



Test report No:
NIE: 53101RAN.001A1

Test report (Modification 1) REFERENCE STANDARDS: FCC 47CFR Part 2.1093

Identification of item tested.....:	Digital Handheld Terminal
Trade mark	PowerTrunk
Model and /or type reference	HTT-500-2
Other identification of the product	FCC ID: WT7PTHTT500760D
Final HW version	B model
Final SW version	173402509091
Manufacturer	TELTRONIC, S.A.U. Poligono Malpica, Calle F-Oeste (50016). Zaragoza. (SPAIN).
Test method requested, standard.....:	FCC 47 CFR Part 2.1093. (10-1-14 Edition) Radiofrequency radiation exposure evaluation: portable devices.
Summary	<p>Considering the results of the performed test according to FCC 47CFR Part 2.1093, the item under test is IN COMPLIANCE with the requested specifications specified in the standards.</p> <p>The maximum 1g volume averaged SAR found during this test has been 7.01 W/kg, into the 799 - 805 MHz frequency band, for P25 mode and body-worn exposure condition.</p> <p>The maximum 1g volume averaged SAR for multiband transmission found during this test has been 7.29 W/kg, for body-worn exposure condition.</p> <p>NOTE: The results presented in this Test Report apply only to the particular item under test established in page 1 of this document, as presented for test on the date(s) shown in section, "USAGE OF SAMPLES, TESTING PERIOD AND ENVIRONMENTAL CONDITIONS".</p>
Approved by (name / position & signature)	Rafael López EMC Lab. Manager
Date of issue	2017-05-24
Report template No.....:	FDT11_19

Index

Competences and guarantees.....	3
General conditions.....	3
Uncertainty	3
Usage of samples.....	4
Test sample description	4
Identification of the client	4
Testing period.....	5
Environmental conditions.....	5
Modifications to the reference test report.....	5
References	5
Remarks and comments.....	5
Testing verdicts	7
Appendix A – Test configuration	8
Appendix B – Test results	23
Appendix C – Measurement report	44
Appendix D – System Validation Reports	74
Appendix E – Calibration data	79
Appendix F – Photographs	139

Competences and guarantees

DEKRA Testing and Certification S.A.U. is a testing laboratory accredited by the National Accreditation Body (ENAC - Entidad Nacional de Acreditación), to perform the tests indicated in the Certificate No. 51/LE 147

In order to assure the traceability to other national and international laboratories, DEKRA has a calibration and maintenance program for its measurement equipment.

DEKRA guarantees the reliability of the data presented in this report, which is the result of the measurements and the tests performed to the item under test on the date and under the conditions stated on the report and, it is based on the knowledge and technical facilities available at DEKRA at the time of performance of the test.

DEKRA is liable to the client for the maintenance of the confidentiality of all information related to the item under test and the results of the test.

The results presented in this Test Report apply only to the particular item under test established in this document.

IMPORTANT: No parts of this report may be reproduced or quoted out of context, in any form or by any means, except in full, without the previous written permission of DEKRA.

General conditions

1. This report is only referred to the item that has undergone the test.
2. This report does not constitute or imply on its own an approval of the product by the Certification Bodies or competent Authorities.
3. This document is only valid if complete; no partial reproduction can be made without previous written permission of DEKRA.
4. This test report cannot be used partially or in full for publicity and/or promotional purposes without previous written permission of DEKRA and the Accreditation Bodies.

Uncertainty

Uncertainty (factor $k=2$) was calculated according to the following documents:

1. FCC OET KDB 865664 D01 - SAR Measurement Requirements for 100 MHz to 6 GHz v01r04 (August 2015).

Usage of samples

Samples undergoing test have been selected by: the client

Sample M/01 is composed of the following elements:

Control N°	Description	Model	Serial N°	Date of reception
52844/14	Portable terminal	HTT-500-2	NYPB-48	2017-03-09
52844/18	Battery	300-01175	---	2017-03-09

Sample M/02 is composed of the following elements:

Control N°	Description	Model	Serial N°	Date of reception
52844/14	Portable terminal	HTT-500-2	NYPB-48	2017-03-09
52844/26	Antenna	300-01938	---	2017-03-09
52844/17/18/19	Battery	300-01175	---	2017-03-09
52844/22/32	Audio Accessory 1	300-00733/300-00564	---	2017-03-09
52844/33	Audio Accessory 2	300-01628	---	2017-03-09
52844/29/30/31	Audio Accessory 3	300-00301/300-00929/300-00735	---	2017-03-09
52844/41	Carry accessory 1	300-00250	---	2017-03-09
52844/35	Carry accessory 2	300-01387	---	2017-03-09
52844/36	Carry accessory 3	300-01589	---	2017-03-09
52844/38	Carry accessory 4	300-01385	---	2017-03-09
52844/39	Carry accessory 5	300-01386	---	2017-03-09
52844/34	Carry accessory 6	300-00912	---	2017-03-09
52844/37	Carry accessory 7	300-00323	---	2017-03-09

1. Sample M/01 has undergone the test(s) specified in subclause "Test method requested": Conducted average output power.
2. Sample M/02 has undergone the test(s) specified in subclause "Test method requested": SAR evaluation for TETRA mode.

Test sample description

The test sample consists of a Digital handheld terminal for TETRA, TI D-LMR and P25 with external antenna, keypad and display. It can also include a Bluetooth module and a GPS receiver inside.

Identification of the client

TELTRONIC, S.A.U.

Polígono Malpica, Calle F-Oeste (50016). Zaragoza. (SPAIN).

Testing period

The performed test started on 2017-03-29 and finished on 2017-04-19.

The tests have been performed at DEKRA.

Environmental conditions

In the laboratory for measurements, the following limits were not exceeded during the test:

Temperature	Min. = 20.1 °C Max. = 24.1 °C
Relative humidity	Min. = 33.9 % Max. = 63.5 %

Modifications to the reference test report

It was introduced the following modifications in respect to the test report number 53101RAN.001 related with the same samples, in the next clauses and sub-clauses:

Clauses / Sub-clauses	Modification	Justification
Usage of samples	Accessory models updated	Client request.
Appendix B	Editorial changes	Client request.

This modification test report cancels and replaces the test report 53101RAN.001

References

The tests documented in this report were performed in accordance with FCC 47 CFR § 2.1093 and the following FCC Published RF exposure KDB procedures:

1. FCC OET KDB 447498 D01 General RF Exposure Guidance v06 (October 2015)
2. FCC OET KDB 865664 D01 - SAR Measurement Requirements for 100 MHz to 6 GHz v01r04 (August 2015).
3. FCC OET KDB 865664 D02 RF Exposure Reporting v01r02 (October 2015)
4. FCC OET KDB 648474 D04 Handset SAR v01r03 (October 2015)
5. FCC OET KDB 643646 D01 v01r03 SAR Test for PTT Radios (October 2015).

Remarks and comments

1: Only the plots of the highest reported SAR for each test configuration and mode/band are included in appendix C.

2: Zoom scan for this position is not required according to FCC OET KDB 447498 D01 General RF Exposure Guidance v06, paragraph "4.4.2. Area scan based 1-g estimation"

3: Testing of other required channels is not required when the measured SAR is ≤ 3.5 W/kg, according to FCC OET KDB 613646 D01 SAR Test for PTT Radios v01r03.

4: SAR for "additional" audio accessories without transmitting antenna is required only when the highest body-worn SAR combination (antenna, battery and body-worn accessory) and channel configuration applicable to the audio accessory is > 4.0 W/kg, according to FCC OET KDB 613646 D01 SAR Test for PTT Radios v01r03.

Used instrumentation

1. Dosimetric E-field probe SPEAG EX3DV4
2. Data acquisition device SPEAG DAE4
3. Electro-optical converter SPEAG EOC3
4. 750 MHz dipole validation kit SPEAG D750V3
5. 900 MHz dipole validation kit SPEAG D900V2
6. Robot Stäubli RX60BL
7. Robot controller Stäubli CM7MB
8. SAR measurement software SPEAG DASY52 V52.8.8.1222
9. SAR post processing software SPEAG SEMCAD X
10. Measurement server SPEAG DASY5 SE UMS 011 BS
11. SAM head-body simulator SPEAG Twin SAM V4.0
12. Oval flat phantom SPEAG ELI 4
13. Head and Body Tissue Equivalent Liquids for 750 MHz and 900 MHz bands
14. Vector network analyzer Agilent FieldFox N9923A
15. Dielectric probe kit SPEAG DAK-3.5
16. Power sensor DC 50 MHz to 18 GHz R&S model NRP-Z91
17. Power meter Agilent E4419B
18. RF Generator R&S SMU200A
19. DC Power supply Agilent U8002A
20. Dual directional coupler HP 778D and NARDA.
21. Power amplifier MITEQ AMF-4D-00400600-50-30P
22. 6 dB attenuator Weinschel 75 A-6-11
23. 20 dB attenuator Weinschel 75 A-20-11
24. SPEAG Mounting Device for Hand-Held Transmitters.
25. Digital thermometer LKM Electronics model DTM300-Spezial
26. Temperature and humidity probe HUMIDIROBE Pico Technology.

Testing verdicts

Not applicable	N/A
Pass	P
Fail	F
Not measured	N/M

FCC 47CFR Part 2.1093 Paragraph	VERDICT			
	NA	P	F	NM
(d)(1) TETRA 769-775 MHz		P		
(d)(1) TETRA 799-805 MHz		P		
(d)(1) TETRA 809-824 MHz		P		
(d)(1) TETRA 854-869 MHz		P		
(d)(1) TI D-LMR 769-775 MHz		P		
(d)(1) TI D-LMR 799-805 MHz		P		
(d)(1) TI D-LMR 809-824 MHz		P		
(d)(1) TI D-LMR 854-869 MHz		P		
(d)(1) P25 769-775 MHz		P		
(d)(1) P25 799-805 MHz		P		
(d)(1) Bluetooth 2450 MHz		P		

Appendix A – Test configuration

INDEX

1.	GENERAL INTRODUCTION	10
1.1.	Application Standard.....	10
1.2.	General requirements	10
1.3.	Measurement system requirements	10
1.4.	Phantom requirements.....	10
1.5.	Measurement Liquids requirements	11
2.	MEASUREMENT SYSTEM	12
2.1.	Measurement System	12
2.2.	Test positions of device relative to head	16
2.3.	Test positions of device relative to body	17
2.4.	Test to be performed	17
2.5.	Description of interpolation/extrapolation scheme	18
2.6.	Determination of the largest peak spatial-average SAR	18
2.7.	System Validation	18
3.	UNCERTAINTY	19
4.	SAR LIMIT	21
5.	DEVICE UNDER TEST	21
5.1.	Dimensions.....	21
5.2.	Wireless Technology.....	21
5.3.	Antenna Location	21
5.4.	Accessories.....	22

1. GENERAL INTRODUCTION

1.1. Application Standard

The Federal Communications Commission (FCC) sets the limits for occupational/controlled exposure to radio frequency electromagnetic fields for transmitting devices designed to be used within 20 centimetres of the body of the user under FCC 47 CFR Part 2.1093 - “Radiofrequency radiation exposure evaluation: portable devices”, paragraph (d)(1).

1.2. General requirements

The SAR measurement has been performed continuing the following considerations and environment conditions:

- The ambient temperature shall be in the range of 18°C to 25°C and the variation shall not exceed +/- 2°C during the test.
- The ambient humidity shall be in the range of and 30% - 70%.
- The device battery shall be fully charged before each measurement.

1.3. Measurement system requirements

The measurement system used for SAR tests fulfils the procedural and technical requirements described at the reference standards used.

1.4. Phantom requirements

The phantom for head worn is a simplified representation of the human anatomy and comprised of material with electrical properties similar to the corresponding tissues in human body. The human model has the following proportions:

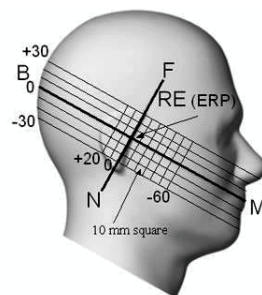

Figure 1: Proportions of Phantom

The shell model is a shaped container and it has the representation shown in the following figure:

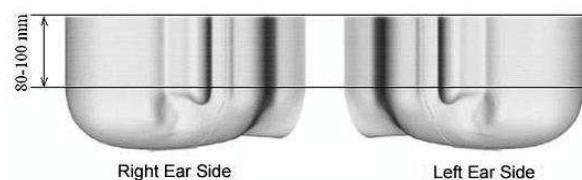

Figure 2: Proportions and shape of Phantom shell

The phantom model for body measurements is an elliptical open-top container with a flat bottom, with the following shape and dimensions:

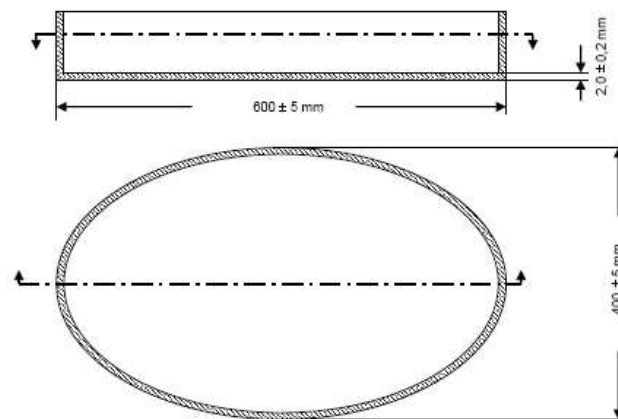

Figure 3: Proportions and shape of Phantom shell

1.5. Measurement Liquids requirements.

The liquids used to simulate the human tissues, must fulfil the requirements of the dielectric properties required. These target dielectric properties per FCC OET KDB 865664 D01 instructions come from the dipole and probe calibration data which are included in Appendix B, Section 3, of this document.

To minimize the effect of reflections on peak spatial-average SAR values, from the upper surface of the tissue-equivalent liquid, the depth of the liquid should be at least 15 cm.

2. MEASUREMENT SYSTEM

2.1. Measurement System

The DASY5 system for performing compliance tests consists of the following items:

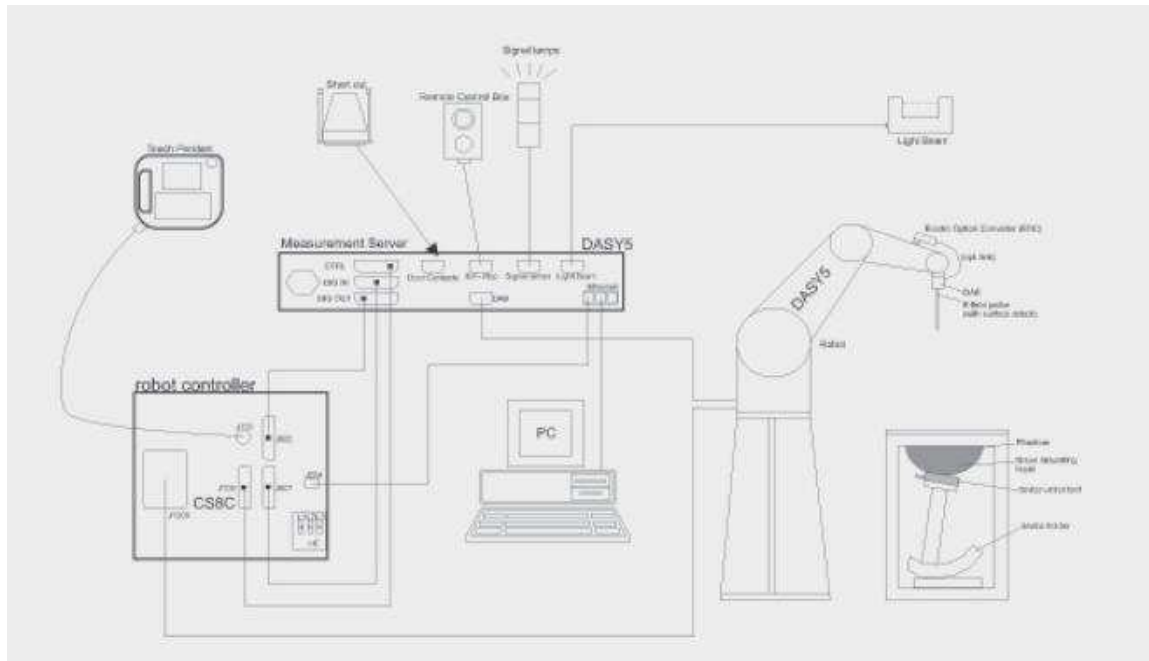



Figure 4: SAR Measurement system

- A standard high precision 6-axis robot (Stäubli TX=RX family) with controller, teach pendant and software. An arm extension for accommodating the data acquisition electronics (DAE).
- An isotropic field probe optimized and calibrated for the targeted measurement.
- A data acquisition electronics (DAE) which performs the signal amplification, signal multiplexing, AD-conversion, offset measurements, mechanical surface detection, collision detection, etc. The unit is battery powered with standard or rechargeable batteries. The signal is optically transmitted to the EOC.
- The Electro-optical converter (EOC) performs the conversion from optical to electrical signals for the digital communication to the DAE. To use optical surface detection, a special version of the EOC is required. The EOC signal is transmitted to the measurement server.
- The function of the measurement server is to perform the time critical tasks such as signal filtering, control of the robot operation and fast movement interrupts.
- The Light Beam used is for probe alignment. This improves the (absolute) accuracy of the probe positioning.
- A computer running Win7 professional operating system and the DASY5 software.
- Remote control and teach pendant as well as additional circuitry for robot safety such as warning lamps, etc.
- The phantom, the device holder and other accessories according to the targeted measurement.

Manufacturer	Device	Type
Schmid & Partner Engineering AG	Dosimetric E-Field Probe	EX3DV4
Schmid & Partner Engineering AG	Data Acquisition Electronics	DAE4
Schmid & Partner Engineering AG	Electro-Optical Converter	EOC3
Stäubli	Robot	RX60BL
Stäubli	Robot controller	CS7MB
Schmid & Partner Engineering AG	Measurement Server	DASY5 SE UMS 011 BS
Schmid & Partner Engineering AG	SAM head-body simulator	TWIN SAM V4.0
Schmid & Partner Engineering AG	Oval flat phantom	SPEAG ELI 4
Schmid & Partner Engineering AG	Mounting Device for Hand-Held Transmitters	SD000 HD1HA
Schmid & Partner Engineering AG	Measurement Software	DASY52 V52.8.8.1222
Schmid & Partner Engineering AG	Postprocessing Software	SEMCAD X
Schmid & Partner Engineering AG	750 MHz System Validation Dipole	D750V3
Schmid & Partner Engineering AG	900 MHz System Validation Dipole	D900V2
Agilent	Vector Network Analyser	FieldFox N9923A
Schmid & Partner Engineering AG	Dielectric Probe Kit	DAK-3.5

Table 1: Measurement Equipment

	Model	EX3DV4
	Construction	Symmetrical design with triangular core. Built-in shielding against static charges. PEEK enclosure material (resistant to organic solvents, e.g., DGBE).
	Frequency	10 MHz to > 6 GHz; Linearity: ± 0.2 dB (30 MHz to 6 GHz)
	Directivity	± 0.3 dB in TSL (rotation around probe axis) ± 0.5 dB in TSL (rotation normal to probe axis)
	Dynamic Range	10 μ W/g to > 100 mW/g Linearity: ± 0.2 dB (noise: typically < 1 μ W/g)
	Dimensions	Overall length: 337 mm (Tip: 20 mm) Tip diameter: 2.5 mm (Body: 12 mm) Typical distance from probe tip to dipole centers: 1.0 mm

	Model	DAE4
	Construction	Signal amplifier, multiplexer, A/D converter, and control logic. Serial optical link communication with DASY4/5 embedded system (fully remote controlled). Two-step probe touch detector for mechanical surface detection and emergency robot stop.
	Measurement Range	-100 to +300 mV (16 bit resolution and two range settings: 4mV, 400mV)
	Input Offset Voltage	< 5 μ V (with auto zero)
	Input Resistance	200 MOhm
	Input Bias Current	< 50 fA

	Model	Twin SAM
	Construction	The shell corresponds to the specifications of the Specific Anthropomorphic Mannequin (SAM) phantom defined in IEEE 1528 and IEC 62209-1. It enables the dosimetric evaluation of left and right hand phone usage as well as body mounted usage at the flat phantom region. A cover prevents evaporation of the liquid. Reference markings on the phantom allow the complete setup of all predefined phantom positions and measurement grids by teaching three points with the robot.
	Material	Vinylester, glass fiber reinforced (VE-GF)
	Liquid Compatibility	Compatible with all SPEAG tissue simulating liquids (incl. DGBE type)
	Shell Thickness	2 \pm 0.2 mm (6 \pm 0.2 mm at ear point)
	Dimensions	Length: 1000 mm Width: 500 mm Height: adjustable feet
	Filling Volume	Approx. 25 liters
	Wooden Support	SPEAG standard phantom table

	Model	ELI
	Construction	Phantom for compliance testing of handheld and body-mounted wireless devices in the frequency range of 30 MHz to 6 GHz. ELI is fully compatible with the IEC 62209-2 standard and all known tissue simulating liquids. ELI has been optimized regarding its performance and can be integrated into our standard phantom tables. A cover prevents evaporation of the liquid. Reference markings on the phantom allow installation of the complete setup, including all predefined phantom positions and measurement grids, by teaching three points. The phantom is compatible with all SPEAG dosimetric probes and dipoles.
	Material	Vinylester, glass fiber reinforced (VE-GF)
	Liquid Compatibility	Compatible with all SPEAG tissue simulating liquids (incl. DGBE type)
	Shell Thickness	2 ± 0.2 mm (bottom plate)
	Dimensions	Major axis: 600 mm Minor axis: 400 mm
	Filling Volume	Approx. 30 liters
	Wooden Support	SPEAG standard phantom table

	Model	Mounting Device for Hand-Held Transmitters
	Construction	In combination with the Twin SAM V5.0/V5.0c or ELI Phantoms, the Mounting Device for Hand-Held Transmitters enables rotation of the mounted transmitter device to specified spherical coordinates. At the heads, the rotation axis is at the ear opening. Transmitter devices can be easily and accurately positioned according to IEC 62209-1, IEEE 1528, FCC, or other specifications. The device holder can be locked for positioning at different phantom sections (left head, right head, flat).
	Material	Polyoxymethylene (POM)

	Model	System Validations Kits 450 MHz – 6 GHz			
	Construction	Symmetrical dipole with I/4 balun. Enables measurement of feedpoint impedance with NWA. Matched for use near flat phantoms filled with tissue simulating solutions.			
	Frequency	450 MHz to 5800 MHz			
	Return Loss	20 dB at specified validation position			
	Dimensions (length and overall height in mm)	Product	Dipole length	Overall height	
		D450V3	290.0	330.0	
D750V3		179.0	330.0		
D900V2		148.5	340.0		
D1800V2		72.5	300.0		
D2000V2		65.0	300.0		
D2450V2	52.0	290.0			
D2600V2	49.2	290.0			
D5GHzV2	20.6	300.0			

2.2. Test positions of device relative to head

The standard requires two test positions for the handset in the head. These positions are the "cheek" position and the "tilted" position. The tests positions used are described below. The handset should be tested in both positions (left and right sides) in the SAM phantom.

The DUT shall be placed in the Phantom in such way that the main point of the mobile terminal (acoustic output) coincides with the reference point located at the Phantom's ear.

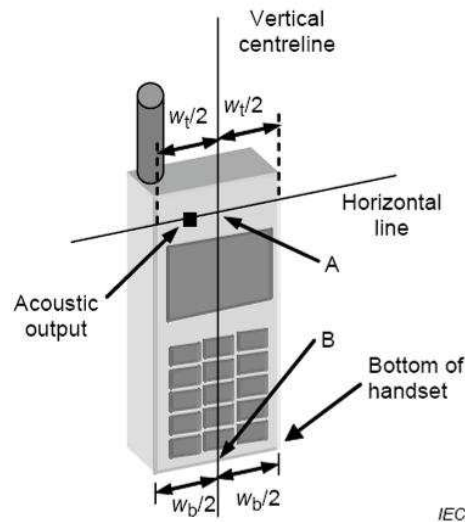

Figure 5: DUT's basic scheme

SAR measurements will be performed for the following configurations as indicated in the reference standard:

- Right side of Phantom, Cheek position.
- Right side of Phantom, 15° Tilted position.
- Left side of Phantom, Cheek position.
- Left side of Phantom, 15° Tilted position.

Definition of the "cheek" position

The "cheek" position relative to Phantom is described as follows:

1. - Position the device with the vertical centre line of the body of the device and the horizontal line crossing the centre of the ear piece in a plane parallel to the sagittal plane of the Phantom. While maintaining the device in this plane, align the centre line with the reference plane containing the three ear and mouth reference points (M, RE and LE).
2. - Translate the mobile phone box towards the Phantom until the ear-piece touches the ear reference point (RE or LE). While maintaining the device in the reference plane, move the bottom of the box until any point of the front side is in contact with the cheek of the Phantom.

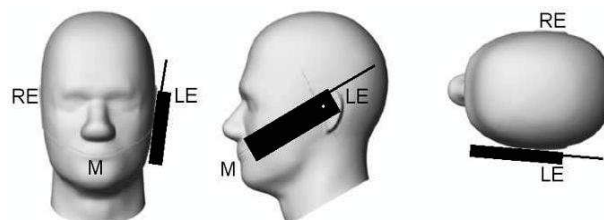

Figure 6: "Cheek" position of DUT

Definition of the tilted position:

The "15° tilted" position relative to Phantom is described as follows:

1. - Position the device in the "cheek" position described above.
2. - While maintaining the device in the reference plane described above and pivoting against the ear, move it outward away from the mouth by an angle of 15 degrees.

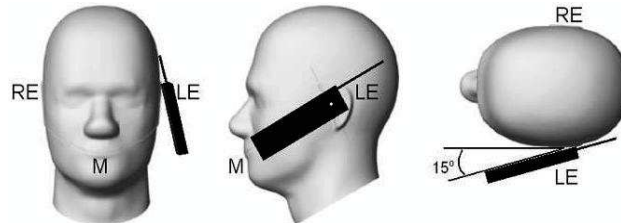

Figure 7: "Tilted" position of DUT

As the device under test is a Handheld PTT two-ways radio, Head SAR in-front-of-the face exposure conditions is also required according to KDB 643646 D01.

Head SAR has been measured with the front face of the radio positioned at 2.5 cm parallel to the flat phantom.

2.3. Test positions of device relative to body.

Handheld PTT two-ways radios shall be tested for body-worn accessory exposure conditions according to KDB 643646 D01.

SAR measurements for body exposure have been performed at 0 mm distance for the worst cases of body-worn accessories, placing the device with the body-worn accessories facing the flat phantom in the applicable use position.

2.4. Test to be performed

For Head SAR test shall be performed at both DUT positions previously described, on each side of the SAM Head-Body Simulator Phantom using the centre frequency of each operating band.

Additionally, the configuration giving to the maximum mass averaged SAR shall be used to test the low-end and the high-end frequencies of each transmitting band. Thus, the tests to be performed are as follows:

- Measurements at Central Channel of application band:
 1. SAR measurement at the left side of Phantom and the cheek position of the DUT.
 2. SAR measurement at the left side of Phantom and the tilted 15° position of the DUT.
 3. SAR measurement at the right side of Phantom and the cheek position of the DUT.
 4. SAR measurement at the right side of Phantom and the tilted 15° position of the DUT.
 5. SAR measurement at the flat side of the Phantom with the front face DUT at 2.5cm parallel to the flat Phantom.
- Measurements at Low Channel of application band: SAR measurement at the side and position where the maximum SAR level, measured at Central channel, was found.
- Measurements at High Channel of application band: SAR measurement at the side and position where the maximum SAR level, measured at Central channel, was found.

For body SAR, test shall be performed with the radio placed in a body-worn accessory, positioned against the flat phantom, representative of the normal operating conditions expected by users, using the centre frequency of each operating band. Low and high channels for each band should be tested at this position.

2.5. Description of interpolation/extrapolation scheme

The local SAR inside the Phantom is measured using small dipole sensing elements inside a probe element. The probe tip must not be in contact with the Phantoms surface in order to minimise measurement errors, but the highest local SAR is obtained from measurements at a certain distances from the shell trough extrapolation. The accurate assessment of the maximum SAR averaged over 1 gr. requires a very fine resolution in the three dimensional scanned data array. Since the measurements have to be performed over a limited time, the measured data have to be interpolated to provide an array of sufficient resolution.

The interpolation of 2D area scan is used after the initial area scan, at a fixed distance from the Phantom shell wall. The initial scan data is collected with approx. 10 mm spatial resolution and this interpolation is used to find the location of the local maximum for positioning the subsequent 3D scanning within a 1mm resolution.

For the 3D scan, data is collected on a spatially regular 3D grid having 5 mm steps in both directions. After the data collection by the SAR probe, the data are extrapolated in the depth direction to assign values to points in the 3D array closer to the shell wall. A notional extrapolation value is also assigned to the first point outside the shell wall so that subsequent interpolation schemes will be applicable right up to the shell wall boundary.

2.6. Determination of the largest peak spatial-average SAR

To determine the maximum value of the peak spatial-average SAR of a DUT, all device positions, configurations and operational modes should be tested for each frequency band.

The averaging volume shall be chosen as 1gr. of contiguous tissue. The cubic volumes, over which the SAR measurements are averaged after extrapolation and interpolation, are chosen in order to include the highest values of local SAR.

The maximum SAR level for the DUT will be the maximum level obtained of the performed measurements, and indicated in the previous points.

2.7. System Validation

Prior to the SAR measurements, system verification is done daily to verify the system accuracy. A complete SAR evaluation is done using a half-wavelength dipole as source with the frequency of the mid-band channel of the operating band, or within 10% of this channel.

The measured one-gram SAR should be within 10% of the expected target values specified in the calibration certificate of the dipole, for the specific tissue and frequency used.

3. UNCERTAINTY

Uncertainty for 300 MHz – 6 GHz

ERROR SOURCES	Uncertainty value (± %)	Probability distribution	Divisor	(c _i) 1g	(c _i) 10g	Standard uncertainty (1g) (± %)	Standard uncertainty (10g) (± %)
Measurement Equipment							
Probe Calibration	6.550	N	1	1	1	6.550	6.550
Axial Isotropy	4.700	R	√3	0.7	0.7	1.899	1.899
Hemisfericall Isotropy	9.600	R	√3	0.7	0.7	3.880	3.880
Boundary effect	2.000	R	√3	1	1	1.155	1.155
Linearity	4.700	R	√3	1	1	2.714	2.714
System Detection limits	1.000	R	√3	1	1	0.577	0.577
Probe modulation response	6.100	R	√3	1	1	3.522	3.522
Readout electronics	0.300	N	1	1	1	0.300	0.300
Response time	0.800	R	√3	1	1	0.462	0.462
Integration time	2.600	R	√3	1	1	1.501	1.501
RF Ambient noise	3.000	R	√3	1	1	1.732	1.732
RF Ambient reflections	3.000	R	√3	1	1	1.732	1.732
Probe positioner mech. restrictions	0.800	R	√3	1	1	0.462	0.462
Probe positioning with respect to phantom shell	6.700	R	√3	1	1	3.868	3.868
Max. SAR Eval.	4.000	R	√3	1	1	2.309	2.309
Test Sample Related							
Device holder uncertainty	2.900	N	1	1	1	2.900	2.900
Test sample positioning	3.600	N	1	1	1	3.600	3.600
Drift of output power	5.000	R	√3	1	1	2.887	2.887
Phantom and Setup							
Phantom uncertainty (shape and thickness tolerances)	6.600	R	√3	1	1	3.811	3.811
Algorithm for correcting SAR for deviations in permittivity and conductivity	1.900	R	√3	1	0.84	1.097	0.921
Liquid conductivity (meas.)	2.454	N	1	0.78	0.71	1.914	1.742
Liquid permittivity (meas.)	2.454	N	1	0.26	0.26	0.638	0.638
Liquid conductivity – temperature uncertainty	3.400	R	√3	0.78	0.71	1.531	1.394
Liquid permittivity – temperature uncertainty	0.400	R	√3	0.23	0.26	0.053	0.060
Combined standard uncertainty	$u_c = \sqrt{\sum_{i=1}^m c_i^2 \cdot u_i^2}$					12.82	12.76
Expanded uncertainty (confidence interval of 95%)	$ue = 2.00 u_c$					25.64	25.53

Table 2: Uncertainty Assessment for 300 MHz - 6 GHz

Uncertainty for Fast SAR measurement 300 MHz – 6 GHz

ERROR SOURCES	Uncertainty value (± %)	Probability distribution	Divisor	(c) 1g	(c) 10g	Standard uncertainty (1g) (± %)	Standard uncertainty (10g) (± %)
Measurement Equipment							
Probe Calibration	6,550	N	1	0	0	0,000	0,000
Axial Isotropy	4,700	R	√3	0,7	0,7	1,899	1,899
Hemisphericall Isotropy	9,600	R	√3	0,7	0,7	3,880	3,880
Boundary effect	2,000	R	√3	1	1	1,155	1,155
Linearity	4,700	R	√3	1	1	2,714	2,714
System Detection limits	1,000	R	√3	1	1	0,577	0,577
Probe modulation response	2,400	R	√3	1	1	1,386	1,386
Readout electronics	0,300	N	1	0	0	0,000	0,000
Response time	0,800	R	√3	0	0	0,000	0,000
Integration time	2,600	R	√3	1	1	1,501	1,501
RF Ambient noise	3,000	R	√3	1	1	1,732	1,732
RF Ambient reflections	3,000	R	√3	0	0	0,000	0,000
Probe positioner mech. restrictions	0,800	R	√3	1	1	0,462	0,462
Probe positioning with respect to phantom shell	6,700	R	√3	1	1	3,868	3,868
Spatial x-y-Resolution	10,000	R	√3	1	1	5,774	5,774
Fast SAR z-Approximation	14,000	R	√3	1	1	8,083	8,083
Test Sample Related							
Device holder uncertainty	2.900	N	1	1	1	2.900	2.900
Test sample positioning	3.600	N	1	1	1	3.600	3.600
Drift of output power	5.000	R	√3	1	1	2.887	2.887
Power Scaling	0,000	R	√3	0	0	0,000	0,000
Phantom and Setup							
Phantom uncertainty (shape and thickness tolerances)	7.600	R	√3	1	1	4.388	4.388
Algorithm for correcting SAR for deviations in permittivity and conductivity	1.900	R	√3	1	0.84	1.097	0.921
Liquid conductivity (meas.)	1.500	N	√3	0.78	0.71	0.675	0.615
Liquid permittivity (meas.)	1.200	N	√3	0.26	0.26	0.180	0.180
Liquid conductivity – temperature uncertainty	3.400	N	√3	0.78	0.71	1.531	1.394
Liquid permittivity – temperature uncertainty	0.400	N	√3	0.23	0.26	0.053	0.060
Combined standard uncertainty	$u_c = \sqrt{\sum_{i=1}^m c_i^2 \cdot u_i^2}$					14.34	14.29
Expanded uncertainty (confidence interval of 95%)	$ue = 2.00 u_c$					28.68	28.59

Table 3: Fast SAR Uncertainty Assessment for 300 MHz - 6 GHz

4. SAR LIMIT

The SAR values have to be averaged over a mass of 1 gr. (SAR 1 gr.) with the shape of a cube. This level couldn't exceed the values indicated in the application Standard:

Standard	Exposure	SAR	SAR Limit (W/kg)
FCC 47 CFR Part 2.1093 Paragraph (d)(1)	Ocupational/controlled	SAR _{1 gr.}	8

Table 4: SAR limit

Having a worst case measurement, the SAR limit is valid for Occupational/controlled exposure.

5. DEVICE UNDER TEST

5.1. Dimensions

Dimensions	Millimetres
Height x Width x Depth	130.0 x 60.0 x 35.0
Overall Diagonal:	150.0
Display Diagonal:	65.0
Antenna:	195.0 x 5.0

Table 5: Dimensions

5.2. Wireless Technology

Wireless Technology	SAR Testing	Frequency Bands
TETRA	Required	769 – 775 MHz, 799 – 805 MHz 809 – 824 MHz, 854 – 869 MHz
TI D-LMR	Required	769 – 775 MHz, 799 – 805 MHz 809 – 824 MHz, 854 – 869 MHz
P25	Required	769 – 775 MHz, 799 – 805 MHz
Bluetooth	Not required	2402-2480 MHz

Table 6: Supported modes

5.3. Antenna Location

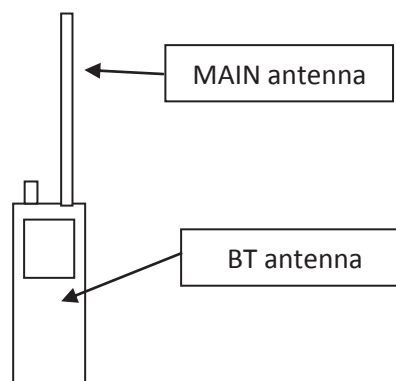

FRONT FACE

Figure 8: Antenna location sketch

5.4. Accessories.

- Battery

There is only one battery type. See “Appendix A - Test results”, Section 1.1 of this document for further information.

- Audio Accesories (AA)

Carrying Accessory	Type	Comments
1	Remote speaker + Earpiece (Default Audio Accessory)	Without radiating antenna
2	Handsfree kit + Earpiece	Without radiating antenna
3	Remote control + Microphone	Without radiating antenna

Table 7: List of audio accessories

- Carrying Accessories (CA)

Carrying Accessory	Type	Metalic Parts	Test Distance	Distance Antenna – Phantom	Comments	Used for SAR testing
CA 1	Shoulder harness	No	0 mm	23 mm	None	Yes
CA 2	Lightweight Case	Yes	0 mm	18 mm	Needs shoulder strap	Yes
CA 3	Plastic Belt Clip	No	0 mm	29 mm	None	Yes
CA 4	Leather Case (with belt clip)	Yes	0 mm	30 mm	None	No*
CA 5	Leather Case	Yes	0 mm	42 mm	Needs CA6 or CA7	No*
CA 6	Leather Belt Accessory	Yes	0 mm	46 mm	Needs adapter	No*
CA 7	Plastic Belt Accessory	No	0 mm	37 mm	Needs adapter	No*

Table 8: List of carry accessories

*Note: For body-worn accessories with similar construction and operating configurations only the body-worn accessory withing the group that is expected to result in the highest SAR (smallest antenna separation distance) has been used for SAR testing, according to 643646 D01 SAR Test for PTT Radios v01r03, paragraph “A2. Body SAR Test Considerations for Body-worn Accessories”

- Antennas

There is only one type of antenna that works in all transmitting frequencies and technologies.

See “Appendix F – Photographs” of this document for further information.

Appendix B – Test results

INDEX

1.	TEST CONDITIONS	25
1.1.	Power supply (V):	25
1.2.	Temperature (°C):	25
1.3.	Test signal, Output Power and Frequencies	25
1.4.	DUT and test-site configurations	25
2.	CONDUCTED AVERAGE POWER MEASUREMENTS	26
2.1.	TETRA Bands	26
2.2.	TI D-LMR Bands	26
2.3.	P25 Bands	26
2.4.	Bluetooth	27
3.	TISSUE PARAMETERS MEASUREMENTS	28
4.	SYSTEM CHECK MEASUREMENTS	29
4.1.	Validation results for Head TSL	29
4.2.	Validation results for Body TSL	29
5.	MEASUREMENT RESULTS FOR SAR (SPECIFIC ABSORPTION RATE)	30
5.1.	Summary maximum results for head measurements	31
5.2.	Summary maximum results for front of face measurements	31
5.3.	Summary maximum results for body measurements	31
5.4.	Maximum results for head simultaneous multi-band transmission	32
5.5.	Maximum results for front of face simultaneous multi-band transmission	32
5.6.	Maximum results for body simultaneous multi-band transmission	32
5.7.	Results for TETRA 769 – 775 MHz band	33
5.8.	Results for TETRA 799 – 805 MHz band	34
5.9.	Results for TETRA 809 – 824 MHz band	35
5.10.	Results for TETRA 854 – 869 MHz band	36
5.11.	Results for TI D-LMR 769 – 775 MHz band	37
5.12.	Results for TI D-LMR 799 – 805 MHz band	38
5.13.	Results for TI D-LMR 809 – 824 MHz band	39
5.14.	Results for TI D-LMR 854 – 869 MHz band	40
5.15.	Results for P25 769 – 775 MHz band	41
5.16.	Results for P25 799 – 805 MHz band	42
5.17.	Variability results	43

1. TEST CONDITIONS

1.1. Power supply (V):

$V_n = 7.4$ Li-polymer rechargeable battery

Type of power supply = DC Voltage from rechargeable Li-Ion 7.4 V battery.

1.2. Temperature (°C):

$T_n = +20.00$ to $+25.00$

The subscript n indicates normal test conditions.

1.3. Test signal, Output Power and Frequencies

The actual DUT supports TETRA, TI D-LMR, P25 and Bluetooth transmitting modes. To perform testing in all supported bands, the sample (S/N: NYPB48) was put into operation by using a software provided by the manufacturer.

A fully charged battery was used for every test sequence. In all operating bands and test position, the measurements were performed on middle channels. In each band, for those positions where the maximum averaged SAR was found, measurements were performed on lowest and highest channels except those with applicable test reductions.

The maximum time-average conducted power of the device for each mode was measured with a power sensor R&S NRP-Z91.

The maximum output power declared by the manufacturer for each supported technology is:

Protocol	Output Power (dBm)	Tune-up tolerance (dBm)	Max. Output Power (dBm)	Max. Average Output Power (dBm)
TETRA	32.5	± 0.25	32.75	26.73
TI D-LMR	32.5	± 0.25	32.75	26.73
P25	34.5	± 0.5	35.0	35.00
Bluetooth	8.16	-	8.16	8.16

1.4. DUT and test-site configurations

The DUT was tested over head and body exposure conditions:

- For head tests, the DUT was placed in cheek and tilt position on the right/left side of the SAM phantom.
- For in-front-of face test, the DUT was placed with the front face against the flat side of the SAM phantom, with a testing distance of 25 mm.
- For body tests, the DUT was placed at 0 mm distance of the flat phantom surface, using the worst combination of each type of carrying accessories.

2. CONDUCTED AVERAGE POWER MEASUREMENTS

2.1. TETRA Bands

Mode	Band	Frequency (MHz)	Burst mode Avg. Output Power (dBm)
TETRA	769-775 MHz	769.0125	25.54
TETRA	769-775 MHz	772.0125	25.58
TETRA	769-775 MHz	774.9875	25.56
TETRA	799-805 MHz	799.0125	25.57
TETRA	799-805 MHz	802.0125	25.61
TETRA	799-805 MHz	804.9875	25.59
TETRA	809-824 MHz	809.0125	25.56
TETRA	809-824 MHz	816.5	25.57
TETRA	809-824 MHz	823.9875	25.56
TETRA	854-869 MHz	854.0125	25.61
TETRA	854-869 MHz	861.5	25.63
TETRA	854-869 MHz	868.9875	25.63

2.2. TI D-LMR Bands

Mode	Band	Frequency (MHz)	Burst mode Avg. Output Power (dBm)
TI D-LMR	769-775 MHz	769.0125	25.48
TI D-LMR	769-775 MHz	772.0125	25.51
TI D-LMR	769-775 MHz	774.9875	25.48
TI D-LMR	799-805 MHz	799.0125	25.50
TI D-LMR	799-805 MHz	802.0125	25.52
TI D-LMR	799-805 MHz	804.9875	25.49
TI D-LMR	809-824 MHz	809.0125	25.52
TI D-LMR	809-824 MHz	816.5	25.54
TI D-LMR	809-824 MHz	823.9875	25.54
TI D-LMR	854-869 MHz	854.0125	25.59
TI D-LMR	854-869 MHz	861.5	25.62
TI D-LMR	854-869 MHz	868.9875	25.61

2.3. P25 Bands

Mode	Band	Frequency (MHz)	Standard Tx mode Avg. Output Power (dBm)
P25	769-775 MHz	769.0125	33.95
P25	769-775 MHz	772.0125	33.93
P25	769-775 MHz	774.9875	33.91
P25	799-805 MHz	799.0125	33.92
P25	799-805 MHz	802.0125	33.94
P25	799-805 MHz	804.9875	33.95

2.4. Bluetooth

The manufacturer declares a maximum conducted output power of 8.16 dBm, which corresponds to 6.55 mW, for the 2402-2480MHz frequency range.

Based on paragraph “4.3.1 Standalone SAR test exclusion considerations” of the KDB 447498 D01 - General RF Exposure Guidance:

$$\frac{[(\text{max. power of channel, including tune-up tolerance, mW})/(\text{min. test separation distance, mm})] \cdot [\sqrt{f(\text{GHz})}]}{\leq 3.0 \text{ for 1-g SAR and } \leq 7.5 \text{ for 10-g extremity SAR}}$$

Protocol	Max. Conducted Output Power		Min. Test Distance (mm)	Freq. (GHz)	Result	Test Exclusion
	(dBm)	(mW)				
Bluetooth	8.16	6.55	5	2.480	2.06	√

The computed value for Bluetooth is < 3.0, so Bluetooth mode qualifies for Standalone SAR test exclusion for 1-g SAR and 10-g SAR.

When standalone SAR test exclusion applies to an antenna that transmits simultaneously with other antennas, standalone SAR must be estimated according to following to determine simultaneous transmission SAR test exclusion:

$$\frac{(\text{max. power of channel, including tune-up tolerance, mW})/(\text{min. test separation distance, mm}) \cdot [\sqrt{f(\text{GHz})/x}] \text{ W/kg}}{\text{for test separation distances } \leq 50 \text{ mm; where } x = 7.5 \text{ for 1-g SAR and } x = 18,75 \text{ for 10-g extremity SAR,}}$$

When the min. test separation distance is < 5 mm, a distance of 5 mm is applied to determine SAR test exclusion.

Estimated SAR						
Protocol	Max. Output Power		Min. Test separation distance (mm)	Frequency (GHz)	Estimated 1-g SAR	Estimated 10-g SAR
	(dBm)	(mW)				
Bluetooth	8.16	6.55	5	2.480	0.28	0.11

3. TISSUE PARAMETERS MEASUREMENTS

Frequency (MHz)	Target Head Tissue		Measured Head Tissue		Deviation %		Measured Date
	Permittivity ϵ	Conductivity σ [S/m]	Permittivity ϵ	Conductivity σ [S/m]	Permittivity ϵ	Conductivity σ [S/m]	
750	41.94	0.87	42.84	0.89	2.13	-0.71	2017-04-03

Frequency (MHz)	Target Body Tissue		Measured Body Tissue		Deviation %		Measured Date
	Permittivity ϵ	Conductivity σ [S/m]	Permittivity ϵ	Conductivity σ [S/m]	Permittivity ϵ	Conductivity σ [S/m]	
750	55.53	0.96	55.90	0.98	0.66	1.23	2017-04-17

Frequency (MHz)	Target Head Tissue		Measured Head Tissue		Deviation %		Measured Date
	Permittivity ϵ	Conductivity σ [S/m]	Permittivity ϵ	Conductivity σ [S/m]	Permittivity ϵ	Conductivity σ [S/m]	
835	41.50	0.90	41.02	0.88	-1.16	-2.36	2017-03-29
900	41.50	0.97	40.10	0.95	-3.38	-1.97	

Frequency (MHz)	Target Body Tissue		Measured Body Tissue		Deviation %		Measured Date
	Permittivity ϵ	Conductivity σ [S/m]	Permittivity ϵ	Conductivity σ [S/m]	Permittivity ϵ	Conductivity σ [S/m]	
835	55.20	0.97	53.50	1.01	-3.07	3.99	2017-04-10
900	55.00	1.05	52.62	1.08	-4.32	2.94	

Note: The dielectric properties have been measured by the contact probe method at 22° C.

- Composition / Information on ingredients

Head and Muscle Tissue Simulation Liquids HSL750V2/MSL750V2

H2O	Water, 35 – 58%
Sucrose	Sugar, white, refined, 40 – 60%
NaCl	Sodium Chloride, 0 – 6%
Hydroxyethyl-cellulose	Medium Viscosity (CAS# 9004-62-0), <0.3%
Preventol-D7	Preservative: aqueous preparation, (CAS# 55965-84-9), containing 5-chloro-2-methyl-3(2H)-isothiazolone and 2-methyl-3(2H)-isothiazolone, 0.1 – 0.7%

Head and Muscle Tissue Simulation Liquids HSL900/MSL900

H2O	Water, 35 – 58%
Sucrose	Sugar, white, refined, 40 – 60%
NaCl	Sodium Chloride, 0 – 6%
Hydroxyethyl-cellulose	Medium Viscosity (CAS# 9004-62-0), <0.3%
Preventol-D7	Preservative: aqueous preparation, (CAS# 55965-84-9), containing 5-chloro-2-methyl-3(2H)-isothiazolone and 2-methyl-3(2H)-isothiazolone, 0.1 – 0.7%

4. SYSTEM CHECK MEASUREMENTS

4.1. Validation results for Head TSL

Date	Frequency (MHz)	SAR over	Fast SAR (W/kg)	SAR (W/kg)	Δ SAR - Fast SAR	1 W Target SAR (W/kg)	1 W Norm. SAR (W/kg)	Drift (%)
2017-04-03	750	1 gr.	2.08	2.05	< $\pm 3\%$	8.07	8.17	1.26
		10 gr.	1.41	1.34	< $\pm 7\%$	5.29	5.34	0.97
2017-03-29	900	1 gr.	2.72	2.67	< $\pm 3\%$	10.6	10.74	1.34
		10 gr.	1.83	1.72	< $\pm 7\%$	6.82	6.92	1.46

4.2. Validation results for Body TSL

Date	Frequency (MHz)	SAR over	Fast SAR (W/kg)	SAR (W/kg)	Δ SAR - Fast SAR	1 W Target SAR (W/kg)	1 W Norm. SAR (W/kg)	Drift (%)
2017-04-17	750	1 gr.	2.26	2.21	< $\pm 3\%$	8.45	8.76	3.66
		10 gr.	1.54	1.47	< $\pm 7\%$	5.60	5.83	4.04
2017-04-10	900	1 gr.	2.84	2.81	< $\pm 3\%$	10.5	11.19	6.55
		10 gr.	1.90	1.83	< $\pm 7\%$	6.79	7.29	7.31

5. MEASUREMENT RESULTS FOR SAR (SPECIFIC ABSORPTION RATE)

SAR measurements have been performed using software provided by the manufacturer, using TETRA Burst mode and TI D-LMR Burst mode for transmission, with a duty factor of 25%, adjusted to the maximum output power rate, and the normal P25 mode, with a duty factor of 100%, adjusted to the maximum output rate.

All measured results have been scaled to a duty factor of 50% as indicated in KDB 447498 D01.

Measured SAR 1g values in the tables of section 5 have been calculated from the 1g SAR value, using the following formula:

$$\text{Measured SAR}_{1-g} = \text{SAR}_{1-g} \cdot 10^{\frac{-\text{Drift}}{10}} \cdot T_{\text{duty-factor}}$$

Where:

SAR 1-g = 1g Averaged SAR (W/kg)

Drift = DASY drift results (dB)

$T_{\text{duty-factor}}$ = Duty cycle scale factor of 50% is applied to the transmission mode.

Only the highest SAR 1-g values have been adjusted for tune-up tolerance according to KDB 643646 D01, section "A5. General Reporting Procedures". Reported SAR 1-g values in the maximum result tables of this section have been calculated using the following formula:

$$\text{Reported_SAR}_{1-g} = \text{Measured_SAR}_{1-g} \cdot \left(\frac{P_{\text{OUT-MAX}}}{P_{\text{conducted}}} \right)^*$$

* Note: Only positive power scale is applied, if $P_{\text{conducted}} > P_{\text{OUT-MAX}} \rightarrow (P_{\text{OUT-MAX}} / P_{\text{conducted}}) = 1$

Where:

Measured SAR 1-g = SAR value calculated as previously described.

$P_{\text{OUT-MAX}}$ = Declared Target Power including tuning tolerance (W)

$P_{\text{conducted}}$ = Measured Conducted Output Power (W)

5.1. Summary maximum results for head measurements.

Band	Mode	Side/Position	Frequency (MHz)	Measured SAR 1-g (W/kg)	Scale Factor	Reported SAR 1-g (W/kg)	Limit SAR 1-g (W/kg)
769 – 775 MHz	TETRA	Left /Tilted	772.0125	1.676	1.303	2.18	8.0
799 – 805 MHz	TETRA	Left /Tilted	802.0125	2.125	1.294	2.75	8.0
809 – 824 MHz	TETRA	Left /Tilted	816.5	2.120	1.306	2.77	8.0
854 – 869 MHz	TETRA	Left /Tilted	861.5	2.220	1.288	2.86	8.0
769 – 775 MHz	TI D-LMR	Left /Tilted	772.0125	1.863	1.324	2.48	8.0
799 – 805 MHz	TI D-LMR	Left /Tilted	802.0125	2.174	1.321	2.87	8.0
809 – 824 MHz	TI D-LMR	Left /Tilted	816.5	2.157	1.315	2.84	8.0
854 – 869 MHz	TI D-LMR	Left /Tilted	861.5	2.774	1.291	3.58	8.0
769 – 775 MHz	P25	Next to the ear configuration is not supported by P25 mode.					
799 – 805 MHz	P25	Next to the ear configuration is not supported by P25 mode.					

5.2. Summary maximum results for front of face measurements.

Band	Mode	Side/Position	Frequency (MHz)	Measured SAR 1-g (W/kg)	Scale Factor	Reported SAR 1-g (W/kg)	Limit SAR 1-g (W/kg)
769 – 775 MHz	TETRA	Front of face	772.0125	1.024	1.303	1.33	8.0
799 – 805 MHz	TETRA	Front of face	802.0125	1.284	1.294	1.66	8.0
809 – 824 MHz	TETRA	Front of face	816.5	1.219	1.306	1.59	8.0
854 – 869 MHz	TETRA	Front of face	861.5	0.906	1.288	1.17	8.0
769 – 775 MHz	TI D-LMR	Front of face	772.0125	1.195	1.324	1.58	8.0
799 – 805 MHz	TI D-LMR	Front of face	802.0125	1.438	1.321	1.90	8.0
809 – 824 MHz	TI D-LMR	Front of face	816.5	1.404	1.315	1.85	8.0
854 – 869 MHz	TI D-LMR	Front of face	861.5	0.848	1.291	1.10	8.0
769 – 775 MHz	P25	Front of face	772.0125	1.827	1.279	2.34	8.0
799 – 805 MHz	P25	Front of face	802.0125	2.112	1.276	2.70	8.0

5.3. Summary maximum results for body measurements

Band	Mode	Side/Accessory	Frequency (MHz)	Measured SAR 1-g (W/kg)	Scale Factor	Reported SAR 1-g (W/kg)	Limit SAR 1-g (W/kg)
769 – 775 MHz	TETRA	Back Face/CA2+AA1	772.0125	2.560	1.303	3.37	8.0
799 – 805 MHz	TETRA	Back Face/CA2+AA1	802.0125	3.455	1.294	4.47	8.0
809 – 824 MHz	TETRA	Back Face/CA2+AA1	816.5	2.644	1.306	3.45	8.0
854 – 869 MHz	TETRA	Back Face/CA2+AA1	861.5	2.020	1.288	2.60	8.0
769 – 775 MHz	TI D-LMR	Back Face/CA2+AA1	772.0125	2.739	1.324	3.63	8.0
799 – 805 MHz	TI D-LMR	Back Face/CA2+AA1	802.0125	3.334	1.321	4.41	8.0
809 – 824 MHz	TI D-LMR	Back Face/CA2+AA1	816.5	3.478	1.315	4.58	8.0
854 – 869 MHz	TI D-LMR	Back Face/CA2+AA1	861.5	2.217	1.291	2.86	8.0
769 – 775 MHz	P25	Back Face/CA2+AA1	772.0125	4.843	1.279	6.20	8.0
799 – 805 MHz	P25 (Var)	Back Face/CA2+AA1	802.0125	5.488	1.276	7.01	8.0

5.4. Maximum results for head simultaneous multi-band transmission

Transmission Mode	Band	Max Reported SAR 1-g (W/kg)	Σ SARi (W/kg)	Limit SAR 1-g (W/kg)	Verdict
TETRA	854– 869 MHz	2.86	3.14	8.0	Pass
Bluetooth	2.45GHz	0.28			
TI D-LMR	854– 869 MHz	3.58	3.86	8.0	Pass
Bluetooth	2.45GHz	0.28			

5.5. Maximum results for front of face simultaneous multi-band transmission

Transmission Mode	Band	Max Reported SAR 1-g (W/kg)	Σ SARi (W/kg)	Limit SAR 1-g (W/kg)	Verdict
TETRA	799 – 805 MHz	1.66	1.94	8.0	Pass
Bluetooth	2.45GHz	0.28			
TI D-LMR	799 – 805 MHz	1.90	2.18	8.0	Pass
Bluetooth	2.45GHz	0.28			
P25	799 – 805 MHz	2.70	2.98	8.0	Pass
Bluetooth	2.45GHz	0.28			

5.6. Maximum results for body simultaneous multi-band transmission

Transmission Mode	Band	Max Reported SAR 1-g (W/kg)	Σ SARi (W/kg)	Limit SAR 1-g (W/kg)	Verdict
TETRA	799 – 805 MHz	4.47	4.75	8.0	Pass
Bluetooth	2.45GHz	0.28			
TI D-LMR	809 – 824 MHz	4.58	4.86	8.0	Pass
Bluetooth	2.45GHz	0.28			
P25	799 – 805 MHz	7.01	7.29	8.0	Pass
Bluetooth	2.45GHz	0.28			

5.7. Results for TETRA 769 – 775 MHz band.

- **Head measurements**

Side / Position	Dist (mm)	Frequency (MHz)	FAST SAR 1-g (W/kg)	SAR 1-g (W/kg)	Power Drift (%)	Measured SAR 1-g (W/kg)	Plot No.
Left / Cheek	0	772.0125	0.356	NM ²	0.12	0.712	
Left / 15° Tilted	0	772.0125	0.842	0.838	1.98	1.676	1
Right / Cheek	0	772.0125	0.273	NM ²	1.27	0.546	
Right / 15° Tilted	0	772.0125	0.485	NM ²	3.28	0.970	
Left / 15° Tilted	0	769.0125	NM ³				
Left / 15° Tilted	0	774.9875	NM ³				
Front of Face (device)	25	772.0125	0.0765	0.0765	3.51	0.153	
Front of Face (Antenna)	25	772.0125	0.512	0.512	0.23	1.024	2

2 and 3: See remarks and comments.

- **Body measurements**

Position	Dist (mm)	Antenna Dist (mm)	Frequency (MHz)	FAST SAR 1-g (W/kg)	SAR 1-g (W/kg)	Power Drift (%)	Measured SAR 1-g (W/kg)	Plot No.
Back face (CA 1+AA1)	0	23	772.0125	1.01	1.04	-1.83	2.158	
Back face (CA 2+AA1)	0	18	772.0125	1.27	1.28	2.80	2.560	3
Back face (CA 3+AA1)	0	29	772.0125	0.412	0.427	0.69	0.854	
Back face (CA 2+AA1)	0	18	769.0125	NM ³				
Back face (CA 2+AA1)	0	18	774.9875	NM ³				
Back face (CA 2+AA2)	0	18	772.0125	NM ⁴				
Back face (CA 2+AA3)	0	18	772.0125	NM ⁴				

3 and 4: See remarks and comments.

5.8. Results for TETRA 799 – 805 MHz band.

- **Head measurements**

Side / Position	Dist (mm)	Frequency (MHz)	FAST SAR 1-g (W/kg)	SAR 1-g (W/kg)	Power Drift (%)	Measured SAR 1-g (W/kg)	Plot No.
Left / Cheek	0	802.0125	0.506	NM ²	-3.06	1.077	
Left / 15° Tilted	0	802.0125	1.01	1.06	-0.12	2.125	4
Right / Cheek	0	802.0125	0.372	NM ²	0.58	0.744	
Right / 15° Tilted	0	802.0125	0.659	NM ²	0.58	1.318	
Left / 15° Tilted	0	799.0125	NM ³				
Left / 15° Tilted	0	804.9875	NM ³				
Front of Face (device)	25	802.0125	0.107	0.107	-0.92	0.218	
Front of Face (Antenna)	25	802.0125	0.631	0.642	2.92	1.284	5

2 and 3: See remarks and comments.

- **Body measurements**

Position	Dist (mm)	Antenna Dist (mm)	Frequency (MHz)	FAST SAR 1-g (W/kg)	SAR 1-g (W/kg)	Power Drift (%)	Measured SAR 1-g (W/kg)	Plot No.
Back face (CA 1+AA1)	0	23	802.0125	1.13	1.14	-0.92	2.322	
Back face (CA 2+AA1)	0	18	802.0125	1.69	1.7	-0.80	3.455	6
Back face (CA 3+AA1)	0	29	802.0125	0.444	0.459	-2.16	0.959	
Back face (CA 2+AA1)	0	18	799.0125	NM ³				
Back face (CA 2+AA1)	0	18	804.9875	NM ³				
Back face (CA 2+AA2)	0	18	802.0125	NM ⁴				
Back face (CA 2+AA3)	0	18	802.0125	NM ⁴				

3 and 4: See remarks and comments.

5.9. Results for TETRA 809 – 824 MHz band.

- **Head measurements**

Side / Position	Dist (mm)	Frequency (MHz)	FAST SAR 1-g (W/kg)	SAR 1-g (W/kg)	Power Drift (%)	Measured SAR 1-g (W/kg)	Plot No.
Left / Cheek	0	816.5	0.503	NM ²	-0.69	1.020	
Left / 15° Tilted	0	816.5	1.02	1.06	0.46	2.120	7
Right / Cheek	0	816.5	0.452	NM ²	0.35	0.904	
Right / 15° Tilted	0	816.5	0.809	NM ²	1.62	1.618	
Left / 15° Tilted	0	809.0125	NM ³				
Left / 15° Tilted	0	823.9875	NM ³				
Front of Face (device)	25	816.5	0.115	0.113	-0.12	0.227	
Front of Face (Antenna)	25	816.5	0.597	0.604	-0.46	1.219	8

2 and 3: See remarks and comments.

- **Body measurements**

Position	Dist (mm)	Antenna Dist (mm)	Frequency (MHz)	FAST SAR 1-g (W/kg)	SAR 1-g (W/kg)	Power Drift (%)	Measured SAR 1-g (W/kg)	Plot No.
Back face (CA 1+AA1)	0	23	816.5	0.773	0.775	1.86	1.550	
Back face (CA 2+AA1)	0	18	816.5	1.3	1.31	-0.46	2.644	9
Back face (CA 3+AA1)	0	29	816.5	0.397	0.405	-0.57	0.819	
Back face (CA 2+AA1)	0	18	809.0125	NM ³				
Back face (CA 2+AA1)	0	18	823.9875	NM ³				
Back face (CA 2+AA2)	0	18	816.5	NM ⁴				
Back face (CA 2+AA3)	0	18	816.5	NM ⁴				

3 and 4: See remarks and comments.

5.10. Results for TETRA 854 – 869 MHz band.

- **Head measurements**

Side / Position	Dist (mm)	Frequency (MHz)	FAST SAR 1-g (W/kg)	SAR 1-g (W/kg)	Power Drift (%)	Measured SAR 1-g (W/kg)	Plot No.
Left / Cheek	0	861.5	0.722	NM ²	-0.92	1.471	
Left / 15° Tilted	0	861.5	1.07	1.11	0.00	2.220	10
Right / Cheek	0	861.5	0.723	NM ²	0.69	1.446	
Right / 15° Tilted	0	861.5	1.01	NM ²	1.62	2.020	
Left / 15° Tilted	0	854.0125	NM ³				
Left / 15° Tilted	0	868.9875	NM ³				
Front of Face (device)	25	861.5	0.128	0.123	0.69	0.246	
Front of Face (Antenna)	25	861.5	0.445	0.453	1.16	0.906	11

2 and 3: See remarks and comments

- **Body measurements**

Position	Dist (mm)	Antenna Dist (mm)	Frequency (MHz)	FAST SAR 1-g (W/kg)	SAR 1-g (W/kg)	Power Drift (%)	Measured SAR 1-g (W/kg)	Plot No.
Back face (CA 1+AA1)	0	23	861.5	0.773	0.775	1.86	1.550	
Back face (CA 2+AA1)	0	18	861.5	0.953	1.01	3.04	2.020	12
Back face (CA 3+AA1)	0	29	861.5	0.397	0.405	-0.57	0.819	
Back face (CA 2+AA1)	0	18	854.0125	NM ³				
Back face (CA 2+AA1)	0	18	868.9875	NM ³				
Back face (CA 2+AA2)	0	18	861.5	NM ⁴				
Back face (CA 2+AA3)	0	18	861.5	NM ⁴				

3 and 4: See remarks and comments.

5.11. Results for TI D-LMR 769 – 775 MHz band.

- **Head measurements**

Side / Position	Dist (mm)	Frequency (MHz)	FAST SAR 1-g (W/kg)	SAR 1-g (W/kg)	Power Drift (%)	Measured SAR 1-g (W/kg)	Plot No.
Left / Cheek	0	772.0125	0.365	NM ²	1.27	0.793	
Left / 15° Tilted	0	772.0125	0.834	0.857	0.35	1.863	13
Right / Cheek	0	772.0125	0.266	NM ²	1.86	0.578	
Right / 15° Tilted	0	772.0125	0.484	NM ²	1.74	1.052	
Left / 15° Tilted	0	769.0125	NM ³				
Left / 15° Tilted	0	774.9875	NM ³				
Front of Face (device)	25	772.0125	0.0802	0.0802	2.21	0.174	
Front of Face (Antenna)	25	772.0125	0.521	0.53	-1.83	1.195	14

2 and 3: See remarks and comments.

- **Body measurements**

Position	Dist (mm)	Antenna Dist (mm)	Frequency (MHz)	FAST SAR 1-g (W/kg)	SAR 1-g (W/kg)	Power Drift (%)	Measured SAR 1-g (W/kg)	Plot No.
Back face (CA 1+AA1)	0	23	772.0125	1.02	1.01	1.39	2.196	
Back face (CA 2+AA1)	0	18	772.0125	1.22	1.26	0.81	2.739	15
Back face (CA 3+AA1)	0	29	772.0125	0.4	0.418	0.00	0.909	
Back face (CA 2+AA1)	0	18	769.0125	NM ³				
Back face (CA 2+AA1)	0	18	774.9875	NM ³				
Back face (CA 2+AA2)	0	18	772.0125	NM ⁴				
Back face (CA 2+AA3)	0	18	772.0125	NM ⁴				

3 and 4: See remarks and comments.

5.12. Results for TI D-LMR 799 – 805 MHz band.

- Head measurements**

Side / Position	Dist (mm)	Frequency (MHz)	FAST SAR 1-g (W/kg)	SAR 1-g (W/kg)	Power Drift (%)	Measured SAR 1-g (W/kg)	Plot No.
Left / Cheek	0	802.0125	0.498	NM ²	-0.92	1.103	
Left / 15° Tilted	0	802.0125	1.01	1.00	0.12	2.174	16
Right / Cheek	0	802.0125	0.36	NM ²	1.04	0.783	
Right / 15° Tilted	0	802.0125	0.65	NM ²	0.35	1.413	
Left / 15° Tilted	0	799.0125	NM ³				
Left / 15° Tilted	0	804.9875	NM ³				
Front of Face (device)	25	802.0125	0.104	0.104	-1.71	0.234	
Front of Face (Antenna)	25	802.0125	0.645	0.654	-0.57	1.438	17

2 and 3: See remarks and comments.

- Body measurements**

Position	Dist (mm)	Antenna Dist (mm)	Frequency (MHz)	FAST SAR 1-g (W/kg)	SAR 1-g (W/kg)	Power Drift (%)	Measured SAR 1-g (W/kg)	Plot No.
Back face (CA 1+AA1)	0	23	802.0125	1.13	1.18	0.69	2.565	
Back face (CA 2+AA1)	0	18	802.0125	1.51	1.53	-0.12	3.334	18
Back face (CA 3+AA1)	0	29	802.0125	0.436	0.448	0.46	0.974	
Back face (CA 2+AA1)	0	18	799.0125	NM ³				
Back face (CA 2+AA1)	0	18	804.9875	NM ³				
Back face (CA 2+AA2)	0	18	802.0125	NM ⁴				
Back face (CA 2+AA3)	0	18	802.0125	NM ⁴				

3 and 4: See remarks and comments.

5.13. Results for TI D-LMR 809 – 824 MHz band.

- **Head measurements**

Side / Position	Dist (mm)	Frequency (MHz)	FAST SAR 1-g (W/kg)	SAR 1-g (W/kg)	Power Drift (%)	Measured SAR 1-g (W/kg)	Plot No.
Left / Cheek	0	816.5	0.487	NM ²	0.12	1.059	
Left / 15° Tilted	0	816.5	0.968	0.992	0.58	2.157	19
Right / Cheek	0	816.5	0.395	NM ²	-0.57	0.869	
Right / 15° Tilted	0	816.5	0.716	NM ²	0.35	1.557	
Left / 15° Tilted	0	809.0125	NM ³				
Left / 15° Tilted	0	823.9875	NM ³				
Front of Face (device)	25	816.5	0.115	0.117	-0.23	0.256	
Front of Face (Antenna)	25	816.5	0.638	0.64	-0.46	1.404	20

2 and 3: See remarks and comments.

- **Body measurements**

Position	Dist (mm)	Antenna Dist (mm)	Frequency (MHz)	FAST SAR 1-g (W/kg)	SAR 1-g (W/kg)	Power Drift (%)	Measured SAR 1-g (W/kg)	Plot No.
Back face (CA 1+AA1)	0	23	816.5	1.06	1.07	-0.46	2.348	
Back face (CA 2+AA1)	0	18	816.5	1.58	1.6	0.46	3.478	21
Back face (CA 3+AA1)	0	29	816.5	0.39	0.39	-0.80	0.862	
Back face (CA 2+AA1)	0	18	809.0125	NM ³				
Back face (CA 2+AA1)	0	18	823.9875	NM ³				
Back face (CA 2+AA2)	0	18	816.5	NM ⁴				
Back face (CA 2+AA3)	0	18	816.5	NM ⁴				

3 and 4: See remarks and comments.

5.14. Results for TI D-LMR 854 – 869 MHz band.

- **Head measurements**

Side / Position	Dist (mm)	Frequency (MHz)	FAST SAR 1-g (W/kg)	SAR 1-g (W/kg)	Power Drift (%)	Measured SAR 1-g (W/kg)	Plot No.
Left / Cheek	0	861.5	0.849	NM ²	1.98	1.846	
Left / 15° Tilted	0	861.5	1.27	1.27	-0.23	2.774	22
Right / Cheek	0	861.5	0.666	NM ²	-2.73	1.530	
Right / 15° Tilted	0	861.5	0.79	NM ²	2.68	1.670	
Left / 15° Tilted	0	854.0125	NM ³				
Left / 15° Tilted	0	868.9875	NM ³				
Front of Face (device)	25	861.5	0.255	0.256	-0.34	0.560	
Front of Face (Antenna)	25	861.5	0.407	0.39	1.27	0.848	23

2 and 3: See remarks and comments.

- **Body measurements**

Position	Dist (mm)	Antenna Dist (mm)	Frequency (MHz)	FAST SAR 1-g (W/kg)	SAR 1-g (W/kg)	Power Drift (%)	Measured SAR 1-g (W/kg)	Plot No.
Back face (CA 1+AA1)	0	23	861.5	0.824	0.823	-3.39	1.917	
Back face (CA 2+AA1)	0	18	861.5	0.958	1.02	1.62	2.217	24
Back face (CA 3+AA1)	0	29	861.5	0.336	0.339	0.46	0.737	
Back face (CA 2+AA1)	0	18	854.0125	NM ³				
Back face (CA 2+AA1)	0	18	868.9875	NM ³				
Back face (CA 2+AA2)	0	18	861.5	NM ⁴				
Back face (CA 2+AA3)	0	18	861.5	NM ⁴				

3 and 4: See remarks and comments.

5.15. Results for P25 769 – 775 MHz band.

- **Head measurements**

Side / Position	Dist (mm)	Frequency (MHz)	FAST SAR 1-g (W/kg)	SAR 1-g (W/kg)	Power Drift (%)	Measured SAR 1-g (W/kg)	Plot No.
Front of Face (device)	25	772.0125	0.503	0.503	0.81	0.252	
Front of Face (Antenna)	25	772.0125	3.5	3.58	-1.03	1.827	25

* Note: Next to the ear configuration is not supported by P25 mode.

- **Body measurements**

Position	Dist (mm)	Antenna Dist (mm)	Frequency (MHz)	FAST SAR 1-g (W/kg)	SAR 1-g (W/kg)	Power Drift (%)	Measured SAR 1-g (W/kg)	Plot No.
Back face (CA 1+AA1)	0	23	772.0125	6.45	6.62	0.00	3.310	
Back face (CA 2+AA1)	0	18	772.0125	9.66	9.51	-0.92	4.843	26
Back face (CA 2+AA1)	0	18	769.0125	9.60	9.44	-0.23	4.742	
Back face (CA 2+AA1)	0	18	774.9875	9.63	9.41	2.45	4.705	
Back face (CA 2+AA2)	0	18	772.0125	9.65	9.49	-0.12	4.756	
Back face (CA 2+AA3)	0	18	772.0125	9.56	9.34	-1.37	4.801	
Back face (CA 3+AA1)	0	29	772.0125	2.53	2.51	0.23	1.255	

5.16. Results for P25 799 – 805 MHz band.

- **Head measurements**

Side / Position	Dist (mm)	Frequency (MHz)	FAST SAR 1-g (W/kg)	SAR 1-g (W/kg)	Power Drift (%)	Measured SAR 1-g (W/kg)	Plot No.
Front of Face (device)	25	802.0125	0.606	0.604	-1.14	0.309	
Front of Face (Antenna)	25	802.0125	4.1	4.09	-1.60	2.112	27

* Note: Next to the ear configuration is not supported by P25 mode.

- **Body measurements**

Position	Dist (mm)	Antenna Dist (mm)	Frequency (MHz)	FAST SAR 1-g (W/kg)	SAR 1-g (W/kg)	Power Drift (%)	Measured SAR 1-g (W/kg)	Plot No.
Back face (CA 1+AA1)	0	23	802.0125	7.52	7.14	-2.28	3.738	
Back face (CA 1+AA1)	0	23	799.0125	7.14	6.96	-0.57	3.520	
Back face (CA 1+AA1)	0	23	804.9875	7.34	7.31	-0.34	3.680	
Back face (CA 2+AA1)	0	18	802.0125	10.7	10.7	0.23	5.350	28
Back face (CA 2+AA1)	0	18	799.0125	9.91	9.96	-0.34	5.015	
Back face (CA 2+AA1)	0	18	804.9875	10.2	10.2	-1.71	5.279	
Back face (CA 2+AA2)	0	18	802.0125	10.5	10.5	-0.46	5.299	
Back face (CA 2+AA3)	0	18	802.0125	10	10.1	-0.12	5.062	
Back face (CA 3+AA1)	0	29	802.0125	2.6	2.53	-0.12	1.268	

5.17. Variability results.

According to KDB 865664 D01 SAR Measurement 100 MHz to 6 GHz, paragraph “2.8.1. SAR measurement variability”, repeated measurements are required for each frequency band, which is determined by the SAR probe calibration point and tissue-equivalent medium used, only when the measured SAR, without been scaled to the maximum tune-up tolerance, is > 4 W/kg for occupational/controlled exposure.

Band	Mode	Side / Position	Frequency (MHz)	SAR 1-g (W/kg)	Power Drift (%)	Measured SAR 1-g (W/kg)	Variation < 20 %	Plot No
799 – 805 MHz	P25	Back face (CA 2+AA1)	802.0125	10.9	-0.34	5.488	√	29

Appendix C – Measurement report

TETRA 769-775 MHz – Left hand side – Tilted position – Plot N° 1

Test Laboratory: DEKRA Testing and Certification, S.A.U; Date: 2017-04-03

DUT: HTT500-2+1/2 Ant; Type: PTT Radio; Serial: NYPB-48

Communication System: UID 0, TETRA (0); Frequency: 772.013 MHz; Duty Cycle: 1:4.00037

Medium parameters used (interpolated): $f = 772.013$ MHz; $\sigma = 0.904$ S/m; $\epsilon_r = 42.532$; $\rho = 1000$ kg/m³

Phantom section: Left Section

DASY5 Configuration:

- Probe: EX3DV4 - SN3687; ConvF(8.82, 8.82, 8.82); Calibrated: 2016-07-26;

- Sensor-Surface: 3mm (Mechanical Surface Detection (Locations From Previous Scan Used)), Sensor-Surface: 4mm (Mechanical Surface Detection)

- Electronics: DAE4 Sn669; Calibrated: 2016-07-18

- Phantom: SAM head-body simulator ; Type: Twin SAM V4.0; Serial: ---

- Measurement SW: DASY52, Version 52.8 (8); SEMCAD X Version 14.6.10 (7331)

Left Hand Side/769-775MHz/TETRA, Mid CH, Tilt/Area Scan (61x231x1):

Interpolated grid: dx=1.500 mm, dy=1.500 mm

[Info: Interpolated medium parameters used for SAR evaluation.](#)

Maximum value of SAR (interpolated) = 1.01 W/kg

Left Hand Side/769-775MHz/TETRA, Mid CH, Tilt/Zoom Scan (5x5x7)/Cube 0:

Measurement grid: dx=8mm, dy=8mm, dz=5mm

Reference Value = 22.01 V/m; Power Drift = -0.17 dB

Peak SAR (extrapolated) = 1.50 W/kg

SAR(1 g) = 0.838 W/kg; SAR(10 g) = 0.523 W/kg (SAR corrected for target medium)

[Info: Interpolated medium parameters used for SAR evaluation.](#)

Maximum value of SAR (measured) = 0.912 W/kg

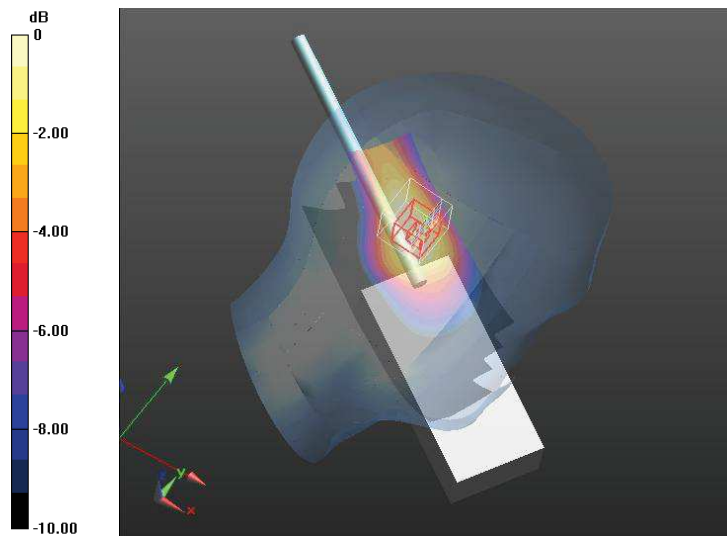

0 dB = 0.912 W/kg = -0.40 dBW/kg

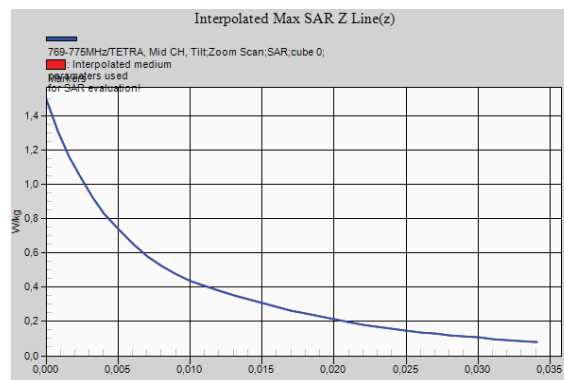

TETRA 769-775 MHz – Front of face (Antenna side) 25 mm – Plot N° 2

Test Laboratory: DEKRA Testing and Certification, S.A.U; Date: 2017-04-04

DUT: HTT500-2+1/2 Ant; Type: PTT Radio; Serial: NYPB-48

Communication System: UID 0, TETRA (0); Frequency: 772.013 MHz; Duty Cycle: 1:4.00037

Medium parameters used (interpolated): $f = 772.013$ MHz; $\sigma = 0.904$ S/m; $\epsilon_r = 42.532$; $\rho = 1000$ kg/m³

Phantom section: Flat Section

DASY5 Configuration:

- Probe: EX3DV4 - SN3687; ConvF(8.82, 8.82, 8.82); Calibrated: 2016-07-26;

- Sensor-Surface: 3mm (Mechanical Surface Detection (Locations From Previous Scan Used)), Sensor-Surface: 4mm (Mechanical Surface Detection)

- Electronics: DAE4 Sn669; Calibrated: 2016-07-18

- Phantom: SAM head-body simulator ; Type: Twin SAM V4.0; Serial: ---

- Measurement SW: DASY52, Version 52.8 (8); SEMCAD X Version 14.6.10 (7331)

Flat Phantom, Face, d=25mm, Antenna side/769-775MHz/TETRA, Mid CH, Front face/Area Scan (51x151x1):

Interpolated grid: dx=1.500 mm, dy=1.500 mm

Info: [Interpolated medium parameters used for SAR evaluation.](#)

Maximum value of SAR (interpolated) = 0.583 W/kg

Flat Phantom, Face, d=25mm, Antenna side/769-775MHz/TETRA, Mid CH, Front face/Zoom Scan (5x6x7)/Cube 0:

Measurement grid: dx=8mm, dy=8mm, dz=5mm

Reference Value = 22.39 V/m; Power Drift = 0.02 dB

Peak SAR (extrapolated) = 0.678 W/kg

SAR(1 g) = 0.512 W/kg; SAR(10 g) = 0.376 W/kg (SAR corrected for target medium)

Info: [Interpolated medium parameters used for SAR evaluation.](#)

Maximum value of SAR (measured) = 0.532 W/kg

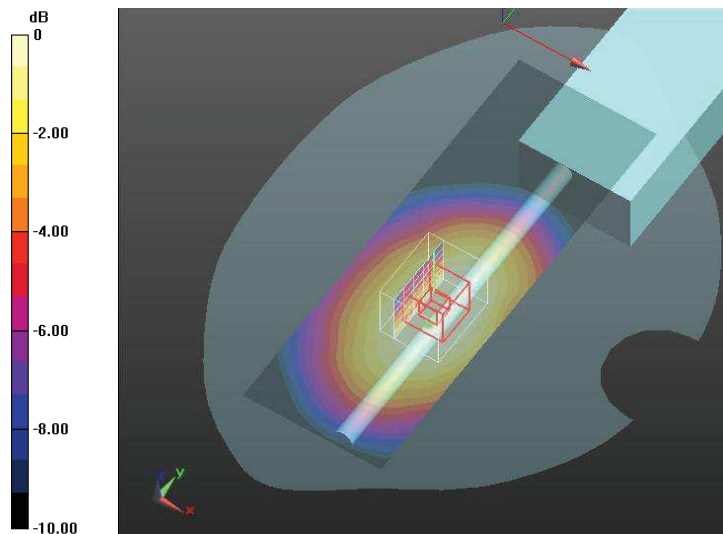

0 dB = 0.532 W/kg = -2.74 dBW/kg

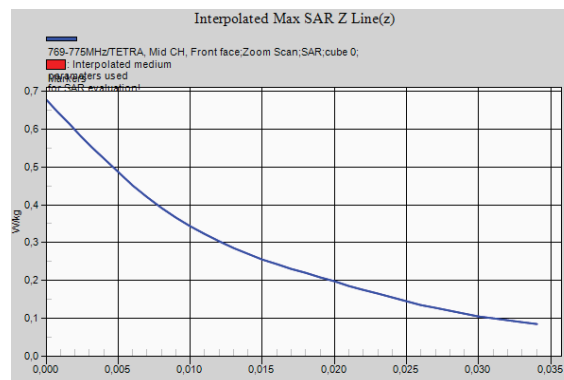

TETRA 769-775 MHz – Body – Carry 2+Audio 1 Accesories – Plot N° 3

Test Laboratory: DEKRA Testing and Certification, S.A.U; Date: 2017-04-17

DUT: HTT500-2+1/2 Ant; Type: PTT Radio; Serial: NYPB-48

Communication System: UID 0, TETRA (0); Frequency: 772.013 MHz; Duty Cycle: 1:4.00037

Medium parameters used (interpolated): $f = 772.013$ MHz; $\sigma = 0.994$ S/m; $\epsilon_r = 55.764$; $\rho = 1000$ kg/m³

Phantom section: Flat Section

DASY5 Configuration:

- Probe: EX3DV4 - SN3687; ConvF(8.61, 8.61, 8.61); Calibrated: 2016-07-26;
- Sensor-Surface: 3mm (Mechanical Surface Detection (Locations From Previous Scan Used)), Sensor-Surface: 4mm (Mechanical Surface Detection)
- Electronics: DAE4 Sn669; Calibrated: 2016-07-18
- Phantom: Flat Phantom ELI4.0; Type: QDOVA001BA; Serial: SN:1060
- Measurement SW: DASY52, Version 52.8 (8); SEMCAD X Version 14.6.10 (7331)

Flat Phantom, Body, d=0mm,/769-775MHz/TETRA, Mid CH, Back face, Acc C2+A1/Area Scan (61x231x1):

Interpolated grid: dx=1.500 mm, dy=1.500 mm

[Info: Interpolated medium parameters used for SAR evaluation.](#)

Maximum value of SAR (interpolated) = 1.47 W/kg

Flat Phantom, Body, d=0mm,/769-775MHz/TETRA, Mid CH, Back face, Acc C2+A1/Zoom Scan (5x6x7)/Cube 0:

Measurement grid: dx=8mm, dy=8mm, dz=5mm

Reference Value = 9.613 V/m; Power Drift = 0.24 dB

Peak SAR (extrapolated) = 1.89 W/kg

SAR(1 g) = 1.28 W/kg; SAR(10 g) = 0.887 W/kg (SAR corrected for target medium)

[Info: Interpolated medium parameters used for SAR evaluation.](#)

Maximum value of SAR (measured) = 1.37 W/kg

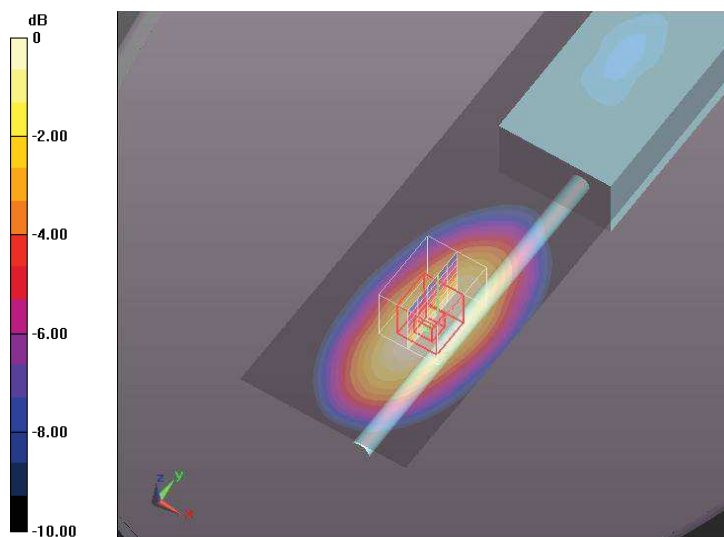

0 dB = 1.37 W/kg = 1.37 dBW/kg

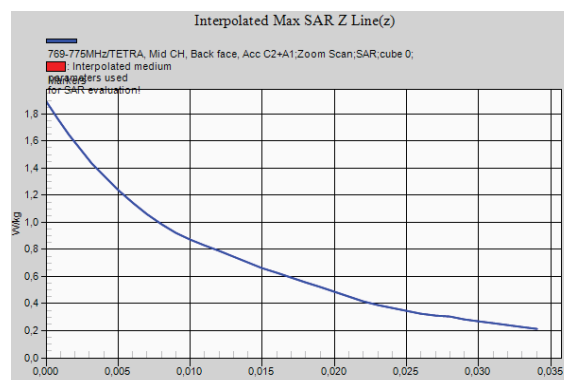

TETRA 799-805 MHz – Left hand side – Tilted position – Plot N° 4

Test Laboratory: DEKRA Testing and Certification, S.A.U; Date: 2017-04-03

DUT: HTT500-2+1/2 Ant; Type: PTT Radio; Serial: NYPB-48

Communication System: UID 0, TETRA (0); Frequency: 802.013 MHz; Duty Cycle: 1:4.00037

Medium parameters used (interpolated): $f = 802.013$ MHz; $\sigma = 0.934$ S/m; $\epsilon_r = 42.154$; $\rho = 1000$ kg/m³

Phantom section: Left Section

DASY5 Configuration:

- Probe: EX3DV4 - SN3687; ConvF(8.82, 8.82, 8.82); Calibrated: 2016-07-26;
- Sensor-Surface: 3mm (Mechanical Surface Detection (Locations From Previous Scan Used)), Sensor-Surface: 4mm (Mechanical Surface Detection)
- Electronics: DAE4 Sn669; Calibrated: 2016-07-18
- Phantom: SAM head-body simulator ; Type: Twin SAM V4.0; Serial: ---
- Measurement SW: DASY52, Version 52.8 (8); SEMCAD X Version 14.6.10 (7331)

Left Hand Side/799-805MHz/TETRA, Mid CH, Tilt/Area Scan (61x231x1):

Interpolated grid: dx=1.500 mm, dy=1.500 mm

Info: [Interpolated medium parameters used for SAR evaluation.](#)

Maximum value of SAR (interpolated) = 1.21 W/kg

Left Hand Side/799-805MHz/TETRA, Mid CH, Tilt/Zoom Scan (5x5x7)/Cube 0:

Measurement grid: dx=8mm, dy=8mm, dz=5mm

Reference Value = 25.18 V/m; Power Drift = -0.01 dB

Peak SAR (extrapolated) = 1.83 W/kg

SAR(1 g) = 1.06 W/kg; SAR(10 g) = 0.647 W/kg (SAR corrected for target medium)

Info: [Interpolated medium parameters used for SAR evaluation.](#)

Maximum value of SAR (measured) = 1.15 W/kg

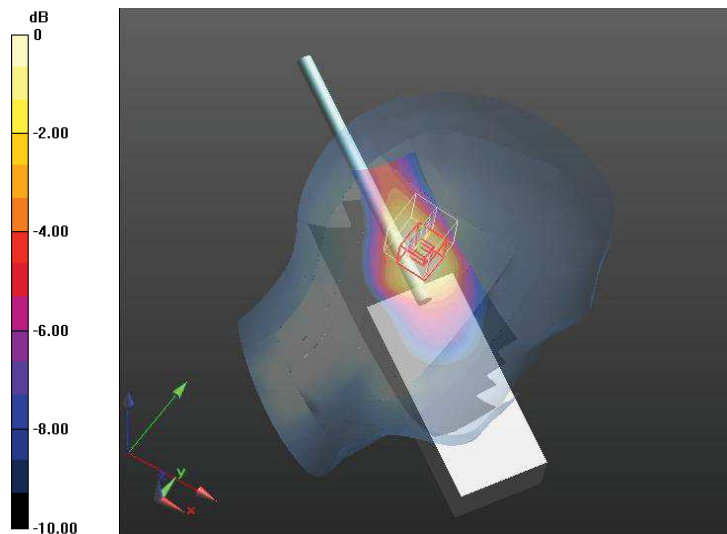

0 dB = 1.15 W/kg = 0.61 dBW/kg

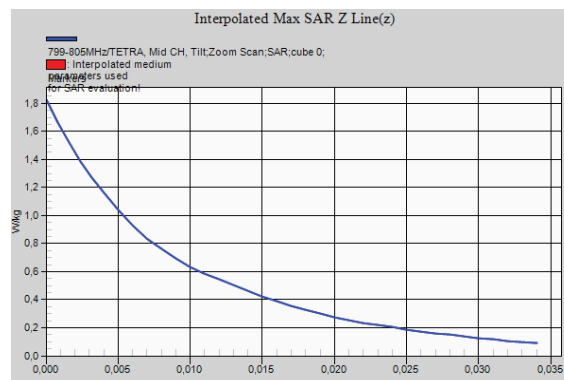

TETRA 799-805 MHz – Front of face (Antenna side) 25 mm – Plot N° 5

Test Laboratory: DEKRA Testing and Certification, S.A.U; Date: 2017-04-04

DUT: HTT500-2+1/2 Ant; Type: PTT Radio; Serial: NYPB-48

Communication System: UID 0, TETRA (0); Frequency: 802.013 MHz; Duty Cycle: 1:4.00037

Medium parameters used (interpolated): $f = 802.013$ MHz; $\sigma = 0.934$ S/m; $\epsilon_r = 42.154$; $\rho = 1000$ kg/m³

Phantom section: Flat Section

DASY5 Configuration:

- Probe: EX3DV4 - SN3687; ConvF(8.82, 8.82, 8.82); Calibrated: 2016-07-26;
- Sensor-Surface: 3mm (Mechanical Surface Detection), Sensor-Surface: 4mm (Mechanical Surface Detection)
- Electronics: DAE4 Sn669; Calibrated: 2016-07-18
- Phantom: SAM head-body simulator ; Type: Twin SAM V4.0; Serial: ---
- Measurement SW: DASY52, Version 52.8 (8); SEMCAD X Version 14.6.10 (7331)

Flat Phantom, Face, d=25mm, Antenna side/799-805MHz/TETRA, Mid CH, Front face/Area Scan (51x151x1):

Interpolated grid: dx=1.500 mm, dy=1.500 mm

[Info: Interpolated medium parameters used for SAR evaluation.](#)

Maximum value of SAR (interpolated) = 0.719 W/kg

Flat Phantom, Face, d=25mm, Antenna side/799-805MHz/TETRA, Mid CH, Front face/Zoom Scan (5x6x7)/Cube 0:

Measurement grid: dx=8mm, dy=8mm, dz=5mm

Reference Value = 22.72 V/m; Power Drift = 0.25 dB

Peak SAR (extrapolated) = 0.853 W/kg

SAR(1 g) = 0.642 W/kg; SAR(10 g) = 0.458 W/kg (SAR corrected for target medium)

[Info: Interpolated medium parameters used for SAR evaluation.](#)

Maximum value of SAR (measured) = 0.691 W/kg

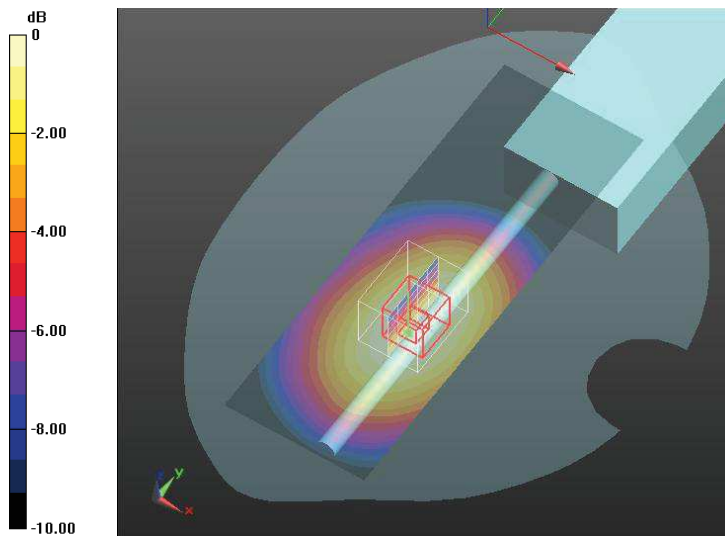

0 dB = 0.691 W/kg = -1.61 dBW/kg

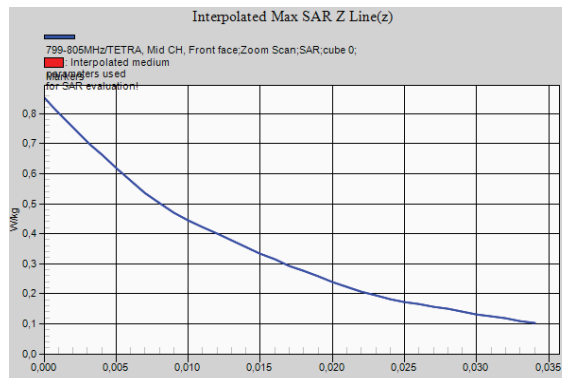

TETRA 799-805 MHz – Body – Carry 2+Audio 1 Accesories – Plot N° 6

Test Laboratory: DEKRA Testing and Certification, S.A.U; Date: 2017-04-17

DUT: HTT500-2+1/2 Ant; Type: PTT Radio; Serial: NYPB-48

Communication System: UID 0, TETRA (0); Frequency: 802.013 MHz; Duty Cycle: 1:4.00037

Medium parameters used (interpolated): $f = 802.013$ MHz; $\sigma = 1.01$ S/m; $\epsilon_r = 55.394$; $\rho = 1000$ kg/m³

Phantom section: Flat Section

DASY5 Configuration:

- Probe: EX3DV4 - SN3687; ConvF(8.61, 8.61, 8.61); Calibrated: 2016-07-26;
- Sensor-Surface: 3mm (Mechanical Surface Detection (Locations From Previous Scan Used)), Sensor-Surface: 4mm (Mechanical Surface Detection)
- Electronics: DAE4 Sn669; Calibrated: 2016-07-18
- Phantom: Flat Phantom ELI4.0; Type: QDOVA001BA; Serial: SN:1060
- Measurement SW: DASY52, Version 52.8 (8); SEMCAD X Version 14.6.10 (7331)

Flat Phantom, Body, d=0mm,/799-805MHz/TETRA, Mid CH, Back face, Acc C2+A1/Area Scan (61x231x1):

Interpolated grid: dx=1.500 mm, dy=1.500 mm

[Info: Interpolated medium parameters used for SAR evaluation.](#)

Maximum value of SAR (interpolated) = 1.96 W/kg

Flat Phantom, Body, d=0mm,/799-805MHz/TETRA, Mid CH, Back face, Acc C2+A1/Zoom Scan (5x5x7)/Cube 0:

Measurement grid: dx=8mm, dy=8mm, dz=5mm

Reference Value = 11.25 V/m; Power Drift = -0.07 dB

Peak SAR (extrapolated) = 2.66 W/kg

SAR(1 g) = 1.7 W/kg; SAR(10 g) = 1.13 W/kg (SAR corrected for target medium)

[Info: Interpolated medium parameters used for SAR evaluation.](#)

Maximum value of SAR (measured) = 1.85 W/kg

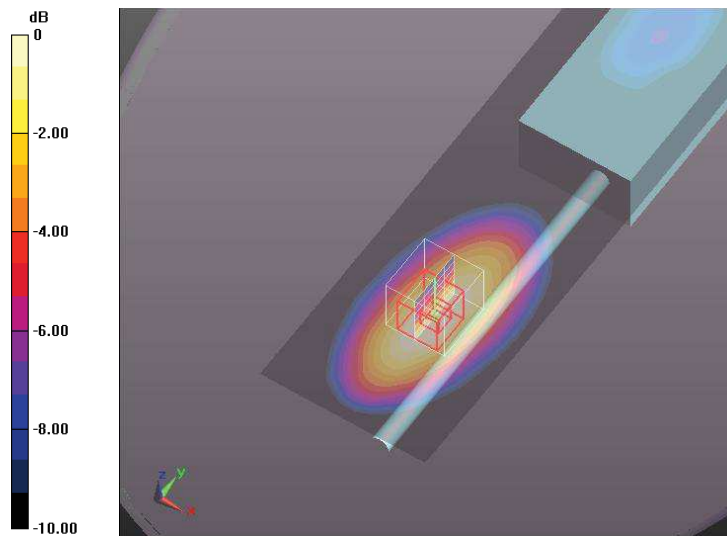

0 dB = 1.85 W/kg = 2.67 dBW/kg

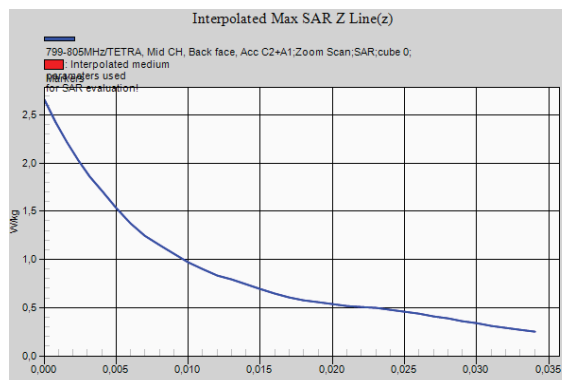

TETRA 809-824 MHz – Left hand side – Tilted position – Plot N° 7

Test Laboratory: DEKRA Testing and Certification, S.A.U; Date: 2017-03-30

DUT: HTT500-2+1/2 Ant; Type: PTT Radio; Serial: NYPB-48

Communication System: UID 0, TETRA (0); Frequency: 816.5 MHz; Duty Cycle: 1:4.00037
 Medium parameters used (interpolated): $f = 816.5 \text{ MHz}$; $\sigma = 0.863 \text{ S/m}$; $\epsilon_r = 41.303$; $\rho = 1000 \text{ kg/m}^3$
 Phantom section: Left Section

DASY5 Configuration:

- Probe: EX3DV4 - SN3687; ConvF(8.61, 8.61, 8.61); Calibrated: 2016-07-26;
- Sensor-Surface: 3mm (Mechanical Surface Detection (Locations From Previous Scan Used)), Sensor-Surface: 4mm (Mechanical Surface Detection)
- Electronics: DAE4 Sn669; Calibrated: 2016-07-18
- Phantom: SAM head-body simulator ; Type: Twin SAM V4.0; Serial: ---
- Measurement SW: DASY52, Version 52.8 (8); SEMCAD X Version 14.6.10 (7331)

Left Hand Side,/809-824MHz/TETRA, Mid CH, Tilt/Area Scan (61x231x1):

Interpolated grid: $dx=1.500 \text{ mm}$, $dy=1.500 \text{ mm}$

Info: [Interpolated medium parameters used for SAR evaluation.](#)

Maximum value of SAR (interpolated) = 1.16 W/kg

Left Hand Side,/809-824MHz/TETRA, Mid CH, Tilt/Zoom Scan (5x5x7)/Cube 0:

Measurement grid: $dx=8\text{mm}$, $dy=8\text{mm}$, $dz=5\text{mm}$

Reference Value = 25.93 V/m; Power Drift = 0.04 dB

Peak SAR (extrapolated) = 1.67 W/kg

SAR(1 g) = 1.06 W/kg; SAR(10 g) = 0.656 W/kg (SAR corrected for target medium)

Info: [Interpolated medium parameters used for SAR evaluation.](#)

Maximum value of SAR (measured) = 1.08 W/kg

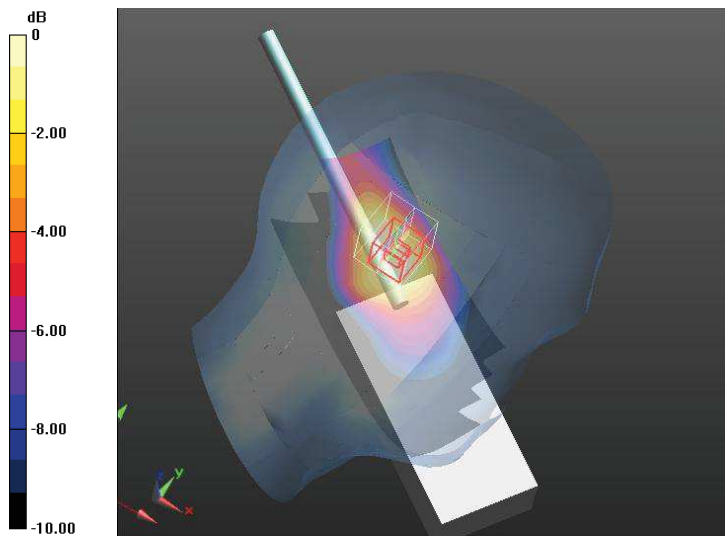

0 dB = 1.08 W/kg = 0.33 dBW/kg

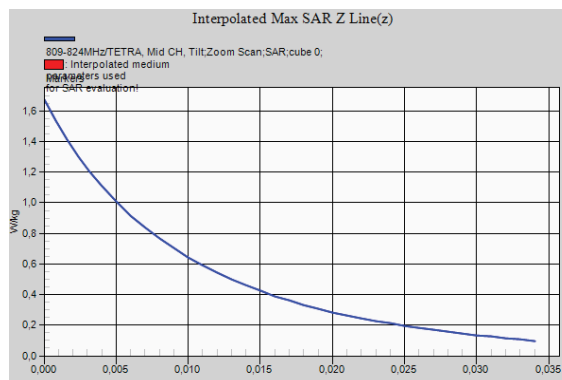

TETRA 809-824 MHz – Front of face (Antenna side) 25 mm – Plot N° 8

Test Laboratory: DEKRA Testing and Certification, S.A.U; Date: 2017-03-30

DUT: HTT500-2+1/2 Ant; Type: PTT Radio; Serial: NYPB-48

Communication System: UID 0, TETRA (0); Frequency: 816.5 MHz; Duty Cycle: 1:4.00037
 Medium parameters used (interpolated): $f = 816.5 \text{ MHz}$; $\sigma = 0.863 \text{ S/m}$; $\epsilon_r = 41.303$; $\rho = 1000 \text{ kg/m}^3$

Phantom section: Flat Section

DASY5 Configuration:

- Probe: EX3DV4 - SN3687; ConvF(8.61, 8.61, 8.61); Calibrated: 2016-07-26;
- Sensor-Surface: 3mm (Mechanical Surface Detection (Locations From Previous Scan Used)), Sensor-Surface: 4mm (Mechanical Surface Detection)
- Electronics: DAE4 Sn669; Calibrated: 2016-07-18
- Phantom: SAM head-body simulator ; Type: Twin SAM V4.0; Serial: ---
- Measurement SW: DASY52, Version 52.8 (8); SEMCAD X Version 14.6.10 (7331)

Flat Phantom, Face (Antenna), d=25mm/809-824MHz/TETRA, Mid CH, Front face/Area Scan (41x151x1):

Interpolated grid: dx=1.500 mm, dy=1.500 mm

[Info: Interpolated medium parameters used for SAR evaluation.](#)

Maximum value of SAR (interpolated) = 0.660 W/kg

Flat Phantom, Face (Antenna), d=25mm/809-824MHz/TETRA, Mid CH, Front face/Zoom Scan (5x5x7)/Cube 0:

Measurement grid: dx=8mm, dy=8mm, dz=5mm

Reference Value = 19.95 V/m; Power Drift = -0.04 dB

Peak SAR (extrapolated) = 0.813 W/kg

SAR(1 g) = 0.604 W/kg; SAR(10 g) = 0.437 W/kg (SAR corrected for target medium)

[Info: Interpolated medium parameters used for SAR evaluation.](#)

Maximum value of SAR (measured) = 0.623 W/kg

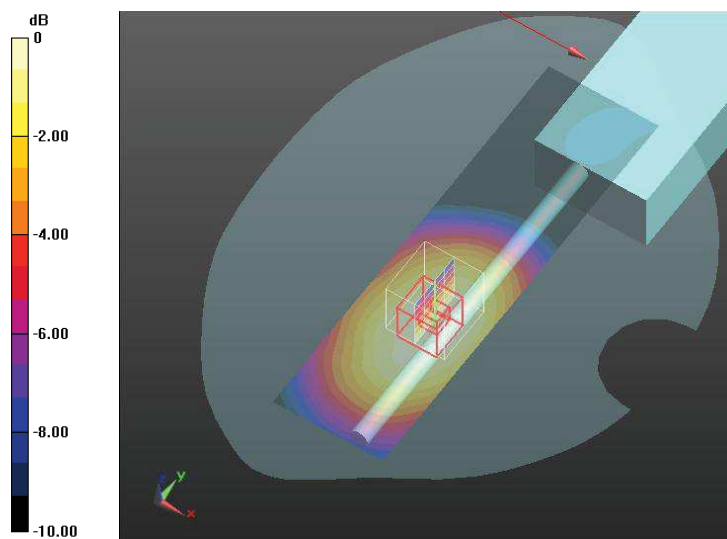

0 dB = 0.623 W/kg = -2.06 dBW/kg

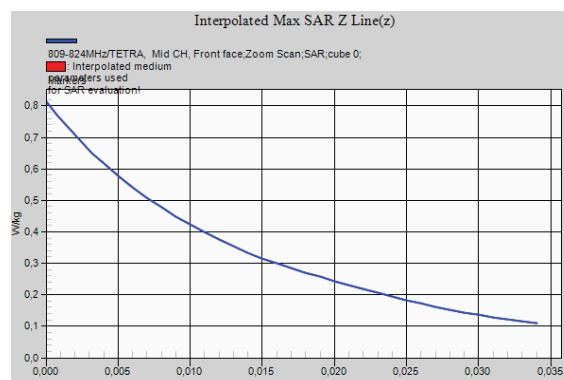

TETRA 799-805 MHz – Body – Carry 2+Audio 1 Accesories – Plot N° 9

Test Laboratory: DEKRA Testing and Certification, S.A.U; Date: 2017-04-10

DUT: HTT500-2+1/2 Ant; Type: PTT Radio; Serial: NYPB-48

Communication System: UID 0, TETRA (0); Frequency: 816.5 MHz; Duty Cycle: 1:4.00037

Medium parameters used (interpolated): $f = 816.5 \text{ MHz}$; $\sigma = 0.99 \text{ S/m}$; $\epsilon_r = 53.749$; $\rho = 1000 \text{ kg/m}^3$

Phantom section: Flat Section

DASY5 Configuration:

- Probe: EX3DV4 - SN3687; ConvF(8.59, 8.59, 8.59); Calibrated: 2016-07-26;
- Sensor-Surface: 3mm (Mechanical Surface Detection (Locations From Previous Scan Used)), Sensor-Surface: 4mm (Mechanical Surface Detection)
- Electronics: DAE4 Sn669; Calibrated: 2016-07-18
- Phantom: Flat Phantom ELI4.0; Type: QDOVA001BA; Serial: SN:1060
- Measurement SW: DASY52, Version 52.8 (8); SEMCAD X Version 14.6.10 (7331)

Flat Phantom, Body, d=0mm/809-824MHz/TETRA, Mid CH, Back face, Acc C2+A1/Area Scan (61x231x1):

Interpolated grid: $dx=1.500 \text{ mm}$, $dy=1.500 \text{ mm}$

[Info: Interpolated medium parameters used for SAR evaluation.](#)

Maximum value of SAR (interpolated) = 1.49 W/kg

Flat Phantom, Body, d=0mm/809-824MHz/TETRA, Mid CH, Back face, Acc C2+A1/Zoom Scan (5x5x7)/Cube 0:

Measurement grid: $dx=8\text{mm}$, $dy=8\text{mm}$, $dz=5\text{mm}$

Reference Value = 8.997 V/m; Power Drift = -0.04 dB

Peak SAR (extrapolated) = 1.95 W/kg

SAR(1 g) = 1.31 W/kg; SAR(10 g) = 0.912 W/kg (SAR corrected for target medium)

[Info: Interpolated medium parameters used for SAR evaluation.](#)

Maximum value of SAR (measured) = 1.41 W/kg

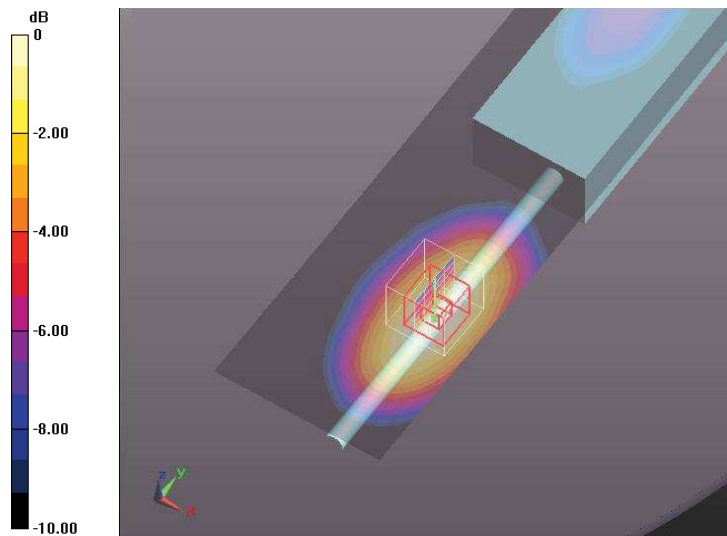

0 dB = 1.41 W/kg = 1.49 dBW/kg

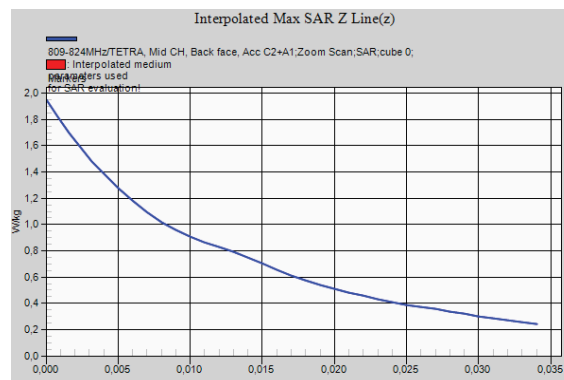

TETRA 854-869 MHz – Left hand side – Tilted position – Plot N° 10

Test Laboratory: DEKRA Testing and Certification, S.A.U; Date: 2017-03-30

DUT: HTT500-2+1/2 Ant; Type: PTT Radio; Serial: NYPB-48

Communication System: UID 0, TETRA (0); Frequency: 861.5 MHz; Duty Cycle: 1:4.00037

Medium parameters used (interpolated): $f = 861.5$ MHz; $\sigma = 0.903$ S/m; $\epsilon_r = 40.63$; $\rho = 1000$ kg/m³

Phantom section: Left Section

DASY5 Configuration:

- Probe: EX3DV4 - SN3687; ConvF(8.25, 8.25, 8.25); Calibrated: 2016-07-26;
- Sensor-Surface: 3mm (Mechanical Surface Detection (Locations From Previous Scan Used)), Sensor-Surface: 4mm (Mechanical Surface Detection)
- Electronics: DAE4 Sn669; Calibrated: 2016-07-18
- Phantom: SAM head-body simulator ; Type: Twin SAM V4.0; Serial: ---
- Measurement SW: DASY52, Version 52.8 (8); SEMCAD X Version 14.6.10 (7331)

Left Hand Side,/854-869MHz/TETRA, Mid CH, Tilt/Area Scan (61x231x1):

Interpolated grid: dx=1.500 mm, dy=1.500 mm

Info: [Interpolated medium parameters used for SAR evaluation.](#)

Maximum value of SAR (interpolated) = 1.27 W/kg

Left Hand Side,/854-869MHz/TETRA, Mid CH, Tilt/Zoom Scan (5x5x7)/Cube 0:

Measurement grid: dx=8mm, dy=8mm, dz=5mm

Reference Value = 23.71 V/m; Power Drift = 0.00 dB

Peak SAR (extrapolated) = 1.71 W/kg

SAR(1 g) = 1.11 W/kg; SAR(10 g) = 0.680 W/kg (SAR corrected for target medium)

Info: [Interpolated medium parameters used for SAR evaluation.](#)

Maximum value of SAR (measured) = 1.17 W/kg

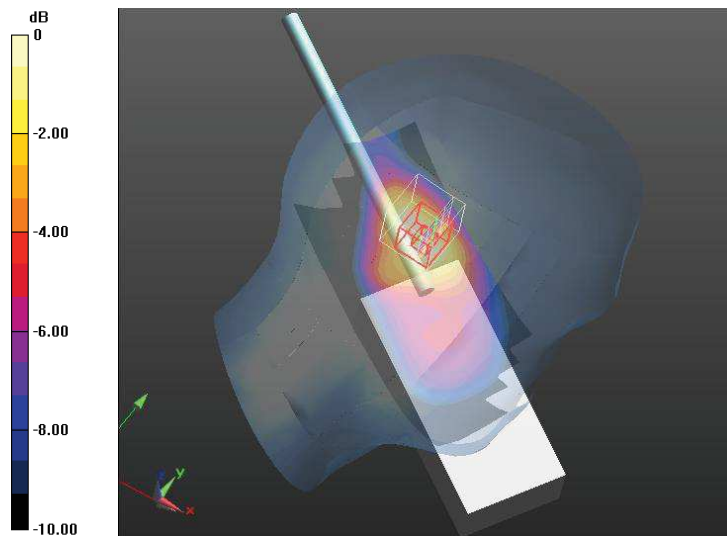

0 dB = 1.17 W/kg = 0.68 dBW/kg

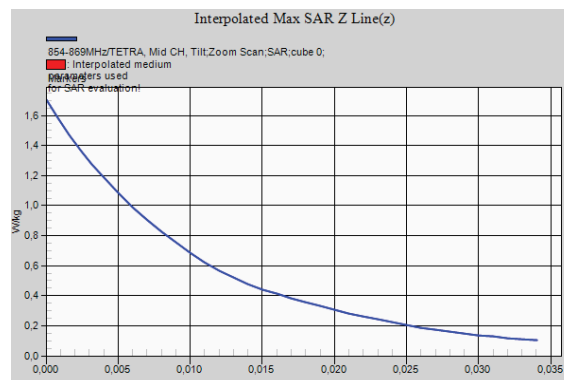

TETRA 854-869 MHz – Front of face (Antenna side) 25 mm – Plot N° 11

Test Laboratory: DEKRA Testing and Certification, S.A.U; Date: 2017-03-30

DUT: HTT500-2+1/2 Ant; Type: PTT Radio; Serial: NYPB-48

Communication System: UID 0, TETRA (0); Frequency: 861.5 MHz; Duty Cycle: 1:4.00037

Medium parameters used (interpolated): $f = 861.5$ MHz; $\sigma = 0.903$ S/m; $\epsilon_r = 40.63$; $\rho = 1000$ kg/m³

Phantom section: Flat Section

DASY5 Configuration:

- Probe: EX3DV4 - SN3687; ConvF(8.25, 8.25, 8.25); Calibrated: 2016-07-26;
- Sensor-Surface: 3mm (Mechanical Surface Detection), Sensor-Surface: 4mm (Mechanical Surface Detection)
- Electronics: DAE4 Sn669; Calibrated: 2016-07-18
- Phantom: SAM head-body simulator ; Type: Twin SAM V4.0; Serial: ---
- Measurement SW: DASY52, Version 52.8 (8); SEMCAD X Version 14.6.10 (7331)

Flat Phantom, Face (Antenna), d=25mm/854-869MHz/TETRA, Mid CH, Front face/Area Scan (41x151x1):

Interpolated grid: dx=1.500 mm, dy=1.500 mm

Info: [Interpolated medium parameters used for SAR evaluation.](#)

Maximum value of SAR (interpolated) = 0.499 W/kg

Flat Phantom, Face (Antenna), d=25mm/854-869MHz/TETRA, Mid CH, Front face/Zoom Scan (5x5x7)/Cube 0:

Measurement grid: dx=8mm, dy=8mm, dz=5mm

Reference Value = 14.73 V/m; Power Drift = 0.10 dB

Peak SAR (extrapolated) = 0.603 W/kg

SAR(1 g) = 0.453 W/kg; SAR(10 g) = 0.327 W/kg (SAR corrected for target medium)

Info: [Interpolated medium parameters used for SAR evaluation.](#)

Maximum value of SAR (measured) = 0.484 W/kg

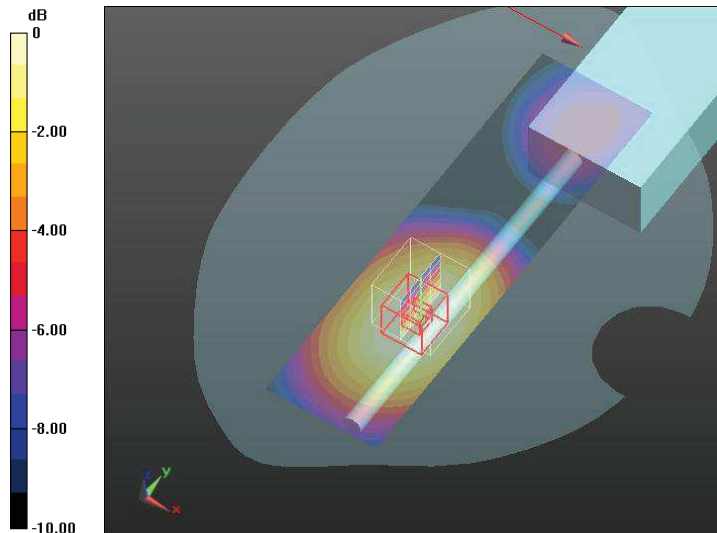

0 dB = 0.484 W/kg = -3.15 dBW/kg

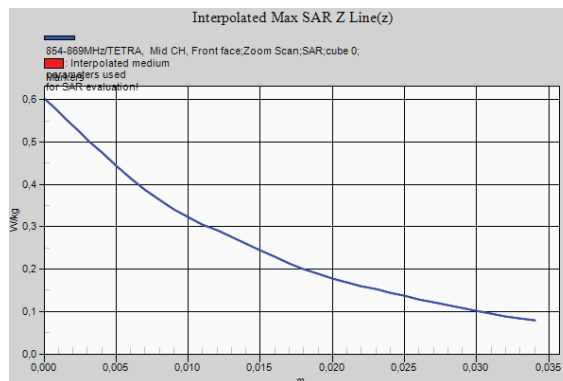

TETRA 854-869 MHz – Body – Carry 2+Audio 1 Accesories – Plot N° 12

Test Laboratory: DEKRA Testing and Certification, S.A.U; Date: 2017-04-11

DUT: HTT500-2+1/2 Ant; Type: PTT Radio; Serial: NYPB-48

Communication System: UID 0, TETRA (0); Frequency: 861.5 MHz; Duty Cycle: 1:4.00037

Medium parameters used (interpolated): $f = 861.5$ MHz; $\sigma = 1.04$ S/m; $\epsilon_r = 53.185$; $\rho = 1000$ kg/m³

Phantom section: Flat Section

DASY5 Configuration:

- Probe: EX3DV4 - SN3687; ConvF(8.49, 8.49, 8.49); Calibrated: 2016-07-26;
- Sensor-Surface: 3mm (Mechanical Surface Detection (Locations From Previous Scan Used)), Sensor-Surface: 4mm (Mechanical Surface Detection)
- Electronics: DAE4 Sn669; Calibrated: 2016-07-18
- Phantom: Flat Phantom ELI4.0; Type: QDOVA001BA; Serial: SN:1060
- Measurement SW: DASY52, Version 52.8 (8); SEMCAD X Version 14.6.10 (7331)

Flat Phantom, Body, d=0mm/854-869MHz/TETRA, Mid CH, Back face, Acc C2+A1/Area Scan (61x231x1):

Interpolated grid: dx=1.500 mm, dy=1.500 mm

[Info: Interpolated medium parameters used for SAR evaluation.](#)

Maximum value of SAR (interpolated) = 1.09 W/kg

Flat Phantom, Body, d=0mm/854-869MHz/TETRA, Mid CH, Back face, Acc C2+A1/Zoom Scan (5x5x7)/Cube 0:

Measurement grid: dx=8mm, dy=8mm, dz=5mm

Reference Value = 11.01 V/m; Power Drift = 0.27 dB

Peak SAR (extrapolated) = 1.42 W/kg

SAR(1 g) = 1.01 W/kg; SAR(10 g) = 0.698 W/kg (SAR corrected for target medium)

[Info: Interpolated medium parameters used for SAR evaluation.](#)

Maximum value of SAR (measured) = 1.10 W/kg

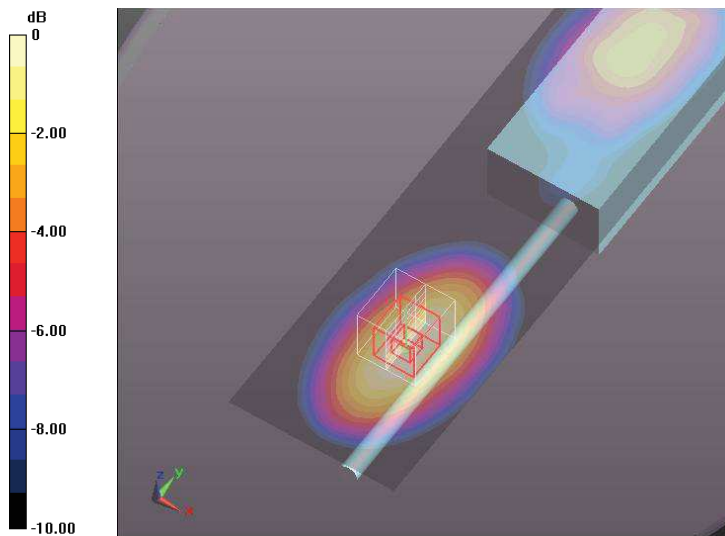

0 dB = 1.10 W/kg = 0.41 dBW/kg

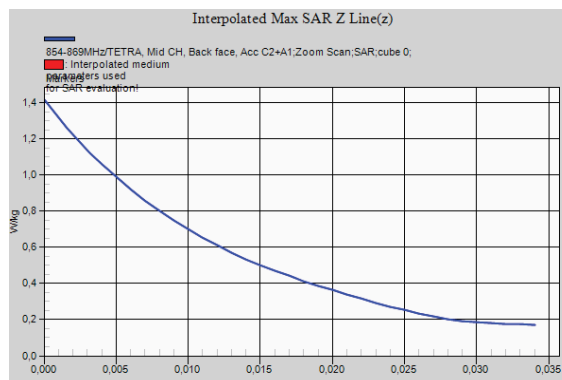

TI D-LMR 769-775 MHz – Left hand side – Tilted position – Plot N° 13

Test Laboratory: DEKRA Testing and Certification, S.A.U; Date: 2017-04-03

DUT: HTT500-2+1/2 Ant; Type: PTT Radio; Serial: NYPB-48

Communication System: UID 0, TI D-LMR (0); Frequency: 772.013 MHz; Duty Cycle: 1:4.30031

Medium parameters used (interpolated): $f = 772.013$ MHz; $\sigma = 0.904$ S/m; $\epsilon_r = 42.532$; $\rho = 1000$ kg/m³

Phantom section: Left Section

DASY5 Configuration:

- Probe: EX3DV4 - SN3687; ConvF(8.82, 8.82, 8.82); Calibrated: 2016-07-26;
- Sensor-Surface: 3mm (Mechanical Surface Detection (Locations From Previous Scan Used)), Sensor-Surface: 4mm (Mechanical Surface Detection)
- Electronics: DAE4 Sn669; Calibrated: 2016-07-18
- Phantom: SAM head-body simulator ; Type: Twin SAM V4.0; Serial: ---
- Measurement SW: DASY52, Version 52.8 (8); SEMCAD X Version 14.6.10 (7331)

Left Hand Side/769-775MHz/TI D-LMR, Mid CH, Tilt/Area Scan (61x231x1):

Interpolated grid: dx=1.500 mm, dy=1.500 mm

[Info: Interpolated medium parameters used for SAR evaluation.](#)

Maximum value of SAR (interpolated) = 1.00 W/kg

Left Hand Side/769-775MHz/TI D-LMR, Mid CH, Tilt/Zoom Scan (5x5x7)/Cube 0:

Measurement grid: dx=8mm, dy=8mm, dz=5mm

Reference Value = 21.76 V/m; Power Drift = 0.03 dB

Peak SAR (extrapolated) = 1.44 W/kg

SAR(1 g) = 0.857 W/kg; SAR(10 g) = 0.527 W/kg (SAR corrected for target medium)

[Info: Interpolated medium parameters used for SAR evaluation.](#)

Maximum value of SAR (measured) = 0.926 W/kg

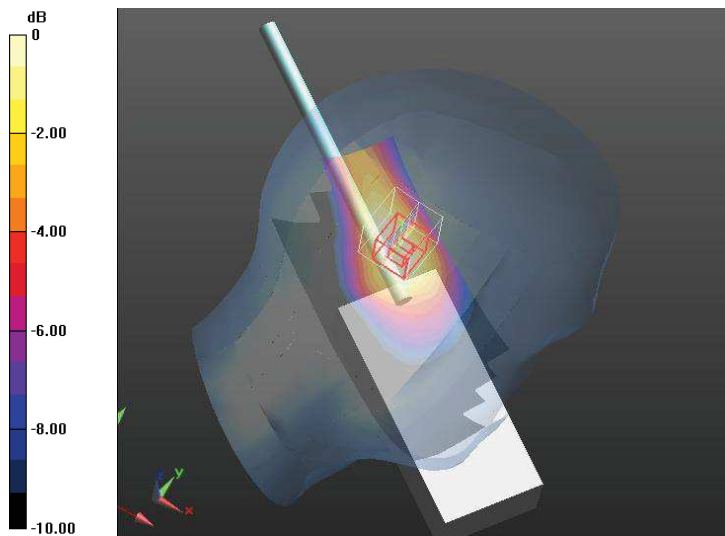

0 dB = 0.926 W/kg = -0.33 dBW/kg

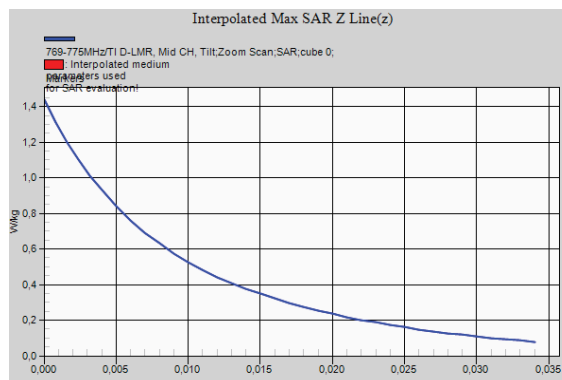

TI D-LMR 769-775 MHz – Front of face (Antenna side) 25 mm – Plot N° 14

Test Laboratory: DEKRA Testing and Certification, S.A.U; Date: 2017-04-04

DUT: HTT500-2+1/2 Ant; Type: PTT Radio; Serial: NYPB-48

Communication System: UID 0, TI D-LMR (0); Frequency: 772.013 MHz; Duty Cycle: 1:4.30031

Medium parameters used (interpolated): $f = 772.013$ MHz; $\sigma = 0.904$ S/m; $\epsilon_r = 42.532$; $\rho = 1000$ kg/m³

Phantom section: Flat Section

DASY5 Configuration:

- Probe: EX3DV4 - SN3687; ConvF(8.82, 8.82, 8.82); Calibrated: 2016-07-26;
- Sensor-Surface: 3mm (Mechanical Surface Detection (Locations From Previous Scan Used)), Sensor-Surface: 4mm (Mechanical Surface Detection)
- Electronics: DAE4 Sn669; Calibrated: 2016-07-18
- Phantom: SAM head-body simulator ; Type: Twin SAM V4.0; Serial: ---
- Measurement SW: DASY52, Version 52.8 (8); SEMCAD X Version 14.6.10 (7331)

Flat Phantom, Face, d=25mm, Antenna side/769-775MHz/TI D-LMR, Mid CH, Front face/Area Scan (51x151x1):

Interpolated grid: dx=1.500 mm, dy=1.500 mm

[Info: Interpolated medium parameters used for SAR evaluation.](#)

Maximum value of SAR (interpolated) = 0.594 W/kg

Flat Phantom, Face, d=25mm, Antenna side/769-775MHz/TI D-LMR, Mid CH, Front face/Zoom Scan (5x5x7)/Cube 0:

Measurement grid: dx=8mm, dy=8mm, dz=5mm

Reference Value = 22.28 V/m; Power Drift = -0.16 dB

Peak SAR (extrapolated) = 0.756 W/kg

SAR(1 g) = 0.530 W/kg; SAR(10 g) = 0.379 W/kg (SAR corrected for target medium)

[Info: Interpolated medium parameters used for SAR evaluation.](#)

Maximum value of SAR (measured) = 0.564 W/kg

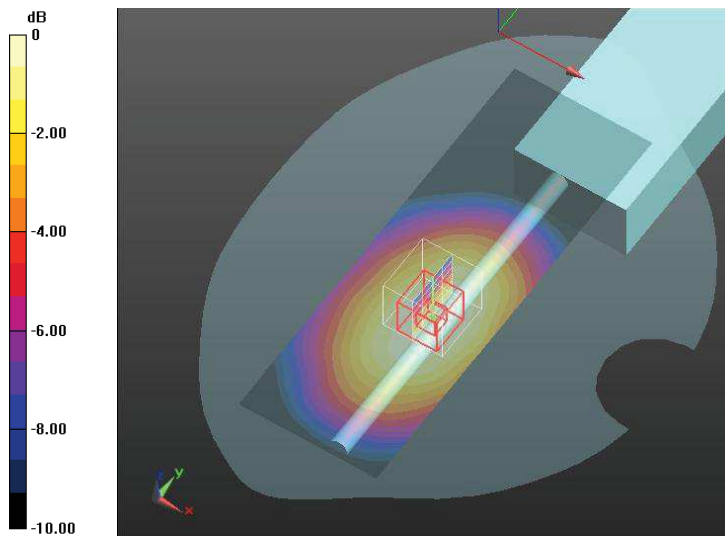

0 dB = 0.564 W/kg = -2.49 dBW/kg

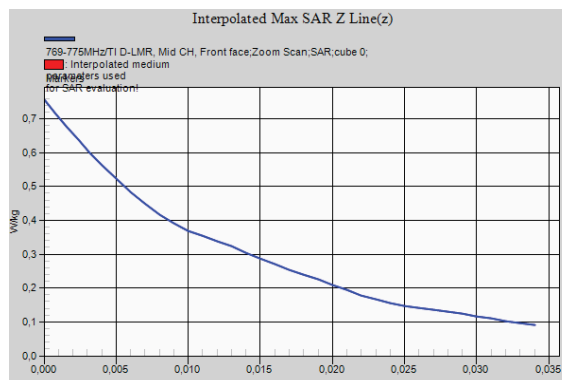

TI D-LMR 769-775 MHz – Body – Carry 2+Audio 1 Accessories – Plot N° 15

Test Laboratory: DEKRA Testing and Certification, S.A.U; Date: 2017-04-17

DUT: HTT500-2+1/2 Ant; Type: PTT Radio; Serial: NYPB-48

Communication System: UID 0, TI D-LMR (0); Frequency: 772.013 MHz; Duty Cycle: 1:4.30031

Medium parameters used (interpolated): $f = 772.013$ MHz; $\sigma = 0.994$ S/m; $\epsilon_r = 55.764$; $\rho = 1000$ kg/m³

Phantom section: Flat Section

DASY5 Configuration:

- Probe: EX3DV4 - SN3687; ConvF(8.61, 8.61, 8.61); Calibrated: 2016-07-26;
- Sensor-Surface: 3mm (Mechanical Surface Detection (Locations From Previous Scan Used)), Sensor-Surface: 4mm (Mechanical Surface Detection)
- Electronics: DAE4 Sn669; Calibrated: 2016-07-18
- Phantom: Flat Phantom ELI4.0; Type: QDOVA001BA; Serial: SN:1060
- Measurement SW: DASY52, Version 52.8 (8); SEMCAD X Version 14.6.10 (7331)

Flat Phantom, Body, d=0mm,/769-775MHz/TI D-LMR, Mid CH, Back face, Acc C2+A1/Area Scan (61x231x1):

Interpolated grid: dx=1.500 mm, dy=1.500 mm

[Info: Interpolated medium parameters used for SAR evaluation.](#)

Maximum value of SAR (interpolated) = 1.39 W/kg

Flat Phantom, Body, d=0mm,/769-775MHz/TI D-LMR, Mid CH, Back face, Acc C2+A1/Zoom Scan (5x5x7)/Cube 0:

Measurement grid: dx=8mm, dy=8mm, dz=5mm

Reference Value = 9.768 V/m; Power Drift = 0.07 dB

Peak SAR (extrapolated) = 1.77 W/kg

SAR(1 g) = 1.26 W/kg; SAR(10 g) = 0.874 W/kg (SAR corrected for target medium)

[Info: Interpolated medium parameters used for SAR evaluation.](#)

Maximum value of SAR (measured) = 1.36 W/kg

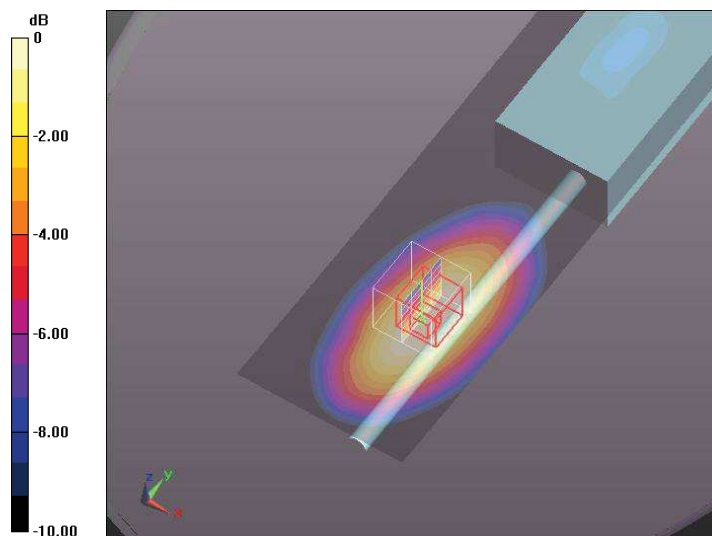

0 dB = 1.36 W/kg = 1.34 dBW/kg

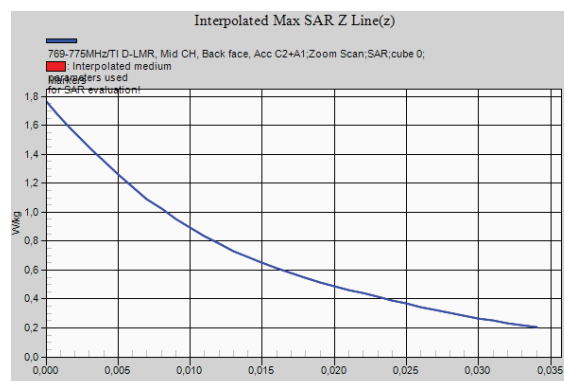

TI D-LMR 799-805 MHz – Left hand side – Tilted position – Plot N° 16

Test Laboratory: DEKRA Testing and Certification, S.A.U; Date: 2017-04-03

DUT: HTT500-2+1/2 Ant; Type: PTT Radio; Serial: NYPB-48

Communication System: UID 0, TI D-LMR (0); Frequency: 802.013 MHz; Duty Cycle: 1:4.30031

Medium parameters used (interpolated): $f = 802.013$ MHz; $\sigma = 0.934$ S/m; $\epsilon_r = 42.154$; $\rho = 1000$ kg/m³

Phantom section: Left Section

DASY5 Configuration:

- Probe: EX3DV4 - SN3687; ConvF(8.82, 8.82, 8.82); Calibrated: 2016-07-26;

- Sensor-Surface: 3mm (Mechanical Surface Detection (Locations From Previous Scan Used)), Sensor-Surface: 4mm (Mechanical Surface Detection)

- Electronics: DAE4 Sn669; Calibrated: 2016-07-18

- Phantom: SAM head-body simulator ; Type: Twin SAM V4.0; Serial: ---

- Measurement SW: DASY52, Version 52.8 (8); SEMCAD X Version 14.6.10 (7331)

Left Hand Side/799-805MHz/TI D-LMR, Mid CH, Tilt/Area Scan (61x231x1):

Interpolated grid: dx=1.500 mm, dy=1.500 mm

[Info: Interpolated medium parameters used for SAR evaluation.](#)

Maximum value of SAR (interpolated) = 1.21 W/kg

Left Hand Side/799-805MHz/TI D-LMR, Mid CH, Tilt/Zoom Scan (5x5x7)/Cube 0:

Measurement grid: dx=8mm, dy=8mm, dz=5mm

Reference Value = 24.84 V/m; Power Drift = 0.01 dB

Peak SAR (extrapolated) = 1.51 W/kg

SAR(1 g) = 1 W/kg; SAR(10 g) = 0.626 W/kg (SAR corrected for target medium)

[Info: Interpolated medium parameters used for SAR evaluation.](#)

Maximum value of SAR (measured) = 1.06 W/kg

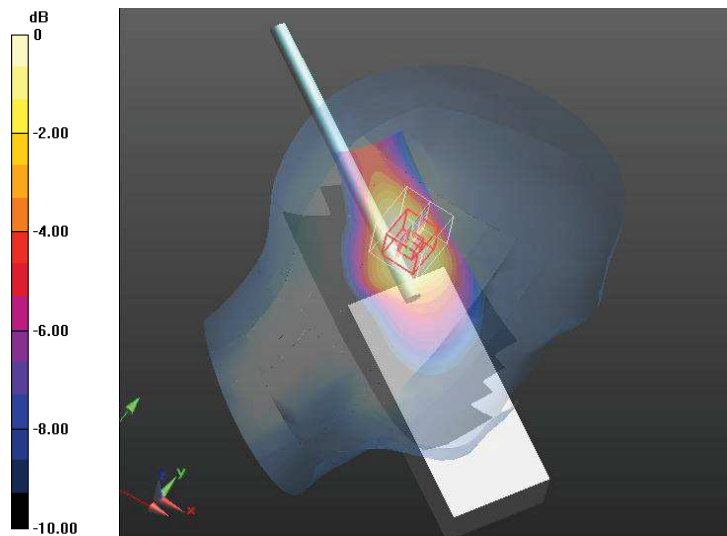

0 dB = 1.06 W/kg = 0.25 dBW/kg

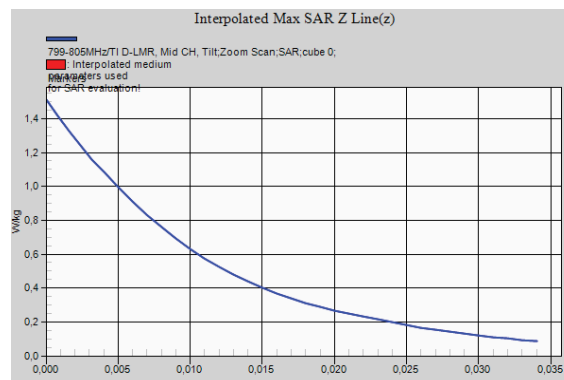

TI D-LMR 799-805 MHz – Front of face (Antenna side) 25 mm – Plot N° 17

Test Laboratory: DEKRA Testing and Certification, S.A.U; Date: 2017-04-04

DUT: HTT500-2+1/2 Ant; Type: PTT Radio; Serial: NYPB-48

Communication System: UID 0, TI D-LMR (0); Frequency: 802.013 MHz; Duty Cycle: 1:4.30031
 Medium parameters used (interpolated): $f = 802.013$ MHz; $\sigma = 0.934$ S/m; $\epsilon_r = 42.154$; $\rho = 1000$ kg/m³
 Phantom section: Flat Section

DASY5 Configuration:

- Probe: EX3DV4 - SN3687; ConvF(8.82, 8.82, 8.82); Calibrated: 2016-07-26;
- Sensor-Surface: 3mm (Mechanical Surface Detection (Locations From Previous Scan Used)), Sensor-Surface: 4mm (Mechanical Surface Detection)
- Electronics: DAE4 Sn669; Calibrated: 2016-07-18
- Phantom: SAM head-body simulator ; Type: Twin SAM V4.0; Serial: ---
- Measurement SW: DASY52, Version 52.8 (8); SEMCAD X Version 14.6.10 (7331)

Flat Phantom, Face, d=25mm, Antenna side/799-805MHz/TI D-LMR, Mid CH, Front face/Area Scan (51x151x1):

Interpolated grid: dx=1.500 mm, dy=1.500 mm

Info: [Interpolated medium parameters used for SAR evaluation.](#)

Maximum value of SAR (interpolated) = 0.739 W/kg

Flat Phantom, Face, d=25mm, Antenna side/799-805MHz/TI D-LMR, Mid CH, Front face/Zoom Scan (5x5x7)/Cube 0:

Measurement grid: dx=8mm, dy=8mm, dz=5mm

Reference Value = 23.43 V/m; Power Drift = -0.05 dB

Peak SAR (extrapolated) = 0.979 W/kg

SAR(1 g) = 0.654 W/kg; SAR(10 g) = 0.464 W/kg (SAR corrected for target medium)

Info: [Interpolated medium parameters used for SAR evaluation.](#)

Maximum value of SAR (measured) = 0.692 W/kg

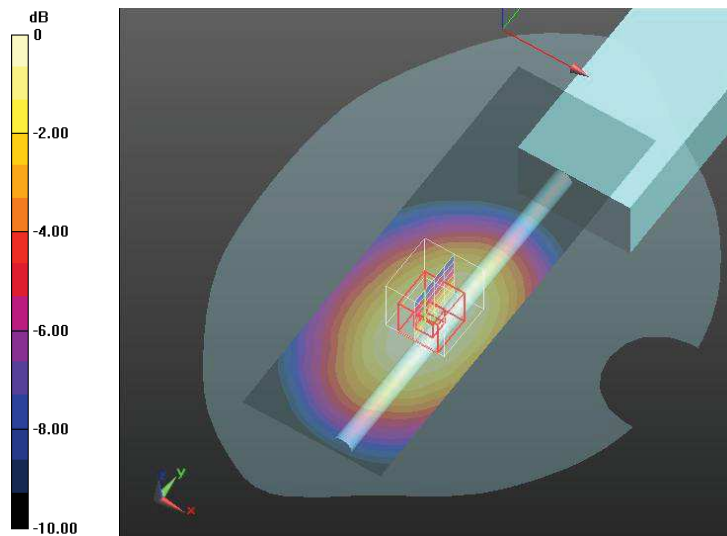

0 dB = 0.692 W/kg = -1.60 dBW/kg

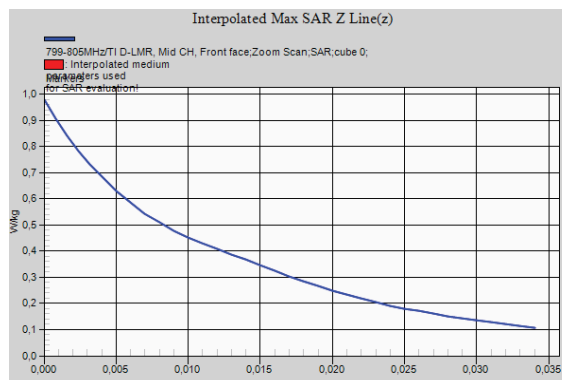

TI D-LMR 799-805 MHz – Body – Carry 2+Audio 1 Accessories – Plot N° 18

Test Laboratory: DEKRA Testing and Certification, S.A.U; Date: 2017-04-18

DUT: HTT500-2+1/2 Ant; Type: PTT Radio; Serial: NYPB-48

Communication System: UID 0, TI D-LMR (0); Frequency: 802.013 MHz; Duty Cycle: 1:4.30031
 Medium parameters used (interpolated): $f = 802.013 \text{ MHz}$; $\sigma = 1.01 \text{ S/m}$; $\epsilon_r = 55.394$; $\rho = 1000 \text{ kg/m}^3$

Phantom section: Flat Section

DASY5 Configuration:

- Probe: EX3DV4 - SN3687; ConvF(8.61, 8.61, 8.61); Calibrated: 2016-07-26;
- Sensor-Surface: 3mm (Mechanical Surface Detection (Locations From Previous Scan Used)), Sensor-Surface: 4mm (Mechanical Surface Detection)
- Electronics: DAE4 Sn669; Calibrated: 2016-07-18
- Phantom: Flat Phantom ELI4.0; Type: QDOVA001BA; Serial: SN:1060
- Measurement SW: DASY52, Version 52.8 (8); SEMCAD X Version 14.6.10 (7331)

Flat Phantom, Body, d=0mm,/799-805MHz/TI D-LMR, Mid CH, Back face, Acc C2+A1/Area Scan (61x231x1):

Interpolated grid: dx=1.500 mm, dy=1.500 mm

[Info: Interpolated medium parameters used for SAR evaluation.](#)

Maximum value of SAR (interpolated) = 1.73 W/kg

Flat Phantom, Body, d=0mm,/799-805MHz/TI D-LMR, Mid CH, Back face, Acc C2+A1/Zoom Scan (5x6x7)/Cube 0:

Measurement grid: dx=8mm, dy=8mm, dz=5mm

Reference Value = 10.51 V/m; Power Drift = -0.01 dB

Peak SAR (extrapolated) = 2.31 W/kg

SAR(1 g) = 1.53 W/kg; SAR(10 g) = 1.04 W/kg (SAR corrected for target medium)

[Info: Interpolated medium parameters used for SAR evaluation.](#)

Maximum value of SAR (measured) = 1.66 W/kg

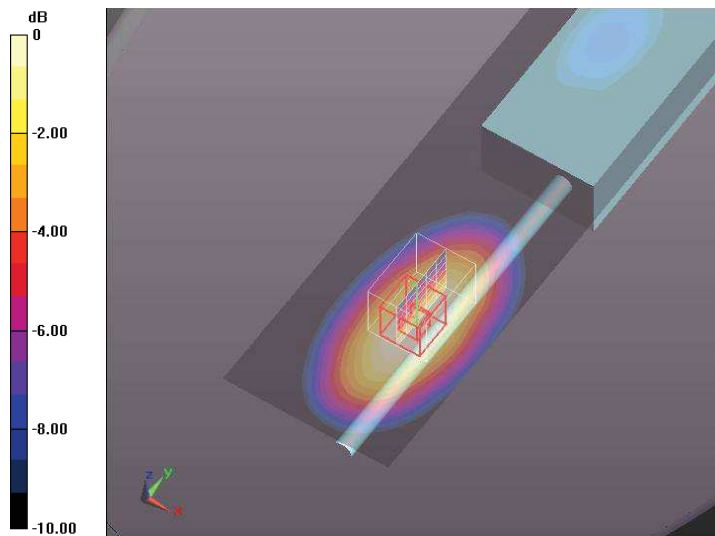

0 dB = 1.66 W/kg = 2.20 dBW/kg

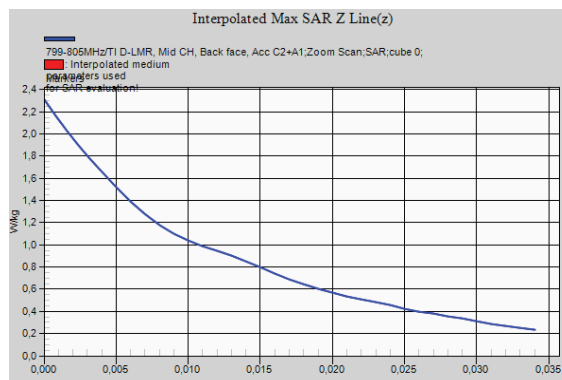

TI D-LMR 809-824 MHz – Left hand side – Tilted position – Plot N° 19

Test Laboratory: DEKRA Testing and Certification, S.A.U; Date: 2017-03-29

DUT: HTT500-2+1/2 Ant; Type: PTT Radio; Serial: NYPB-48

Communication System: UID 0, TI D-LMR (0); Frequency: 816.5 MHz; Duty Cycle: 1:4.30031

Medium parameters used (interpolated): $f = 816.5 \text{ MHz}$; $\sigma = 0.863 \text{ S/m}$; $\epsilon_r = 41.303$; $\rho = 1000 \text{ kg/m}^3$

Phantom section: Left Section

DASY5 Configuration:

- Probe: EX3DV4 - SN3687; ConvF(8.61, 8.61, 8.61); Calibrated: 2016-07-26;
- Sensor-Surface: 3mm (Mechanical Surface Detection), Sensor-Surface: 4mm (Mechanical Surface Detection)
- Electronics: DAE4 Sn669; Calibrated: 2016-07-18
- Phantom: SAM head-body simulator ; Type: Twin SAM V4.0; Serial: ---
- Measurement SW: DASY52, Version 52.8 (8); SEMCAD X Version 14.6.10 (7331)

Left Hand Side,/809-824MHz/TI D-LMR, Mid CH, Tilt/Area Scan (61x231x1):

Interpolated grid: $dx=1.500 \text{ mm}$, $dy=1.500 \text{ mm}$

Info: [Interpolated medium parameters used for SAR evaluation.](#)

Maximum value of SAR (interpolated) = 1.10 W/kg

Left Hand Side,/809-824MHz/TI D-LMR, Mid CH, Tilt/Zoom Scan (5x5x7)/Cube 0:

Measurement grid: $dx=8\text{mm}$, $dy=8\text{mm}$, $dz=5\text{mm}$

Reference Value = 25.33 V/m; Power Drift = 0.04 dB

Peak SAR (extrapolated) = 1.53 W/kg

SAR(1 g) = 0.992 W/kg; SAR(10 g) = 0.616 W/kg (SAR corrected for target medium)

Info: [Interpolated medium parameters used for SAR evaluation.](#)

Maximum value of SAR (measured) = 1.04 W/kg

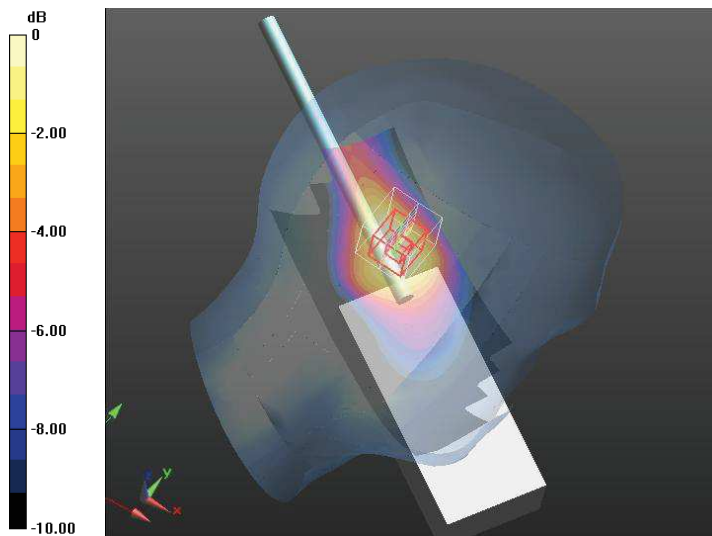

0 dB = 1.04 W/kg = 0.17 dBW/kg

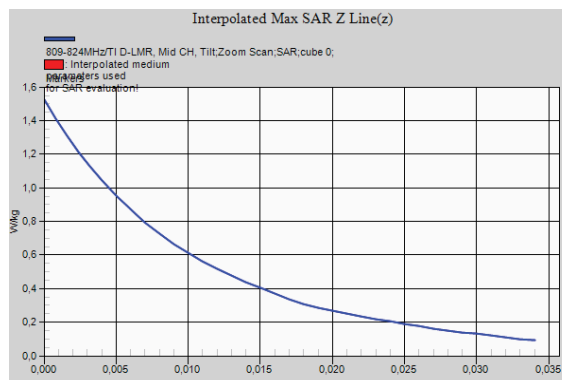

TI D-LMR 809-824 MHz – Front of face (Antenna side) 25 mm – Plot N° 20

Test Laboratory: DEKRA Testing and Certification, S.A.U; Date: 2017-03-30

DUT: HTT500-2+1/2 Ant; Type: PTT Radio; Serial: NYPB-48

Communication System: UID 0, TI D-LMR (0); Frequency: 816.5 MHz; Duty Cycle: 1:4.30031

Medium parameters used (interpolated): $f = 816.5 \text{ MHz}$; $\sigma = 0.863 \text{ S/m}$; $\epsilon_r = 41.303$; $\rho = 1000 \text{ kg/m}^3$

Phantom section: Flat Section

DASY5 Configuration:

- Probe: EX3DV4 - SN3687; ConvF(8.61, 8.61, 8.61); Calibrated: 2016-07-26;
- Sensor-Surface: 3mm (Mechanical Surface Detection), Sensor-Surface: 4mm (Mechanical Surface Detection)
- Electronics: DAE4 Sn669; Calibrated: 2016-07-18
- Phantom: SAM head-body simulator ; Type: Twin SAM V4.0; Serial: ---
- Measurement SW: DASY52, Version 52.8 (8); SEMCAD X Version 14.6.10 (7331)

Flat Phantom, Face (Antenna), d=25mm/809-824MHz/TI D-LMR, Mid CH, Front face/Area Scan (41x151x1):

Interpolated grid: dx=1.500 mm, dy=1.500 mm

[Info: Interpolated medium parameters used for SAR evaluation.](#)

Maximum value of SAR (interpolated) = 0.705 W/kg

Flat Phantom, Face (Antenna), d=25mm/809-824MHz/TI D-LMR, Mid CH, Front face/Zoom Scan (5x5x7)/Cube 0:

Measurement grid: dx=8mm, dy=8mm, dz=5mm

Reference Value = 21.77 V/m; Power Drift = -0.04 dB

Peak SAR (extrapolated) = 0.787 W/kg

SAR(1 g) = 0.640 W/kg; SAR(10 g) = 0.464 W/kg (SAR corrected for target medium)

[Info: Interpolated medium parameters used for SAR evaluation.](#)

Maximum value of SAR (measured) = 0.658 W/kg

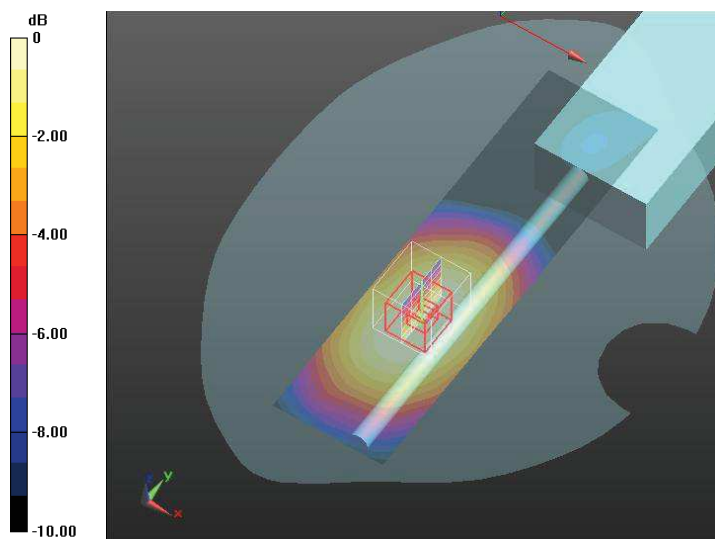

0 dB = 0.658 W/kg = -1.82 dBW/kg

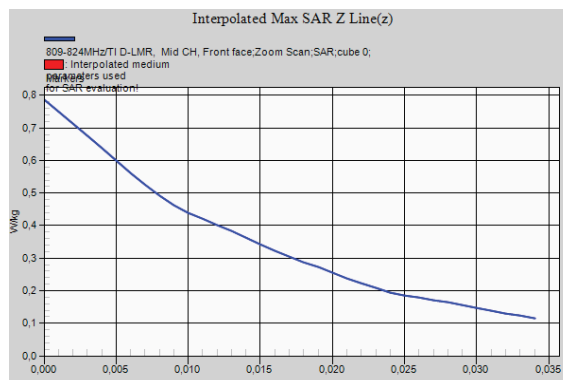

TI D-LMR 809-824 MHz – Body – Carry 2+Audio 1 Accessories – Plot N° 21

Test Laboratory: DEKRA Testing and Certification, S.A.U; Date: 2017-04-11

DUT: HTT500-2+1/2 Ant; Type: PTT Radio; Serial: NYPB-48

Communication System: UID 0, TI D-LMR (0); Frequency: 816.5 MHz; Duty Cycle: 1:4.30031

Medium parameters used (interpolated): $f = 816.5$ MHz; $\sigma = 0.99$ S/m; $\epsilon_r = 53.749$; $\rho = 1000$ kg/m³

Phantom section: Flat Section

DASY5 Configuration:

- Probe: EX3DV4 - SN3687; ConvF(8.59, 8.59, 8.59); Calibrated: 2016-07-26;
- Sensor-Surface: 3mm (Mechanical Surface Detection (Locations From Previous Scan Used)), Sensor-Surface: 4mm (Mechanical Surface Detection)
- Electronics: DAE4 Sn669; Calibrated: 2016-07-18
- Phantom: Flat Phantom ELI4.0; Type: QDOVA001BA; Serial: SN:1060
- Measurement SW: DASY52, Version 52.8 (8); SEMCAD X Version 14.6.10 (7331)

Flat Phantom, Body, d=0mm/809-824MHz/TI D-LMR, Mid CH, Back face, Acc C2+A1/Area Scan (61x231x1):

Interpolated grid: dx=1.500 mm, dy=1.500 mm

Info: [Interpolated medium parameters used for SAR evaluation.](#)

Maximum value of SAR (interpolated) = 1.84 W/kg

Flat Phantom, Body, d=0mm/809-824MHz/TI D-LMR, Mid CH, Back face, Acc C2+A1/Zoom Scan (5x5x7)/Cube 0:

Measurement grid: dx=8mm, dy=8mm, dz=5mm

Reference Value = 12.33 V/m; Power Drift = 0.04 dB

Peak SAR (extrapolated) = 2.42 W/kg

SAR(1 g) = 1.6 W/kg; SAR(10 g) = 1.1 W/kg (SAR corrected for target medium)

Info: [Interpolated medium parameters used for SAR evaluation.](#)

Maximum value of SAR (measured) = 1.77 W/kg

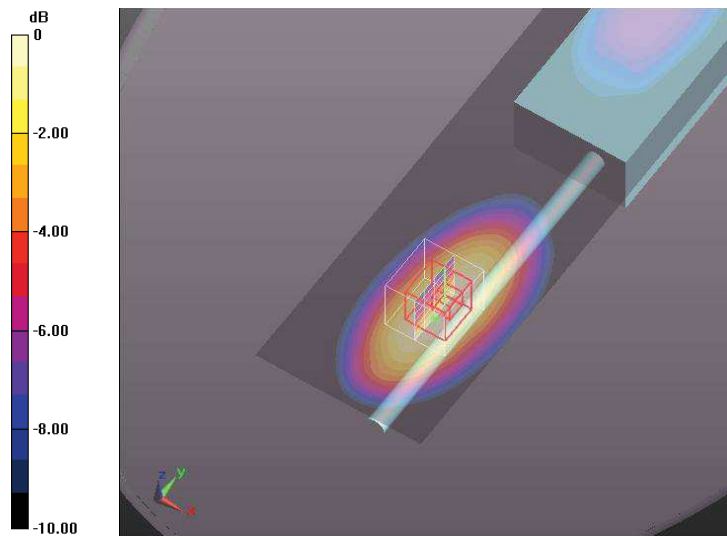

0 dB = 1.77 W/kg = 2.48 dBW/kg

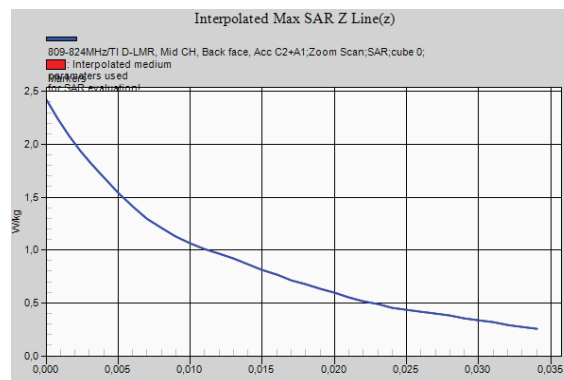

TI D-LMR 854-869 MHz – Left hand side – Tilted position – Plot N° 22

Test Laboratory: DEKRA Testing and Certification, S.A.U; Date: 2017-03-29

DUT: HTT500-2+1/2 Ant; Type: PTT Radio; Serial: NYPB-48

Communication System: UID 0, TI D-LMR (0); Frequency: 861.5 MHz; Duty Cycle: 1:4.30031

Medium parameters used (interpolated): $f = 861.5$ MHz; $\sigma = 0.903$ S/m; $\epsilon_r = 40.63$; $\rho = 1000$ kg/m³

Phantom section: Left Section

DASY5 Configuration:

- Probe: EX3DV4 - SN3687; ConvF(8.25, 8.25, 8.25); Calibrated: 2016-07-26;
- Sensor-Surface: 3mm (Mechanical Surface Detection (Locations From Previous Scan Used)), Sensor-Surface: 4mm (Mechanical Surface Detection)
- Electronics: DAE4 Sn669; Calibrated: 2016-07-18
- Phantom: SAM head-body simulator ; Type: Twin SAM V4.0; Serial: ---
- Measurement SW: DASY52, Version 52.8 (8); SEMCAD X Version 14.6.10 (7331)

Left Hand Side,/854-869MHz/TI D-LMR, Mid CH, Tilt/Area Scan (61x231x1):

Interpolated grid: dx=1.500 mm, dy=1.500 mm

[Info: Interpolated medium parameters used for SAR evaluation.](#)

Maximum value of SAR (interpolated) = 1.53 W/kg

Left Hand Side,/854-869MHz/TI D-LMR, Mid CH, Tilt/Zoom Scan (5x5x7)/Cube 0:

Measurement grid: dx=8mm, dy=8mm, dz=5mm

Reference Value = 28.64 V/m; Power Drift = -0.02 dB

Peak SAR (extrapolated) = 1.98 W/kg

SAR(1 g) = 1.27 W/kg; SAR(10 g) = 0.779 W/kg (SAR corrected for target medium)

[Info: Interpolated medium parameters used for SAR evaluation.](#)

Maximum value of SAR (measured) = 1.39 W/kg

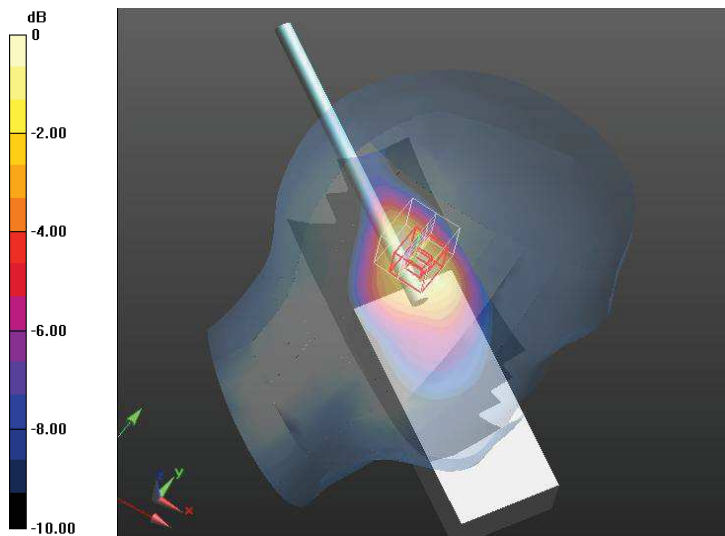

0 dB = 1.39 W/kg = 1.43 dBW/kg

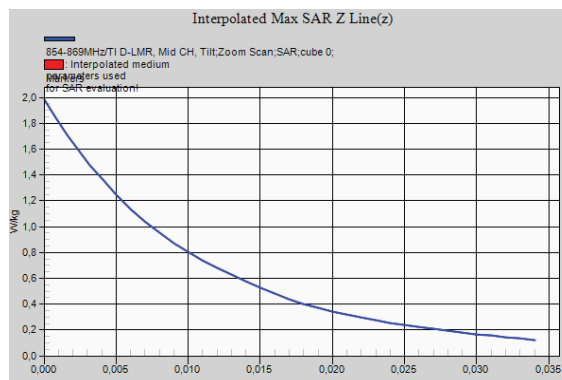

TI D-LMR 854-869 MHz – Front of face (Antenna side) 25 mm – Plot N° 23

Test Laboratory: DEKRA Testing and Certification, S.A.U; Date: 2017-03-30

DUT: HTT500-2+1/2 Ant; Type: PTT Radio; Serial: NYPB-48

Communication System: UID 0, TI D-LMR (0); Frequency: 861.5 MHz; Duty Cycle: 1:4.30031

Medium parameters used (interpolated): $f = 861.5$ MHz; $\sigma = 0.903$ S/m; $\epsilon_r = 40.63$; $\rho = 1000$ kg/m³

Phantom section: Flat Section

DASY5 Configuration:

- Probe: EX3DV4 - SN3687; ConvF(8.25, 8.25, 8.25); Calibrated: 2016-07-26;

- Sensor-Surface: 3mm (Mechanical Surface Detection (Locations From Previous Scan Used)), Sensor-Surface: 4mm (Mechanical Surface Detection)

- Electronics: DAE4 Sn669; Calibrated: 2016-07-18

- Phantom: SAM head-body simulator ; Type: Twin SAM V4.0; Serial: ---

- Measurement SW: DASY52, Version 52.8 (8); SEMCAD X Version 14.6.10 (7331)

Flat Phantom, Face (Antenna), d=25mm/854-869MHz/TI D-LMR, Mid CH, Front face/Area Scan (41x151x1):

Interpolated grid: dx=1.500 mm, dy=1.500 mm

[Info: Interpolated medium parameters used for SAR evaluation.](#)

Maximum value of SAR (interpolated) = 0.460 W/kg

Flat Phantom, Face (Antenna), d=25mm/854-869MHz/TI D-LMR, Mid CH, Front face/Zoom Scan (5x5x7)/Cube 0:

Measurement grid: dx=8mm, dy=8mm, dz=5mm

Reference Value = 15.10 V/m; Power Drift = 0.11 dB

Peak SAR (extrapolated) = 0.515 W/kg

SAR(1 g) = 0.390 W/kg; SAR(10 g) = 0.287 W/kg (SAR corrected for target medium)

[Info: Interpolated medium parameters used for SAR evaluation.](#)

Maximum value of SAR (measured) = 0.407 W/kg

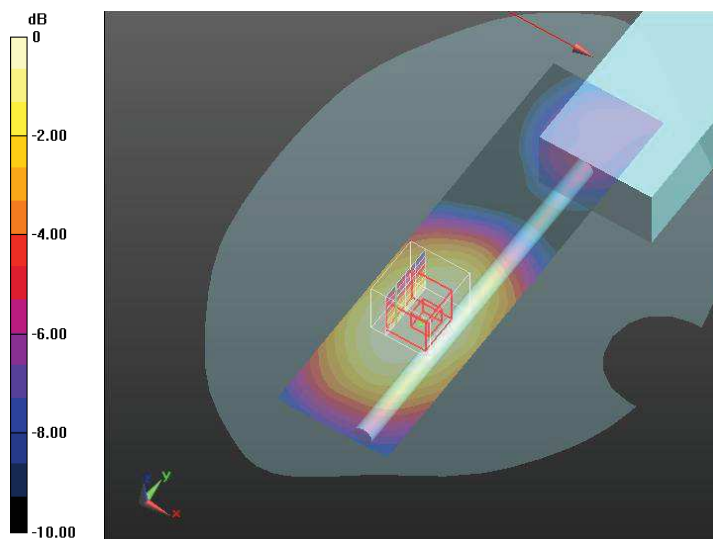

0 dB = 0.407 W/kg = -3.90 dBW/kg

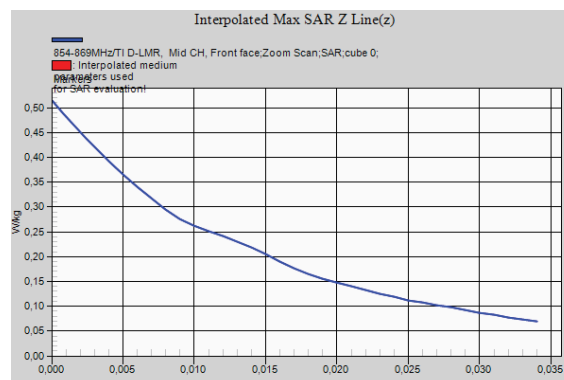

TI D-LMR 854-869 MHz – Body – Carry 2+Audio 1 Accessories – Plot N° 24

Test Laboratory: DEKRA Testing and Certification, S.A.U; Date: 2017-04-11

DUT: HTT500-2+1/2 Ant; Type: PTT Radio; Serial: NYPB-48

Communication System: UID 0, TI D-LMR (0); Frequency: 861.5 MHz; Duty Cycle: 1:4.30031

Medium parameters used (interpolated): $f = 861.5$ MHz; $\sigma = 1.04$ S/m; $\epsilon_r = 53.185$; $\rho = 1000$ kg/m³

Phantom section: Flat Section

DASY5 Configuration:

- Probe: EX3DV4 - SN3687; ConvF(8.49, 8.49, 8.49); Calibrated: 2016-07-26;

- Sensor-Surface: 3mm (Mechanical Surface Detection (Locations From Previous Scan Used)), Sensor-Surface: 4mm (Mechanical Surface Detection)

- Electronics: DAE4 Sn669; Calibrated: 2016-07-18

- Phantom: Flat Phantom ELI4.0; Type: QDOVA001BA; Serial: SN:1060

- Measurement SW: DASY52, Version 52.8 (8); SEMCAD X Version 14.6.10 (7331)

Flat Phantom, Body, d=0mm/854-869MHz/TI D-LMR, Mid CH, Back face, Acc C2+A1/Area Scan (61x231x1):

Interpolated grid: dx=1.500 mm, dy=1.500 mm

[Info: Interpolated medium parameters used for SAR evaluation.](#)

Maximum value of SAR (interpolated) = 1.10 W/kg

Flat Phantom, Body, d=0mm/854-869MHz/TI D-LMR, Mid CH, Back face, Acc C2+A1/Zoom Scan (5x5x7)/Cube 0:

Measurement grid: dx=8mm, dy=8mm, dz=5mm

Reference Value = 11.18 V/m; Power Drift = 0.14 dB

Peak SAR (extrapolated) = 1.43 W/kg

SAR(1 g) = 1.02 W/kg; SAR(10 g) = 0.700 W/kg (SAR corrected for target medium)

[Info: Interpolated medium parameters used for SAR evaluation.](#)

Maximum value of SAR (measured) = 1.10 W/kg

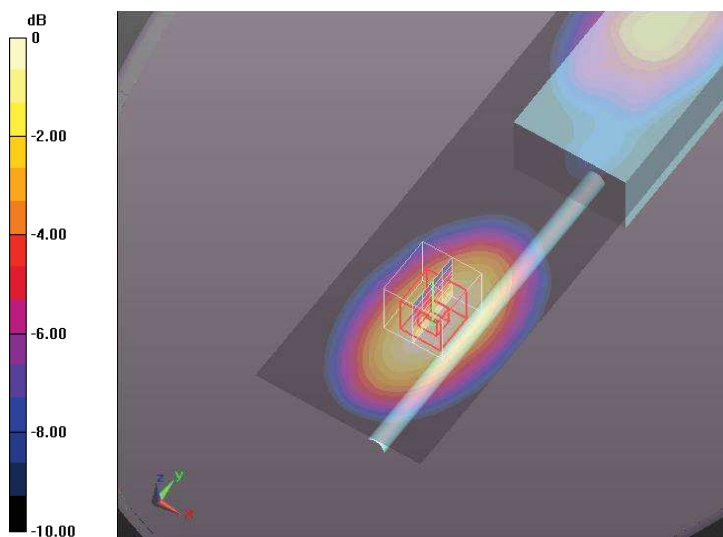

0 dB = 1.10 W/kg = 0.41 dBW/kg

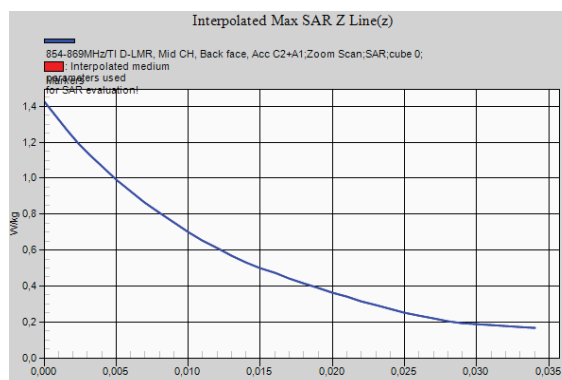

P25 769-775 MHz – Front of face (Antenna side) 25 mm – Plot N° 25

Test Laboratory: DEKRA Testing and Certification, S.A.U; Date: 2017-04-04

DUT: HTT500-2+1/2 Ant; Type: PTT Radio; Serial: NYPB-48

Communication System: UID 0, P25 (0); Frequency: 772.013 MHz; Duty Cycle: 1:1

Medium parameters used (interpolated): $f = 772.013$ MHz; $\sigma = 0.904$ S/m; $\epsilon_r = 42.532$; $\rho = 1000$ kg/m³

Phantom section: Flat Section

DASY5 Configuration:

- Probe: EX3DV4 - SN3687; ConvF(8.82, 8.82, 8.82); Calibrated: 2016-07-26;
- Sensor-Surface: 3mm (Mechanical Surface Detection (Locations From Previous Scan Used)), Sensor-Surface: 4mm (Mechanical Surface Detection)
- Electronics: DAE4 Sn669; Calibrated: 2016-07-18
- Phantom: SAM head-body simulator ; Type: Twin SAM V4.0; Serial: ---
- Measurement SW: DASY52, Version 52.8 (8); SEMCAD X Version 14.6.10 (7331)

Flat Phantom, Face, d=25mm, Antenna side/769-775MHz/P25, Mid CH, Front face/Area Scan (51x151x1):

Interpolated grid: dx=1.500 mm, dy=1.500 mm

[Info: Interpolated medium parameters used for SAR evaluation.](#)

Maximum value of SAR (interpolated) = 3.97 W/kg

Flat Phantom, Face, d=25mm, Antenna side/769-775MHz/P25, Mid CH, Front face/Zoom Scan (5x5x7)/Cube 0:

Measurement grid: dx=8mm, dy=8mm, dz=5mm

Reference Value = 58.31 V/m; Power Drift = -0.09 dB

Peak SAR (extrapolated) = 4.76 W/kg

SAR(1 g) = 3.58 W/kg; SAR(10 g) = 2.58 W/kg (SAR corrected for target medium)

[Info: Interpolated medium parameters used for SAR evaluation.](#)

Maximum value of SAR (measured) = 3.79 W/kg

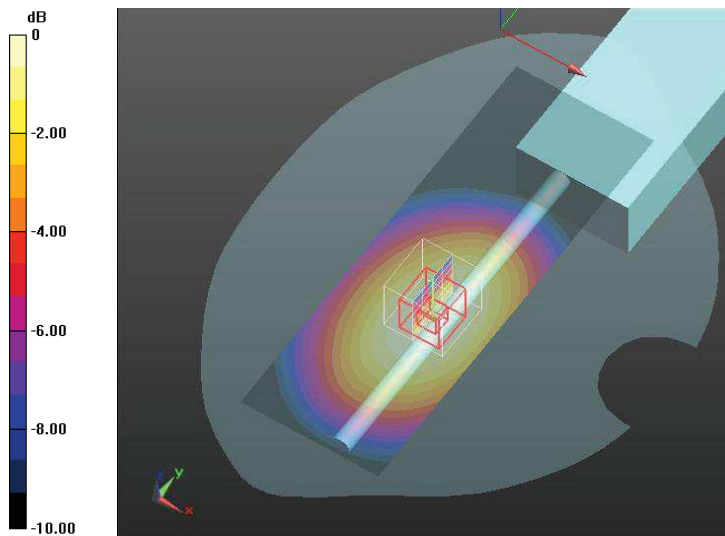

0 dB = 3.79 W/kg = 5.79 dBW/kg

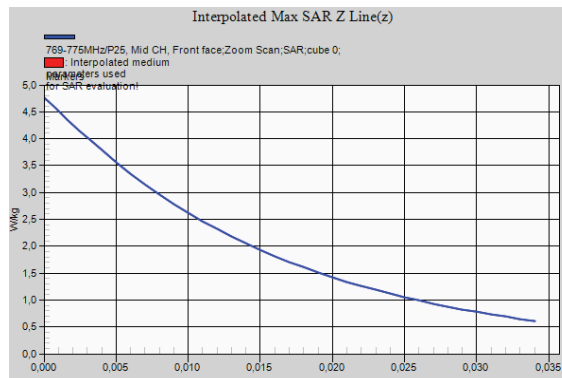

P25 769-775 MHz – Body – Carry 2+Audio 1 Accesories – Plot N° 26

Test Laboratory: DEKRA Testing and Certification, S.A.U; Date: 2017-04-18

DUT: HTT500-2+1/2 Ant; Type: PTT Radio; Serial: NYPB-48

Communication System: UID 0, P25 (0); Frequency: 772.013 MHz; Duty Cycle: 1:1

Medium parameters used (interpolated): $f = 772.013$ MHz; $\sigma = 0.994$ S/m; $\epsilon_r = 55.764$; $\rho = 1000$ kg/m³

Phantom section: Flat Section

DASY5 Configuration:

- Probe: EX3DV4 - SN3687; ConvF(8.61, 8.61, 8.61); Calibrated: 2016-07-26;
- Sensor-Surface: 3mm (Mechanical Surface Detection (Locations From Previous Scan Used)), Sensor-Surface: 4mm (Mechanical Surface Detection)
- Electronics: DAE4 Sn669; Calibrated: 2016-07-18
- Phantom: Flat Phantom ELI4.0; Type: QDOVA001BA; Serial: SN:1060
- Measurement SW: DASY52, Version 52.8 (8); SEMCAD X Version 14.6.10 (7331)

Flat Phantom, Body, d=0mm,/769-775MHz/P25, Mid CH, Back face, Acc C2+A1/Area Scan (61x231x1):

Interpolated grid: dx=1.500 mm, dy=1.500 mm

[Info: Interpolated medium parameters used for SAR evaluation.](#)

Maximum value of SAR (interpolated) = 11.1 W/kg

Flat Phantom, Body, d=0mm,/769-775MHz/P25, Mid CH, Back face, Acc C2+A1/Zoom Scan (5x5x7)/Cube 0:

Measurement grid: dx=8mm, dy=8mm, dz=5mm

Reference Value = 26.09 V/m; Power Drift = -0.08 dB

Peak SAR (extrapolated) = 13.5 W/kg

SAR(1 g) = 9.51 W/kg; SAR(10 g) = 6.48 W/kg (SAR corrected for target medium)

[Info: Interpolated medium parameters used for SAR evaluation.](#)

Maximum value of SAR (measured) = 10.2 W/kg

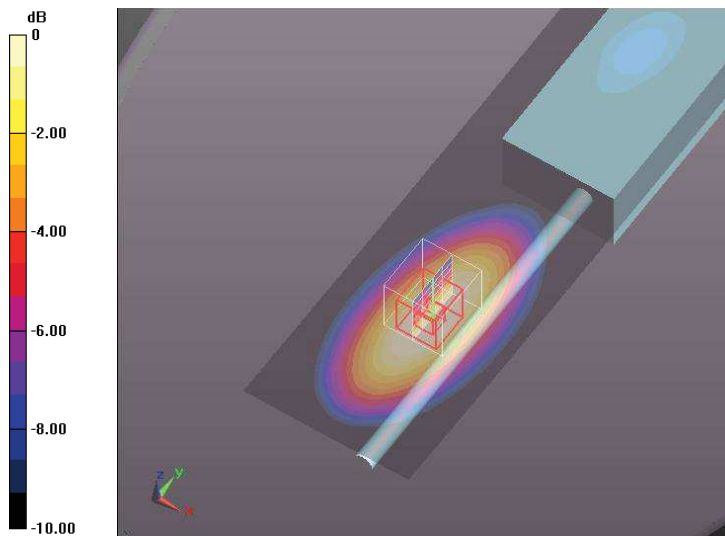

0 dB = 10.2 W/kg = 10.09 dBW/kg

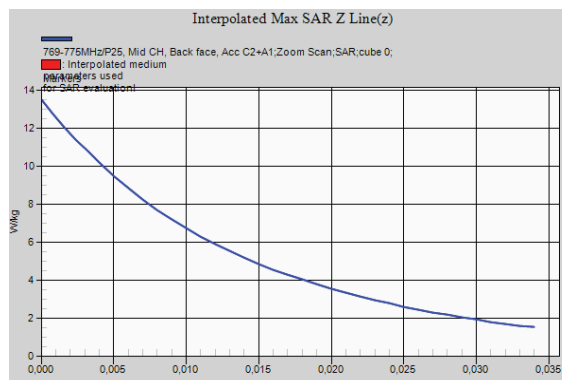

P25 799-805 MHz – Front of face (Antenna side) 25 mm – Plot N° 27

Test Laboratory: DEKRA Testing and Certification, S.A.U; Date: 2017-04-04

DUT: HTT500-2+1/2 Ant; Type: PTT Radio; Serial: NYPB-48

Communication System: UID 0, P25 (0); Frequency: 802.013 MHz; Duty Cycle: 1:1

Medium parameters used (interpolated): $f = 802.013$ MHz; $\sigma = 0.934$ S/m; $\epsilon_r = 42.154$; $\rho = 1000$ kg/m³

Phantom section: Flat Section

DASY5 Configuration:

- Probe: EX3DV4 - SN3687; ConvF(8.82, 8.82, 8.82); Calibrated: 2016-07-26;

- Sensor-Surface: 3mm (Mechanical Surface Detection (Locations From Previous Scan Used)), Sensor-Surface: 4mm (Mechanical Surface Detection)

- Electronics: DAE4 Sn669; Calibrated: 2016-07-18

- Phantom: SAM head-body simulator ; Type: Twin SAM V4.0; Serial: ---

- Measurement SW: DASY52, Version 52.8 (8); SEMCAD X Version 14.6.10 (7331)

Flat Phantom, Face, d=25mm, Antenna side/799-805MHz/P25, Mid CH, Front face/Area Scan (51x151x1):

Interpolated grid: dx=1.500 mm, dy=1.500 mm

[Info: Interpolated medium parameters used for SAR evaluation.](#)

Maximum value of SAR (interpolated) = 4.65 W/kg

Flat Phantom, Face, d=25mm, Antenna side/799-805MHz/P25, Mid CH, Front face/Zoom Scan (5x5x7)/Cube 0:

Measurement grid: dx=8mm, dy=8mm, dz=5mm

Reference Value = 58.91 V/m; Power Drift = -0.14 dB

Peak SAR (extrapolated) = 5.49 W/kg

SAR(1 g) = 4.09 W/kg; SAR(10 g) = 2.92 W/kg (SAR corrected for target medium)

[Info: Interpolated medium parameters used for SAR evaluation.](#)

Maximum value of SAR (measured) = 4.33 W/kg

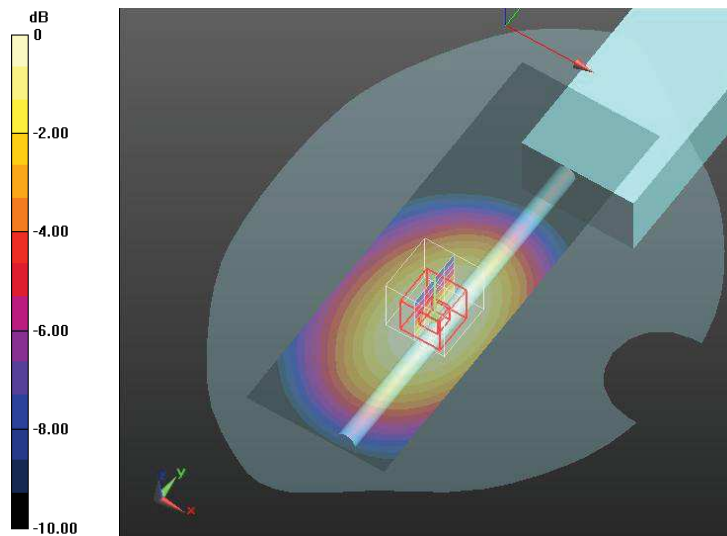

0 dB = 4.33 W/kg = 6.36 dBW/kg

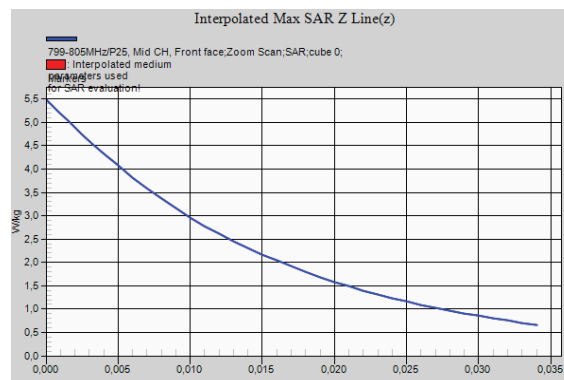

P25 799-805 MHz – Body – Carry 2+Audio 1 Accesories – Plot N° 28

Test Laboratory: DEKRA Testing and Certification, S.A.U; Date: 2017-04-19

DUT: HTT500-2+1/2 Ant; Type: PTT Radio; Serial: NYPB-48

Communication System: UID 0, P25 (0); Frequency: 802.013 MHz; Duty Cycle: 1:1

Medium parameters used (interpolated): $f = 802.013$ MHz; $\sigma = 1.01$ S/m; $\epsilon_r = 55.394$; $\rho = 1000$ kg/m³

Phantom section: Flat Section

DASY5 Configuration:

- Probe: EX3DV4 - SN3687; ConvF(8.61, 8.61, 8.61); Calibrated: 2016-07-26;
- Sensor-Surface: 3mm (Mechanical Surface Detection (Locations From Previous Scan Used)), Sensor-Surface: 4mm (Mechanical Surface Detection)
- Electronics: DAE4 Sn669; Calibrated: 2016-07-18
- Phantom: Flat Phantom ELI4.0; Type: QDOVA001BA; Serial: SN:1060
- Measurement SW: DASY52, Version 52.8 (8); SEMCAD X Version 14.6.10 (7331)

Flat Phantom, Body, d=0mm./799-805MHz/P25, Mid CH, Back face, Acc C2+A1/Area Scan (61x231x1): Interpolated grid: dx=1.500 mm, dy=1.500 mm

[Info: Interpolated medium parameters used for SAR evaluation.](#)

Maximum value of SAR (interpolated) = 12.3 W/kg

Flat Phantom, Body, d=0mm./799-805MHz/P25, Mid CH, Back face, Acc C2+A1/Zoom Scan (5x5x7)/Cube 0:

Measurement grid: dx=8mm, dy=8mm, dz=5mm

Reference Value = 33.46 V/m; Power Drift = 0.02 dB

Peak SAR (extrapolated) = 15.5 W/kg

SAR(1 g) = 10.7 W/kg; SAR(10 g) = 7.19 W/kg (SAR corrected for target medium)

[Info: Interpolated medium parameters used for SAR evaluation.](#)

Maximum value of SAR (measured) = 11.5 W/kg

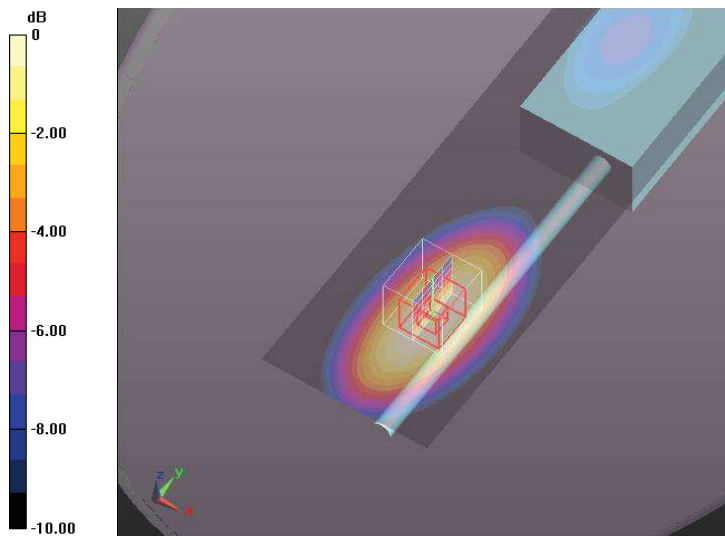

0 dB = 11.5 W/kg = 10.61 dBW/kg

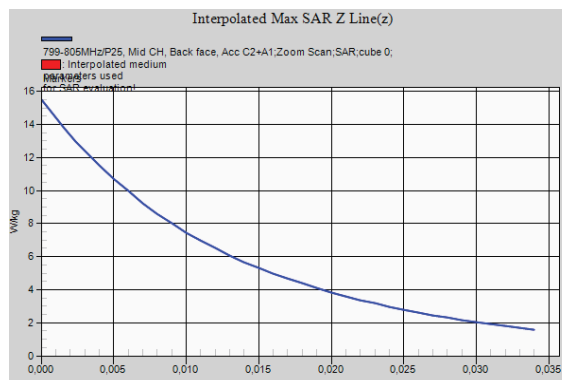

P25 799-805 MHz – Body Variability – Carry 2+Audio 1 Accesories – Plot N° 29

Test Laboratory: DEKRA Testing and Certification, S.A.U; Date: 2017-04-19

DUT: HTT500-2+1/2 Ant; Type: PTT Radio; Serial: NYPB-48

Communication System: UID 0, P25 (0); Frequency: 802.013 MHz; Duty Cycle: 1:1

Medium parameters used (interpolated): $f = 802.013 \text{ MHz}$; $\sigma = 1.01 \text{ S/m}$; $\epsilon_r = 55.394$; $\rho = 1000 \text{ kg/m}^3$

Phantom section: Flat Section

DASY5 Configuration:

- Probe: EX3DV4 - SN3687; ConvF(8.61, 8.61, 8.61); Calibrated: 2016-07-26;
- Sensor-Surface: 3mm (Mechanical Surface Detection (Locations From Previous Scan Used)), Sensor-Surface: 4mm (Mechanical Surface Detection)
- Electronics: DAE4 Sn669; Calibrated: 2016-07-18
- Phantom: Flat Phantom ELI4.0; Type: QDOVA001BA; Serial: SN:1060
- Measurement SW: DASY52, Version 52.8 (8); SEMCAD X Version 14.6.10 (7331)

Flat Phantom, Body, d=0mm./799-805MHz/P25, Mid CH, Back face, Acc C2+A1, Variability/Area Scan (61x231x1):

Interpolated grid: $dx=1.500 \text{ mm}$, $dy=1.500 \text{ mm}$

[Info: Interpolated medium parameters used for SAR evaluation.](#)

Maximum value of SAR (interpolated) = 12.4 W/kg

Flat Phantom, Body, d=0mm./799-805MHz/P25, Mid CH, Back face, Acc C2+A1, Variability/Zoom Scan (5x5x7)/Cube 0:

Measurement grid: $dx=8\text{mm}$, $dy=8\text{mm}$, $dz=5\text{mm}$

Reference Value = 34.05 V/m ; Power Drift = 0.11 dB

Peak SAR (extrapolated) = 15.8 W/kg

SAR(1 g) = 10.9 W/kg ; SAR(10 g) = 7.29 W/kg (SAR corrected for target medium)

[Info: Interpolated medium parameters used for SAR evaluation.](#)

Maximum value of SAR (measured) = 11.7 W/kg

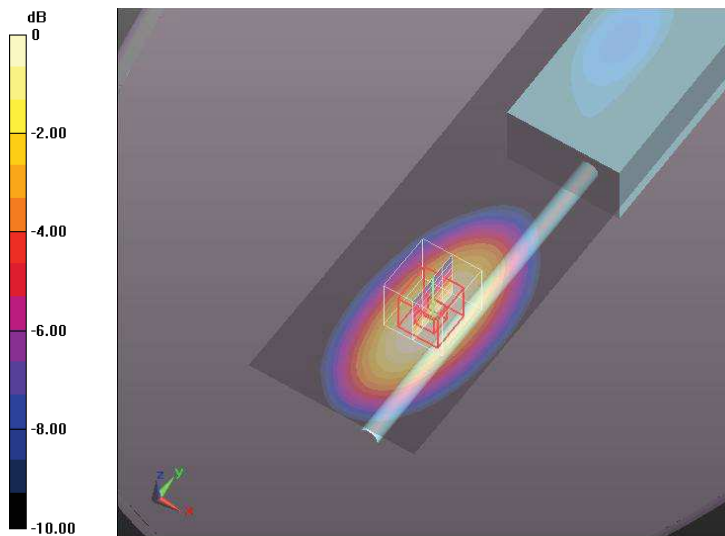

0 dB = $11.7 \text{ W/kg} = 10.68 \text{ dBW/kg}$

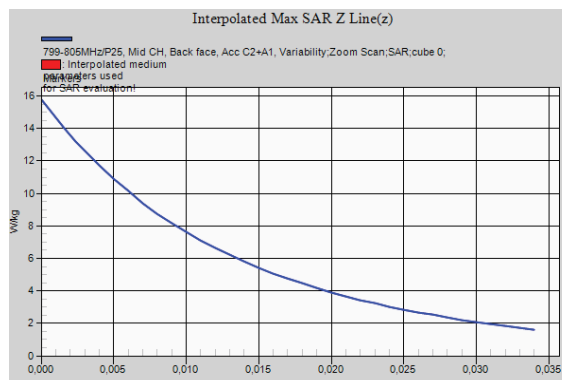

Appendix D – System Validation Reports

Validation results in 750 MHz Band for Head TSL

Test Laboratory: DEKRA Testing and Certification, S.A.U; Date: 2017-04-03

DUT: Dipole 750 MHz D750V3; Type: D750V3; Serial: D750V3 - SN:1036

Communication System: UID 0, CW (0); Frequency: 750 MHz; Duty Cycle: 1:1
 Medium parameters used: $f = 750$ MHz; $\sigma = 0.89$ S/m; $\epsilon_r = 42.84$; $\rho = 1000$ kg/m³

Phantom section: Flat Section

DASY5 Configuration:

- Probe: EX3DV4 - SN3687; ConvF(8.82, 8.82, 8.82); Calibrated: 2016-07-26;
- Sensor-Surface: 3mm (Mechanical Surface Detection)
- Electronics: DAE4 Sn669; Calibrated: 2016-07-18
- Phantom: SAM head-body simulator ; Type: Twin SAM V4.0; Serial: ---
- Measurement SW: DASY52, Version 52.8 (8); SEMCAD X Version 14.6.10 (7331)

Configuration 750MHz_2017-04-03/d=15mm, Pin=250 mW/Area Scan (61x91x1):

Interpolated grid: dx=1.500 mm, dy=1.500 mm

Maximum value of SAR (interpolated) = 2.37 W/kg

Configuration 750MHz_2017-04-03/d=15mm, Pin=250 mW/Zoom Scan (7x7x7)/Cube 0:

Measurement grid: dx=5mm, dy=5mm, dz=5mm

Reference Value = 52.61 V/m; Power Drift = -0.04 dB

Peak SAR (extrapolated) = 3.07 W/kg

SAR(1 g) = 2.05 W/kg; SAR(10 g) = 1.34 W/kg (SAR corrected for target medium)

Maximum value of SAR (measured) = 2.40 W/kg

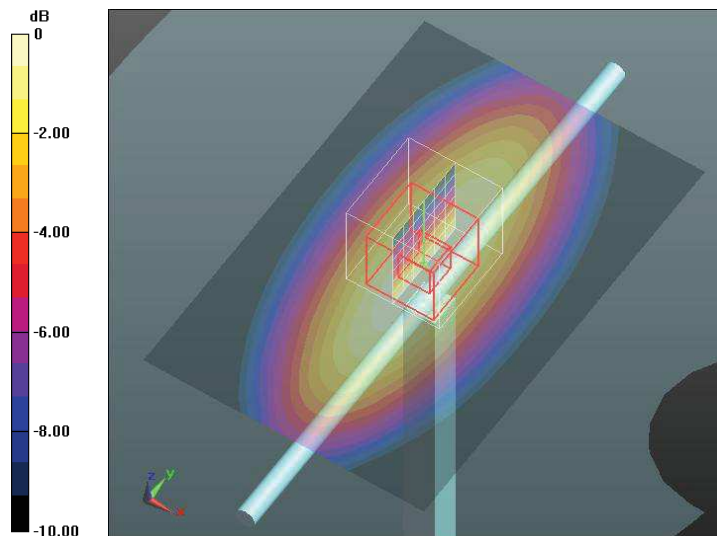

0 dB = 2.40 W/kg = 3.80 dBW/kg

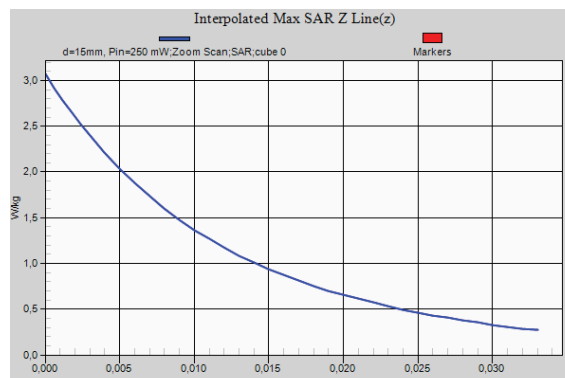

Validation results in 750 MHz Band for Body TSL

Test Laboratory: DEKRA Testing and Certification, S.A.U; Date: 2017-04-17

DUT: Dipole 750 MHz D750V3; Type: D750V3; Serial: D750V3 - SN:1036

Communication System: UID 0, CW (0); Frequency: 750 MHz; Duty Cycle: 1:1

Medium parameters used: $f = 750$ MHz; $\sigma = 0.98$ S/m; $\epsilon_r = 55.9$; $\rho = 1000$ kg/m³

Phantom section: Flat Section

DASY5 Configuration:

- Probe: EX3DV4 - SN3687; ConvF(8.61, 8.61, 8.61); Calibrated: 2016-07-26;

- Sensor-Surface: 3mm (Mechanical Surface Detection)

- Electronics: DAE4 Sn669; Calibrated: 2016-07-18

- Phantom: Flat Phantom ELI4.0; Type: QDOVA001BA; Serial: SN:1060

- Measurement SW: DASY52, Version 52.8 (8); SEMCAD X Version 14.6.10 (7331)

Configuration 750MHz, 2017-04-17/d=15mm, Pin=250 mW/Area Scan (61x91x1):

Interpolated grid: dx=1.500 mm, dy=1.500 mm

Maximum value of SAR (interpolated) = 2.59 W/kg

Configuration 750MHz, 2017-04-17/d=15mm, Pin=250 mW/Zoom Scan (7x7x7)/Cube 0:

Measurement grid: dx=5mm, dy=5mm, dz=5mm

Reference Value = 52.05 V/m; Power Drift = -0.12 dB

Peak SAR (extrapolated) = 3.27 W/kg

SAR(1 g) = 2.21 W/kg; SAR(10 g) = 1.47 W/kg (SAR corrected for target medium)

Maximum value of SAR (measured) = 2.57 W/kg

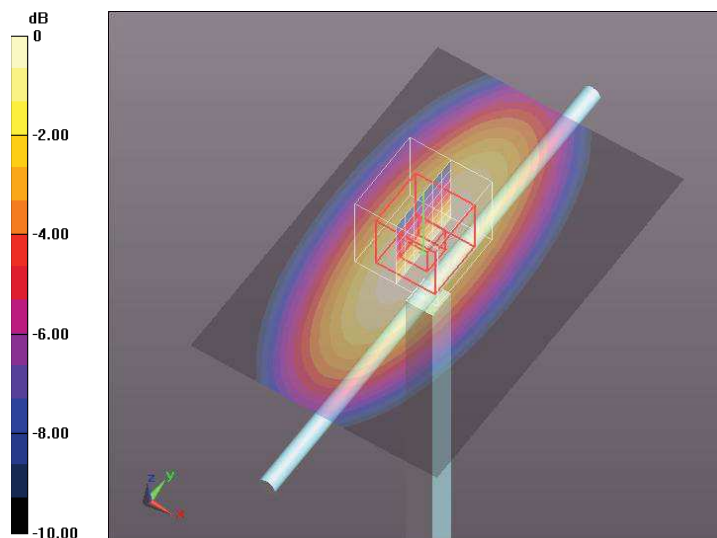

0 dB = 2.57 W/kg = 4.10 dBW/kg

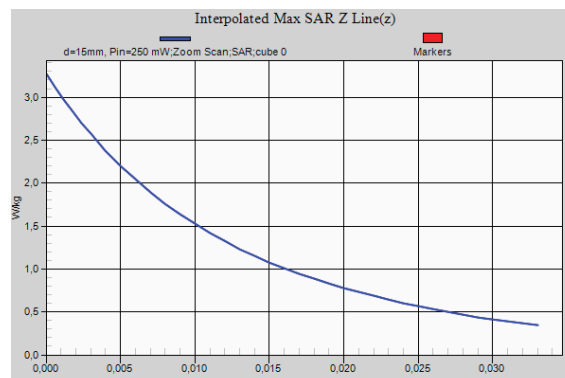

Validation results in 900 MHz Band for Head TSL

Test Laboratory: DEKRA Testing and Certification, S.A.U; Date: 2017-03-29

DUT: Dipole 900 MHz D900V2; Type: D900V2; Serial: D900V2 - SN:1d007

Communication System: UID 0, CW; Frequency: 900 MHz; Duty Cycle: 1:1
 Medium parameters used: $f = 900$ MHz; $\sigma = 0.95$ S/m; $\epsilon_r = 40.1$; $\rho = 1000$ kg/m³

Phantom section: Flat Section

DASY5 Configuration:

- Probe: EX3DV4 - SN3687; ConvF(8.25, 8.25, 8.25); Calibrated: 2016-07-26;
- Sensor-Surface: 3mm (Mechanical Surface Detection)
- Electronics: DAE4 Sn669; Calibrated: 2016-07-18
- Phantom: SAM head-body simulator ; Type: Twin SAM V4.0; Serial: ---
- Measurement SW: DASY52, Version 52.8 (8); SEMCAD X Version 14.6.10 (7331)

Configuration 900MHz_2017-03-29/d=15mm, Pin=250 mW/Area Scan (61x91x1):

Interpolated grid: dx=1.500 mm, dy=1.500 mm

Maximum value of SAR (interpolated) = 3.11 W/kg

Configuration 900MHz_2017-03-29/d=15mm, Pin=250 mW/Zoom Scan (7x7x7)/Cube 0:

Measurement grid: dx=5mm, dy=5mm, dz=5mm

Reference Value = 58.39 V/m; Power Drift = -0.05 dB

Peak SAR (extrapolated) = 4.02 W/kg

SAR(1 g) = 2.67 W/kg; SAR(10 g) = 1.72 W/kg (SAR corrected for target medium)

Maximum value of SAR (measured) = 3.11 W/kg

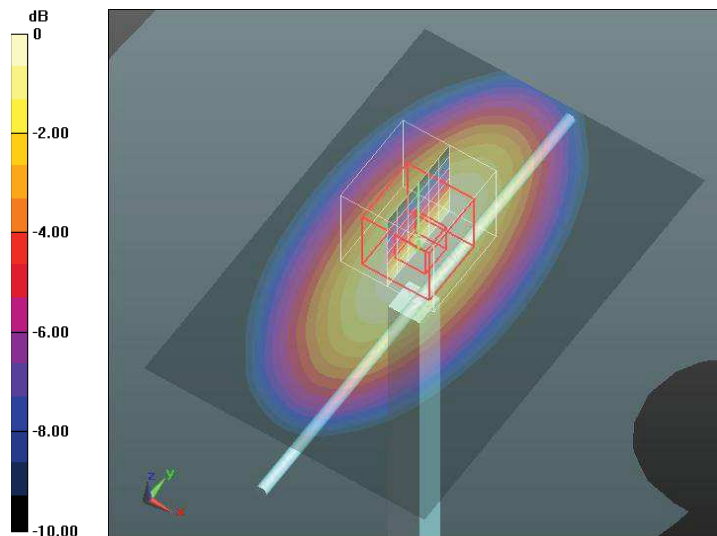

0 dB = 3.11 W/kg = 4.93 dBW/kg

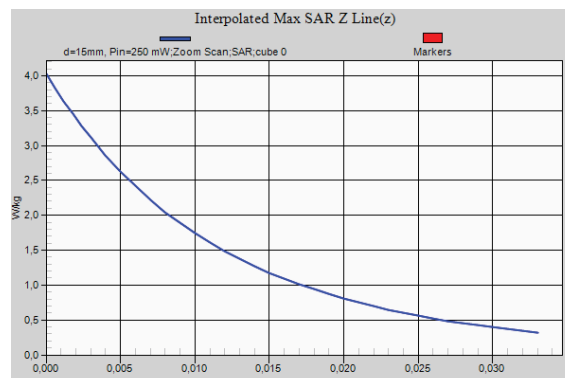

Validation results in 900 MHz Band for Body TSL

Test Laboratory: DEKRA Testing and Certification, S.A.U; Date: 2017-04-10

DUT: Dipole 900 MHz D900V2; Type: D900V2; Serial: D900V2 - SN:1d007

Communication System: UID 0, CW; Frequency: 900 MHz; Duty Cycle: 1:1

Medium parameters used: $f = 900$ MHz; $\sigma = 1.08$ S/m; $\epsilon_r = 52.62$; $\rho = 1000$ kg/m³

Phantom section: Flat Section

DASY5 Configuration:

- Probe: EX3DV4 - SN3687; ConvF(8.49, 8.49, 8.49); Calibrated: 2016-07-26;

- Sensor-Surface: 3mm (Mechanical Surface Detection)

- Electronics: DAE4 Sn669; Calibrated: 2016-07-18

- Phantom: Flat Phantom ELI4.0; Type: QDOVA001BA; Serial: SN:1060

- Measurement SW: DASY52, Version 52.8 (8); SEMCAD X Version 14.6.10 (7331)

Configuration 900MHz, 2017-04-10/d=15mm, Pin=250 mW/Area Scan (61x91x1):

Interpolated grid: dx=1.500 mm, dy=1.500 mm

Maximum value of SAR (interpolated) = 3.28 W/kg

Configuration 900MHz, 2017-04-10/d=15mm, Pin=250 mW/Zoom Scan (7x7x7)/Cube 0:

Measurement grid: dx=5mm, dy=5mm, dz=5mm

Reference Value = 55.35 V/m; Power Drift = -0.05 dB

Peak SAR (extrapolated) = 4.22 W/kg

SAR(1 g) = 2.81 W/kg; SAR(10 g) = 1.83 W/kg (SAR corrected for target medium)

Maximum value of SAR (measured) = 3.28 W/kg

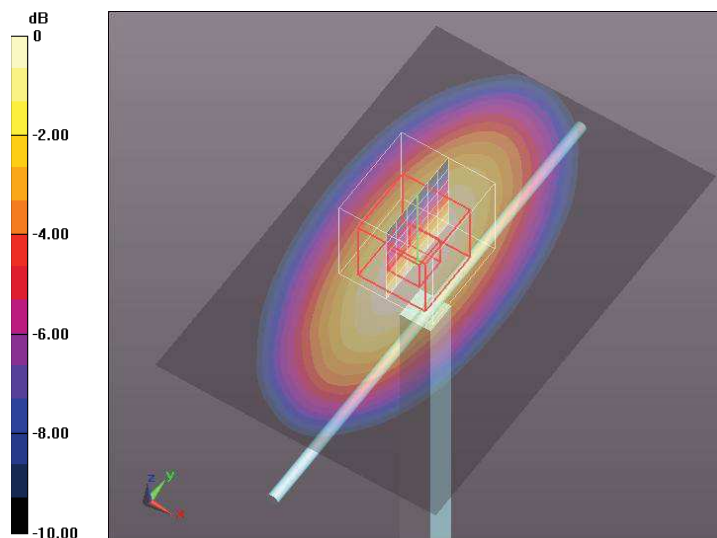

0 dB = 3.28 W/kg = 5.16 dBW/kg

