



**FCC 47 CFR PART 15 SUBPART C
ISED CANADA RSS-247 ISSUE 1**

CERTIFICATION TEST REPORT

FOR

TETRA RADIO HANDSET

HVIN: SC2024

PMN: SC2024

FCC ID: XX6SC2024

IC: 8739A-SC2024

REPORT NUMBER: R11228006-E2

ISSUE DATE: 2016-08-31

**Prepared for
SEPURA PLC
9000 CAMBRIDGE RESEARCH PARK
BEACH DRIVE WATERBEACH
CAMBRIDGE
CB25 9TL
United Kingdom**

**Prepared by
UL LLC
12 LABORATORY DR.
RESEARCH TRIANGLE PARK, NC 27709 USA
TEL: (919) 549-1400**



NVLAP Lab code: 200246-0

Revision History

<u>Ver.</u>	<u>Issue Date</u>	<u>Revisions</u>	<u>Revised By</u>
1	2016-08-31	Initial Issue	Brian Kiewra

TABLE OF CONTENTS

1. ATTESTATION OF TEST RESULTS	5
2. TEST METHODOLOGY	6
3. FACILITIES AND ACCREDITATION	6
4. CALIBRATION AND UNCERTAINTY	6
4.1. MEASURING INSTRUMENT CALIBRATION	6
4.2. SAMPLE CALCULATION	6
4.3. MEASUREMENT UNCERTAINTY	7
5. EQUIPMENT UNDER TEST	8
5.1. DESCRIPTION OF EUT	8
5.2. MAXIMUM OUTPUT POWER	8
5.3. DESCRIPTION OF AVAILABLE ANTENNAS	8
5.4. SOFTWARE AND FIRMWARE	8
5.5. WORST-CASE CONFIGURATION AND MODE	9
5.6. DESCRIPTION OF TEST SETUP	10
6. TEST AND MEASUREMENT EQUIPMENT	13
7. ANTENNA PORT TEST RESULTS	17
7.1. ON TIME AND DUTY CYCLE	17
7.1.1. ON TIME AND DUTY CYCLE RESULTS	17
7.1.2. DUTY CYCLE PLOTS	18
7.2. BASIC DATA RATE GFSK MODULATION	19
7.2.1. 20 dB AND 99% BANDWIDTH	19
7.2.2. HOPPING FREQUENCY SEPARATION	23
7.2.3. NUMBER OF HOPPING CHANNELS	25
7.2.4. AVERAGE TIME OF OCCUPANCY	28
7.2.5. OUTPUT POWER	33
7.2.6. AVERAGE POWER	34
7.2.7. CONDUCTED SPURIOUS EMISSIONS	35
7.3. ENHANCED DATA RATE QPSK MODULATION	40
7.3.1. 20 dB AND 99% BANDWIDTH	40
7.3.2. HOPPING FREQUENCY SEPARATION	44
7.3.3. NUMBER OF HOPPING CHANNELS	46
7.3.4. AVERAGE TIME OF OCCUPANCY	49
7.3.5. OUTPUT POWER	53
7.3.6. AVERAGE POWER	54
7.4. ENHANCED DATA RATE 8PSK MODULATION	55

7.4.1.	20 dB AND 99% BANDWIDTH	55
7.4.2.	HOPPING FREQUENCY SEPARATION	59
7.4.3.	NUMBER OF HOPPING CHANNELS.....	61
7.4.4.	AVERAGE TIME OF OCCUPANCY	64
7.4.5.	OUTPUT POWER.....	68
7.4.6.	AVERAGE POWER.....	69
7.4.7.	CONDUCTED SPURIOUS EMISSIONS.....	70
8.	RADIATED TEST RESULTS.....	75
8.1.	<i>LIMITS AND PROCEDURE.....</i>	<i>75</i>
8.2.	<i>TRANSMITTER ABOVE 1 GHz.....</i>	<i>76</i>
8.2.1.	BASIC DATA RATE GFSK MODULATION.....	76
8.2.2.	ENHANCED DATA RATE 8PSK MODULATION	90
8.2.3.	WORSE-CASE 18-26GHz.....	104
8.3.	<i>WORST-CASE BELOW 1 GHz.....</i>	<i>106</i>
9.	POWER LINE CONDUCTED.....	110
10.	SETUP PHOTOS.....	112

1. ATTESTATION OF TEST RESULTS

COMPANY NAME: SEPURA PLC
9000 CAMBRIDGE RESEARCH PARK
BEACH DRIVE WATERBEACH
CAMBRIDGE CB25 9TL United Kingdom

EUT DESCRIPTION: TETRA RADIO HANDSET

HVIN: SC2024
PMN: SC2024

SERIAL NUMBER: Radiated: 1PR0003Z2A5
Conducted: 1PR0003Z2AQ

DATE TESTED: 2016-05-09 to 2016-05-11

APPLICABLE STANDARDS	
STANDARD	TEST RESULTS
CFR 47 Part 15 Subpart C	Pass
ISED CANADA RSS-247 Issue 1	Pass
ISED CANADA RSS-GEN Issue 4	Pass

UL LLC tested the above equipment in accordance with the requirements set forth in the above standards. All indications of Pass/Fail in this report are opinions expressed by UL LLC based on interpretations and/or observations of test results. Measurement Uncertainties were not taken into account and are published for informational purposes only. The test results show that the equipment tested is capable of demonstrating compliance with the requirements as documented in this report.

Note: The results documented in this report apply only to the tested sample, under the conditions and modes of operation as described herein. This document may not be altered or revised in any way unless done so by UL LLC and all revisions are duly noted in the revisions section. Any alteration of this document not carried out by UL LLC will constitute fraud and shall nullify the document. This report must not be used by the client to claim product certification, approval, or endorsement by NVLAP, NIST, any agency of the Federal Government, or any agency of any government.

Approved & Released
For UL LLC By:

Prepared By:



Jeff Moser
EMC Program Manager
UL – Consumer Technology Division

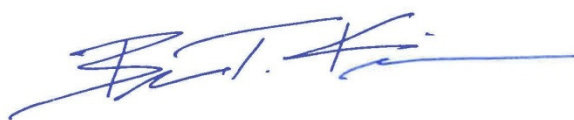

Brian Kiewra
WISE Engineer
UL – Consumer Technology Division

2. TEST METHODOLOGY

The tests documented in this report were performed in accordance with FCC CFR 47 Part 2, FCC CFR 47 Part 15, ANSI C63.10-2013, RSS-GEN Issue 4, RSS-247 Issue 1.

3. FACILITIES AND ACCREDITATION

The test sites and measurement facilities used to collect data are located at 12 Laboratory Dr., Research Triangle Park, NC 27709, USA and 2800 Suite B, Perimeter Park Drive, Morrisville, NC 27560.

12 Laboratory Dr., RTP, NC 27709
<input type="checkbox"/> Chamber A
<input type="checkbox"/> Chamber C

2800 Suite B Perimeter Park Dr., Morrisville, NC 27560
<input type="checkbox"/> Chamber NORTH
<input checked="" type="checkbox"/> Chamber SOUTH

The onsite chambers are covered under ISED Canada company address code 2180C with site numbers 2180C -1 through 2180C-4, respectively.

UL LLC (RTP) is accredited by NVLAP, Laboratory Code 200246-0. The full scope of accreditation can be viewed at <http://www.nist.gov/nvlap/>.

4. CALIBRATION AND UNCERTAINTY

4.1. MEASURING INSTRUMENT CALIBRATION

The measuring equipment utilized to perform the tests documented in this report has been calibrated in accordance with the manufacturer's recommendations, and is traceable to recognized national standards.

4.2. SAMPLE CALCULATION

Where relevant, the following sample calculation is provided:

$$\begin{aligned} \text{Field Strength (dBuV/m)} &= \text{Measured Voltage (dBuV)} + \text{Antenna Factor (dB/m)} + \\ &\text{Cable Loss (dB)} - \text{Preamp Gain (dB)} \\ 36.5 \text{ dBuV} + 18.7 \text{ dB/m} + 0.6 \text{ dB} - 26.9 \text{ dB} &= 28.9 \text{ dBuV/m} \end{aligned}$$

4.3. MEASUREMENT UNCERTAINTY

Where relevant, the following measurement uncertainty levels have been estimated for tests performed on the apparatus:

PARAMETER		UNCERTAINTY
Total RF power, conducted	+/-	0.45
RF power density, conducted	+/-	1.50
Spurious emissions, conducted	+/-	2.94
All emissions, radiated up to 26 GHz	+/-	5.36
Temperature	+/-	0.07
Humidity	+/-	2.26
DC and low frequency voltages	+/-	1.27
Conducted Emissions (0.150-30MHz)	+/-	2.37

Uncertainty figures are valid to a confidence level of 95%.

5. EQUIPMENT UNDER TEST

5.1. DESCRIPTION OF EUT

The EUT is a portable communication device (walkie talkie) that can be configured as a standalone device or operate within a charging cradle. The device comes with an optional lapel speaker accessory. The EUT contains 802.11 b/g and Bluetooth radios. The radio module is manufactured by Texas Instruments.

5.2. MAXIMUM OUTPUT POWER

The transmitter has a maximum peak conducted output power as follows:

Frequency Range (MHz)	Mode	Output Power (dBm)	Output Power (mW)
2402 - 2480	Basic GFSK	8.16	6.55
2402 - 2480	DQPSK	5.10	3.24
2402 - 2480	Enhanced 8PSK	5.58	3.61

5.3. DESCRIPTION OF AVAILABLE ANTENNAS

The radio utilizes an inverted-f antenna, with a maximum gain of 2.5 dBi.

5.4. SOFTWARE AND FIRMWARE

The EUT driver software installed during testing was Tetra USB Serial Driver x86. The test utility software used during testing was BT/WiFi Test Script ver 0.5.

5.5. WORST-CASE CONFIGURATION AND MODE

Radiated emission and power line conducted emission were performed with the EUT set to transmit at the channel with highest output power as worst-case scenario.

The fundamental of the EUT was investigated in three orthogonal orientations X,Y,Z, it was determined that Z orientation was worst-case orientation; therefore, all final radiated testing was performed with the EUT in Z orientation. For charger/cradle mode, the EUT can only be mounted in one orientation (Z-Axis).

Based on the conducted measurements, the worst-case data rates were:

802.11b mode: 11 Mbps

802.11g mode: 54 Mbps

EUT was tested in standalone mode and mounted in the charger. The EUT was also tested with the lapel speaker accessory attached.

For Enhanced Data rate modes, 8DPSK is considered worst-case and only select tests were performed for the DQPSK mode. Additionally, unless noted in the test report, all tests were performed with the DH5 packet size as this was considered worst-case.

5.6. DESCRIPTION OF TEST SETUP

SUPPORT EQUIPMENT

Support Equipment List				
Description	Manufacturer	Model	Serial Number	FCC ID
Laptop	Compaq	CQ56-115DX	CNF1134NRP	NA
Laptop	Lenovo	T450	RTP0116PC0A2UQU	NA
AC Adaptor	Click	CPS024100240	1541B	NA
Charging Cradle	Sapura	STP8000	7PP311551F7005Q	NA

I/O CABLES (CONDUCTED SETUP)

I/O Cable List					
Cable No	Port	# of Identical ports	Connector Type	Cable Length (m)	Remarks
1	Antenna Port	1	EUT	0.1m	NA

CABLES (Radiated Setup)

I/O Cable List					
Cable No	Port	# of Identical ports	Connector Type	Cable Length (m)	Remarks
1	AC Charger	1	AC Adaptor	1.85	NA
2	Accessory Lapel Speaker	1	RF/Serial	>1m	NA

TEST SETUP

Test software exercised the radio card.

SETUP DIAGRAM FOR TESTS

Conducted Setup

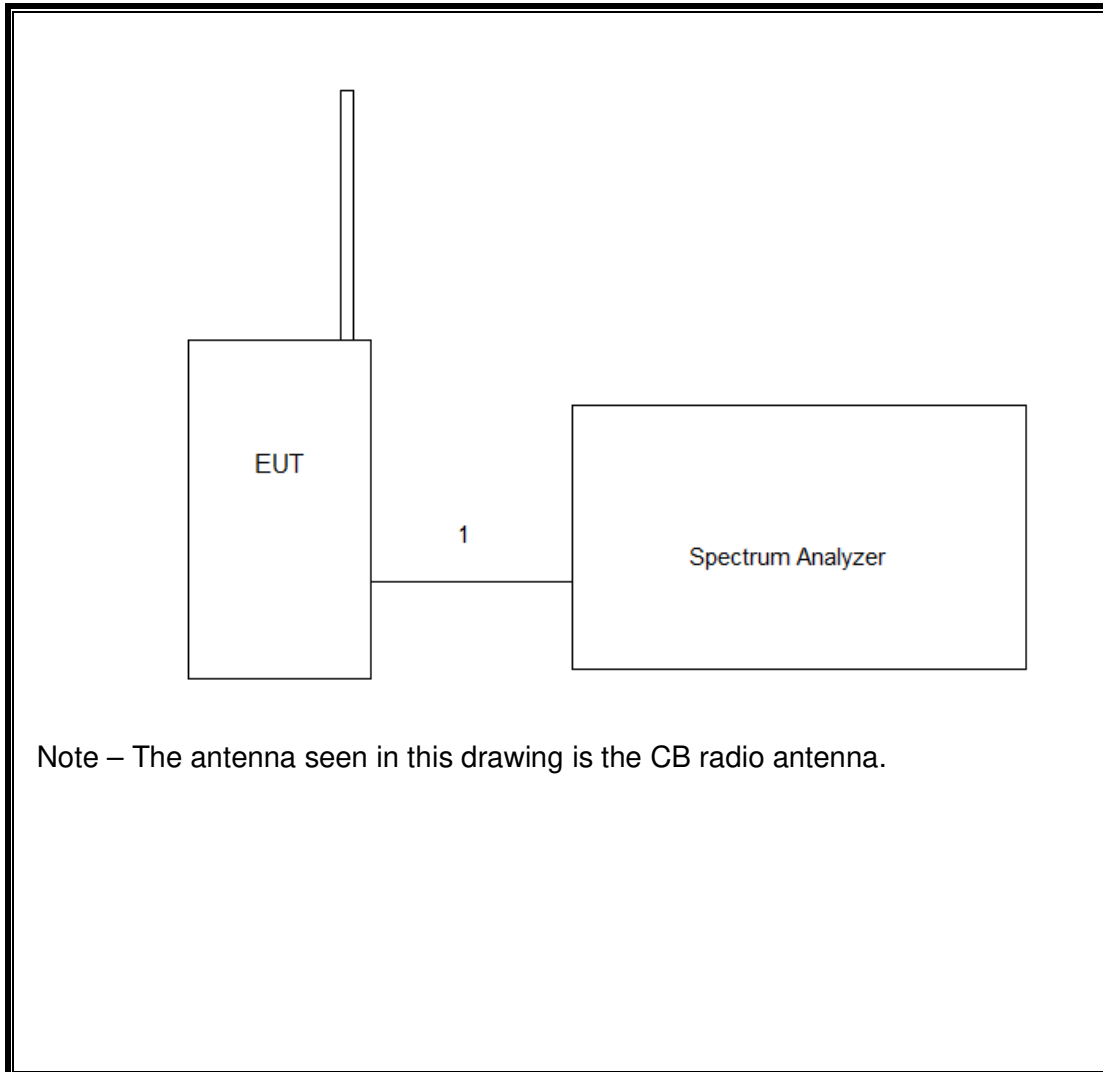

Note – The antenna seen in this drawing is the CB radio antenna.

Radiated Setup

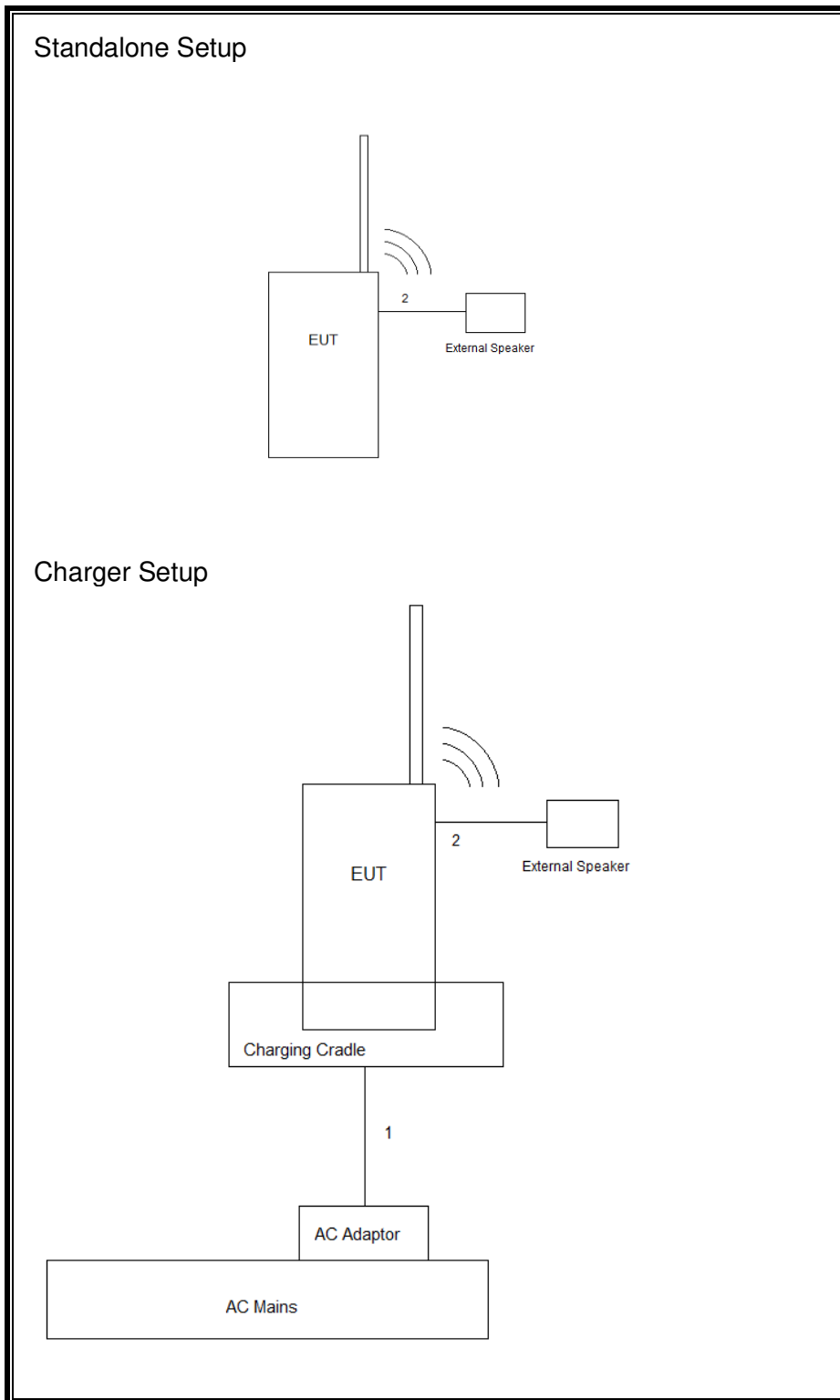

6. TEST AND MEASUREMENT EQUIPMENT

The following test and measurement equipment was utilized for the tests documented in this report:

Test Equipment Used - Radiated Disturbance Emissions Test Equipment (Morrisville - South Chamber)

Equip. ID	Description	Manufacturer	Model Number	Last Cal.	Next Cal.
	0.009-30MHz	(Loop Ant.)			
AT0079	Active Loop Antenna	ETS-Lindgren	6502	2015-12-08	2016-12-31
	30-1000 MHz				
AT0074	Hybrid Broadband Antenna	Sunol Sciences Corp.	JB3	2015-06-10	2016-06-30
	1-18 GHz				
AT0069	Double-Ridged Waveguide Horn Antenna, 1 to 18 GHz	ETS Lindgren	3117	2016-03-07	2017-03-31
	18-40 GHz				
AT0076	Horn Antenna, 18-26.5GHz	ARA	MWH-1826/B	2015-08-27	2016-08-31
AT0077	Horn Antenna, 26-40GHz	ARA	MWH-2640/B	2015-08-27	2016-08-31
	Gain-Loss Chains				
S-SAC01	Gain-loss string: 0.009-30MHz	Various	Various	2015-10-07	2016-10-31
S-SAC02	Gain-loss string: 30-1000MHz	Various	Various	2015-06-09	2016-06-30
S-SAC03	Gain-loss string: 1-18GHz	Various	Various	2015-08-22	2016-08-31
S-SAC04	Gain-loss string: 18-40GHz	Various	Various	2016-02-29	2017-02-28
	Receiver & Software				
SA0025	Spectrum Analyzer	Agilent	N9030A	2016-03-17	2017-03-31
SA0026 (18-40GHz RSE)	Spectrum Analyzer	Agilent	N9030A	2016-02-24	2017-02-28
SOFTEMI	EMI Software	UL	Version 9.5	NA	NA
HI0050	Temp/Humid/Pressure Meter	Cole-Parmer	99760-00	2015-07-01	2016-07-31

Test Equipment Used - Wireless Conducted Measurement Equipment

Equipment ID	Description	Manufacturer	Model Number	Last Cal.	Next Cal.
Conducted Room 1					
SA0019	Spectrum Analyzer	Agilent Technologies	E4446A	2015-09-02	2016-09-30
PWM004	RF Power Meter	Keysight Technologies	N1911A	2015-06-08	2017-06-08
PWS004	Peak and Avg Power Sensor, 50MHz to 6GHz	Keysight Technologies	E9323A	2015-06-05	2016-06-05
HI0079	Temp/Humid/Pressure Meter	Springfield	PreciseTemp	2015-07-1	2016-07-31
MM0167	True RMS Multimeter	Agilent	U1232A	2015-08-17	2016-08-31
76022	DC Regulated Power Supply	CircuitSpecialists.Com	CSI3005X5	N/A	N/A
T1023	EMPower USB RF Power Sensor, 10MHz to 6GHz	ETS Lindgren	7002-006	2015-10-01	2016-10-01
Conducted Room 2					
T146	Spectrum Analyzer	Agilent Technologies	E4446A	2015-06-17	2016-06-17
HI0080	Temp/Humid/Pressure Meter	Springfield	HI0080	2015-07-01	2016-07-31
MM0168	True RMS Multimeter	Agilent	U1232A	2015-08-17	2016-08-31
76021	DC Regulated Power Supply	CircuitSpecialists.Com	CSI3005X5	N/A	N/A

Test Equipment Used - Line-Conducted Emissions – Voltage (Morrisville – Conducted 1)

Equipment ID	Description	Manufacturer	Model Number	Last Cal.	Next Cal.
CBL077	Coax cable, RG223, N-male to BNC-male, 20-ft.	Pasternack	PE3476-240	2015-10-29	2016-10-31
HI0079	Temp/Humid/Pressure Meter	Springfield Precision	PreciseTemp	2015-07-01	2016-07-31
LISN003	LISN, 50-ohm/50-uH, 2-conductor, 25A	Fischer Custom Com.	FCC-LISN-50-25-2-01-550V	2015-08-24	2016-08-31
LISN008	LISN, 50-ohm/50-uH, 2-conductor, 25A (For support gear only.)	Solar Electronics	8012-50-R-24-BNC	2015-09-03	2016-09-30
MM0167	Multi-meter	Agilent	U1232A	2015-08-17	2016-08-31
PRE0101521 (75141)	EMI Test Receiver 9kHz-7GHz	Rohde & Schwarz	ESCI 7	2015-08-26	2016-08-31
TL001	Transient Limiter, 0.009-30MHz	Com-Power	LIT-930A	2015-05-22	2016-05-31
PS214	AC Power Source	Elgar	CW2501M (s/n 1523A02396)	NA	NA
PS215	AC Power Source	Elgar	CW2501M (s/n 1523A02397)	NA	NA
SOFTEMI	EMI Software	UL	Version 9.5	NA	NA

7. MEASUREMENT METHODS

Duty Cycle: KDB 558074 Section 6.0 (b)

20 dB BW: ANSI C63.10 Section 6.9.2.

99% Occupied Bandwidth: ANSI C63.10-2013, Section 6.9.3

Hopping Frequency Separation: ANSI C63.10 Section 7.8.2

Number of Hopping Channels: ANSI C63.10 Section 7.8.3

Average Time of Occupancy: ANSI C63.10 Section 7.8.4

Output Power: ANSI C63.10 Section 7.8.5

Out-of-band emissions in non-restricted bands: ANSI C63.10 Section 7.8.6 & 7.8.8

Out-of-band emissions in restricted bands: ANSI C63.10:2013 Sections 6.3-6.6

Line Conducted Emissions: ANSI C63.10:2013 Sections 6.2

8. ANTENNA PORT TEST RESULTS

8.1. ON TIME AND DUTY CYCLE

LIMITS

None; for reporting purposes only.

PROCEDURE

KDB 558074 Section 6.0 (b)

Test Information

Date: 2016-05-10

Tester: Mark Learner

8.1.1. ON TIME AND DUTY CYCLE RESULTS

Mode	ON Time B (msec)	Period (msec)	Duty Cycle x (linear)	Duty Cycle (%)	Duty Cycle Correction Factor (dB)	1/B Minimum VBW (kHz)
2.4 GHz band (Hopping OFF)						
Bluetooth GFSK	2.910	3.753	0.775	77.54%	1.10	0.344
Bluetooth 8PSK	2.910	3.753	0.775	77.54%	1.10	0.344

8.1.2. DUTY CYCLE PLOTS

HOPPING OFF

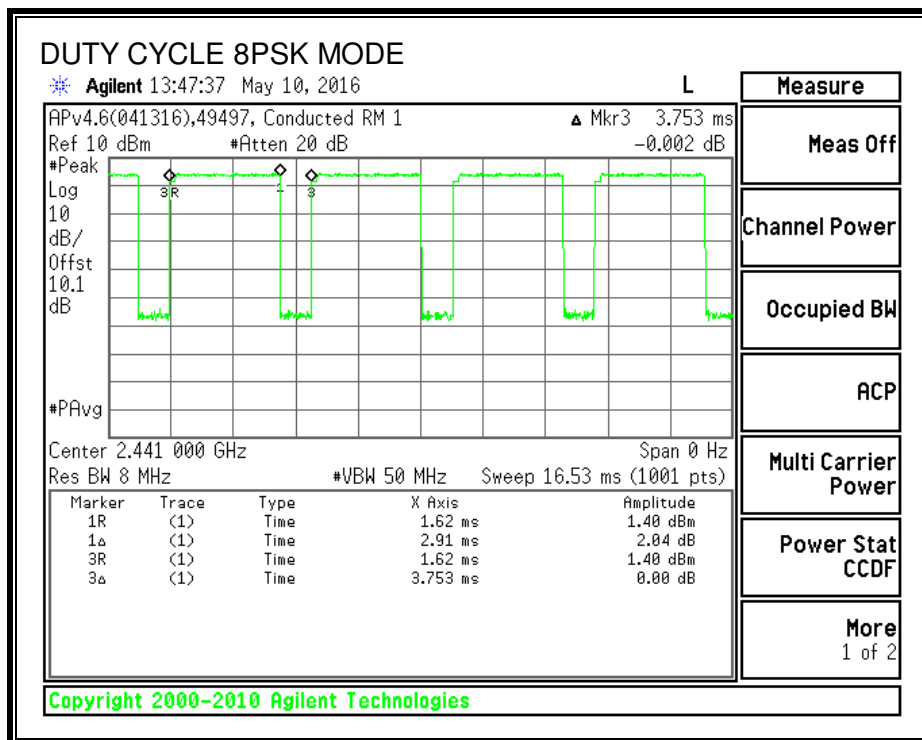
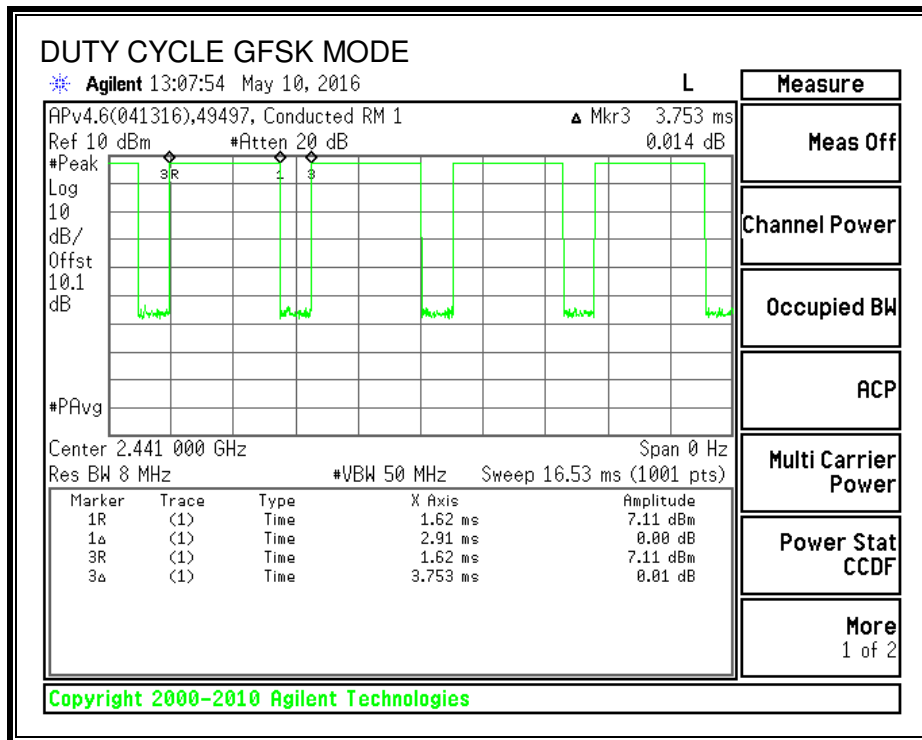

8.2. BASIC DATA RATE GFSK MODULATION

8.2.1. 20 dB AND 99% BANDWIDTH

LIMIT

FCC §15.247 (a) (1)

IC RSS-247 5.1 (1)

IC RSS-Gen clause 6.6

None; for reporting purposes only.

TEST PROCEDURE

The transmitter output is connected to a spectrum analyzer. The RBW is set to 1-5% of the 20 dB bandwidth and 99% Occupied Bandwidth. The VBW is set to \geq RBW. The sweep time is coupled.

Test Information

Date: 2016-05-10

Tester: Mark Learner

RESULTS

Channel	Frequency (MHz)	20 dB Bandwidth (kHz)	99% Bandwidth (kHz)
Low	2402	926	855.9652
Middle	2441	938	866.322
High	2480	844	878.7051

20 dB AND 99% BANDWIDTH

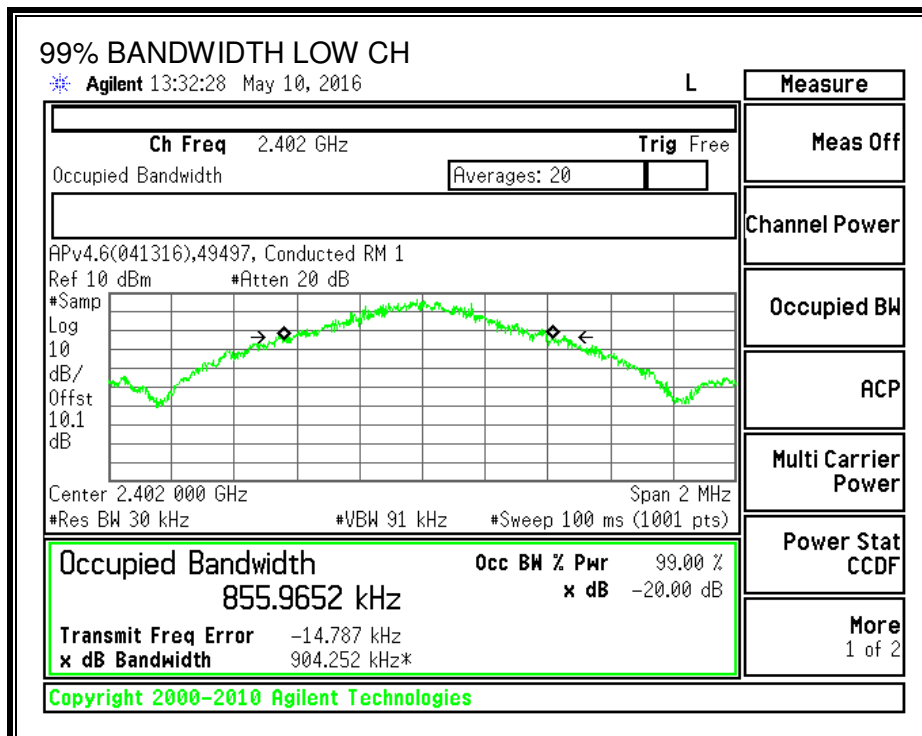
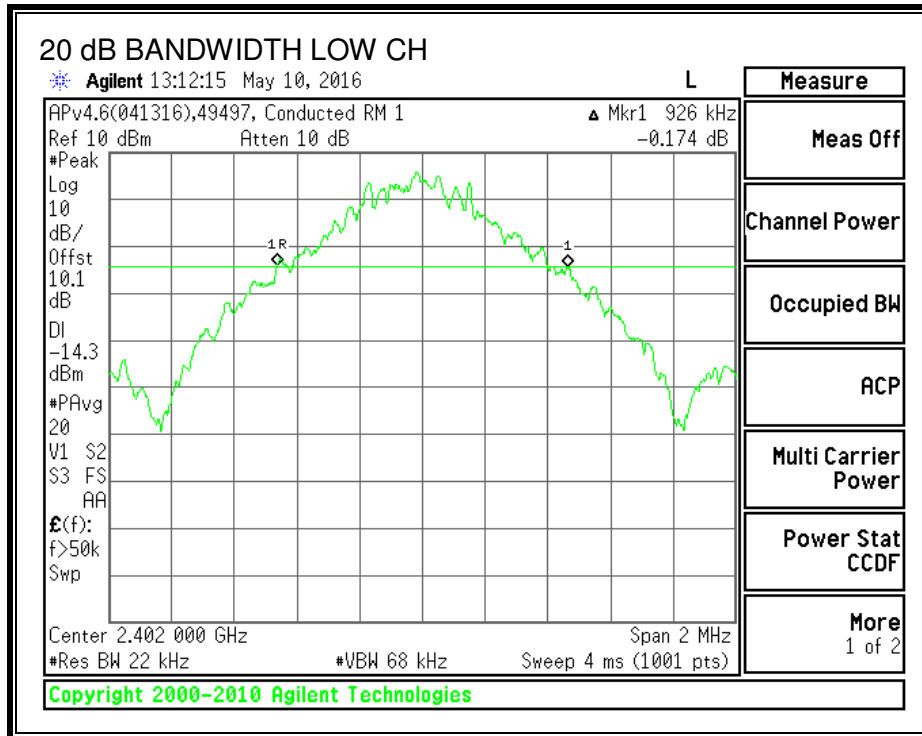

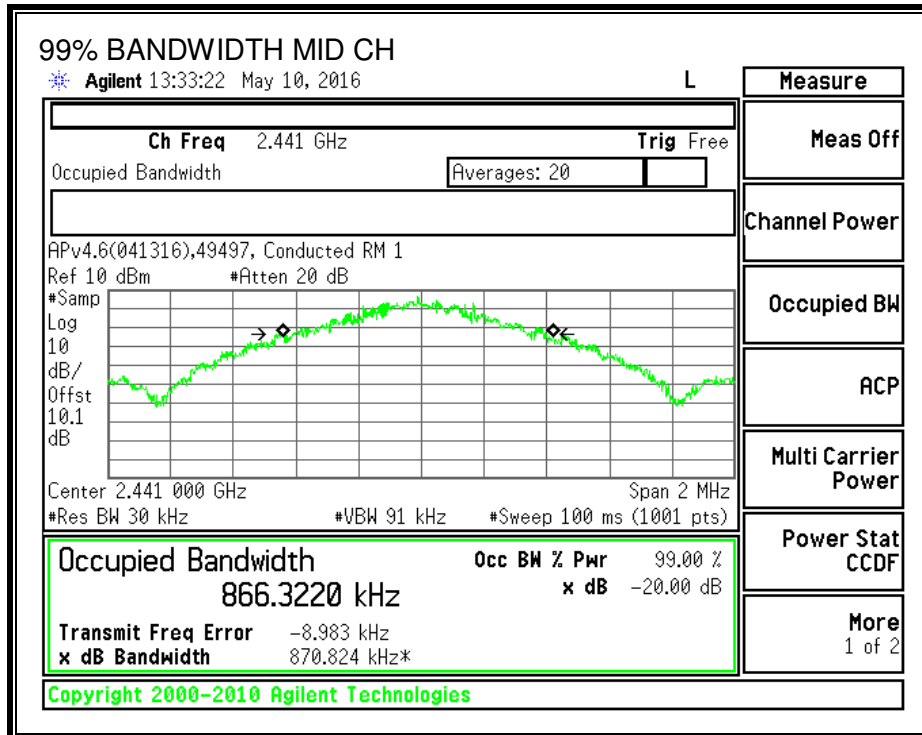
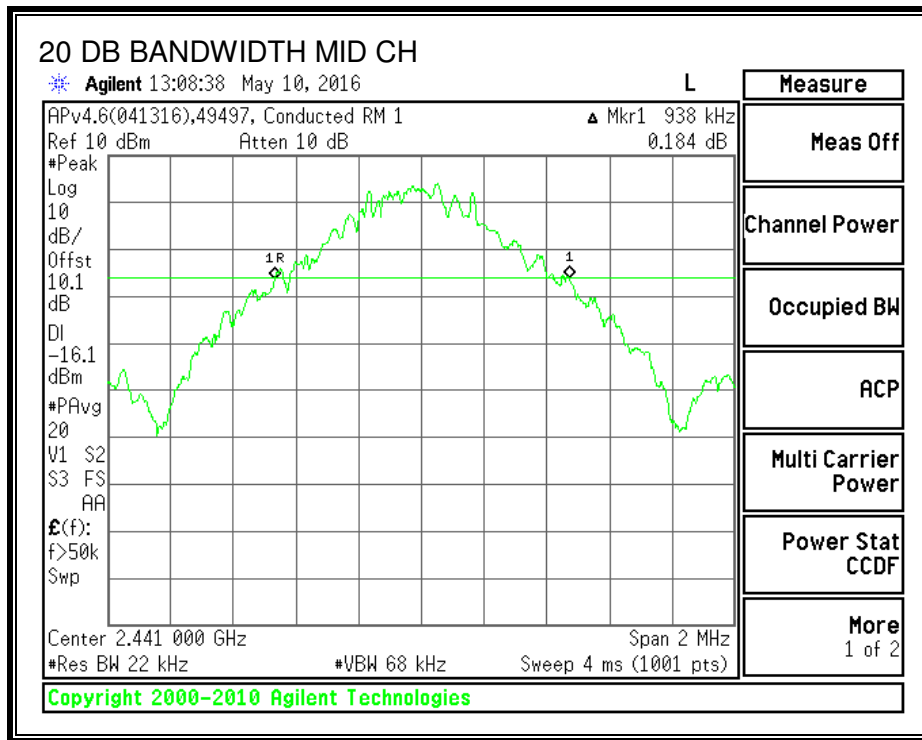

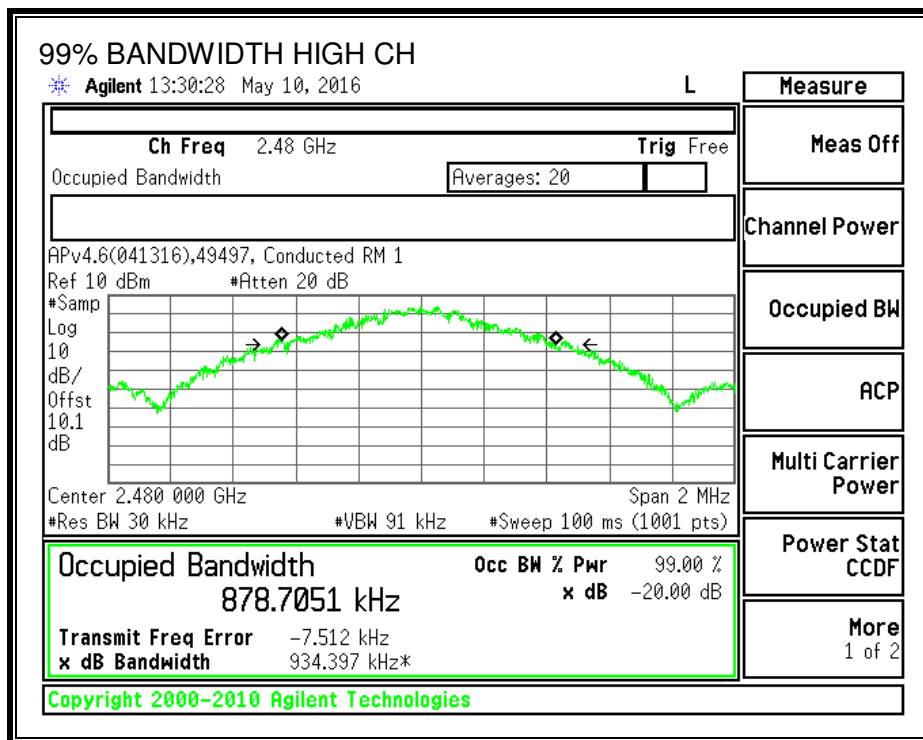
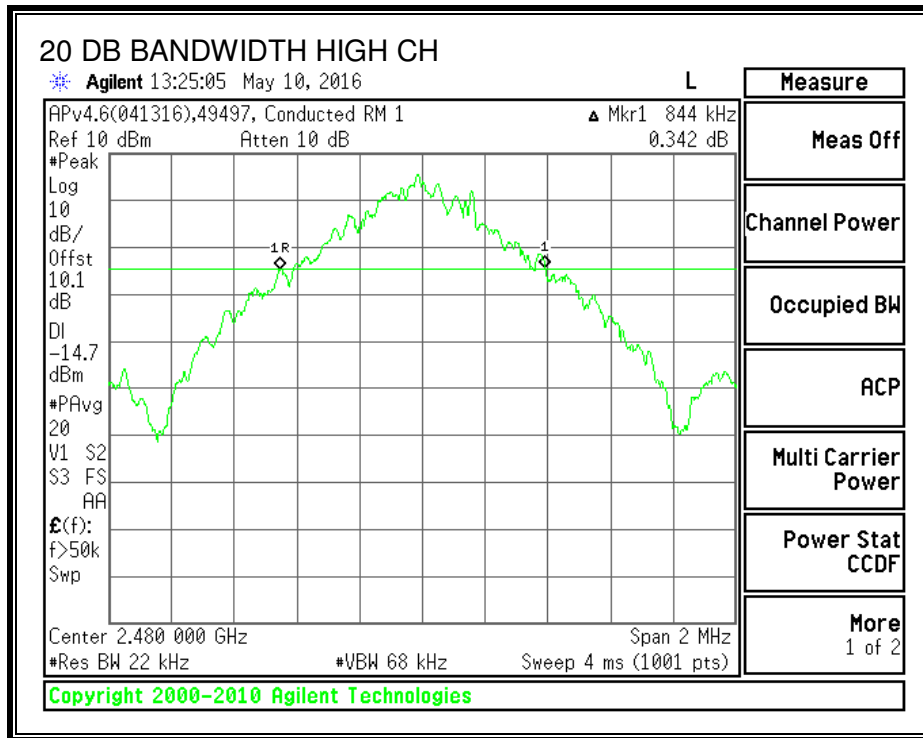

8.2.2. HOPPING FREQUENCY SEPARATION

LIMIT

ANSI C63.10 Section 7.8.2

FCC §15.247 (a) (1)

IC RSS-247 5.1 (2)

Frequency hopping systems shall have hopping channel carrier frequencies separated by a minimum of 25 kHz or the 20 dB bandwidth of the hopping channel, whichever is greater.

Alternatively, frequency hopping systems operating in the 2400-2483.5 MHz band may have hopping channel carrier frequencies that are separated by 25 kHz or two-thirds of the 20 dB bandwidth of the hopping channel, whichever is greater, provided the systems operate with an output power no greater than 125 mW.

TEST PROCEDURE

The transmitter output is connected to a spectrum analyzer. The RBW is set to 300 kHz and the VBW is set to 3x RBW. The sweep time is coupled.

Test Information

Date: 2016-05-10

Tester: Mark Learner

RESULTS

Channel 1 (MHz)	Channel 2 (MHz)	Channel Separation (MHz)	2/3 of 20dB BW (MHz)	Margin (MHz)
2441	2442	1	0.625	-0.375

HOPPING FREQUENCY SEPARATION

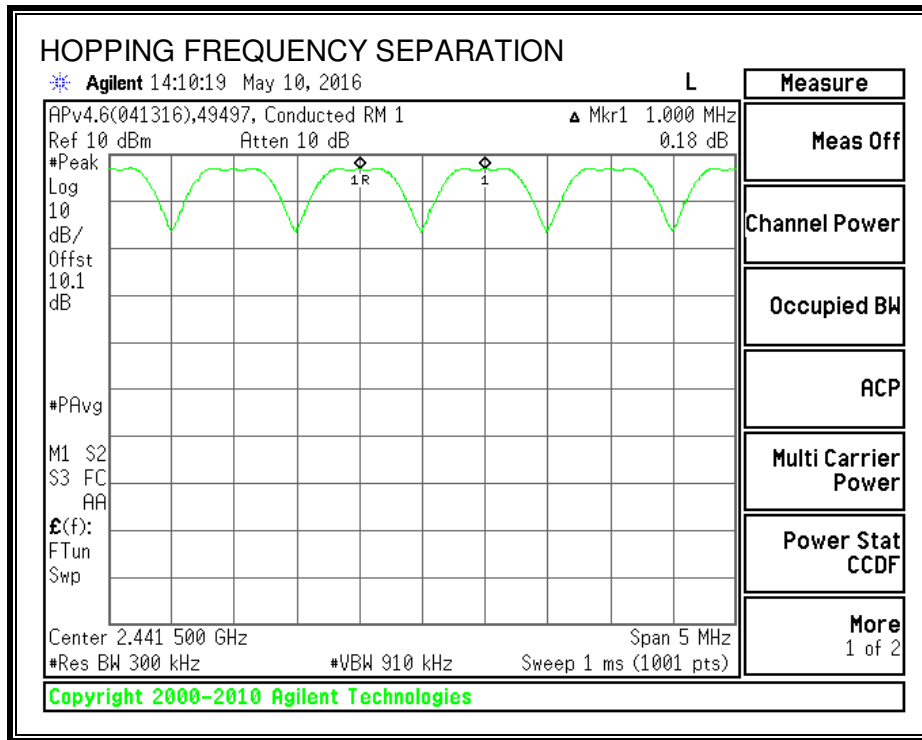

8.2.3. NUMBER OF HOPPING CHANNELS

LIMIT

ANSI C63.10 Section 7.8.3

FCC §15.247 (a) (1) (iii)

IC RSS-210 5.1 (4)

Frequency hopping systems in the 2400 – 2483.5 MHz band shall use at least 15 non-overlapping channels.

TEST PROCEDURE

The transmitter output is connected to a spectrum analyzer. The span is set to cover the entire authorized band, in either a single sweep or in multiple contiguous sweeps for visibility of the entire span. Then, smaller spans are set to more clearly identify the channels. The RBW is set to 30% of the channel spacing (approx. 300 kHz). The analyzer is set to Max Hold.

Test Information

Date: 2016-05-10

Tester: Mark Learner

RESULTS

Normal Mode: 79 Channels observed.

AFH Mode: min of 20 Channels declared.

NUMBER OF HOPPING CHANNELS

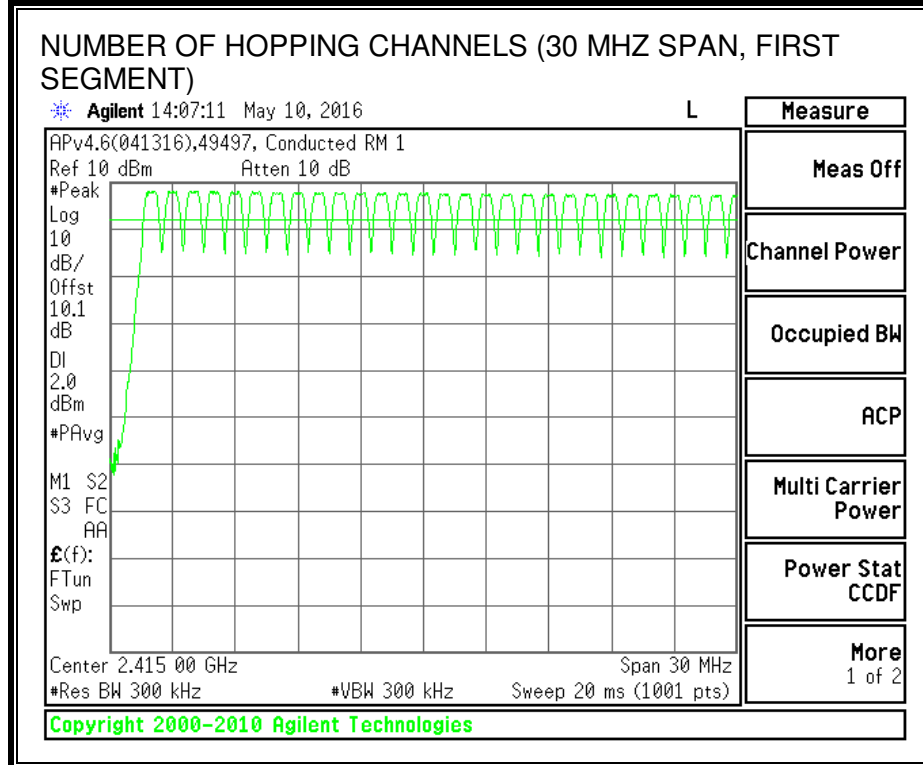
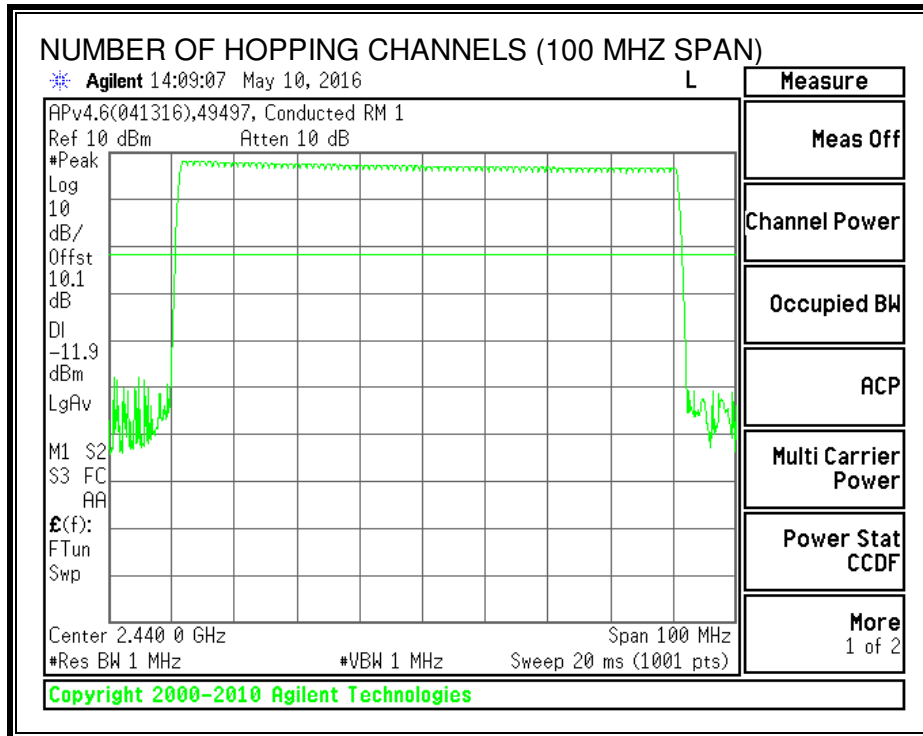

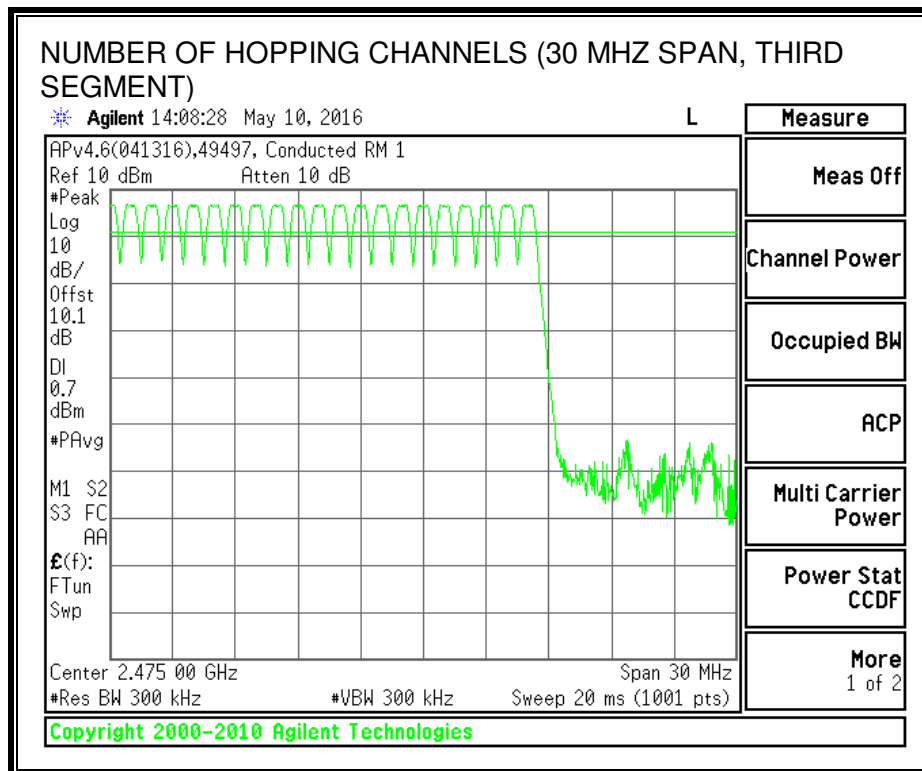
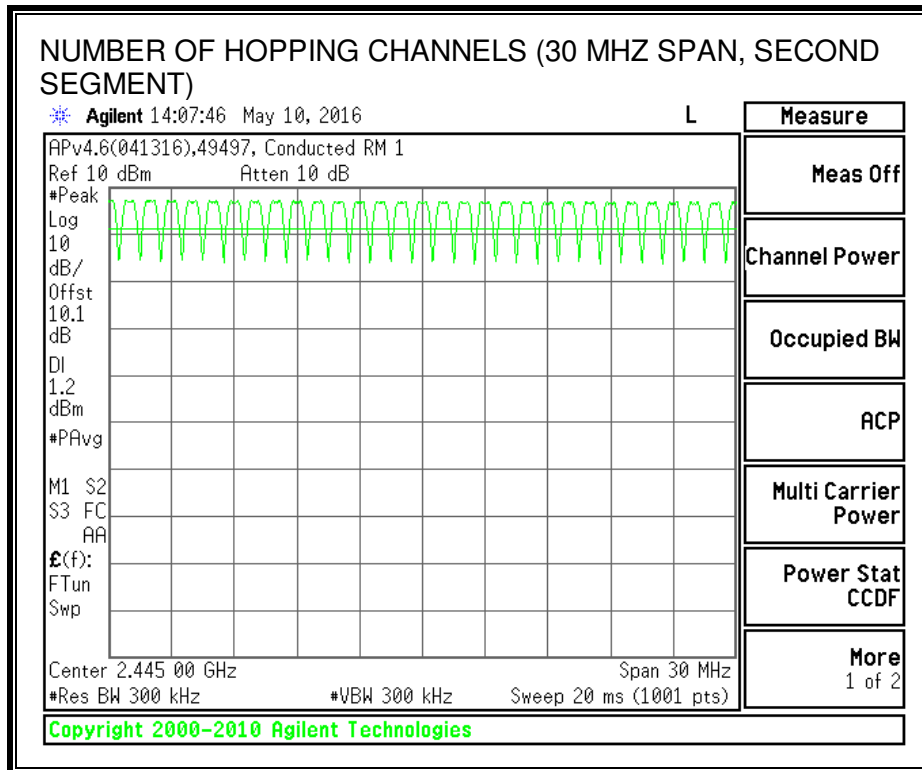

8.2.4. AVERAGE TIME OF OCCUPANCY

LIMIT

ANSI C63.10 Section 7.8.4

FCC §15.247 (a) (1) (iii)

IC RSS-247 5.1 (4)

The average time of occupancy on any channel shall not be greater than 0.4 seconds within a period of 0.4 seconds multiplied by the number of hopping channels employed.

TEST PROCEDURE

The transmitter output is connected to a spectrum analyzer. The span is set to 0 Hz, centered on a single, selected hopping channel. The width of a single pulse is measured in a fast scan. The number of pulses is measured in a 3.16 second scan, to enable resolution of each occurrence.

The average time of occupancy in the specified 31.6 second period (79 channels * 0.4 s) is equal to $10 * (\# \text{ of pulses in } 3.16 \text{ s}) * \text{ pulse width}$.

For AFH mode, the average time of occupancy in the specified 8 second period (20 channels * 0.4 seconds) is equal to $10 * (\# \text{ of pulses in } 0.8 \text{ s}) * \text{ pulse width}$.

Test Information

Date: 2016-05-10

Tester: Mark Learner

RESULTS

DH Packet	Pulse Width (msec)	Number of Pulses in 3.16 seconds	Average Time of Occupancy (sec)	Limit (sec)	Margin (sec)
GFSK Normal Mode					
DH1	0.4	32	0.128	0.4	-0.272
DH3	1.654	17	0.281	0.4	-0.119
DH5	2.904	12	0.348	0.4	-0.052
DH Packet	Pulse Width (msec)	Number of Pulses in 0.8 seconds	Average Time of Occupancy (sec)	Limit (sec)	Margin (sec)
GFSK AFH Mode					
DH1	0.4	8	0.032	0.4	-0.368
DH3	1.654	4.25	0.070	0.4	-0.330
DH5	2.904	3	0.087	0.4	-0.313

PULSE WIDTH - DH1

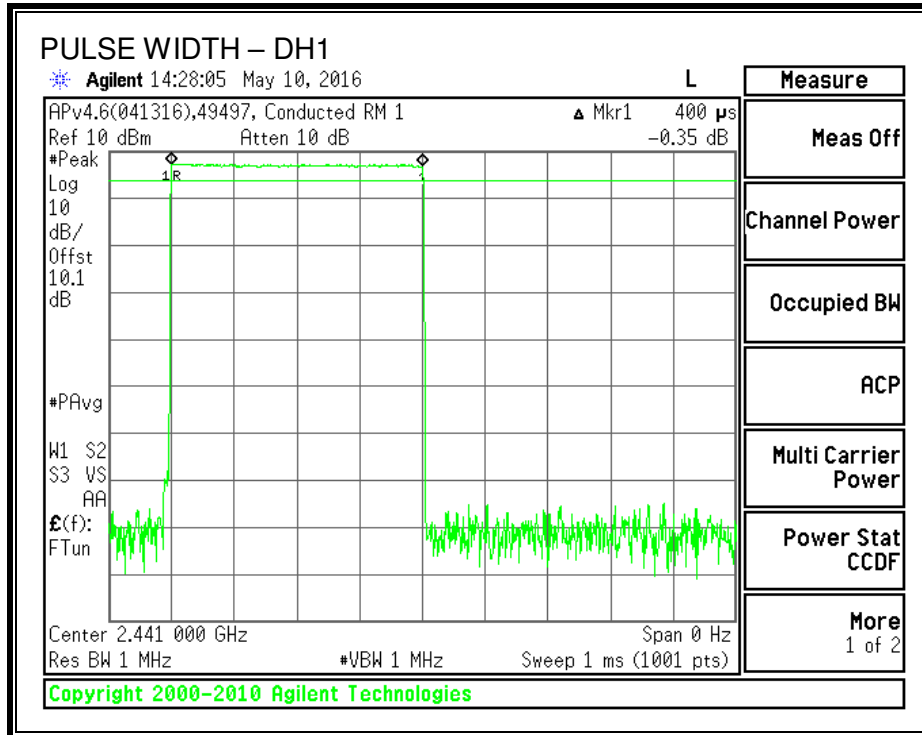

NUMBER OF PULSES IN 3.16 SECOND OBSERVATION PERIOD – DH1

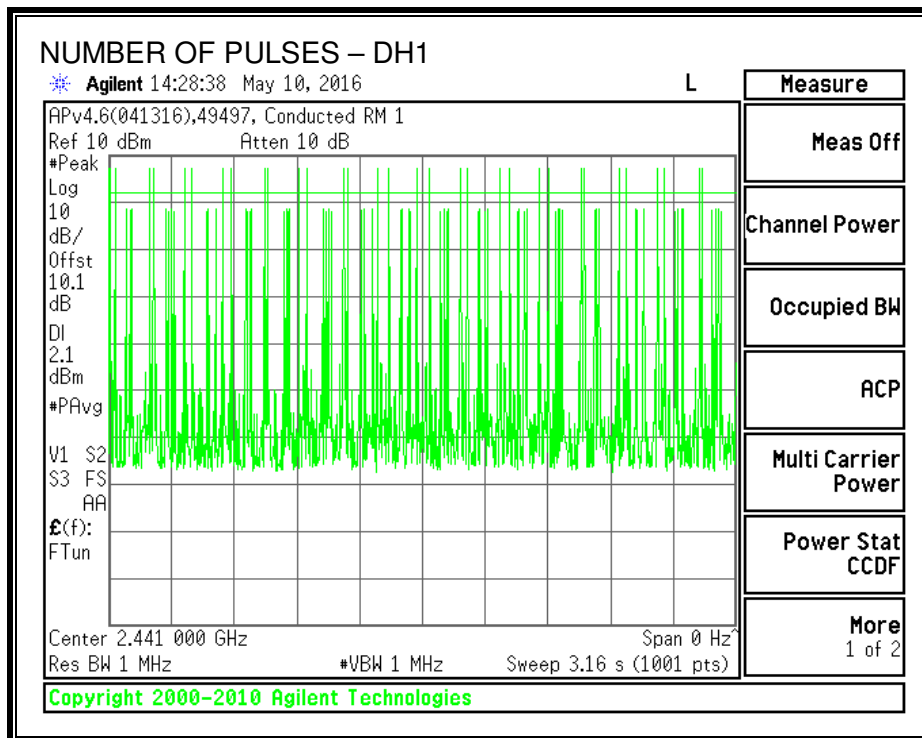

PULSE WIDTH – DH3

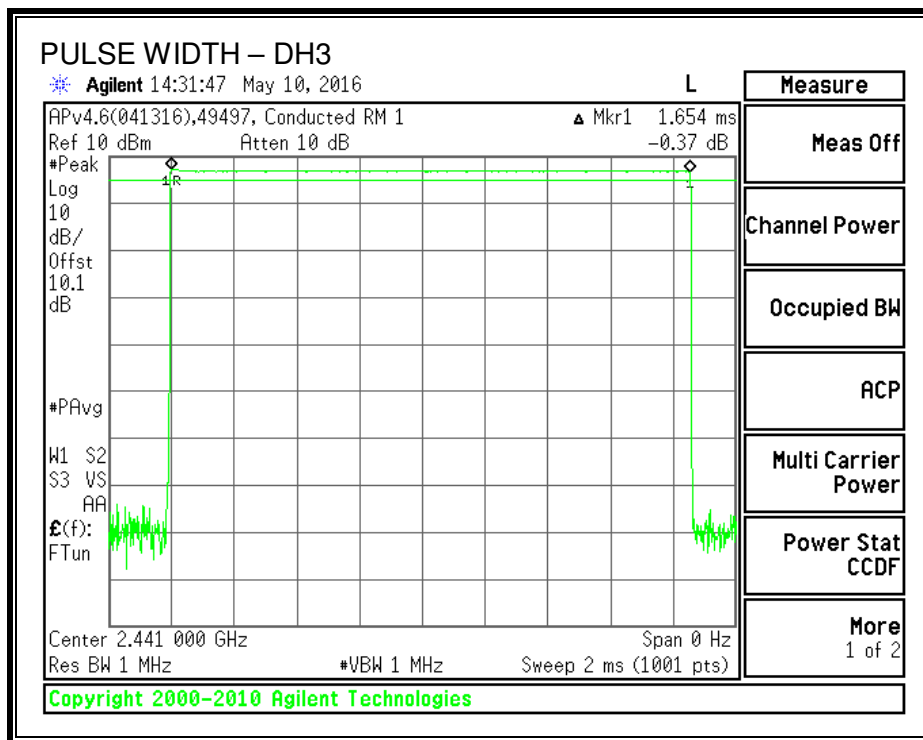

NUMBER OF PULSES IN 3.16 SECOND OBSERVATION PERIOD – DH3

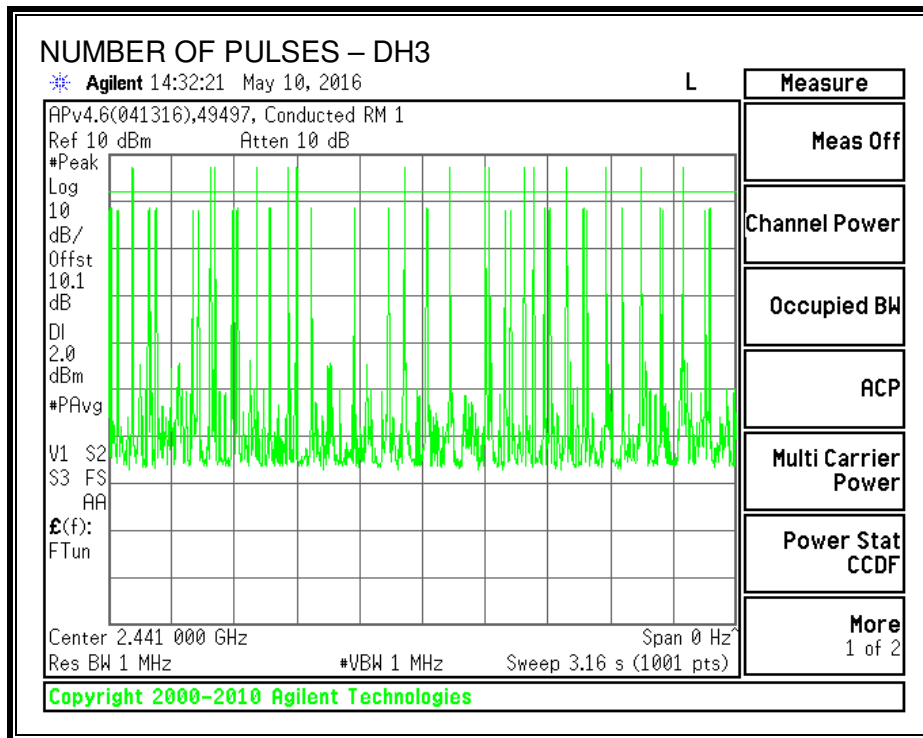

PULSE WIDTH – DH5

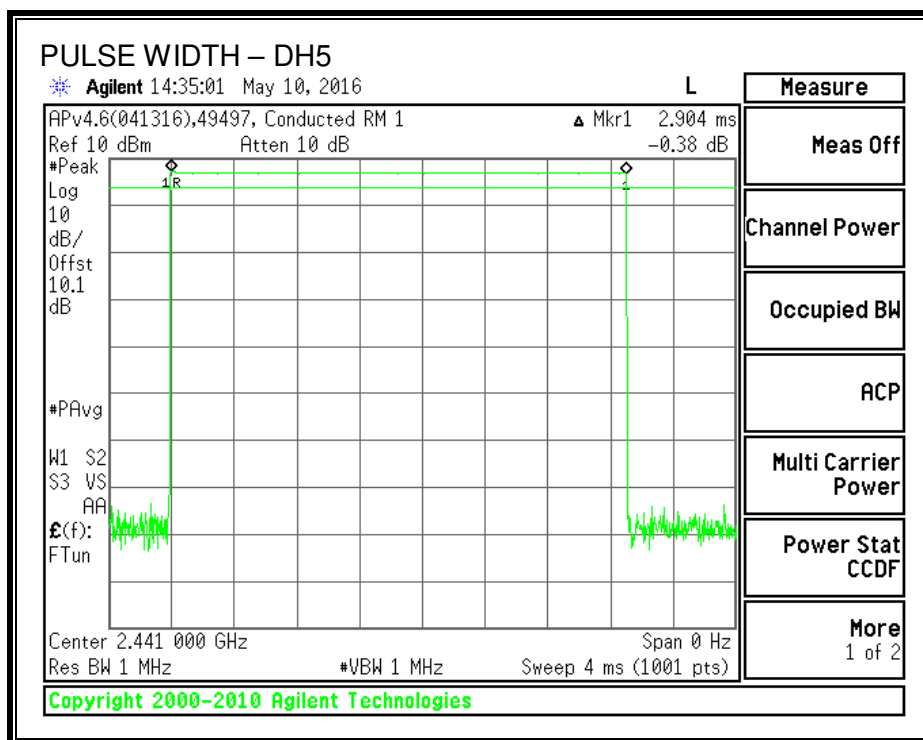

NUMBER OF PULSES IN 3.16 SECOND OBSERVATION PERIOD – DH5

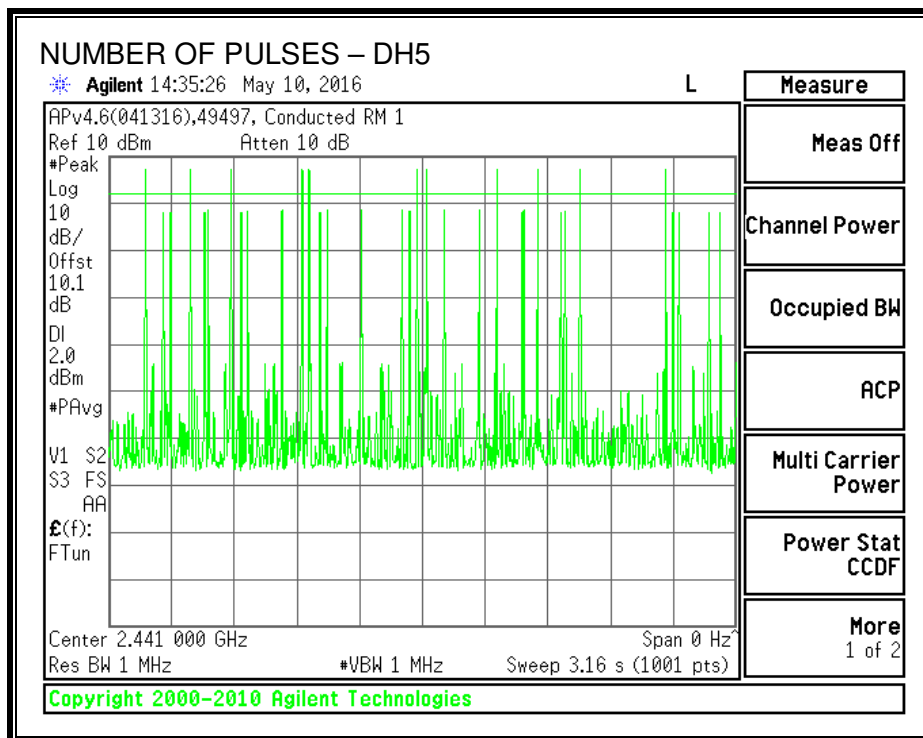

8.2.5. OUTPUT POWER

LIMIT

ANSI C63.10 Section 7.8.5

§15.247 (b) (1)

For frequency hopping systems operating in the 2400-2483.5 MHz band employing at least 75 non-overlapping hopping channels, and all frequency hopping systems in the 5725-5850 MHz band: 1 watt. For all other frequency hopping systems in the 2400-2483.5 MHz band: 0.125 watts.

RSS-247 Clause 5.4 (2)

For frequency hopping systems operating in the band 2400-2483.5 MHz and employing at least 75 hopping channels, the maximum peak conducted output power shall not exceed 1 W; for all other frequency hopping systems in the band, the maximum peak conducted output power shall not exceed 0.125 W.

TEST PROCEDURE

The transmitter output was connected to a power meter equipped with a power sensor capable of measuring peak power. The cable assembly insertion loss of 10.1dB (including 10 dB pad and 0.1dB cable) was entered as an offset in the power meter to allow for direct reading of power.

Test Information

Date: 2016-05-10

Tester: Mark Learner

RESULTS

The following is peak power:

Channel	Frequency (MHz)	Output Power (dBm)	Directional Gain (dBi)	Limit (dBm)	Margin (dB)
Low	2402	8.16	2.50	30	-21.84
Middle	2441	7.02	2.50	30	-22.98
High	2480	6.65	2.50	30	-23.35

8.2.6. AVERAGE POWER

LIMIT

None; for reporting purposes only.

TEST PROCEDURE

The transmitter output is connected to a power meter.

Test Information

Date: 2016-05-10

Tester: Mark Learner

RESULTS

The cable assembly insertion loss of 10.1 dB (including 10 dB pad and 0.1 dB cable) was entered as an offset in the power meter to allow for direct reading of power. The below is an gated average measurement.

Channel	Frequency (MHz)	Average Power (dBm)
Low	2402	8.13
Middle	2441	6.98
High	2480	6.62

8.2.7. CONDUCTED SPURIOUS EMISSIONS

LIMITS

ANSI C63.10 Section 7.8.6 and 7.8.8

FCC §15.247 (d)

In any 100 kHz bandwidth outside the frequency band in which the spread spectrum or digitally modulated intentional radiator is operating, the radio frequency power that is produced by the intentional radiator shall be at least 20 dB below that in the 100 kHz bandwidth within the band that contains the highest level of the desired power, based on either an RF conducted or a radiated measurement, provided the transmitter demonstrates compliance with the peak conducted power limits. If the transmitter complies with the conducted power limits based on the use of RMS averaging over a time interval, as permitted under paragraph (b)(3) of this section, the attenuation required under this paragraph shall be 30 dB instead of 20 dB. Attenuation below the general limits specified in §15.209(a) is not required. In addition, radiated emissions which fall in the restricted bands, as defined in §15.205(a), must also comply with the radiated emission limits specified in §15.209(a) (see §15.205(c)).

IC RSS-247 5.5

In any 100 kHz bandwidth outside the frequency band in which the spread spectrum or digitally modulated device is operating, the RF power that is produced shall be at least 20 dB below that in the 100 kHz bandwidth within the band that contains the highest level of the desired power, based on either an RF conducted or a radiated measurement, provided that the transmitter demonstrates compliance with the peak conducted power limits. If the transmitter complies with the conducted power limits based on the use of root-mean-square averaging over a time interval, as permitted under Section A8.4 (4), the attenuation required shall be 30 dB instead of 20 dB. Attenuation below the general field strength limits specified in RSS-Gen is not required.

TEST PROCEDURE

The transmitter output is connected to a spectrum analyzer. The resolution bandwidth is set to 100 kHz. The video bandwidth is set to 300 kHz.

The spectrum from 30 MHz to 26 GHz is investigated with the transmitter set to the lowest, middle, and highest channels.

The bandedges at 2.4 and 2.4835 GHz are investigated with the transmitter set to the normal hopping mode.

Test Information

Date: 2016-05-10

Tester: Mark Learner

RESULTS

SPURIOUS EMISSIONS, LOW CHANNEL

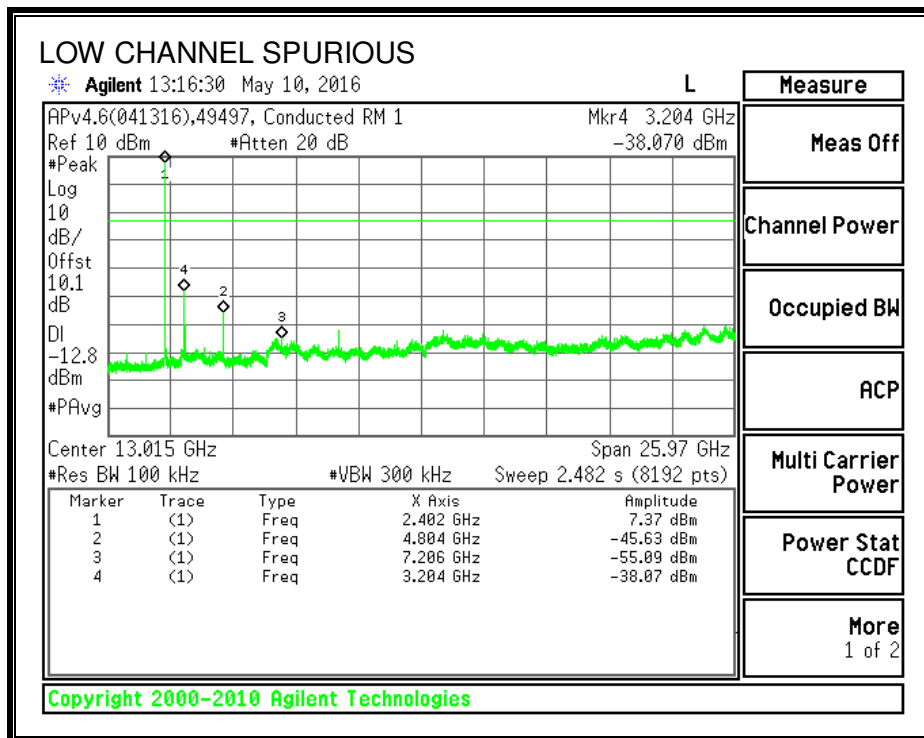
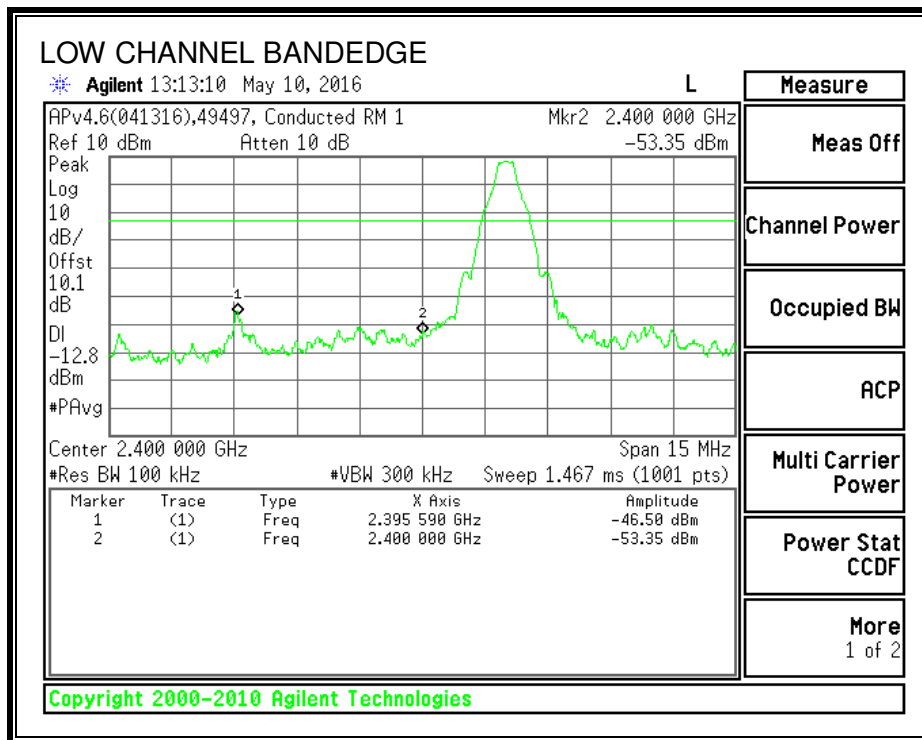

SPURIOUS EMISSIONS, MID CHANNEL

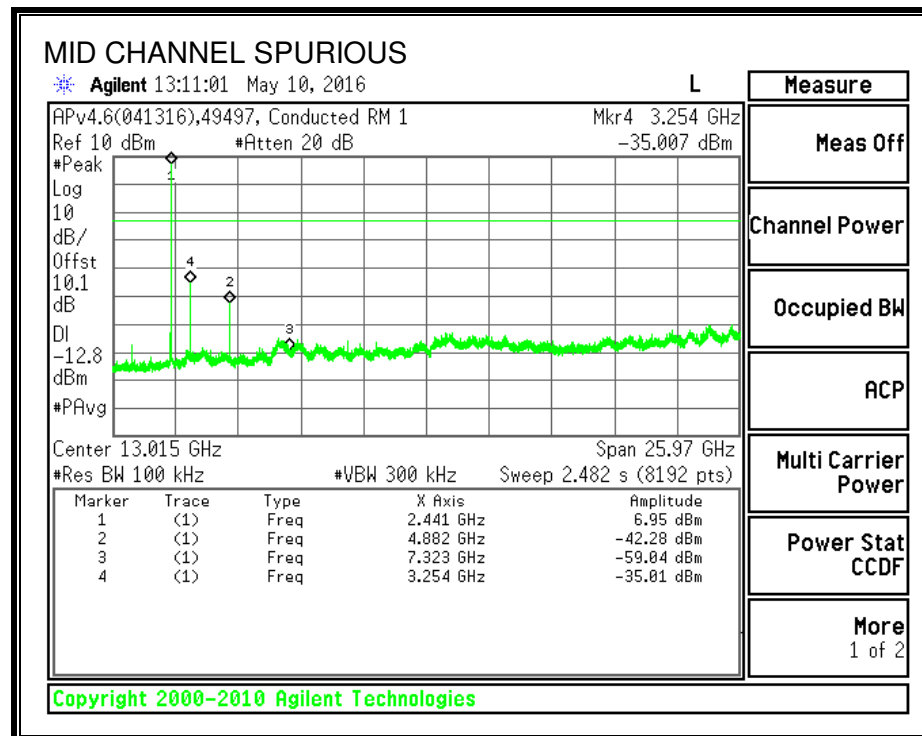
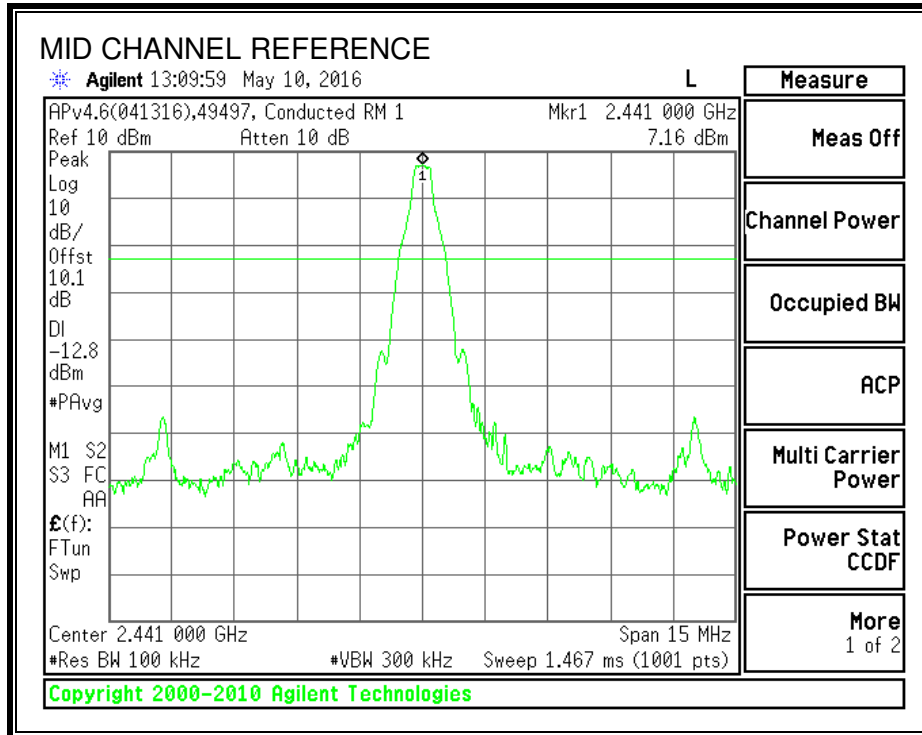

SPURIOUS EMISSIONS, HIGH CHANNEL

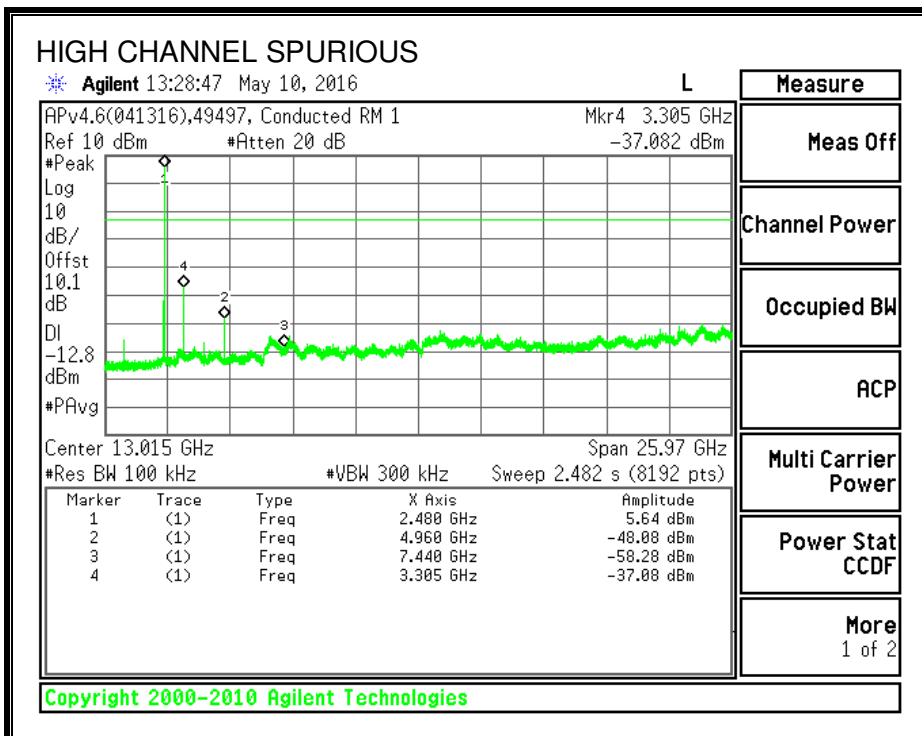
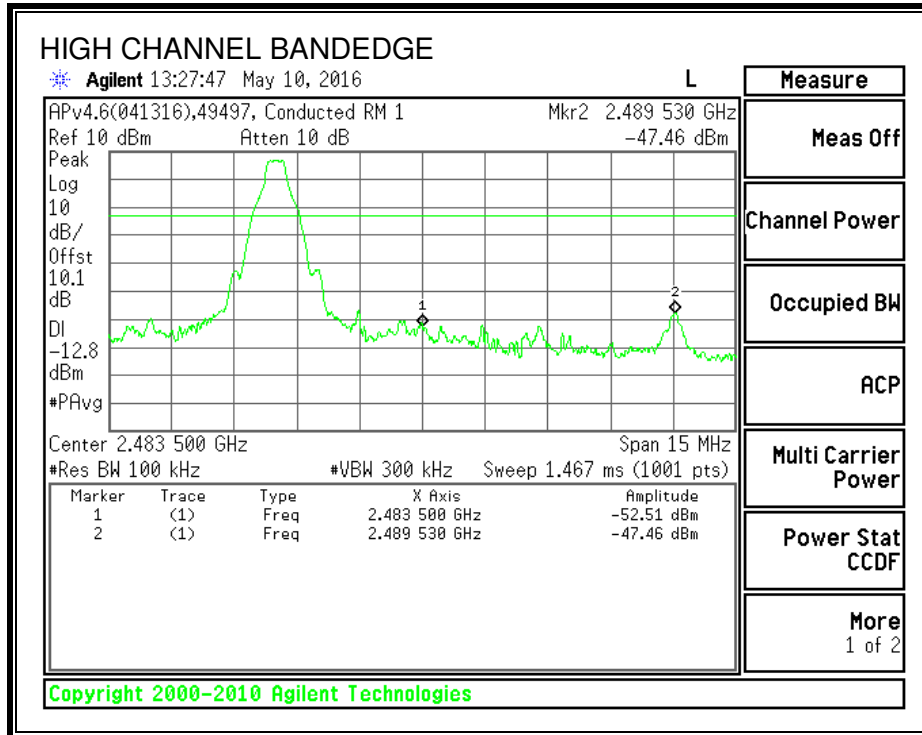

SPURIOUS BANDEGE EMISSIONS WITH HOPPING ON

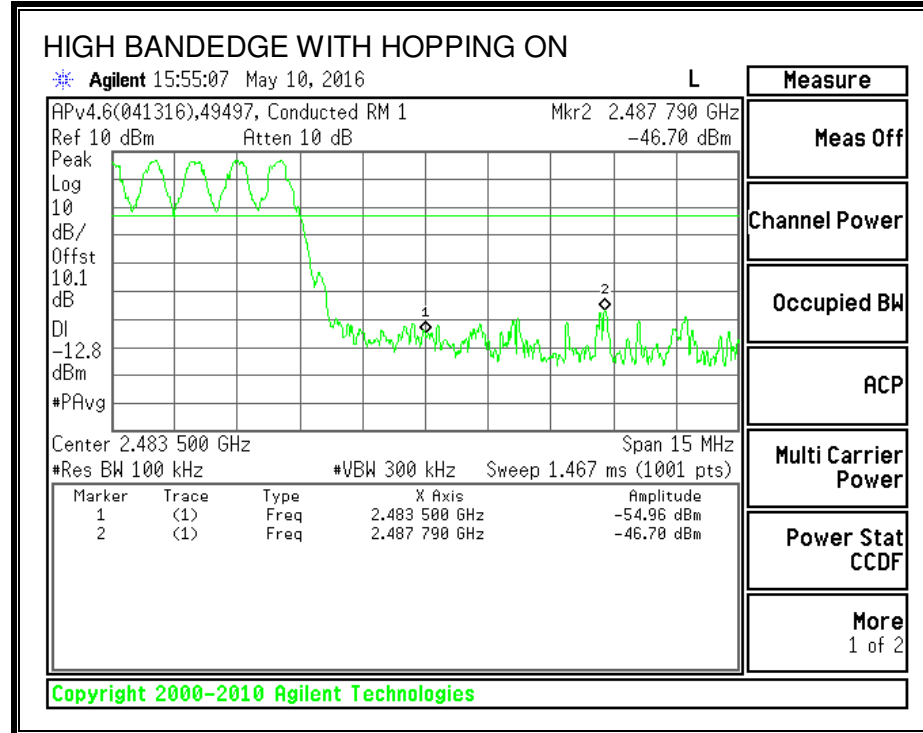
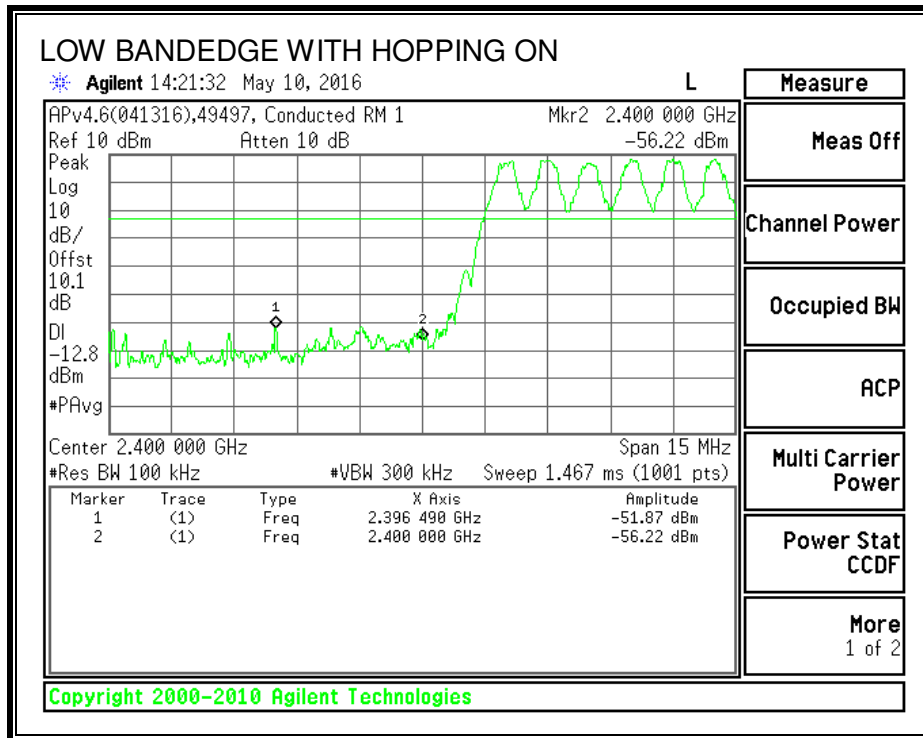

8.3. ENHANCED DATA RATE QPSK MODULATION

8.3.1. 20 dB AND 99% BANDWIDTH

LIMIT

FCC §15.247 (a) (1)

IC RSS-247 5.1 (1)

IC RSS-Gen clause 6.6

None; for reporting purposes only.

TEST PROCEDURE

The transmitter output is connected to a spectrum analyzer. The RBW is set to 1-5% of the 20 dB bandwidth and 99% Occupied Bandwidth. The VBW is set to \geq RBW. The sweep time is coupled.

Test Information

Date: 2016-05-10

Tester: Mark Learner

Channel	Frequency (MHz)	20 dB Bandwidth (kHz)	99% Bandwidth (kHz)
Low	2402	1332	1211.9
Middle	2441	1338	1228.1
High	2480	1326	1212.7

RESULTS

20 dB AND 99% BANDWIDTH

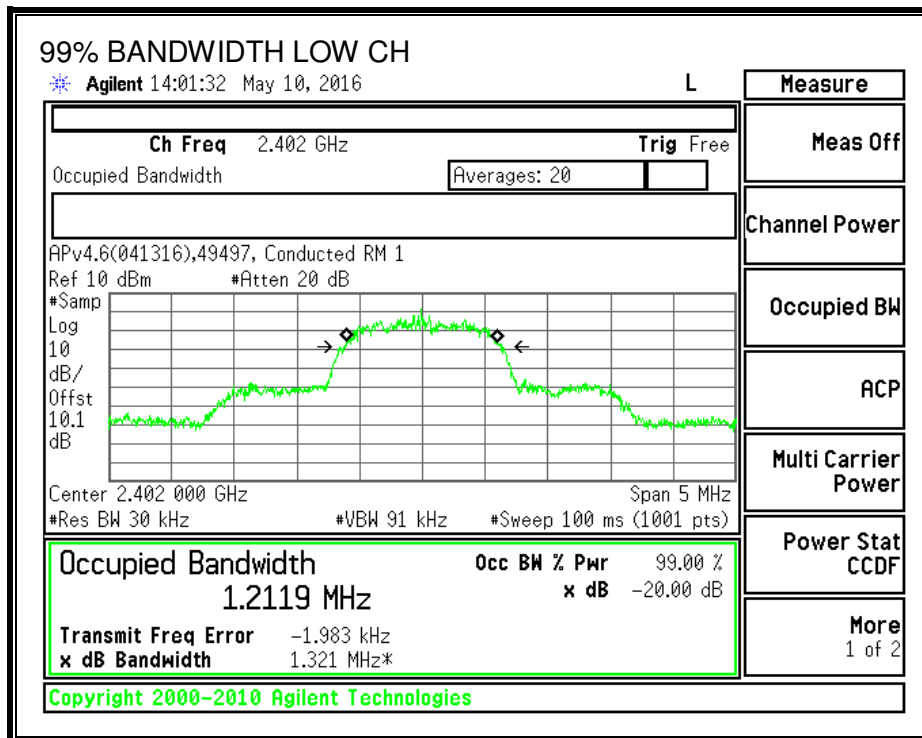
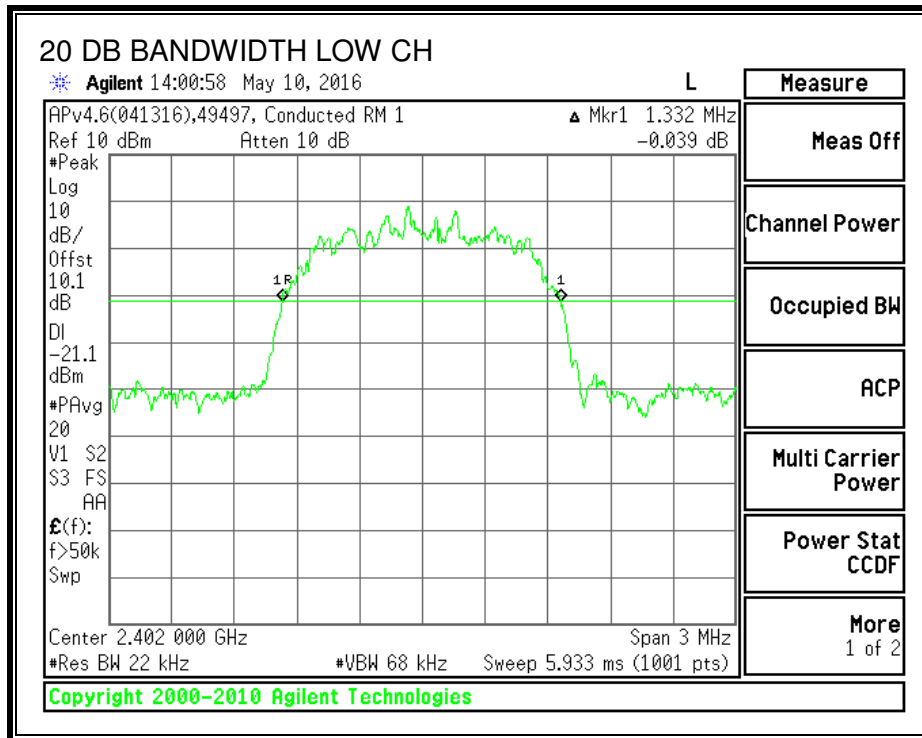

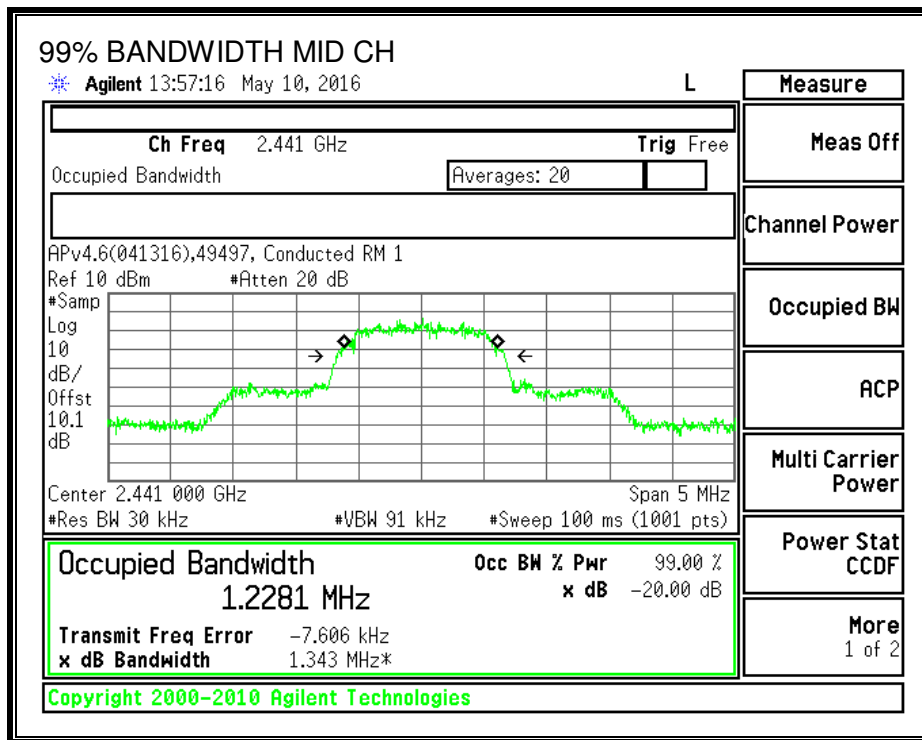
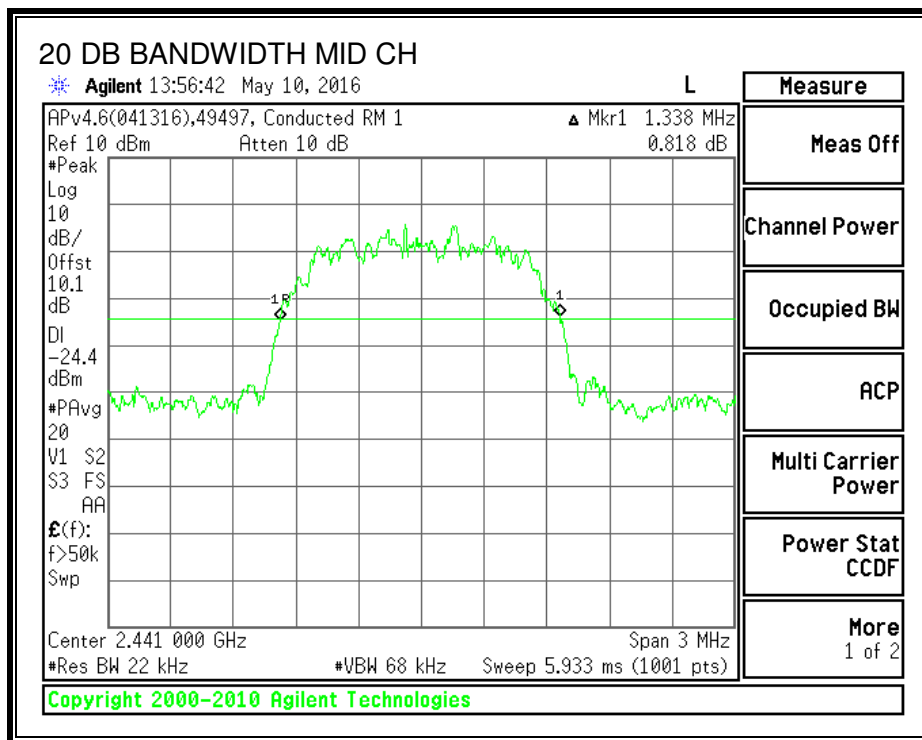

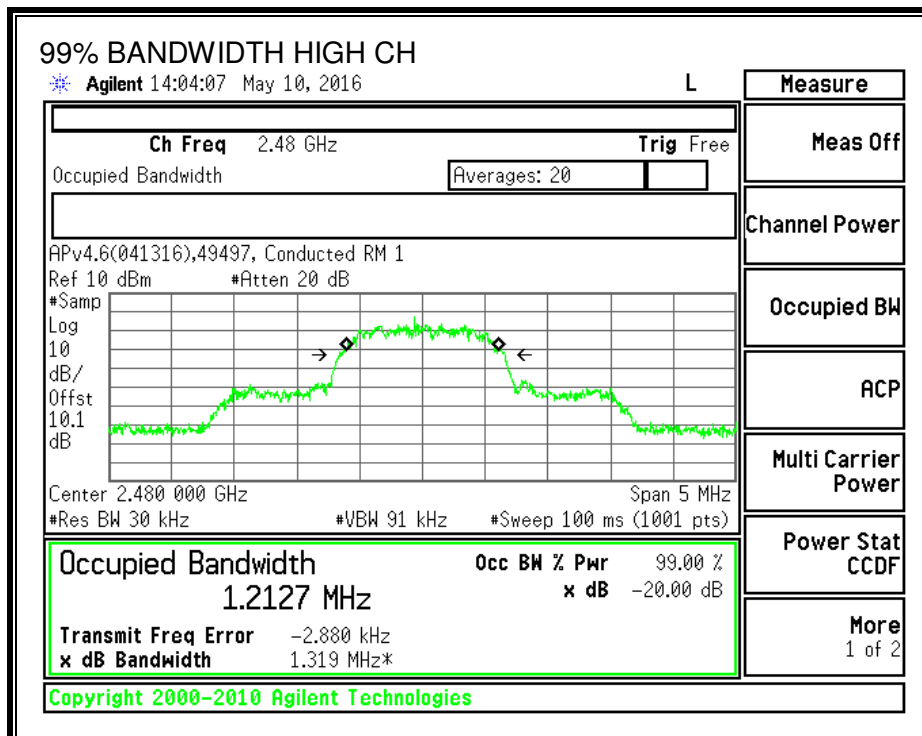
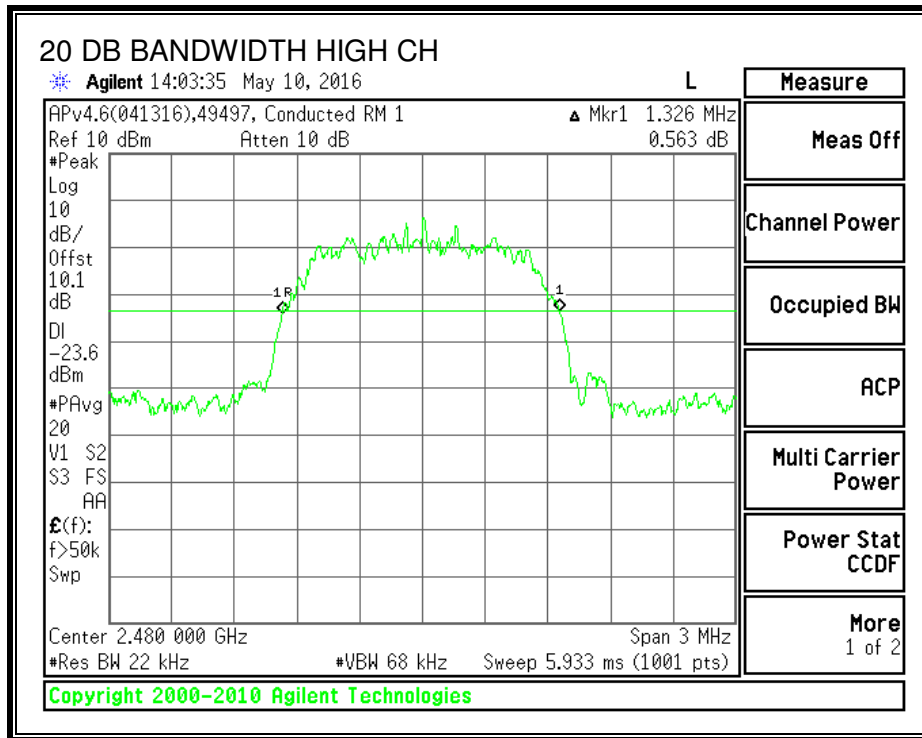

8.3.2. HOPPING FREQUENCY SEPARATION

LIMIT

ANSI C63.10 Section 7.8.2

FCC §15.247 (a) (1)

IC RSS-247 5.1 (2)

Frequency hopping systems shall have hopping channel carrier frequencies separated by a minimum of 25 kHz or the 20 dB bandwidth of the hopping channel, whichever is greater.

Alternatively, frequency hopping systems operating in the 2400-2483.5 MHz band may have hopping channel carrier frequencies that are separated by 25 kHz or two-thirds of the 20 dB bandwidth of the hopping channel, whichever is greater, provided the systems operate with an output power no greater than 125 mW.

TEST PROCEDURE

The transmitter output is connected to a spectrum analyzer. The RBW is set to 300 kHz and the VBW is set to 3x RBW. The sweep time is coupled.

Test Information

Date: 2016-05-10

Tester: Mark Learner

RESULTS

Channel 1 (MHz)	Channel 2 (MHz)	Channel Separation (MHz)	2/3 of 20dB BW (MHz)	Margin (MHz)
2441	2442	1	0.892	-0.108

HOPPING FREQUENCY SEPARATION

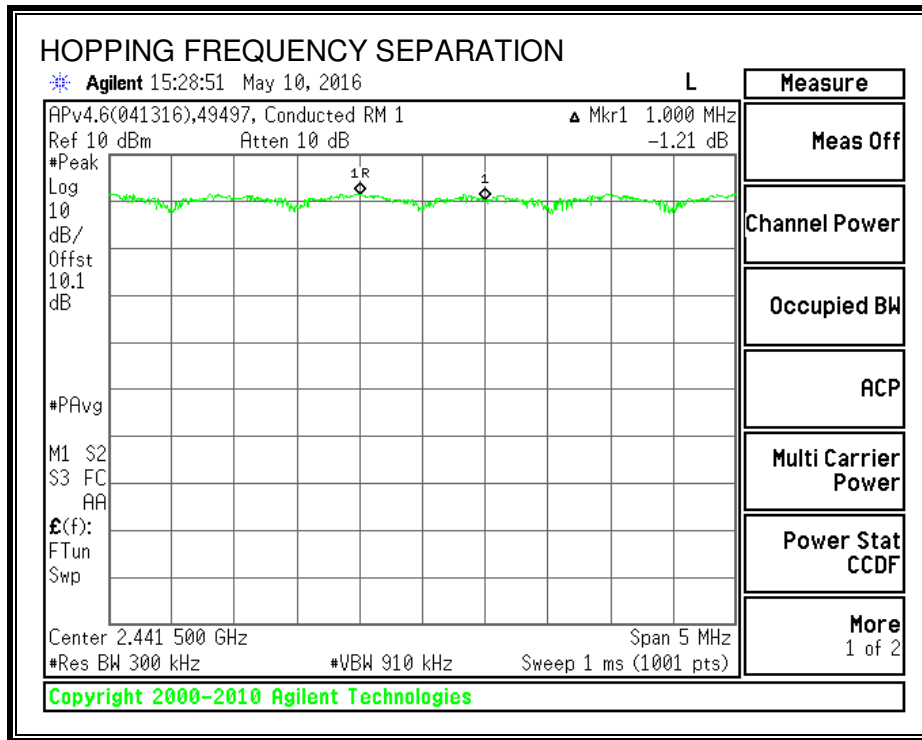

Note – The channel hopping separation of 1MHz is less than the 20 dB bandwidth (approx. 1.3 MHz). However, the output power is less than 125 mW and the channel separation is greater than 2/3 the 20 dB bandwidth (approx. 875 kHz).

8.3.3. NUMBER OF HOPPING CHANNELS

LIMIT

ANSI C63.10 Section 7.8.3

FCC §15.247 (a) (1) (iii)

IC RSS-247 5.1 (4)

Frequency hopping systems in the 2400 – 2483.5 MHz band shall use at least 15 non-overlapping channels.

TEST PROCEDURE

The transmitter output is connected to a spectrum analyzer. The span is set to cover the entire authorized band, in either a single sweep or in multiple contiguous sweeps for visibility of the entire span. Then, smaller spans are set to more clearly identify the channels. The RBW is set to 30% of the channel spacing (approx. 300 kHz). The analyzer is set to Max Hold.

Test Information

Date: 2016-05-10

Tester: Mark Learner

RESULTS

Normal Mode: 79 Channels observed.

AFH Mode: min of 20 Channels declared.

NUMBER OF HOPPING CHANNELS

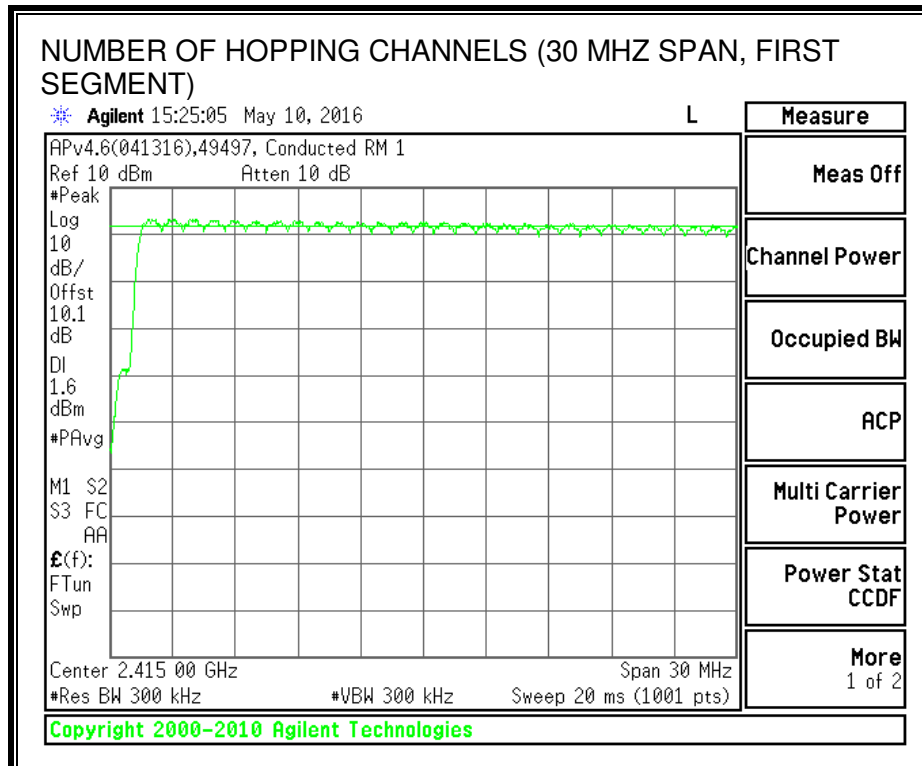
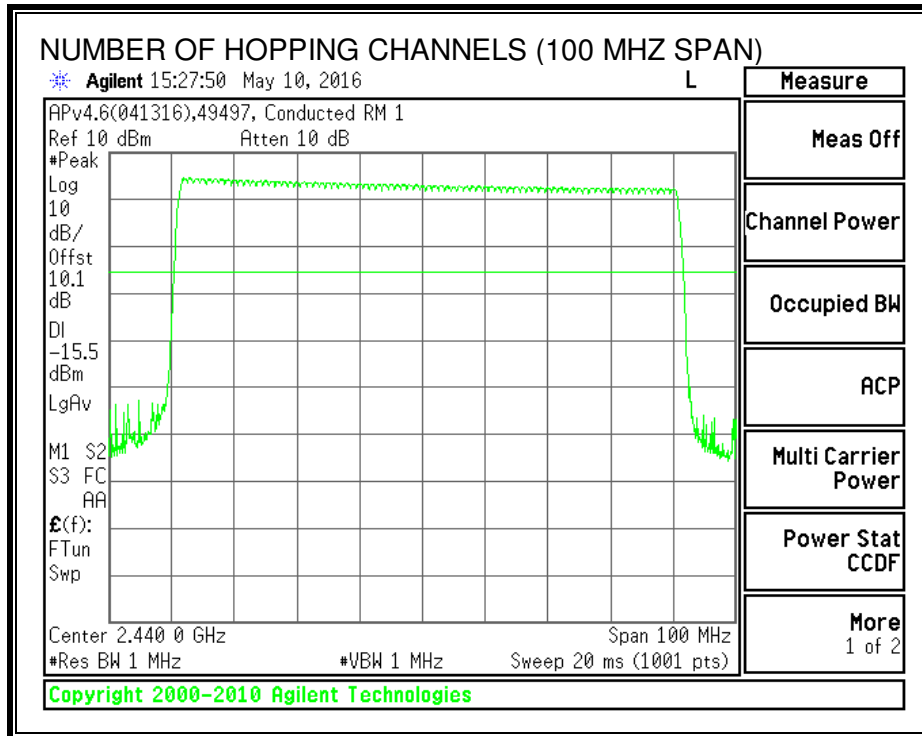

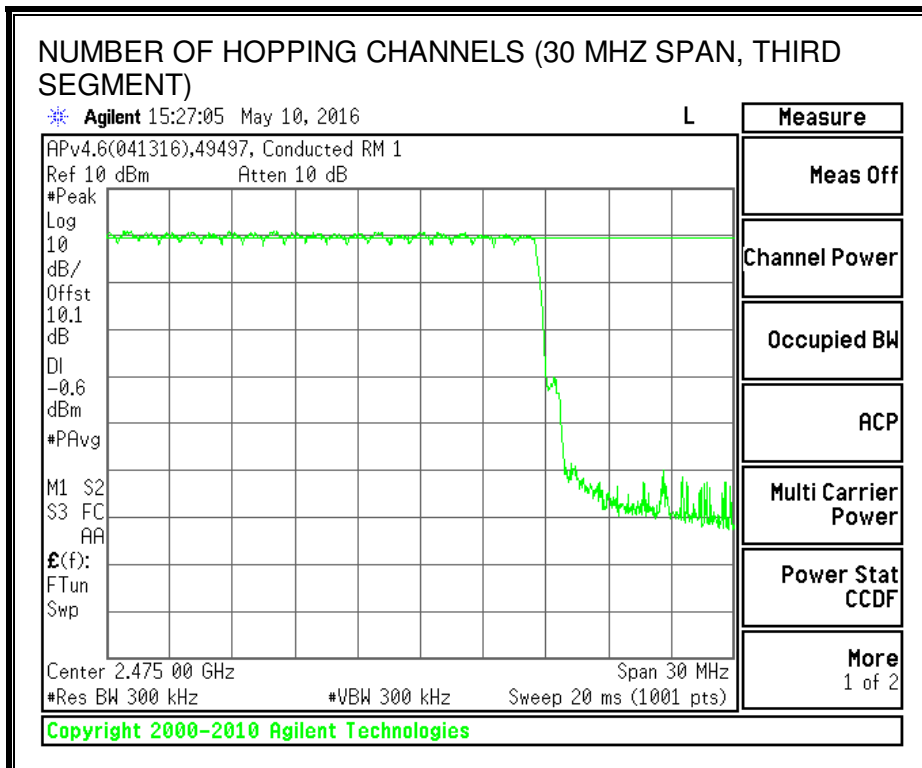
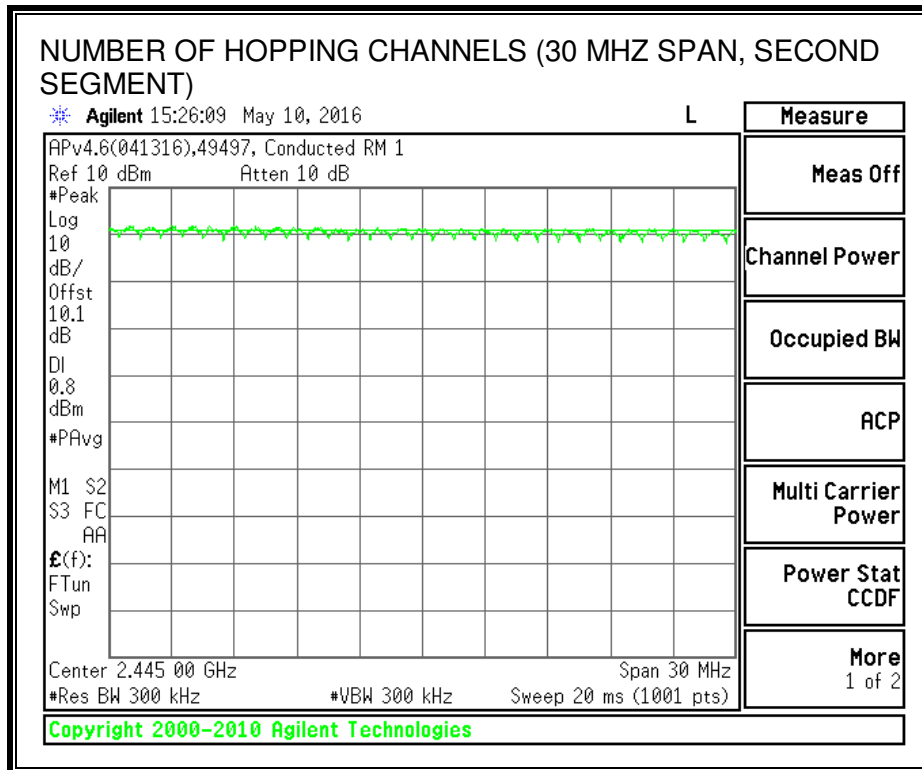

8.3.4. AVERAGE TIME OF OCCUPANCY

LIMIT

ANSI C63.10 Section 7.8.4

FCC §15.247 (a) (1) (iii)

IC RSS-247 5.1 (4)

The average time of occupancy on any channel shall not be greater than 0.4 seconds within a period of 0.4 seconds multiplied by the number of hopping channels employed.

TEST PROCEDURE

The transmitter output is connected to a spectrum analyzer. The span is set to 0 Hz, centered on a single, selected hopping channel. The width of a single pulse is measured in a fast scan. The number of pulses is measured in a 3.16 second scan, to enable resolution of each occurrence.

The average time of occupancy in the specified 31.6 second period (79 channels * 0.4 s) is equal to $10 * (\# \text{ of pulses in } 3.16 \text{ s}) * \text{ pulse width}$.

Test Information

Date: 2016-05-10

Tester: Mark Learner

RESULTS

DQPSK Mode

DH Packet	Pulse Width (msec)	Number of Pulses in 3.16 seconds	Average Time of (sec)	Limit (sec)	Margin (sec)
DH1	0.407	31	0.126	0.4	-0.274
DH3	1.658	18	0.298	0.4	-0.102
DH5	2.904	9	0.261	0.4	-0.139

Note: for AFH (DQPSK) mode, please refer to the results of AFH (GFSK) mode; the channel selection and hopping rate are the same for both EDR and Basic Rate operation, data for Basic Rate on page 27 demonstrates compliance with channel occupancy when AFH is employed.

PULSE WIDTH - DH1

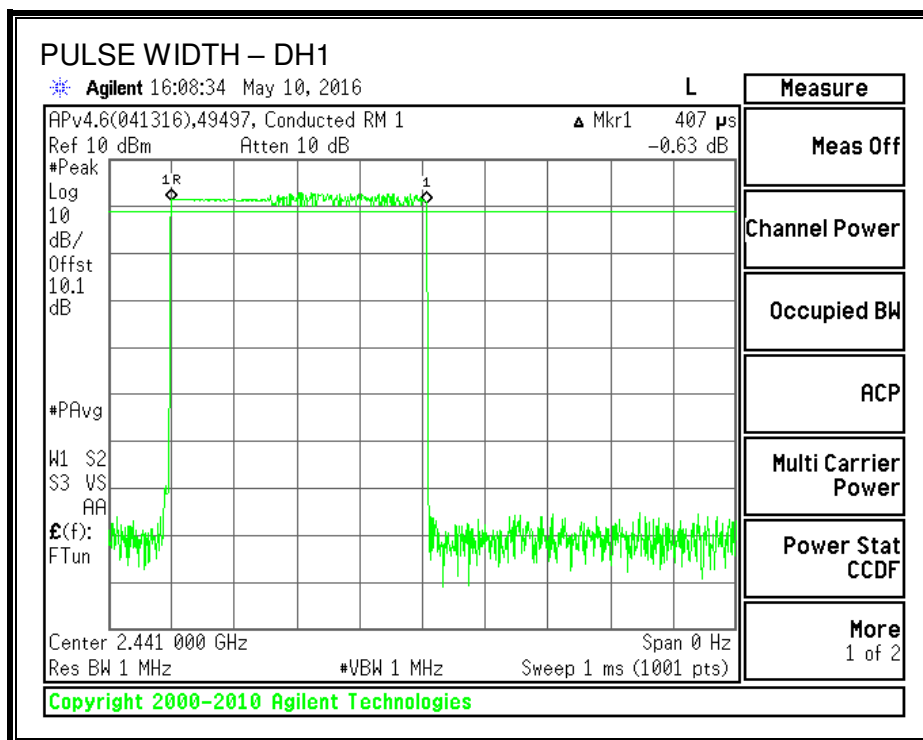

NUMBER OF PULSES IN 3.16 SECOND OBSERVATION PERIOD – DH1

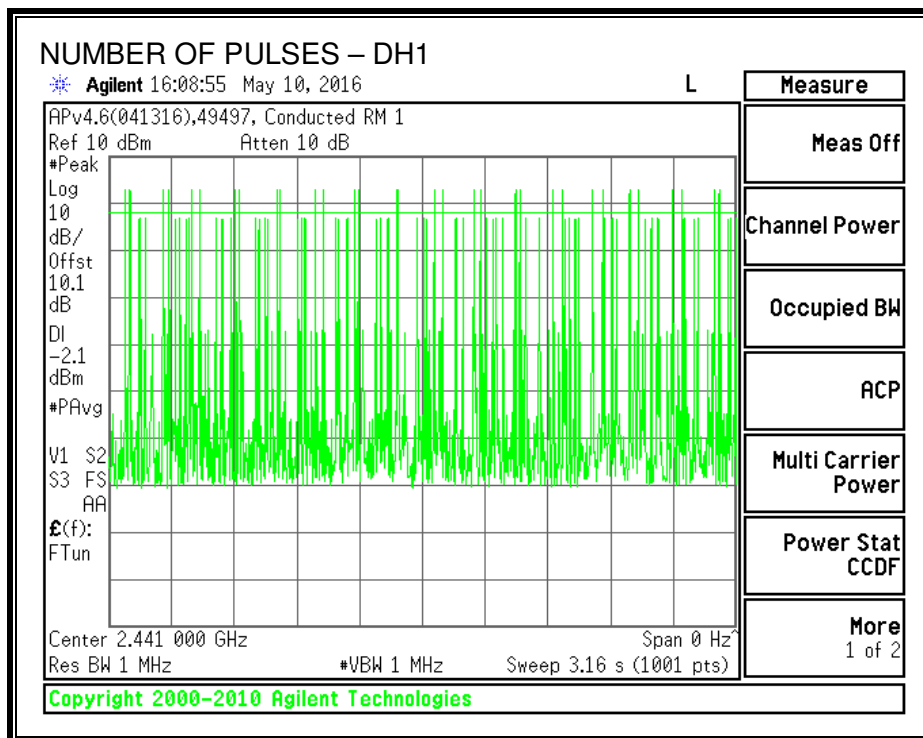

PULSE WIDTH – DH3

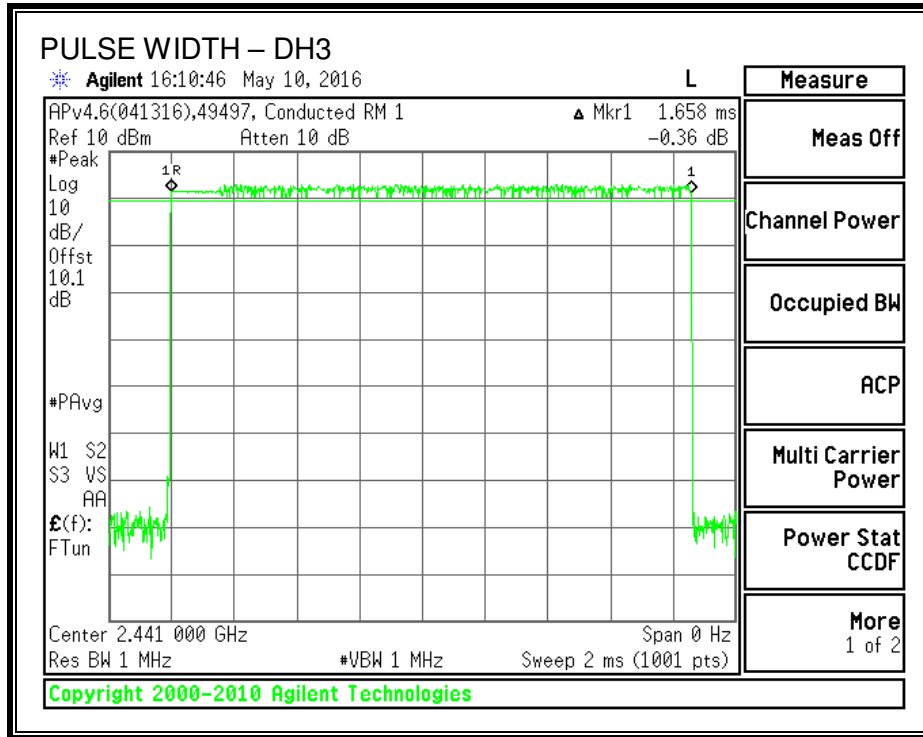

NUMBER OF PULSES IN 3.16 SECOND OBSERVATION PERIOD – DH3

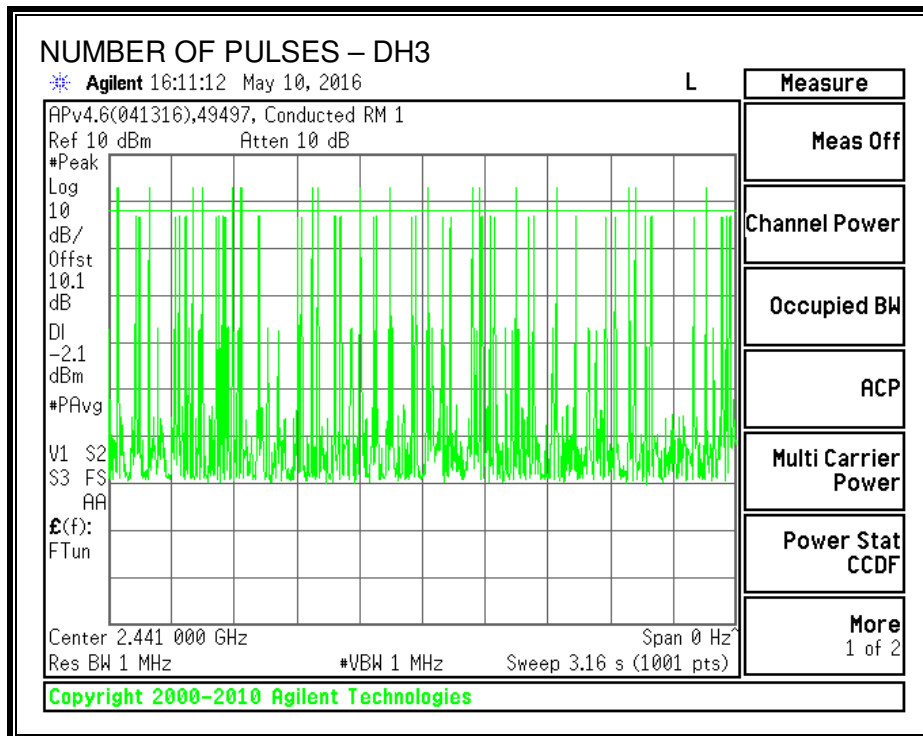

PULSE WIDTH – DH5

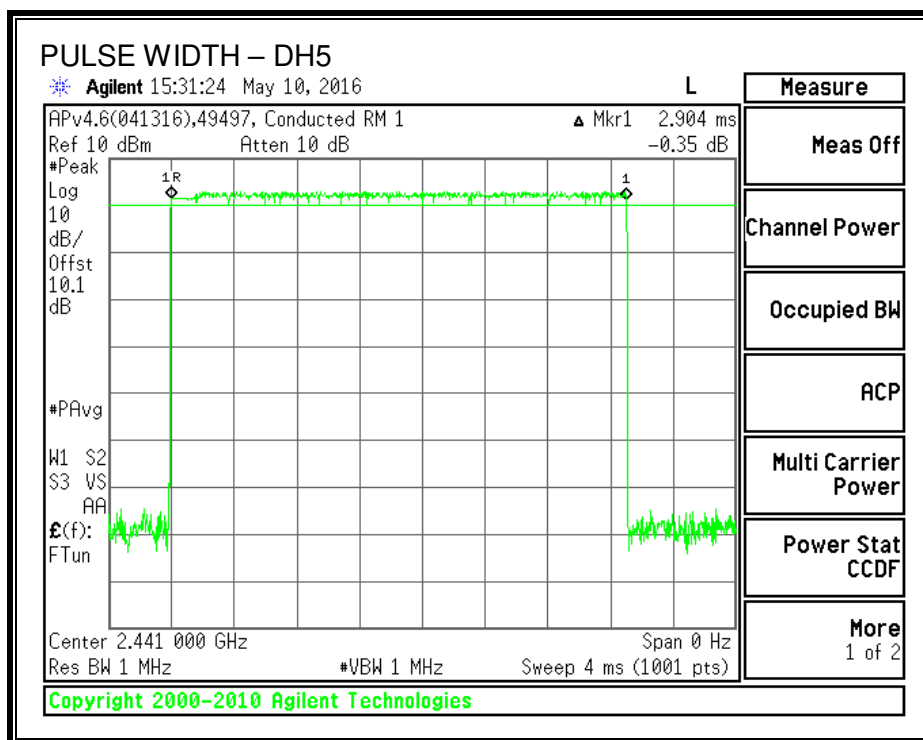

NUMBER OF PULSES IN 3.16 SECOND OBSERVATION PERIOD – DH5

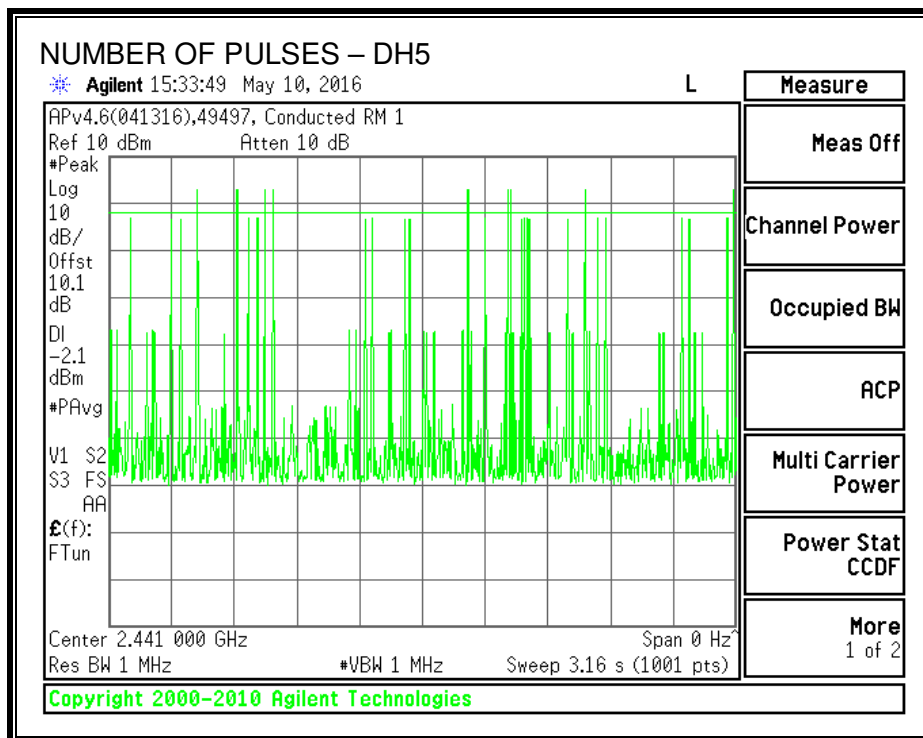

8.3.5. OUTPUT POWER

LIMIT

ANSI C63.10 Section 7.8.5

§15.247 (b) (1)

For frequency hopping systems operating in the 2400-2483.5 MHz band employing at least 75 non-overlapping hopping channels, and all frequency hopping systems in the 5725-5850 MHz band: 1 watt. For all other frequency hopping systems in the 2400-2483.5 MHz band: 0.125 watts.

RSS-247 Clause 5.4 (2)

For frequency hopping systems operating in the band 2400-2483.5 MHz and employing at least 75 hopping channels, the maximum peak conducted output power shall not exceed 1 W; for all other frequency hopping systems in the band, the maximum peak conducted output power shall not exceed 0.125 W.

TEST PROCEDURE

The transmitter output was connected to a power meter equipped with a power sensor capable of measuring peak power. The cable assembly insertion loss of 10.1 dB (including 10 dB pad and 0.1dB cable) was entered as an offset in the power meter to allow for direct reading of power.

Test Information

Date: 2016-05-10

Tester: Mark Learner

RESULTS

Note: For DQPSK mode, the channel separation was limited to 2/3 the 20 dB bandwidth. Therefore, the output power was limited to 125 mW.

The following is peak power:

Channel	Frequency (MHz)	Output Power (dBm)	Directional Gain (dBi)	Limit (dBm)	Margin (dB)
Low	2402	5.10	2.50	21	-15.90
Middle	2441	3.52	2.50	21	-17.48
High	2480	2.89	2.50	21	-18.11

8.3.6. AVERAGE POWER

LIMIT

None; for reporting purposes only.

TEST PROCEDURE

The transmitter output is connected to a power meter.

Test Information

Date: 2016-05-10

Tester: Mark Learner

RESULTS

The cable assembly insertion loss of 10.1 dB (including 10 dB pad and 0.1 dB cable) was entered as an offset in the power meter to allow for direct reading of power.

Channel	Frequency (MHz)	Average Power (dBm)
Low	2402	2.75
Middle	2441	0.99
High	2480	0.16

8.4. ENHANCED DATA RATE 8PSK MODULATION

8.4.1. 20 dB AND 99% BANDWIDTH

LIMIT

FCC §15.247 (a) (1)

IC RSS-247 5.1 (1)

IC RSS-Gen clause 6.6

None; for reporting purposes only.

TEST PROCEDURE

The transmitter output is connected to a spectrum analyzer. The RBW is set to 1-5% of the 20 dB bandwidth and 99% Occupied Bandwidth. The VBW is set to \geq RBW. The sweep time is coupled.

Test Information

Date: 2016-05-10

Tester: Mark Learner

RESULTS

Channel	Frequency (MHz)	20 dB Bandwidth (kHz)	99% Bandwidth (kHz)
Low	2402	1254	1210.5
Middle	2441	1260	1209.5
High	2480	1248	1199.8

20 dB AND 99% BANDWIDTH

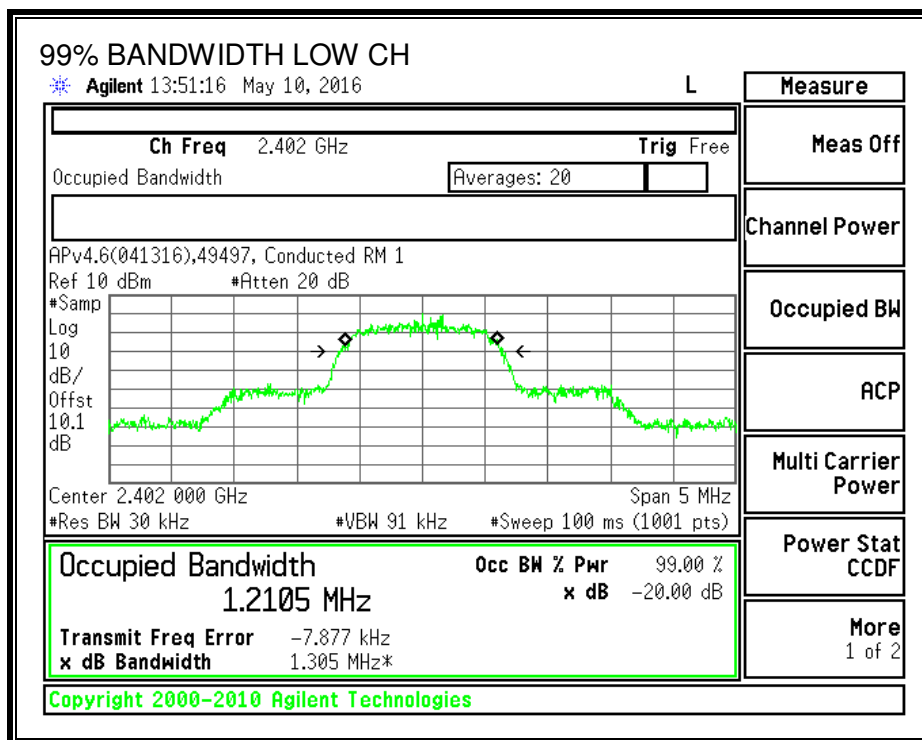
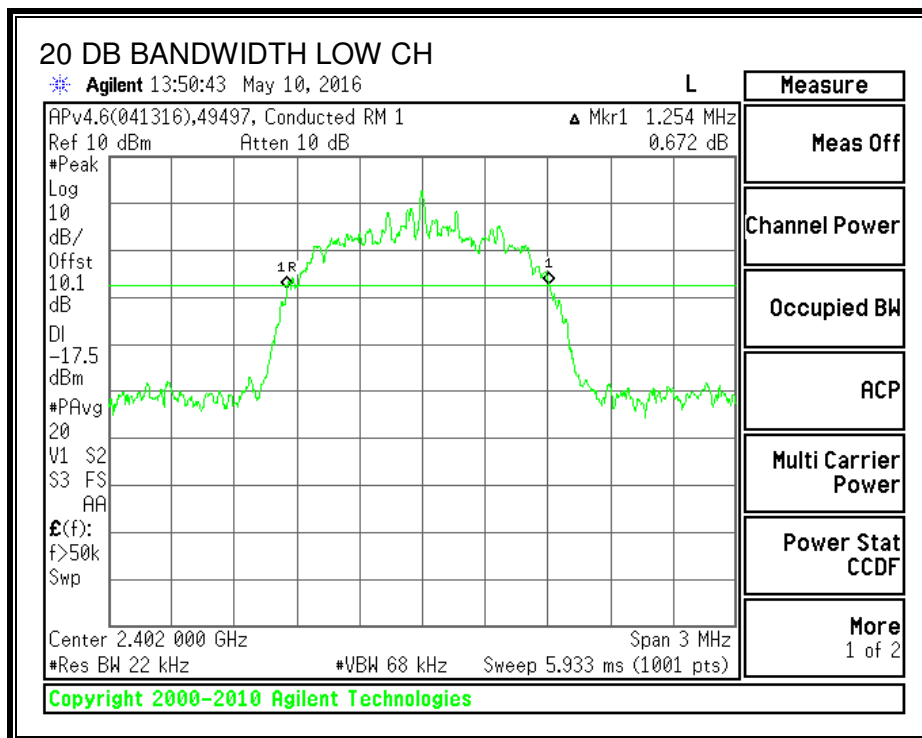

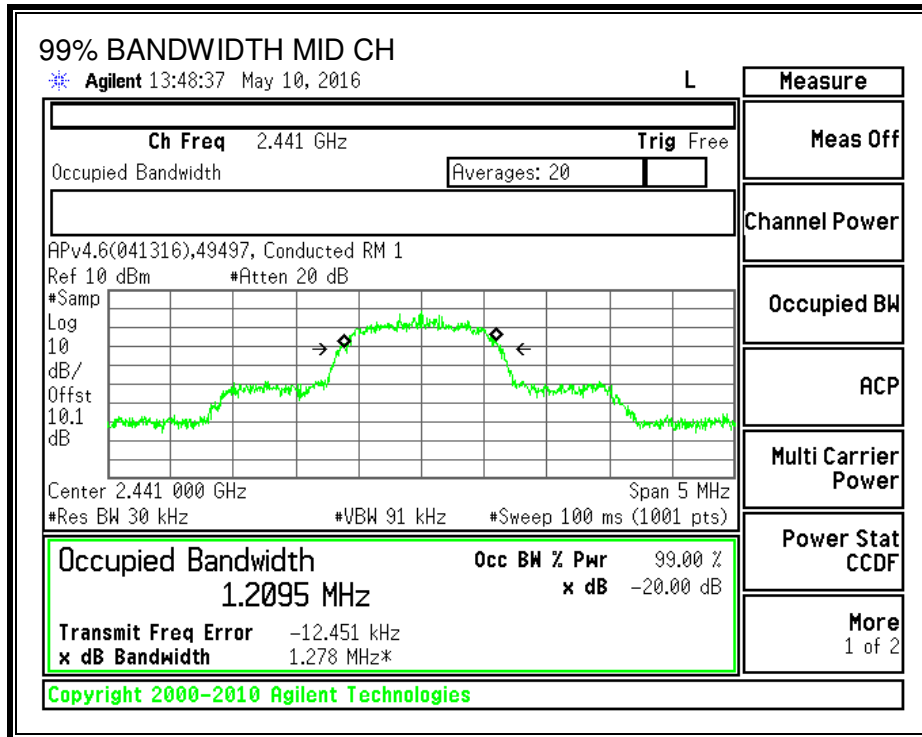
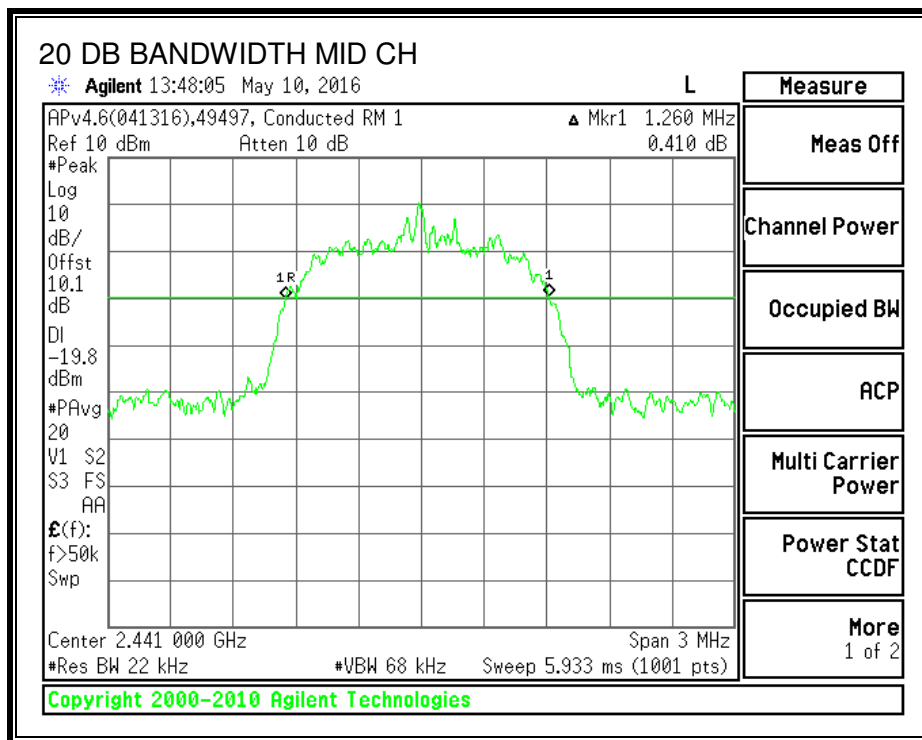

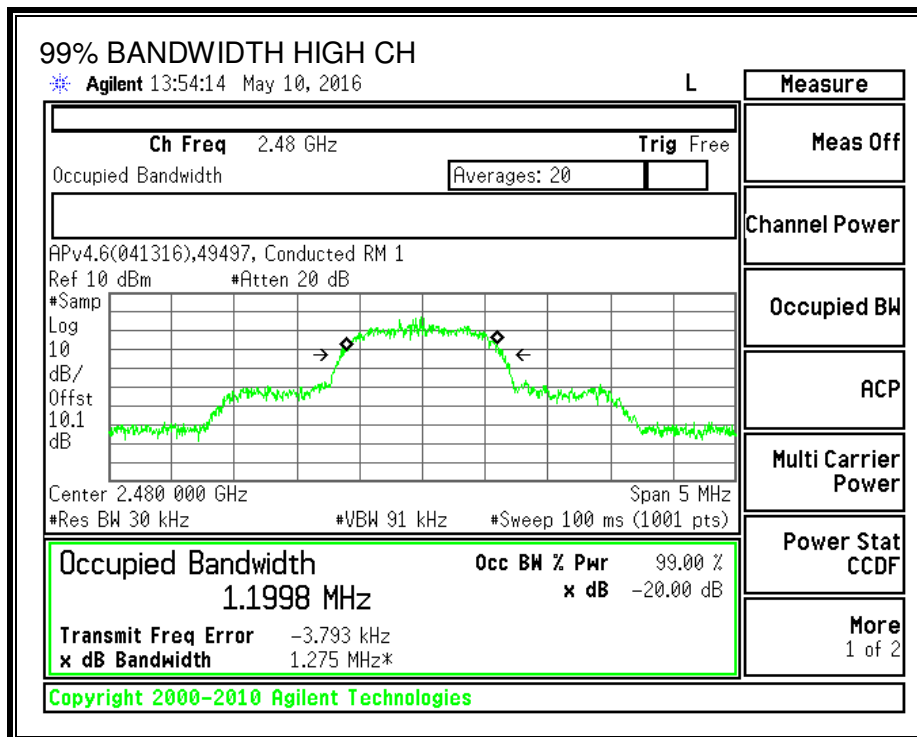
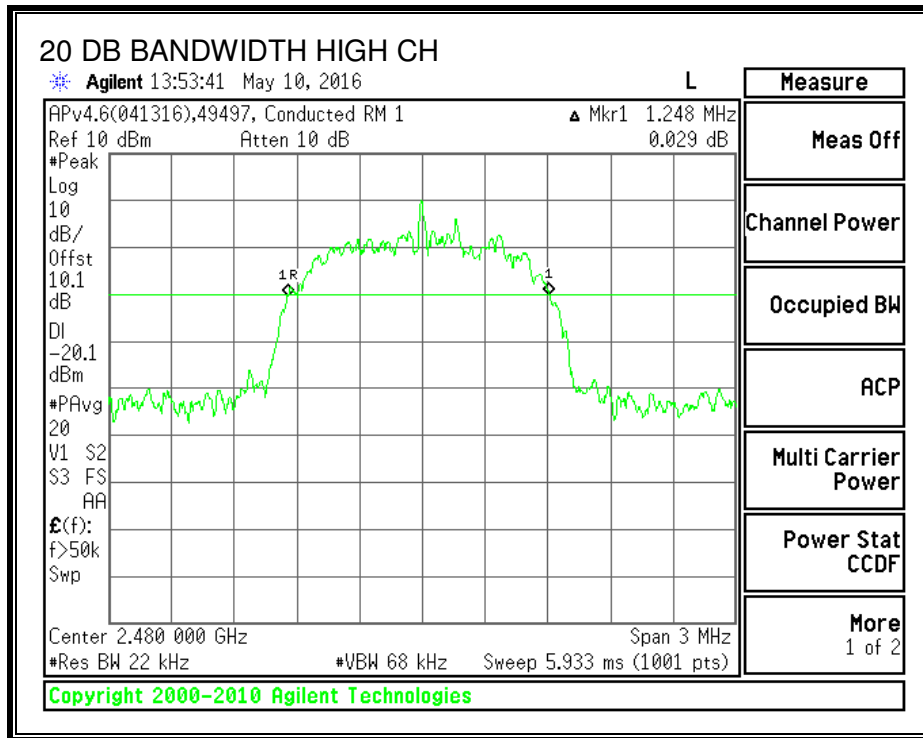

8.4.2. HOPPING FREQUENCY SEPARATION

LIMIT

ANSI C63.10 Section 7.8.2

FCC §15.247 (a) (1)

IC RSS-247 5.1 (2)

Frequency hopping systems shall have hopping channel carrier frequencies separated by a minimum of 25 kHz or the 20 dB bandwidth of the hopping channel, whichever is greater.

Alternatively, frequency hopping systems operating in the 2400-2483.5 MHz band may have hopping channel carrier frequencies that are separated by 25 kHz or two-thirds of the 20 dB bandwidth of the hopping channel, whichever is greater, provided the systems operate with an output power no greater than 125 mW.

TEST PROCEDURE

The transmitter output is connected to a spectrum analyzer. The RBW is set to 300 kHz and the VBW is set to 3x RBW. The sweep time is coupled.

Test Information

Date: 2016-05-10

Tester: Mark Learner

RESULTS

Channel 1 (MHz)	Channel 2 (MHz)	Channel Separation (MHz)	2/3 of 20dB BW (MHz)	Margin (MHz)
2441	2442	1	0.84	-0.16

HOPPING FREQUENCY SEPARATION

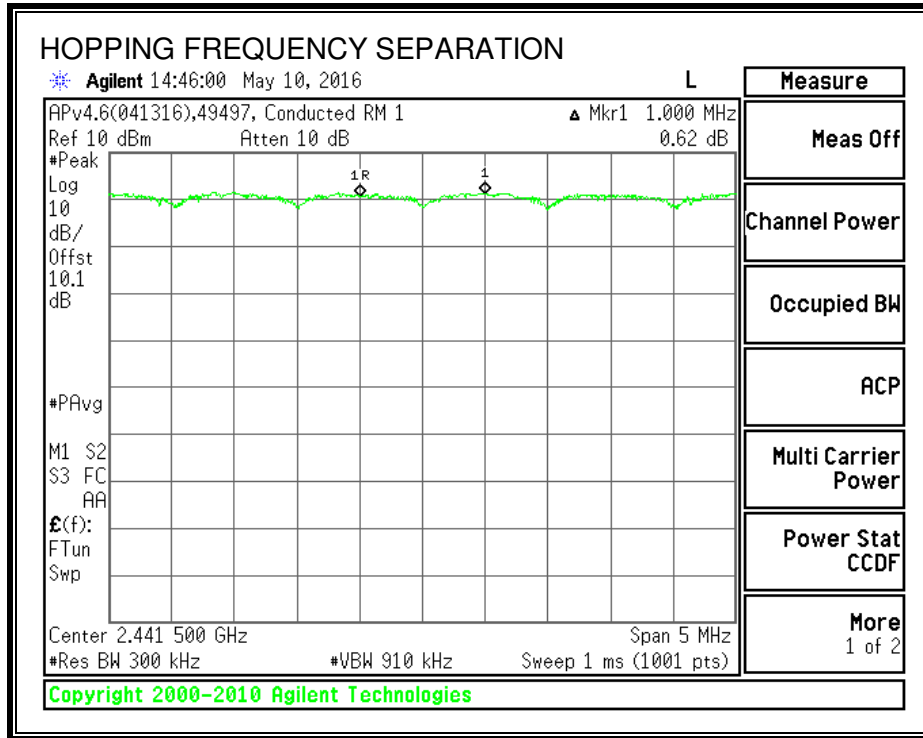

Note – The channel hopping separation of 1MHz is less than the 20 dB bandwidth (approx. 1.3 MHz). However, the output power is less than 125 mW and the channel separation is greater than 2/3 the 20 dB bandwidth (approx. 875 kHz).

8.4.3. NUMBER OF HOPPING CHANNELS

LIMIT

ANSI C63.10 Section 7.8.3

FCC §15.247 (a) (1) (iii)

IC RSS-247 5.1 (4)

Frequency hopping systems in the 2400 – 2483.5 MHz band shall use at least 15 non-overlapping channels.

TEST PROCEDURE

The transmitter output is connected to a spectrum analyzer. The span is set to cover the entire authorized band, in either a single sweep or in multiple contiguous sweeps for visibility of the entire span. Then, smaller spans are set to more clearly identify the channels. The RBW is set to 30% of the channel spacing (approx. 300 kHz). The analyzer is set to Max Hold.

Test Information

Date: 2016-05-10

Tester: Mark Learner

RESULTS

Normal Mode: 79 Channels observed.

AFH Mode: min of 20 Channels declared

NUMBER OF HOPPING CHANNELS

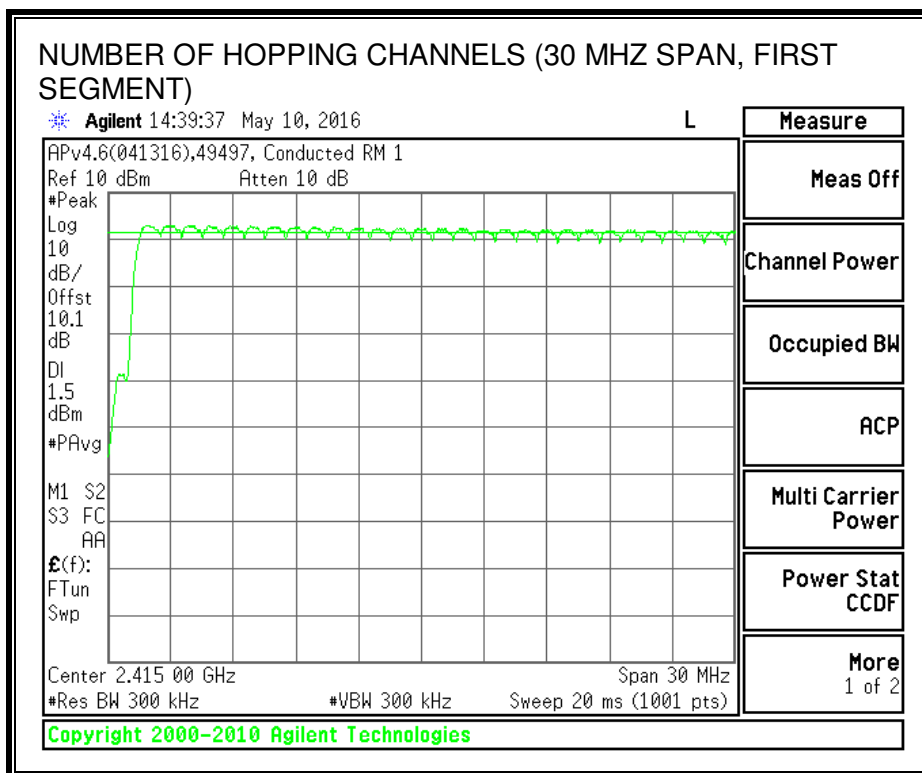
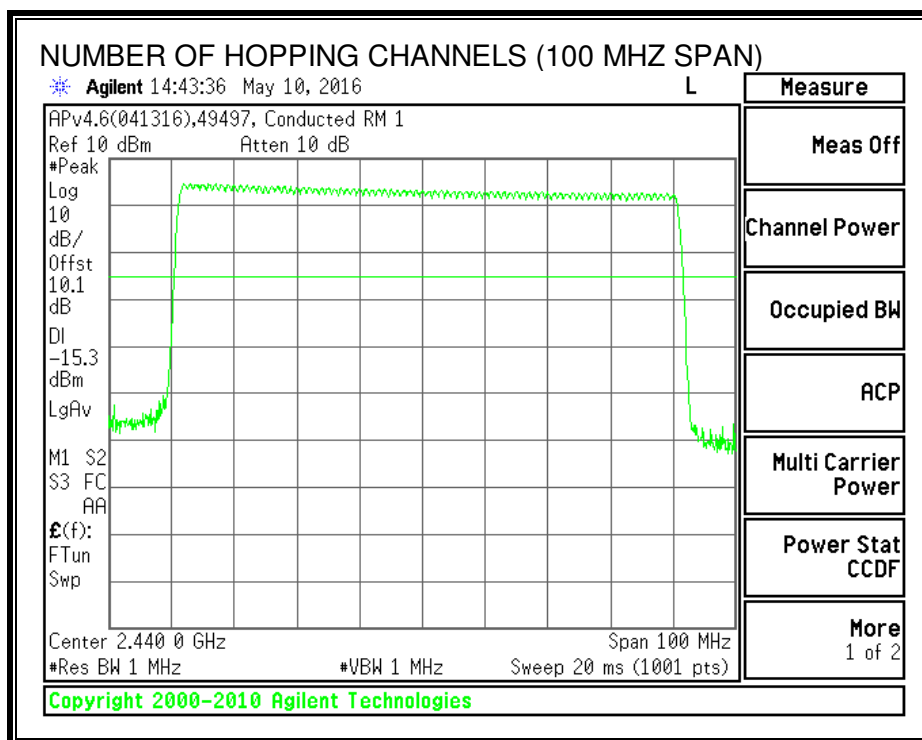

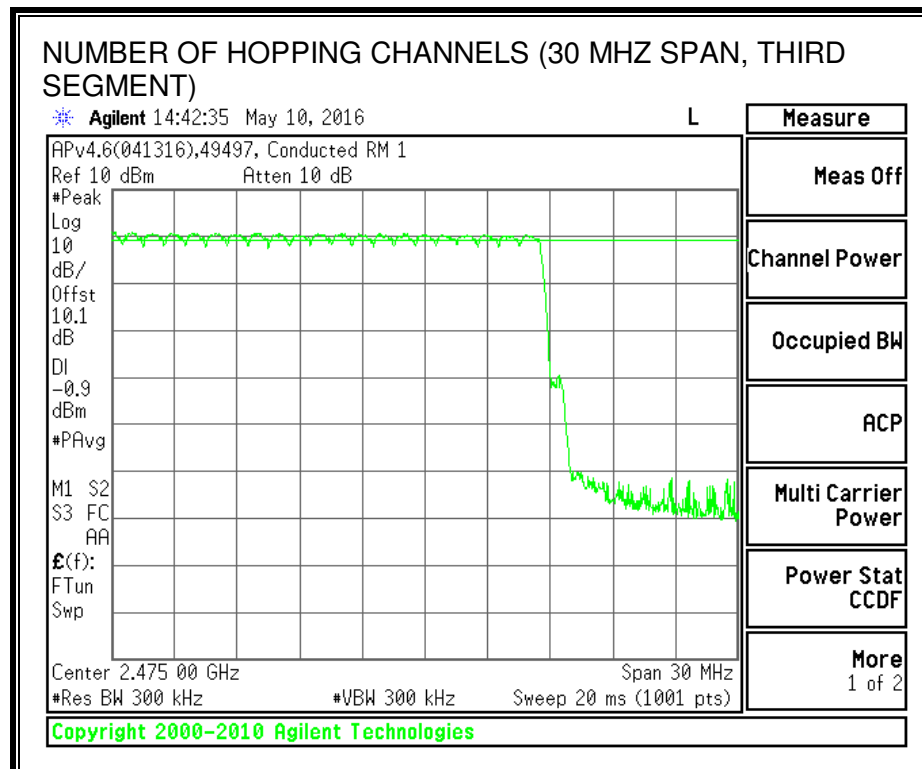
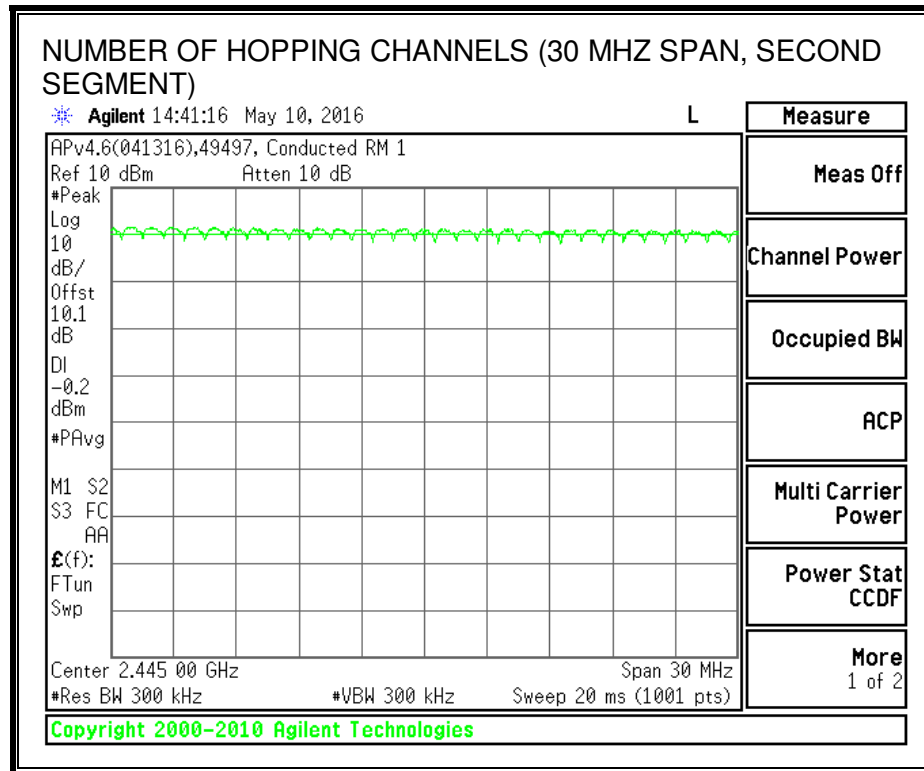

8.4.4. AVERAGE TIME OF OCCUPANCY

LIMIT

ANSI C63.10 Section 7.8.4

FCC §15.247 (a) (1) (iii)

IC RSS-247 5.1 (4)

The average time of occupancy on any channel shall not be greater than 0.4 seconds within a period of 0.4 seconds multiplied by the number of hopping channels employed.

TEST PROCEDURE

The transmitter output is connected to a spectrum analyzer. The span is set to 0 Hz, centered on a single, selected hopping channel. The width of a single pulse is measured in a fast scan. The number of pulses is measured in a 3.16 second scan, to enable resolution of each occurrence.

The average time of occupancy in the specified 31.6 second period (79 channels * 0.4 s) is equal to $10 * (\# \text{ of pulses in } 3.16 \text{ s}) * \text{ pulse width}$.

Test Information

Date: 2016-05-10 and 2016-05-11

Tester: Mark Learner

RESULTS

8PSK (EDR) Mode

DH Packet	Pulse Width (msec)	Number of Pulses in 3.16 seconds	Average Time of (sec)	Limit (sec)	Margin (sec)
DH1	0.406	31	0.126	0.4	-0.274
DH3	1.656	17	0.282	0.4	-0.118
DH5	2.9	13	0.377	0.4	-0.023

PULSE WIDTH - DH1

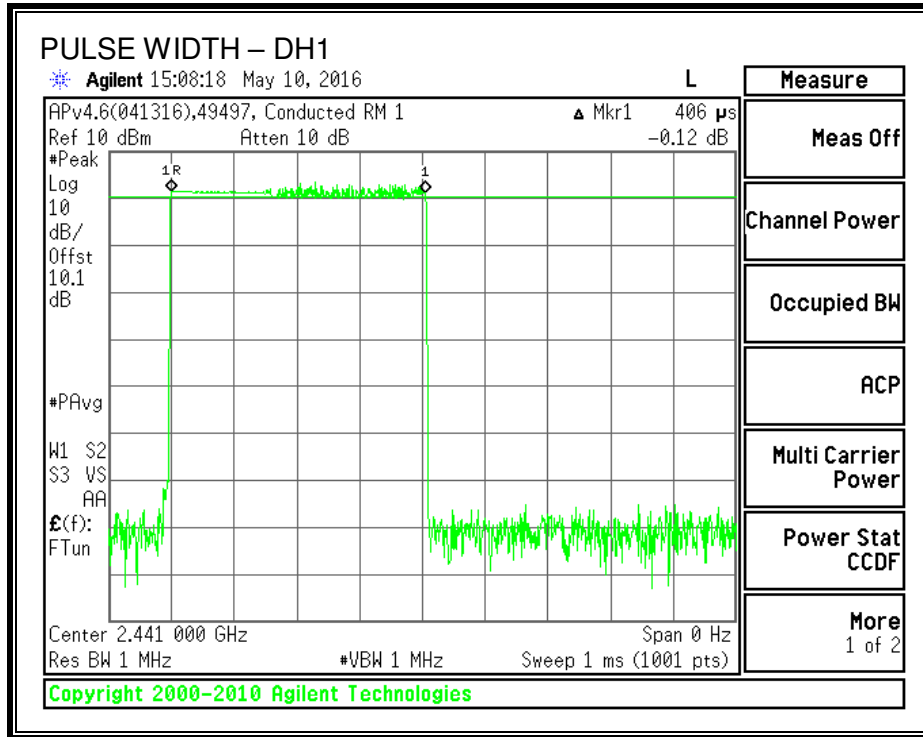

NUMBER OF PULSES IN 3.16 SECOND OBSERVATION PERIOD – DH1

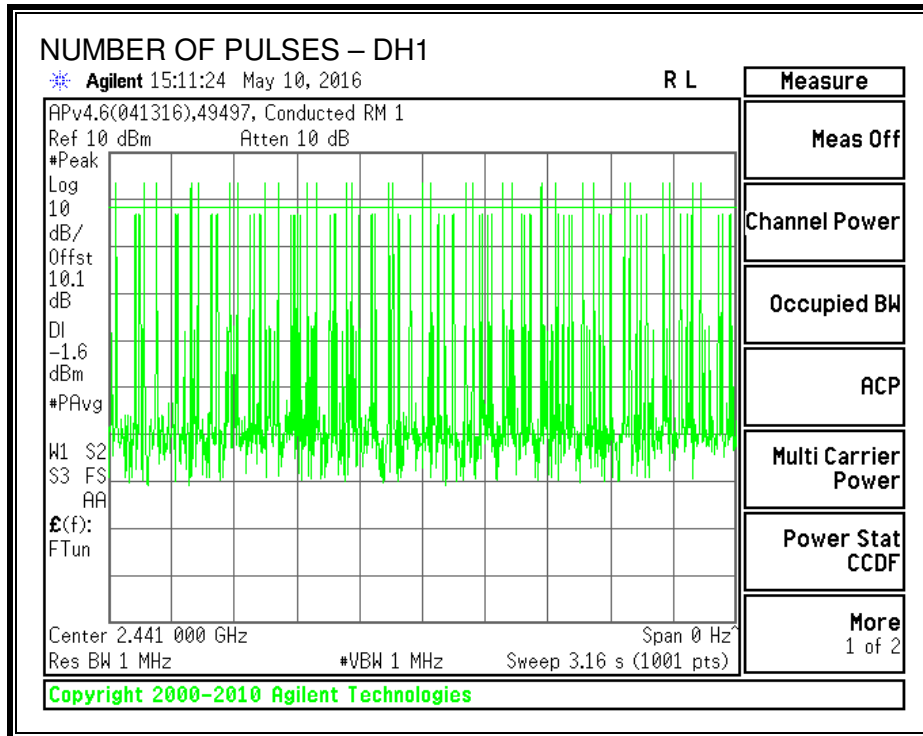

PULSE WIDTH – DH3

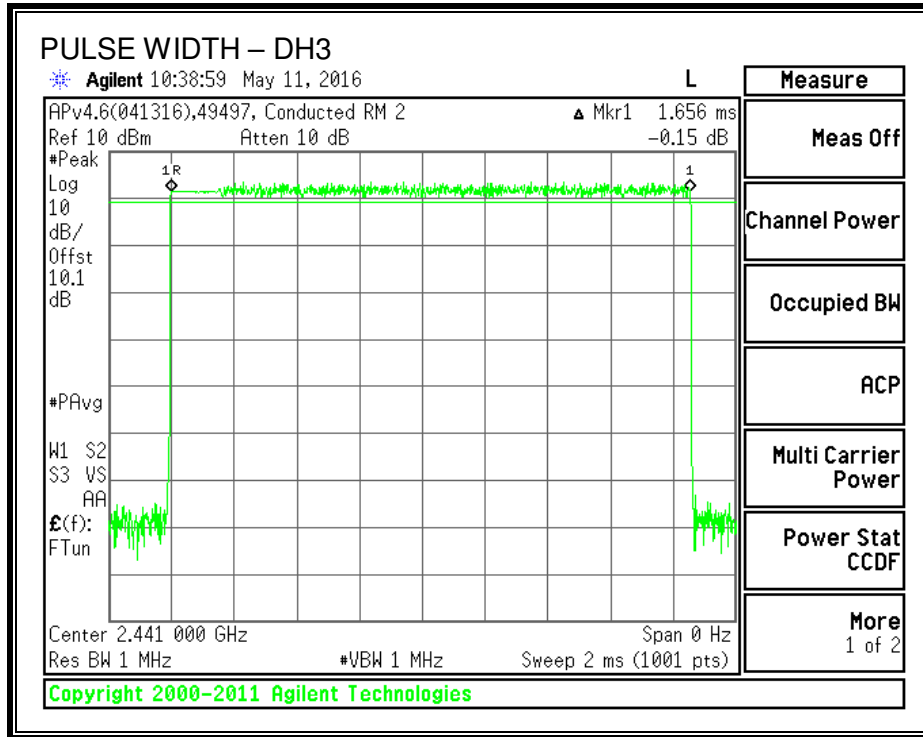

NUMBER OF PULSES IN 3.16 SECOND OBSERVATION PERIOD – DH3

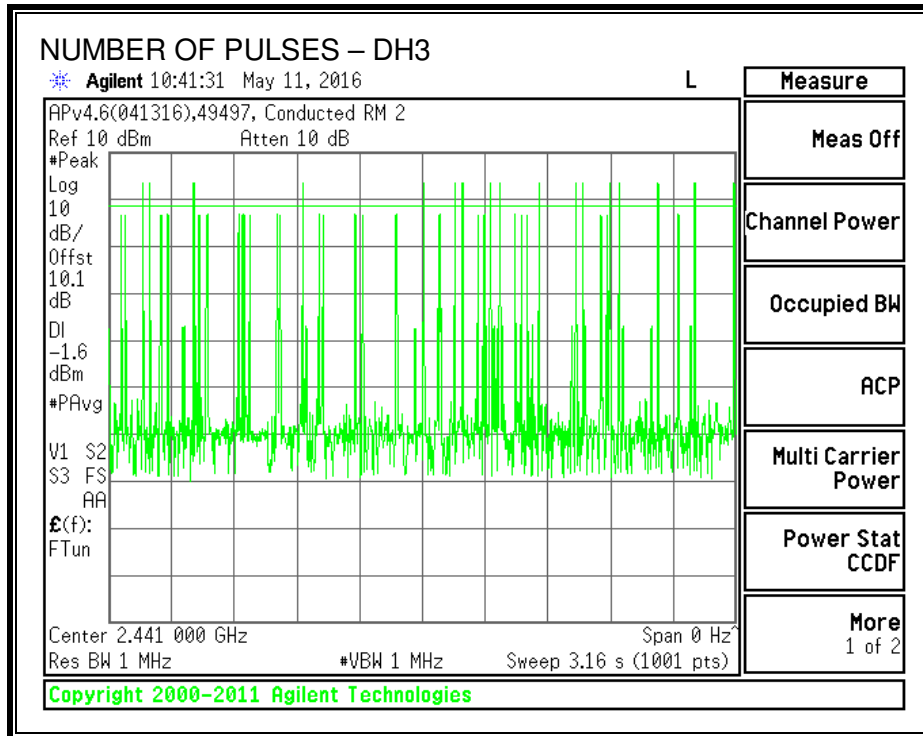

PULSE WIDTH – DH5

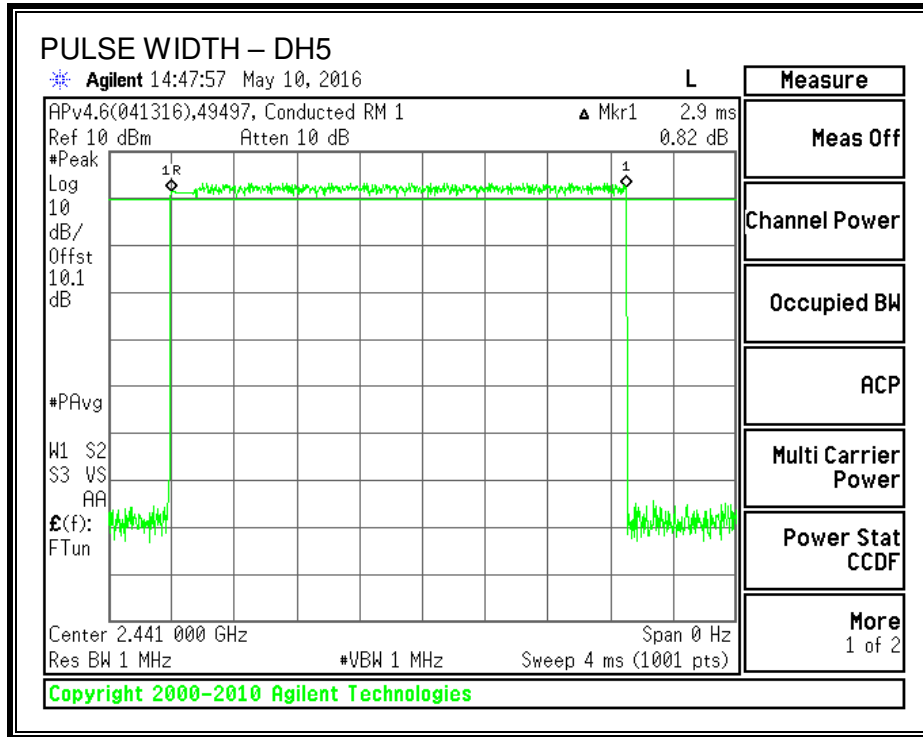

NUMBER OF PULSES IN 3.16 SECOND OBSERVATION PERIOD – DH5

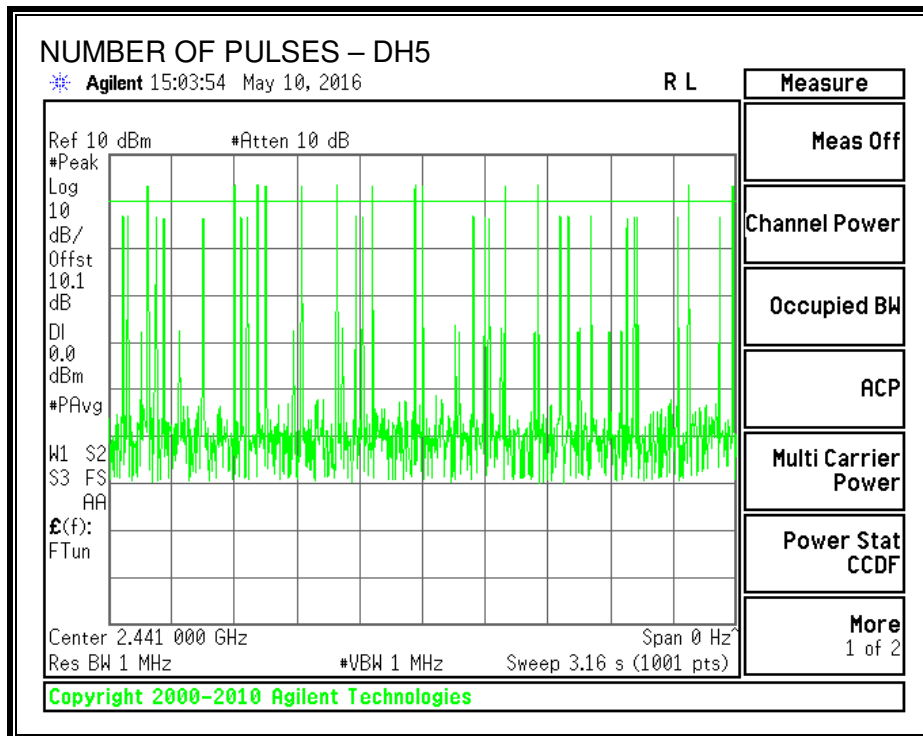

8.4.5. OUTPUT POWER

LIMIT

ANSI C63.10 Section 7.8.5

§15.247 (b) (1)

For frequency hopping systems operating in the 2400-2483.5 MHz band employing at least 75 non-overlapping hopping channels, and all frequency hopping systems in the 5725-5850 MHz band: 1 watt. For all other frequency hopping systems in the 2400-2483.5 MHz band: 0.125 watts.

RSS-247 Clause 5.4 (2)

For frequency hopping systems operating in the band 2400-2483.5 MHz and employing at least 75 hopping channels, the maximum peak conducted output power shall not exceed 1 W; for all other frequency hopping systems in the band, the maximum peak conducted output power shall not exceed 0.125 W.

TEST PROCEDURE

The transmitter output was connected to a power meter equipped with a power sensor capable of measuring peak power. The cable assembly insertion loss of 10.1 dB (including 10 dB pad and 0.1 dB cable) was entered as an offset in the power meter to allow for direct reading of power.

Test Information

Date: 2016-05-10

Tester: Mark Learner

RESULTS

Note: For 8PSK mode, the channel separation was limited to 2/3 the 20 dB bandwidth. Therefore, the output power was limited to 125 mW.

The following is peak power.

Channel	Frequency (MHz)	Output Power (dBm)	Directional Gain (dBi)	Limit (dBm)	Margin (dB)
Low	2402	5.58	2.50	21	-15.42
Middle	2441	4.07	2.50	21	-16.93
High	2480	3.48	2.50	21	-17.52

8.4.6. AVERAGE POWER

LIMIT

None; for reporting purposes only.

TEST PROCEDURE

The transmitter output is connected to a power meter.

Test Information

Date: 2016-05-10

Tester: Mark Learner

RESULTS

The cable assembly insertion loss of 10.1dB (including 10 dB pad and 0.1 dB cable) was entered as an offset in the power meter to allow for direct reading of power.

Channel	Frequency (MHz)	Average Power (dBm)
Low	2402	2.75
Middle	2441	1.00
High	2480	0.16

8.4.7. CONDUCTED SPURIOUS EMISSIONS

LIMITS

ANSI C63.10 Section 7.8.6 and 7.8.8

FCC §15.247 (d)

In any 100 kHz bandwidth outside the frequency band in which the spread spectrum or digitally modulated intentional radiator is operating, the radio frequency power that is produced by the intentional radiator shall be at least 20 dB below that in the 100 kHz bandwidth within the band that contains the highest level of the desired power, based on either an RF conducted or a radiated measurement, provided the transmitter demonstrates compliance with the peak conducted power limits. If the transmitter complies with the conducted power limits based on the use of RMS averaging over a time interval, as permitted under paragraph (b)(3) of this section, the attenuation required under this paragraph shall be 30 dB instead of 20 dB. Attenuation below the general limits specified in §15.209(a) is not required. In addition, radiated emissions which fall in the restricted bands, as defined in §15.205(a), must also comply with the radiated emission limits specified in §15.209(a) (see §15.205(c)).

IC RSS-247 5.5

In any 100 kHz bandwidth outside the frequency band in which the spread spectrum or digitally modulated device is operating, the RF power that is produced shall be at least 20 dB below that in the 100 kHz bandwidth within the band that contains the highest level of the desired power, based on either an RF conducted or a radiated measurement, provided that the transmitter demonstrates compliance with the peak conducted power limits. If the transmitter complies with the conducted power limits based on the use of root-mean-square averaging over a time interval, as permitted under Section A8.4 (4), the attenuation required shall be 30 dB instead of 20 dB. Attenuation below the general field strength limits specified in RSS-Gen is not required.

TEST PROCEDURE

The transmitter output is connected to a spectrum analyzer. The resolution bandwidth is set to 100 kHz. The video bandwidth is set to 300 kHz.

The spectrum from 30 MHz to 26 GHz is investigated with the transmitter set to the lowest, middle, and highest channels.

The bandedges at 2.4 and 2.4835 GHz are investigated with the transmitter set to the normal hopping mode.

Test Information

Date: 2016-05-10

Tester: Mark Learner

RESULTS
SPURIOUS EMISSIONS, LOW CHANNEL

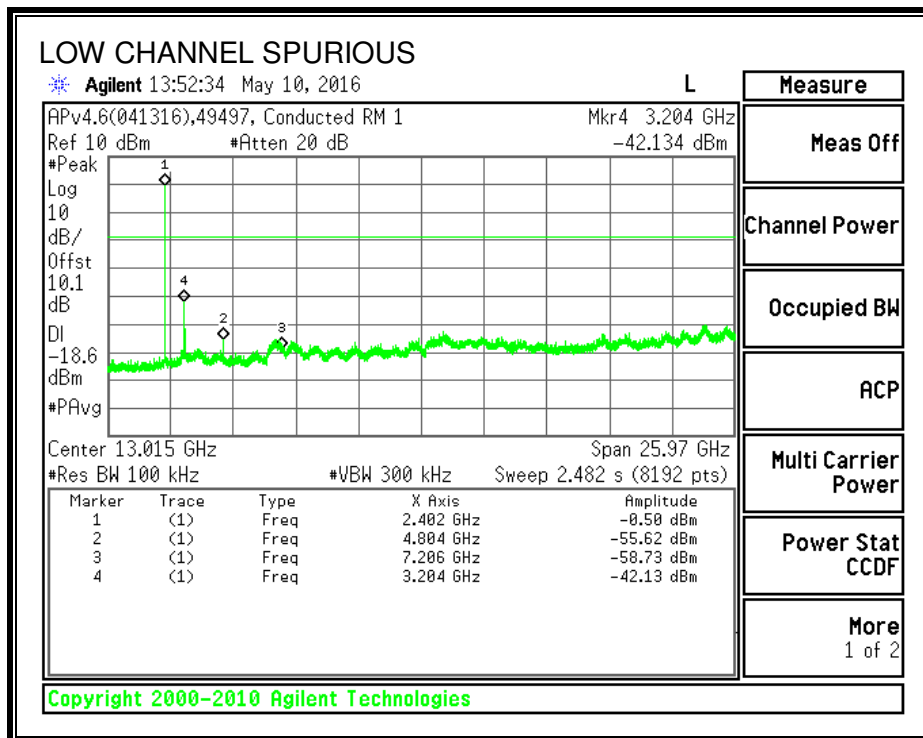
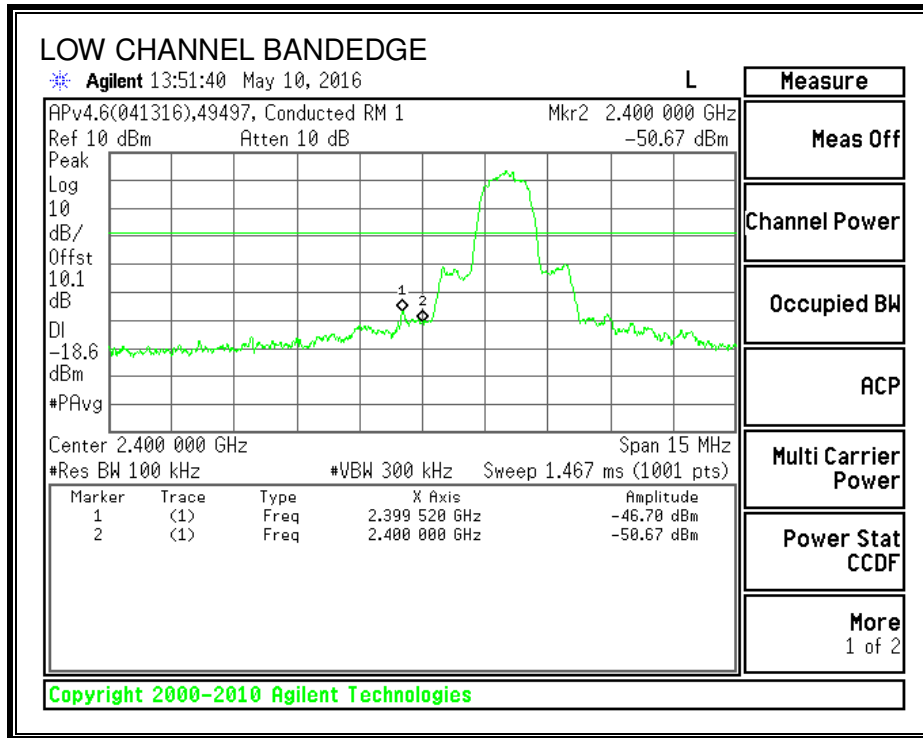

SPURIOUS EMISSIONS, MID CHANNEL

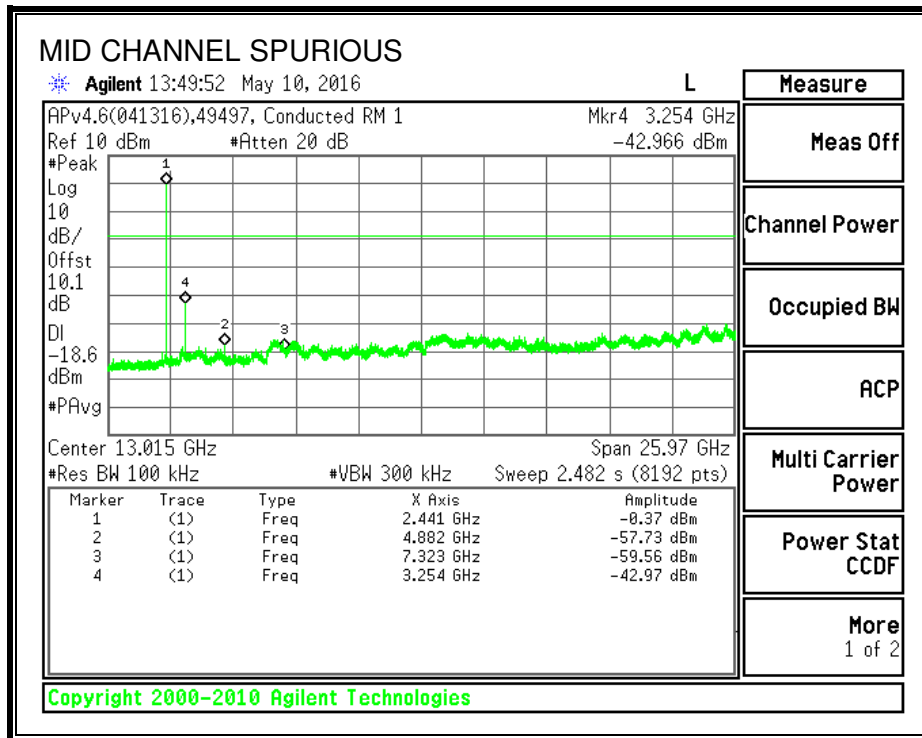
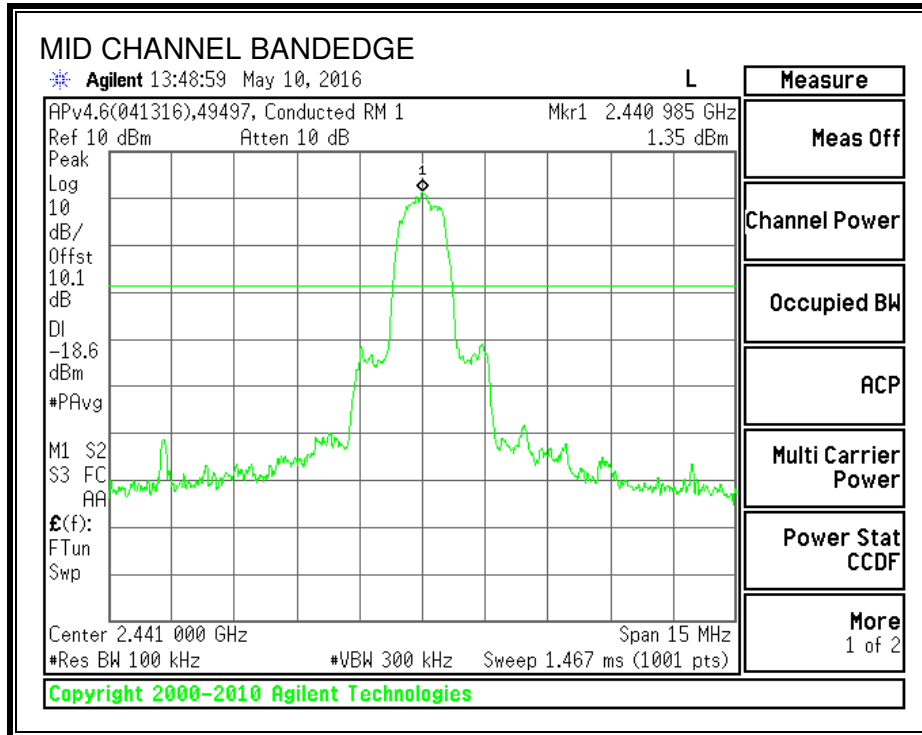

SPURIOUS EMISSIONS, HIGH CHANNEL

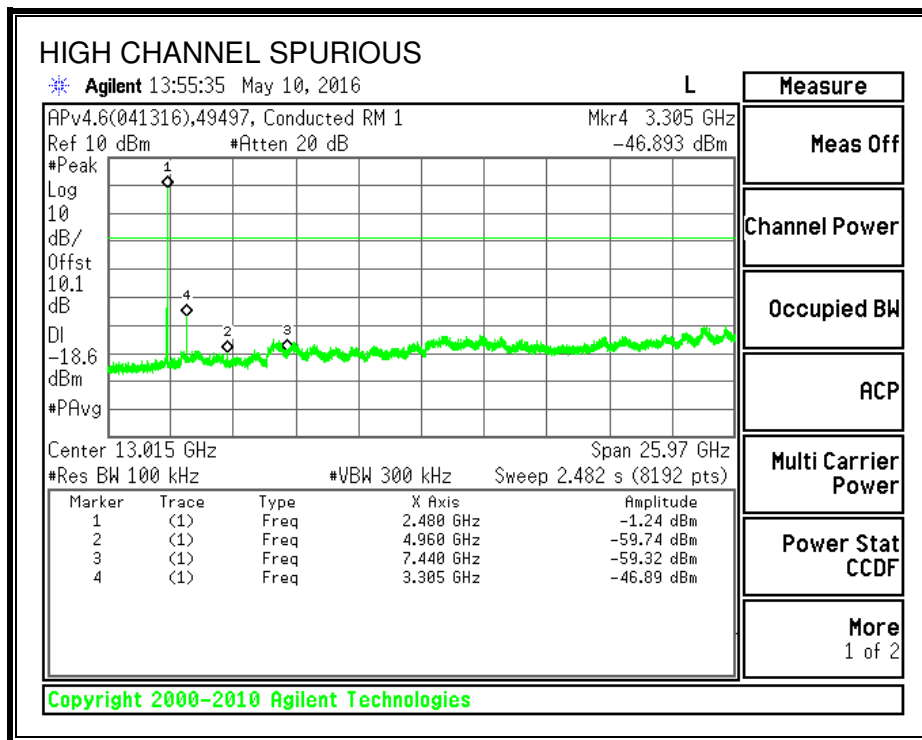
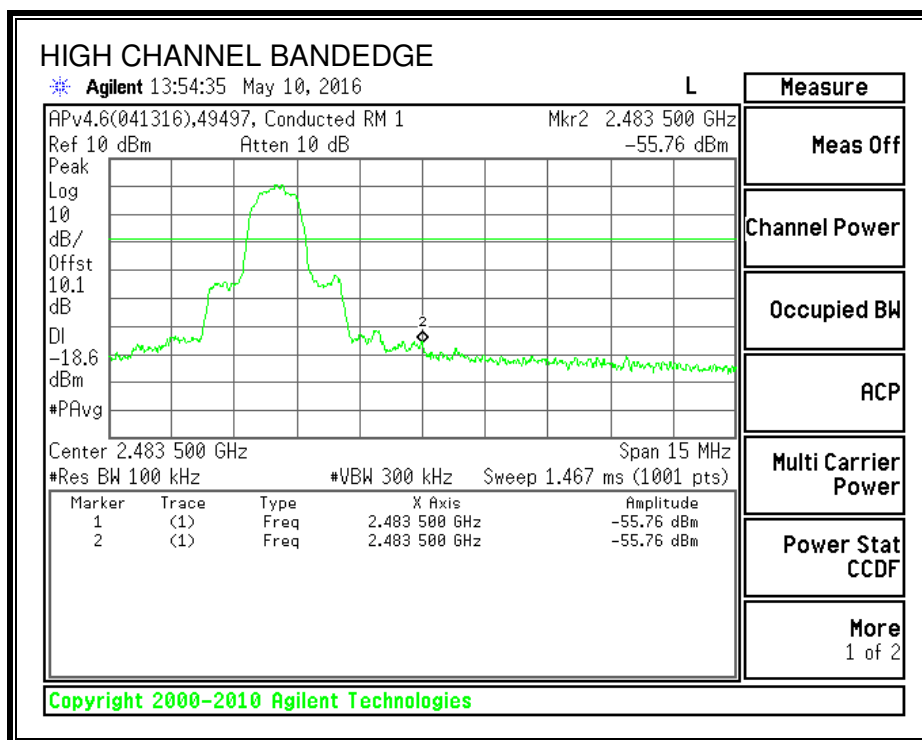

SPURIOUS BANDEDGE EMISSIONS WITH HOPPING ON

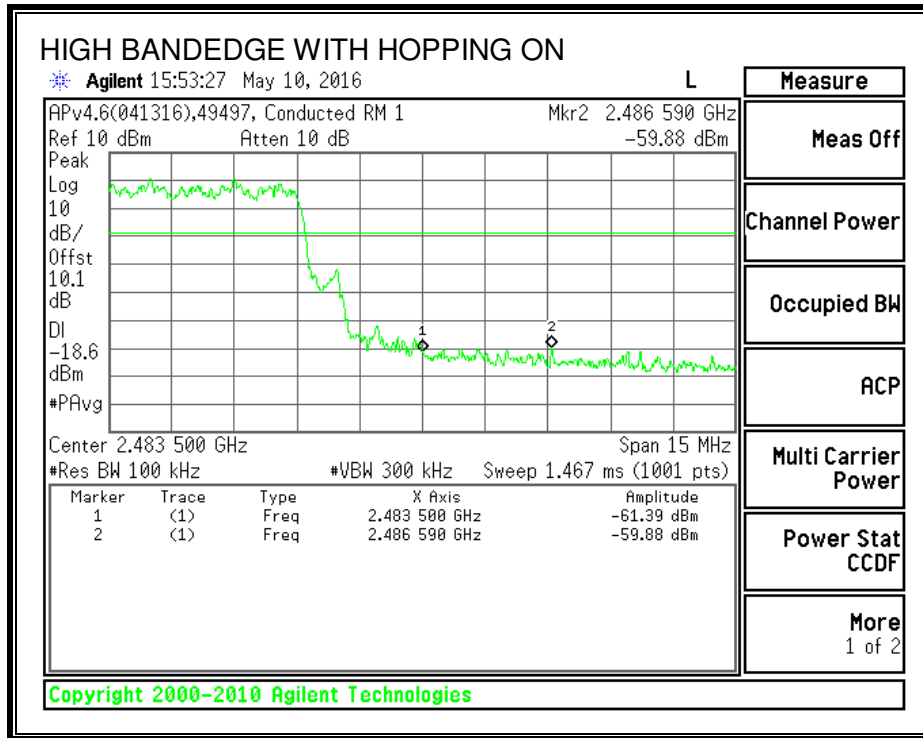
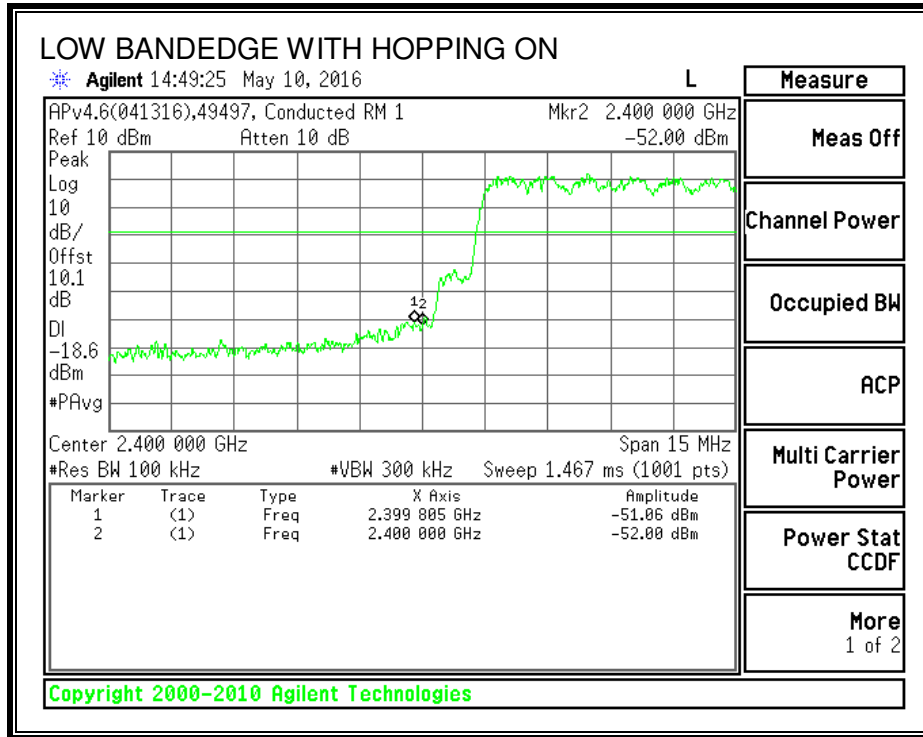

9. RADIATED TEST RESULTS

9.1. LIMITS AND PROCEDURE

LIMITS

FCC §15.205 and §15.209
IC RSS-GEN Clause 8.9 (Transmitter)
IC RSS-GEN Clause 7.1.2 (Receiver)

Frequency Range (MHz)	Field Strength Limit (uV/m) at 3 m	Field Strength Limit (dBuV/m) at 3 m
0.009-0.490	2400/F(kHz) @ 300 m	-
0.490-1.705	24000/F(kHz) @ 30 m	-
1.705 - 30	30 @ 30m	-
30 - 88	100	40
88 - 216	150	43.5
216 - 960	200	46
Above 960	500	54

TEST PROCEDURE

The EUT is placed on a non-conducting table 80 cm above the ground plane for below 1GHz measurements and 1.5 m above the ground plane for above 1GHz measurements. The antenna to EUT distance is 3 meters.

For measurements below 1 GHz the resolution bandwidth is set to 120 kHz for peak detection measurements or 120 kHz for quasi-peak detection measurements. Peak detection is used unless otherwise noted as quasi-peak.

For peak measurements above 1 GHz, the resolution bandwidth is set to 1 MHz and the video bandwidth is set to 3 MHz. For average measurements above 1GHz, the resolution bandwidth and video bandwidth are set as described in ANSI C63.10:2013 for the applicable measurement. The particular averaging method used for this test program was by measuring using a Peak detector with the resolution bandwidth set to 1MHz and a reduced video bandwidth, based on $1/T_{on}$ where T_{on} is the transmit on time.

The spectrum from 9 kHz to 26 GHz is investigated with the transmitter set to the lowest, middle, and highest channels in each applicable band.

The frequency range of interest is monitored at a fixed antenna height and EUT azimuth. The EUT is rotated through 360 degrees to maximize emissions received. The antenna is scanned from 1 to 4 meters above the ground plane to further maximize the emission. Measurements are made with the antenna polarized in both the vertical and the horizontal positions.

9.2. TRANSMITTER ABOVE 1 GHz

9.2.1. BASIC DATA RATE GFSK MODULATION

RESTRICTED BANDEDGE (LOW CHANNEL, STANDALONE)

LOW CHANNEL RESTRICTED, HORIZ

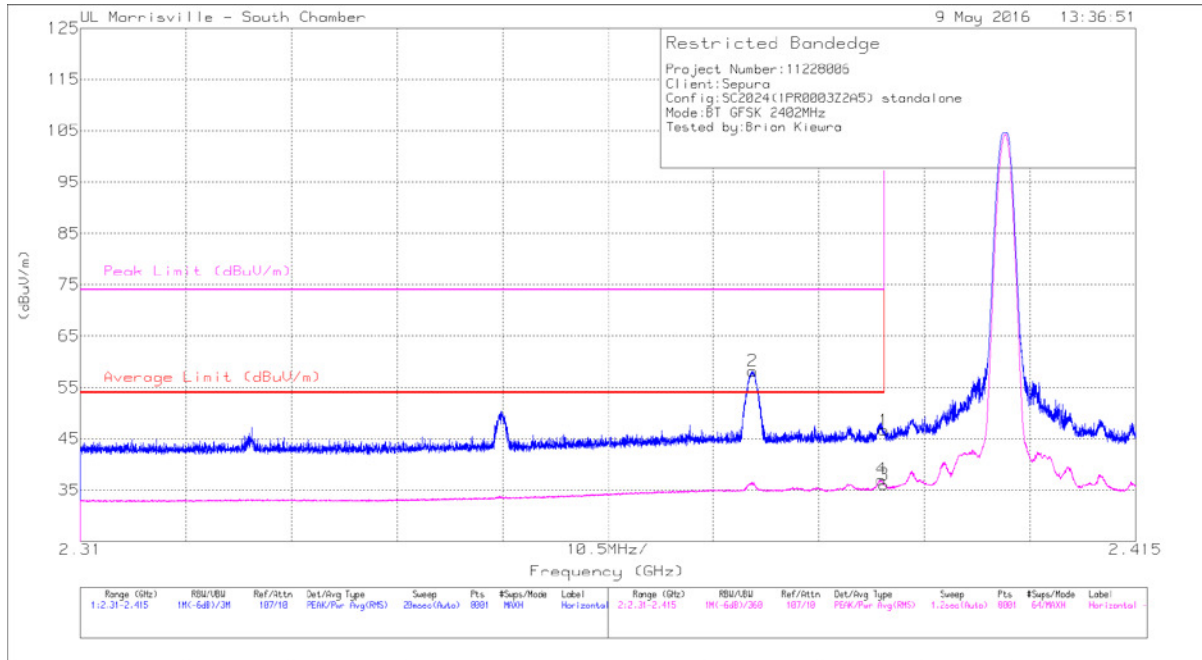

Marker	Frequency (GHz)	Meter Reading (dBuV)	Det	AF AT0069 (dB/m)	Amp/Cbl/Filtr/Pad (dB)	Corrected Reading (dBuV/m)	Average Limit (dBuV/m)	Margin (dB)	Peak Limit (dBuV/m)	PK Margin (dB)	Azimuth (Degs)	Height (cm)	Polarity
1	* 2.39	38.64	Pk	32.2	-24.2	46.64	-	-	74	-27.36	124	187	H
2	* 2.377	50.18	Pk	32.1	-24.1	58.18	-	-	74	-15.82	124	187	H
3	* 2.39	28.06	V1TR	32.2	-24.2	36.06	54	-17.94	-	-	124	187	H
4	* 2.39	28.97	V1TR	32.2	-24.1	37.07	54	-16.93	-	-	124	187	H

* - indicates frequency in CFR47 Pt 15 / IC RSS-Restricted Band

Pk - Peak detector

V1TR: VB=1/Ton, Ton is packet duration

LOW CHANNEL RESTRICTED, VERT

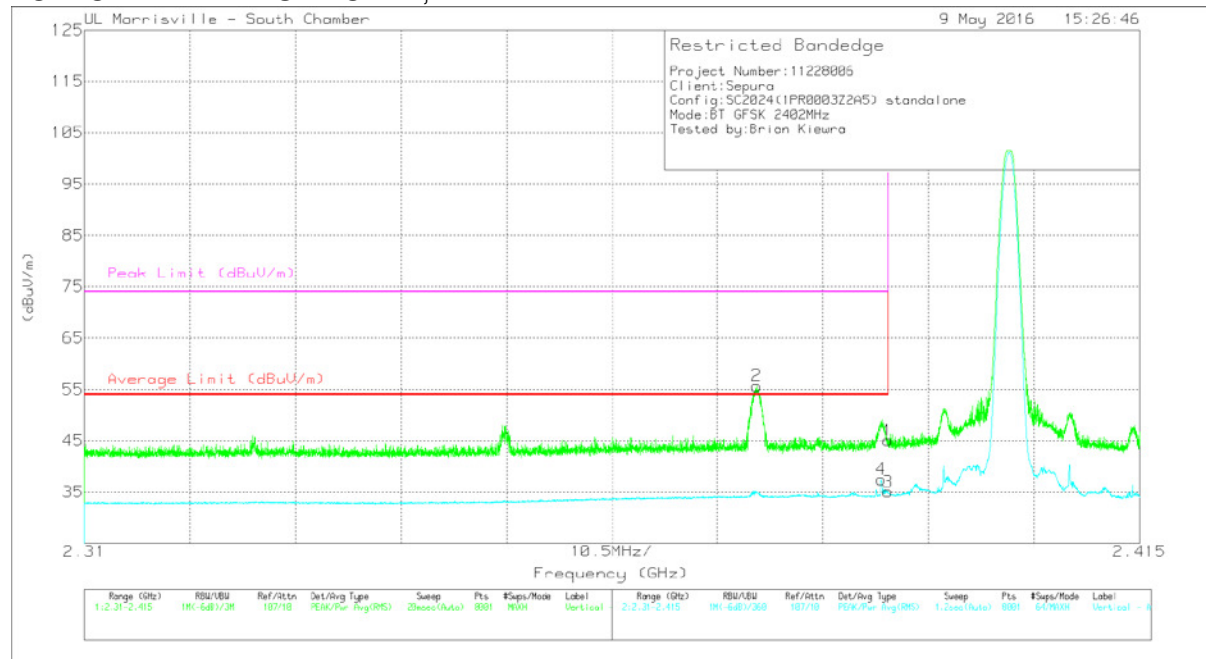

Marker	Frequency (GHz)	Meter Reading (dBuV)	Det	AF AT0069 (dB/m)	Amp/Cbl/ Filtr/Pad (dB)	Corrected Reading (dBuV/m)	Average Limit (dBuV/m)	Margin (dB)	Peak Limit (dBuV/m)	PK Margin (dB)	Azimuth (Degs)	Height (cm)	Polarity
1	* 2.39	37.06	Pk	32.2	-24.2	45.06	-	-	74	-28.94	319	134	V
2	* 2.377	47.65	Pk	32.1	-24.1	55.65	-	-	74	-18.35	319	134	V
3	* 2.39	27.05	V1TR	32.2	-24.2	35.05	54	-18.95	-	-	319	134	V
4	* 2.389	29.36	V1TR	32.2	-24.1	37.46	54	-16.54	-	-	319	134	V

* - indicates frequency in CFR47 Pt 15 / IC RSS-Restricted Band

Pk - Peak detector

V1TR: VB=1/Ton, where: Ton is packet duration

RESTRICTED BANDEDGE (LOW CHANNEL, CHARGER)

LOW CHANNEL RESTRICTED, HORIZ

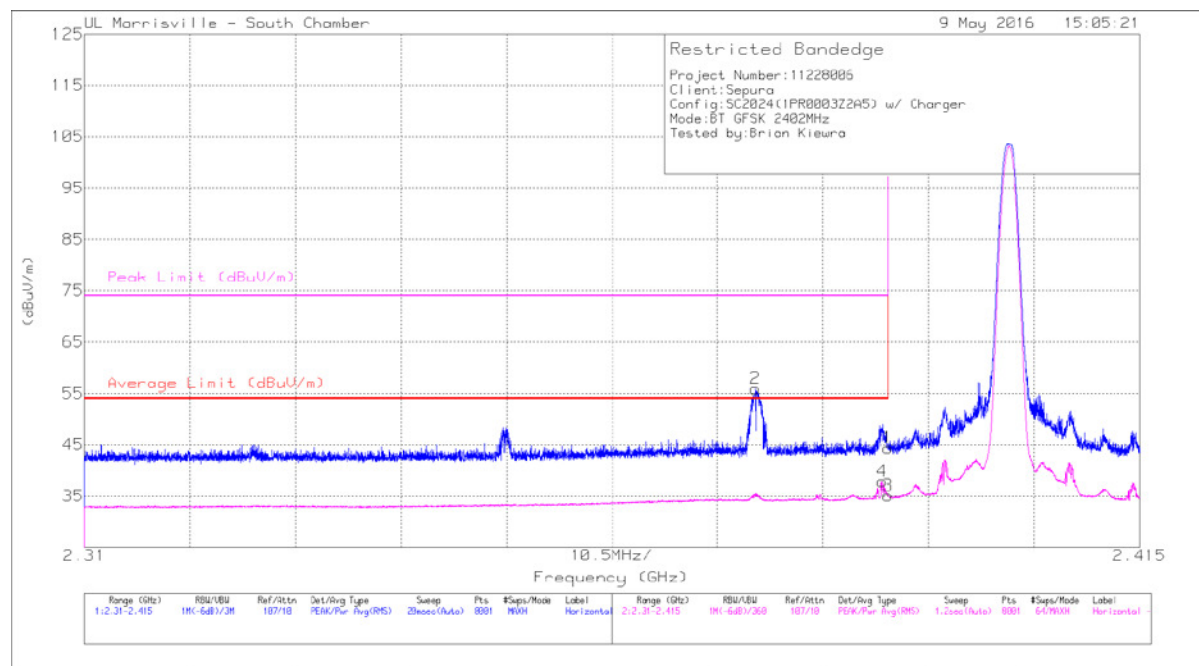

Marker	Frequency (GHz)	Meter Reading (dBuV)	Det	AF AT0069 (dB/m)	Amp/Cbl/Filtr/Pad (dB)	Corrected Reading (dBuV/m)	Average Limit (dBuV/m)	Margin (dB)	Peak Limit (dBuV/m)	PK Margin (dB)	Azimuth (Degs)	Height (cm)	Polarity
1	* 2.39	36.39	Pk	32.2	-24.2	44.39	-	-	74	-29.61	59	111	H
2	* 2.377	47.9	Pk	32.1	-24.1	55.9	-	-	74	-18.1	59	111	H
3	* 2.39	27.09	V1TR	32.2	-24.2	35.09	54	-18.91	-	-	59	111	H
4	* 2.389	29.75	V1TR	32.2	-24.1	37.85	54	-16.15	-	-	59	111	H

* - indicates frequency in CFR47 Pt 15 / IC RSS-Restricted Band

Pk - Peak detector

V1TR: VB=1/Ton, where: Ton is packet duration

LOW CHANNEL RESTRICTED, VERT

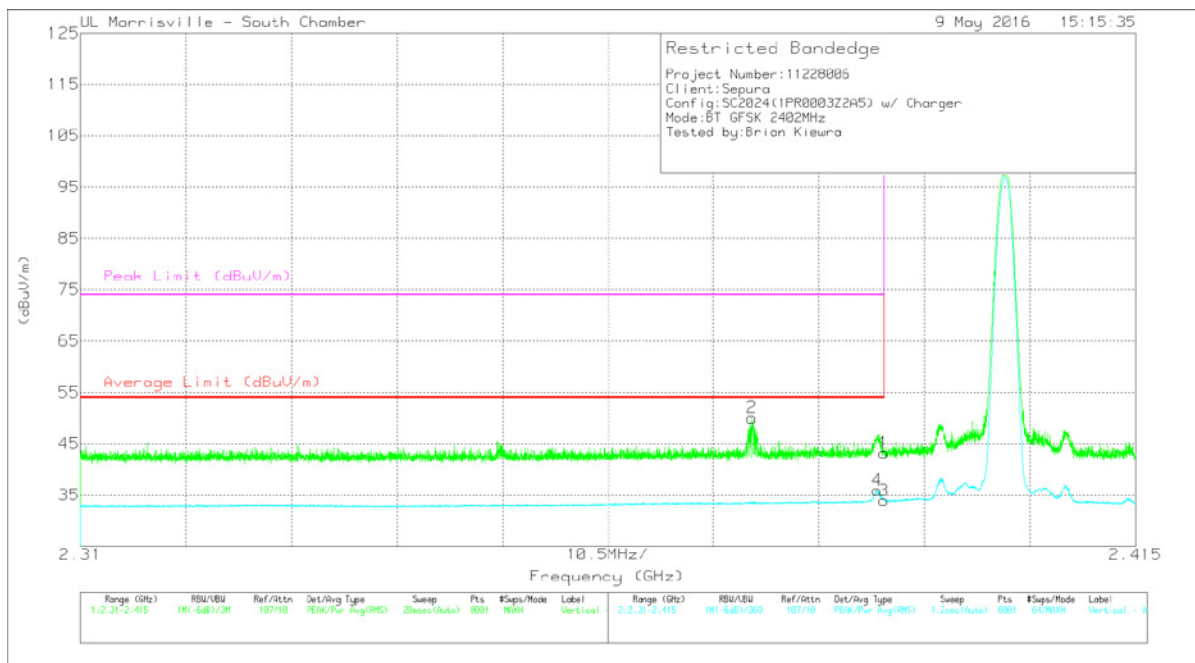

Marker	Frequency (GHz)	Meter Reading (dBuV)	Det	AF AT0069 (dB/m)	Amp/Cbl/Filtr/Pad (dB)	Corrected Reading (dBuV/m)	Average Limit (dBuV/m)	Margin (dB)	Peak Limit (dBuV/m)	PK Margin (dB)	Azimuth (Degs)	Height (cm)	Polarity
1	* 2.39	35.21	Pk	32.2	-24.2	43.21	-	-	74	-30.79	133	113	V
2	* 2.377	42.04	Pk	32.1	-24.1	50.04	-	-	74	-23.96	133	113	V
3	* 2.39	25.96	V1TR	32.2	-24.2	33.96	54	-20.04	-	-	133	113	V
4	* 2.389	27.83	V1TR	32.2	-24.1	35.93	54	-18.07	-	-	133	113	V

* - indicates frequency in CFR47 Pt 15 / IC RSS-Restricted Band

Pk - Peak detector

V1TR: VB=1/Ton, where: Ton is packet duration

RESTRICTED BANDEDGE (HIGH CHANNEL, STANDALONE)

HIGH CHANNEL RESTRICTED, HORIZ

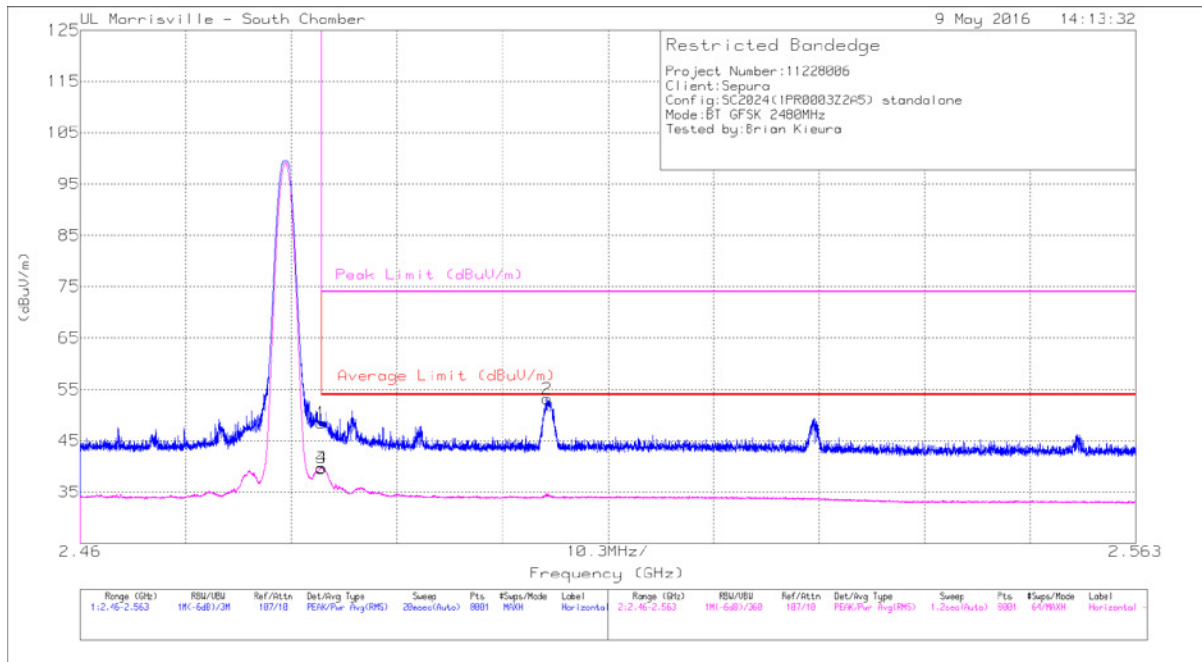

Marker	Frequency (GHz)	Meter Reading (dBuV)	Det	AF AT0069 (dB/m)	Amp/Cbl/Filtr/Pad (dB)	Corrected Reading (dBuV/m)	Average Limit (dBuV/m)	Margin (dB)	Peak Limit (dBuV/m)	PK Margin (dB)	Azimuth (Degs)	Height (cm)	Polarity
1	* 2.484	40.71	Pk	32.4	-24.7	48.41	-	-	74	-25.59	132	106	H
3	* 2.484	31.93	V1TR	32.4	-24.7	39.63	54	-14.37	-	-	132	106	H
4	* 2.484	32.02	V1TR	32.4	-24.7	39.72	54	-14.28	-	-	132	106	H
2	2.506	45.44	Pk	32.5	-24.8	53.14	-	-	74	-20.86	132	106	H

* - indicates frequency in CFR47 Pt 15 / IC RSS-Restricted Band

Pk - Peak detector

V1TR: VB=1/Ton, where: Ton is packet duration

HIGH CHANNEL RESTRICTED, VERT

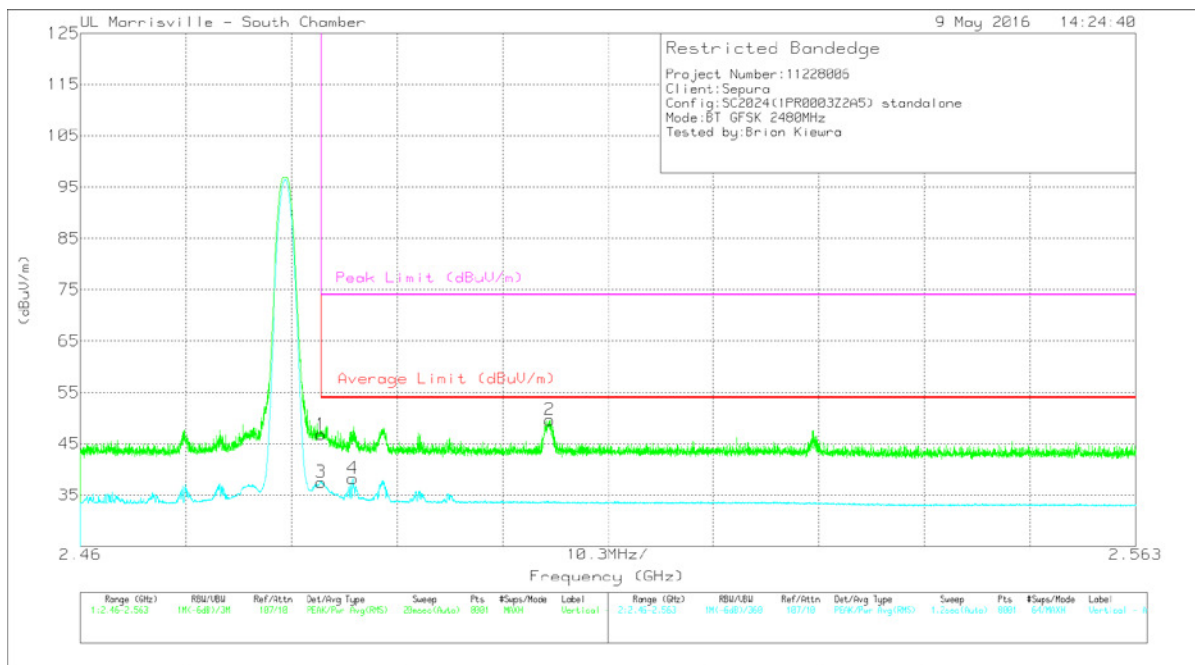

Marker	Frequency (GHz)	Meter Reading (dBuV)	Det	AF AT0069 (dB/m)	Amp/Cbl/Fitr/Pad (dB)	Corrected Reading (dBuV/m)	Average Limit (dBuV/m)	Margin (dB)	Peak Limit (dBuV/m)	PK Margin (dB)	Azimuth (Degs)	Height (cm)	Polarity
1	* 2.484	39.11	Pk	32.4	-24.7	46.81	-	-	74	-27.19	38	108	V
3	* 2.484	29.84	V1TR	32.4	-24.7	37.54	54	-16.46	-	-	38	108	V
4	* 2.487	30.55	V1TR	32.4	-24.7	38.25	54	-15.75	-	-	38	108	V
2	2.506	41.96	Pk	32.5	-24.8	49.66	-	-	74	-24.34	38	108	V

* - indicates frequency in CFR47 Pt 15 / IC RSS-Restricted Band

Pk - Peak detector

V1TR: VB=1/Ton, where: Ton is packet duration

RESTRICTED BANDEDGE (HIGH CHANNEL, CHARGER)

HIGH CHANNEL RESTRICTED, HORIZ

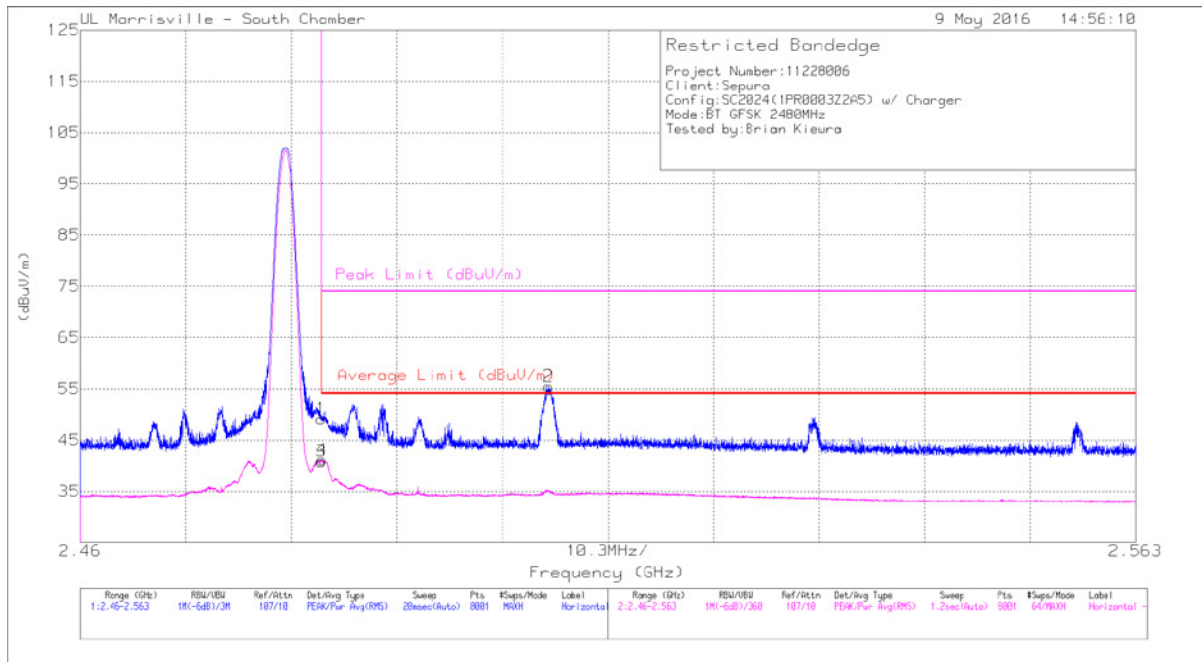

Marker	Frequency (GHz)	Meter Reading (dBuV)	Det	AF AT0069 (dB/m)	Amp/Cbl/Filtr/Pad (dB)	Corrected Reading (dBuV/m)	Average Limit (dBuV/m)	Margin (dB)	Peak Limit (dBuV/m)	PK Margin (dB)	Azimuth (Degs)	Height (cm)	Polarity
1	* 2.484	41.45	Pk	32.4	-24.7	49.15	-	-	74	-24.85	59	111	H
3	* 2.484	33.15	V1TR	32.4	-24.7	40.85	54	-13.15	-	-	59	111	H
4	* 2.484	33.43	V1TR	32.4	-24.7	41.13	54	-12.87	-	-	59	111	H
2	2.506	47.78	Pk	32.5	-24.8	55.48	-	-	74	-18.52	59	111	H

* - indicates frequency in CFR47 Pt 15 / IC RSS-Restricted Band

Pk - Peak detector

V1TR: VB=1/Ton, where: Ton is packet duration

HIGH CHANNEL RESTRICTED, VERT

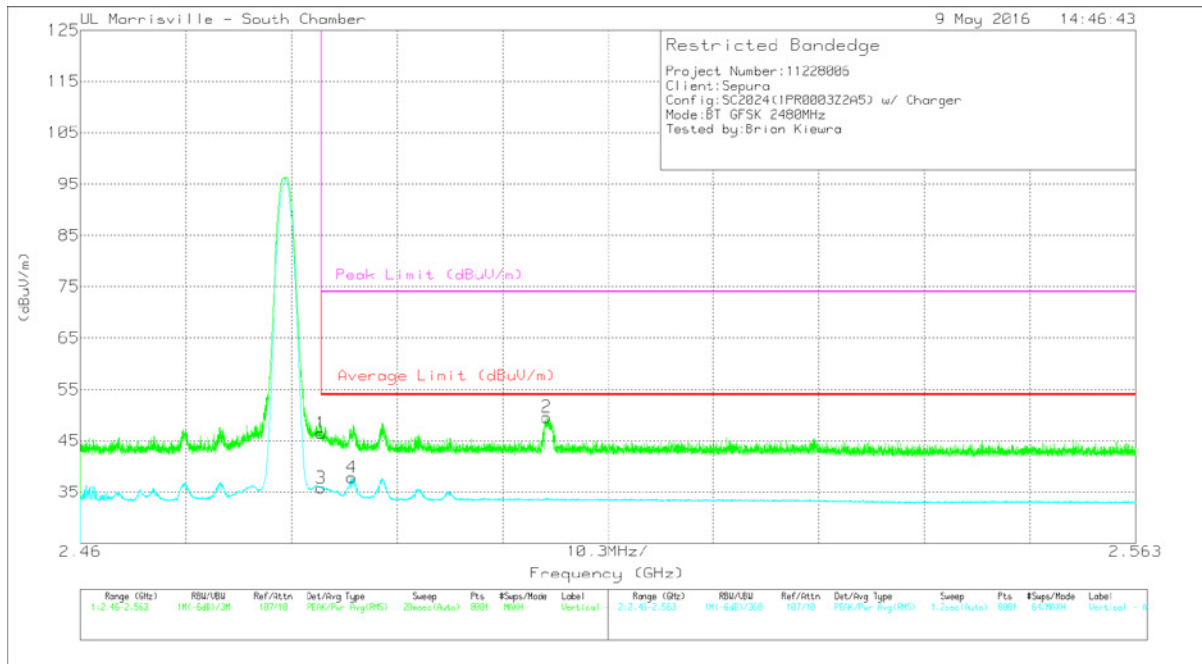

Marker	Frequency (GHz)	Meter Reading (dBuV)	Det	AF AT0069 (dB/m)	Amp/Cbl/Filtr/Pad (dB)	Corrected Reading (dBuV/m)	Average Limit (dBuV/m)	Margin (dB)	Peak Limit (dBuV/m)	PK Margin (dB)	Azimuth (Degs)	Height (cm)	Polarity
1	* 2.484	38.77	Pk	32.4	-24.7	46.47	-	-	74	-27.53	33	109	V
3	* 2.484	28.11	V1TR	32.4	-24.7	35.81	54	-18.19	-	-	33	109	V
4	* 2.486	30.15	V1TR	32.4	-24.7	37.85	54	-16.15	-	-	33	109	V
2	2.506	41.91	Pk	32.5	-24.8	49.61	-	-	74	-24.39	33	109	V

* - indicates frequency in CFR47 Pt 15 / IC RSS-Restricted Band

Pk - Peak detector

V1TR: VB=1/Ton, where: Ton is packet duration

HARMONICS AND SPURIOUS EMISSIONS

Standalone Low Channel

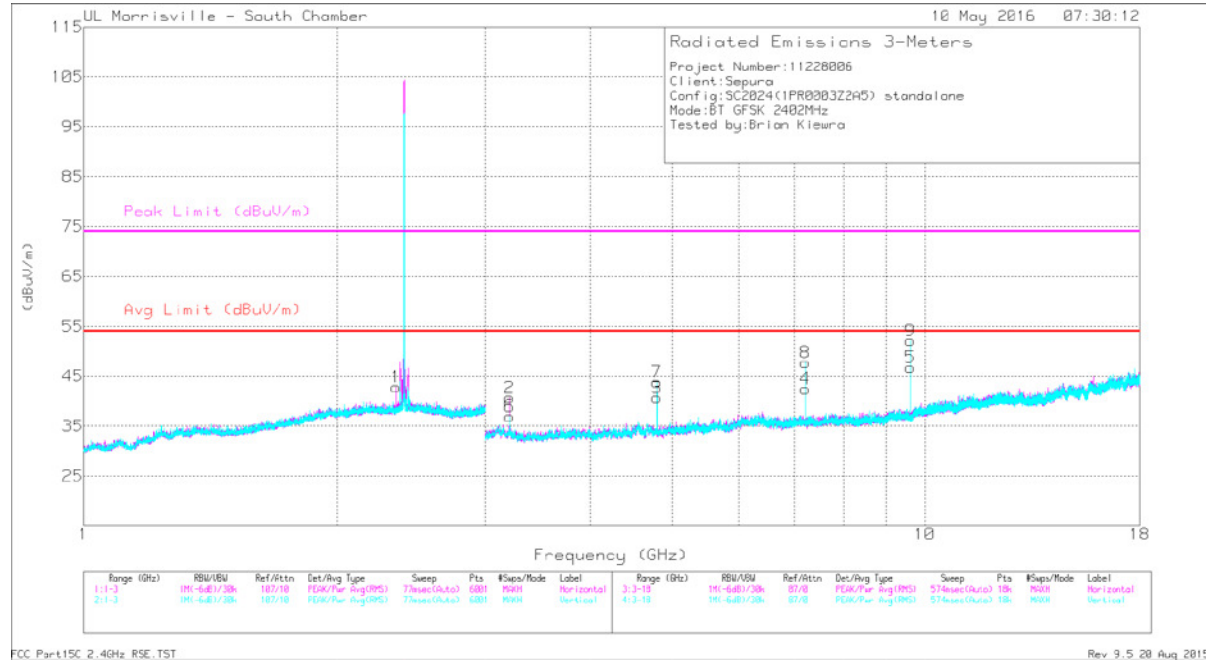

Marker	Frequency (GHz)	Meter Reading (dBuV)	Det	AF AT0069 (dB/m)	Amp/Cbl/ Fitr/Pad (dB)	Corrected Reading (dBuV/m)	Avg Limit (dBuV/m)	Margin (dB)	Peak Limit (dBuV/m)	PK Margin (dB)	Azimuth (Degs)	Height (cm)	Polarity
1	* 2.352	43.24	PK-U	31.8	-24	51.04	-	-	74	-22.96	73	173	H
	* 2.352	25.98	V1TR	31.8	-24	33.78	54	-20.22	-	-	73	173	H
3	* 4.804	44.81	PK-U	34	-31.7	47.11	-	-	74	-26.89	241	141	H
	* 4.804	38.94	V1TR	34	-31.7	41.24	54	-12.76	-	-	241	141	H
7	* 4.804	46.67	PK-U	34	-31.7	48.97	-	-	74	-25.03	237	272	V
	* 4.804	41.99	V1TR	34	-31.7	44.29	54	-9.71	-	-	237	272	V
2	3.202	40.65	Pk	33.4	-33.4	40.65	-	-	-	-	0-360	102	H
4	7.206	35.58	Pk	35.6	-28.7	42.48	-	-	-	-	0-360	199	H
5	9.608	37.27	Pk	36.6	-27.1	46.77	-	-	-	-	0-360	199	H
6	3.202	36.96	Pk	33.4	-33.4	36.96	-	-	-	-	0-360	102	V
8	7.206	40.78	Pk	35.6	-28.7	47.68	-	-	-	-	0-360	199	V
9	9.608	42.63	Pk	36.6	-27.1	52.13	-	-	-	-	0-360	102	V

* - indicates frequency in CFR47 Pt 15 / IC RSS-Restricted Band

Pk - Peak detector

PK-U: Maximum Peak

V1TR: VB=1/Ton, where: Ton is packet duration

Standalone Mid Channel

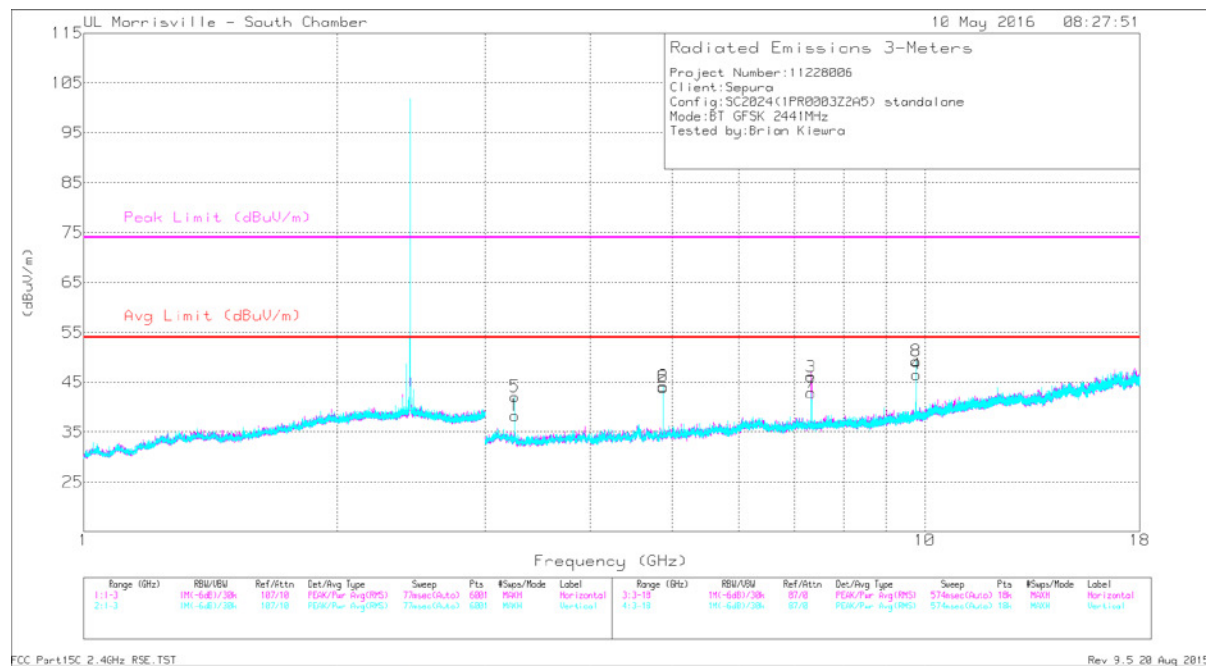

Marker	Frequency (GHz)	Meter Reading (dBuV)	Det	AF AT0069 (dB/m)	Amp/Cbl/ ftr/Pad (dB)	Corrected Reading (dBuV/m)	Avg Limit (dBuV/m)	Margin (dB)	Peak Limit (dBuV/m)	PK Margin (dB)	Azimuth (Degs)	Height (cm)	Polarity
2	* 4.882	43.24	PK-U	34.1	-31.5	45.84	-	-	74	-28.16	251	137	H
	* 4.882	37.03	V1TR	34.1	-31.5	39.63	54	-14.37	-	-	251	137	H
3	* 7.323	41.51	PK-U	35.5	-28.4	48.61	-	-	74	-25.39	169	386	H
	* 7.323	34.46	V1TR	35.5	-28.4	41.56	54	-12.44	-	-	169	386	H
6	* 4.882	46.61	PK-U	34.1	-31.5	49.21	-	-	74	-24.79	243	295	V
	* 4.882	41.92	V1TR	34.1	-31.5	44.52	54	-9.48	-	-	243	295	V
7	* 7.323	43.12	PK-U	35.5	-28.4	50.22	-	-	74	-23.78	238	115	V
	* 7.323	36.37	V1TR	35.5	-28.4	43.47	54	-10.53	-	-	238	115	V
1	3.254	38.94	Pk	33.1	-33.7	38.34	-	-	-	-	0-360	102	H
4	9.765	36.13	Pk	36.8	-26.4	46.53	-	-	-	-	0-360	102	H
5	3.255	42.72	Pk	33.1	-33.7	42.12	-	-	-	-	0-360	101	V
8	9.763	38.86	Pk	36.8	-26.4	49.26	-	-	-	-	0-360	101	V

* - indicates frequency in CFR47 Pt 15 / IC RSS-Restricted Band

Pk - Peak detector

PK-U: Maximum Peak

V1TR: VB=1/Ton, where: Ton is packet duration

Standalone High Channel

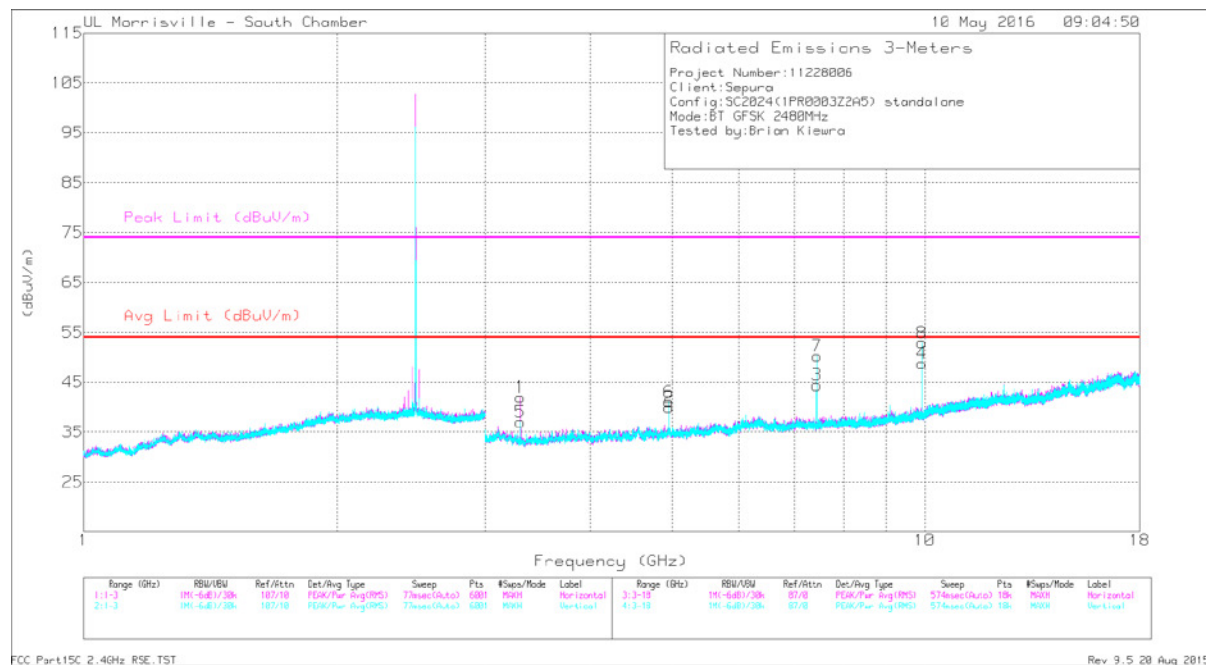

Marker	Frequency (GHz)	Meter Reading (dBuV)	Det	AF AT0069 (dB/m)	Amp/Cbl/ ftr/Pad (dB)	Corrected Reading (dBuV/m)	Avg Limit (dBuV/m)	Margin (dB)	Peak Limit (dBuV/m)	PK Margin (dB)	Azimuth (Degs)	Height (cm)	Polarity
2	* 4.96	43.9	PK-U	34.1	-31.6	46.4	-	-	74	-27.6	343	222	H
	* 4.96	36.51	V1TR	34.1	-31.6	39.01	54	-14.99	-	-	343	222	H
3	* 7.44	41.25	PK-U	35.5	-28.7	48.05	-	-	74	-25.95	168	221	H
	* 7.44	34.04	V1TR	35.5	-28.7	40.84	54	-13.16	-	-	168	221	H
6	* 4.96	44.64	PK-U	34.1	-31.6	47.14	-	-	74	-26.86	245	400	V
	* 4.96	38.92	V1TR	34.1	-31.6	41.42	54	-12.58	-	-	245	400	V
7	* 7.44	46.08	PK-U	35.5	-28.7	52.88	-	-	74	-21.12	285	183	V
	* 7.44	40.87	V1TR	35.5	-28.7	47.67	54	-6.33	-	-	285	183	V
1	3.307	42.78	Pk	32.7	-33.5	41.98	-	-	-	-	0-360	199	H
5	3.307	37.87	Pk	32.7	-33.5	37.07	-	-	-	-	0-360	101	V
4	9.92	38.16	Pk	37.1	-26.5	48.76	-	-	-	-	0-360	199	H
8	9.92	42.24	Pk	37.1	-26.5	52.84	-	-	-	-	0-360	101	V

* - indicates frequency in CFR47 Pt 15 / IC RSS-Restricted Band

Pk - Peak detector

PK-U: Maximum Peak

V1TR: VB=1/Ton, where: Ton is packet duration

Charger Low Channel

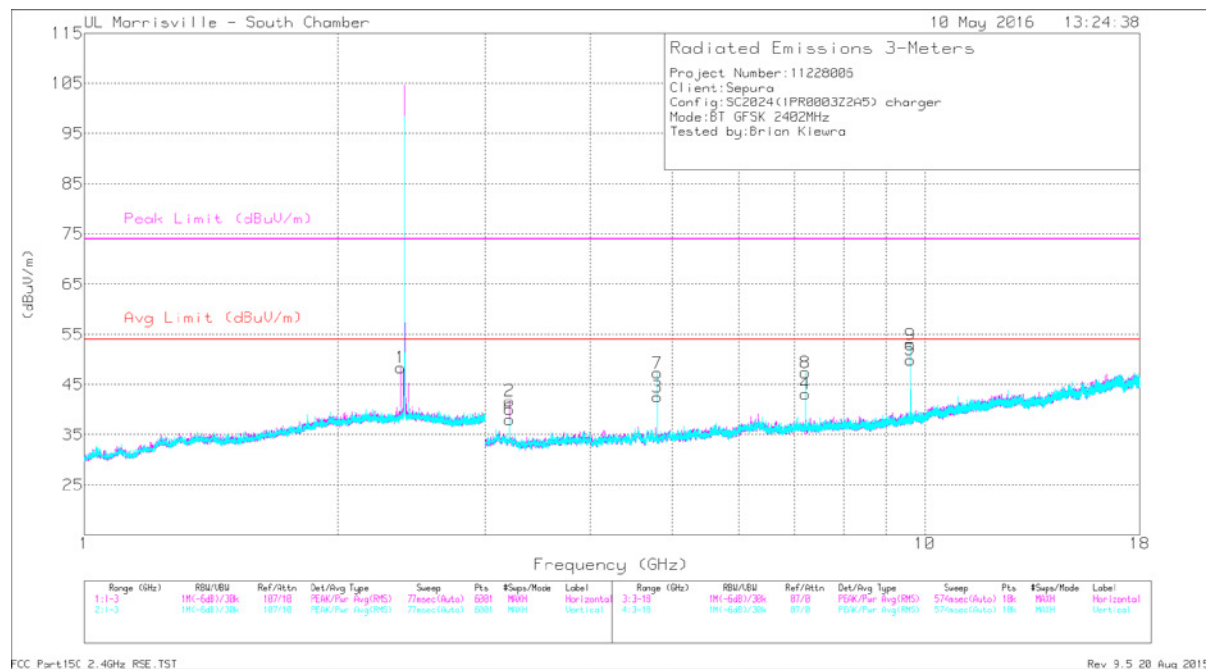

Marker	Frequency (GHz)	Meter Reading (dBuV)	Det	AF AT0069 (dB/m)	Amp/Cbl/Filtr/Pad (dB)	Corrected Reading (dBuV/m)	Avg Limit (dBuV/m)	Margin (dB)	Peak Limit (dBuV/m)	PK Margin (dB)	Azimuth (Degs)	Height (cm)	Polarity
1	* 2.377	48.59	PK-U	32.1	-24.1	56.59	-	-	74	-17.41	64	154	H
	* 2.377	27.35	V1TR	32.1	-24.1	35.35	54	-18.65	-	-	64	154	H
3	* 4.804	44.51	PK-U	34	-31.7	46.81	-	-	74	-27.19	227	223	H
	* 4.804	38.98	V1TR	34	-31.7	41.28	54	-12.72	-	-	227	223	H
7	* 4.804	48.49	PK-U	34	-31.7	50.79	-	-	74	-23.21	210	239	V
	* 4.804	44.84	V1TR	34	-31.7	47.14	54	-6.86	-	-	210	239	V
2	3.202	41.71	Pk	33.4	-33.4	41.71	-	-	-	-	0-360	101	H
6	3.202	38.06	Pk	33.4	-33.4	38.06	-	-	-	-	0-360	102	V
4	7.206	36.23	Pk	35.6	-28.7	43.13	-	-	-	-	0-360	199	H
8	7.206	40.45	Pk	35.6	-28.7	47.35	-	-	-	-	0-360	199	V
5	9.607	40.45	Pk	36.6	-27.1	49.95	-	-	-	-	0-360	199	H
9	9.608	43.4	Pk	36.6	-27.1	52.9	-	-	-	-	0-360	102	V

* - indicates frequency in CFR47 Pt 15 / IC RSS-Restricted Band
 Pk - Peak detector
 PK-U: Maximum Peak
 V1TR: VB=1/Ton, where: Ton is packet duration

Charger Mid Channel

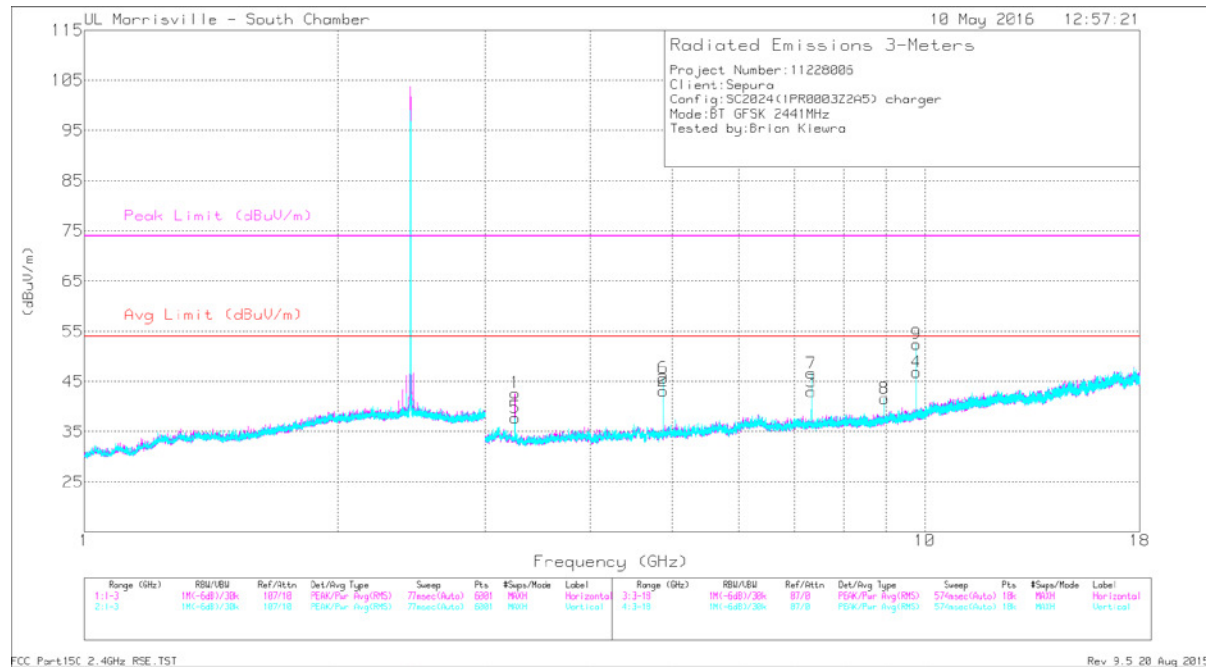

Marker	Frequency (GHz)	Meter Reading (dBuV)	Det	AF AT0069 (dB/m)	Amp/Cbl/ ftr/Pad (dB)	Corrected Reading (dBuV/m)	Avg Limit (dBuV/m)	Margin (dB)	Peak Limit (dBuV/m)	PK Margin (dB)	Azimuth (Degs)	Height (cm)	Polarity
2	* 4.882	46.39	PK-U	34.1	-31.5	48.99	-	-	74	-25.01	197	244	H
	* 4.882	42.03	V1TR	34.1	-31.5	44.63	54	-9.37	-	-	197	244	H
3	* 7.323	41.12	PK-U	35.5	-28.4	48.22	-	-	74	-25.78	209	193	H
	* 7.323	33.01	V1TR	35.5	-28.4	40.11	54	-13.89	-	-	209	193	H
6	* 4.882	45.87	PK-U	34.1	-31.5	48.47	-	-	74	-25.53	199	222	V
	* 4.882	41.42	V1TR	34.1	-31.5	44.02	54	-9.98	-	-	199	222	V
7	* 7.323	43.62	PK-U	35.5	-28.4	50.72	-	-	74	-23.28	267	186	V
	* 7.323	37.31	V1TR	35.5	-28.4	44.41	54	-9.59	-	-	267	186	V
1	3.255	43.31	Pk	33.1	-33.7	42.71	-	-	-	-	0-360	102	H
5	3.255	38.4	Pk	33.1	-33.7	37.8	-	-	-	-	0-360	102	V
8	8.95	33.5	Pk	35.9	-27.8	41.6	-	-	-	-	0-360	199	V
4	9.763	36.45	Pk	36.8	-26.4	46.85	-	-	-	-	0-360	199	H
9	9.764	42.06	Pk	36.8	-26.4	52.46	-	-	-	-	0-360	199	V

* - indicates frequency in CFR47 Pt 15 / IC RSS-Restricted Band
 Pk - Peak detector
 PK-U: Maximum Peak
 V1TR: VB=1/Ton, where: Ton is packet duration

Charger High Channel

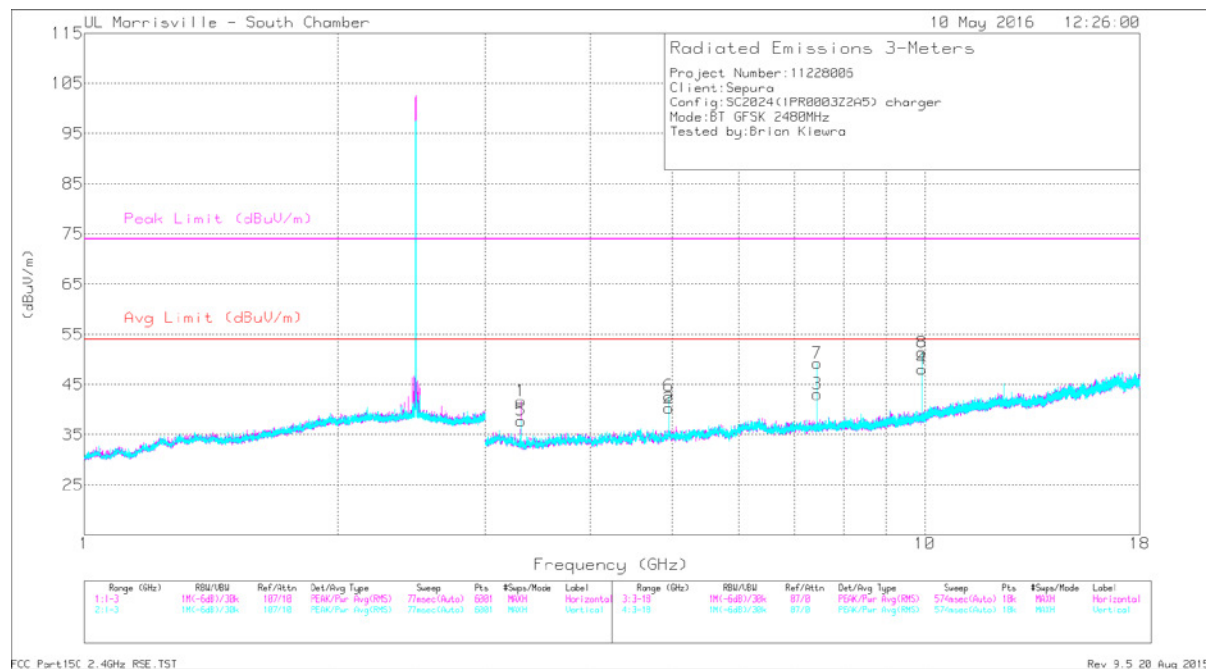

Marker	Frequency (GHz)	Meter Reading (dBuV)	Det	AF AT0069 (dB/m)	Amp/Cbl/ftr/Pad (dB)	Corrected Reading (dBuV/m)	Avg Limit (dBuV/m)	Margin (dB)	Peak Limit (dBuV/m)	PK Margin (dB)	Azimuth (Degs)	Height (cm)	Polarity
2	* 4.96	43.76	PK-U	34.1	-31.6	46.26	-	-	74	-27.74	193	224	H
	* 4.96	36.96	V1TR	34.1	-31.6	39.46	54	-14.54	-	-	193	224	H
3	* 7.44	42.03	PK-U	35.5	-28.7	48.83	-	-	74	-25.17	215	182	H
	* 7.44	34.5	V1TR	35.5	-28.7	41.3	54	-12.7	-	-	215	182	H
6	* 4.96	45.24	PK-U	34.1	-31.6	47.74	-	-	74	-26.26	254	229	V
	* 4.96	38.83	V1TR	34.1	-31.6	41.33	54	-12.67	-	-	254	229	V
7	* 7.44	45.3	PK-U	35.5	-28.7	52.1	-	-	74	-21.9	280	180	V
	* 7.44	39.56	V1TR	35.5	-28.7	46.36	54	-7.64	-	-	280	180	V
1	3.307	42.52	Pk	32.7	-33.5	41.72	-	-	-	-	0-360	102	H
5	3.307	38.64	Pk	32.7	-33.5	37.84	-	-	-	-	0-360	102	V
4	9.92	37.48	Pk	37.1	-26.5	48.08	-	-	-	-	0-360	102	H
8	9.92	40.81	Pk	37.1	-26.5	51.41	-	-	-	-	0-360	199	V

* - indicates frequency in CFR47 Pt 15 / IC RSS-Restricted Band
 Pk - Peak detector
 PK-U: Maximum Peak
 V1TR: VB=1/Ton, where: Ton is packet duration

9.2.2. ENHANCED DATA RATE 8PSK MODULATION

RESTRICTED BANDEDGE (LOW CHANNEL, STANDALONE)

LOW CHANNEL RESTRICTED, HORIZ

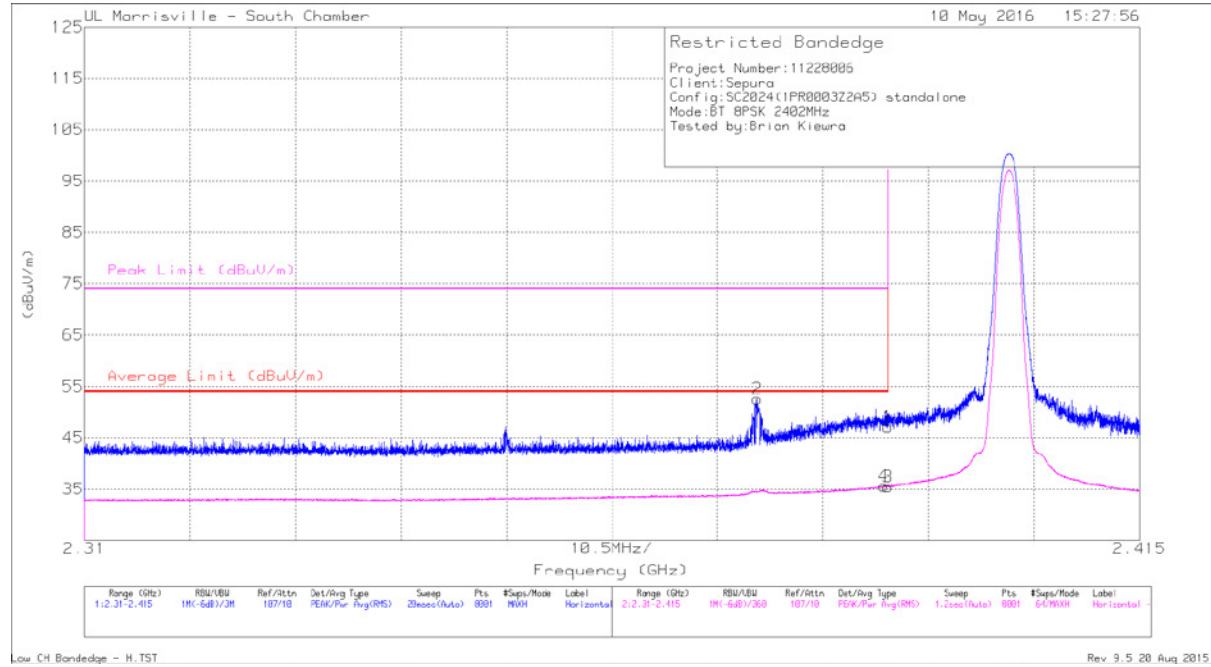

Marker	Frequency (GHz)	Meter Reading (dBuV)	Det	AF AT0069 (dB/m)	Amp/Cbl/Filtr/Pad (dB)	Corrected Reading (dBuV/m)	Average Limit (dBuV/m)	Margin (dB)	Peak Limit (dBuV/m)	PK Margin (dB)	Azimuth (Degs)	Height (cm)	Polarity
2	* 2.377	44.55	Pk	32.1	-24.1	52.55	-	-	74	-21.45	67	102	H
1	* 2.39	39.1	Pk	32.2	-24.2	47.1	-	-	74	-26.9	67	102	H
3	* 2.39	27.44	V1TR	32.2	-24.2	35.44	54	-18.56	-	-	67	102	H
4	* 2.39	27.46	V1TR	32.2	-24.1	35.56	54	-18.44	-	-	67	102	H

* - indicates frequency in CFR47 Pt 15 / IC RSS-Restricted Band

Pk - Peak detector

V1TR: VB=1/Ton, where: Ton is packet duration

LOW CHANNEL RESTRICTED, VERT

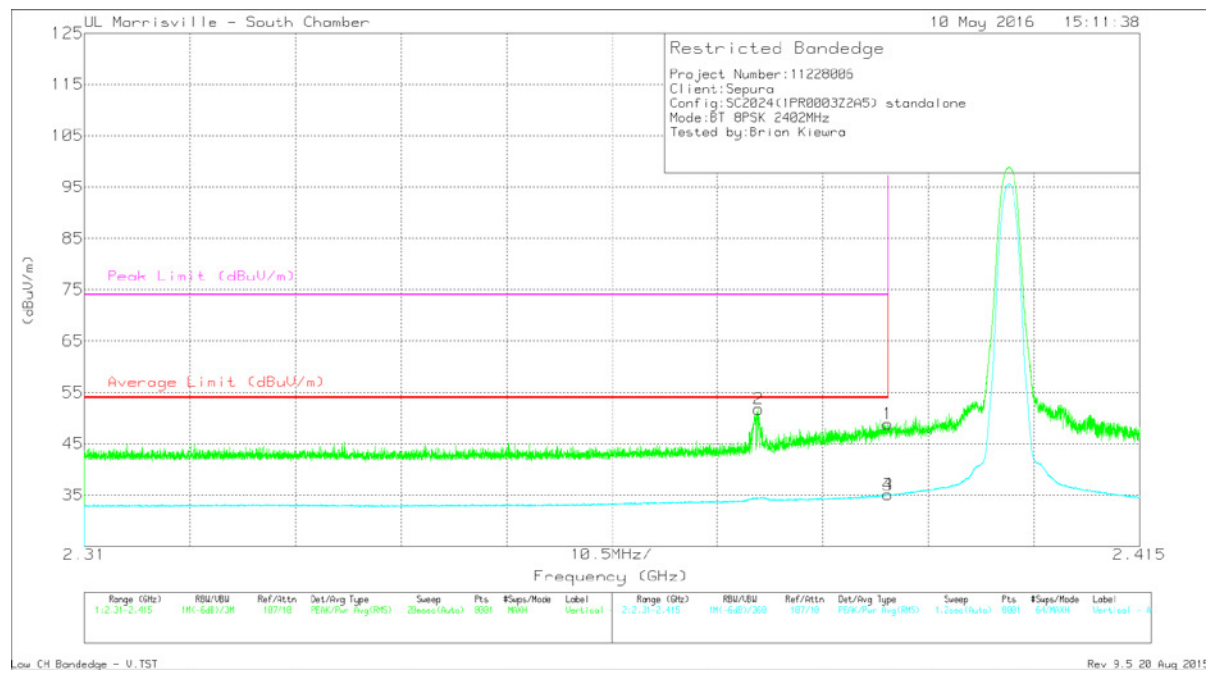

Marker	Frequency (GHz)	Meter Reading (dBuV)	Det	AF AT0069 (dB/m)	Amp/Cbl/Filtr/Pad (dB)	Corrected Reading (dBuV/m)	Average Limit (dBuV/m)	Margin (dB)	Peak Limit (dBuV/m)	PK Margin (dB)	Azimuth (Degs)	Height (cm)	Polarity
2	* 2.377	43.74	Pk	32.1	-24.1	51.74	-	-	74	-22.26	40	115	V
1	* 2.39	40.85	Pk	32.2	-24.2	48.85	-	-	74	-25.15	40	115	V
3	* 2.39	27.06	V1TR	32.2	-24.2	35.06	54	-18.94	-	-	40	115	V
4	* 2.39	27.08	V1TR	32.2	-24.2	35.08	54	-18.92	-	-	40	115	V

* - indicates frequency in CFR47 Pt 15 / IC RSS-Restricted Band

Pk - Peak detector

V1TR: VB=1/Ton, where: Ton is packet duration

RESTRICTED BANDEGE (LOW CHANNEL, CHARGER)

LOW CHANNEL RESTRICTED, HORIZ

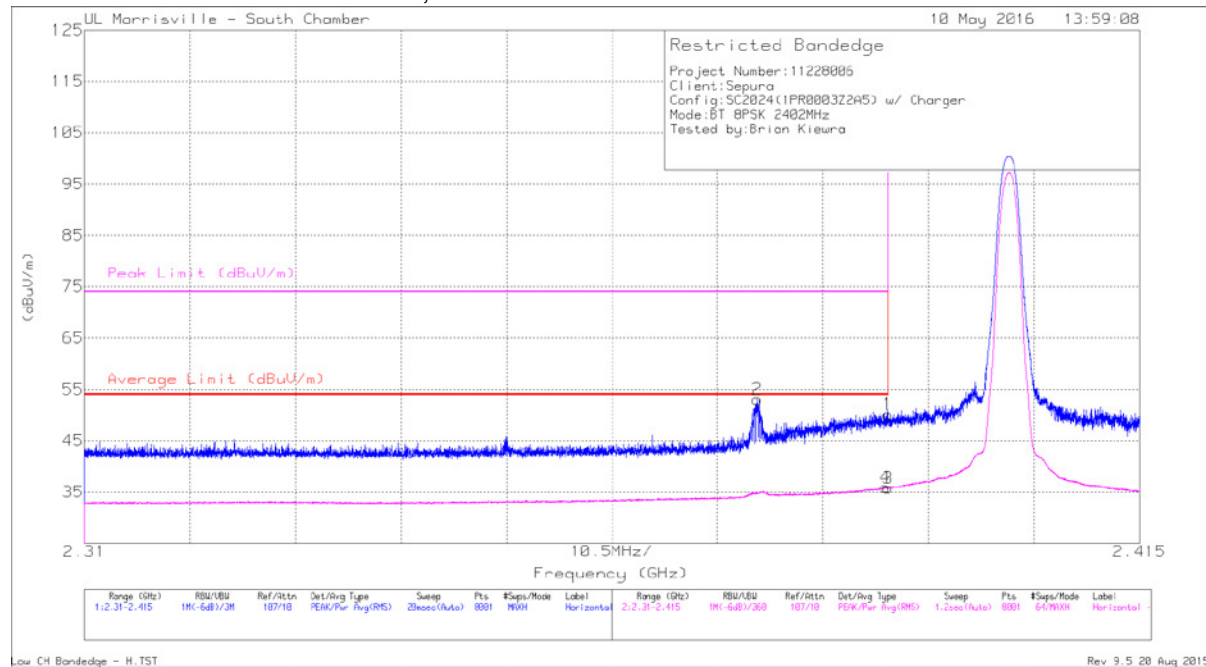

Marker	Frequency (GHz)	Meter Reading (dBuV)	Det	AF AT0069 (dB/m)	Amp/Cbl/Filtr/Pad (dB)	Corrected Reading (dBuV/m)	Average Limit (dBuV/m)	Margin (dB)	Peak Limit (dBuV/m)	PK Margin (dB)	Azimuth (Degs)	Height (cm)	Polarity
1	* 2.39	42.11	Pk	32.2	-24.2	50.11	-	-	74	-23.89	162	238	H
2	* 2.377	45.06	Pk	32.1	-24.1	53.06	-	-	74	-20.94	162	238	H
3	* 2.39	27.77	V1TR	32.2	-24.2	35.77	54	-18.23	-	-	162	238	H
4	* 2.39	27.9	V1TR	32.2	-24.2	35.9	54	-18.1	-	-	162	238	H

* - indicates frequency in CFR47 Pt 15 / IC RSS-Restricted Band

Pk - Peak detector

V1TR: VB=1/Ton, where: Ton is packet duration

LOW CHANNEL RESTRICTED, VERT

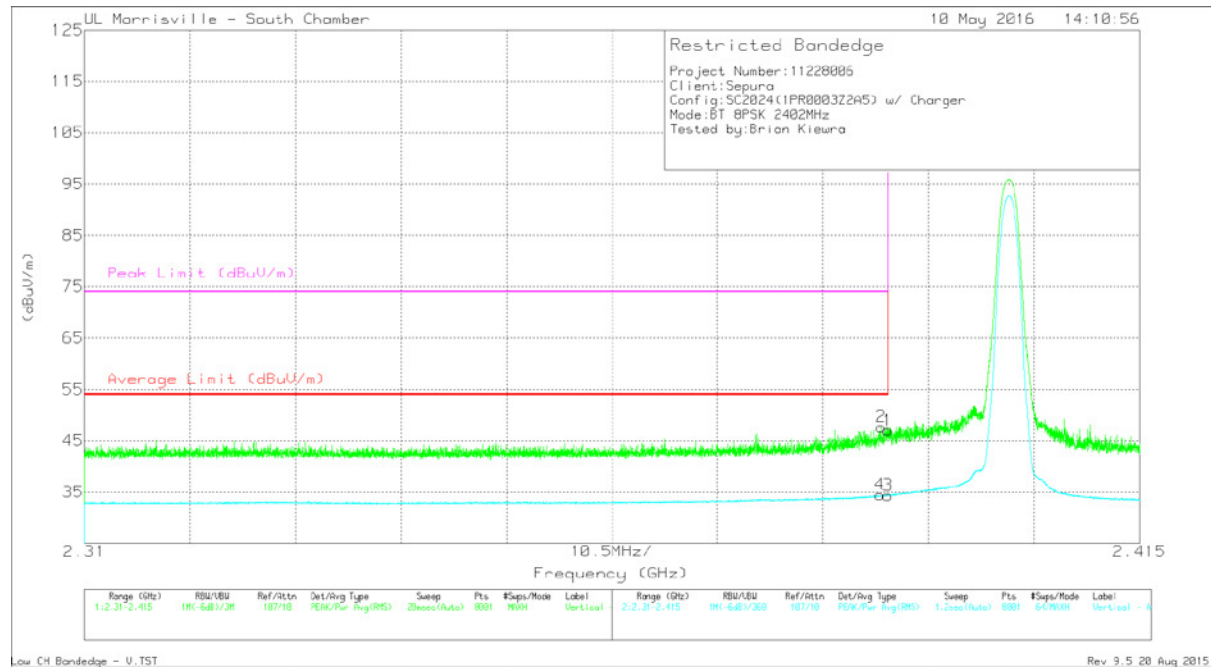

Marker	Frequency (GHz)	Meter Reading (dBuV)	Det	AF AT0069 (dB/m)	Amp/Cbl/Filtr/Pad (dB)	Corrected Reading (dBuV/m)	Average Limit (dBuV/m)	Margin (dB)	Peak Limit (dBuV/m)	PK Margin (dB)	Azimuth (Degs)	Height (cm)	Polarity
1	* 2.39	39	Pk	32.2	-24.2	47	-	-	74	-27	334	348	V
2	* 2.389	39.6	Pk	32.2	-24.1	47.7	-	-	74	-26.3	334	348	V
3	* 2.39	26.36	V1TR	32.2	-24.2	34.36	54	-19.64	-	-	334	348	V
4	* 2.389	26.4	V1TR	32.2	-24.1	34.5	54	-19.5	-	-	334	348	V

* - indicates frequency in CFR47 Pt 15 / IC RSS-Restricted Band
 Pk - Peak detector
 V1TR: VB=1/Ton, where: Ton is packet duration

RESTRICTED BANDEDGE (HIGH CHANNEL, STANDALONE)

HIGH CHANNEL RESTRICTED, HORIZ

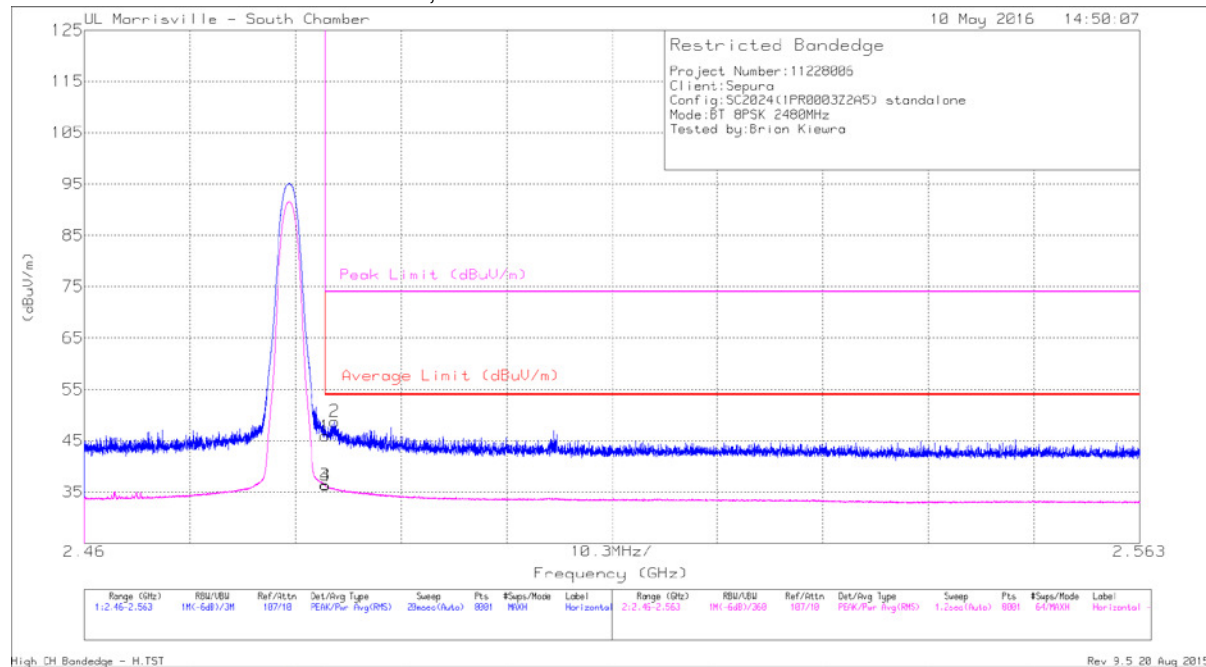

Marker	Frequency (GHz)	Meter Reading (dBuV)	Det	AF AT0069 (dB/m)	Amp/Cbl/Filtr/Pad (dB)	Corrected Reading (dBuV/m)	Average Limit (dBuV/m)	Margin (dB)	Peak Limit (dBuV/m)	PK Margin (dB)	Azimuth (Degs)	Height (cm)	Polarity
1	* 2.484	38.22	PK	32.4	-24.7	45.92	-	-	74	-28.08	210	292	H
2	* 2.484	41.06	Pk	32.4	-24.7	48.76	-	-	74	-25.24	210	292	H
3	* 2.484	28.71	V1TR	32.4	-24.7	36.41	54	-17.59	-	-	210	292	H
4	* 2.484	28.56	V1TR	32.4	-24.7	36.26	54	-17.74	-	-	210	292	H

* - indicates frequency in CFR47 Pt 15 / IC RSS-Restricted Band

Pk - Peak detector

V1TR: VB=1/Ton, where: Ton is packet duration

HIGH CHANNEL RESTRICTED, VERT

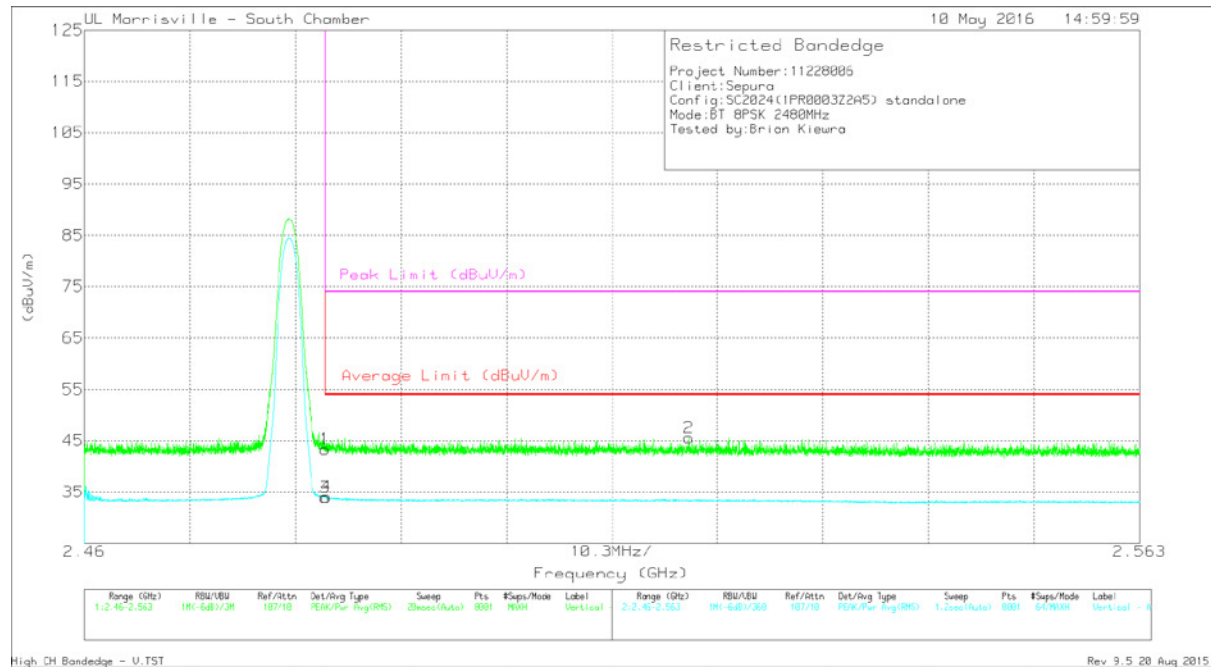

Marker	Frequency (GHz)	Meter Reading (dBuV)	Det	AF AT0069 (dB/m)	Amp/Cbl/Filtr/Pad (dB)	Corrected Reading (dBuV/m)	Average Limit (dBuV/m)	Margin (dB)	Peak Limit (dBuV/m)	PK Margin (dB)	Azimuth (Degs)	Height (cm)	Polarity
1	* 2.484	35.67	Pk	32.4	-24.7	43.37	-	-	74	-30.63	323	161	V
3	* 2.484	26.23	V1TR	32.4	-24.7	33.93	54	-20.07	-	-	323	161	V
4	* 2.484	26.33	V1TR	32.4	-24.7	34.03	54	-19.97	-	-	323	161	V
2	2.519	37.95	Pk	32.5	-24.9	45.55	-	-	74	-28.45	323	161	V

* - indicates frequency in CFR47 Pt 15 / IC RSS-Restricted Band

Pk - Peak detector

V1TR: VB=1/Ton, where: Ton is packet duration

RESTRICTED BANDEDGE (HIGH CHANNEL, CHARGER)

HIGH CHANNEL RESTRICTED, HORIZ

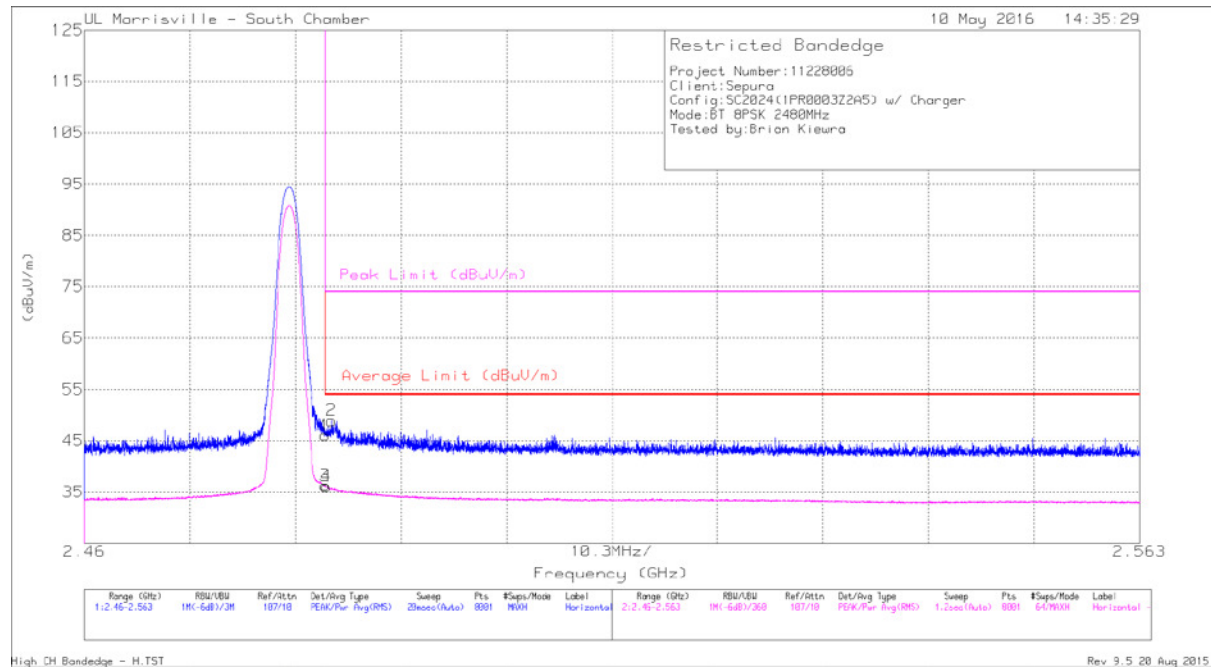

Marker	Frequency (GHz)	Meter Reading (dBuV)	Det	AF AT0069 (dB/m)	Amp/Cbl /Filtr/Pad (dB)	Corrected Reading (dBuV/m)	Average Limit (dBuV/m)	Margin (dB)	Peak Limit (dBuV/m)	PK Margin (dB)	Azimuth (Degs)	Height (cm)	Polarity
1	* 2.484	38.36	Pk	32.4	-24.7	46.06	-	-	74	-27.94	243	376	H
2	* 2.484	41.24	Pk	32.4	-24.7	48.94	-	-	74	-25.06	243	376	H
3	* 2.484	28.58	V1TR	32.4	-24.7	36.28	54	-17.72	-	-	243	376	H
4	* 2.484	28.4	V1TR	32.4	-24.7	36.1	54	-17.9	-	-	243	376	H

* - indicates frequency in CFR47 Pt 15 / IC RSS-Restricted Band

Pk - Peak detector

V1TR: VB=1/Ton, where: Ton is packet duration

HIGH CHANNEL RESTRICTED, VERT

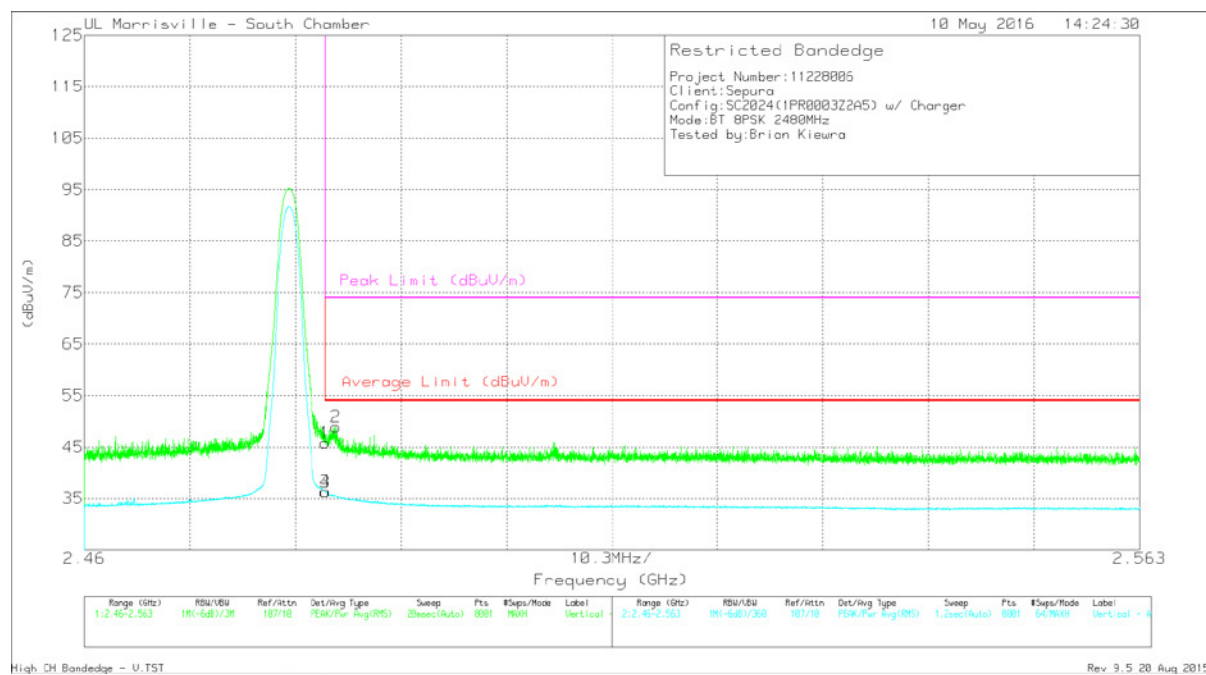

Marker	Frequency (GHz)	Meter Reading (dBuV)	Det	AF AT0069 (dB/m)	Amp/Cbl/Filtr/Pad (dB)	Corrected Reading (dBuV/m)	Average Limit (dBuV/m)	Margin (dB)	Peak Limit (dBuV/m)	PK Margin (dB)	Azimuth (Degs)	Height (cm)	Polarity
1	* 2.484	38.09	Pk	32.4	-24.7	45.79	-	-	74	-28.21	17	387	V
2	* 2.485	41.19	Pk	32.4	-24.7	48.89	-	-	74	-25.11	17	387	V
3	* 2.484	28.59	V1TR	32.4	-24.7	36.29	54	-17.71	-	-	17	387	V
4	* 2.484	28.61	V1TR	32.4	-24.7	36.31	54	-17.69	-	-	17	387	V

* - indicates frequency in CFR47 Pt 15 / IC RSS-Restricted Band

Pk - Peak detector

V1TR: VB=1/Ton, where: Ton is packet duration

HARMONICS AND SPURIOUS EMISSIONS

STANDALONE LOW CHANNEL

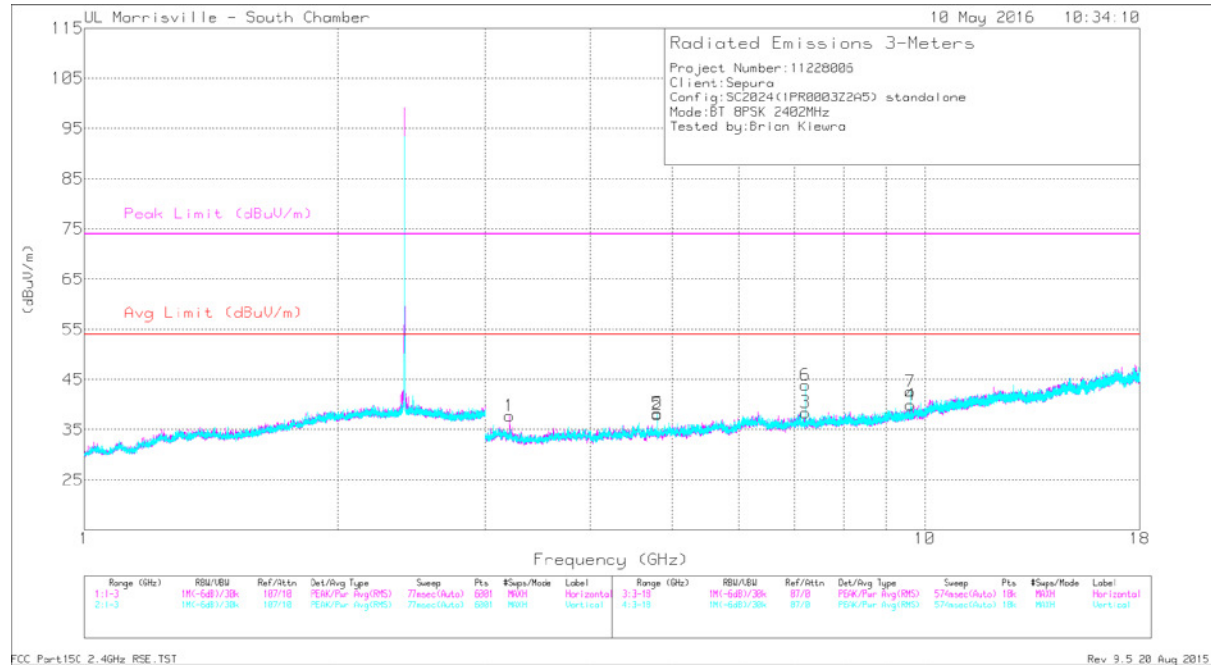

Marker	Frequency (GHz)	Meter Reading (dBuV)	Det	AF AT0069 (dB/m)	Amp/Cbl/ fltr/Pad (dB)	Corrected Reading (dBuV/m)	Avg Limit (dBuV/m)	Margin (dB)	Peak Limit (dBuV/m)	PK Margin (dB)	Azimuth (Degs)	Height (cm)	Polarity
2	* 4.804	44.03	PK-U	34	-31.7	46.33	-	-	74	-27.67	68	260	H
	* 4.804	34.66	V1TR	34	-31.7	36.96	54	-17.04	-	-	68	260	H
5	* 4.804	42.9	PK-U	34	-31.7	45.2	-	-	74	-28.8	241	101	V
	* 4.804	34.09	V1TR	34	-31.7	36.39	54	-17.61	-	-	241	101	V
1	3.202	37.79	Pk	33.4	-33.4	37.79	-	-	-	-	0-360	102	H
3	7.206	31.54	Pk	35.6	-28.7	38.44	-	-	-	-	0-360	199	H
4	9.608	30.44	Pk	36.6	-27.1	39.94	-	-	-	-	0-360	199	H
6	7.206	37.01	Pk	35.6	-28.7	43.91	-	-	-	-	0-360	199	V
7	9.608	33.15	Pk	36.6	-27.1	42.65	-	-	-	-	0-360	102	V

* - indicates frequency in CFR47 Pt 15 / IC RSS-Restricted Band

Pk - Peak detector

PK-U: Maximum Peak

V1TR: VB=1/Ton, where: Ton is packet duration

STANDALONE MID CHANNEL

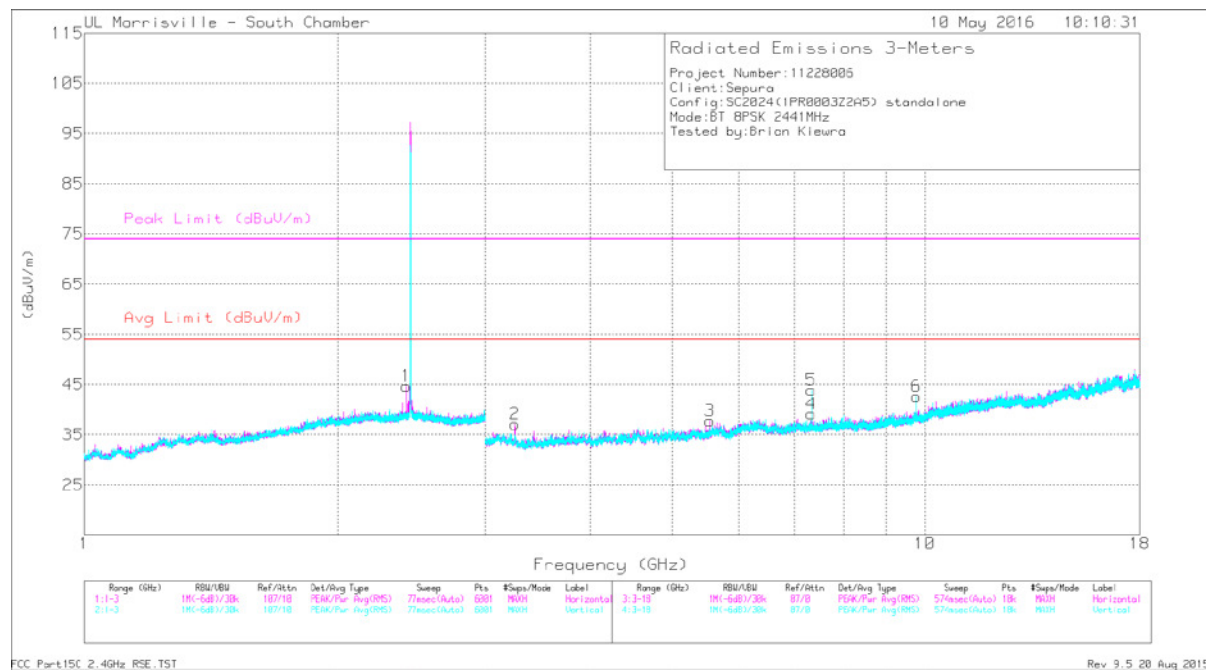

Marker	Frequency (GHz)	Meter Reading (dBuV)	Det	AF AT0069 (dB/m)	Amp/Cbl/Filtr/Pad (dB)	Corrected Reading (dBuV/m)	Avg Limit (dBuV/m)	Margin (dB)	Peak Limit (dBuV/m)	PK Margin (dB)	Azimuth (Degs)	Height (cm)	Polarity
4	* 7.323	38.76	PK-U	35.5	-28.4	45.86	-	-	74	-28.14	209	166	H
	* 7.323	29.4	V1TR	35.5	-28.4	36.5	54	-17.5	-	-	209	166	H
5	* 7.323	40.98	PK-U	35.5	-28.4	48.08	-	-	74	-25.92	267	167	V
	* 7.323	32.47	V1TR	35.5	-28.4	39.57	54	-14.43	-	-	267	167	V
1	2.415	36.8	Pk	32.3	-24.4	44.7	-	-	-	-	0-360	102	H
2	3.254	37.72	Pk	33.1	-33.7	37.12	-	-	-	-	0-360	102	H
3	5.548	34.67	Pk	34.6	-31.5	37.77	-	-	-	-	0-360	102	H
6	9.763	32.21	Pk	36.8	-26.4	42.61	-	-	-	-	0-360	101	V

* - indicates frequency in CFR47 Pt 15 / IC RSS-Restricted Band

Pk - Peak detector

PK-U: Maximum Peak

V1TR: VB=1/Ton, where: Ton is packet duration

STANDALONE HIGH CHANNEL

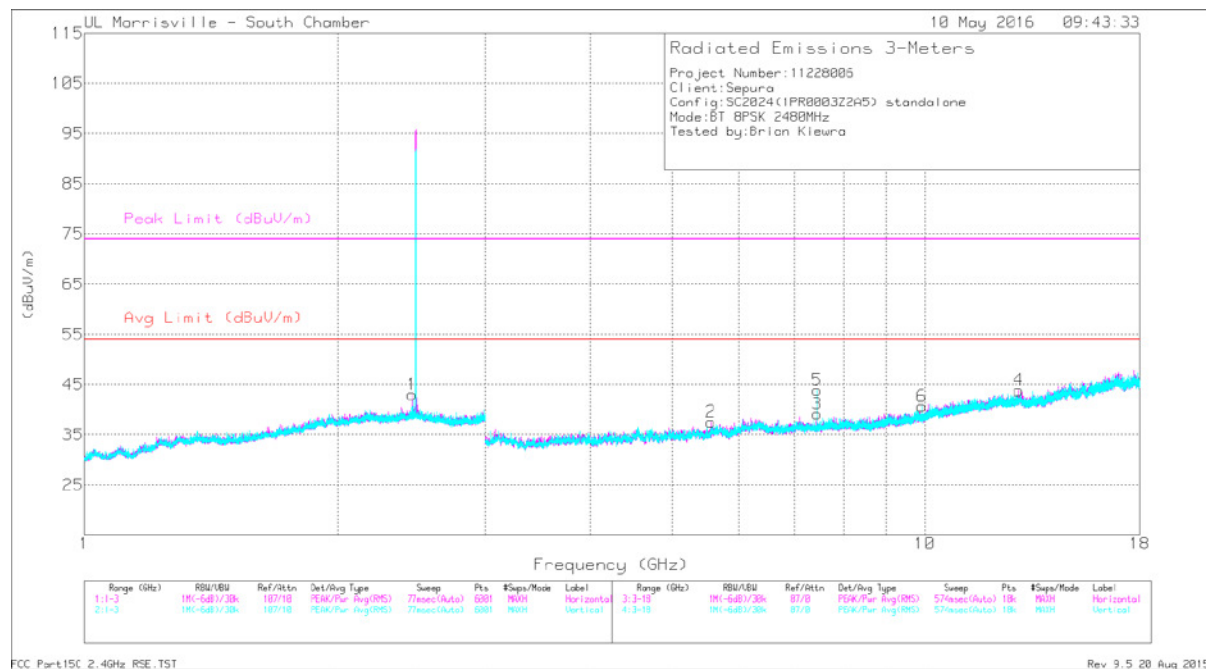

Marker	Frequency (GHz)	Meter Reading (dBuV)	Det	AF AT0069 (dB/m)	Amp/Cbl/Filtr/Pad (dB)	Corrected Reading (dBuV/m)	Avg Limit (dBuV/m)	Margin (dB)	Peak Limit (dBuV/m)	PK Margin (dB)	Azimuth (Degs)	Height (cm)	Polarity
3	* 7.44	39.11	PK-U	35.5	-28.7	45.91	-	-	74	-28.09	217	185	H
	* 7.44	28.51	V1TR	35.5	-28.7	35.31	54	-18.69	-	-	217	185	H
5	* 7.44	42.06	PK-U	35.5	-28.7	48.86	-	-	74	-25.14	300	205	V
	* 7.44	33.55	V1TR	35.5	-28.7	40.35	54	-13.65	-	-	300	205	V
1	2.454	35.21	Pk	32.3	-24.5	43.01	-	-	-	-	0-360	199	H
2	5.567	34.15	Pk	34.6	-31.2	37.55	-	-	-	-	0-360	102	H
6	9.919	30.17	Pk	37.1	-26.6	40.67	-	-	-	-	0-360	101	V
4	12.931	29.66	Pk	39.2	-25	43.86	-	-	-	-	0-360	102	H

* - indicates frequency in CFR47 Pt 15 / IC RSS-Restricted Band
 Pk - Peak detector
 PK-U: Maximum Peak
 V1TR: VB=1/Ton, where: Ton is packet duration

CHARGER LOW CHANNEL

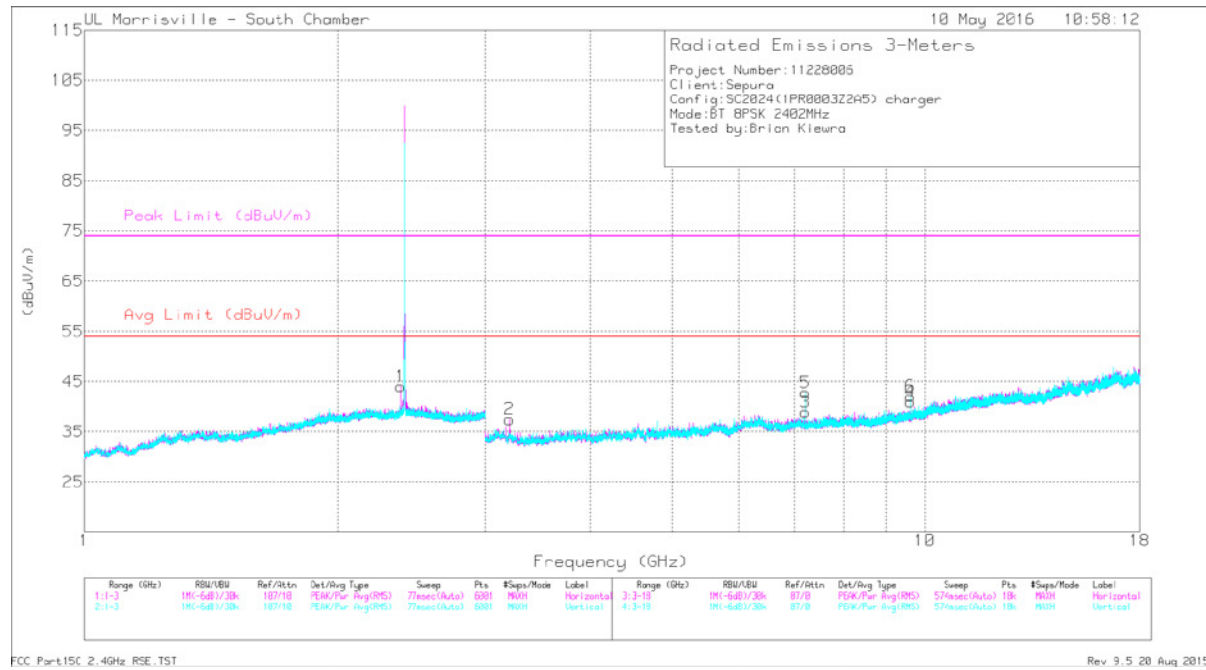

Marker	Frequency (GHz)	Meter Reading (dBuV)	Det	AF AT0069 (dB/m)	Amp/Cbl/Filtr/Pad (dB)	Corrected Reading (dBuV/m)	Avg Limit (dBuV/m)	Margin (dB)	Peak Limit (dBuV/m)	PK Margin (dB)	Azimuth (Degs)	Height (cm)	Polarity
1	* 2.377	43.59	PK-U	32.1	-24.1	51.59	-	-	74	-22.41	77	369	H
	* 2.377	26.2	V1TR	32.1	-24.1	34.2	54	-19.8	-	-	77	369	H
2	3.203	37.49	Pk	33.4	-33.4	37.49	-	-	-	-	0-360	101	H
3	7.206	32.02	Pk	35.6	-28.7	38.92	-	-	-	-	0-360	101	H
5	7.206	35.87	Pk	35.6	-28.7	42.77	-	-	-	-	0-360	200	V
6	9.607	32.56	Pk	36.6	-27.1	42.06	-	-	-	-	0-360	102	V
4	9.608	31.48	Pk	36.6	-27.1	40.98	-	-	-	-	0-360	101	H

* - indicates frequency in CFR47 Pt 15 / IC RSS-Restricted Band
 Pk - Peak detector
 PK-U: Maximum Peak
 V1TR: VB=1/Ton, where: Ton is packet duration

CHARGER MID CHANNEL

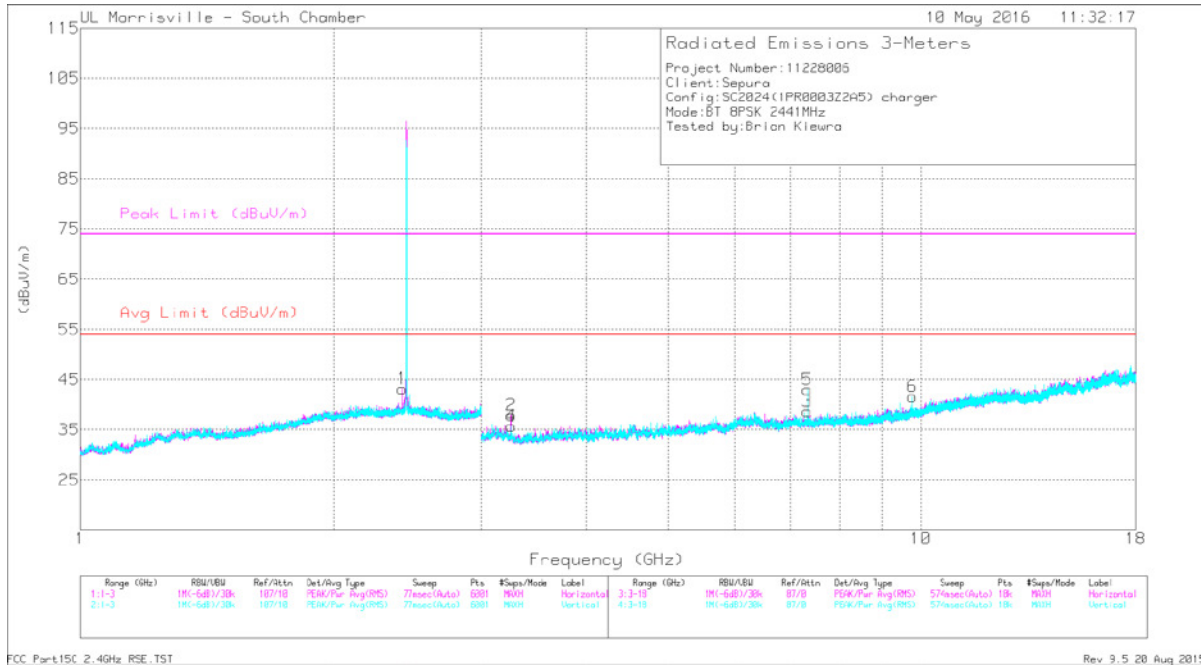

Marker	Frequency (GHz)	Meter Reading (dBuV)	Det	AF AT0069 (dB/m)	Amp/Cbl/Fltr/Pad (dB)	Corrected Reading (dBuV/m)	Avg Limit (dBuV/m)	Margin (dB)	Peak Limit (dBuV/m)	PK Margin (dB)	Azimuth (Degs)	Height (cm)	Polarity
3	* 7.323	38.62	PK-U	35.5	-28.4	45.72	-	-	74	-28.28	196	270	H
	* 7.323	27.84	V1TR	35.5	-28.4	34.94	54	-19.06	-	-	196	270	H
5	* 7.323	41.28	PK-U	35.5	-28.4	48.38	-	-	74	-25.62	282	216	V
	* 7.323	33.05	V1TR	35.5	-28.4	40.15	54	-13.85	-	-	282	216	V
1	2.416	35.29	Pk	32.3	-24.4	43.19	-	-	-	-	0-360	199	H
2	3.255	38.5	Pk	33.1	-33.7	37.9	-	-	-	-	0-360	199	H
4	3.255	36.29	Pk	33.1	-33.7	35.69	-	-	-	-	0-360	101	V
6	9.763	31.2	Pk	36.8	-26.4	41.6	-	-	-	-	0-360	199	V

* - indicates frequency in CFR47 Pt 15 / IC RSS-Restricted Band
 Pk - Peak detector
 PK-U: Maximum Peak
 V1TR: VB=1/Ton, where: Ton is packet duration

CHARGER HIGH CHANNEL

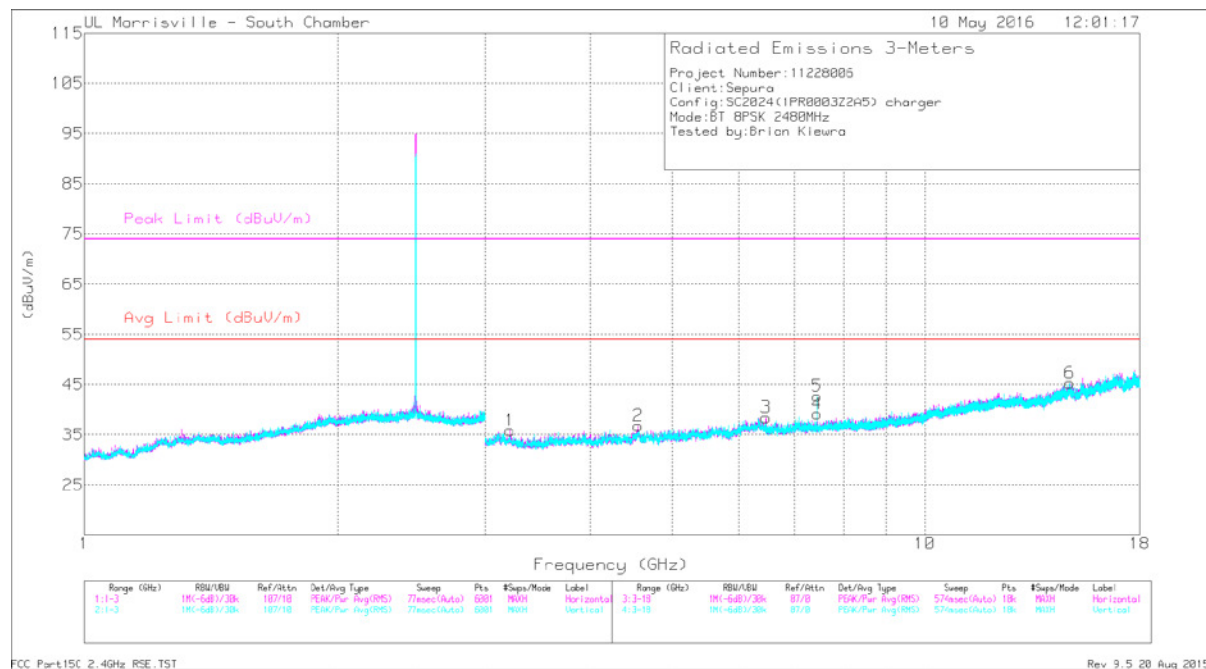

Marker	Frequency (GHz)	Meter Reading (dBuV)	Det	AF AT0069 (dB/m)	Amp/Cbl/ ftr/Pad (dB)	Corrected Reading (dBuV/m)	Avg Limit (dBuV/m)	Margin (dB)	Peak Limit (dBuV/m)	PK Margin (dB)	Azimuth (Degs)	Height (cm)	Polarity
2	* 4.556	40.25	PK-U	34	-32	42.25	-	-	74	-31.75	339	247	H
	* 4.558	29	V1TR	34	-32	31	54	-23	-	-	339	247	H
4	* 7.441	39.28	PK-U	35.5	-28.7	46.08	-	-	74	-27.92	16	390	H
	* 7.44	28.92	V1TR	35.5	-28.7	35.72	54	-18.28	-	-	16	390	H
5	* 7.44	41.65	PK-U	35.5	-28.7	48.45	-	-	74	-25.55	282	188	V
	* 7.44	33.18	V1TR	35.5	-28.7	39.98	54	-14.02	-	-	282	188	V
1	3.21	35.66	Pk	33.4	-33.2	35.86	-	-	-	-	0-360	102	H
3	6.469	33.15	Pk	35.4	-30.1	38.45	-	-	-	-	0-360	102	H
6	14.875	29.01	Pk	39.9	-23.6	45.31	-	-	-	-	0-360	199	V

* - indicates frequency in CFR47 Pt 15 / IC RSS-Restricted Band
 Pk - Peak detector
 PK-U: Maximum Peak
 V1TR: VB=1/Ton, where: Ton is packet duration

9.2.3. WORSE-CASE 18-26GHz

SPURIOUS EMISSIONS 18 to 26GHz (STANDALONE)

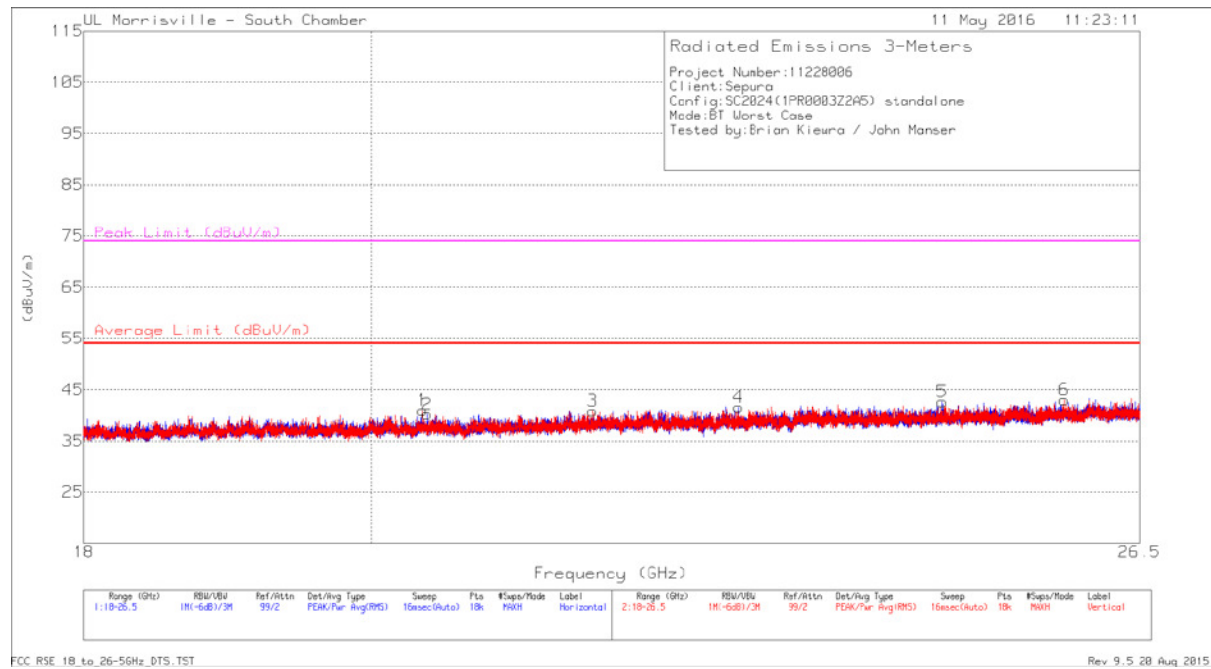

Marker	Frequency (GHz)	Meter Reading (dBuV)	Det	AF AT0076 (dB/m)	Amp/Cbl (dB)	Corrected Reading (dBuV/m)	Average Limit (dBuV/m)	Margin (dB)	Peak Limit (dBuV/m)	Margin (dB)	Azimuth (Degs)	Height (cm)	Polarity
2	* 20.411	46.36	PK-U	33.4	-40.3	39.46	-	-	74	-34.54	33	360	H
	* 20.41	35.77	V1TR	33.4	-40.3	28.87	54	-25.13	-	-	33	360	H
4	* 22.881	47.51	PK-U	33.7	-39.4	41.81	-	-	74	-32.19	344	187	H
	* 22.878	35.89	V1TR	33.7	-39.4	30.19	54	-23.81	-	-	344	187	H
1	* 20.38	46.95	PK-U	33.3	-39.9	40.35	-	-	74	-33.65	285	398	V
	* 20.379	35.82	V1TR	33.3	-39.9	29.22	54	-24.78	-	-	285	398	V
3	21.688	46.88	Pk	33.7	-39.7	40.88	-	-	-	-	0-360	202	V
5	24.654	46.58	Pk	34.6	-38.5	42.68	-	-	-	-	0-360	250	H
6	25.778	45.96	Pk	34.8	-37.7	43.06	-	-	-	-	0-360	252	V

* - indicates frequency in CFR47 Pt 15 / IC RSS-Restricted Band

Pk - Peak detector

PK-U: Maximum Peak

V1TR: VB=1/Ton, where: Ton is packet duration

SPURIOUS EMISSIONS 18 to 26GHz (CHARGER)

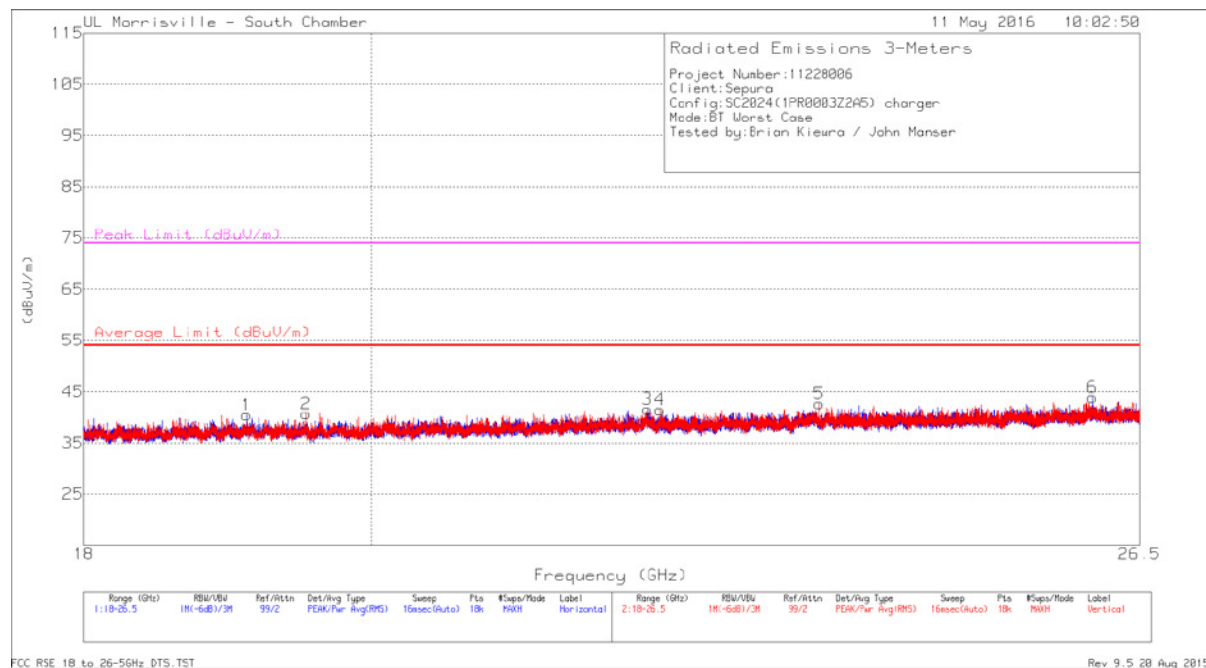

Marker	Frequency (GHz)	Meter Reading (dBuV)	Det	AF AT0076 (dB/m)	Amp/Cbl (dB)	Corrected Reading (dBuV/m)	Average Limit (dBuV/m)	Margin (dB)	Peak Limit (dBuV/m)	Margin (dB)	Azimuth (Degs)	Height (cm)	Polarity
1	* 19.107	48.18	PK-U	32.9	-40.8	40.28	-	-	74	-33.72	110	192	H
	* 19.107	36.5	V1TR	32.9	-40.8	28.6	54	-25.4	-	-	110	192	H
3	* 22.127	48.15	PK-U	33.9	-39.9	42.15	-	-	74	-31.85	0	291	H
	* 22.126	36.5	V1TR	33.9	-39.9	30.5	54	-23.5	-	-	0	291	H
2	* 19.529	50.74	PK-U	32.9	-40.4	43.24	-	-	74	-30.76	245	145	V
	* 19.529	41.47	V1TR	32.9	-40.4	33.97	54	-20.03	-	-	245	145	V
4	* 22.227	47.25	PK-U	33.7	-39.6	41.35	-	-	74	-32.65	203	160	V
	* 22.227	35.93	V1TR	33.7	-39.6	30.03	54	-23.97	-	-	203	160	V
5	23.562	47.68	Pk	34.2	-39.2	42.68	-	-	-	-	0-360	299	V
6	26.047	46.29	Pk	35.1	-37.5	43.89	-	-	-	-	0-360	249	H

* - indicates frequency in CFR47 Pt 15 / IC RSS-Restricted Band

Pk - Peak detector

PK-U: Maximum Peak

V1TR: VB=1/Ton, where: Ton is packet duration

9.3. WORST-CASE BELOW 1 GHz

Note: All measurements were made at a test distance of 3 m. The limits in the plots and tabular data are the FCC/IC limits extrapolated from the specification distance (300 m from 9-490 kHz and 30 m from 490 kHz – 30 MHz) to the measurement distance to clearly show the relative levels of fundamental and spurious emissions and demonstrate compliance with the requirement that the level of any spurious emissions be below the level of the intentionally transmitted signal. The extrapolation factor for the limits were 40*Log (specification distance / test distance). The anechoic chamber has been properly calibrated so that the measurement results correspond to what would be obtained from an open field sites.

SPURIOUS EMISSIONS 9kHz to 30MHz (WORST-CASE CONFIGURATION,STANDALONE)

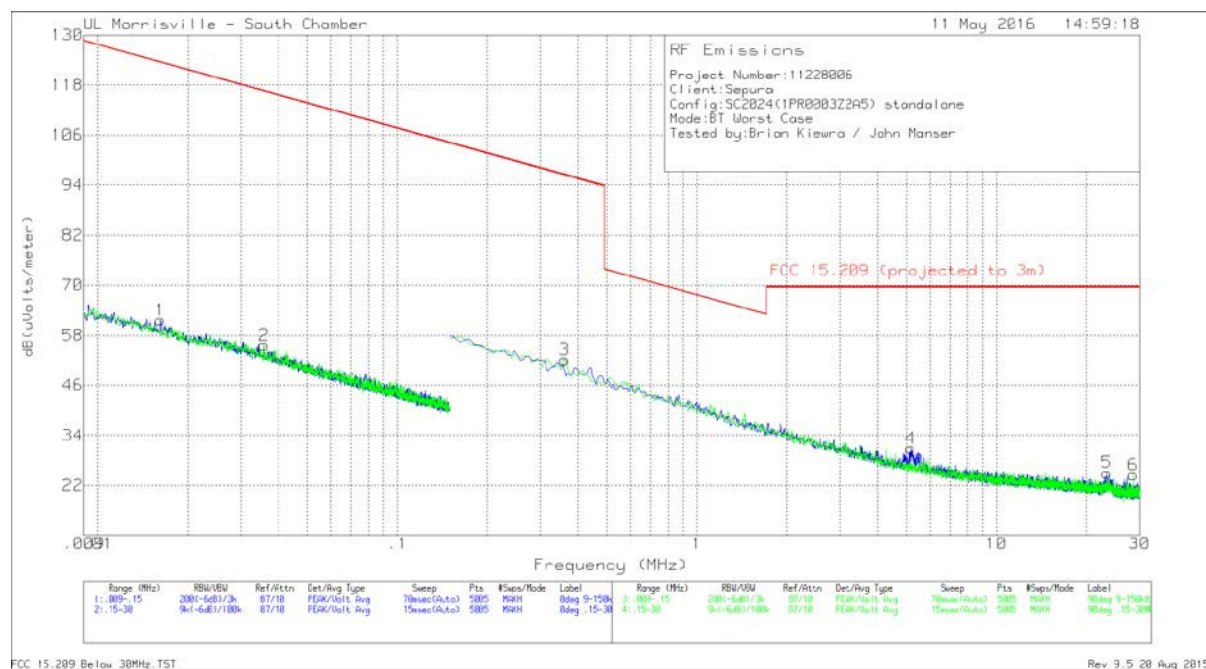

FCC_15_209_Below_30MHz_TST

Rev. 9.5.20 Aug. 2015.

Marker	Frequency (MHz)	Meter Reading (dBuV)	Det	AT0079 AF (dB/m)	Cbl (dB)	Corrected Reading dB(uVolts/meter)	FCC 15.209 (projected to 3m)	Margin (dB)	Azimuth (Degs)
1	.01622	45.13	Pk	16.4	.1	61.63	123.4	-61.77	0-360
2	.03588	41.85	Pk	13.6	.1	55.55	116.51	-60.96	0-360
3	.36176	40.16	Pk	11.9	.1	52.16	96.44	-44.28	0-360
4	5.16955	19.15	Pk	11.3	.4	30.85	69.54	-38.69	0-360
5	23.3121	14.86	Pk	9.4	.8	25.06	69.54	-44.48	0-360
6	28.59112	15.06	Pk	8.6	.9	24.56	69.54	-44.98	0-360

Pk - Peak detector

SPURIOUS EMISSIONS 9kHz to 30MHz (WORST-CASE CONFIGURATION,CHARGER)

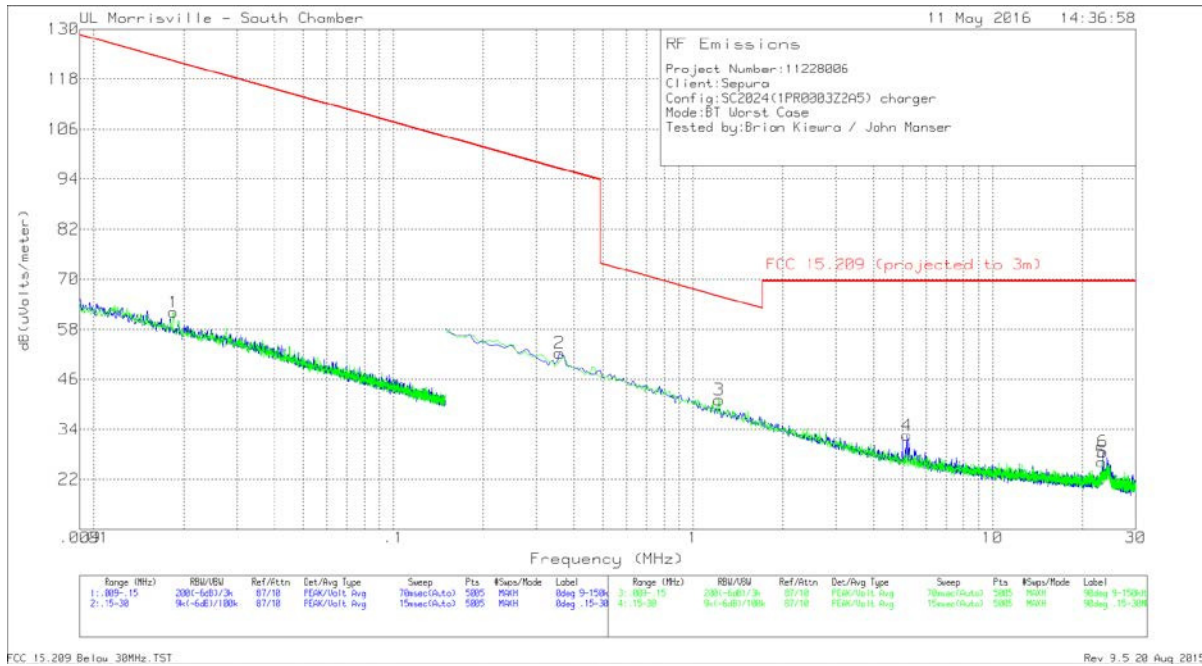

Marker	Frequency (MHz)	Meter Reading (dBuV)	Det	AT0079 AF (dB/m)	Cbl (dB)	Corrected Reading dB(uVolts/meter)	FCC 15.209 (projected to 3m)	Margin (dB)	Azimuth (Degs)
1	.01844	46.49	Pk	15.5	.1	62.09	122.29	-60.2	0-360
2	.35878	40.31	Pk	11.9	.1	52.31	96.51	-44.2	0-360
3	1.2237	28.96	Pk	11.9	.2	41.06	65.85	-24.79	0-360
4	5.16657	20.82	Pk	11.3	.4	32.52	69.54	-37.02	0-360
5	23.14508	15.87	Pk	9.5	.8	26.17	69.54	-43.37	0-360
6	23.28227	18.4	Pk	9.4	.8	28.6	69.54	-40.94	0-360

Pk - Peak detector

SPURIOUS EMISSIONS 30 TO 1000 MHz (WORST-CASE CONFIGURATION,STANDALONE)

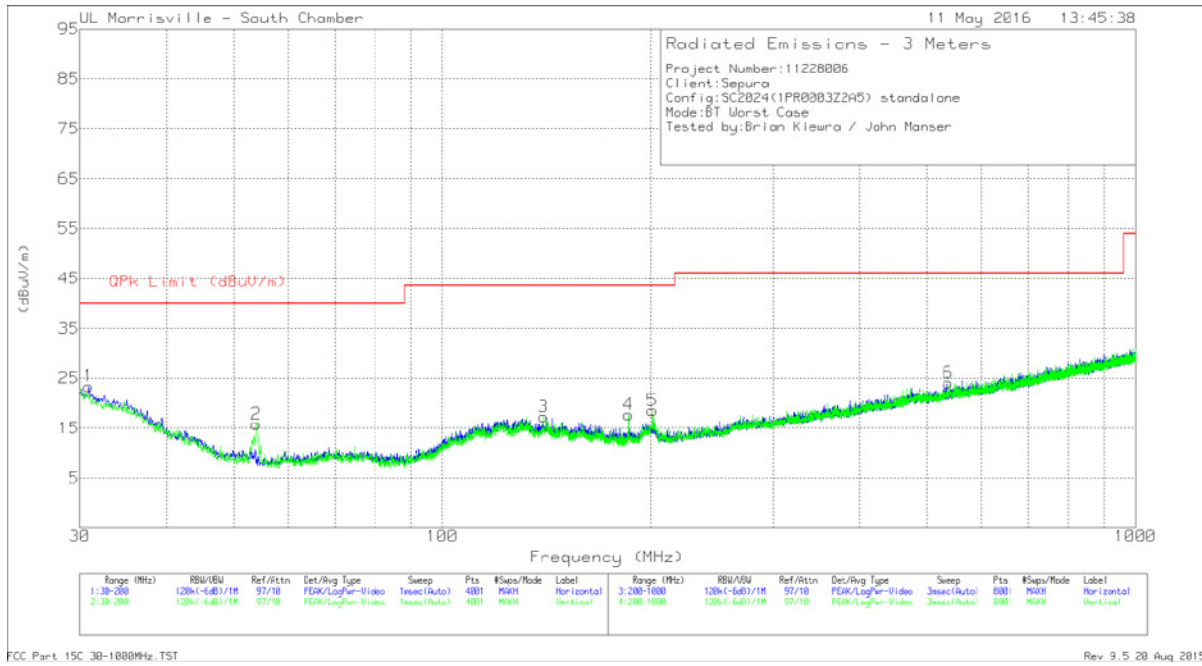

Marker	Frequency (MHz)	Meter Reading (dBuV)	Det	AF AT0074 (dB/m)	Port 0 Factors	Corrected Reading (dBuV/m)	QPk Limit (dBuV/m)	Margin (dB)	Azimuth (Degs)	Height (cm)	Polarity
1	30.8925	29.69	Pk	25.5	-31.8	23.39	40	-16.61	0-360	299	H
2	53.9275	35.52	Pk	11.9	-31.6	15.82	40	-24.18	0-360	102	V
3	139.99	30.48	Pk	17.5	-30.7	17.28	43.52	-26.24	0-360	102	V
4	185.635	32.31	Pk	15.8	-30.4	17.71	43.52	-25.81	0-360	102	V
5	201	31.61	Pk	17.1	-30.2	18.51	43.52	-25.01	0-360	199	V
6	537	30.07	Pk	22.7	-28.7	24.07	46.02	-21.95	0-360	199	V

Pk - Peak detector
 FCC Part 15C 30-1000MHz.TST
 Rev 9.5 20 Aug 2015

SPURIOUS EMISSIONS 30 TO 1000 MHz (WORST-CASE CONFIGURATION, CHARGER)

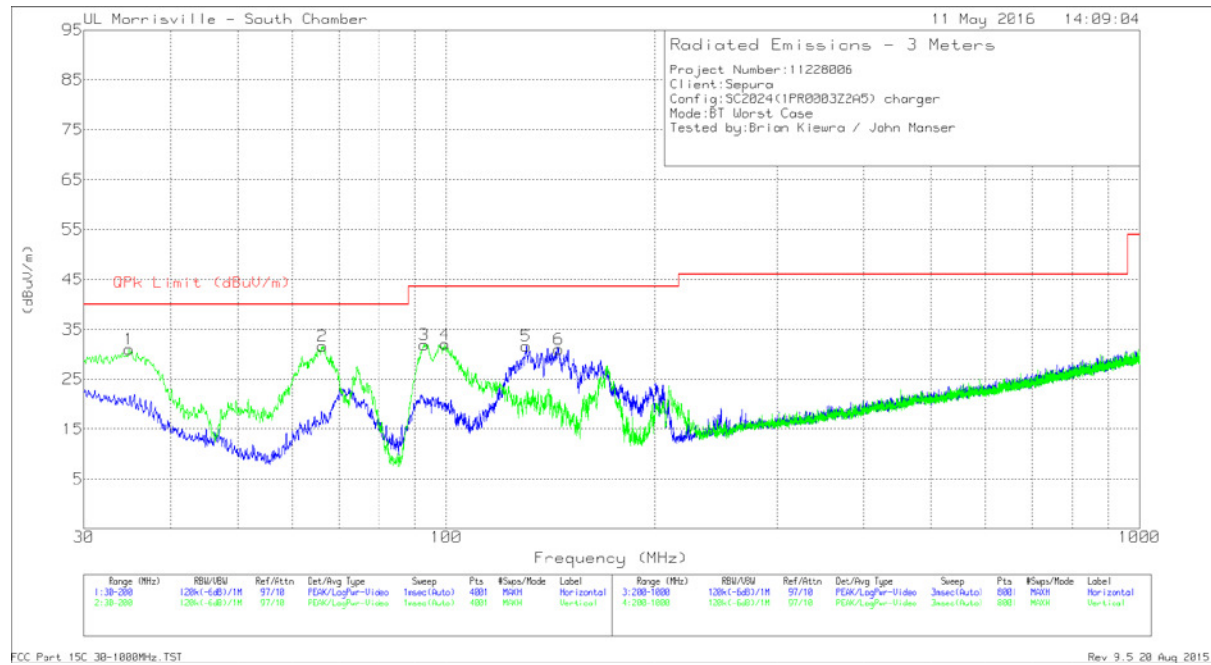

Marker	Frequency (MHz)	Meter Reading (dBuV)	Det	AF AT0074 (dB/m)	Port 0 Factors	Corrected Reading (dBuV/m)	QPk Limit (dBuV/m)	Margin (dB)	Azimuth (Degs)	Height (cm)	Polarity
1	34.845	40.31	Pk	22.4	-31.7	31.01	40	-8.99	0-360	102	V
2	66.295	50.59	Pk	12.2	-31.2	31.59	40	-8.41	0-360	102	V
3	92.985	50.53	Pk	12.3	-31	31.83	43.52	-11.69	0-360	102	V
4	99.53	48.76	Pk	14.3	-31.1	31.96	43.52	-11.56	0-360	102	V
5	130.47	44.22	Pk	18.1	-30.7	31.62	43.52	-11.9	0-360	199	H
6	145.2388	44.6	Pk	17.1	-30.7	31	43.52	-12.52	0-360	199	H

Pk - Peak detector
 FCC Part 15C 30-1000MHz.TST
 Rev 9.5 20 Aug 2015

10. POWER LINE CONDUCTED

LIMITS

ANSI C63.10 Section 6.2

FCC §15.207 (a)

RSS-Gen 7.2.2

Frequency of Emission (MHz)	Conducted Limit (dBuV)	
	Quasi-peak	Average
0.15-0.5	66 to 56*	56 to 46*
0.5-5	56	46
5-30	60	50

*Decreases with the logarithm of the frequency.

TEST PROCEDURE

The EUT is placed on a non-conducting table 40 cm from the vertical ground plane and 80 cm above the horizontal ground plane. The EUT is configured in accordance with ANSI C63.10.

The receiver is set to a resolution bandwidth of 9 kHz. Peak detection is used unless otherwise noted as quasi-peak or average.

Line conducted data is recorded for both NEUTRAL and HOT lines.

RESULTS

POWER LINE CONDUCTED RESULTS (CHARGER)

Range 1: Line-L1 .15 - 30MHz										
Marker	Frequency (MHz)	Meter Reading (dBuV)	Det	LISN VCF [dB]	Cb/Limiter (dB)	Corrected Reading dBuV	Class-B QP Limit	Margin (dB)	Class-B Avg Limit	Margin (dB)
3	.159	38.04	Pk	.2	10	48.24	65.52	-17.28	-	-
4	.159	6.41	Av	.2	10	16.61	-	-	55.52	-38.91
5	.372	30.5	Pk	.1	10	40.6	58.46	-17.86	-	-
6	.372	11.54	Av	.1	10	21.64	-	-	48.46	-26.82
11	22.128	21	Pk	.3	10.6	31.9	60	-28.1	-	-
12	22.155	4.76	Av	.3	10.6	15.66	-	-	50	-34.34

Pk - Peak detector
 Av - Average detection

Range 2: Line-L2 .15 - 30MHz										
Marker	Frequency (MHz)	Meter Reading (dBuV)	Det	LISN VCF [dB]	Cbl/Limiter (dB)	Corrected Reading dBuV	Class-B QP Limit	Margin (dB)	Class-B Avg Limit	Margin (dB)
1	.156	37.67	Pk	.2	10	47.87	65.67	-17.8	-	-
2	.156	7.38	Av	.2	10	17.58	-	-	55.67	-38.09
7	.366	26.32	Pk	.1	10	36.42	58.59	-22.17	-	-
8	.366	2.76	Av	.1	10	12.86	-	-	48.59	-35.73
9	8.904	25.03	Pk	.1	10.3	35.43	60	-24.57	-	-
10	8.895	7.37	Av	.1	10.3	17.77	-	-	50	-32.23

Pk - Peak detector
 Av - Average detection

11. SETUP PHOTOS

ANTENNA PORT CONDUCTED RF MEASUREMENT SETUP

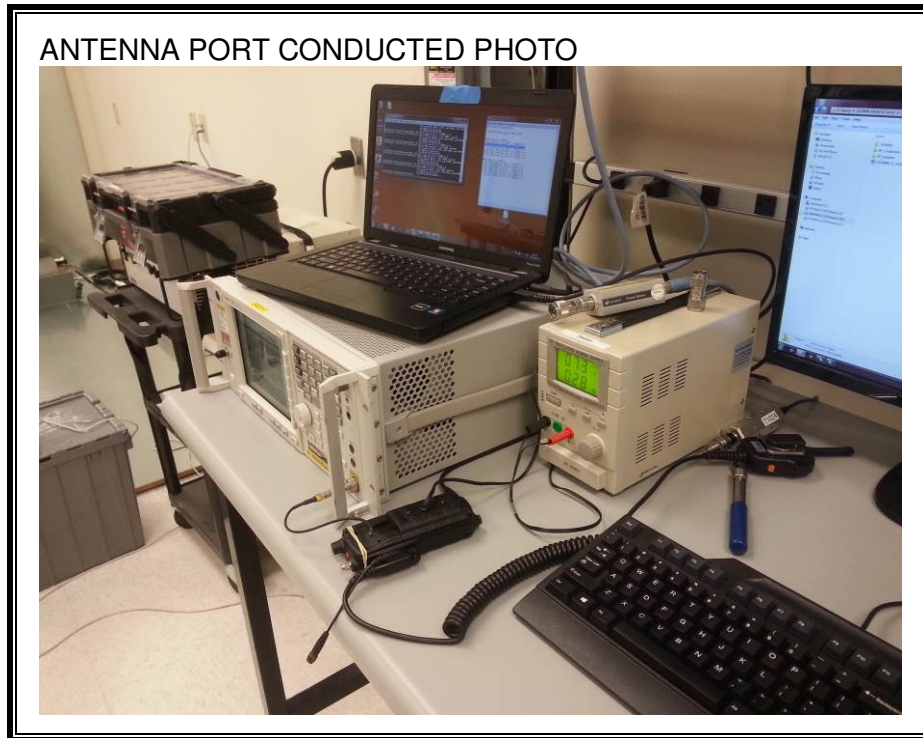

RADIATED RF MEASUREMENT SETUP (BELOW 1 GHz)

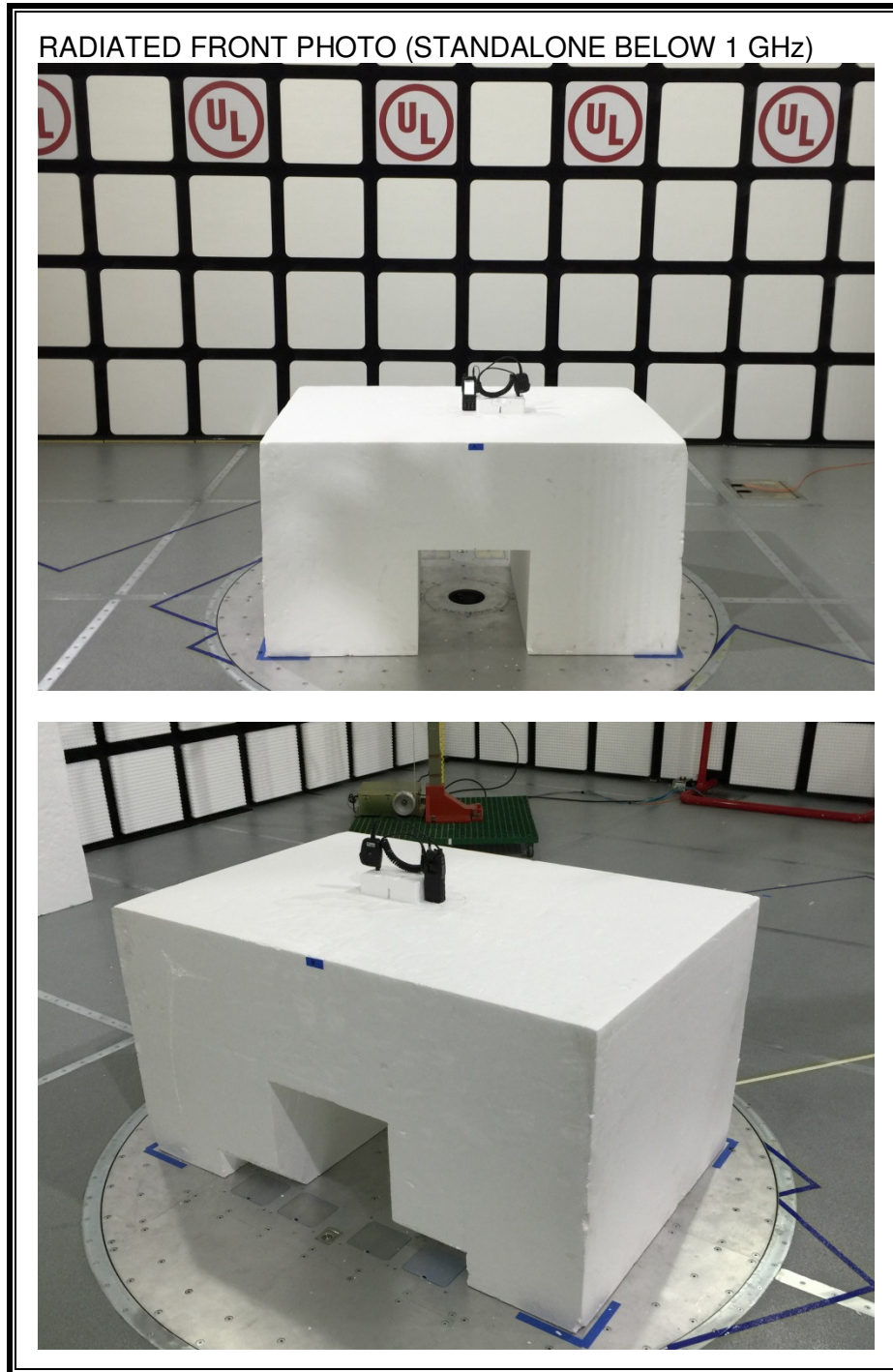

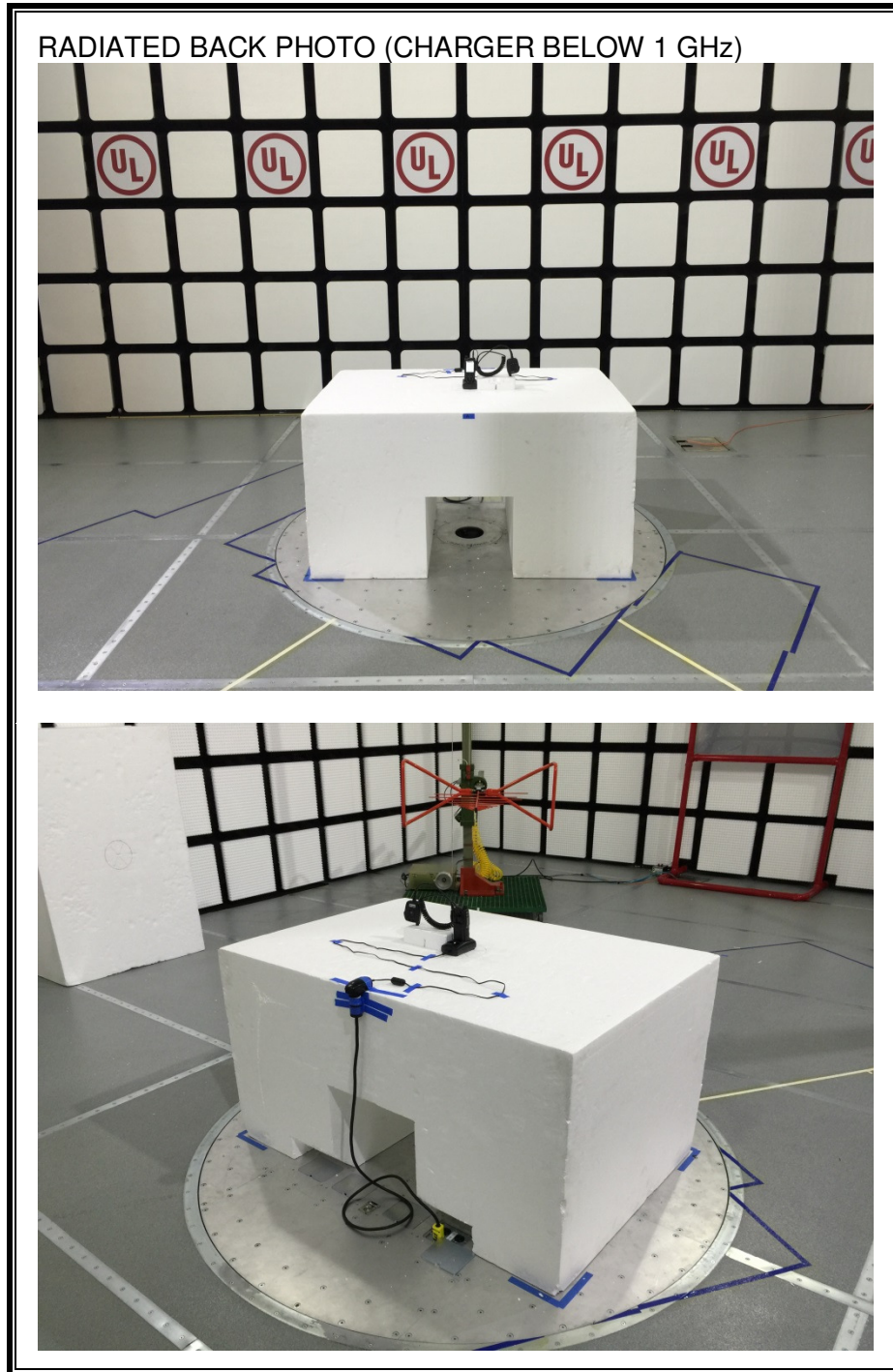

RADIATED RF MEASUREMENT SETUP (ABOVE 1 GHz)

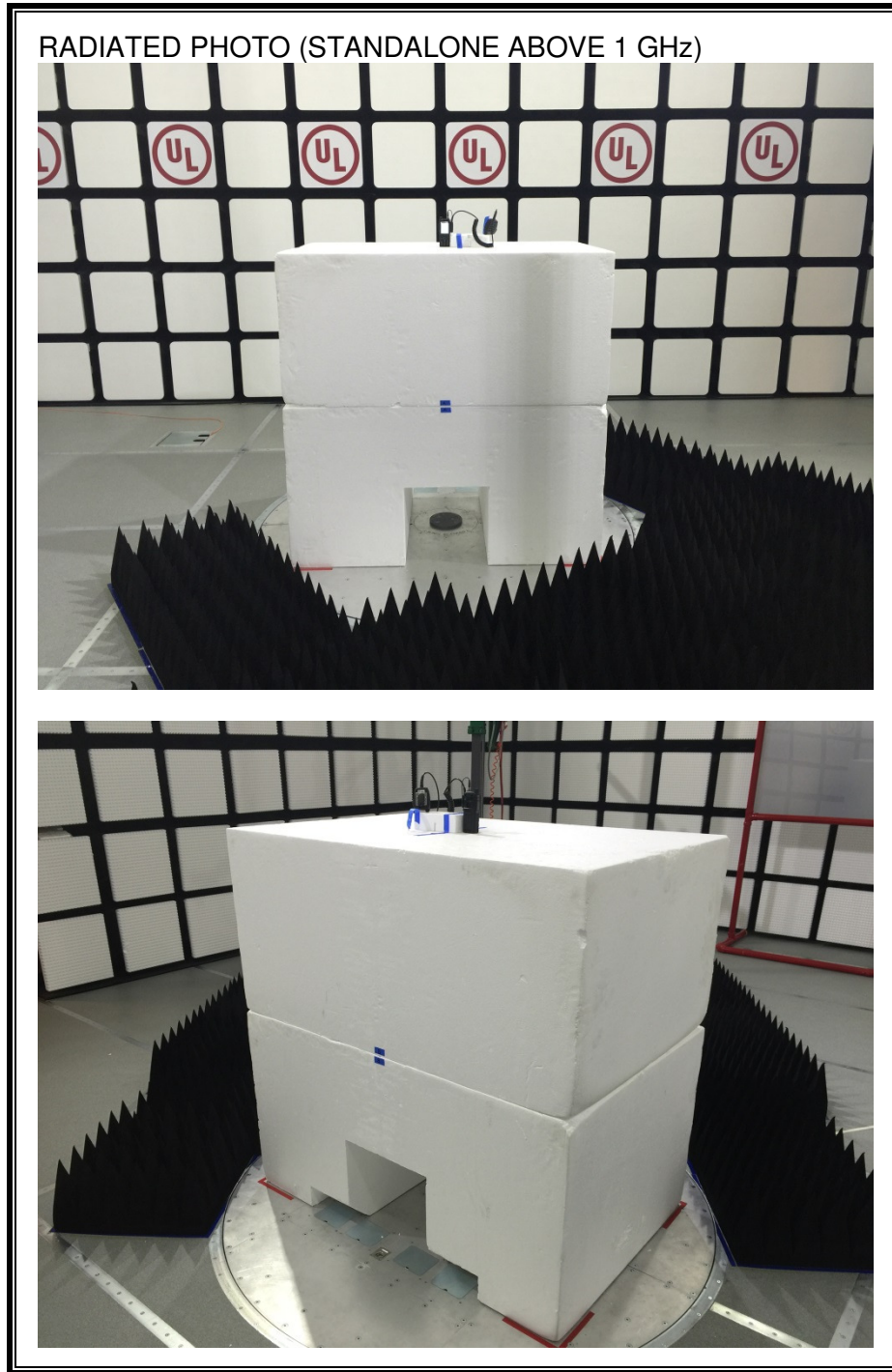

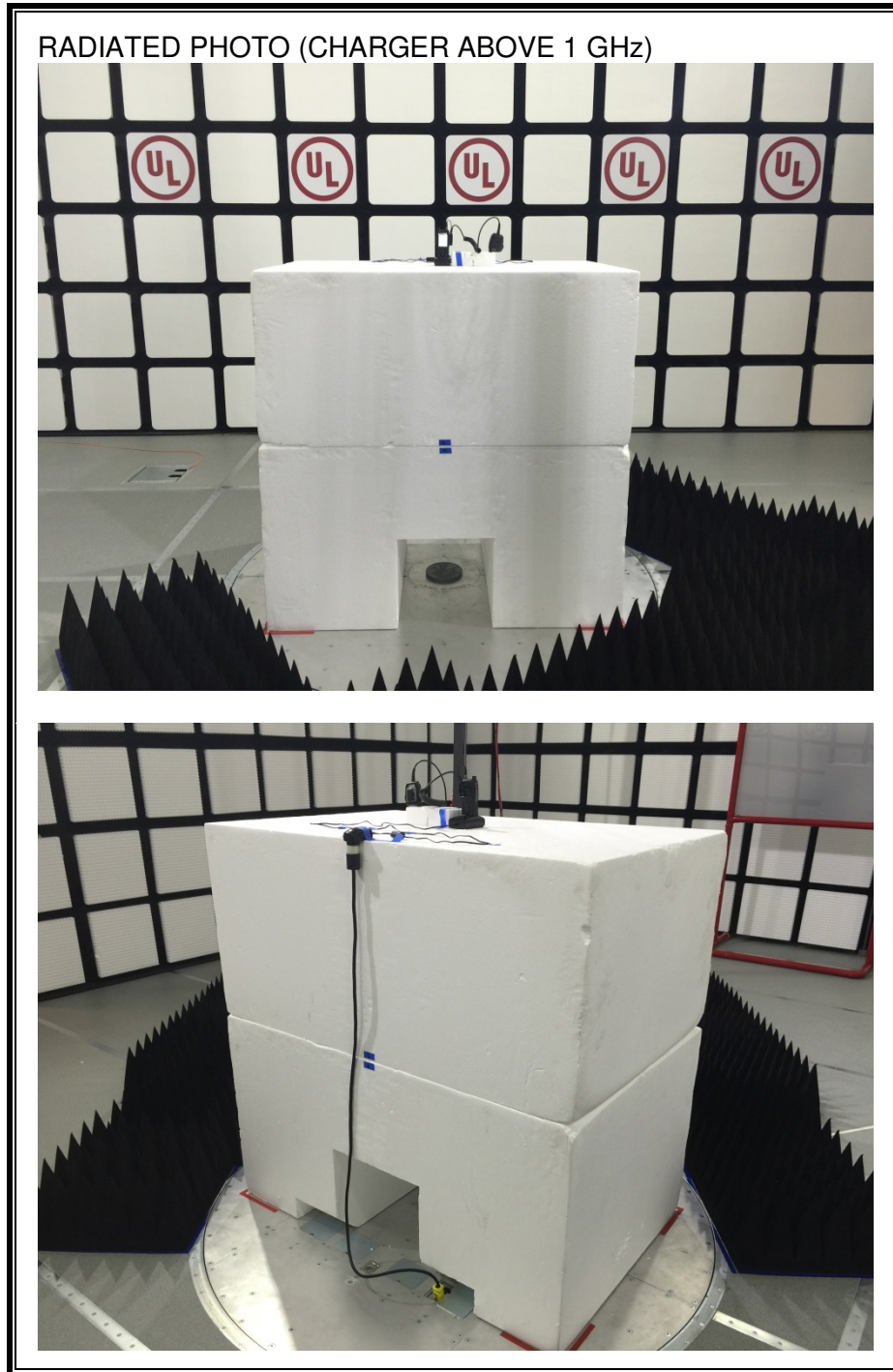

RADIATED RF MEASUREMENT SETUP FOR PORTABLE CONFIGURATION

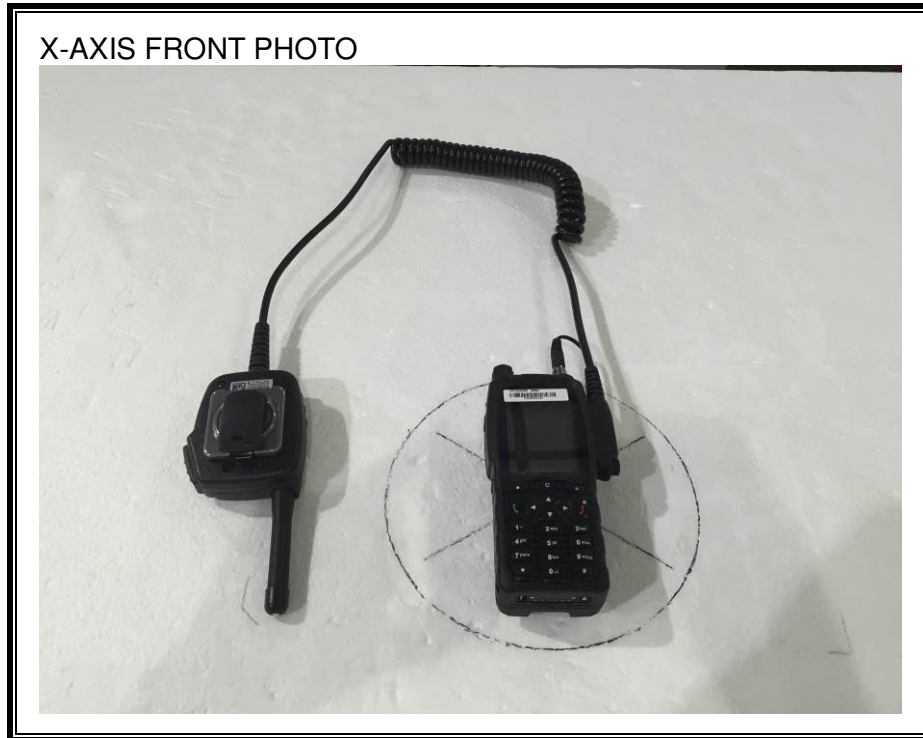



POWERLINE CONDUCTED EMISSIONS MEASUREMENT SETUP

LINE CONDUCTED FRONT PHOTO

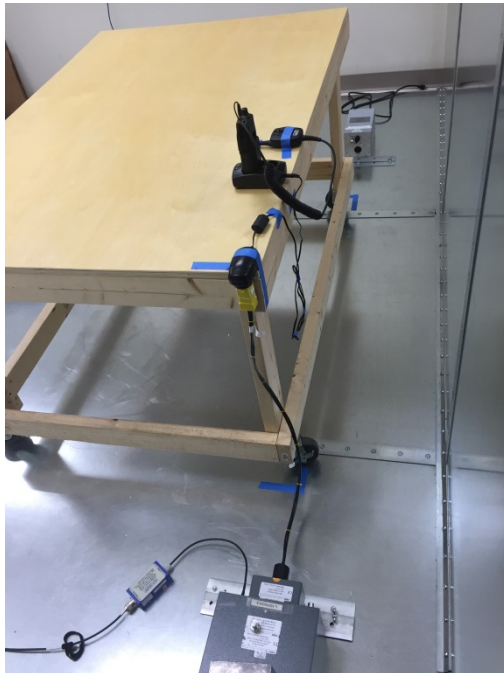

END OF REPORT