

TECHNICAL DESCRIPTION

PowerTrunk-T

BSR & BSR75. INSTALLATION GUIDE.



Document	F067207PT_2800b05
Product	PowerTrunk-T
Date	March 2018

WASTE MANAGEMENT



The symbol means that the product must be taken to separate collection at the product end-of-life. Do not dispose of these products as unsorted municipal waste.

PowerTrunk Inc. is the subsidiary of Teltronic S.A.U. responsible for business development, distribution and customer support for Teltronic's Land Mobile Radio products in North America. The company is headquartered in New Jersey. Teltronic S.A.U. distributes the same products for Land Mobile Radio under different trademarks and brand names in other regions of the world.

Disclaimer

Although every reasonable effort has been made to ensure the accuracy of the information contained herein and in any other referred document, this should not be construed as a commitment on the part of Teltronic S.A.U. and/or PowerTrunk Inc., and the liability of Teltronic S.A.U. and/or PowerTrunk Inc. for any errors and omissions shall be limited to the correction of such errors and omissions. Teltronic S.A.U. and/or PowerTrunk Inc. welcomes any comment as a way to improve any delivered documentation.

The information contained herein has been prepared for the use of appropriately trained personnel, and it is intended for the purpose of the agreement under which the information is submitted. Any party using or relying upon this information assumes full responsibility for such use and in no event shall Teltronic S.A.U. and/or PowerTrunk Inc. be liable to anyone for special, collateral, incidental, or consequential damages in connection with or arising out of the use of this information.

The information or statements given in these documents regarding the suitability, capacity or performance of the mentioned hardware or software products cannot be considered binding but shall be defined in the agreement made between Teltronic S.A.U. and/or PowerTrunk Inc. and the customer.

Teltronic S.A.U. and/or PowerTrunk Inc. reserves the right to revise these documents and to make changes to their content at any time, without prior notification.

Copyright

No part of the information contained herein and the other referred documents may be copied, distributed or transmitted by any means to any other party without prior written permission of Teltronic S.A.U. and/or PowerTrunk Inc. The distribution of this document may be also covered by NDA (non-disclosure agreement) between Teltronic S.A.U. and/or PowerTrunk Inc. and the receiver.

Please also note that part of these contents even may be covered by patent rights.

This document, the referred documents and the described product are considered protected by copyright according to the applicable laws.

PowerTrunk and the PowerTrunk logo are registered trademarks of Teltronic S.A.U.

Copyright © PowerTrunk Inc. All rights reserved

TABLE OF CONTENTS

1. INTRODUCTION	4
2. UNPACKING AND CHECKING	4
3. PREVIOUS CONSIDERATIONS	4
4. INFORMATION ON SAFETY AND ELECTROMAGNETIC COMPATIBILITY / INFORMATIONS SUR LA SÉCURITÉ ET LA COMPATIBILITÉ ÉLECTROMAGNÉTIQUE	5
4.1 ENGLISH	5
4.1.1 GENERAL CONSIDERATIONS ABOUT SAFETY	5
4.1.2 OPERATION AND EXPOSURE TO RF ENERGY	6
4.1.3 IMPORTANT SAFETY NOTES ABOUT THE ANTENNA	7
4.1.4 ELECTROMAGNETIC COMPATIBILITY REGULATORY INFORMATION (FCC AND ISCED)	8
4.1.5 EMC, SAFETY AND RF EXPOSURE STANDARDS	9
4.2 FRANÇAIS	10
4.2.1 CONSIDÉRATIONS GÉNÉRALES SUR LA SÉCURITÉ	10
4.2.2 FONCTIONNEMENT ET EXPOSITION À L'ÉNERGIE RF	11
4.2.3 NOTES DE SÉCURITÉ SUR L'ANTENNE	12
4.2.4 INFORMATIONS RÉGLEMENTAIRES SUR LA COMPATIBILITÉ ÉLECTROMAGNÉTIQUE (FCC ET ISCED)	13
4.2.5 RÉGLEMENT SUR LA CEM, LA SÉCURITÉ ET L'EXPOSITION AUX RF	14
5. EQUIPMENT DESCRIPTION	15
5.1 FRONT VIEW	15
5.2 REAR VIEW	17
5.3 MODULES	18
5.4 CABLING AND CONNECTORS	21
6. INSTALLATION GUIDE	23
6.1 LOCATION	23
6.2 POWER SUPPLY CONNECTION	23
6.3 ANTENNA CONNECTION	24
6.4 SWITCHING ON THE BSR OR BSR75	24
7. CONFIGURATION	25
8. INCIDENTS	25
8.1 ALARMS	25
8.2 ALARMS WITHOUT STATUS LEDS	28
8.2.1 INTERFERENCE AT BSR.	28

1. INTRODUCTION

The BSR module (Base Station Repeater 40 W) and BSR75 module (Base Station Repeater 75 W) are a modular design, high performance products used as TETRA repeaters.

This manual is common to all the equipment models, including all their options and accessories.

The proper functioning of any electronic device depends on its correct use. It is therefore recommended that the instructions in this manual be followed.

2. UNPACKING AND CHECKING

The BSR or BSR75 module is usually supplied already assembled in the infrastructure cabinet; nevertheless, in special circumstances, it may be individually packaged.

The equipment is supplied with all the modules already assembled in the rack and with RF cables connected. The modules in the basic configuration are: Control (RCPU), Transmitter (RTX or RTX75), power module (RPA or RPA75), Receiver (RRX) and the power supply module (RPS or RPS75).

IMPORTANT: if any of these elements is missing or damaged, contact your dealer and / or installer.

3. PREVIOUS CONSIDERATIONS

This manual contains information on instructions for installation, maintenance and use. Read the following pages before using this equipment.

It is inadvisable to switch on the equipment without having previously connected the antenna or, in specific versions of BSR75, the 50Ω load to the TNC connector. Doing so may seriously damage the equipment and even cause irreparable damage to the transmitter circuits. It is important to use an antenna adjusted to the work frequency.

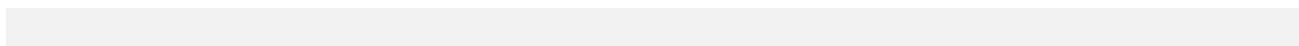

4. INFORMATION ON SAFETY AND ELECTROMAGNETIC COMPATIBILITY / INFORMATIONS SUR LA SÉCURITÉ ET LA COMPATIBILITÉ ÉLECTROMAGNÉTIQUE

4.1 ENGLISH

4.1.1 GENERAL CONSIDERATIONS ABOUT SAFETY

Most electronic equipment is susceptible to electromagnetic interference if it is not duly protected. If the BSR or BSR75 is placed near unprotected electronic devices, they may malfunction.

Only cables that fulfil the characteristics specified in this document must be used. Communication cables must be shielded and earthed at both ends.

Do not attempt to dismantle this product. Servicing and repairs to this product must be performed by trained service technicians at PowerTrunk approved service centres.

PowerTrunk has not approved any changes or modifications to this device by the user. Any changes or modifications could void the user's authority to operate the equipment.

Only fit an approved accessory. If a non-approved accessory is fitted, it may compromise the product safety ratings and may void any product warranty.

Take care when handling the BSR or BSR75. It has sharp edges, which may cut if handled incorrectly.

Maintenance and repair of these repeaters must be carried out by qualified personnel only.

Connect the BSR or BSR75 chassis to earth.

Switch off the BSR or BSR75 before inserting/removing any of its modules

4.1.2 OPERATION AND EXPOSURE TO RF ENERGY

It is the responsibility of the person operating the product to ensure that it is operated safely at all times, and that local laws and regulations governing the usage of Radio Frequency (RF) wireless devices are observed. Obey all signs and instructions relating to the usage to RF wireless devices.

PowerTrunk designs and manufactures products to meet strict guidelines and international standards relating to Radio Frequency (RF) energy and the potential health risks associated with using RF wireless devices. If you have any concerns relating to long term health risks associated with using RF wireless devices, you should obtain advice from your employer.

FCC and ISED radiation exposure statement

This radio is intended for use in occupational/controlled applications where users have been made aware of the potential risks for exposure and can exercise control over their exposure. This product is not authorised for general population, consumer or similar use. This transmitter must not be co-located or operated in conjunction with any other antenna or transmitter.

This equipment complies with FCC and ISED radiation exposure limits set forth for an uncontrolled environment. The antenna should be installed and operated with minimum distance of 5.5 m between the radiator and your body. This transmitter must not be co-located or operating in conjunction with any other antenna or transmitter.

FCC compliance labelling on RF Exposure

The following compliance product labelling can be found in a conspicuous location of the BSR75 for North America market:

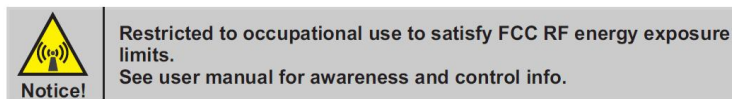

FCC notice on operating the device

The device may contain functions that are not operational in U.S Territories except as noted in the certification filing. Devices may be restricted in frequency by the FCC TCB Grant. Please refer to it for allowed frequency ranges. The TCB Grant may have extended frequencies as noted in the certification filing and Section 2.927(b) may apply to the authorisation. The device complies with 47 CFR Part 90.203 (e), in that the operator cannot directly program the transmit frequencies using the normal accessible external controls. All instructions detailed in this manual must be followed in order to ensure compliance with RF exposure limits.

Failure to observe these restrictions may result in exceeding the FCC RF exposure limits.

ISED Canada information on RF Exposure

The Government of Canada provides further information about RF Exposure by means of official publications that are available on the following website:

<http://www.ic.gc.ca/eic/site/smt-gst.nsf/eng/sf01904.html>

4.1.3 IMPORTANT SAFETY NOTES ABOUT THE ANTENNA

The BSR75 has been approved by FCC and ISED to operate with the antenna types listed below with the maximum permissible gain indicated. Antenna types not included in this list, having a gain greater than the maximum gain indicated for that type, are strictly prohibited for use with this device.

MODEL	CERTIFICATION NUMBER	TYPE OF ANTENNA	MAX.GAIN
BSR75 –7 (409-430 MHz)	FCC ID: WT7PTBSR75410B IC: 8624A-PTBSR75410B	Vertically polarised panel antenna	11.0 dBi
		Cross-polarised panel antenna	15.0 dBi
		Vertically polarised collinear antenna	11.15 dBi

MODEL	CERTIFICATION NUMBER	TYPE OF ANTENNA	MAX.GAIN
BSR75 –8 (450-470 MHz)	FCC ID: WT7PTBSR75450B IC: 8624A-PTBSR75450B	Vertically polarised panel antenna	11.0 dBi
		Cross-polarised panel antenna	15.0 dBi
		Vertically polarised collinear antenna	11.15 dBi

MODEL	CERTIFICATION NUMBER	TYPE OF ANTENNA	MAX.GAIN
BSR75 –K (763-806 MHz)	FCC ID: WT7PTBSR75760B IC: 8624A-PTBSR75760B	Vertically polarised panel antenna	16.5 dBi
		Cross-polarised panel antenna	18.0 dBi
		Vertically polarised collinear antenna	11.15 dBi

MODEL	CERTIFICATION NUMBER	TYPE OF ANTENNA	MAX.GAIN
BSR75 –N (806-870 MHz)	FCC ID: WT7PTBSR75800B IC: 8624A-PTBSR75800B	Vertically polarised panel antenna	16.5 dBi
		Cross-polarised panel antenna	18.0 dBi
		Vertically polarised collinear antenna	11.15 dBi

Only use PowerTrunk approved antennas with this product. The use of non-approved antennas may damage the product, will result in the non-compliance with regulatory requirements, will compromise the product safety ratings, will reduce the length of operating time and will invalidate the product warranty.

When installing the antenna, follow the guidelines for exposure of the human body to high and low frequency electromagnetic fields. Follow the supplier's / manufacturer's instructions.

The BSR must not transmit without its antenna connected or, in specific versions of BSR75, without the 50Ω load in the TNC connector.

Burns may be suffered if the antenna connector output of the power module (RPA or RPA75) is touched by bare skin when the BSR or BSR75 are transmitting with the antenna disconnected.

NEVER use your device if the antenna shows signs of damage.

4.1.4 **ELECTROMAGNETIC COMPATIBILITY REGULATORY INFORMATION (FCC AND ISED)**

These devices generate, use and radiate RF energy and, if not installed and used in accordance with the instruction manual, may cause harmful interference to radio communications.

FCC interference statement and compliance labelling

This device complies with Part 15 of the FCC Rules and Industry Canada's licence-exempt RSS standards. Operation is subject to the following two conditions: (1) this device may not cause interference, and (2) this device must accept any interference, including interference that may cause undesired operation of the device.

A label with the text above can be found in a conspicuous location of the BSR75 for North America market.

FCC Class B digital device notice

This equipment has been tested and found to comply with the limits for a Class B digital device, pursuant to part 15 of the FCC Rules. These limits are designed to provide reasonable protection against harmful interference in a residential installation. This equipment generates, uses and can radiate radio frequency energy and, if not installed and used in accordance with the instructions, may cause harmful interference to radio communications. However, there is no guarantee that interference will not occur in a particular installation. If this equipment does cause harmful interference to radio or television reception, which can be determined by turning the equipment off and on, the user is encouraged to try to correct the interference by one or more of the following measures:

- Reorient or relocate the receiving antenna.
- Increase the separation between the equipment and receiver.
- Connect the equipment into an outlet on a circuit different from that to which the receiver is connected.
- Consult the dealer or an experienced radio/TV technician for help.

ISED Canada ICES-003 compliance labelling

This Class B digital apparatus has been fully tested and found to comply with the Canadian ISED (Innovation, Science and Economic Development) standard ICES-003. A label with the text below can be found in a prominent location of the radio for North America market:

CAN ICES-3 (B) / NMB-3 (B)

4.1.5 EMC, SAFETY AND RF EXPOSURE STANDARDS

BSR and BSR75 are in conformity with the applicable requirements of the following standards and normative documents, in full accordance with the aforesaid directive:

ETSI EN 300 394-1	Terrestrial Trunked Radio (TETRA); Conformance testing specification; Part 1: Radio
ETSI EN 301 489-1	Electromagnetic Compatibility and Radio spectrum Matters (ERM); ElectroMagnetic Compatibility (EMC) standard for radio equipment and services; Part 1: Common technical requirements
ETSI EN 301 489-5	ElectroMagnetic Compatibility (EMC) standard for radio equipment and services; Part 5: Specific conditions for Private land Mobile Radio (PMR) and ancillary equipment (speech and non-speech) and Terrestrial Trunked Radio (TETRA) Harmonised Standard covering the essential requirements of article 3.1(b) of the Directive 2014/53/EU
EN 60950-1 / IEC 60950-1 / UL 60950-1	Information technology equipment - Safety -- Part 1: General requirements
EN 50385	Product standard to demonstrate the compliance of radio base stations and fixed terminal stations for wireless telecommunication systems with the basic restrictions or the reference levels related to human exposure to radio frequency electromagnetic fields (110 MHz - 40 GHz) - General public

BSR and BSR75 have been designed according to the Radio Equipment Directive 2014/53/EU (RED).

Note: The exact editions can be found in the declaration of conformity.

4.2 FRANÇAIS

4.2.1 CONSIDÉRATIONS GÉNÉRALES SUR LA SÉCURITÉ

La plupart des équipements électroniques sont susceptibles d'être soumis à des interférences électromagnétiques s'ils ne sont pas correctement protégés. Le montage de le BSR ou le BSR75 est placé à proximité d'équipements électroniques non protégés peut provoquer un dysfonctionnement de ces derniers.

Seuls les câbles répondant aux caractéristiques indiquées dans ce document doivent être utilisés. Les câbles de communication doivent être blindés et ils doivent être mis à la terre aux deux extrémités.

N'essayez pas de démonter ce produit. L'entretien et les réparations de ce produit doivent être effectués par des techniciens de maintenance qualifiés dans les centres de service agréés par PowerTrunk.

PowerTrunk n'approuve aucune modification apportée à l'appareil par l'utilisateur, quelle qu'en soit la nature. Tout changement ou modification peuvent annuler le droit d'utilisation de l'appareil par l'utilisateur.

N'installez qu'un accessoire approuvé. Si un accessoire non approuvé est installé, cela pourrait compromettre les cotes de sécurité du produit et annuler la garantie du produit.

Manipuler le BST/BSR75 avec soin. Cet équipement est pourvu d'arêtes qui peuvent être à l'origine de coupures en cas de mauvaise manipulation.

La maintenance et la réparation de cet équipement doivent être prises en charge par du personnel qualifié.

Connectez le châssis BSR ou BSR75 à la terre.

Eteindre le BSR ou le BSR75 avant d'insérer / retirer l'un de ses modules.

4.2.2 FONCTIONNEMENT ET EXPOSITION À L'ÉNERGIE RF

Il est de la responsabilité de la personne qui exploite le produit de s'assurer qu'il est exploité en toute sécurité en tout temps et que les lois et règlements régissant l'utilisation des appareils sans fil à radiofréquence (RF) sont respectés. Respectez tous les signes et instructions relatifs à l'utilisation des appareils RF sans fil

Powertrunk conçoit et fabrique des produits répondant aux normes et directives internationales strictes relatives à l'énergie des radiofréquences (RF) et aux risques potentiels pour la santé associés à l'utilisation de dispositifs RF sans fil. Si vous avez des préoccupations concernant les risques à long terme pour la santé associés à l'utilisation de dispositifs RF sans fil, vous devriez obtenir des conseils de votre employeur

Déclaration de l'exposition aux radiations FCC et ISED

Cette radio est conçue pour être utilisée dans des applications professionnelles / contrôlées où les utilisateurs ont été informés des risques potentiels d'une exposition et peuvent exercer un contrôle sur leur exposition. Ce produit n'est pas autorisé pour l'usage de la population générale, consommateur ou similaire. Cet émetteur ne doit pas être localisé ou utilisé avec d'autres antennes ou émetteurs.

Cet équipement est conforme aux limites d'exposition aux radiations FCC et ISED définies pour un environnement non contrôlé. L'antenne doit être installée de façon à garder une distance minimale de 5.5 m entre la source de rayonnements et votre corps. L'émetteur ne doit pas être colocalisé ni fonctionner conjointement avec à autre antenne ou autre émetteur.

Étiquetage de conformité FCC RF

L'étiquette de conformité de produit suivante peut être trouvée dans un emplacement visible sur l'unité BSR75 pour le marché nord-américain:

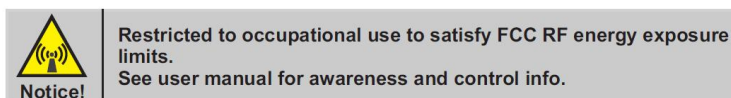

Avis sur le fonctionnement du dispositif FCC

L'appareil peut contenir des fonctions qui ne sont pas opérationnelles dans les territoires des États-Unis. UU sauf tel qu'indiqué dans la demande de certification. La subvention FCC TCB peut limiter la fréquence des appareils. Voir les plages de fréquences autorisées. La subvention de TCB peut avoir des fréquences étendues comme indiqué dans la soumission de certification et la section 2.927 (b) peut s'appliquer à l'autorisation. L'appareil est conforme à la norme 47 CFR Part 90.203 (e), car l'opérateur ne peut pas programmer directement les fréquences de transmission à l'aide des commandes externes normalement accessibles. Toutes les instructions détaillées dans ce manuel doivent être suivies pour assurer la conformité aux limites d'exposition RF.

Information d'ISED Canada sur l'exposition aux RF

Le gouvernement du Canada fournit plus de renseignements sur l'exposition aux radiofréquences au moyen de publications officielles disponibles sur le site Web suivant:

<http://www.ic.gc.ca/eic/site/smt-gst.nsf/eng/sf01904.html>

4.2.3 NOTES DE SÉCURITÉ SUR L'ANTENNE

BSR75 a été approuvée par FCC et ISED pour fonctionner avec les types d'antennes énumérés ci-dessous avec le gain maximum admissible indiqué. Les types d'antennes non inclus dans cette liste, qui ont un gain supérieur au gain maximal indiqué pour ce type, sont strictement interdits pour une utilisation avec cet appareil

MODÈLE	NUMÉRO DE CERTIFICATION	TYPE D'ANTENNE	MAX.GAIN
BSR75 –7 (409-430 MHz)	FCC ID: WT7PTBSR75410B IC: 8624A-PTBSR75410B	Antenne de panneau polarisée verticalement	11.0 dBi
		Cross-polarised panel antenna	15.0 dBi
		Antenne de panneau polarisée verticalement	11.15 dBi

MODÈLE	NUMÉRO DE CERTIFICATION	TYPE D'ANTENNE	MAX.GAIN
BSR75 –8 (450-470 MHz)	FCC ID: WT7PTBSR75450B IC: 8624A-PTBSR75450B	Antenne de panneau polarisée verticalement	11.0 dBi
		Antenne de panneau à polarisation croisée	15.0 dBi
		Antenne de panneau polarisée verticalement	11.15 dBi

MODÈLE	NUMÉRO DE CERTIFICATION	TYPE D'ANTENNE	MAX.GAIN
BSR75 –K (763-806 MHz)	FCC ID: WT7PTBSR75760B IC: 8624A-PTBSR75760B	Antenne de panneau polarisée verticalement	16.5 dBi
		Antenne de panneau à polarisation croisée	18.0 dBi
		Antenne de panneau polarisée verticalement	11.15 dBi

MODÈLE	NUMÉRO DE CERTIFICATION	TYPE D'ANTENNE	MAX.GAIN
BSR75 –N (806-870 MHz)	FCC ID: WT7PTBSR75800B IC: 8624A-PTBSR75800B	Antenne de panneau polarisée verticalement	16.5 dBi
		Antenne de panneau à polarisation croisée	18.0 dBi
		Antenne de panneau polarisée verticalement	11.15 dBi

Utilisez uniquement des antennes approuvées par Powertrunk avec ce produit. L'utilisation d'antennes non approuvées peut endommager le produit, entraîner le non-respect des exigences réglementaires, compromettre les cotes de sécurité du produit, réduire le temps de fonctionnement et invalider la garantie du produit.

Une fois l'antenne installée, suivez les directives pour exposer le corps humain aux champs électromagnétiques de haute et basse fréquence. Suivez les instructions du fournisseur / fabricant.

N'utilisez JAMAIS votre appareil sans antenne connectée ou, dans des versions spécifiques de BSR75, sans la charge de 50Ω dans le connecteur TNC.

Des brûlures peuvent être subies si la sortie du connecteur d'antenne du module d'alimentation (RPA ou RPA75) est touchée par la peau nue lorsque le BSR ou le BSR75 émet avec l'antenne déconnectée.

N'utilisez JAMAIS votre appareil si l'antenne présente des signes de dommages

4.2.4 INFORMATIONS RÉGLEMENTAIRES SUR LA COMPATIBILITÉ ÉLECTROMAGNÉTIQUE (FCC ET ISED)

Ces appareils génèrent, utilisent et rayonnent de l'énergie RF et, s'ils ne sont pas installés et utilisés conformément au manuel d'instructions, peuvent causer des interférences nuisibles aux communications radio.

Déclaration d'interférence et étiquetage de conformité FCC

Cet appareil est conforme à la partie 15 des règlements de la FCC et aux règles RSS exemptées de la licence d'Industrie Canada. Le fonctionnement est soumis aux deux conditions suivantes: (1) cet appareil ne doit pas causer d'interférences, et (2) cet appareil doit accepter toute interférence, y compris les interférences pouvant provoquer un fonctionnement indésirable de l'appareil.

Une étiquette avec le texte ci-dessus peut être trouvée dans un endroit visible de le BSR75 pour le marché nord-américain.

Avis sur les appareils numériques de classe B de la FCC

Cet équipement a été testé et répond aux limites d'un appareil numérique de classe B, conformément à la partie 15 des règles de la FCC. Ces limites sont conçues pour fournir une protection raisonnable contre les interférences nuisibles dans une installation résidentielle. Cet équipement génère, utilise et peut émettre de l'énergie radiofréquence et, s'il n'est pas installé et utilisé conformément aux instructions, peut causer des interférences nuisibles aux communications radio. Cependant, il n'y a aucune garantie que des interférences ne se produiront pas dans une installation particulière. Si cet équipement cause des interférences nuisibles à la réception radio ou télévision, ce qui peut être déterminé en éteignant et en rallumant l'équipement, l'utilisateur est encouragé à essayer de corriger l'interférence par une ou plusieurs des mesures suivantes:

- Réorienter ou déplacer l'antenne de réception.
- Augmentez la distance entre l'équipement et le récepteur.
- Connectez l'équipement à une prise d'un circuit différent de celui auquel le récepteur est connecté.
- Consulter le revendeur ou un technicien radio / TV expérimenté pour obtenir de l'aide.

Étiquetage de conformité ISED Canada ICES-003

Cet appareil numérique de classe B a été entièrement testé et est conforme à la norme canadienne ISED (Innovation, Sciences et Développement Économique) ICES-003. Une étiquette avec le texte suivant peut être trouvée dans un endroit visible sur la radio pour le marché nord-américain:

CAN ICES-3 (B) / NMB-3 (B)

4.2.5 RÉGLEMENT SUR LA CEM, LA SÉCURITÉ ET L'EXPOSITION AUX RF

L'équipement a été conçu conformément aux réglementations suivantes:

ETSI EN 300 394-1	Réseaux radioélectriques à ressources partagées (TETRA); spécification du test de conformité ; Partie 1: Radio
ETSI EN 301 489-1	Compatibilité électromagnétique et spectre radioélectrique (ERM); norme de compatibilité électromagnétique (CEM) pour l'équipement et les services radio ; Partie 1: Conditions requises techniques courantes
ETSI EN 301 489-5	Compatibilité électromagnétique (EMC) pour les équipements et services radio; Part. 5: Conditions spécifiques pour la norme harmonisée de radio mobile terrestre privée (PMR) et de matériel auxiliaire (parole et non-parole) et radio terrestre à ressources partagées (TETRA) couvrant les exigences essentielles de l'article 3.1 (b) de la directive 2014/53 / UE
EN 60950-1 / IEC 60950-1 / UL 60950-1	Équipement de technologie d'informations - Sécurité -- Partie 1: Exigences générales
EN 50385	Norme produit pour la démonstration de la conformité des stations de base radio et des stations terminales fixes pour les radio télécommunications, aux restrictions de base et aux niveaux de référence relatifs à l'exposition de l'homme aux champs électromagnétiques (110 MHz - 40 GHz) - Application au public en général

BSR et BSR75 ont été conçus conformément à la directive sur les équipements radio 2014/53 / UE (RED).

Note: Les éditions exactes peuvent être trouvées dans la déclaration de conformité.

5. EQUIPMENT DESCRIPTION

5.1 FRONT VIEW

◆ BSR

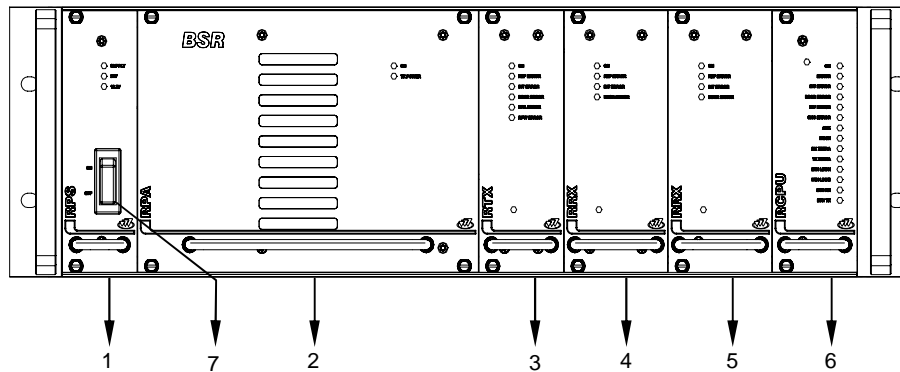

- 1.- RPS (Repeater Power Supply)
- 2.- RPA (Repeater Power Amplifier)
- 3.- RTX (Repeater Transmitter)
- 4.- RRX (Repeater Receiver)
- 5.- Option RRX2/BSYNC (Repeater Receiver 2 / BSR Synchronism)
- 6.- RCP (Repeater Control Processing Unit)
- 7.- Switch ON/OFF

◆ **BSR75**

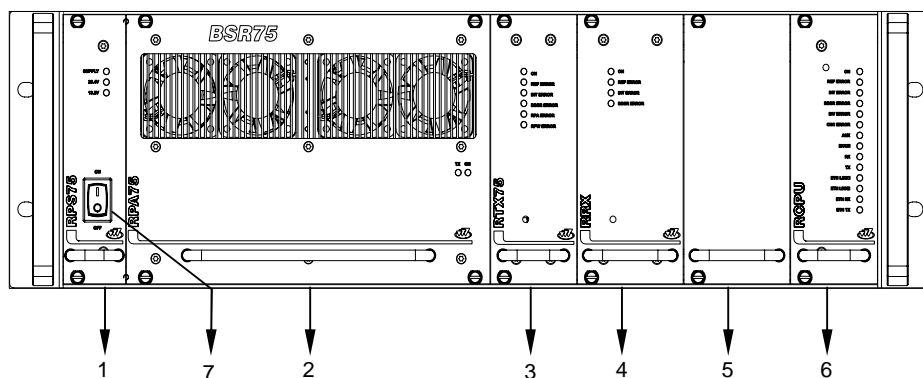

- 1.- RPS75 (Repeater Power Supply 75 W)
- 2.- RPA75 (Repeater Power Amplifier 75 W)
- 3.- RTX75 (Repeater Transmitter 75 W)
- 4.- RRX (Repeater Receiver)
- 5.- Option RRX2/BSYNC (Repeater Receiver 2 / BSR Synchronism)
- 6.- RCP (Repeater Control Processing Unit)
- 7.- Switch ON/OFF

5.2 REAR VIEW

◆ **BSR**

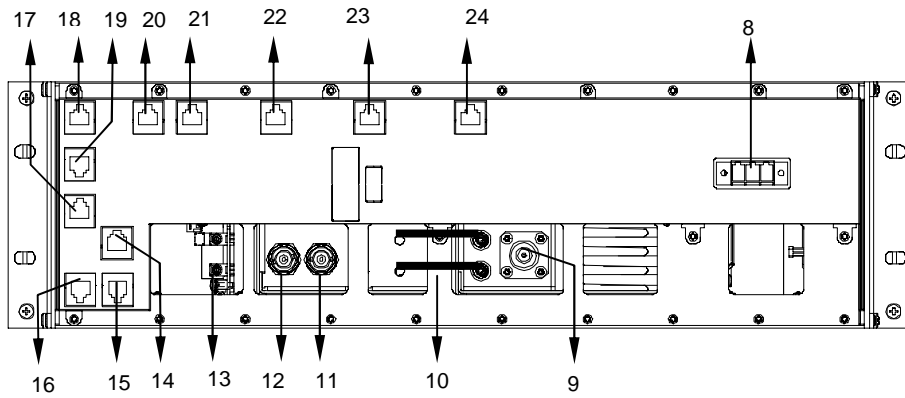

◆ **BSR75**

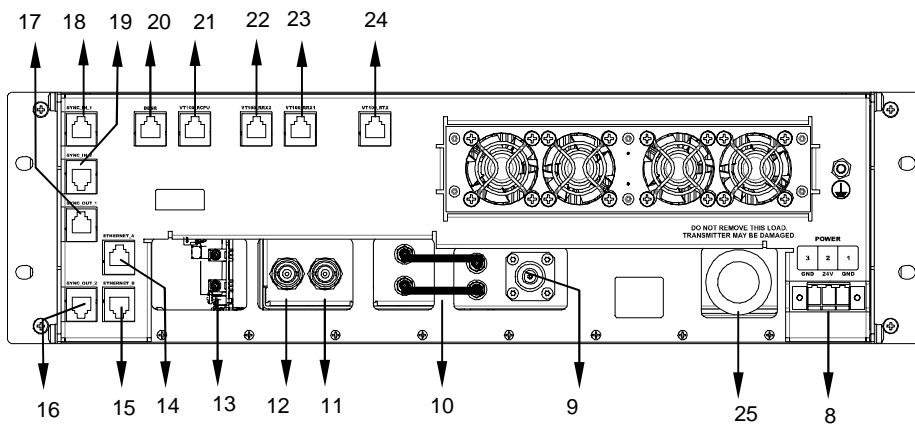

5.3 MODULES

1.- RPS or RPS75 (REPEATER POWER SUPPLY)

LEDs to indicate module status.

LED	TYPE	NORMAL STATUS	FUNCIÓN
SUPPLY	Green	On	There are 27.4 V at the RPS or RPS75 input
24 V or 26.4 V	Green	On	There are 27.4 V at the RPS or RPS75 output
13.2 V	Green	On	There are 13.2 V at the RPS or RPS 75 output

Power on switch (Ref. 7): ON/OFF switch to connect to and disconnect from the BSR or BSR75.

2.- RPA or RPA75 (REPEATER POWER AMPLIFIER)

LEDs to indicate module status:

LED	TYPE	NORMAL STATUS	FUNCIÓN
ON	Green	On	Power supply correct
TX POWER	Green	On	Module transmitting

3.- RTX or RTX75 (REPEATER TRANSMITTER)

LEDs to indicate module status:

LED	TYPE	NORMAL STATUS	FUNCIÓN
ON	Green	On	Power supply correct
REF. ERROR	Red	Off	Failure in the 10 MHz reference
INT. ERROR	Red	Off	Internal failure
BBSR ERROR	Red	Off	Communication failure with RCPU module
RPA ERROR	Red	Off	RPA or RPA75 failure
RPW ERROR	Red	Off	Reflected power failure

4.- RRX (REPEATER RECEIVER)

LEDs to indicate module status:

LED	TYPE	NORMAL STATUS	FUNCIÓN
ON	Green	On	Power supply correct
REF. ERROR	Red	Off	Failure in the 10 MHz reference
INT. ERROR	Red	Off	Internal failure
BBSR ERROR	Red	Off	Communication failure with the RCPU module

5.- SLOT OPTION: RRX2 / BSYNC (REPEATER RECEIVER 2/ BSR SYNCHRONISM)

LEDs to indicate the status of option RRX2:

LED	TYPE	NORMAL STATUS	FUNCIÓN
ON	Green	On	Power supply correct
REF. ERROR	Red	Off	Failure in the 10 MHz reference
INT. ERROR	Red	Off	Internal failure
BBSR ERROR	Red	Off	Communication failure with RCPU module

LEDs to indicate the status of option BSYNC:

LED	TYPE	NORMAL STATUS	FUNCIÓN
ON	Green	On	Power supply correct
REF. ERROR	Red	Off	Failure in the 10 MHz reference
WARM UP	Red	Off	Oscillator in warming up phase
TIME GPS	Green	Flashing	There is NMEA signal from GPS
PPS GPS	Green	Flashing	There is PPS signal from GPS
TIME LOCAL	Green	Flashing	There is NMEA local signal (without GPS)
PPS LOCAL	Green	Flashing	There is PPS local signal (without GPS)

NOTE: this slot is not used in the BSR basic configuration.

6.- RCPU (REPEATER CONTROL)

LEDs to indicate the module status:

LED	TYPE	NORMAL STATUS	FUNCIÓN
ON	Green	On	Power supply correct
REF. ERROR	Red	Off	Failure in the 10 MHz reference
INT. ERROR	Red	Off	Internal failure
BBSR ERROR	Red	Off	BSR bus failure
DIV ERROR	Red	Off	Diversity failure
CNC ERROR	Red	Off	Communication failure with the CNC
AUX	Green	Off	Not used
MCCH	Green	Off / On	Main carrier indicator
RX	Green	Flickering	TETRA information received
TX	Green	On	TETRA information transmission
ETH LINK1	Yellow	On	Link between the local network switch and the RCPU module in Ethernet port 1
ETH LINK2	Yellow	Off	Link between the local network switch and the RCPU module in Ethernet port 1
ETH RX	Green	Flashing	Reception of an Ethernet packet
ETH TX	Green	Flashing	Transmission of an Ethernet packet

5.4 CABLING AND CONNECTORS

◆ BSR

- 8.- Power supply connector.
- 9.- Transmitter antenna connector.
- 10.- SMB RF cables.
- 11.- Reception antenna connector (receiver chain 1).
- 12.- Reception antenna connector (receiver chain 2).
- 13.- Reception antenna connectors for the RRX2 option / antenna connectors for the GPS, depending on the inserted module.
- 14.- Ethernet_A connector.
- 15.- Ethernet_B connector.
- 16.- SYNC_OUT_2 connector.
- 17.- SYNC_OUT_1 connector.
- 18.- SYNC_IN_1 connector.
- 19.- SYNC_IN_2 connector.
- 20.- Maintenance connector for BSR Bus.
- 21.- VT100 Connector for RCPU module maintenance.
- 22.- VT100 Connector for RRX2 module maintenance.
- 23.- VT100 Connector for RRX1 module maintenance.
- 24.- VT100 Connector for RTX module maintenance.

◆ **BSR75**

- 8.- Power supply connector.
- 9.- Transmission power antenna connector.
- 10.- SMB RF cables.
- 11.- Reception antenna connector (receiver chain 1).
- 12.- Reception antenna connector (receiver chain 2).
- 13.- Reception antenna connectors for the RRX2 option / antenna connectors for the GPS, depending on the inserted module.
- 14.- Ethernet_A connector.
- 15.- Ethernet_B connector.
- 16.- SYNC_OUT_2 connector.
- 17.- SYNC_OUT_1 connector.
- 18.- SYNC_IN_1 connector.
- 19.- SYNC_IN_2 connector.
- 20.- Maintenance connector for BSR bus.
- 21.- Connector VT100 for RCPU module maintenance.
- 22.- Connector VT100 for RRX2 module maintenance.
- 23.- Connector VT100 for RRX1 module maintenance.
- 24.- Connector VT100 for RTX75 module maintenance.
- 25.- TNC connector for 50Ω load (only in specific BSR75 hardware versions).

6. INSTALLATION GUIDE

The following recommendations must be followed closely before starting up the BSR module or the BSR75 module.

6.1 LOCATION

The BSR and BSR75 have been designed in the standard format of 19" / 3 units high, and so they must be installed in cabinets with this format.

The BSR or BSR75 site must be permanent, well-ventilated and without vibrations.

6.2 POWER SUPPLY CONNECTION

DC power supply: check that the power supply source and/or the battery to be used meet the voltage and current requirements necessary to supply the equipment:

Nominal voltage: 27.4 VDC (range: from 21.6 to 28 VDC)

Minimum source current: 10 A (BSR) or 20 A (BSR75)

- ❑ If lead batteries are used, they are to be placed as far from the BSR or BSR75 as possible to prevent corrosion in the repeater due to battery vapours. They should be situated in a well-ventilated place.
- ❑ Use the power supply connector provided (D013000) to connect the BSR or BSR75 to the power supply source. Use cable with a minimum section of 3.5 mm² (or AWG-12). Ensure that the connection is made with the correct polarity.
- ❑ Ensure that the earth connection is made. Make this connection with a cable of maximum diameter and minimum length.

NEVER use a gas or electricity conduit as an earth.

6.3 ANTENNA CONNECTION

- ❑ Choose the most adaptable antenna for the installation. The antenna must have an impedance of 50 ohms to the equipment transmission frequency. Install the antenna in accordance with the manufacturer's instructions.
- ❑ Use cable coaxial, avoiding as much as possible large cable lengths. Cable impedance is 50 ohms.
- ❑ Measure the ROE of the installation. Never accept a ROE greater than 2.
- ❑ If a duplexer module or a band pass filter is required, adjust them to the work frequency before starting up.

6.4 SWITCHING ON THE BSR OR BSR75

- ❑ Check the connections between the modules.
- ❑ Check that the power supply source is connected correctly.
- ❑ Check that the RF SMB cables are connected correctly (see Rear View diagram Ref. 10).
- ❑ Check the connections of the antennas in the RPA or RPA75 and RRX modules.
- ❑ Only in case of the BSR75 check the 50Ω load is connected to the rear TNC connector in the RPA75.
- ❑ Check that the Ethernet connections to the CNC/Gateway are in accordance with the configuration.
- ❑ Check that the RPS or RPS75 module LED SUPPLY is on.
- ❑ Activate the power on switch on the RPS module or RPS75 module.
- ❑ Check that the 24V LED and the 13.2 V LED on the RPS module or the 26.4 V LED and 13.2 V LED on the RPS75 module are on and check that the LEDS ON are switched on for the other modules.
- ❑ Wait for the BSR or BSR75 to start up.
- ❑ Check that the mobile equipment is registered in the BSR or BSR75.

Note: see section 5 for more information on references for the different modules and LEDs.

7. CONFIGURATION

A BSR (BSR or BSR75) is configured via a NMS (Network Management System). To configure the BSR or BSR75, consult NMS User manual.

8. INCIDENTS



The repeater must be repaired by authorized technical personnel only. If a BSR failure occurs, the entire BSR must be replaced. If transmitter module is damaged and there is not an entire BSR available to replace, set RTX and RPA modules previously calibrated jointly.

If an error or alarm occurs in the BSR or BSR75, this is indicated in the corresponding LED for each one of the modules. The following list shows the possible failures and their solutions.

8.1 ALARMS

	<i>Led indication</i>	<i>Status</i>	<i>Failure / Solution</i>
RPS / RPS75	SUPPLY	OFF	Power supply failure. Check that the source and the power supply cable are correctly connected. Check the internal fuse of the RPS. Contact Technical Services if unsolved.
	24V or 26.4 V	OFF	Power supply failure. Contact Technical services.
	13.2 V	OFF	Power supply failure. Contact Technical services.

RPA / RPA75	ON	OFF	Power supply failure. Contact Technical Services.
	TX POWER	OFF	No power transmission in the antenna. Wait for BSR or BSR75 to be started up by the CNC. Check other LED indications. Contact Technical Services if unsolved.

RTX / RTX75	ON	OFF	Internal power supply failure. Contact Technical services.
	REF. ERROR	ON	Failure in the 10 MHz reference. Contact Technical services.
	INT. ERROR	ON	Internal failure. Contact Technical services.
	BBSR ERROR	ON	Communication failure with the RCPU module. Check that all the modules are correctly installed. Contact Technical services if still unsolved.
	RPA ERROR	ON	Failure in the RPA or RPA75 modules. Check that the RF SMB cables (Ref. 10) are correctly connected. Contact Technical services if still unsolved.
	RPW ERROR	ON	Reflected power alarm. Check that the antenna is correctly installed. Contact Technical services.

RRX	ON	OFF	Internal power supply failure. Contact Technical services.
	REF. ERROR	ON	Failure in the 10 MHz reference. Contact Technical services.
	INT. ERROR	ON	Internal failure. Contact Technical services.
	BBSR ERROR	ON	Communication failure with the RCPU module. Check that all the modules are correctly installed. Contact Technical Services if still unsolved.

BSYNC	ON	OFF	Internal power supply failure. Contact Technical services.
	REF. ERROR	OFF	Failure in the 10 MHz reference. Contact Technical services.
	TIME GPS	OFF	If GPS is activated, there is failure in the data frame. Contact Technical Services.
	PPS GPS	OFF	If GPS is activated, there is failure in the PPS signal of the GPS: - Check that the starting up period has been exceeded (about 10 minutes after switching on) - Check the GPS antenna connection. - Check the correct positioning of the GPS antenna, in accordance with the manufacturer's instructions. Contact Technical Services if still unsolved.
	TIME LOCAL	OFF	If GPS is not activated, there is failure in the local reference data frame. Contact Technical Services.
	PPS LOCAL	OFF	If GPS is not activated, there is failure in the local PPS signal. Contact Technical Services.

RCPU	ON	OFF	Internal power supply failure. Contact Technical Services.
	REF ERROR	ON	Failure in the 10 MHz reference. Check that the BSYNC module is installed or that the SYNC IN cable is correctly connected. Contact Technical services if still unsolved.
	INT ERROR	ON	Internal failure. Contact Technical Services.
	BBSR ERROR	ON	Communication failure by the BSR bus. Check that all the modules are correctly installed. Contact Technical services if still unsolved.
	DIV ERROR	ON	Error in diversity: occurs when the difference in received power between received paths exceeds a level (20 dBs by default) for a consecutive number of receptions. These receptions on the received paths which do not have sufficient power are not counted. This alarm does not disappear until there are no receptions with the sufficient power, and until the difference of received power between received paths does not exceed the level previously mentioned. Check diversity configuration in the CNC. Check that the reception antennas are correctly installed. Contact Technical services if still unsolved.
	CNC ERROR	ON	Communication failure with the CNC. Check the Ethernet connections. Check that the CNC is working correctly. Contact Technical Services if still unsolved.
	RX	Continuous ON	Interference detection. Check the installation. Check that the work frequencies are correct.
	ETH LINK1	OFF	Failure in Ethernet link 1. Check Ethernet connection 1 and the Switch A.
	ETH LINK2	OFF	Failure in Ethernet link 2. Check Ethernet connection 2 and the Switch B.
	ETH RX	OFF	Packets are not received by Ethernet. Check the Ethernet connections.
	ETH TX	OFF	Packets are not sent by Ethernet. Check the Ethernet connections.

8.2 ALARMS WITHOUT STATUS LEDS

8.2.1 INTERFERENCE AT BSR.

This alarm is monitored in the management and configuration module NMS. See the infrastructure Event List in the NMS Client Help contents.

Interference in the BSR or BSR75 is activated when there are a large number of consecutive reception faults in the BSR or BSR75. A reception fault is considered when a level higher than the threshold for reception of the carrier, but is not recognized as valid TETRA signal. Depending on the signal level, interference is considered low or high. So, if the level of signal is above the threshold for reception and below the threshold set to high interference and is not recognized as valid sign, it will be a low interference alarm. If the signal level is above the threshold set to high interference and is not recognized as a valid signal, the low level alarm would disappear (if it happened) and high interference would produce.

These alarms are turned off when the interference source disappears or with any right TETRA reception for low interference case, and with more than one consecutive right reception for high-level interference.