

FCC Radio Test Report

FCC ID: WSGSK-BTH-015A

This report concerns (check one) : Original Grant Class II Change

Issued Date : Sep. 30, 2008
Project No. : 0808C114
Equipment : Bluetooth Headset
Model Name : SK-BTH-015A; SK-BTH-015B; SK-BTH-015C;
SK-BTH-028; SK-BTH-038; SK-BTH-018;
SK-BTH-058; SK-BTH-066
Applicant : SKY WING COMMUNICATION ELECTRONICS
CO.,LTD
Address : No.10 Road 63#,Long yan,Humen Town,
Dongguan City,Guangdong,China

Tested by:

Neutron Engineering Inc. EMC Laboratory

Date of Test:

Aug. 22, 2008 ~ Sep. 30, 2008

Testing Engineer :

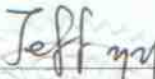
(Jeff Yang)

Technical Manager :

(Vic Chiu)

Authorized Signatory :

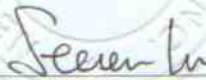
(Steven Lu)

NEUTRON ENGINEERING INC.

No. 132-1, Lane 329, Sec. 2, Palain Rd.,
Shijr City, Taipei, Taiwan
TEL : (02) 2646-5426 FAX : (02) 2646-6815



Declaration

Neutron represents to the client that testing is done in accordance with standard procedures as applicable and that test instruments used has been calibrated with the standards traceable to National Measurement Laboratory (**NML**) of **R.O.C.**, or National Institute of Standards and Technology (**NIST**) of **U.S.A.**

Neutron's reports apply only to the specific samples tested under conditions. It is manufacture's responsibility to ensure that additional production units of this model are manufactured with the identical electrical and mechanical components. **Neutron** shall have no liability for any declarations, inferences or generalizations drawn by the client or others from **Neutron** issued reports.

Neutron's reports must not be used by the client to claim product endorsement by the authorities or any agency of the Government.

This report is the confidential property of the client. As a mutual protection to the clients, the public and **Neutron-self**, extracts from the test report shall not be reproduced except in full with **Neutron's** authorized written approval.

Neutron's laboratory quality assurance procedures are in compliance with the **ISO Guide 17025** requirements, and accredited by the conformity assessment authorities listed in this test report.

Limitation

For the use of the authority's logo is limited unless the Test Standard(s)/Scope(s)/Item(s) mentioned in this test report is (are) included in the conformity assessment authorities acceptance respective.

Table of Contents	Page
1 . CERTIFICATION	6
2 . SUMMARY OF TEST RESULTS	7
2.1 TEST FACILITY	8
2.2 MEASUREMENT UNCERTAINTY	8
3 . GENERAL INFORMATION	9
3.1 GENERAL DESCRIPTION OF EUT	9
3.2 DESCRIPTION OF TEST MODES	11
3.3 TABLE OF PARAMETERS OF TEXT SOFTWARE SETTING	11
3.4 BLOCK DIGRAM SHOWING THE CONFIGURATION OF SYSTEM TESTED	12
3.5 DESCRIPTION OF SUPPORT UNITS (RADIATED MODE)	13
3.6 DESCRIPTION OF SUPPORT UNITS(CONDUCTED MODE)	14
4 . EMC EMISSION TEST	15
4.1 CONDUCTED EMISSION MEASUREMENT	15
4.1.1 POWER LINE CONDUCTED EMISSION LIMITS	15
4.1.2 MEASUREMENT INSTRUMENTS LIST AND SETTING	15
4.1.3 TEST PROCEDURE	16
4.1.4 DEVIATION FROM TEST STANDARD	16
4.1.5 TEST SETUP	16
4.1.6 EUT OPERATING CONDITIONS	17
4.1.7 TEST RESULTS	18
4.2 RADIATED EMISSION MEASUREMENT	20
4.2.1 RADIATED EMISSION LIMITS	20
4.2.2 MEASUREMENT INSTRUMENTS LIST ANS SETTING	21
4.2.3 TEST PROCEDURE	22
4.2.4 DEVIATION FROM TEST STANDARD	22
4.2.5 TEST SETUP	23
4.2.6 EUT OPERATING CONDITIONS	23
4.2.7 TEST RESULTS (BETWEEN30 – 1000 MHZ)	24
4.2.8 TEST RESULTS (ABOVE 1000 MHZ)	26
4.2.9 TEST RESULTS (RESTRICTED BANDS REQUIREMENTS)	50
5 . NUMBER OF HOPPING CHANNEL	58
5.1 APPLIED PROCEDURES / LIMIT	58
5.1.1 MEASUREMENT INSTRUMENTS LIST AND SETTING	58
5.1.2 TEST PROCEDURE	58
5.1.3 DEVIATION FROM STANDARD	58

Table of Contents	Page
5.1.4 TEST SETUP	58
5.1.5 EUT OPERATION CONDITIONS	58
5.1.6 TEST RESULTS	59
6 . AVERAGE TIME OF OCCUPANCY	61
6.1 APPLIED PROCEDURES / LIMIT	61
6.1.1 MEASUREMENT INSTRUMENTS LIST	61
6.1.2 TEST PROCEDURE	61
6.1.3 DEVIATION FROM STANDARD	61
6.1.4 TEST SETUP	62
6.1.5 EUT OPERATION CONDITIONS	62
6.1.6 TEST RESULTS	63
7 . HOPPING CHANNEL SEPARATION MEASUREMENT	75
7.1 APPLIED PROCEDURES / LIMIT	75
7.1.1 MEASUREMENT INSTRUMENTS LIST AND SETTING	75
7.1.2 TEST PROCEDURE	75
7.1.3 DEVIATION FROM STANDARD	75
7.1.4 TEST SETUP	75
7.1.5 EUT OPERATION CONDITIONS	75
7.1.6 TEST RESULTS	76
8 . BANDWIDTH TEST	80
8.1 APPLIED PROCEDURES / LIMIT	80
8.1.1 MEASUREMENT INSTRUMENTS LIST AND SETTING	80
8.1.2 TEST PROCEDURE	80
8.1.3 DEVIATION FROM STANDARD	80
8.1.4 TEST SETUP	80
8.1.5 EUT OPERATION CONDITIONS	80
8.1.6 TEST RESULTS	81
9 . PEAK OUTPUT POWER TEST	85
9.1 APPLIED PROCEDURES / LIMIT	85
9.1.1 MEASUREMENT INSTRUMENTS LIST AND SETTING	85
9.1.2 TEST PROCEDURE	85
9.1.3 DEVIATION FROM STANDARD	85
9.1.4 TEST SETUP	85
9.1.5 EUT OPERATION CONDITIONS	85
9.1.6 TEST RESULTS	86
10 . ANTENNA CONDUCTED SPURIOUS EMISSION	90
10.1 APPLIED PROCEDURES / LIMIT	90
10.1.1 MEASUREMENT INSTRUMENTS LIST AND SETTING	90
10.1.2 TEST PROCEDURE	90

Table of Contents	Page
10.1.3 DEVIATION FROM STANDARD	90
10.1.4 TEST SETUP	91
10.1.5 EUT OPERATION CONDITIONS	91
10.1.6 TEST RESULTS	92
11 . RF EXPOSURE TEST	96
11.1 APPLIED PROCEDURES / LIMIT	96
11.1.1 MEASUREMENT INSTRUMENTS LIST	97
11.1.2 MPE CALCULATION METHOD	97
11.1.3 DEVIATION FROM STANDARD	98
11.1.4 TEST SETUP	98
11.1.5 EUT OPERATION CONDITIONS	98
12 . EUT TEST PHOTO	99

1. CERTIFICATION

Equipment : Bluetooth Headset
Trade Name : SKYWING
Model Name : SK-BTH-015A; SK-BTH-015B; SK-BTH-015C; SK-BTH-028;
SK-BTH-038; SK-BTH-018; SK-BTH-058; SK-BTH-066
Applicant : SKY WING COMMUNICATION ELECTRONICS CO.,LTD
Test Item : ENGINEERING SAMPLE
Date of Test : Aug. 22, 2008 ~ Sep. 30, 2008
Standards : FCC Part15, Subpart C(15.247) / ANCI C63.4 : 2003

The above equipment has been tested and found compliance with the requirement of the relative standards by Neutron Engineering Inc. EMC Laboratory.

The test data, data evaluation, and equipment configuration contained in our test report (Ref No. NEI-FCCP-1-0808C114) were obtained utilizing the test procedures, test instruments, test sites that has been accredited by the Authority of NVLAP and TAF according to the ISO-17025 quality assessment standard and technical standard(s).

2. SUMMARY OF TEST RESULTS

Test procedures according to the technical standards:

FCC Part15 (15.247) , Subpart C			
Standard Section	Test Item	Judgment	Remark
15.207	Conducted Emission	PASS	
15.247 (c)	Antenna conducted Spurious Emission	PASS	
15.247 (a)(1)	Hopping Channel Separation	PASS	
15.247 (b)(1)	Peak Output Power	PASS	
15.247 (c)	Radiated Spurious Emission	PASS	
15.247 (b)(1)	Number of Hopping Frequency	PASS	
15.247 (a)(1)	Dwell Time	PASS	
15.205	Restricted Bands	PASS	
15.203	Antenna Requirement	PASS	
1.1307 1.1310 2.1091 2.1093	RF Exposure Compliance	PASS	

NOTE:

(1) "N/A" denotes test is not applicable in this Test Report

2.1 TEST FACILITY

The test facilities used to collect the test data in this report is **C01/OS02** at the location of No.132-1, Lane 329, Sec. 2, Palain Road, Shijr City, Taipei, Taiwan.
Neutron's test firm number is 95335

2.2 MEASUREMENT UNCERTAINTY

The reported uncertainty of measurement $y \pm U$, where expended uncertainty **U** is based on a standard uncertainty multiplied by a coverage factor of **k=2**, providing a level of confidence of approximately **95 %**.

A. Conducted Measurement :

Test Site	Method	Measurement Frequency Range	U , (dB)	NOTE
C01	ANSI	150 KHz ~ 30MHz	1.94	

B. Radiated Measurement :

Test Site	Method	Measurement Frequency Range	Ant. H / V	U , (dB)	NOTE
OS-01	ANSI	30MHz ~ 200MHz	V	3.82	
		30MHz ~ 200MHz	H	3.60	
		200MHz ~ 1,000MHz	V	3.86	
		200MHz ~ 1,000MHz	H	3.94	
OS-02	ANSI	30MHz ~ 200MHz	V	2.48	
		30MHz ~ 200MHz	H	2.16	
		200MHz ~ 1,000MHz	V	2.50	
		200MHz ~ 1,000MHz	H	2.66	

3. GENERAL INFORMATION

3.1 GENERAL DESCRIPTION OF EUT

Equipment	Bluetooth Headset	
Trade Name	SKYWING	
Model Name	SK-BTH-015A; SK-BTH-015B; SK-BTH-015C; SK-BTH-028; SK-BTH-038; SK-BTH-018; SK-BTH-058; SK-BTH-066	
OEM Brand/Model Name	N/A	
Model Difference	Only difference is model names.	
Product Description	The EUT is a Bluetooth Headset	
	Operation Frequency:	2402~2480 MHz
	Modulation Type:	FHSS
	Bit Rate of Transmitter	GFSK(1Mbps) $\pi/4$ -DQPSK(2Mbps) 8-DPSK(3Mbps)
	Number Of Channel	79 CH
	Antenna Designation:	Please see Note 3.
	Antenna Gain(Peak)	Please see Note 3.
	Output Power:	-0.36 dBm (GFSK) -0.11 dBm (8-DPSK)
	Based on the application, features, or specification exhibited in User's Manual, the EUT is considered as an ITE/Computing Device. More details of EUT technical specification, please refer to the User's Manual.	
Channel List	Please refer to the Note 2.	
Power Source	DC Voltage supplied from USB Charger/Li-ion battery Model name:NL501220H	
Power Rating	I/P AC 120V/60Hz O/P DC 5V Li-ion battery 3.7Vdc	
Connecting I/O Port(s)	Please refer to the User's Manual	
Products Covered	N/A	

Note:

1. For a more detailed features description, please refer to the manufacturer's specifications or the User's Manual.

2.

Channel List					
Channel	Frequency (MHz)	Channel	Frequency (MHz)	Channel	Frequency (MHz)
00	2402	27	2429	54	2456
01	2403	28	2430	55	2457
02	2404	29	2431	56	2458
03	2405	30	2432	57	2459
04	2406	31	2433	58	2460
05	2407	32	2434	59	2461
06	2408	33	2435	60	2462
07	2409	34	2436	61	2463
08	2410	35	2437	62	2464
09	2411	36	2438	63	2465
10	2412	37	2439	64	2466
11	2413	38	2440	65	2467
12	2414	39	2441	66	2468
13	2415	40	2442	67	2469
14	2416	41	2443	68	2470
15	2417	42	2444	69	2471
16	2418	43	2445	70	2472
17	2419	44	2446	71	2473
18	2420	45	2447	72	2474
19	2421	46	2448	73	2475
20	2422	47	2449	74	2476
21	2423	48	2450	75	2477
22	2424	49	2451	76	2478
23	2425	50	2452	77	2479
24	2426	51	2453	78	2480
25	2427	52	2454		
26	2428	53	2455		

3.

Table for Filed Antenna

Ant	Brand	Model Name	Antenna Type	Connector	Gain (dBi)	NOTE
1	N/A	N/A	Printed Antenna	NA	2.74	BT Antenna

3.2 DESCRIPTION OF TEST MODES

To investigate the maximum EMI emission characteristics generates from EUT, the test system was pre-scanning tested base on the consideration of following EUT operation mode or test configuration mode which possible have effect on EMI emission level. Each of these EUT operation mode(s) or test configuration mode(s) mentioned above was evaluated respectively.

Pretest Mode	Description
Mode 1	CH00 (GFSK;8-DPSK)
Mode 2	CH39 (GFSK;8-DPSK)
Mode 3	CH78 (GFSK;8-DPSK)
Mode 4	Normal Link with charge mode

For Conducted Emission	
Final Test Mode	Description
Mode 4	Normal Link with charge mode

For Radiated Emission	
Final Test Mode	Description
Mode 1	CH00 (GFSK;8-DPSK)
Mode 2	CH39 (GFSK;8-DPSK)
Mode 3	CH78 (GFSK;8-DPSK)

Note:

- (1) The measurements are performed at the highest, middle, lowest available channels.
- (2) The EUT is considered a portable unit; it was pre-tested on the positioned of each 3 axis. The worst case was found positioned on X-plane. Therefore only the test data of this X-plane was used for radiated emission measurement test.

3.3 TABLE OF PARAMETERS OF TEXT SOFTWARE SETTING

During testing channel & power controlling software provided by the customer was used to control the operating channel as well as the output power level. The RF output power selection is for the setting of RF output power expected by the customer and is going to be fixed on the firmware of the final end product power parameters of FHSS

Test software Version	Test program: BlueTest		
Frequency	2402 MHz	2441 MHz	2480 MHz
Parameters(GFSK)	65	65	65
Parameters(8-DPSK)	100	100	100

3.4 BLOCK DIGRAM SHOWING THE CONFIGURATION OF SYSTEM TESTED

RADIATED MODE

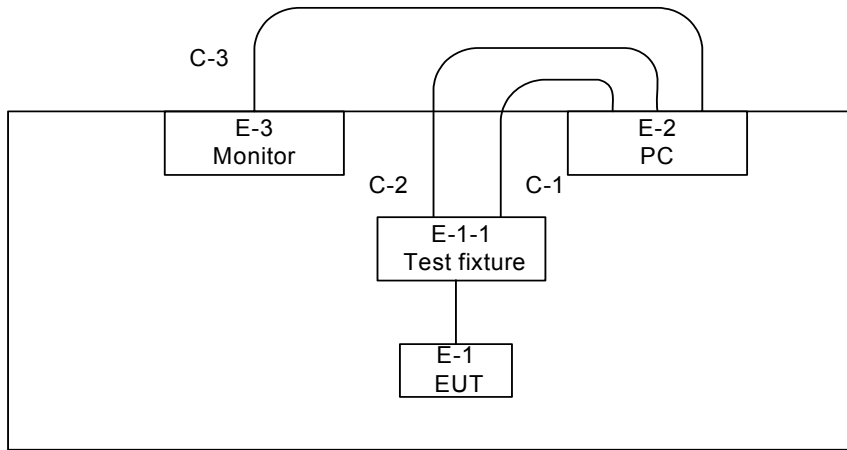

C-1 RS-232 Cable
 C-2 USB Cable
 C-3 VGA Cable

CONDUCTED MODE: NORMAL LINK WITH CHARGE MODE

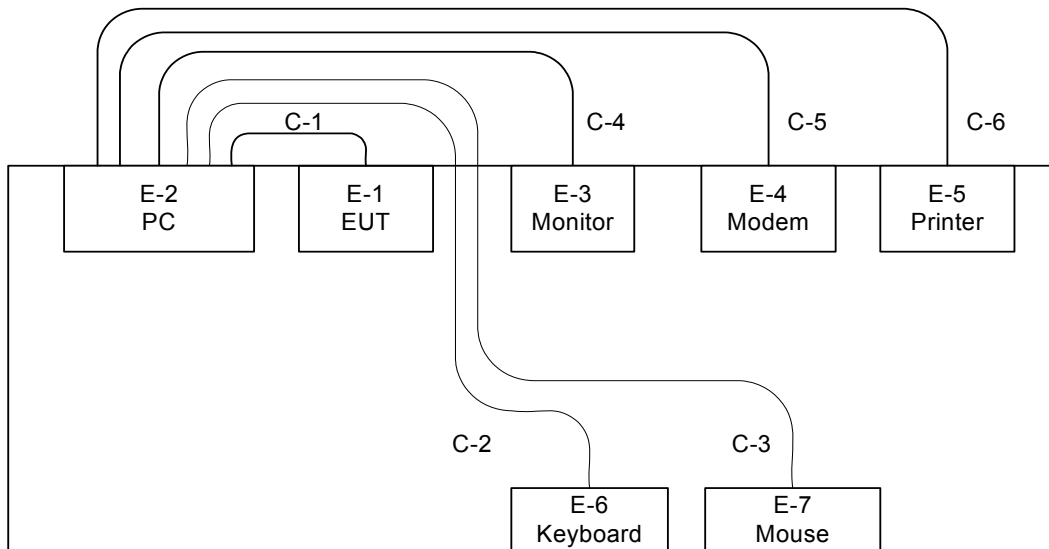

C-1 USB Cable
 C-2 Data Cable
 C-3 Data Cable
 C-4 VGA Cable
 C-5 RS232 Cable
 C-6 Parallel Cable

3.5 DESCRIPTION OF SUPPORT UNITS (RADIATED MODE)

The EUT has been tested as an independent unit together with other necessary accessories or support units. The following support units or accessories were used to form a representative test configuration during the tests.

Item	Equipment	Mfr/Brand	Model/Type No.	FCC ID	Series No.	Note
E-1	Bluetooth Headset	SKYWING	SK-BTH-015A	WGSK-BTH-015A	N/A	EUT
E-2	PC	HP	xw8200	DOC	SGH50402C3	
E-3	Monitor	DELL	E177FPc	DOC	CN-0FJ179-64180-6AG-1PKS	

Item	Shielded Type	Ferrite Core	Length	Note
C-1	YES	NO	1.0 M	
C-2	YES	NO	1.2 M	
C-3	YES	YES	1.8 M	

Note:

- (1) The support equipment was authorized by Declaration of Confirmation.
- (2) For detachable type I/O cable should be specified the length in cm in 『Length』 column.

3.1 DESCRIPTION OF SUPPORT UNITS(CONDUCTED MODE)

The EUT has been tested as an independent unit together with other necessary accessories or support units. The following support units or accessories were used to form a representative test configuration during the tests.

Item	Equipment	Mfr/Brand	Model/Type No.	FCC ID	Series No.	Note
E-1	Bluetooth Headset	N/A	SK-BTH-015A	WSGSK-BTH-015A	N/A	EUT
E-2	PC	HP	xw8200	DOC	SGH50402C3	
E-3	Monitor	DELL	E177FPc	DOC	CN-0FJ179-64180-6AG-1PKS	
E-4	Modem	ACEEX	DM-1414V	DOC	8041708	
E-5	Printer	SII	DPU-414	DOC	1045105A	
E-6	USB K/B	DELL	SK-8115	DOC	MY-0DJ325-71619-77N-1526	
E-7	USB Mouse	Dell	MO56UC	DOC	G0R000XN	

Item	Shielded Type	Ferrite Core	Length	Note
C-1	YES	NO	1.2 M	
C-2	YES	NO	1.8 M	
C-3	YES	NO	1.8 M	
C-4	YES	NO	1.8 M	
C-5	YES	NO	1.8 M	
C-6	YES	YES	1.8 M	

Note:

- (1) The support equipment was authorized by Declaration of Confirmation.
- (2) For detachable type I/O cable should be specified the length in cm in 『Length』 column.

4. EMC EMISSION TEST

4.1 CONDUCTED EMISSION MEASUREMENT

4.1.1 POWER LINE CONDUCTED EMISSION Limits (Frequency Range 150KHz-30MHz)

FREQUENCY (MHz)	Class A (dBuV)		Class B (dBuV)		Standard
	Quasi-peak	Average	Quasi-peak	Average	
0.15 -0.5	79.00	66.00	66 - 56 *	56 - 46 *	CISPR
0.50 -5.0	73.00	60.00	56.00	46.00	CISPR
5.0 -30.0	73.00	60.00	60.00	50.00	CISPR

0.15 -0.5	79.00	66.00	66 - 56 *	56 - 46 *	FCC
0.50 -5.0	73.00	60.00	56.00	46.00	FCC
5.0 -30.0	73.00	60.00	60.00	50.00	FCC

Note:

- (1) The tighter limit applies at the band edges.
- (2) The limit of " * " marked band means the limitation decreases linearly with the logarithm of the frequency in the range.

4.1.2 MEASUREMENT INSTRUMENTS LIST AND SETTING

Item	Kind of Equipment	Manufacturer	Type No.	Serial No.	Calibrated until
1	LISN	EMCO	3816/2	00042991	Jan. 24, 2009
2	LISN	EMCO	3816/2	00042990	Jan. 24, 2009
3	Pulse Limiter	Electro-Metrics	EM-7600	112644	Nov. 27, 2008
4	50Ω Terminator	N/A	N/A	N/A	May.12, 2009
5	Test Cable	N/A	C01	N/A	Nov. 27, 2008
6	EMI Test Receiver	R&S	ESCI	100082	Mar. 07, 2009

Remark: " N/A" denotes No Model No. , Serial No. or No Calibration specified.

The following table is the setting of the receiver

Receiver Parameters	Setting
Attenuation	10 dB
Start Frequency	0.15 MHz
Stop Frequency	30 MHz
IF Bandwidth	9 kHz

4.1.3 TEST PROCEDURE

- a. The EUT was placed 0.4 meters from the horizontal ground plane with EUT being connected to the power mains through a line impedance stabilization network (LISN). All other support equipments powered from additional LISN(s). The LISN provide 50 Ohm/ 50uH of coupling impedance for the measuring instrument.
- b. Interconnecting cables that hang closer than 40 cm to the ground plane shall be folded back and forth in the center forming a bundle 30 to 40 cm long.
- c. I/O cables that are not connected to a peripheral shall be bundled in the center. The end of the cable may be terminated, if required, using the correct terminating impedance. The overall length shall not exceed 1 m.
- d. LISN at least 80 cm from nearest part of EUT chassis.
- e. For the actual test configuration, please refer to the related Item –EUT Test Photos.

4.1.4 DEVIATION FROM TEST STANDARD

No deviation

4.1.5 TEST SETUP

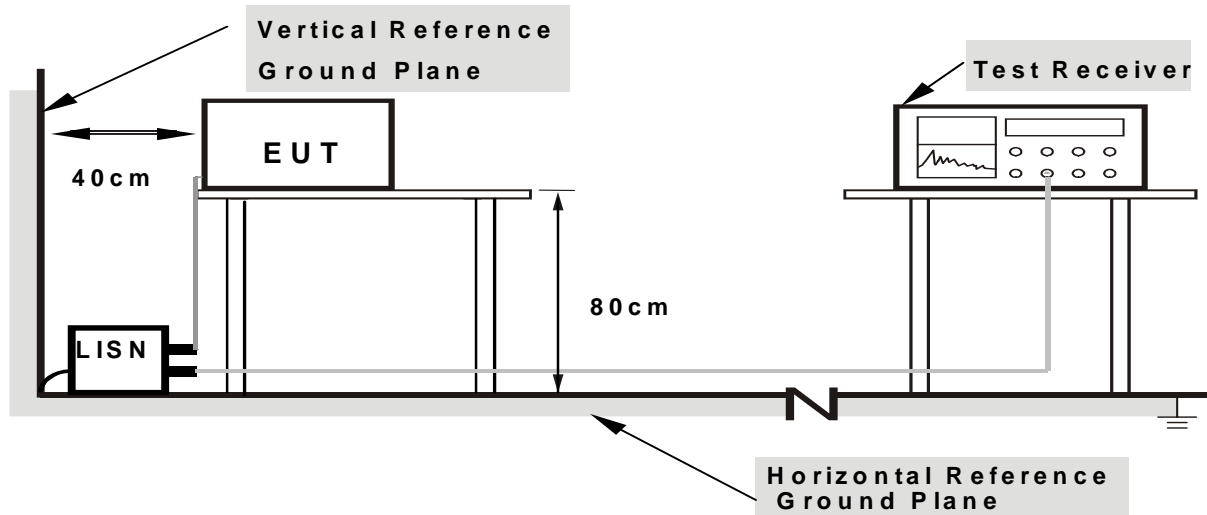

Note: 1. Support units were connected to second LISN.

2. Both of LISNs (AMN) are 80 cm from EUT and at least 80 cm from other units and other metal planes

4.1.6 EUT OPERATING CONDITIONS

The EUT was configured for testing in a typical fashion (as a customer would normally use it). The EUT has been programmed to continuously transmit during test. This operating condition was tested and used to collect the included data.

4.1.7 TEST RESULTS

EUT :	Bluetooth Headset	Model Name :	SK-BTH-015A
Temperature :	27 °C	Relative Humidity :	56%
Pressure :	1010hPa	Test Voltage :	AC 120V/60Hz
Test Mode :	Normal Link with charge mode		

Freq. (MHz)	Terminal L/N	Measured(dBuV)		Limits(dBuV)		Margin (dB)	Note
		QP-Mode	AV-Mode	QP-Mode	AV-Mode		
0.20	Line	51.09	*	63.82	53.82	-12.73	(QP)
0.31	Line	48.48	38.22	60.11	50.11	-11.63	(QP)
0.48	Line	47.28	36.55	56.43	46.43	-9.15	(QP)
0.57	Line	47.73	33.67	56.00	46.00	-8.27	(QP)
0.87	Line	45.31	31.53	56.00	46.00	-10.69	(QP)
11.77	Line	41.16	*	60.00	50.00	-18.84	(QP)

Remark

- (1) All readings are QP Mode value unless otherwise stated AVG in column of "Note". If the QP Mode Measured value compliance with the QP Limits and lower than AVG Limits, the EUT shall be deemed to meet both QP & AVG Limits and then only QP Mode was measured, but AVG Mode didn't perform. In this case, a "*" marked in AVG Mode column of Interference Voltage Measured.
- (2) Measuring frequency range from 150KHz to 30MHz.

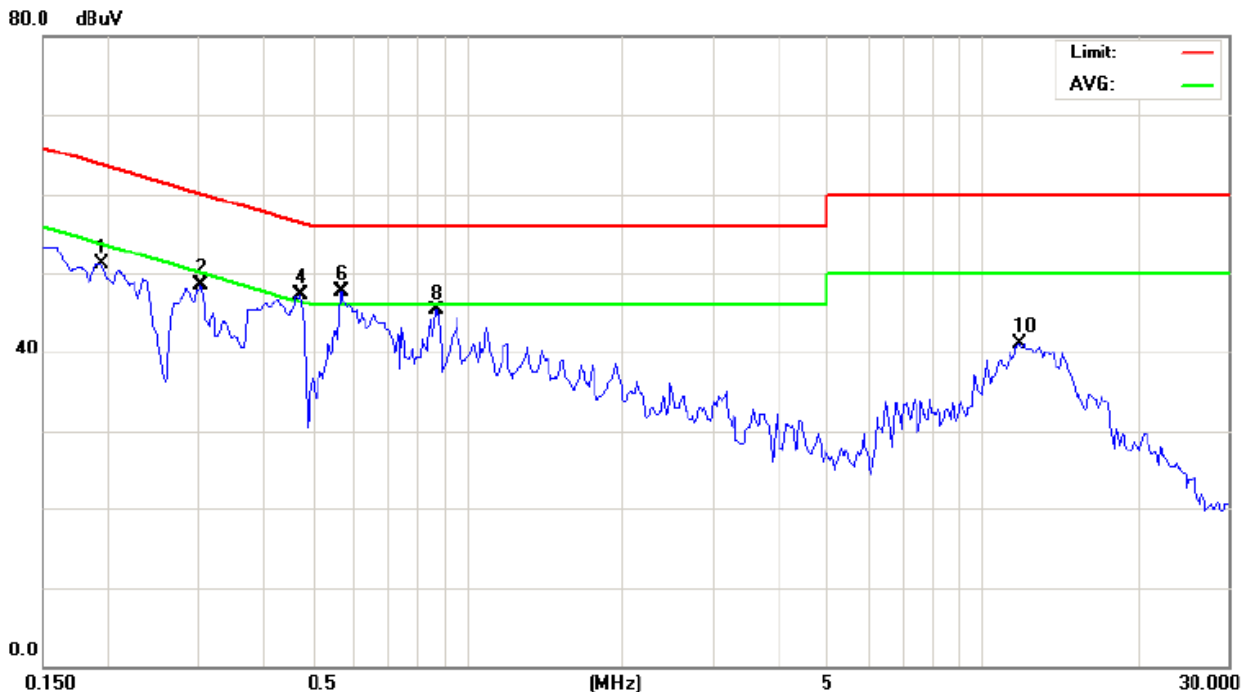

EUT :	Bluetooth Headset	Model Name :	SK-BTH-015A
Temperature :	27 °C	Relative Humidity :	56%
Pressure :	1010 hPa	Test Voltage :	AC 120V/60Hz
Test Mode :	Normal Link with charge mode		

Freq. (MHz)	Terminal L/N	Measured(dBuV)		Limits(dBuV)		Margin (dB)	Note
		QP-Mode	AV-Mode	QP-Mode	AV-Mode		
0.23	Neutral	50.21	*	62.61	52.61	-12.40	(QP)
0.29	Neutral	49.88	40.69	60.67	50.67	-9.98	(AV)
0.47	Neutral	47.88	34.68	56.51	46.51	-8.63	(QP)
0.57	Neutral	48.44	34.24	56.00	46.00	-7.56	(QP)
0.96	Neutral	46.06	36.72	56.00	46.00	-9.28	(AV)
13.05	Neutral	44.33	*	60.00	50.00	-15.67	(QP)

Remark

- (1) All readings are QP Mode value unless otherwise stated AVG in column of Note. If the QP Mode Measured value compliance with the QP Limits and lower than AVG Limits, the EUT shall be deemed to meet both QP & AVG Limits and then only QP Mode was measured, but AVG Mode didn't perform. In this case, a "*" marked in AVG Mode column of Interference Voltage Measured.
- (2) Measuring frequency range from 150KHz to 30MHz.

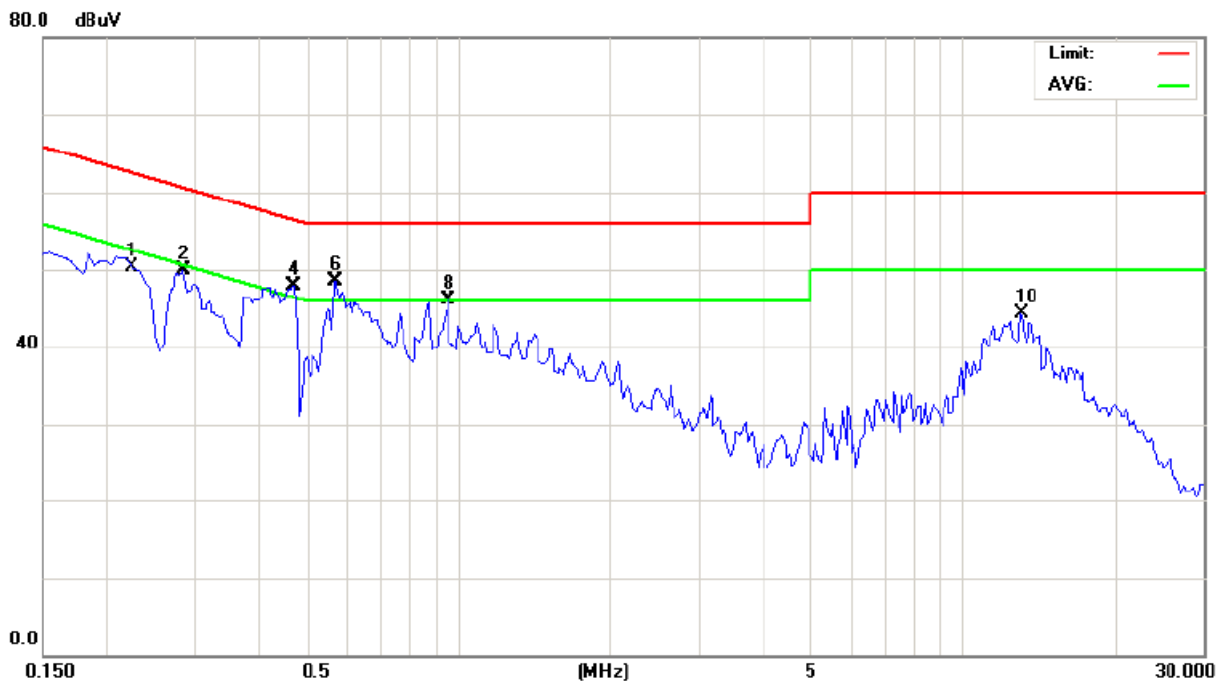

4.2 RADIATED EMISSION MEASUREMENT

4.2.1 RADIATED EMISSION LIMITS (Frequency Range 9kHz-1000MHz)

20dBc in any 100 kHz bandwidth outside the operating frequency band. In case the emission fall within the restricted band specified on 15.205(a), then the 15.209(a) limit in the table below has to be followed.

Frequencies (MHz)	Field Strength (micorvolts/meter)	Measurement Distance (meters)
0.009~0.490	2400/F(KHz)	300
0.490~1.705	24000/F(KHz)	30
1.705~30.0	30	30
30~88	100	3
88~216	150	3
216~960	200	3
Above 960	500	3

LIMITS OF RADIATED EMISSION MEASUREMENT (Above 1000MHz)

FREQUENCY (MHz)	Class A (dBuV/m) (at 3m)		Class B (dBuV/m) (at 3m)	
	PEAK	AVERAGE	PEAK	AVERAGE
Above 1000	80	60	74	54

Notes:

- (1) The limit for radiated test was performed according to FCC PART 15C.
- (2) The tighter limit applies at the band edges.
- (3) Emission level (dBuV/m)=20log Emission level (uV/m).

FREQUENCY RANGE OF RADIATED MEASUREMENT (For unintentional radiators)

Highest frequency generated or Upper frequency of measurement used in the device or on which the device operates or tunes (MHz)	Range (MHz)
Below 1.705	30
1.705 – 108	1000
108 – 500	2000
500 – 1000	5000
Above 1000	5 th harmonic of the highest frequency or 40 GHz, whichever is lower

4.2.2 MEASUREMENT INSTRUMENTS LIST AND SETTING

Item	Kind of Equipment	Manufacturer	Type No.	Serial No.	Calibrated until
1	Log-Bicon Antenna	Schwarzbeck	VULB 9160	3058	Nov. 27, 2008
2	Test Cable	N/A	10M_OS02	N/A	Nov. 27, 2008
3	Test Cable	N/A	OS02-1/-2/-3	N/A	Nov. 27, 2008
4	Pre-Amplifier	Anritsu	MH648A	M09961	Nov. 27, 2008
5	EMI Test Receiver	R&S	ESCI	100082	Jan. 30, 2009
6	Antenna Mast	Chance Most	CMTB-1.5	N/A	N/A
7	Turn Table	Chance Most	CMTB-1.5	N/A	N/A
8	Spectrum Analyzer	R&S	FSP_40	100129	Jan. 07, 2009
9	Horn Antenna	Schwarzbeck	BBHA9120D	9120D-325	Oct. 24, 2008
10	Horn Antenna	Schwarzbeck	BBHA9170	9170187	Oct. 24, 2008
11	Microwave Pre amplifier	Agilent	8449B	3008A01714	Mar. 09, 2009
12	Microflex Cable	United Microwave	57793	1m	Mar. 09, 2009
13	Microflex Cable	United Microwave	A30A30-5006	10M	Jul. 06, 2009

Remark: " N/A" denotes No Model Name / Serial No. and No Calibration specified.

Spectrum Parameter	Setting
Attenuation	Auto
Start Frequency	1000 MHz
Stop Frequency	10th carrier harmonic
RB / VB (emission in restricted band)	1MHz / 1MHz for Peak, 1 MHz / 10Hz for Average
RB / VB (other emission)	100KHz / 100KHz for peak

Receiver Parameter	Setting
Attenuation	Auto
Start ~ Stop Frequency	9kHz~150kHz / RB 200Hz for QP
Start ~ Stop Frequency	150kHz~30MHz / RB 9kHz for QP
Start ~ Stop Frequency	30MHz~1000MHz / RB 120kHz for QP

4.2.3 TEST PROCEDURE

- a. The measuring distance of at 3 m shall be used for measurements at frequency up to 1GHz. For frequencies above 1GHz, any suitable measuring distance may be used.
- b. The EUT was placed on the top of a rotating table 0.8 meters above the ground at a 3 meter open area test site. The table was rotated 360 degrees to determine the position of the highest radiation.
- c. The height of the equipment or of the substitution antenna shall be 0.8 m; the height of the test antenna shall vary between 1 m to 4 m. Both horizontal and vertical polarizations of the antenna are set to make the measurement.
- d. The initial step in collecting conducted emission data is a spectrum analyzer peak detector mode pre-scanning the measurement frequency range. Significant peaks are then marked and then Quasi Peak detector mode re-measured.
- e. If the Peak Mode measured value compliance with and lower than Quasi Peak Mode Limit, the EUT shall be deemed to meet QP Limits and then no additional QP Mode measurement performed.
- f. For the actual test configuration, please refer to the related Item –EUT Test Photos.

4.2.4 DEVIATION FROM TEST STANDARD

No deviation

4.2.5 TEST SETUP

(A) Radiated Emission Test Set-Up, Frequency Below 1000MHz

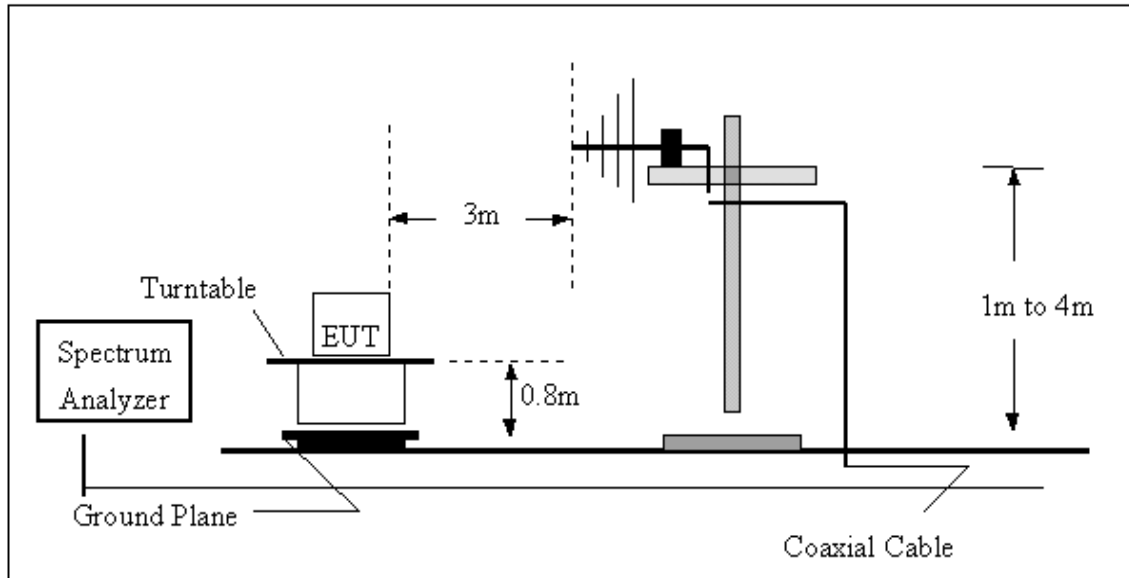

(B) Radiated Emission Test Set-Up Frequency Above 1 GHz

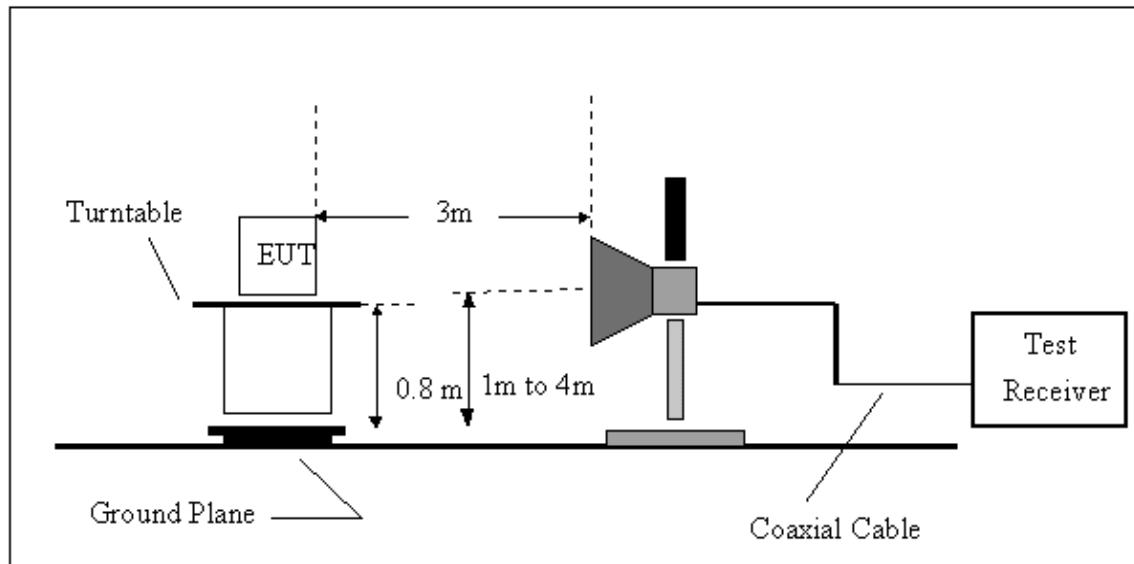

4.2.6 EUT OPERATING CONDITIONS

The EUT tested system was configured as the statements of 4.1.6 Unless otherwise a special operating condition is specified in the follows during the testing.

4.2.7 TEST RESULTS (BETWEEN 30 – 1000 MHZ)

EUT :	Bluetooth Headset	Model Name :	SK-BTH-015A
Temperature :	25 °C	Relative Humidity :	60%
Pressure :	1010 hPa	Test Voltage :	Li-ion Battery 3.7Vdc
Test Mode :	TX Mode 2441MHz		

Freq. (MHz)	Ant. H/V	Reading(RA) (dBuV)	Corr.Factor(CF) (dB)	Measured(FS) (dBuV/m)	Limits(QP) (dBuV/m)	Margin (dB)	Note
63.00	V	32.54	-10.61	21.93	40.00	- 18.07	
132.64	V	34.86	-9.43	25.43	43.50	- 18.07	
189.06	V	34.25	-10.69	23.56	43.50	- 19.94	
239.54	V	32.37	-10.39	21.98	46.00	- 24.02	
567.38	V	20.80	-0.82	19.98	46.00	- 26.02	
743.94	V	26.47	2.20	28.67	46.00	- 17.33	

Remark :

- (1) Reading in which marked as QP or Peak means measurements by using are Quasi-Peak Mode or Peak Mode with Detector BW=120KHz ; SPA setting in RBW=120KHz, VBW =120KHz, Swp. Time = 0.3 sec./MHz ◦
- (2) All readings are Peak unless otherwise stated QP in column of 『 Note 』 . Peak denotes that the Peak reading compliance with the QP Limits and then QP Mode measurement didn't perform ◦
- (3) Measuring frequency range from 30MHz to 1000MHz ◦
- (4) If the peak scan value lower limit more than 20dB, then this signal data does not show in table ◦

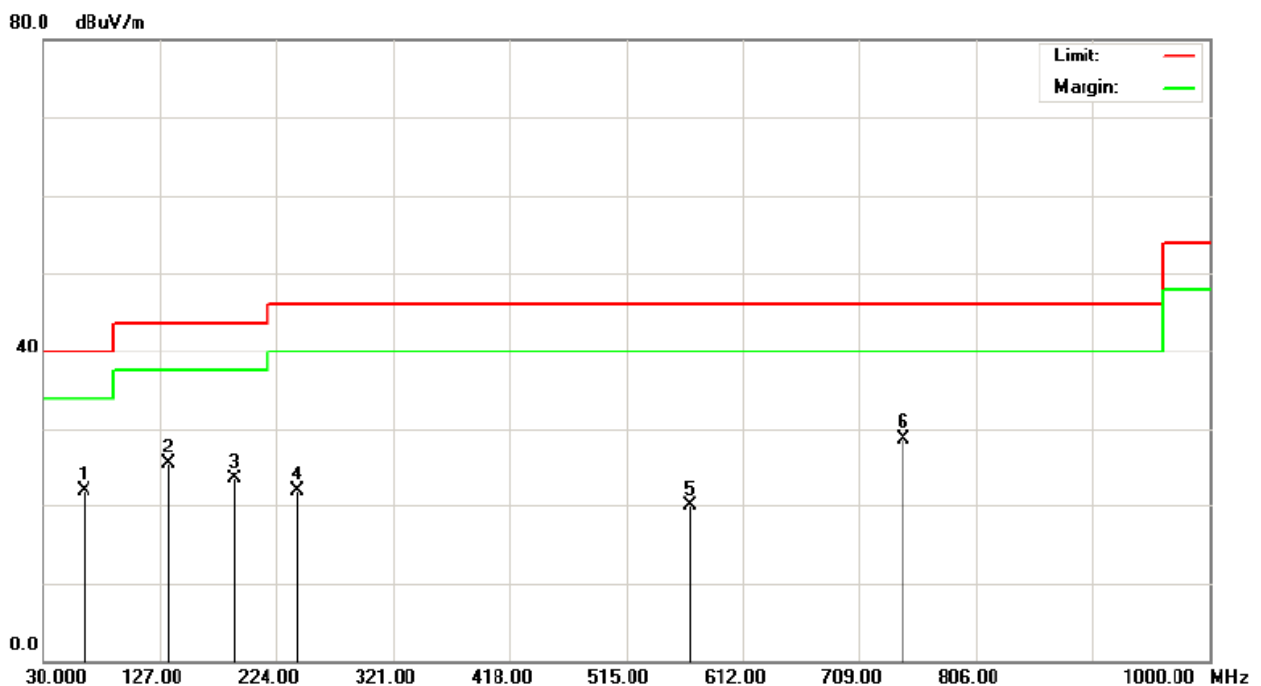

EUT :	Bluetooth Headset	Model Name :	SK-BTH-015A
Temperature :	25 °C	Relative Humidity :	60%
Pressure :	1010 hPa	Test Voltage :	Li-ion Battery 3.7Vdc
Test Mode :	TX Mode 2441MHz		

Freq. (MHz)	Ant. H/V	Reading(RA) (dBuV)	Corr.Factor(CF) (dB)	Measured(FS) (dBuV/m)	Limits(QP) (dBuV/m)	Margin (dB)	Note
72.68	H	33.09	-12.22	20.87	40.00	- 19.13	
109.54	H	35.58	-10.69	24.89	43.50	- 18.61	
119.24	H	39.74	-10.29	29.45	43.50	- 14.05	
239.76	H	41.05	-10.39	30.66	46.00	- 15.34	
567.38	H	26.71	-0.82	25.89	46.00	- 20.11	
666.77	H	27.44	1.01	28.45	46.00	- 17.55	

Remark :

- (1) Reading in which marked as QP or Peak means measurements by using are Quasi-Peak Mode or Peak Mode with Detector BW=120KHz ; SPA setting in RBW=120KHz, VBW =120KHz, Swp. Time = 0.3 sec./MHz .
- (2) All readings are Peak unless otherwise stated QP in column of 『 Note 』 . Peak denotes that the Peak reading compliance with the QP Limits and then QP Mode measurement didn't perform .
- (3) Measuring frequency range from 30MHz to 1000MHz .
- (4) If the peak scan value lower limit more than 20dB, then this signal data does not show in table .

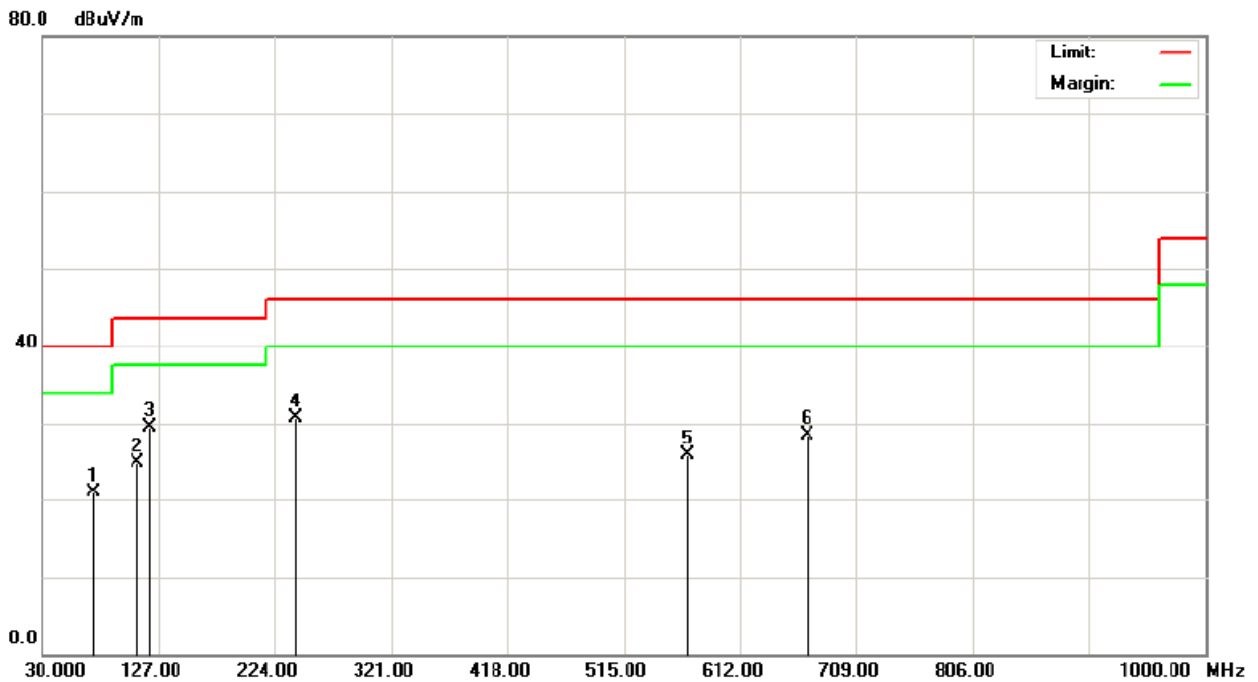

4.2.8 TEST RESULTS (ABOVE 1000 MHZ)

EUT :	Bluetooth Headset	Model Name :	SK-BTH-015A
Temperature :	30 °C	Relative Humidity :	63%
Pressure :	1010 hPa	Test Voltage :	Li-ion Battery 3.7Vdc
Test Mode :	TX 2402MHz – CH 00-1Mbps		

Freq. (MHz)	Ant.Pol. H/V	Reading		Ant./CF CF(dB)	Act.		Limit		Note
		Peak (dBuV)	AV (dBuV)		Peak (dBuV/m)	AV (dBuV/m)	Peak (dBuV/m)	AV (dBuV/m)	
2390.00	V	25.08	14.19	32.05	57.13	46.24	74.00	54.00	X/E
2402.00	V	49.97	25.82	32.08	82.05	57.90			X/F
1602.04	V	47.37	43.57	-6.51	40.86	37.06	74.00	54.00	X/H
4804.04	V	65.47	40.14	3.51	68.98	43.65	74.00	54.00	X/H

Remark :

- (1) All readings are Peak unless otherwise stated QP in column of 『Note』 . Peak denotes that the Peak reading compliance with the QP Limits and then QP Mode measurement didn't perform .
- (2) Measuring frequency range from 30MHz to 1000MHz or the 10th harmonic of highest fundamental frequency .“F” denotes fundamental frequency; “H” denotes spurious frequency. “E” denotes band edge frequency. (This judgment method includes the Band Edge Requirement.)
- (3) Radiated emissions measured in frequency range above 1000MHz were made with an instrument using Peak detector mode and AV detector mode of the emission .
- (4) Data of measurement within this frequency range shown “ * ” in the table above means the reading of emissions are attenuated more than 20dB below the permissible limits or the field strength is too small to be measured.
- (5) A preamp and high pass filter were used for this test in order to provide sufficient measurement sensitivity.
- (6) EUT Orthogonal Axis :
“X” - denotes Laid on Table ; “Y” - denotes Vertical Stand ; “Z” - denotes Side Stand
- (7) During the measurements above 1 GHz it is taken care of that the EUT is always within the 3 dB cone of radiation BW of the used antenna

TX CH00(Above 1000 MHz, Vertical)

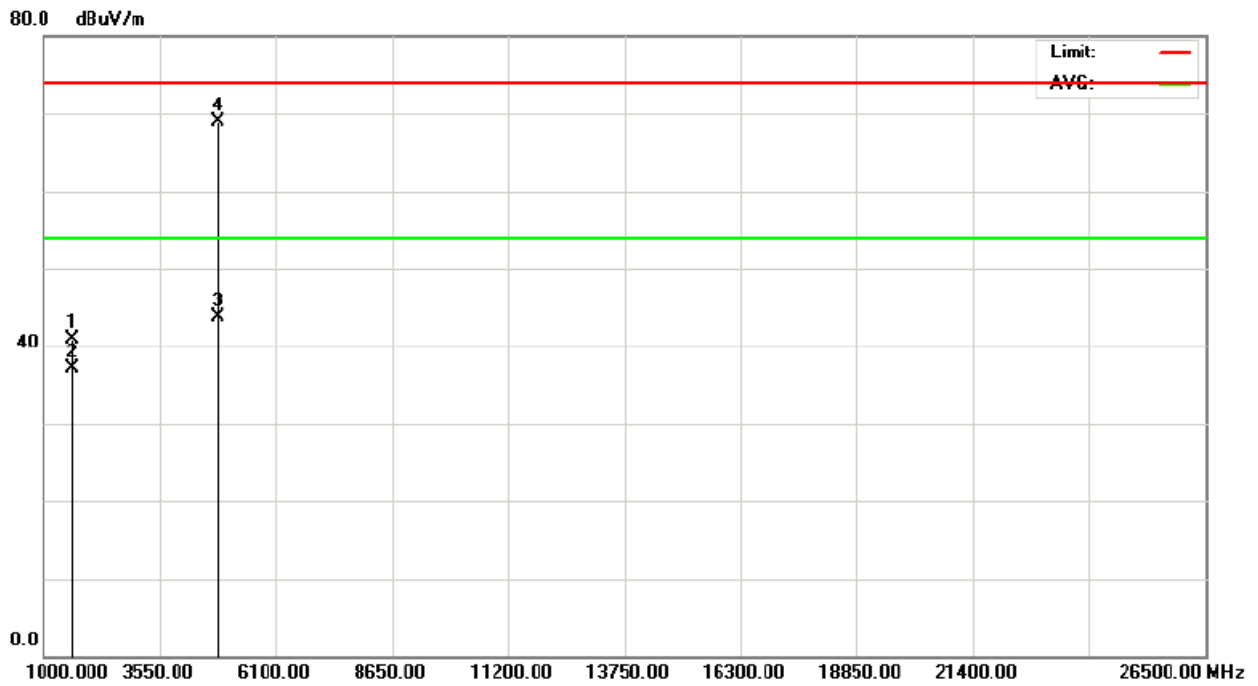
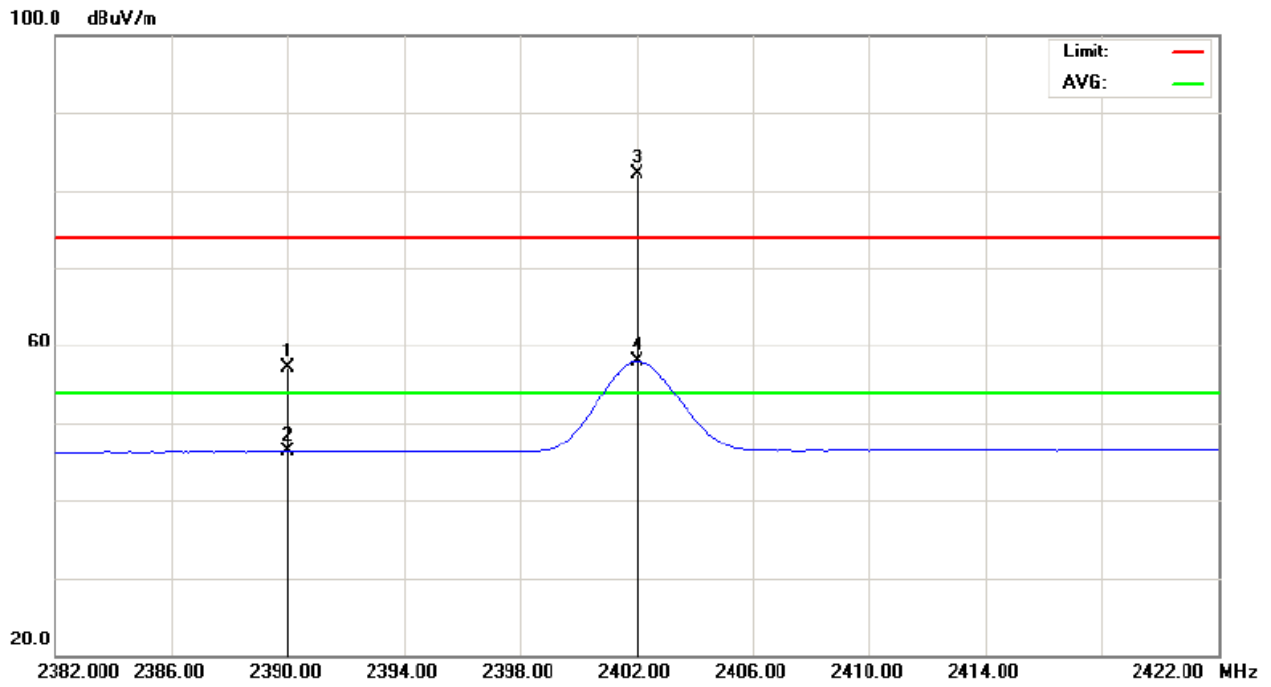

EUT :	Bluetooth Headset	Model Name :	SK-BTH-015A
Temperature :	30 °C	Relative Humidity :	63%
Pressure :	1010hPa	Test Voltage :	Li-ion Battery 3.7Vdc
Test Mode :	TX 2402MHz – CH 00-1Mbps		

Freq. (MHz)	Ant.Pol. H/V	Reading		Ant./CF CF(dB)	Act.		Limit		Note
		Peak (dBuV)	AV (dBuV)		Peak (dBuV/m)	AV (dBuV/m)	Peak (dBuV/m)	AV (dBuV/m)	
2390.00	H	25.55	14.19	32.05	57.60	46.24	74.00	54.00	X/E
2401.84	H	60.18	29.38	32.08	92.26	61.46			X/F
1602.04	H	53.39	49.72	-6.51	46.88	43.21	74.00	54.00	X/H
4804.04	H	64.26	39.76	3.51	67.77	43.27	74.00	54.00	X/H

Remark :

- (1) All readings are Peak unless otherwise stated QP in column of 『Note』 . Peak denotes that the Peak reading compliance with the QP Limits and then QP Mode measurement didn't perform .
- (2) Measuring frequency range from 30MHz to 1000MHz or the 10th harmonic of highest fundamental frequency .“F” denotes fundamental frequency; “H” denotes spurious frequency. “E” denotes band edge frequency. (This judgment method includes the Band Edge Requirement.)
- (3) Radiated emissions measured in frequency range above 1000MHz were made with an instrument using Peak detector mode and AV detector mode of the emission .
- (4) Data of measurement within this frequency range shown “ * ” in the table above means the reading of emissions are attenuated more than 20dB below the permissible limits or the field strength is too small to be measured.
- (5) A preamp and high pass filter were used for this test in order to provide sufficient measurement sensitivity.
- (6) EUT Orthogonal Axis :
“X” - denotes Laid on Table ; “Y” - denotes Vertical Stand ; “Z” - denotes Side Stand
- (7) During the measurements above 1 GHz it is taken care of that the EUT is always within the 3 dB cone of radiation BW of the used antenna

TX CH00(Above 1000 MHz, Horizontal)

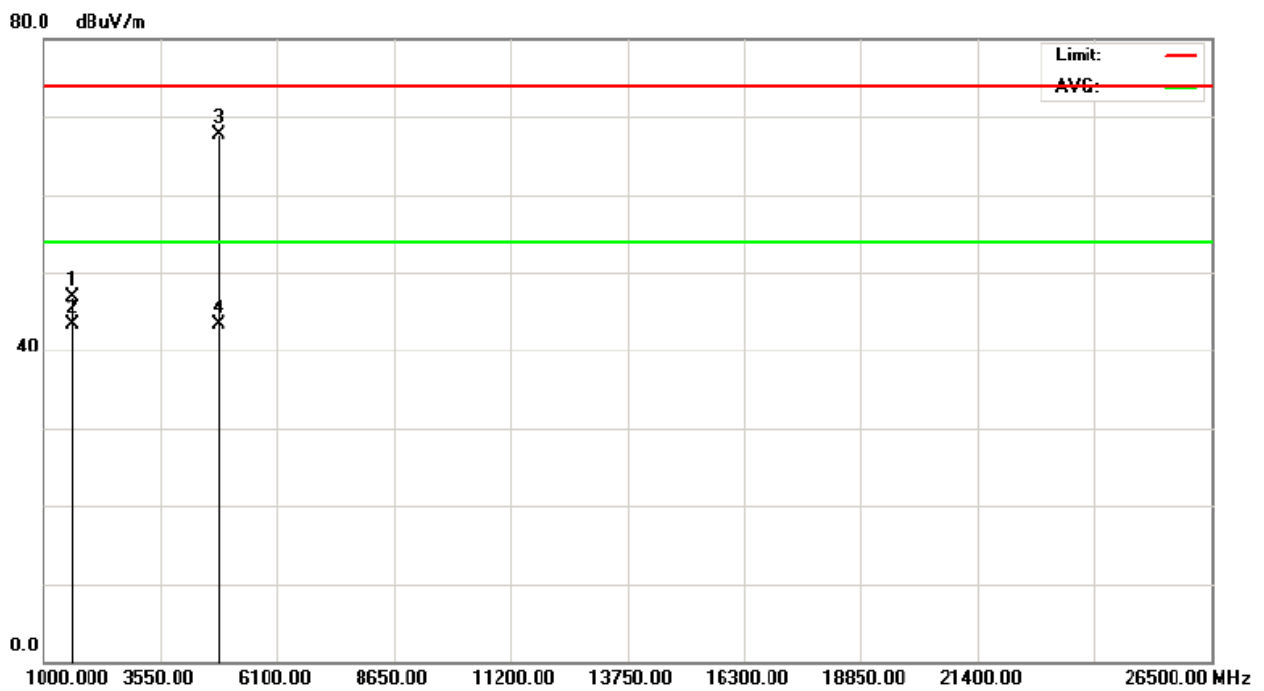
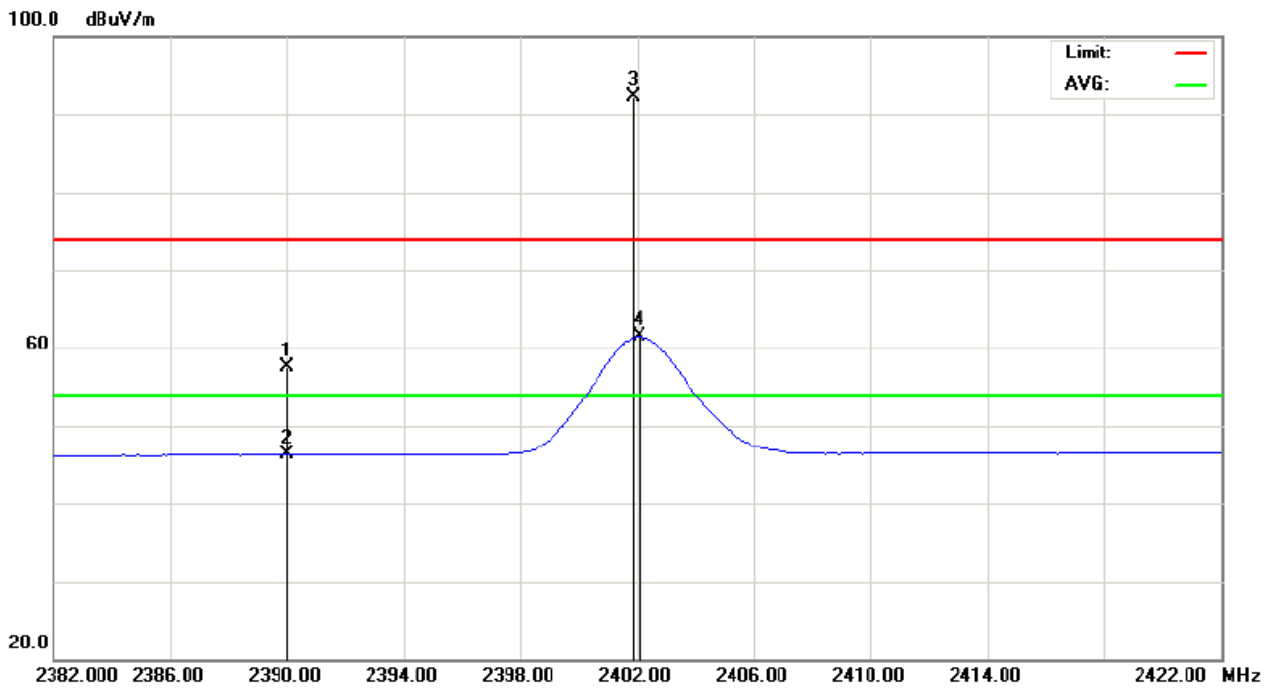

EUT :	Bluetooth Headset	Model Name :	SK-BTH-015A
Temperature :	30 °C	Relative Humidity :	63%
Pressure :	1010 hPa	Test Voltage :	Li-ion Battery 3.7Vdc
Test Mode :	TX 2441MHz –CH39-1Mbps		

Freq. (MHz)	Ant.Pol. H/V	Reading		Ant./CF CF(dB)	Act.		Limit		Note
		Peak (dBuV)	AV (dBuV)		Peak (dBuV/m)	AV (dBuV/m)	Peak (dBuV/m)	AV (dBuV/m)	
2440.84	V	48.88	25.50	32.21	81.09	57.71			X/F
1628.81	V	48.26	44.48	-6.36	41.90	38.12	74.00	54.00	X/H
4882.04	V	66.08	39.42	3.75	69.83	43.17	74.00	54.00	X/H

Remark :

- (1) All readings are Peak unless otherwise stated QP in column of 『Note』 . Peak denotes that the Peak reading compliance with the QP Limits and then QP Mode measurement didn't perform .
- (2) Measuring frequency range from 30MHz to 1000MHz or the 10th harmonic of highest fundamental frequency .“F” denotes fundamental frequency; “H” denotes spurious frequency. “E” denotes band edge frequency. (This judgment method includes the Band Edge Requirement.)
- (3) Radiated emissions measured in frequency range above 1000MHz were made with an instrument using Peak detector mode and AV detector mode of the emission .
- (4) Data of measurement within this frequency range shown “ * ” in the table above means the reading of emissions are attenuated more than 20dB below the permissible limits or the field strength is too small to be measured.
- (5) A preamp and high pass filter were used for this test in order to provide sufficient measurement sensitivity.
- (6) EUT Orthogonal Axis :
“X” - denotes Laid on Table ; “Y” - denotes Vertical Stand ; “Z” - denotes Side Stand
- (7) During the measurements above 1 GHz it is taken care of that the EUT is always within the 3 dB cone of radiation BW of the used antenna

TX CH39 (Above 1000 MHz, Vertical)

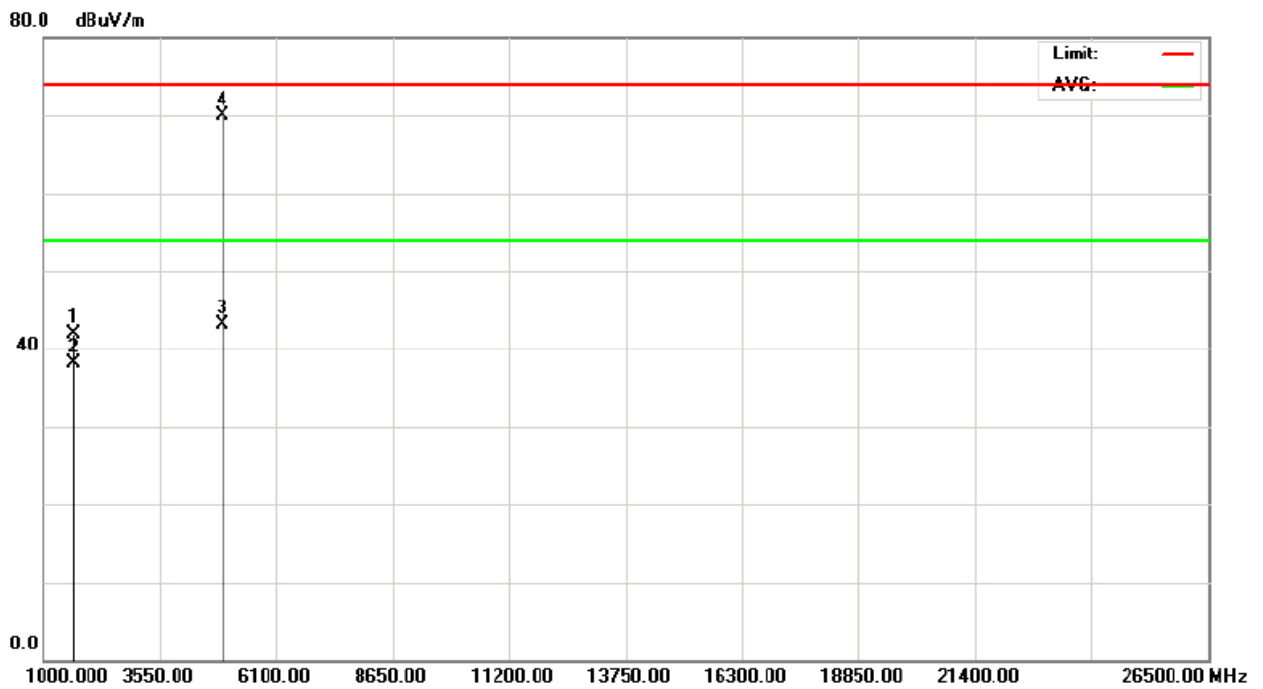
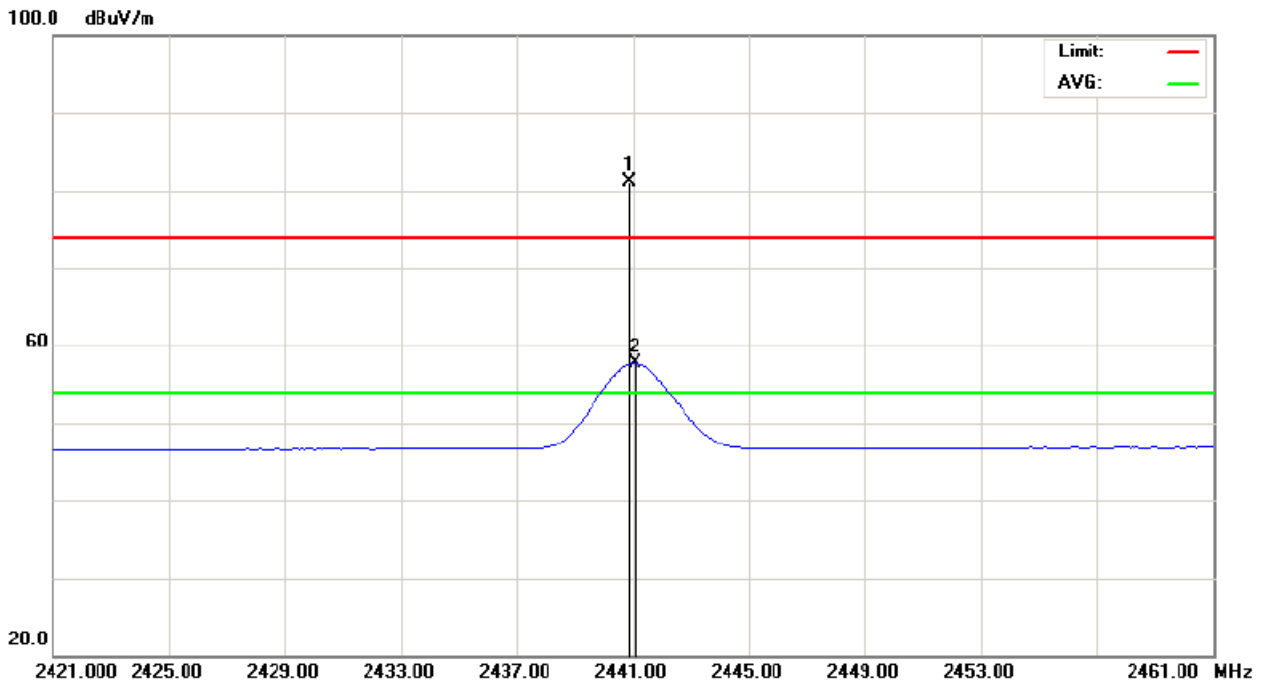

EUT :	Bluetooth Headset	Model Name :	SK-BTH-015A
Temperature :	30 °C	Relative Humidity :	63%
Pressure :	1010 hPa	Test Voltage :	Li-ion Battery 3.7Vdc
Test Mode :	TX 2441MHz –CH39-1Mbps		

Freq.	Ant.Pol.	Reading		Ant./CF	Act.		Limit		Note
		Peak	AV		Peak	AV	Peak	AV	
(MHz)	H/V	(dBuV)	(dBuV)	CF(dB)	(dBuV/m)	(dBuV/m)	(dBuV/m)	(dBuV/m)	
2440.92	H	59.86	29.39	32.21	92.07	61.60			X/F
1628.10	H	54.32	51.77	-6.36	47.96	45.41	74.00	54.00	X/H
4882.00	H	61.85	38.00	3.75	65.60	41.75	74.00	54.00	X/H

Remark :

- (1) All readings are Peak unless otherwise stated QP in column of 『 Note 』 . Peak denotes that the Peak reading compliance with the QP Limits and then QP Mode measurement didn't perform .
- (2) Measuring frequency range from 30MHz to 1000MHz or the 10th harmonic of highest fundamental frequency . "F" denotes fundamental frequency; "H" denotes spurious frequency. "E" denotes band edge frequency. (This judgment method includes the Band Edge Requirement.)
- (3) Radiated emissions measured in frequency range above 1000MHz were made with an instrument using Peak detector mode and AV detector mode of the emission .
- (4) Data of measurement within this frequency range shown " * " in the table above means the reading of emissions are attenuated more than 20dB below the permissible limits or the field strength is too small to be measured.
- (5) A preamp and high pass filter were used for this test in order to provide sufficient measurement sensitivity.
- (6) EUT Orthogonal Axis :
 "X" - denotes Laid on Table ; "Y" - denotes Vertical Stand ; "Z" - denotes Side Stand
- (7) During the measurements above 1 GHz it is taken care of that the EUT is always within the 3 dB cone of radiation BW of the used antenna

TX CH39 (Above 1000 MHz, Horizontal)

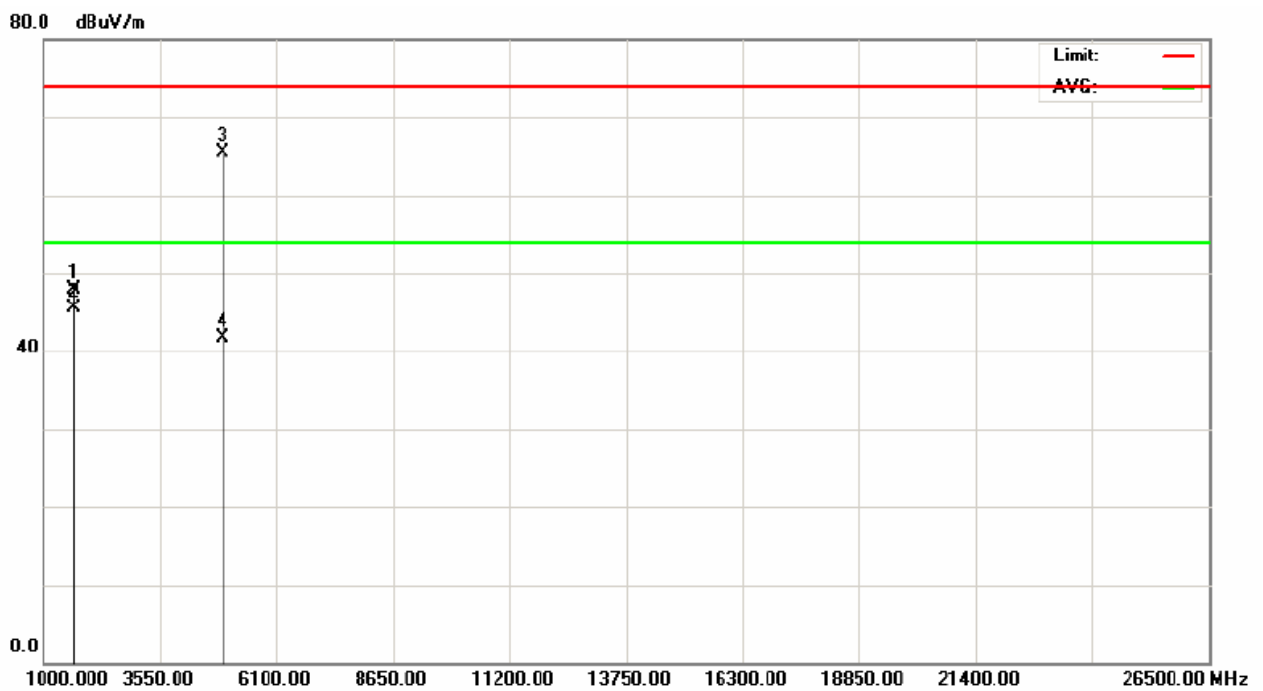
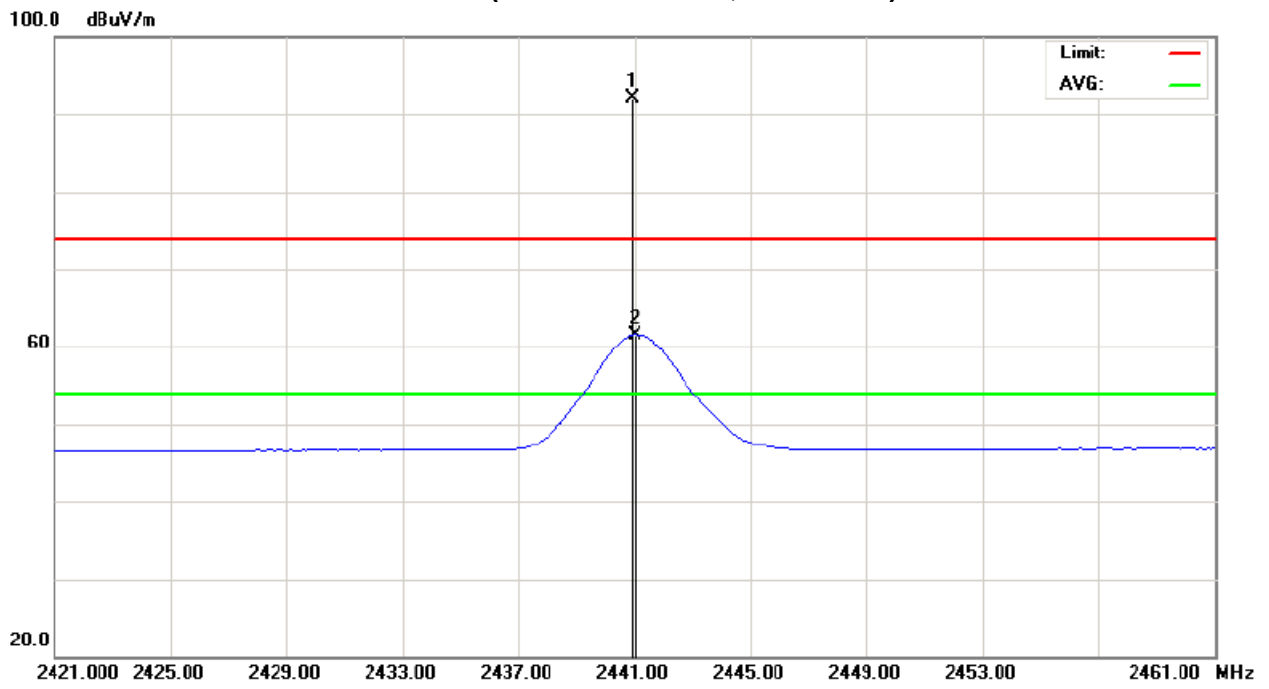

EUT :	Bluetooth Headset	Model Name :	SK-BTH-015A
Temperature :	30 °C	Relative Humidity :	63%
Pressure :	1010hPa	Test Voltage :	Li-ion Battery 3.7Vdc
Test Mode :	TX 2480MHz –CH78-1Mbps		

Freq.	Ant.Pol.	Reading		Ant./CF	Act.		Limit		Note
		Peak	AV		Peak	AV	Peak	AV	
(MHz)	H/V	(dBuV)	(dBuV)	CF(dB)	(dBuV/m)	(dBuV/m)	(dBuV/m)	(dBuV/m)	
2480.00	V	50.30	26.13	32.34	82.64	58.47			X/F
2483.50	V	25.46	14.96	32.34	57.80	47.30	74.00	54.00	X/E
1654.02	V	52.04	49.36	-6.21	45.83	43.15	74.00	54.00	X/H
4960.04	V	63.29	39.75	3.98	67.27	43.73	74.00	54.00	X/H

Remark :

- (1) All readings are Peak unless otherwise stated QP in column of 『Note』 . Peak denotes that the Peak reading compliance with the QP Limits and then QP Mode measurement didn't perform .
- (2) Measuring frequency range from 30MHz to 1000MHz or the 10th harmonic of highest fundamental frequency .“F” denotes fundamental frequency; “H” denotes spurious frequency. “E” denotes band edge frequency. (This judgment method includes the Band Edge Requirement.)
- (3) Radiated emissions measured in frequency range above 1000MHz were made with an instrument using Peak detector mode and AV detector mode of the emission .
- (4) Data of measurement within this frequency range shown “ * ” in the table above means the reading of emissions are attenuated more than 20dB below the permissible limits or the field strength is too small to be measured.
- (5) A preamp and high pass filter were used for this test in order to provide sufficient measurement sensitivity.
- (6) EUT Orthogonal Axis :
 “X” - denotes Laid on Table ; “Y” - denotes Vertical Stand ; “Z” - denotes Side Stand
- (7) During the measurements above 1 GHz it is taken care of that the EUT is always within the 3 dB cone of radiation BW of the used antenna

TX CH78 (Above 1000 MHz, Vertical)

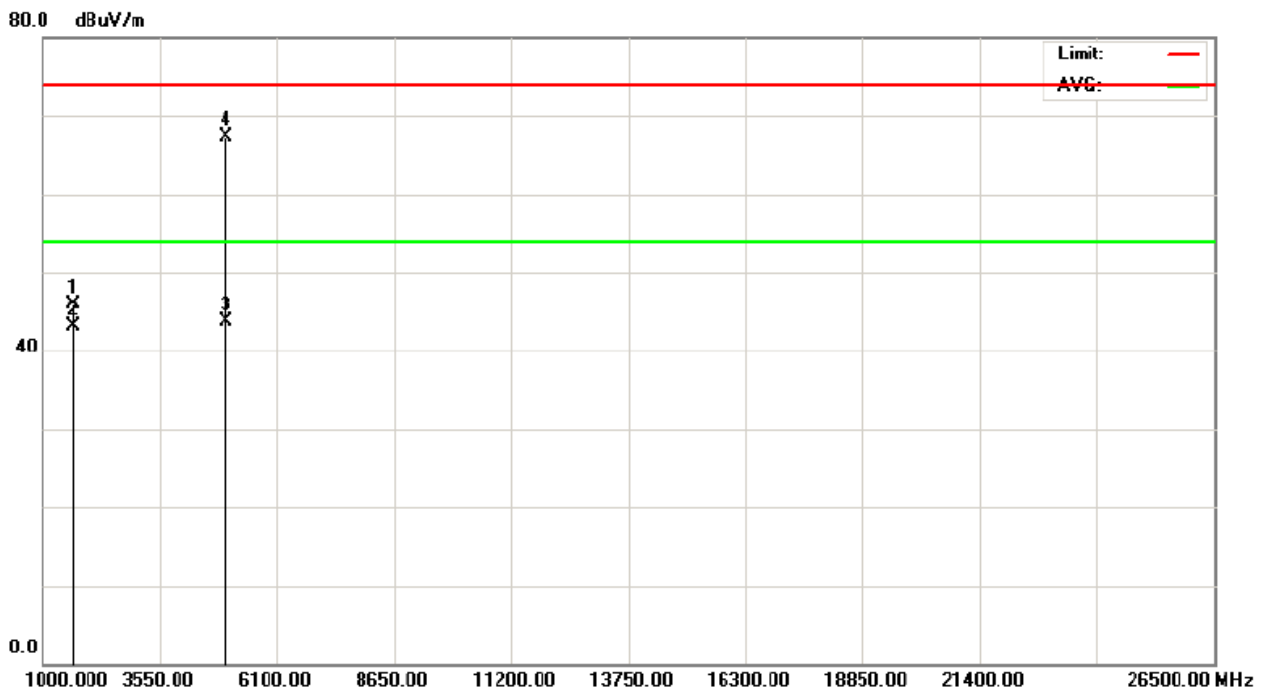
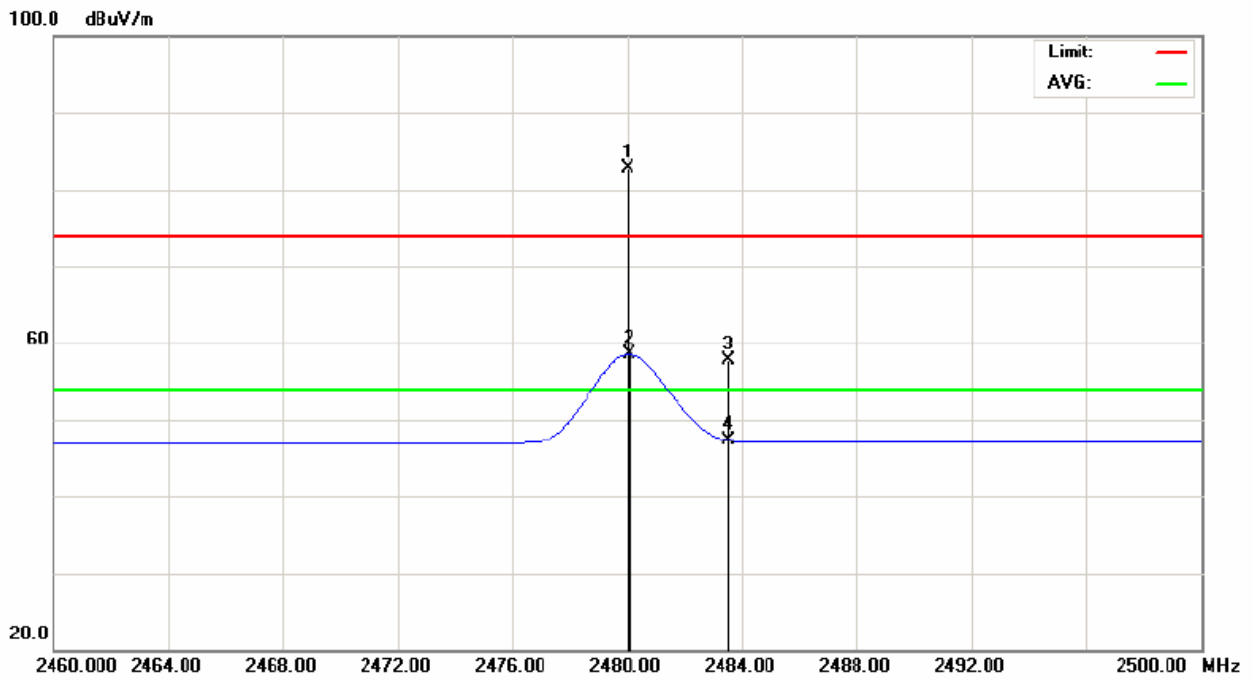

EUT :	Bluetooth Headset	Model Name :	SK-BTH-015A
Temperature :	30 °C	Relative Humidity :	63%
Pressure :	1010 hPa	Test Voltage :	Li-ion Battery 3.7Vdc
Test Mode :	TX 2480MHz –CH78-1Mbps		

Freq. (MHz)	Ant.Pol. H/V	Reading		Ant./CF CF(dB)	Act.		Limit		Note
		Peak (dBuV)	AV (dBuV)		Peak (dBuV/m)	AV (dBuV/m)	Peak (dBuV/m)	AV (dBuV/m)	
2479.92	H	59.71	29.51	32.34	92.05	61.85			X/F
2483.50	H	24.96	16.39	32.34	57.30	48.73	74.00	54.00	X/E
1654.02	H	57.58	53.08	-6.21	51.37	46.87	74.00	54.00	X/H
4960.04	H	62.95	38.22	3.98	66.93	42.20	74.00	54.00	X/H

Remark :

- (1) All readings are Peak unless otherwise stated QP in column of 『Note』 . Peak denotes that the Peak reading compliance with the QP Limits and then QP Mode measurement didn't perform .
- (2) Measuring frequency range from 30MHz to 1000MHz or the 10th harmonic of highest fundamental frequency . "F" denotes fundamental frequency; "H" denotes spurious frequency. "E" denotes band edge frequency. (This judgment method includes the Band Edge Requirement.)
- (3) Radiated emissions measured in frequency range above 1000MHz were made with an instrument using Peak detector mode and AV detector mode of the emission .
- (4) Data of measurement within this frequency range shown " * " in the table above means the reading of emissions are attenuated more than 20dB below the permissible limits or the field strength is too small to be measured.
- (5) A preamp and high pass filter were used for this test in order to provide sufficient measurement sensitivity.
- (6) EUT Orthogonal Axis :
 "X" - denotes Laid on Table ; "Y" - denotes Vertical Stand ; "Z" - denotes Side Stand
- (7) During the measurements above 1 GHz it is taken care of that the EUT is always within the 3 dB cone of radiation BW of the used antenna

TX CH78 (Above 1000 MHz, Horizontal)

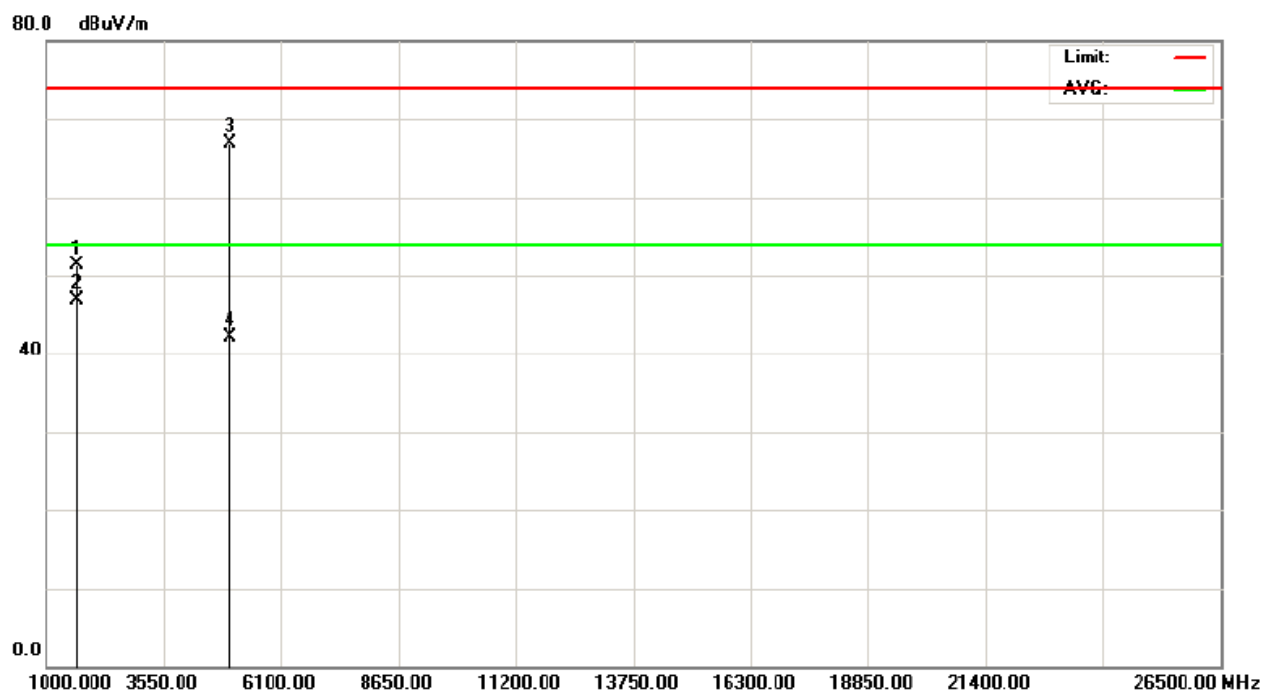
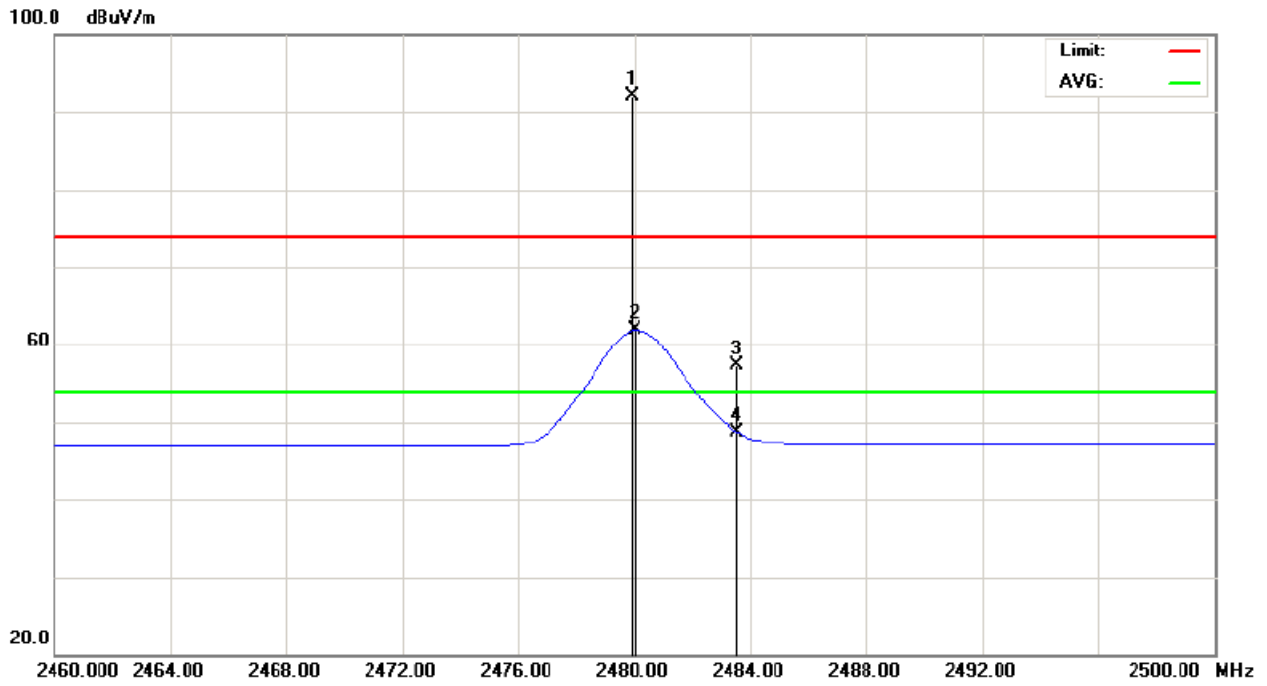

EUT :	Bluetooth Headset	Model Name :	SK-BTH-015A
Temperature :	30 °C	Relative Humidity :	63%
Pressure :	1010 hPa	Test Voltage :	Li-ion Battery 3.7Vdc
Test Mode :	TX 2402MHz – CH 00-3Mbps		

Freq. (MHz)	Ant.Pol. H/V	Reading		Ant./CF CF(dB)	Act.		Limit		Note
		Peak (dBuV)	AV (dBuV)		Peak (dBuV/m)	AV (dBuV/m)	Peak (dBuV/m)	AV (dBuV/m)	
2390.00	V	26.00	14.23	32.05	58.05	46.28	74.00	54.00	X/E
2402.00	V	46.01	24.12	32.08	78.09	56.20			X/F
1601.99	V	47.93	43.46	-6.51	41.42	36.95	74.00	54.00	X/H
4803.88	V	57.32	36.24	3.51	60.83	39.75	74.00	54.00	X/H

Remark :

- (1) All readings are Peak unless otherwise stated QP in column of 『Note』 . Peak denotes that the Peak reading compliance with the QP Limits and then QP Mode measurement didn't perform .
- (2) Measuring frequency range from 30MHz to 1000MHz or the 10th harmonic of highest fundamental frequency . "F" denotes fundamental frequency; "H" denotes spurious frequency. "E" denotes band edge frequency. (This judgment method includes the Band Edge Requirement.)
- (3) Radiated emissions measured in frequency range above 1000MHz were made with an instrument using Peak detector mode and AV detector mode of the emission .
- (4) Data of measurement within this frequency range shown " * " in the table above means the reading of emissions are attenuated more than 20dB below the permissible limits or the field strength is too small to be measured.
- (5) A preamp and high pass filter were used for this test in order to provide sufficient measurement sensitivity.
- (6) EUT Orthogonal Axis :
 "X" - denotes Laid on Table ; "Y" - denotes Vertical Stand ; "Z" - denotes Side Stand
- (7) During the measurements above 1 GHz it is taken care of that the EUT is always within the 3 dB cone of radiation BW of the used antenna

TX CH00(Above 1000 MHz, Vertical)

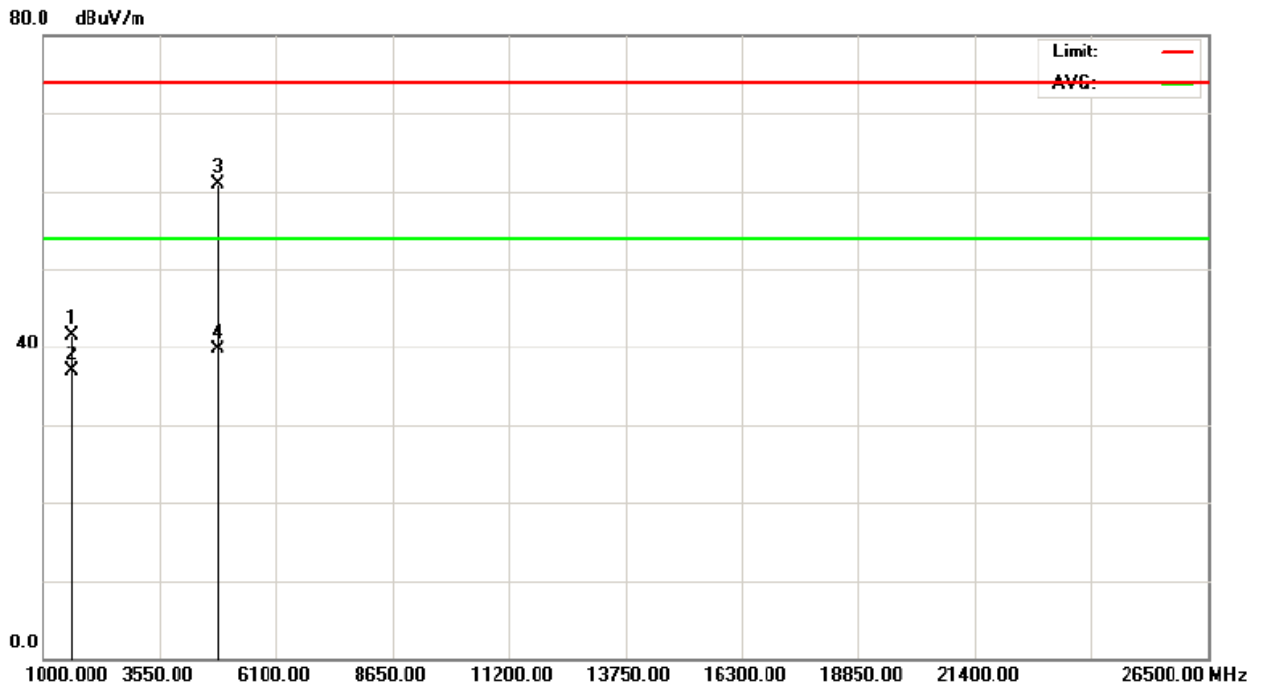
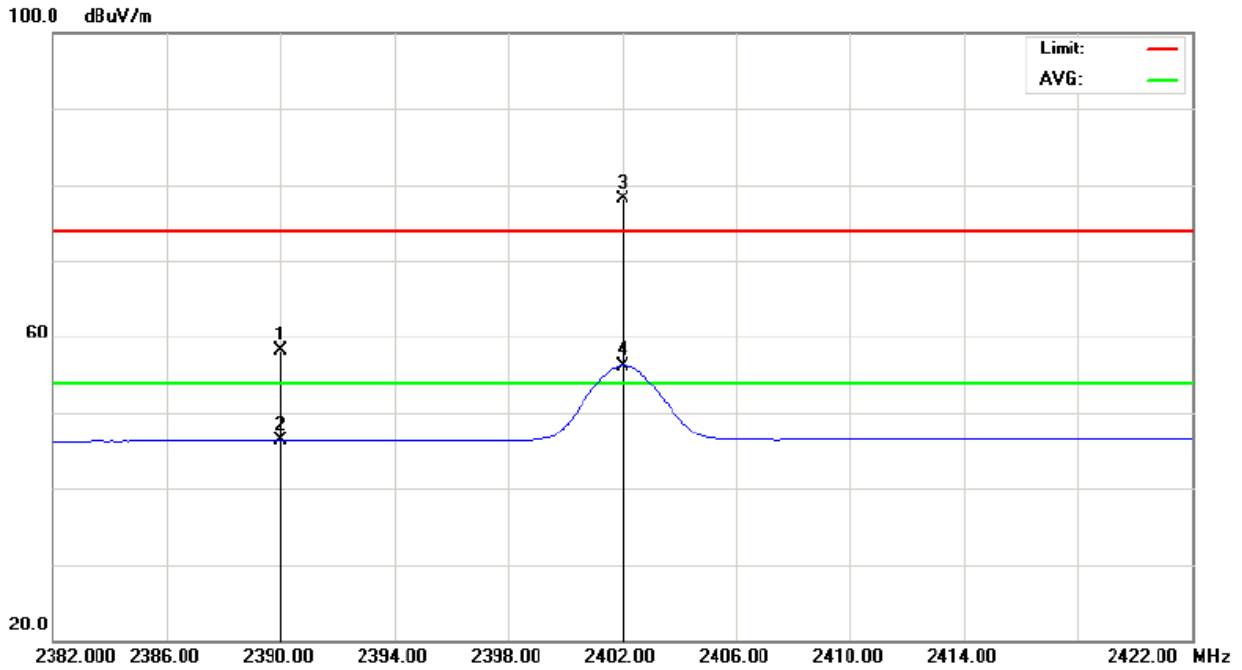

EUT :	Bluetooth Headset	Model Name :	SK-BTH-015A
Temperature :	30 °C	Relative Humidity :	63%
Pressure :	1010hPa	Test Voltage :	Li-ion Battery 3.7Vdc
Test Mode :	TX 2402MHz – CH 00-3Mbps		

Freq. (MHz)	Ant.Pol. H/V	Reading		Ant./CF CF(dB)	Act.		Limit		Note
		Peak (dBuV)	AV (dBuV)		Peak (dBuV/m)	AV (dBuV/m)	Peak (dBuV/m)	AV (dBuV/m)	
2390.00	H	25.88	14.25	32.05	57.93	46.30	74.00	54.00	X/E
2402.00	H	57.26	28.16	32.08	89.34	60.24			X/F
1601.99	H	53.74	49.65	-6.51	47.23	43.14	74.00	54.00	X/H
4804.08	H	58.88	36.93	3.51	62.39	40.44	74.00	54.00	X/H

Remark :

- (1) All readings are Peak unless otherwise stated QP in column of 『Note』 . Peak denotes that the Peak reading compliance with the QP Limits and then QP Mode measurement didn't perform .
- (2) Measuring frequency range from 30MHz to 1000MHz or the 10th harmonic of highest fundamental frequency .“F” denotes fundamental frequency; “H” denotes spurious frequency. “E” denotes band edge frequency. (This judgment method includes the Band Edge Requirement.)
- (3) Radiated emissions measured in frequency range above 1000MHz were made with an instrument using Peak detector mode and AV detector mode of the emission .
- (4) Data of measurement within this frequency range shown “ * ” in the table above means the reading of emissions are attenuated more than 20dB below the permissible limits or the field strength is too small to be measured.
- (5) A preamp and high pass filter were used for this test in order to provide sufficient measurement sensitivity.
- (6) EUT Orthogonal Axis :
“X” - denotes Laid on Table ; “Y” - denotes Vertical Stand ; “Z” - denotes Side Stand
- (7) During the measurements above 1 GHz it is taken care of that the EUT is always within the 3 dB cone of radiation BW of the used antenna

TX CH00(Above 1000 MHz, Horizontal)

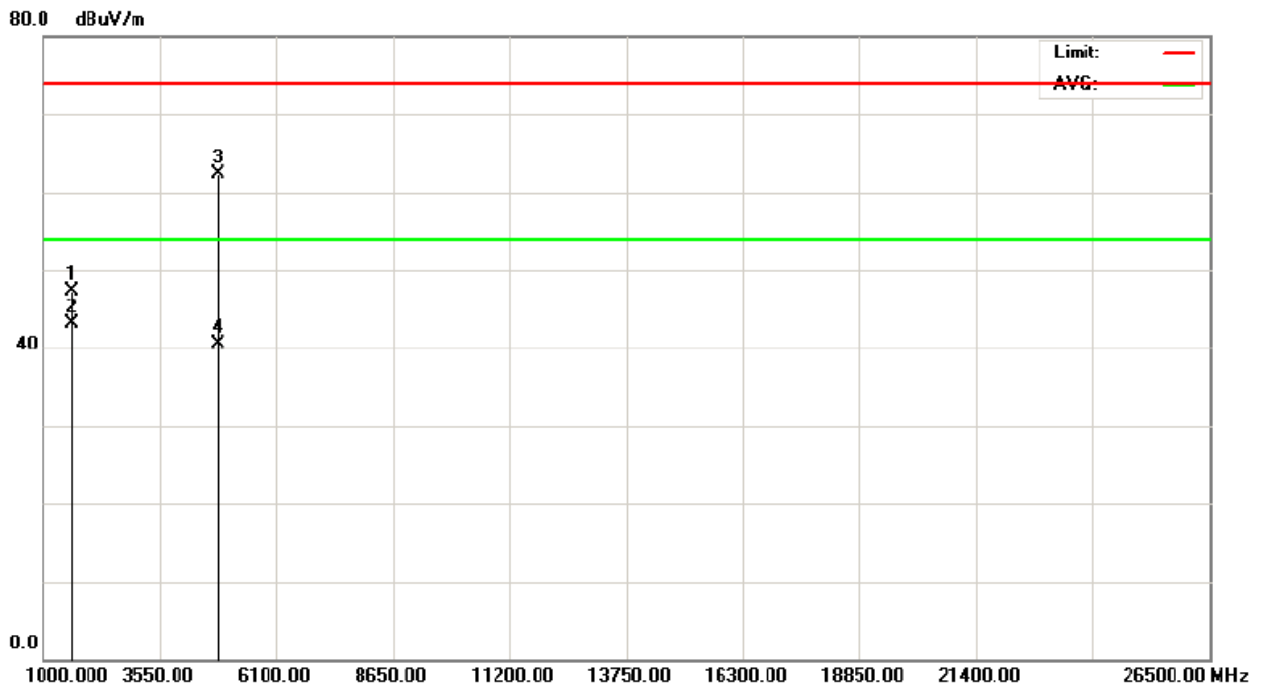
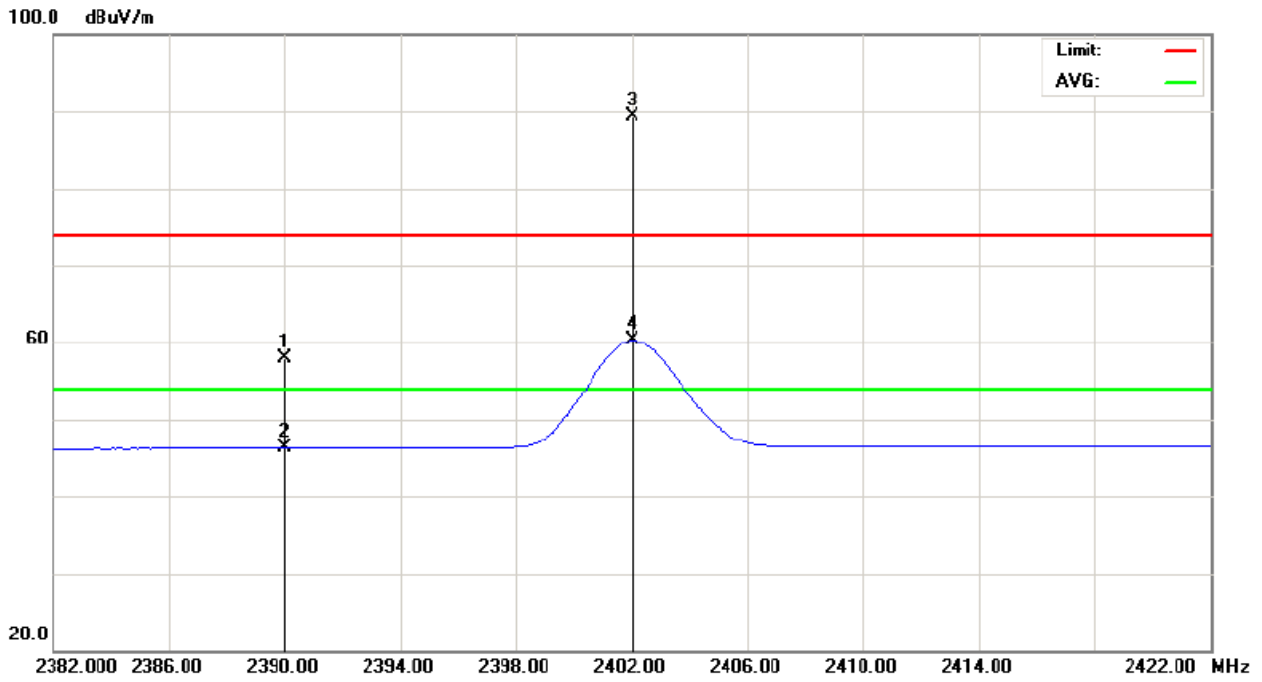

EUT :	Bluetooth Headset	Model Name :	SK-BTH-015A
Temperature :	30 °C	Relative Humidity :	63%
Pressure :	1010 hPa	Test Voltage :	Li-ion Battery 3.7Vdc
Test Mode :	TX 2441MHz –CH39-3Mbps		

Freq.	Ant.Pol.	Reading		Ant./CF	Act.		Limit		Note
		Peak	AV		Peak	AV	Peak	AV	
(MHz)	H/V	(dBuV)	(dBuV)	CF(dB)	(dBuV/m)	(dBuV/m)	(dBuV/m)	(dBuV/m)	
2441.00	V	45.35	24.00	32.21	77.56	56.21			X/F
1628.00	V	48.05	44.23	6.36	41.69	37.87	74.00	54.00	X/H
4881.96	V	56.92	35.01	3.75	60.67	38.85	74.00	54.00	X/H

Remark :

- (1) All readings are Peak unless otherwise stated QP in column of 『Note』 . Peak denotes that the Peak reading compliance with the QP Limits and then QP Mode measurement didn't perform .
- (2) Measuring frequency range from 30MHz to 1000MHz or the 10th harmonic of highest fundamental frequency .“F” denotes fundamental frequency; “H” denotes spurious frequency. “E” denotes band edge frequency. (This judgment method includes the Band Edge Requirement.)
- (3) Radiated emissions measured in frequency range above 1000MHz were made with an instrument using Peak detector mode and AV detector mode of the emission .
- (4) Data of measurement within this frequency range shown “ * ” in the table above means the reading of emissions are attenuated more than 20dB below the permissible limits or the field strength is too small to be measured.
- (5) A preamp and high pass filter were used for this test in order to provide sufficient measurement sensitivity.
- (6) EUT Orthogonal Axis :
 “X” - denotes Laid on Table ; “Y” - denotes Vertical Stand ; “Z” - denotes Side Stand
- (7) During the measurements above 1 GHz it is taken care of that the EUT is always within the 3 dB cone of radiation BW of the used antenna

TX CH39 (Above 1000 MHz, Vertical)

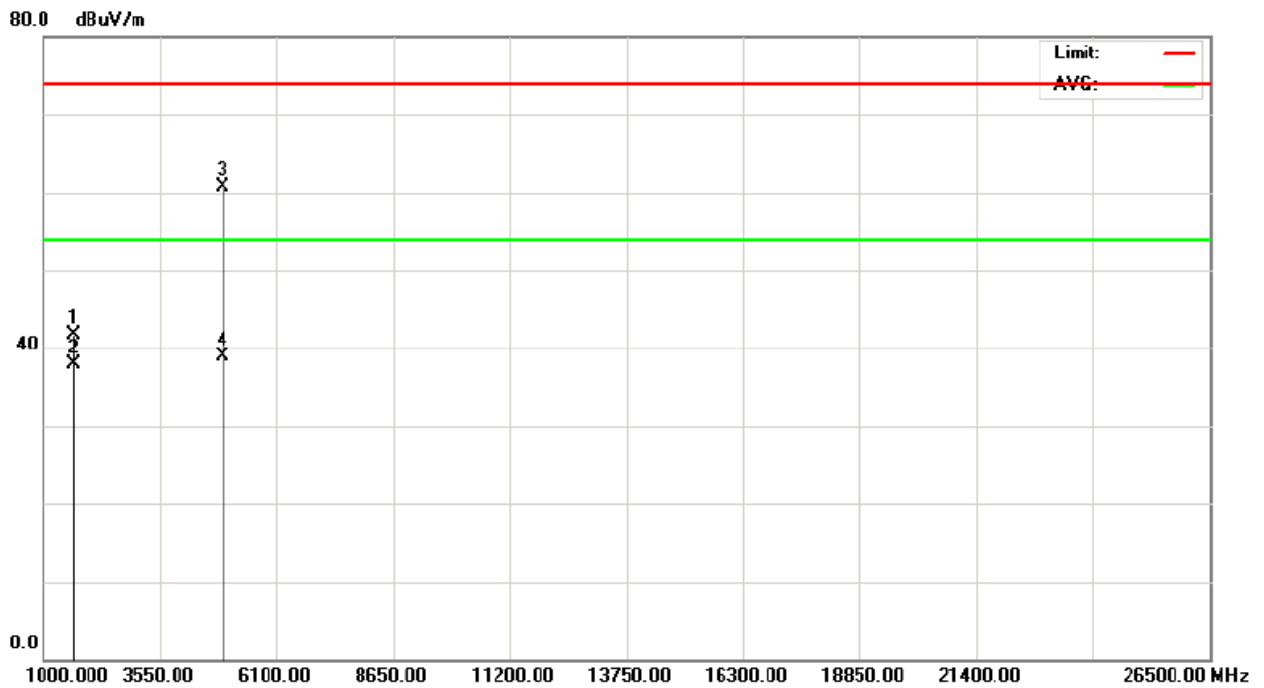
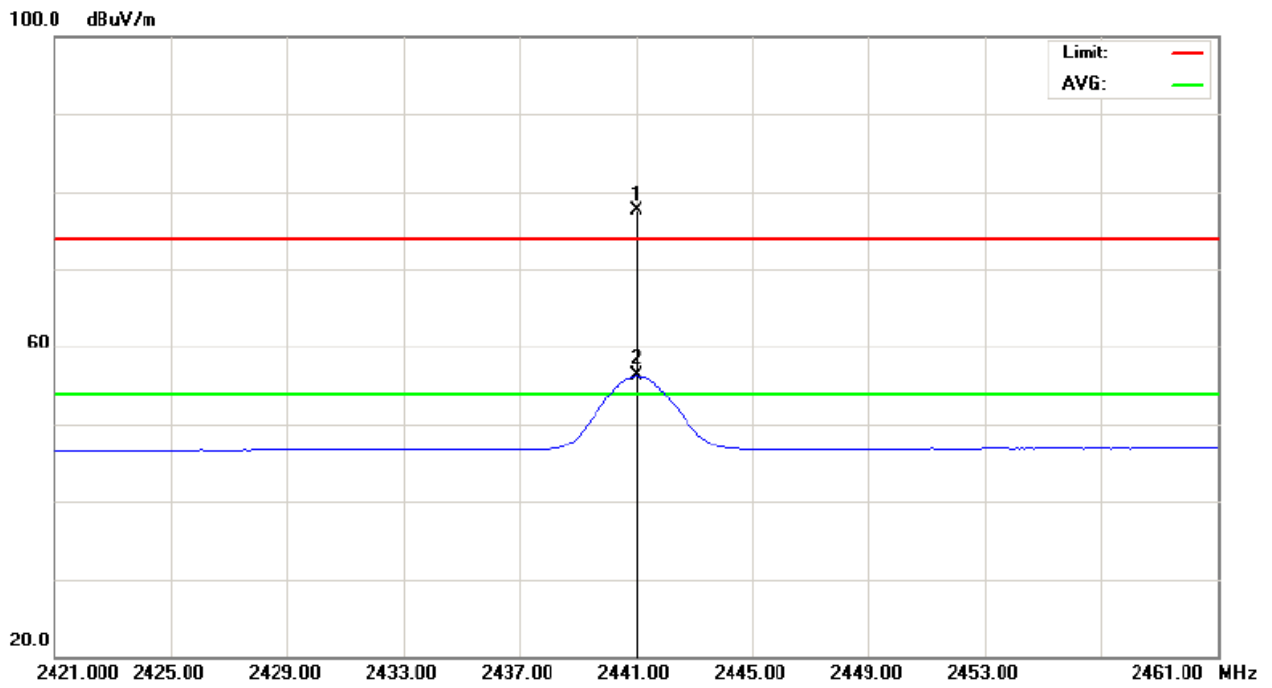

EUT :	Bluetooth Headset	Model Name :	SK-BTH-015A
Temperature :	30 °C	Relative Humidity :	63%
Pressure :	1010 hPa	Test Voltage :	Li-ion Battery 3.7Vdc
Test Mode :	TX 2441MHz –CH39-3Mbps		

Freq.	Ant.Pol.	Reading		Ant./CF	Act.		Limit		Note
		Peak	AV		Peak	AV	Peak	AV	
(MHz)	H/V	(dBuV)	(dBuV)	CF(dB)	(dBuV/m)	(dBuV/m)	(dBuV/m)	(dBuV/m)	
2441.08	H	56.63	28.09	32.21	88.84	60.30			X/F
1628.14	H	55.85	51.49	-6.36	49.49	45.13	74.00	54.00	X/H
4882.04	H	58.82	35.97	3.75	62.57	39.72	74.00	54.00	X/H

Remark :

- (1) All readings are Peak unless otherwise stated QP in column of 『 Note 』 . Peak denotes that the Peak reading compliance with the QP Limits and then QP Mode measurement didn't perform .
- (2) Measuring frequency range from 30MHz to 1000MHz or the 10th harmonic of highest fundamental frequency . "F" denotes fundamental frequency; "H" denotes spurious frequency. "E" denotes band edge frequency. (This judgment method includes the Band Edge Requirement.)
- (3) Radiated emissions measured in frequency range above 1000MHz were made with an instrument using Peak detector mode and AV detector mode of the emission .
- (4) Data of measurement within this frequency range shown " * " in the table above means the reading of emissions are attenuated more than 20dB below the permissible limits or the field strength is too small to be measured.
- (5) A preamp and high pass filter were used for this test in order to provide sufficient measurement sensitivity.
- (6) EUT Orthogonal Axis :
 "X" - denotes Laid on Table ; "Y" - denotes Vertical Stand ; "Z" - denotes Side Stand
- (7) During the measurements above 1 GHz it is taken care of that the EUT is always within the 3 dB cone of radiation BW of the used antenna

TX CH39 (Above 1000 MHz, Horizontal)

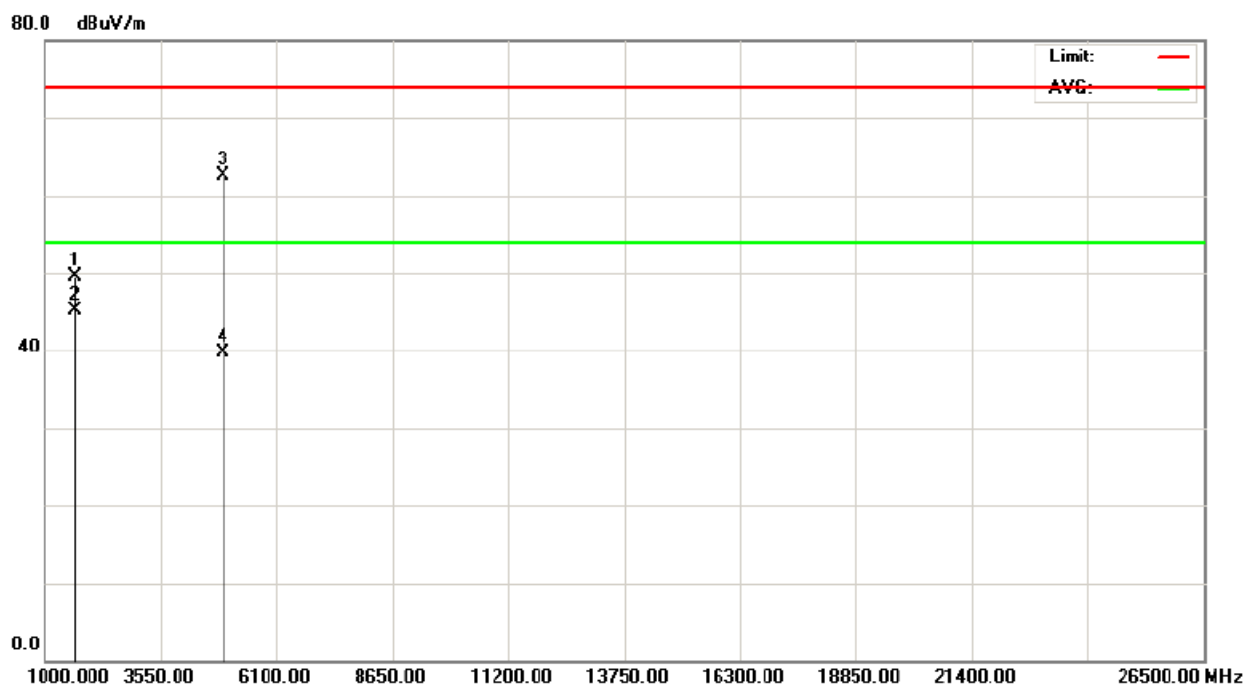
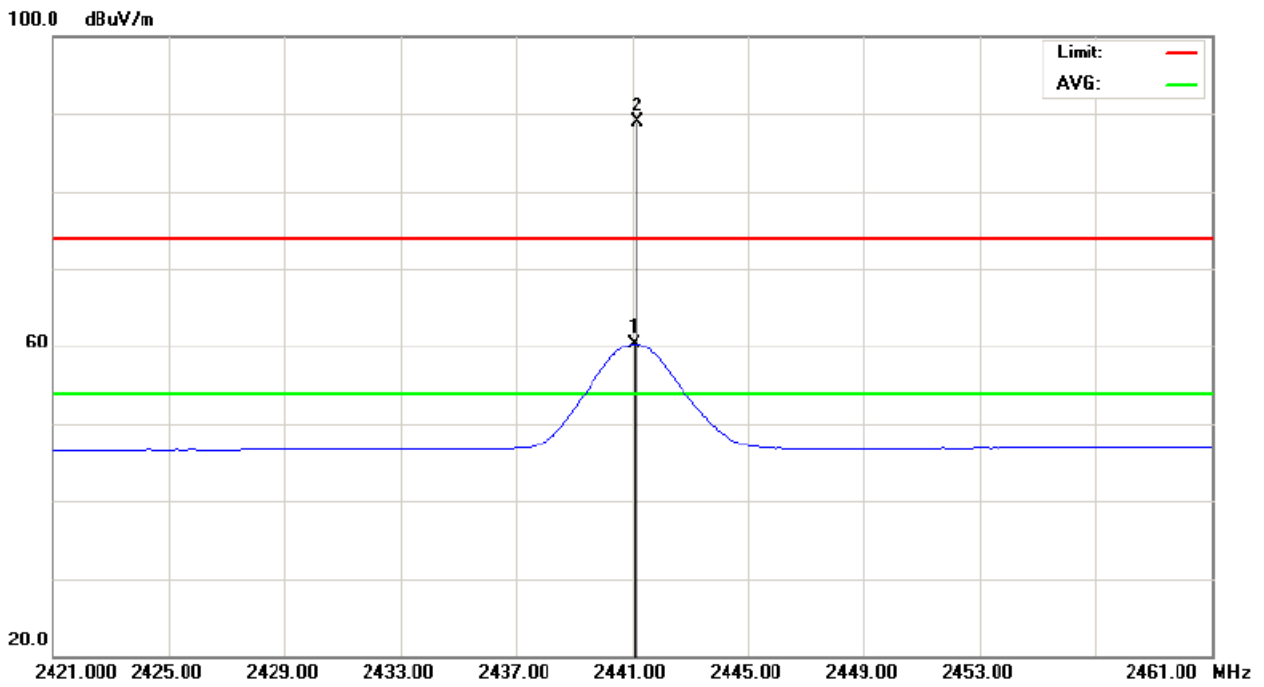

EUT :	Bluetooth Headset	Model Name :	SK-BTH-015A
Temperature :	30 °C	Relative Humidity :	63%
Pressure :	1010hPa	Test Voltage :	Li-ion Battery 3.7Vdc
Test Mode :	TX 2480MHz –CH78-3Mbps		

Freq.	Ant.Pol.	Reading		Ant./CF	Act.		Limit		Note
		Peak	AV		Peak	AV	Peak	AV	
(MHz)	H/V	(dBuV)	(dBuV)	CF(dB)	(dBuV/m)	(dBuV/m)	(dBuV/m)	(dBuV/m)	
2480.00	V	45.58	24.19	32.34	77.92	56.53			X/F
2483.50	V	25.74	14.82	32.34	58.08	47.16	74.00	54.00	X/E
1654.06	V	49.72	45.67	-6.21	43.51	39.46	74.00	54.00	X/H
4960.00	V	56.16	34.39	3.98	60.14	38.37	74.00	54.00	X/H

Remark :

- (1) All readings are Peak unless otherwise stated QP in column of 『Note』 . Peak denotes that the Peak reading compliance with the QP Limits and then QP Mode measurement didn't perform .
- (2) Measuring frequency range from 30MHz to 1000MHz or the 10th harmonic of highest fundamental frequency .“F” denotes fundamental frequency; “H” denotes spurious frequency. “E” denotes band edge frequency. (This judgment method includes the Band Edge Requirement.)
- (3) Radiated emissions measured in frequency range above 1000MHz were made with an instrument using Peak detector mode and AV detector mode of the emission .
- (4) Data of measurement within this frequency range shown “ * ” in the table above means the reading of emissions are attenuated more than 20dB below the permissible limits or the field strength is too small to be measured.
- (5) A preamp and high pass filter were used for this test in order to provide sufficient measurement sensitivity.
- (6) EUT Orthogonal Axis :
 “X” - denotes Laid on Table ; “Y” - denotes Vertical Stand ; “Z” - denotes Side Stand
- (7) During the measurements above 1 GHz it is taken care of that the EUT is always within the 3 dB cone of radiation BW of the used antenna

TX CH78 (Above 1000 MHz, Vertical)

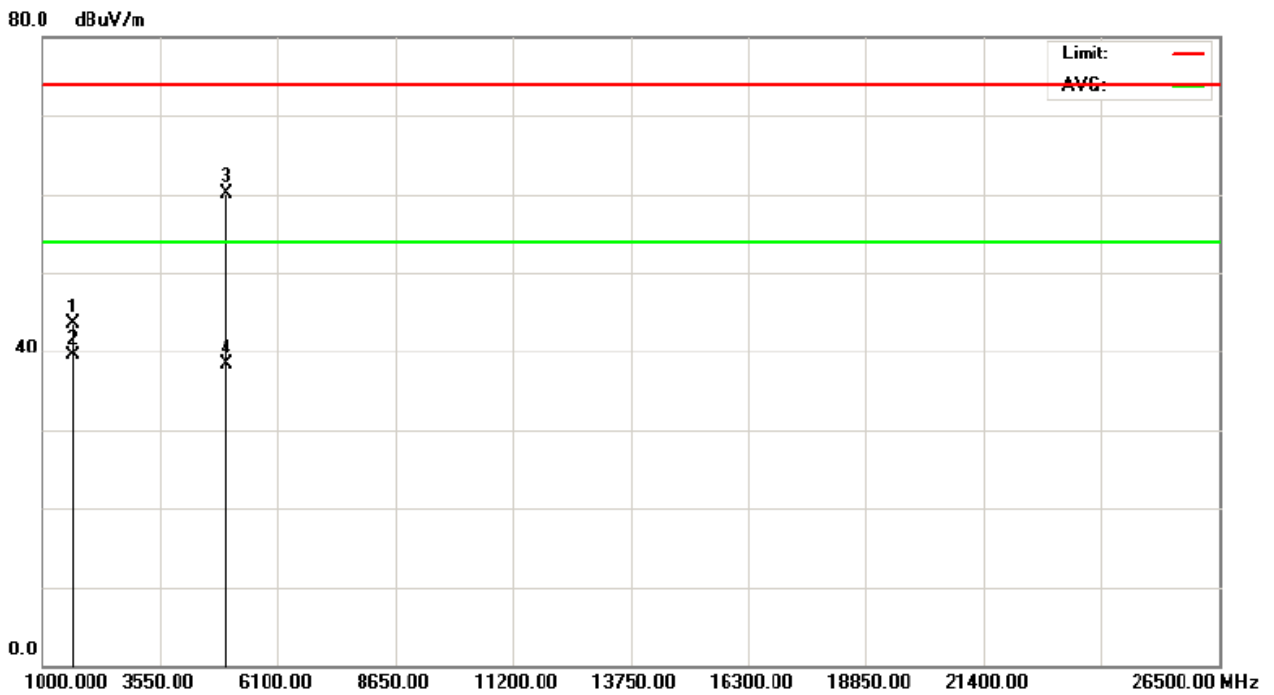
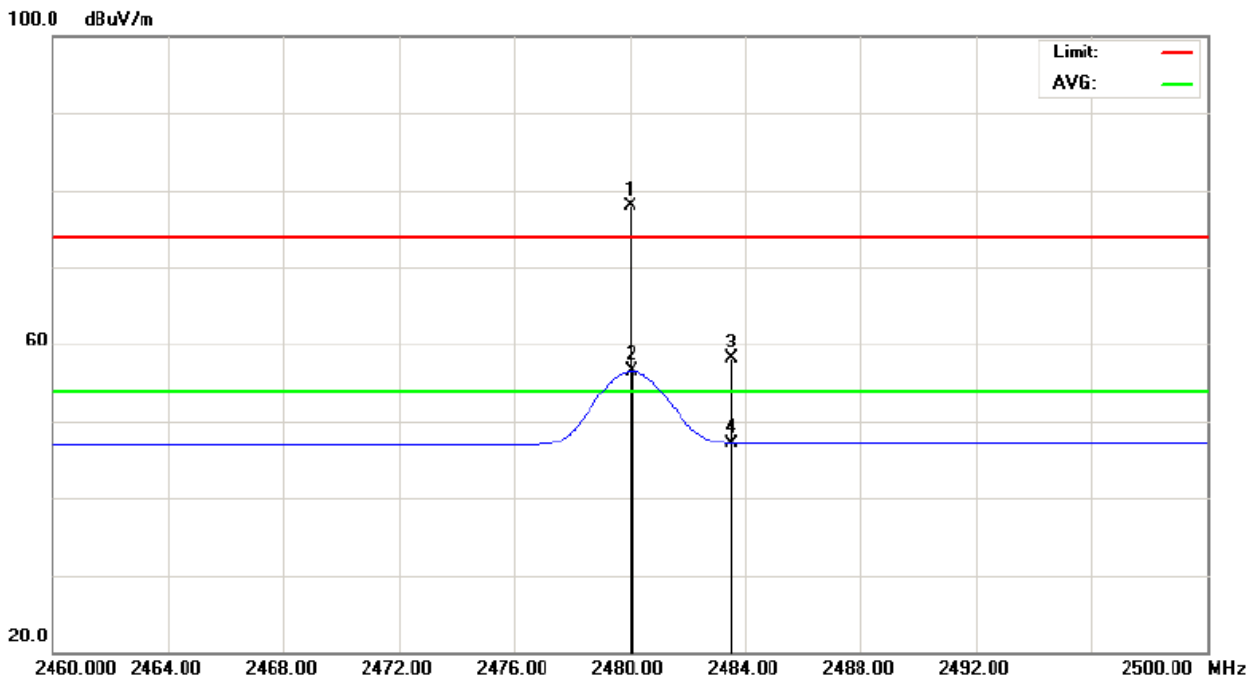

EUT :	Bluetooth Headset	Model Name :	SK-BTH-015A
Temperature :	30 °C	Relative Humidity :	63%
Pressure :	1010 hPa	Test Voltage :	Li-ion Battery 3.7Vdc
Test Mode :	TX 2480MHz –CH78-3Mbps		

Freq. (MHz)	Ant.Pol. H/V	Reading		Ant./CF CF(dB)	Act.		Limit		Note
		Peak (dBuV)	AV (dBuV)		Peak (dBuV/m)	AV (dBuV/m)	Peak (dBuV/m)	AV (dBuV/m)	
2480.08	H	55.86	27.90	32.34	88.20	60.24			X/F
2483.50	H	25.68	15.55	32.34	58.02	47.89	74.00	54.00	X/E
1654.02	H	56.07	52.82	-6.21	49.86	46.61	74.00	54.00	X/H
4960.00	H	60.20	35.98	3.98	64.18	39.96	74.00	54.00	X/H

Remark :

- (1) All readings are Peak unless otherwise stated QP in column of 『Note』 . Peak denotes that the Peak reading compliance with the QP Limits and then QP Mode measurement didn't perform .
- (2) Measuring frequency range from 30MHz to 1000MHz or the 10th harmonic of highest fundamental frequency . "F" denotes fundamental frequency; "H" denotes spurious frequency. "E" denotes band edge frequency. (This judgment method includes the Band Edge Requirement.)
- (3) Radiated emissions measured in frequency range above 1000MHz were made with an instrument using Peak detector mode and AV detector mode of the emission .
- (4) Data of measurement within this frequency range shown " * " in the table above means the reading of emissions are attenuated more than 20dB below the permissible limits or the field strength is too small to be measured.
- (5) A preamp and high pass filter were used for this test in order to provide sufficient measurement sensitivity.
- (6) EUT Orthogonal Axis :
 "X" - denotes Laid on Table ; "Y" - denotes Vertical Stand ; "Z" - denotes Side Stand
- (7) During the measurements above 1 GHz it is taken care of that the EUT is always within the 3 dB cone of radiation BW of the used antenna

TX CH78 (Above 1000 MHz, Horizontal)

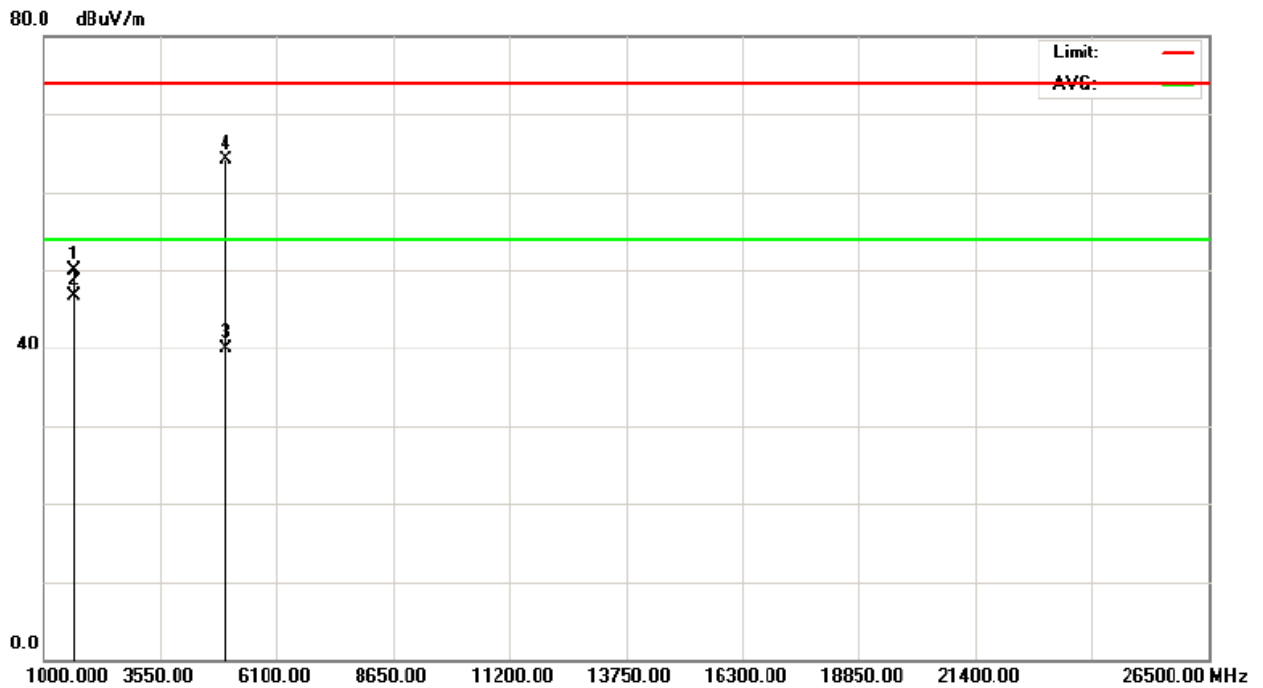
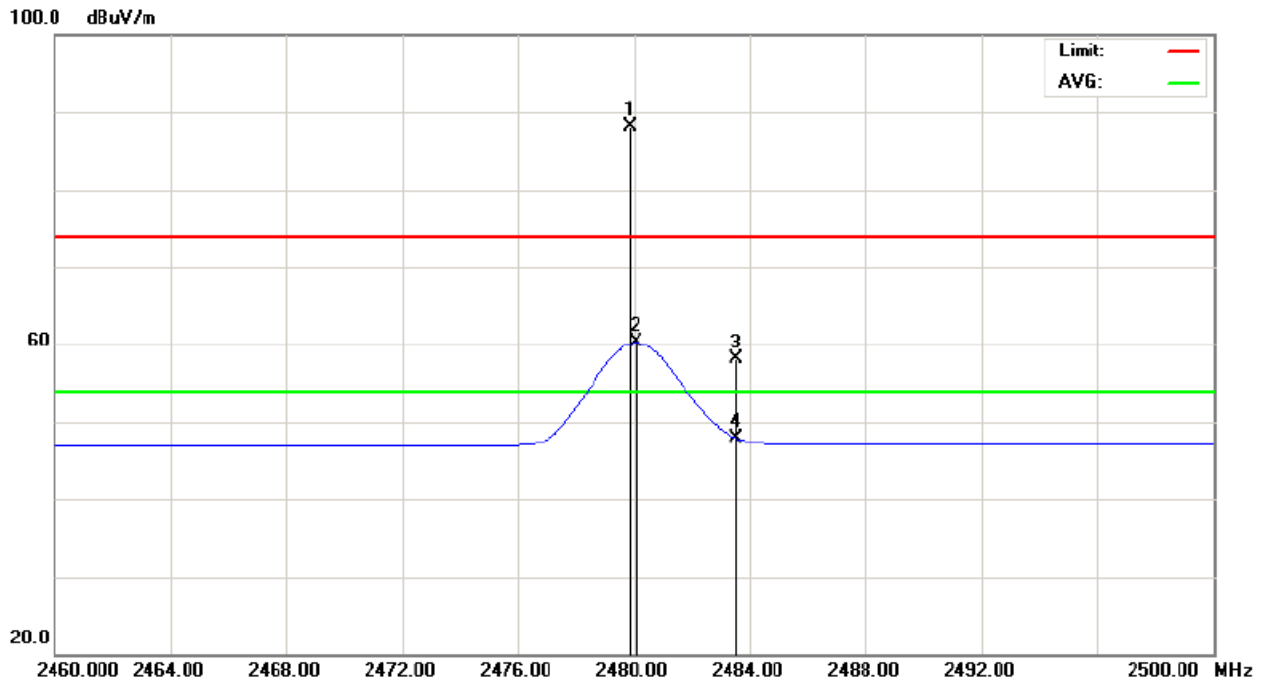

4.2.9 TEST RESULTS (RESTRICTED BANDS REQUIREMENTS)

EUT :	Bluetooth Headset	Model Name :	SK-BTH-015A
Temperature :	30 °C	Relative Humidity :	63%
Pressure :	1010 hPa	Test Voltage :	Li-ion Battery 3.7Vdc
Test Mode :	TX 2402MHz/2480MHz -1Mbps		
Note :	1. The transmitter was setup to transmit at the lowest channel (CH00). Then the field strength was measured at 2310-2390 MHz. 2. The transmitter was setup to transmit at the highest channel (CH78). Then the field strength was measured at 2483.5-2500 MHz.		

Freq. (MHz)	Ant.Pol. H/V	Reading		Ant./CF CF(dB)	Act.		Limit		Note
		Peak (dBuV)	AV (dBuV)		Peak (dBuV/m)	AV (dBuV/m)	Peak (dBuV/m)	AV (dBuV/m)	
2390.00	V	25.08	14.19	32.05	57.13	46.24	74.00	54.00	CH00
2483.50	V	25.46	14.96	32.34	57.80	47.30	74.00	54.00	CH78

Remark :

- (1) Radiated emissions measured in frequency range above 1000MHz were made with an instrument using Peak detector mode and AV detector mode of the emission .
- (2) EUT Orthogonal Axis :
 "X" - denotes Laid on Table ; "Y" - denotes Vertical Stand ; "Z" - denotes Side Stand
- (3) During the measurements above 1 GHz it is taken care of that the EUT is always within the 3 dB cone of radiation BW of the used antenna

Restricted Bands Requirements, Vertical
CH00

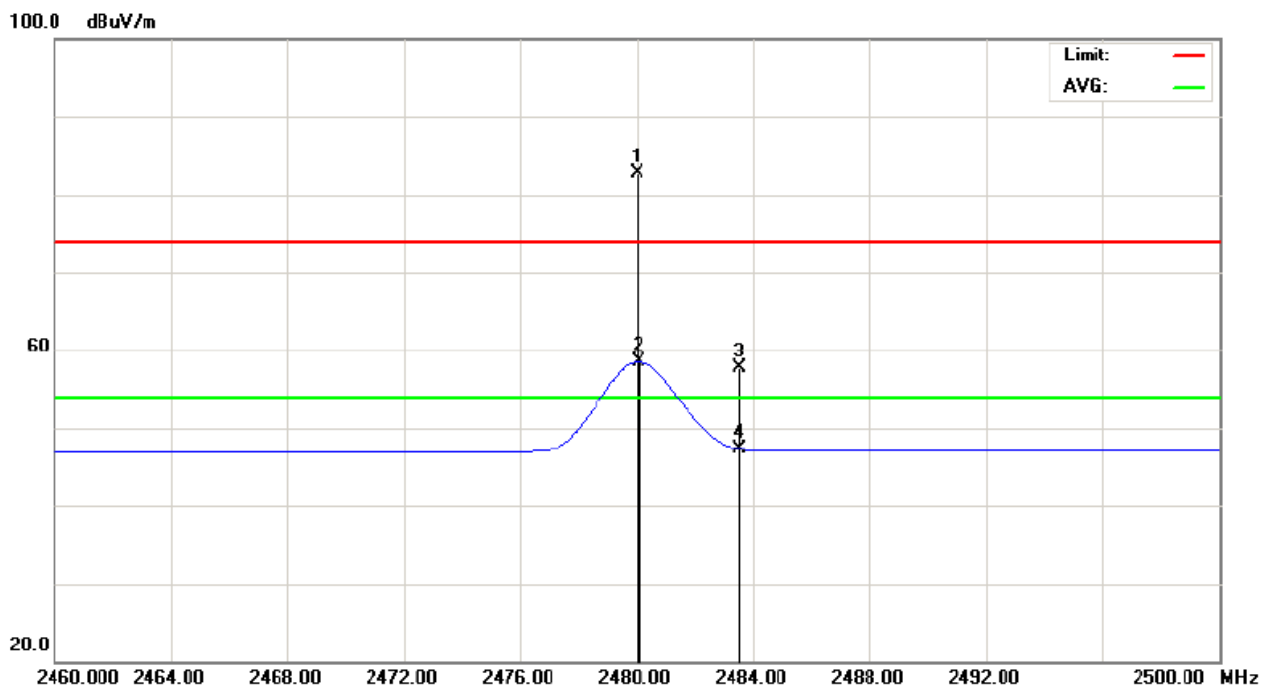
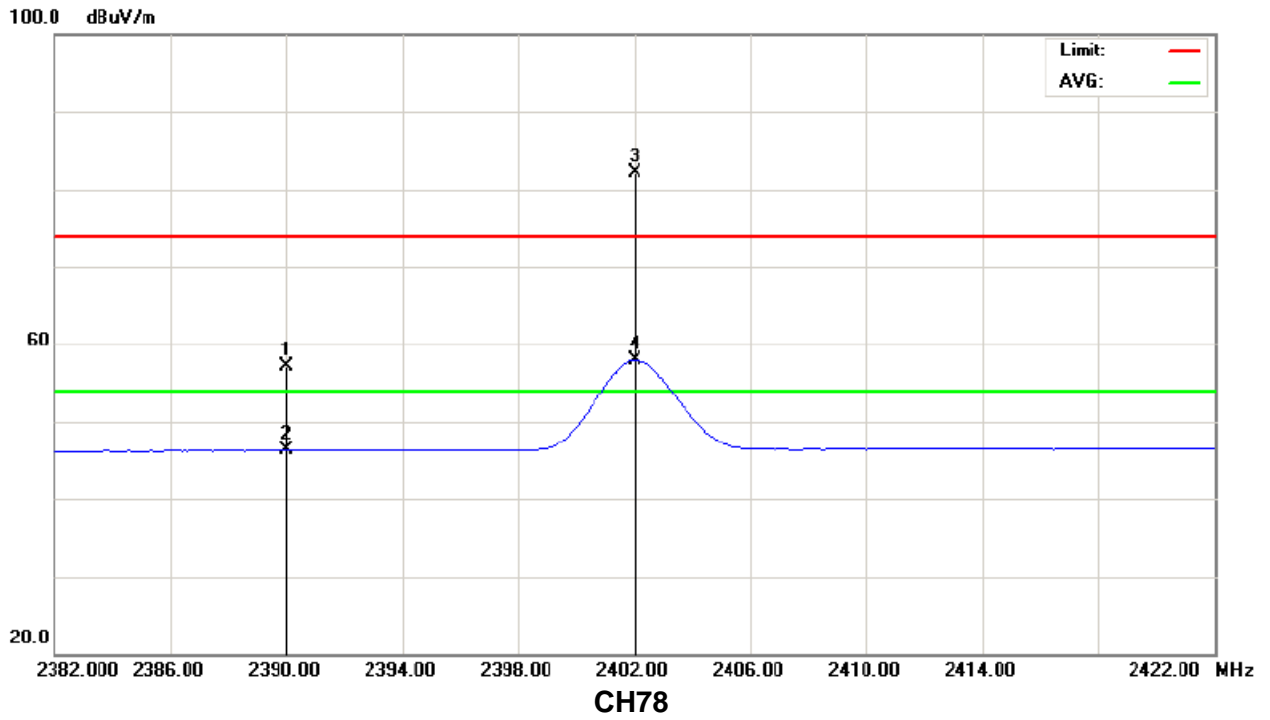

EUT :	Bluetooth Headset	Model Name :	SK-BTH-015A
Temperature :	30 °C	Relative Humidity :	63%
Pressure :	1010 hPa	Test Voltage :	Li-ion Battery 3.7Vdc
Test Mode :	TX 2402MHz/2480MHz -1Mbps		
Note :	1. The transmitter was setup to transmit at the lowest channel (CH00). Then the field strength was measured at 2310-2390 MHz. 2. The transmitter was setup to transmit at the highest channel (CH78). Then the field strength was measured at 2483.5-2500 MHz.		

Freq.	Ant.Pol.	Reading		Ant./CF	Act.		Limit		Note
		Peak	AV		Peak	AV	Peak	AV	
(MHz)	H/V	(dBuV)	(dBuV)	CF(dB)	(dBuV/m)	(dBuV/m)	(dBuV/m)	(dBuV/m)	
2390.00	H	25.55	14.19	32.05	57.60	46.24	74.00	54.00	CH00
2483.50	H	24.96	16.39	32.34	57.30	48.73	74.00	54.00	CH78

Remark :

- (1) Radiated emissions measured in frequency range above 1000MHz were made with an instrument using Peak detector mode and AV detector mode of the emission .
- (2) EUT Orthogonal Axis :
 "X" - denotes Laid on Table ; "Y" - denotes Vertical Stand ; "Z" - denotes Side Stand
- (3) During the measurements above 1 GHz it is taken care of that the EUT is always within the 3 dB cone of radiation BW of the used antenna

Restricted Bands Requirements, Horizontal
CH00

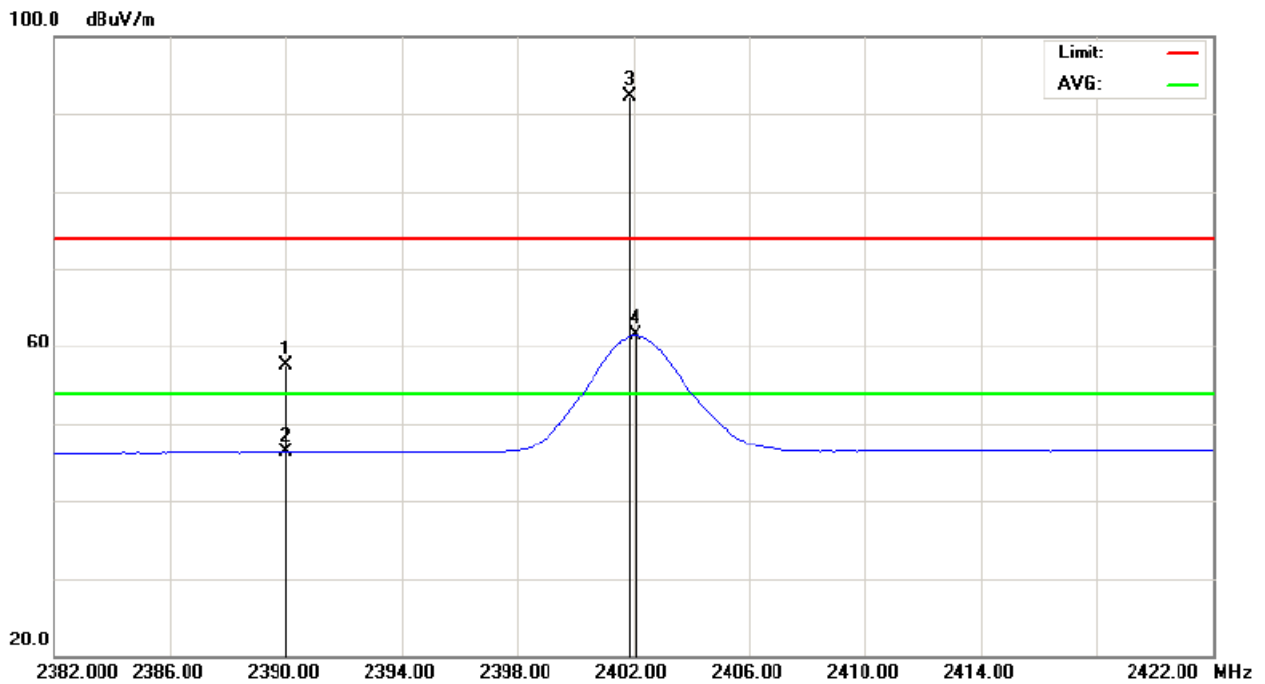

CH78

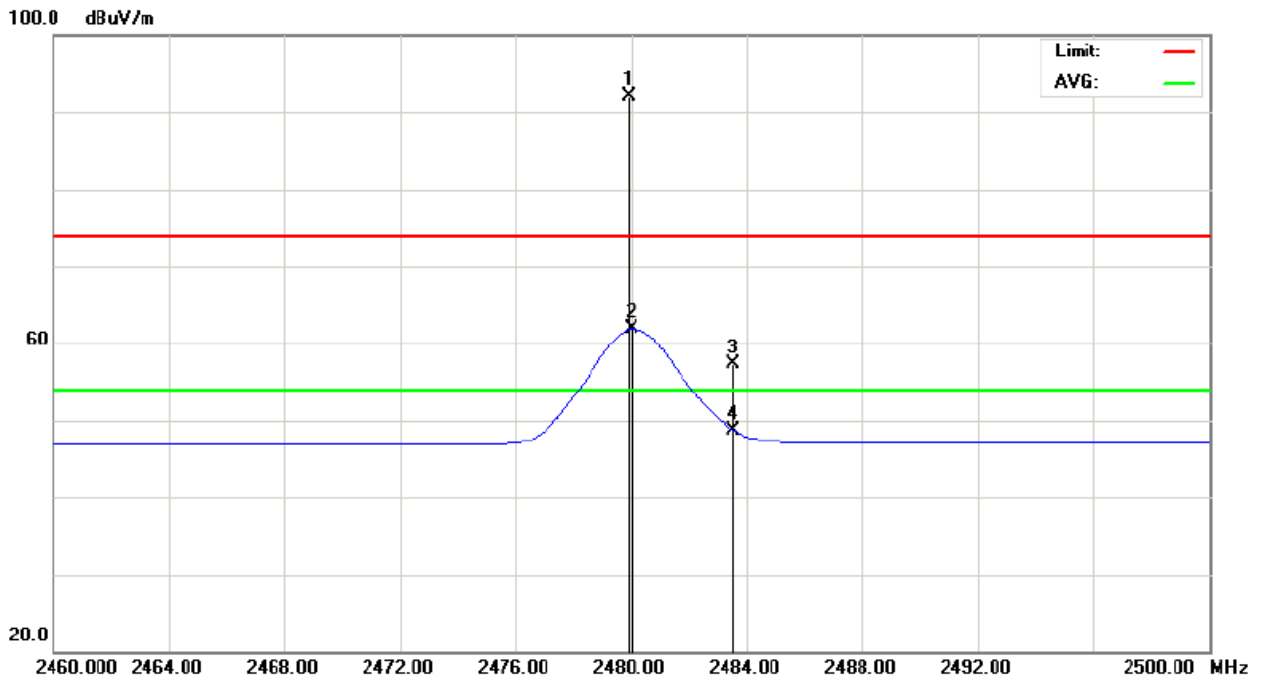

EUT :	Bluetooth Headset	Model Name :	SK-BTH-015A
Temperature :	30 °C	Relative Humidity :	63%
Pressure :	1010 hPa	Test Voltage :	Li-ion Battery 3.7Vdc
Test Mode :	TX 2402MHz/2480MHz -3Mbps		
Note :	1. The transmitter was setup to transmit at the lowest channel (CH00). Then the field strength was measured at 2310-2390 MHz. 2. The transmitter was setup to transmit at the highest channel (CH78). Then the field strength was measured at 2483.5-2500 MHz.		

Freq. (MHz)	Ant.Pol. H/V	Reading		Ant./CF CF(dB)	Act.		Limit		Note
		Peak (dBuV)	AV (dBuV)		Peak (dBuV/m)	AV (dBuV/m)	Peak (dBuV/m)	AV (dBuV/m)	
2390.00	V	26.00	14.23	32.05	58.05	46.28	74.00	54.00	CH00
2483.50	V	25.74	14.82	32.34	58.08	47.16	74.00	54.00	CH78

Remark :

- (1) Radiated emissions measured in frequency range above 1000MHz were made with an instrument using Peak detector mode and AV detector mode of the emission .
- (2) EUT Orthogonal Axis :
 "X" - denotes Laid on Table ; "Y" - denotes Vertical Stand ; "Z" - denotes Side Stand
- (3) During the measurements above 1 GHz it is taken care of that the EUT is always within the 3 dB cone of radiation BW of the used antenna

Restricted Bands Requirements, Vertical
CH00

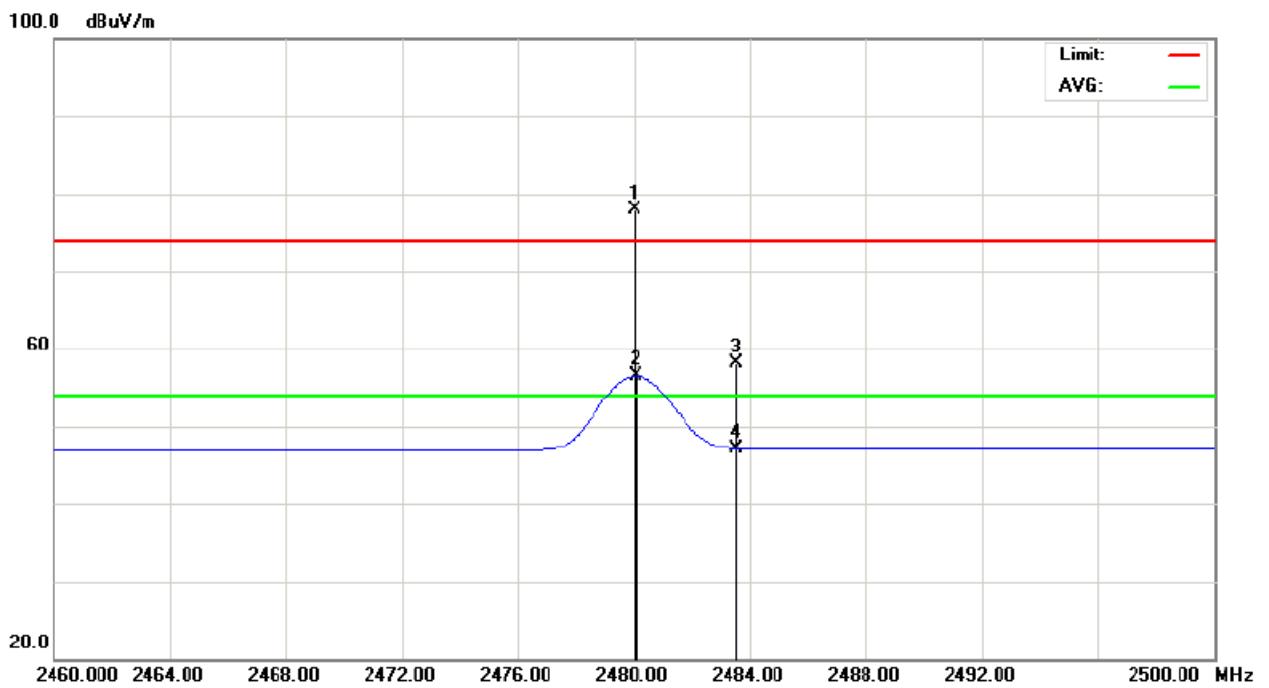
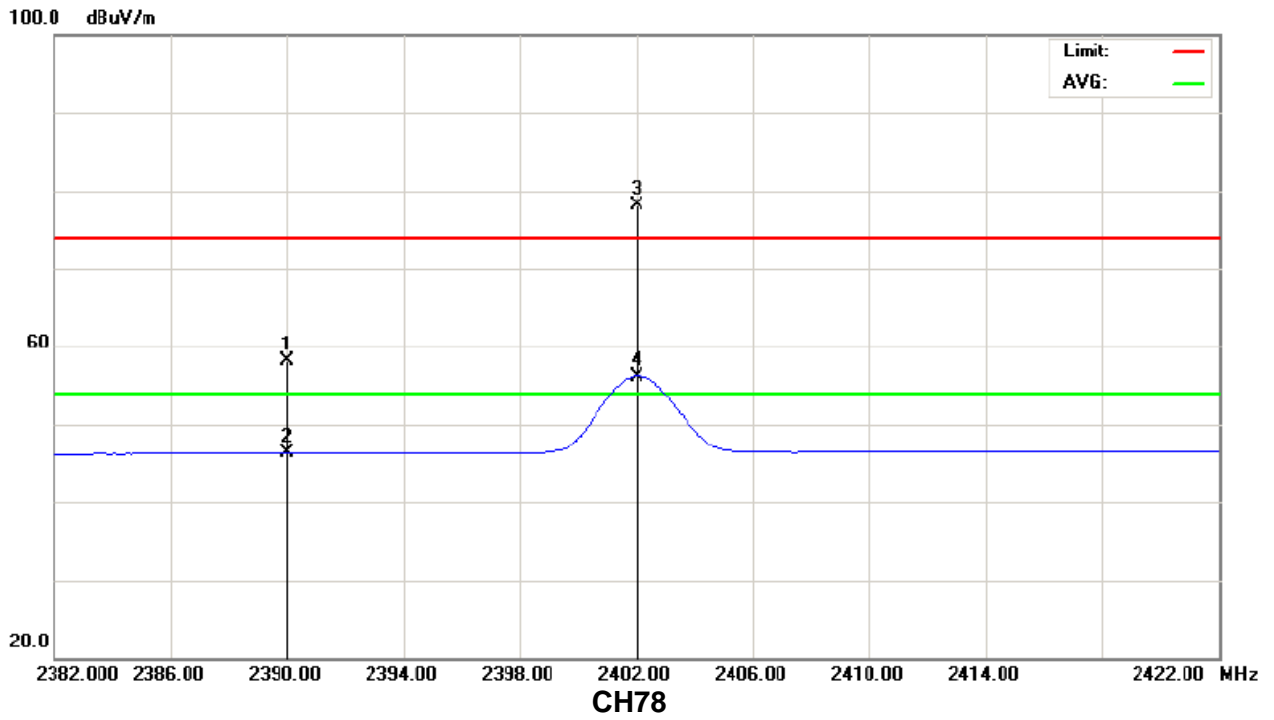

EUT :	Bluetooth Headset	Model Name :	SK-BTH-015A
Temperature :	30 °C	Relative Humidity :	63%
Pressure :	1010 hPa	Test Voltage :	Li-ion Battery 3.7Vdc
Test Mode :	TX 2402MHz/2480MHz -3Mbps		
Note :	1. The transmitter was setup to transmit at the lowest channel (CH00). Then the field strength was measured at 2310-2390 MHz. 2. The transmitter was setup to transmit at the highest channel (CH78). Then the field strength was measured at 2483.5-2500 MHz.		

Freq.	Ant.Pol.	Reading		Ant./CF	Act.		Limit		Note
		Peak	AV		Peak	AV	Peak	AV	
(MHz)	H/V	(dBuV)	(dBuV)	CF(dB)	(dBuV/m)	(dBuV/m)	(dBuV/m)	(dBuV/m)	
2390.00	H	25.88	14.25	32.05	57.93	46.30	74.00	54.00	CH00
2483.50	H	25.68	15.55	32.34	58.02	47.89	74.00	54.00	CH78

Remark :

- (1) Radiated emissions measured in frequency range above 1000MHz were made with an instrument using Peak detector mode and AV detector mode of the emission .
- (2) EUT Orthogonal Axis :
 "X" - denotes Laid on Table ; "Y" - denotes Vertical Stand ; "Z" - denotes Side Stand
- (3) During the measurements above 1 GHz it is taken care of that the EUT is always within the 3 dB cone of radiation BW of the used antenna

Restricted Bands Requirements, Horizontal CH00

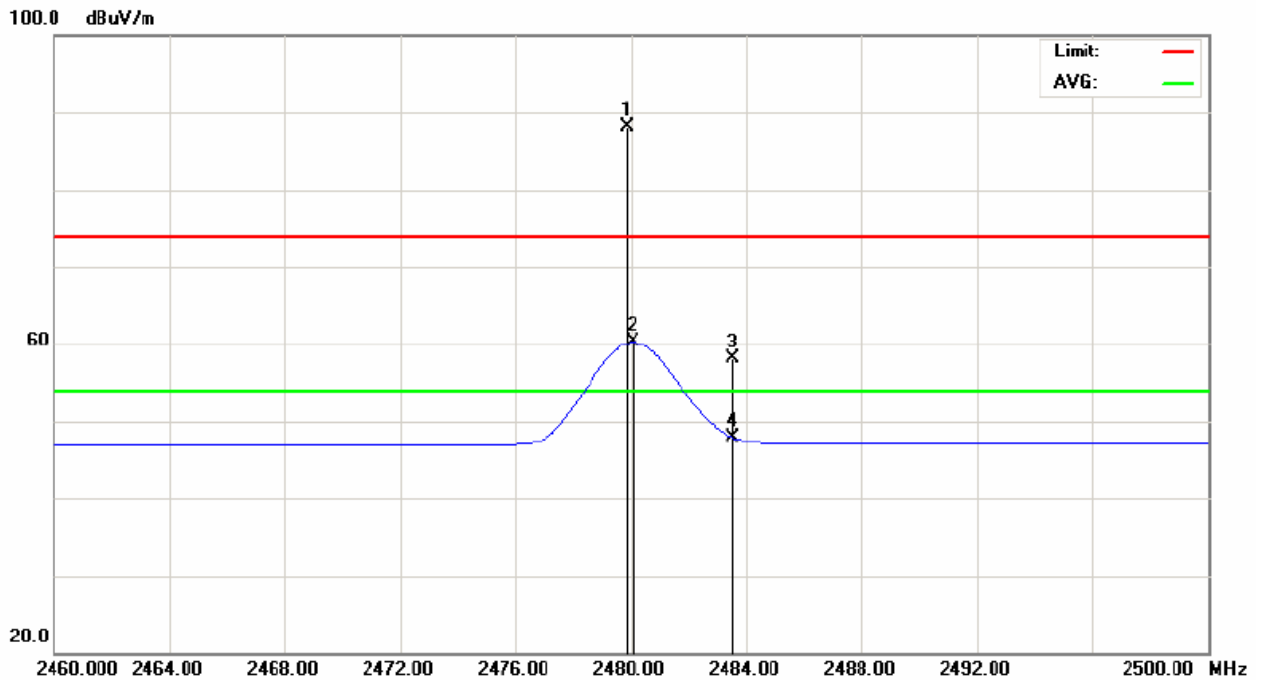
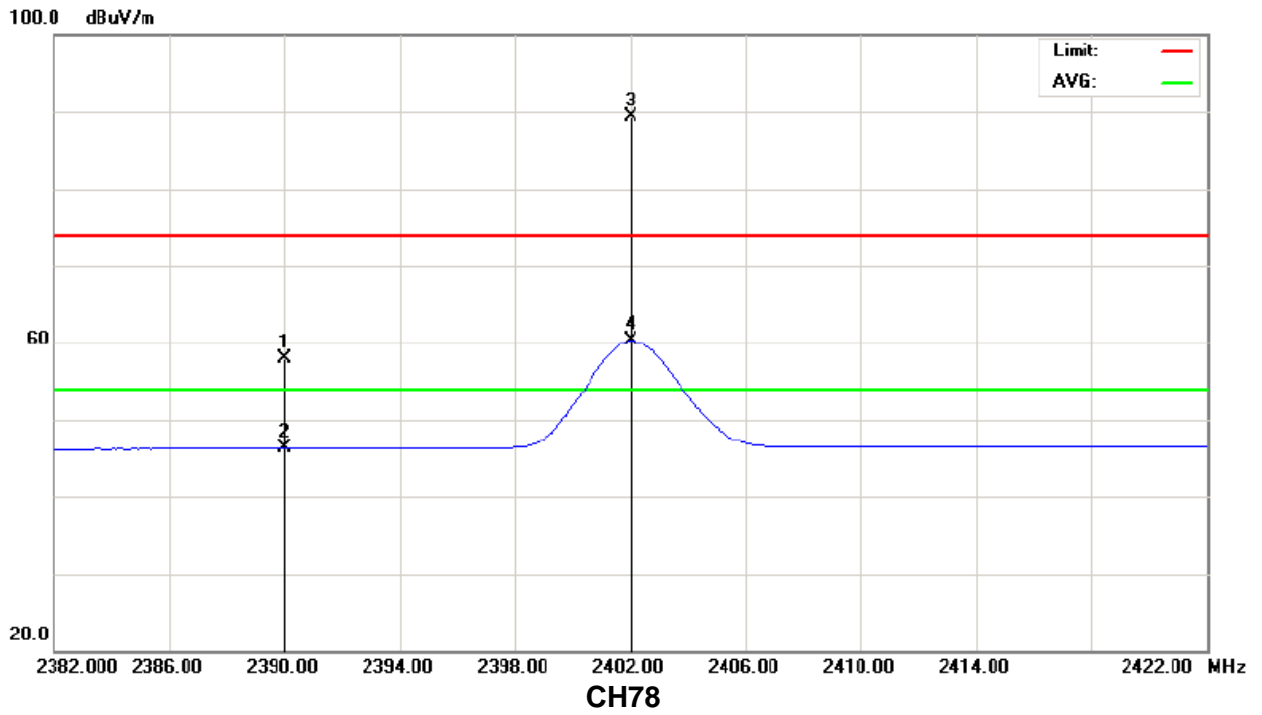

5. NUMBER OF HOPPING CHANNEL

5.1 APPLIED PROCEDURES / LIMIT

FCC Part15 (15.247) , Subpart C			
Section	Test Item	Frequency Range (MHz)	Result
15.247 (a)(1)(ii)	Number of Hopping Channel	2400-2483.5	PASS

5.1.1 MEASUREMENT INSTRUMENTS LIST AND SETTING

Item	Kind of Equipment	Manufacturer	Type No.	Serial No.	Calibrated until
1	Spectrum Analyzer	R&S	FSP_40	100129	Jan. 07, 2009

Remark: " N/A" denotes No Model Name , Serial No. or No Calibration specified.

Spectrum Parameters	Setting
Attenuation	Auto
Span Frequency	> Operating Frequency Range
RB	100 kHz
VB	100 kHz
Detector	Peak
Trace	Max Hold
Sweep Time	Auto

5.1.2 TEST PROCEDURE

- a. The EUT was directly connected to the spectrum analyzer and antenna output port as show in the block diagram below,
- b. Spectrum Setting : RBW= 100KHz, VBW=100KHz, Sweep time = Auto.

5.1.3 DEVIATION FROM STANDARD

No deviation.

5.1.4 TEST SETUP



5.1.5 EUT OPERATION CONDITIONS

The EUT tested system was configured as the statements of 4.1.6 Unless otherwise a special operating condition is specified in the follows during the testing.

5.1.6 TEST RESULTS

EUT :	Bluetooth Headset	Model Name :	SK-BTH-015A
Temperature :	25 °C	Relative Humidity :	60%
Pressure :	1015 hPa	Test Voltage :	Li-ion Battery 3.7Vdc
Test Mode :	Hopping Mode -1 Mbps		

Number of Hopping Channel	79
---------------------------	----

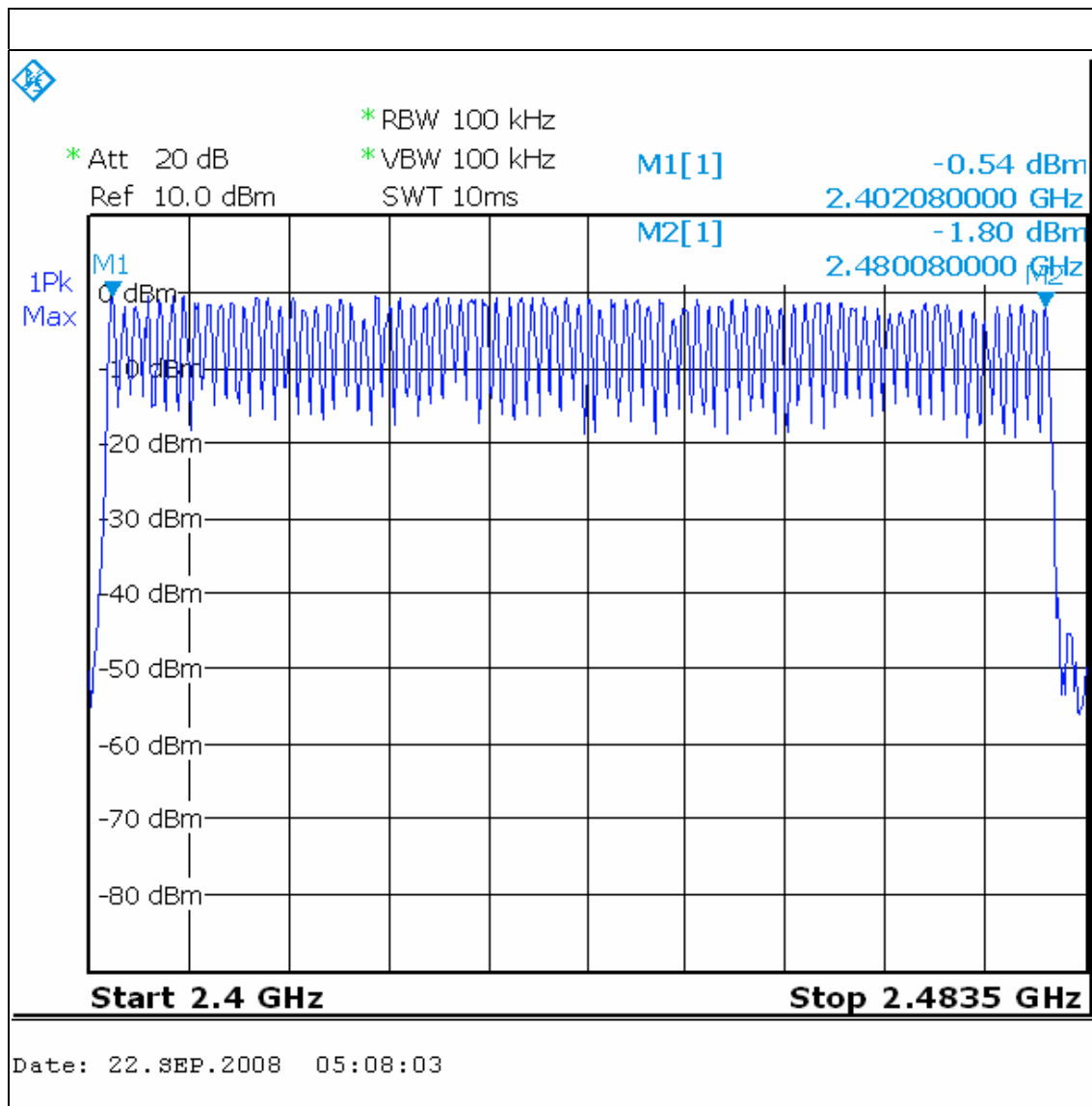

EUT :	Bluetooth Headset	Model Name :	SK-BTH-015A
Temperature :	25 °C	Relative Humidity :	60%
Pressure :	1015 hPa	Test Voltage :	Li-ion Battery 3.7Vdc
Test Mode :	Hopping Mode -3 Mbps		

Number of Hopping Channel	79
---------------------------	----

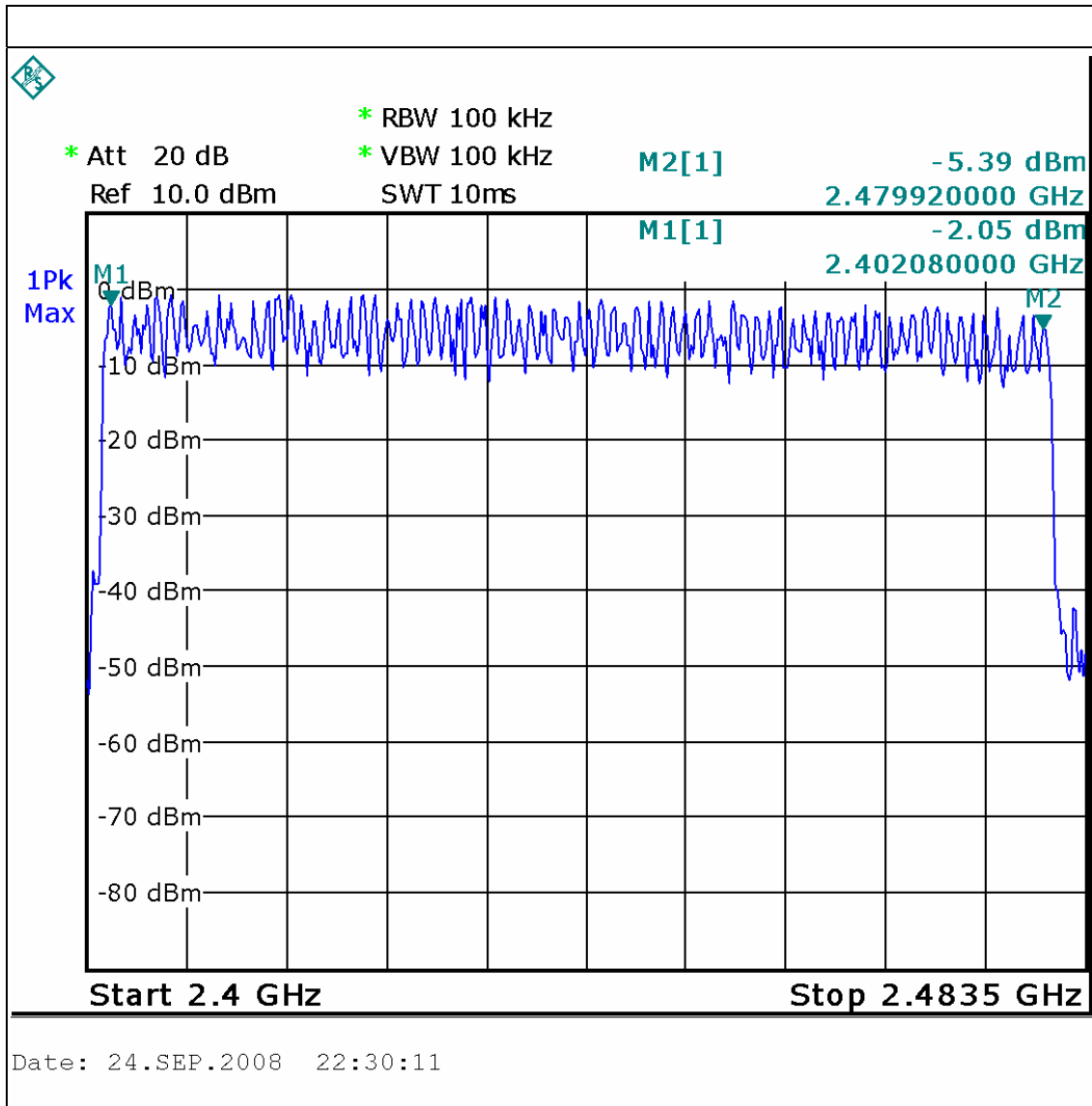

6. AVERAGE TIME OF OCCUPANCY

6.1 APPLIED PROCEDURES / LIMIT

FCC Part15 (15.247) , Subpart C				
Section	Test Item	Limit	Frequency Range (MHz)	Result
15.247 (a)(1)(ii)	Average Time of Occupancy	0.4sec	2400-2483.5	PASS

6.1.1 MEASUREMENT INSTRUMENTS LIST

Item	Kind of Equipment	Manufacturer	Type No.	Serial No.	Calibrated until
1	Spectrum Analyzer	R&S	FSP_40	100129	Jan. 07, 2009

Remark: " N/A" denotes No Model Name , Serial No. or No Calibration specified.

6.1.2 TEST PROCEDURE

- a. The transmitter output (antenna port) was connected to the spectrum analyzer
- b. Set RBW of spectrum analyzer to 1MHz and VBW to 1MHz.
- c. Use a video trigger with the trigger level set to enable triggering only on full pulses.
- d. Sweep Time is more than once pulse time.
- e. Set the center frequency on any frequency would be measure and set the frequency span to zero span.
- f. Measure the maximum time duration of one single pulse.
- g. Set the EUT for DH5, DH3 and DH1 packet transmitting.
- h. Measure the maximum time duration of one single pulse.
- i. DH5 Packet permit maximum $1600 / 79 / 6 = 3.37$ hops per second in each channel (5 time slots RX, 1 time slot TX). So, the dwell time is the time duration of the pulse times $3.37 \times 31.6 = 106.6$ within 31.6 seconds.
- j. DH3 Packet permit maximum $1600 / 79 / 4 = 5.06$ hops per second in each channel (3 time slots RX, 1 time slot TX). So, the dwell time is the time duration of the pulse times $5.06 \times 31.6 = 160$ within 31.6 seconds.
- k. DH1 Packet permit maximum $1600 / 79 / 2 = 10.12$ hops per second in each channel (1 time slot RX, 1 time slot TX). So, the dwell time is the time duration of the pulse times $10.12 \times 31.6 = 320$ within 31.6 seconds.

6.1.3 DEVIATION FROM STANDARD

No deviation.

6.1.4 TEST SETUP

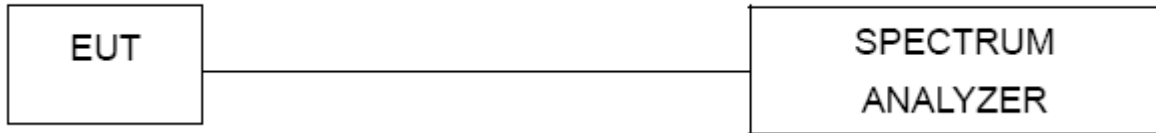

6.1.5 EUT OPERATION CONDITIONS

The EUT tested system was configured as the statements of 4.1.6 Unless otherwise a special operating condition is specified in the follows during the testing.

6.1.6 TEST RESULTS

EUT :	Bluetooth Headset	Model Name :	SK-BTH-015A
Temperature :	25 °C	Relative Humidity :	60%
Pressure :	1012 hPa	Test Voltage :	Li-ion Battery 3.7Vdc
Test Mode :	CH00-DH1/DH3/DH5 -1Mbps		

Data Packet	Frequency	Pulse Duration (ms)	Dwell Time (s)	Limits (s)
DH5	2402 MHz	3.0950	0.3301	0.4000
DH3	2402 MHz	1.8300	0.2928	0.4000
DH1	2402 MHz	0.5400	0.1728	0.4000

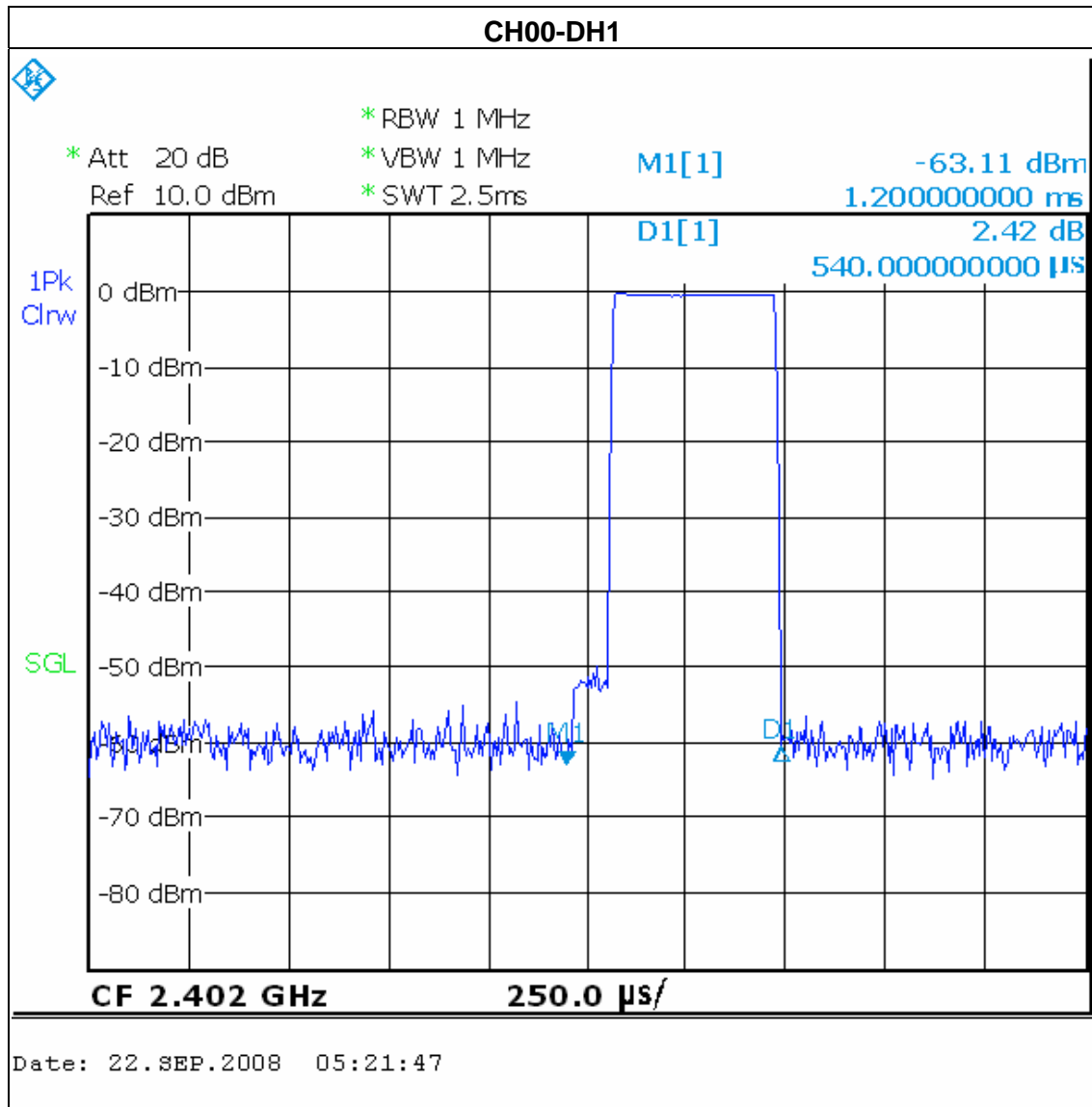

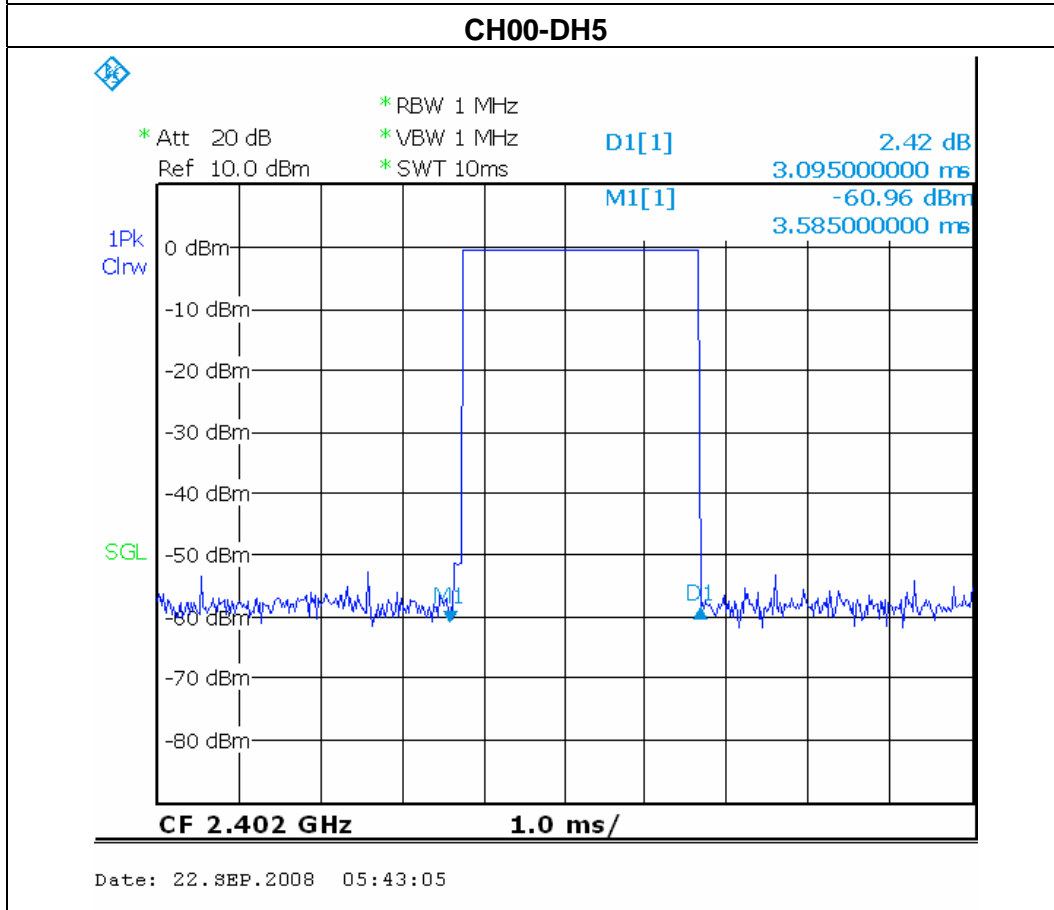
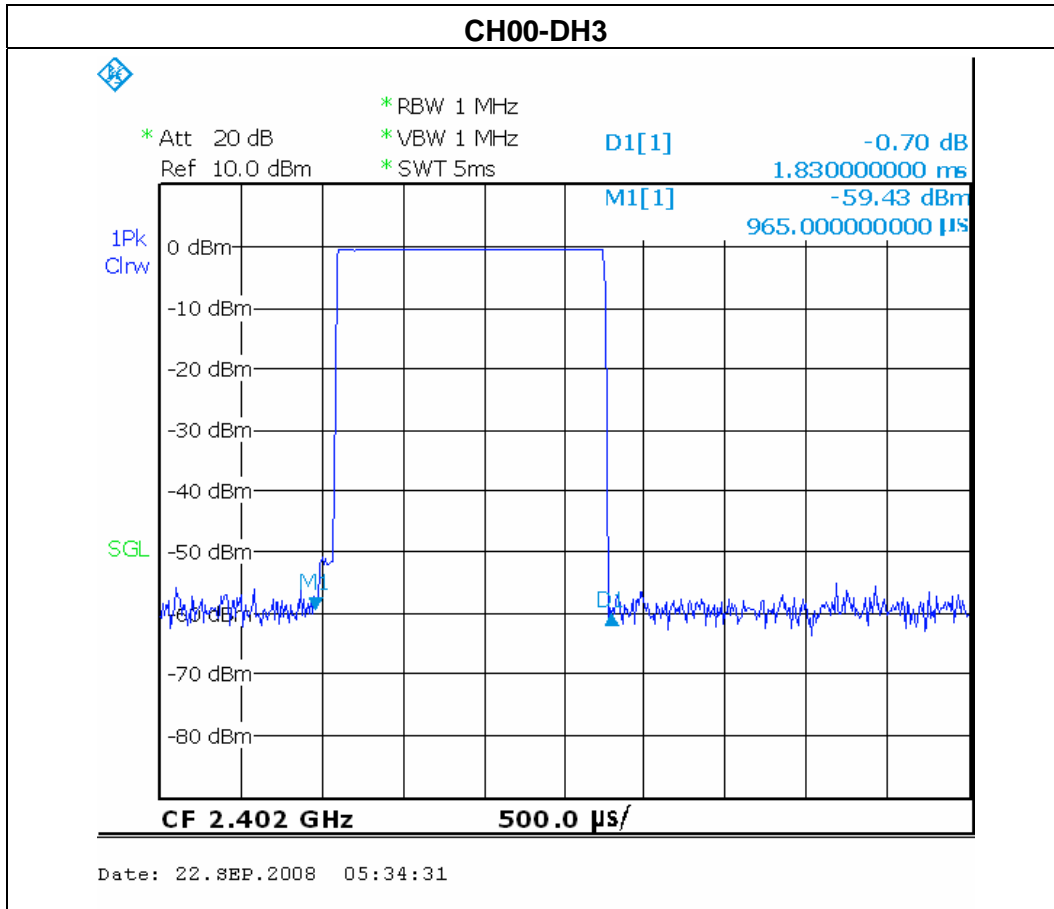

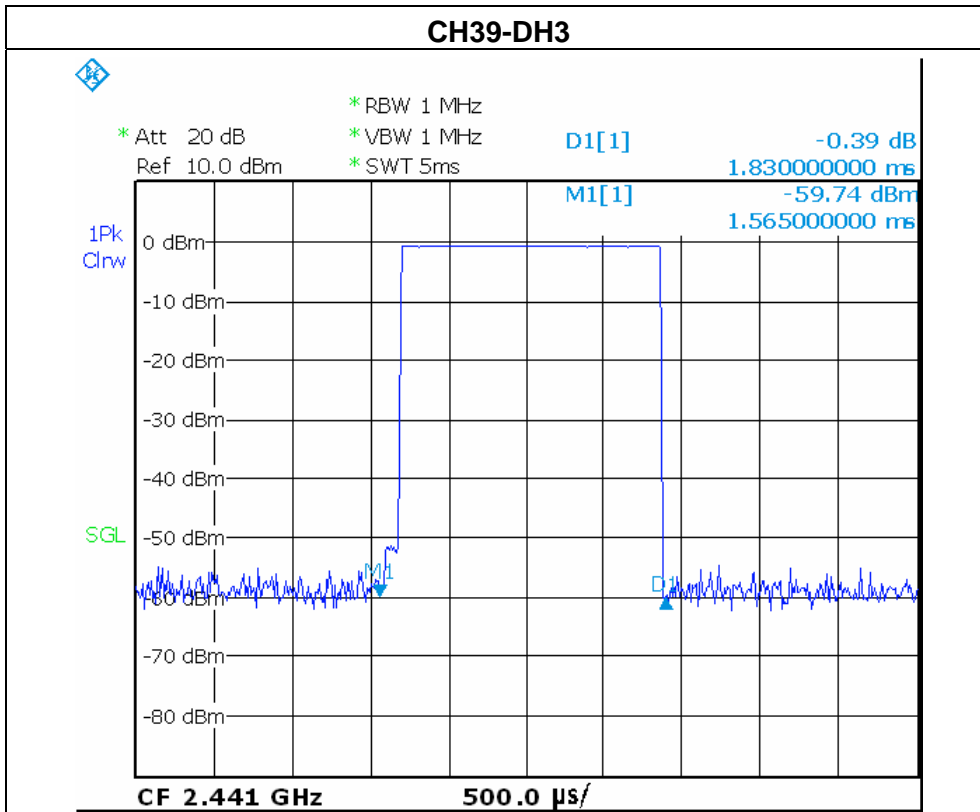

Date: 22.SEP.2008 05:35:55

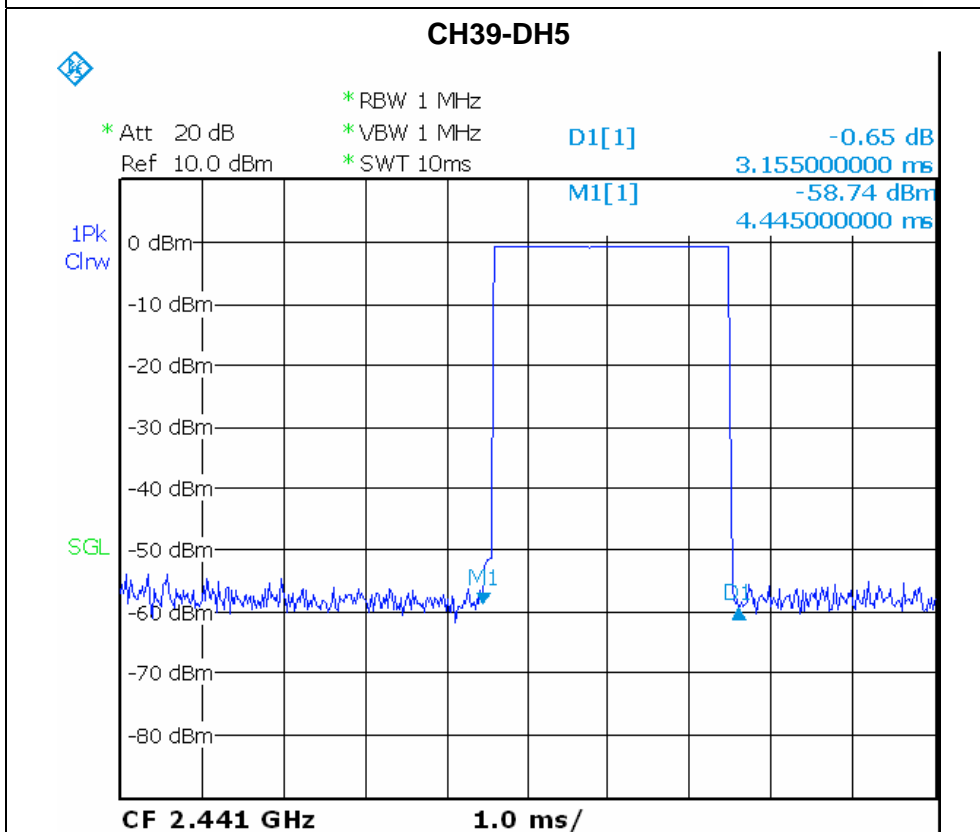

Date: 22.SEP.2008 05:40:56

EUT :	Bluetooth Headset	Model Name :	SK-BTH-015A
Temperature :	25 °C	Relative Humidity :	60%
Pressure :	1012 hPa	Test Voltage :	Li-ion Battery 3.7Vdc
Test Mode :	CH78 -DH1/DH3/DH5 -1Mbps		

Data Packet	Frequency	Pulse Duration (ms)	Dwell Time (s)	Limits (s)
DH5	2480 MHz	3.1550	0.3365	0.4000
DH3	2480 MHz	1.8100	0.2896	0.4000
DH1	2480 MHz	0.5500	0.1760	0.4000

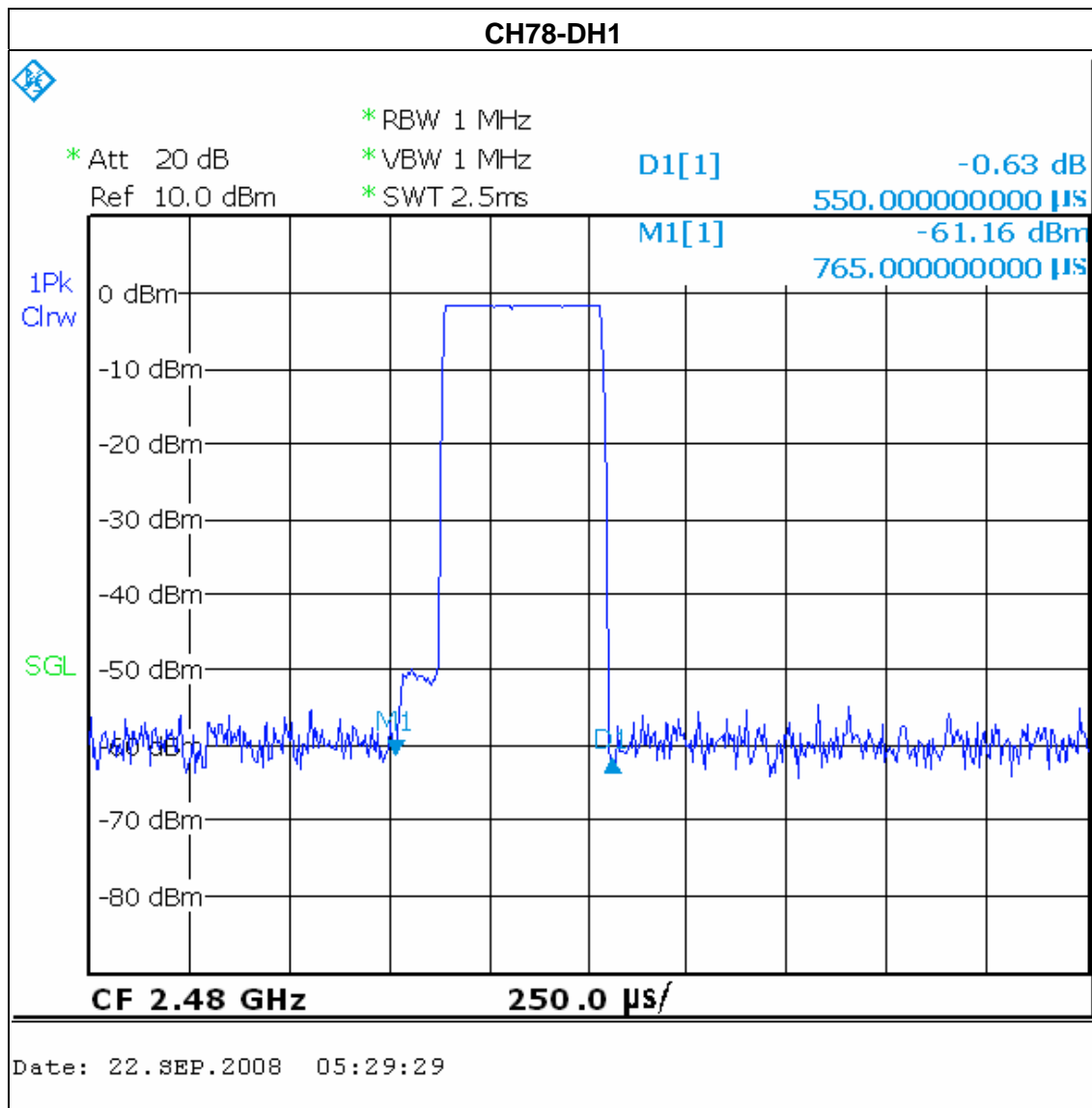

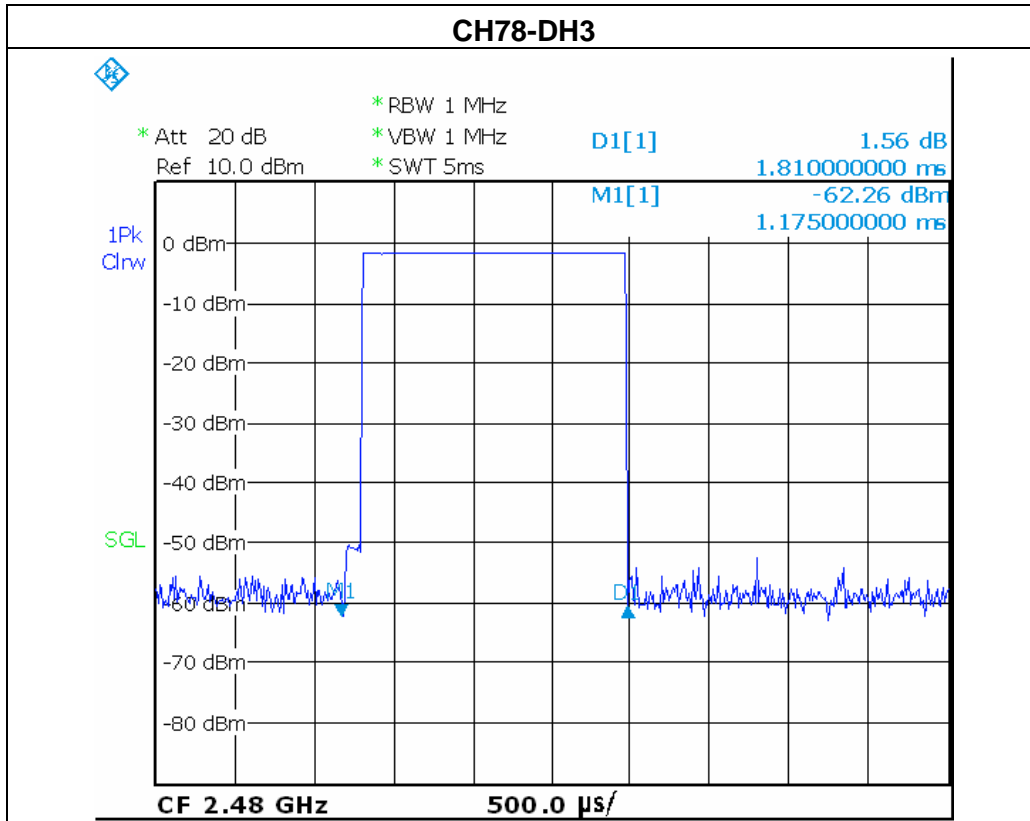

Date: 22.SEP.2008 05:31:17

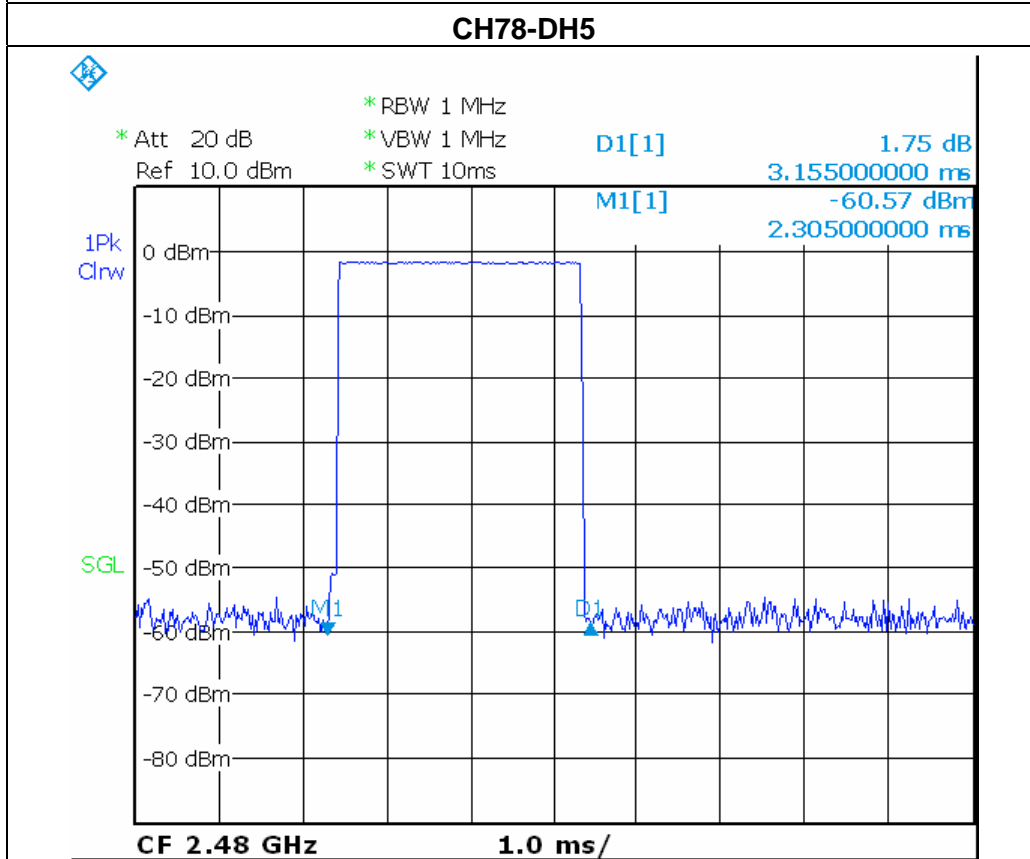

Date: 22.SEP.2008 05:45:57

EUT :	Bluetooth Headset	Model Name :	SK-BTH-015A
Temperature :	25 °C	Relative Humidity :	60%
Pressure :	1012 hPa	Test Voltage :	Li-ion Battery 3.7Vdc
Test Mode :	CH00-DH1/DH3/DH5 -3Mbps		

Data Packet	Frequency	Pulse Duration (ms)	Dwell Time (s)	Limits (s)
DH5	2402 MHz	3.1950	0.3408	0.4000
DH3	2402 MHz	1.9150	0.3064	0.4000
DH1	2402 MHz	0.5500	0.1760	0.4000

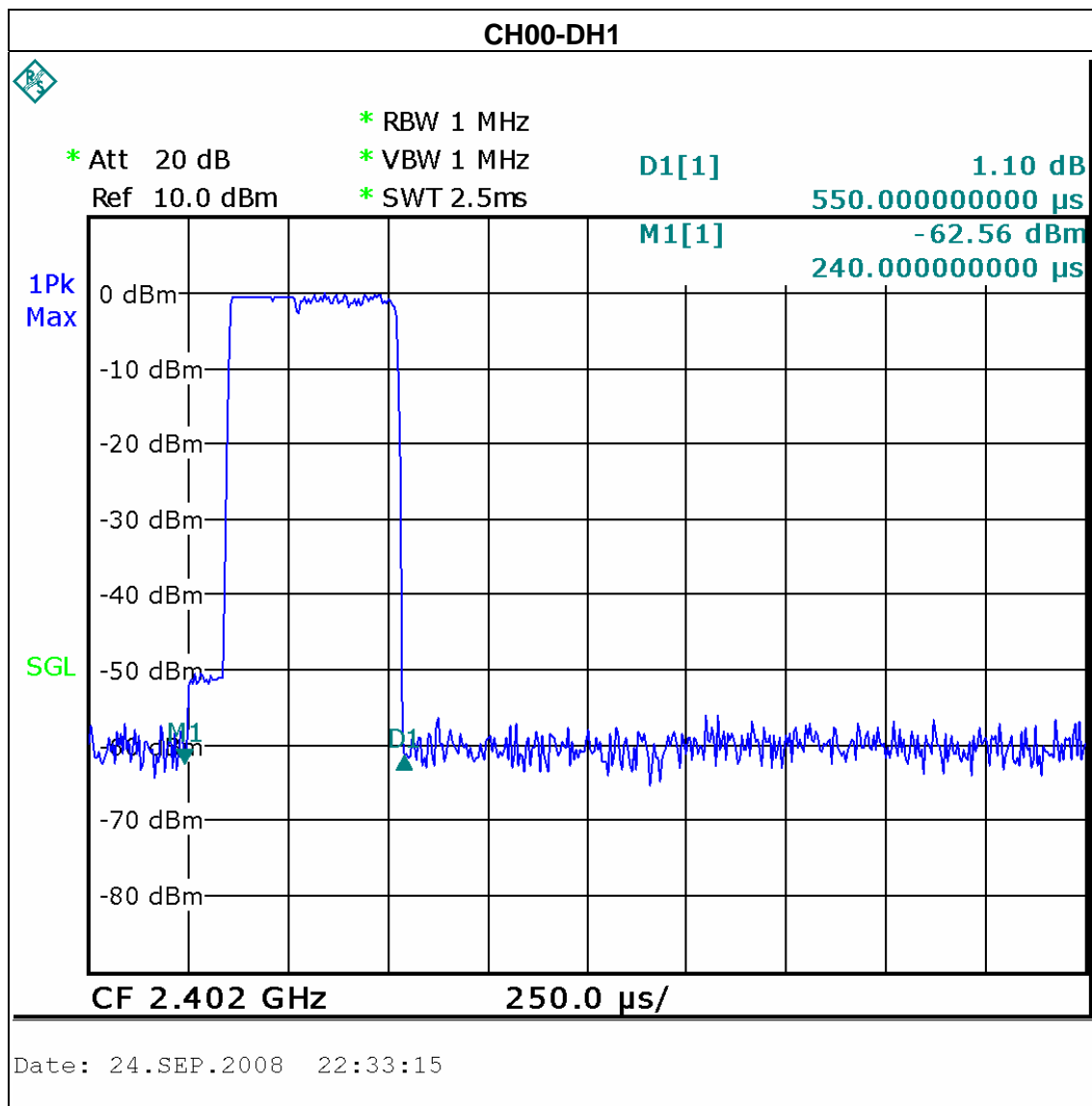

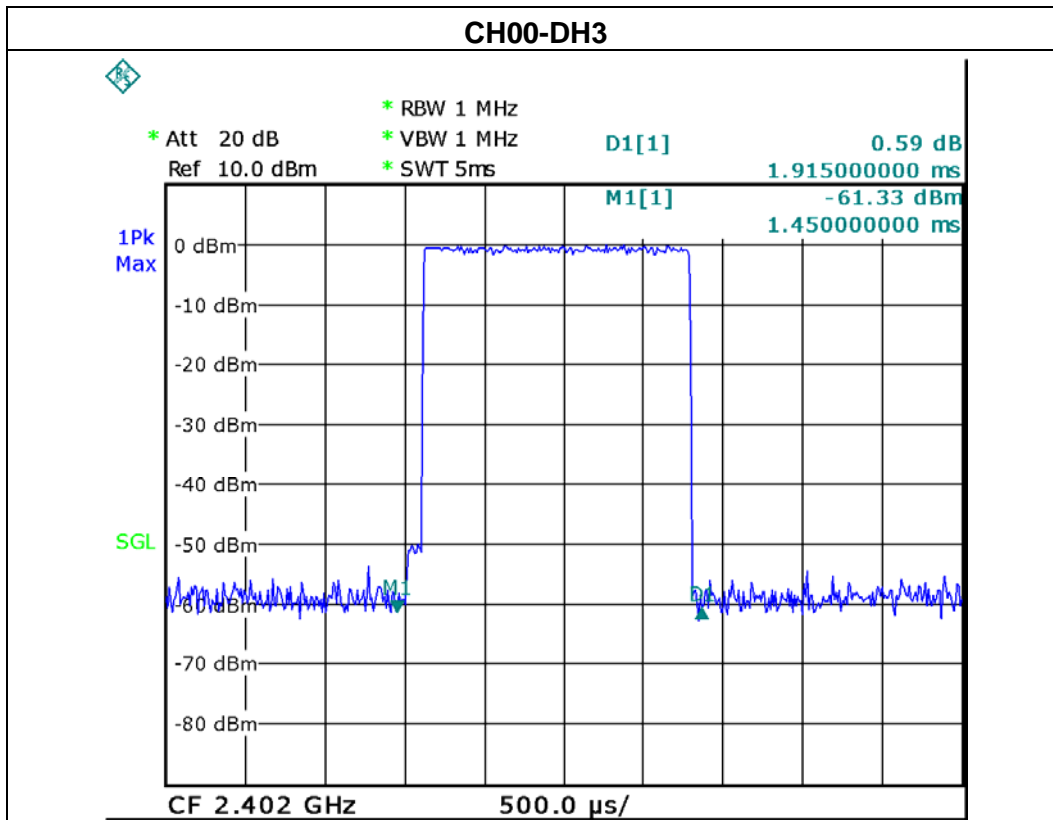

Date: 24.SEP.2008 22:49:10

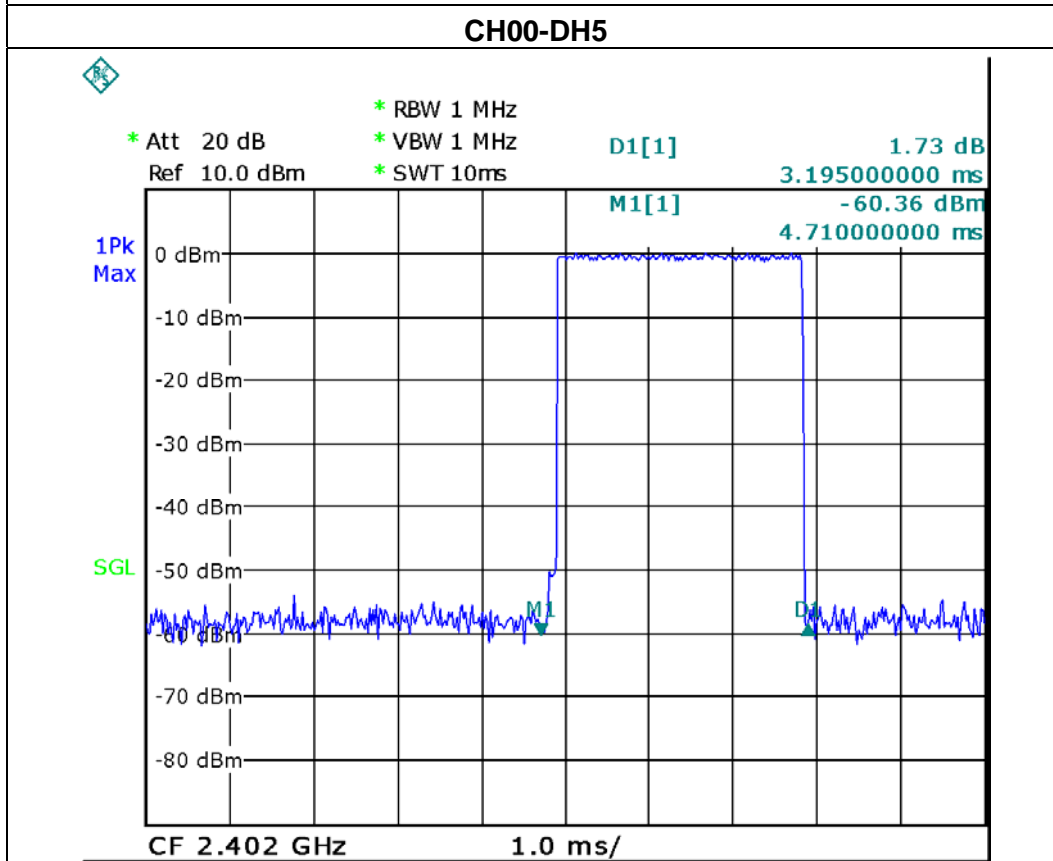

Date: 24.SEP.2008 22:51:07

EUT :	Bluetooth Headset	Model Name :	SK-BTH-015A
Temperature :	25 °C	Relative Humidity :	60%
Pressure :	1012 hPa	Test Voltage :	Li-ion Battery 3.7Vdc
Test Mode :	CH39 -DH1/DH3/DH5 -3Mbps		

Data Packet	Frequency	Pulse Duration (ms)	Dwell Time (s)	Limits (s)
DH5	2441 MHz	3.0950	0.3301	0.4000
DH3	2441 MHz	1.8250	0.2920	0.4000
DH1	2441 MHz	0.5650	0.1808	0.4000

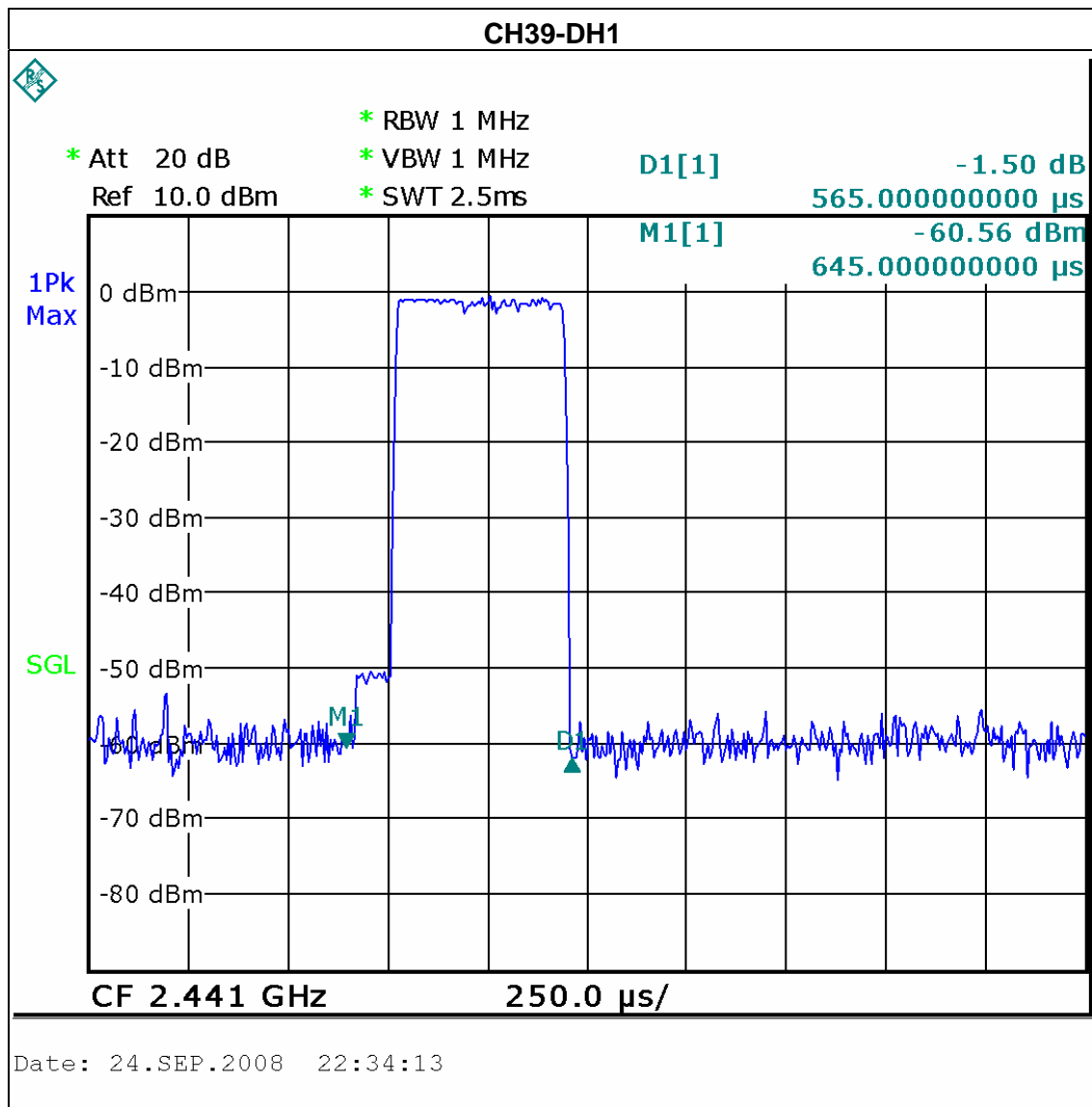

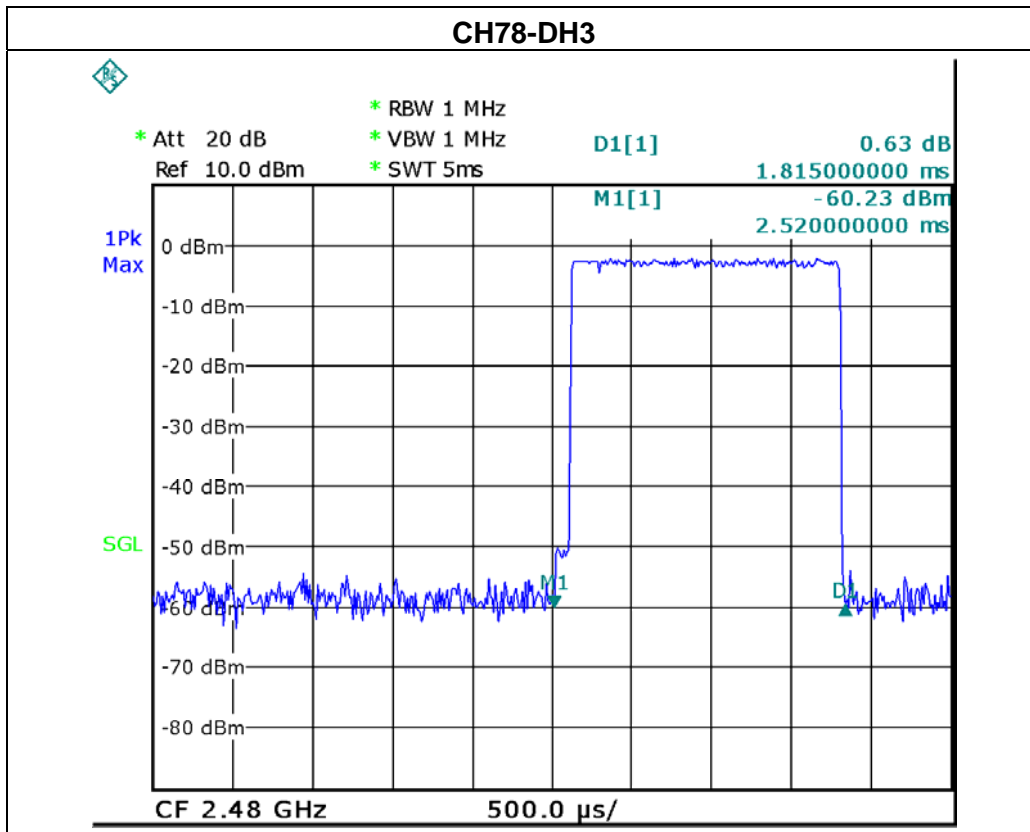

Date: 24.SEP.2008 22:44:41

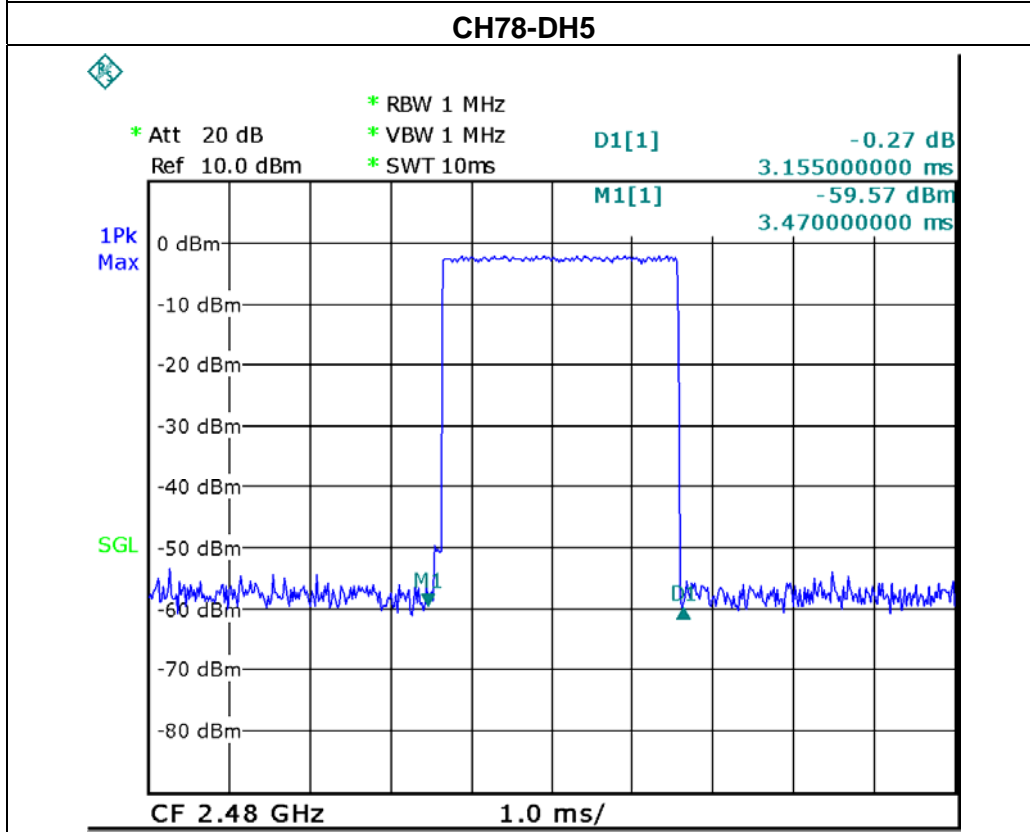

Date: 24.SEP.2008 22:55:43

7. HOPPING CHANNEL SEPARATION MEASUREMENT

7.1 APPLIED PROCEDURES / LIMIT

Frequency hopping systems operating in the 2400-2483.5 MHz band may have hopping channel carrier frequencies that are separated by 25 kHz or two-thirds of the 20 dB bandwidth of the hopping channel, whichever is greater.

7.1.1 MEASUREMENT INSTRUMENTS LIST AND SETTING

Item	Kind of Equipment	Manufacturer	Type No.	Serial No.	Calibrated until
1	Spectrum Analyzer	R&S	FSP_40	100129	Jan. 07, 2009

Remark: " N/A" denotes No Model Name , Serial No. or No Calibration specified.

Spectrum Parameter	Setting
Attenuation	Auto
Span Frequency	> Measurement Bandwidth or Channel Separation
RB	30 kHz (20dB Bandwidth) / 100 kHz (Channel Separation)
VB	100 kHz (20dB Bandwidth) / 300 kHz (Channel Separation)
Detector	Peak
Trace	Max Hold
Sweep Time	Auto

7.1.2 TEST PROCEDURE

- The transmitter output (antenna port) was connected to the spectrum analyser in peak hold mode.
- The resolution bandwidth of 30 kHz and the video bandwidth of 100 kHz were utilised for 20 dB bandwidth measurement.
- The resolution bandwidth of 100 kHz and the video bandwidth of 300 kHz were utilised for channel separation measurement.

7.1.3 DEVIATION FROM STANDARD

No deviation.

7.1.4 TEST SETUP

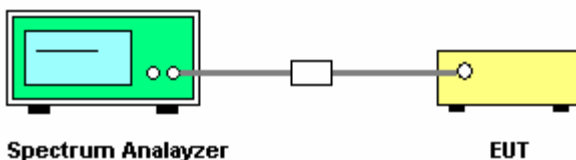

7.1.5 EUT OPERATION CONDITIONS

The EUT was programmed to be in continuously transmitting mode.

7.1.6 TEST RESULTS

EUT :	Bluetooth Headset	Model Name :	SK-BTH-015A
Temperature :	25 °C	Relative Humidity :	60%
Pressure :	1012 hPa	Test Voltage :	Li-ion Battery 3.7Vdc
Test Mode :	CH00 / CH39 /CH78 -1 Mbps		

Frequency	Ch. Separation (MHz)	20d Bandwidth B (kHz)	99% Occupied Bandwidth (kHz)	Result
2402 MHz	1	858.30	846.31	Complies
2441 MHz	1	834.31	846.31	Complies
2480 MHz	1	842.30	846.31	Complies

Ch. Separation Limits: >20dB bandwidth or >2/3 of 20dB bandwidth

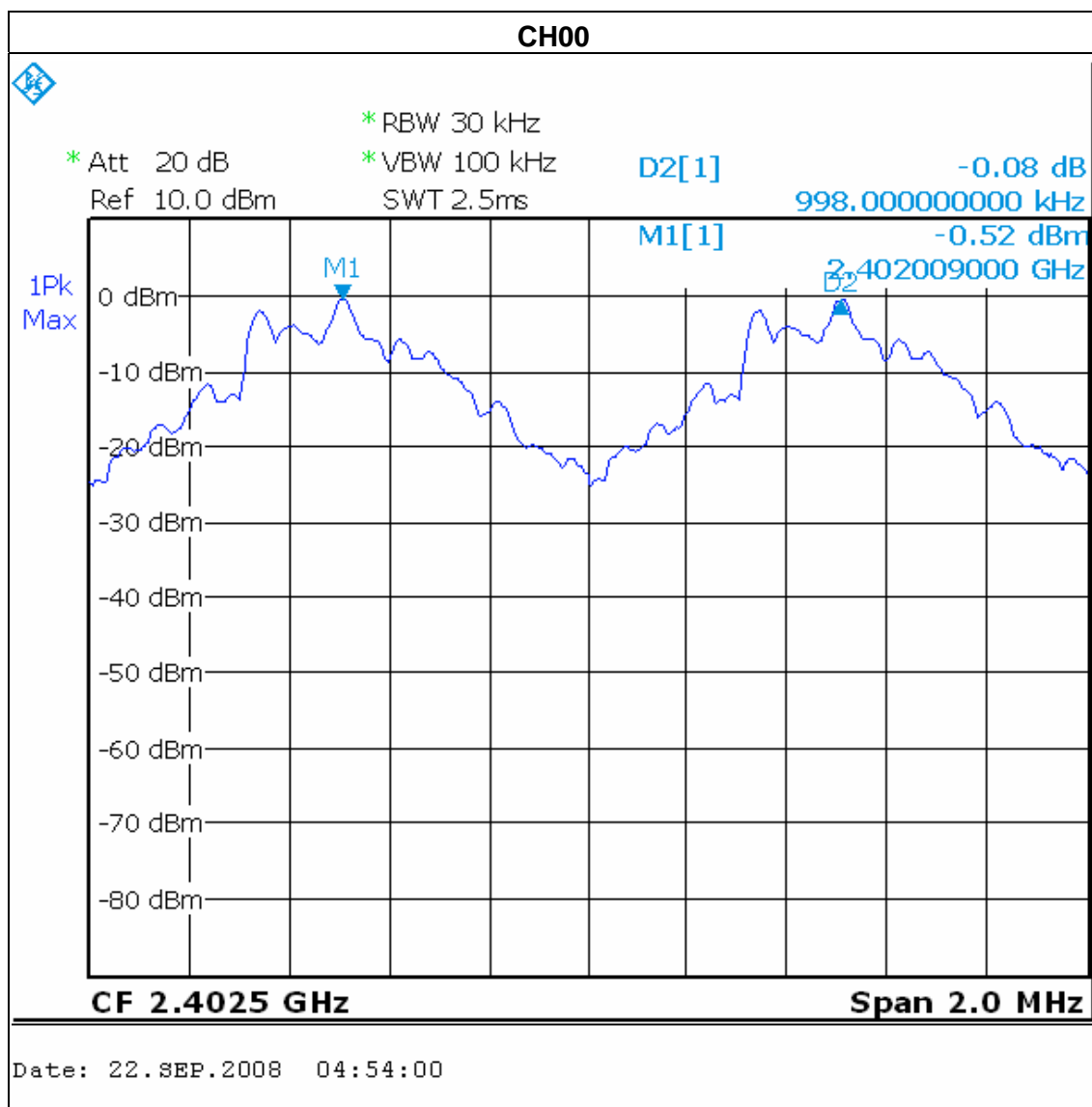

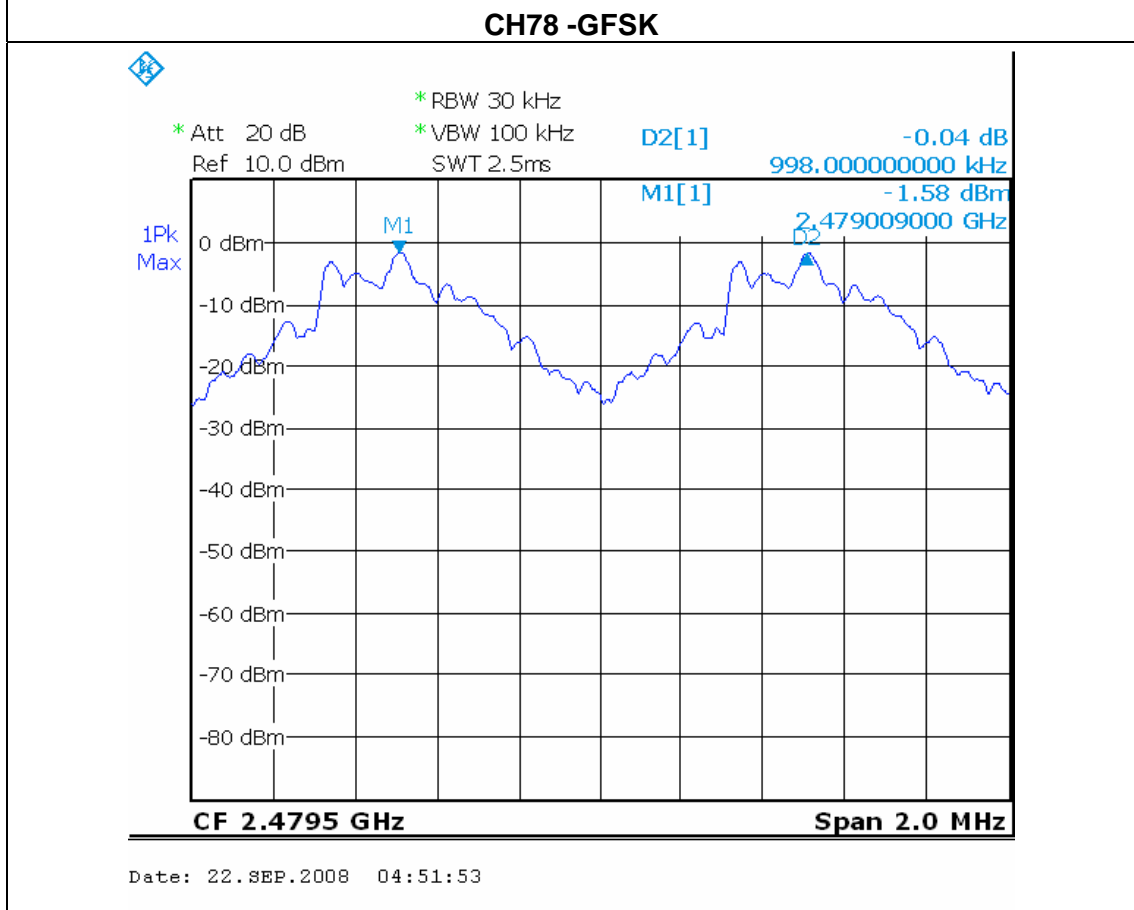
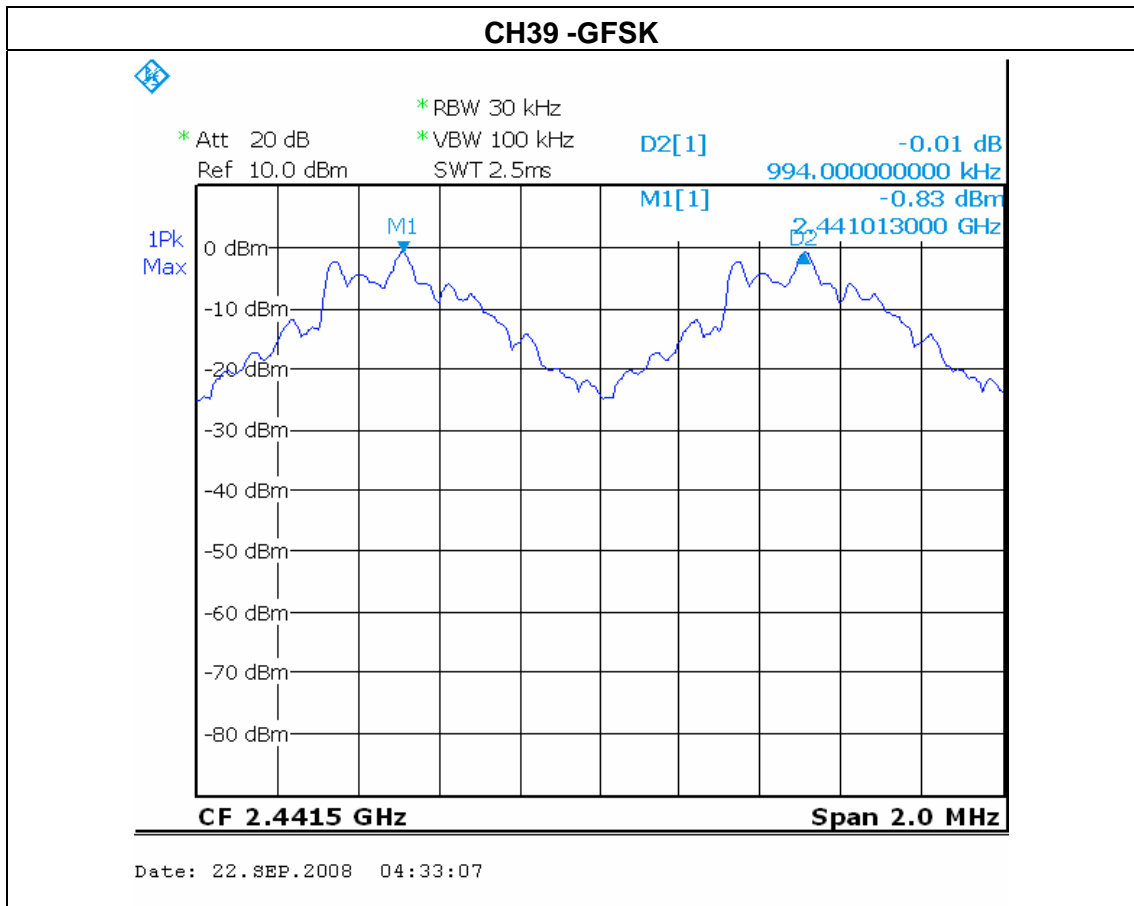

EUT :	Bluetooth Headset	Model Name :	SK-BTH-015A
Temperature :	25 °C	Relative Humidity :	60%
Pressure :	1012 hPa	Test Voltage :	Li-ion Battery 3.7Vdc
Test Mode :	CH00 / CH39 /CH78 -3 Mbps		

Frequency	Ch. Separation (MHz)	20d Bandwidth B (MHz)	99% Occupied Bandwidth (MHz)	Result
2402 MHz	1	1.210	1.150	Complies
2441 MHz	1	1.210	1.146	Complies
2480 MHz	1	1.202	1.146	Complies

Ch. Separation Limits: >20dB bandwidth or >2/3 of 20dB bandwidth

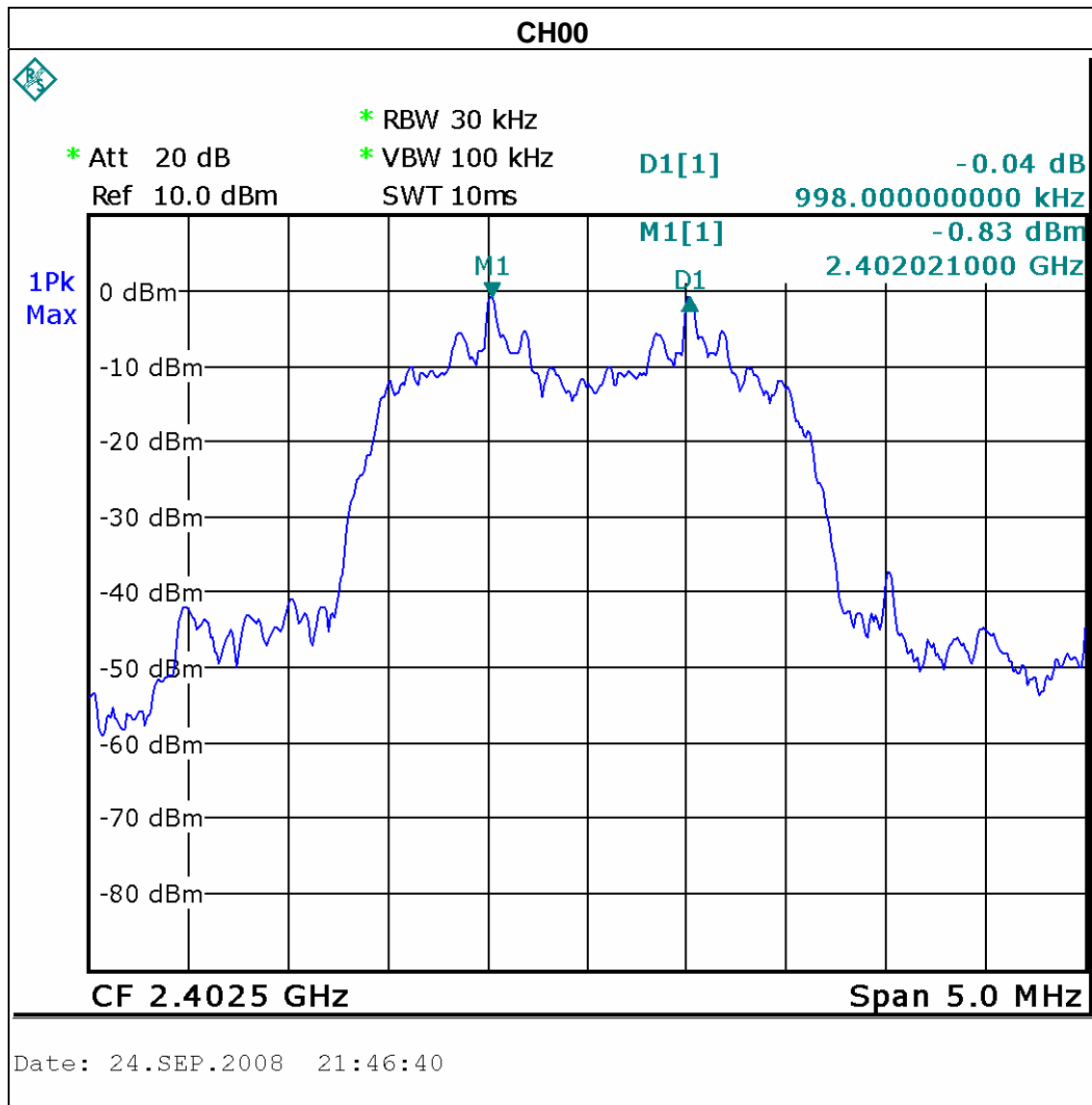

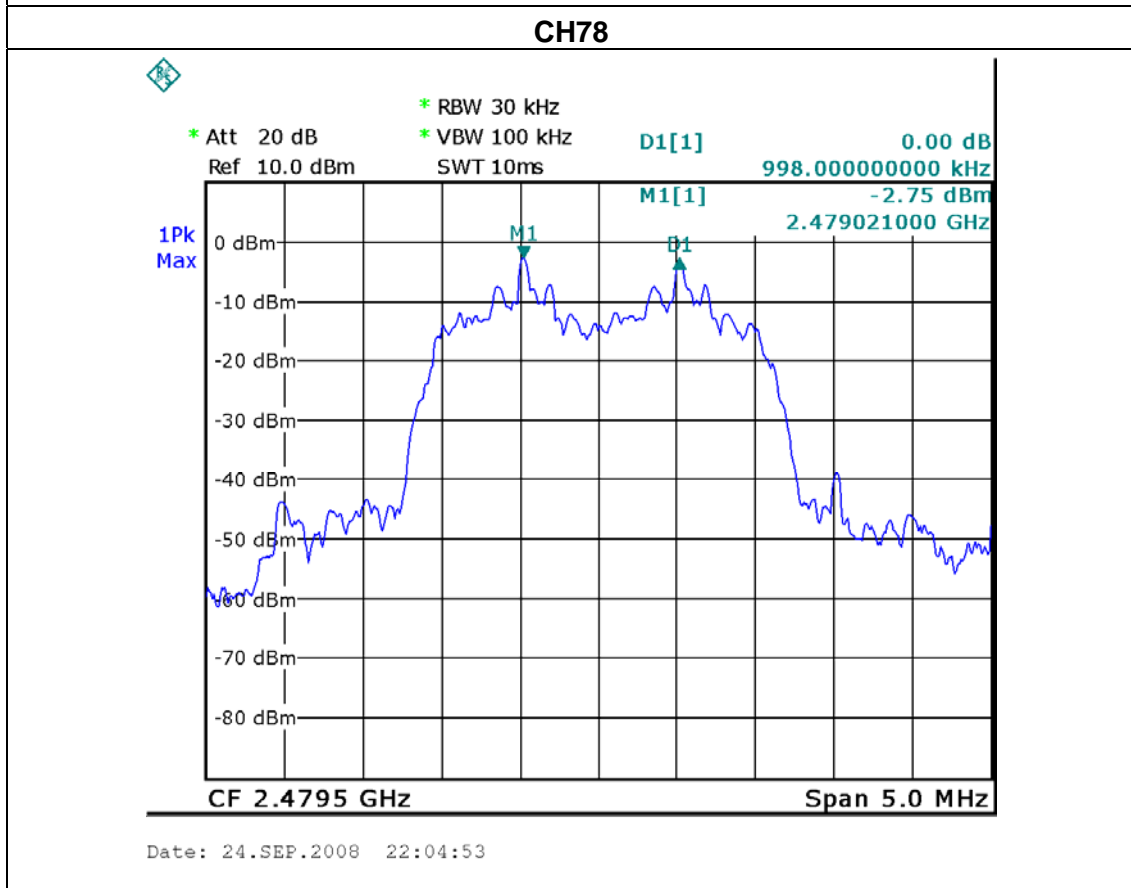
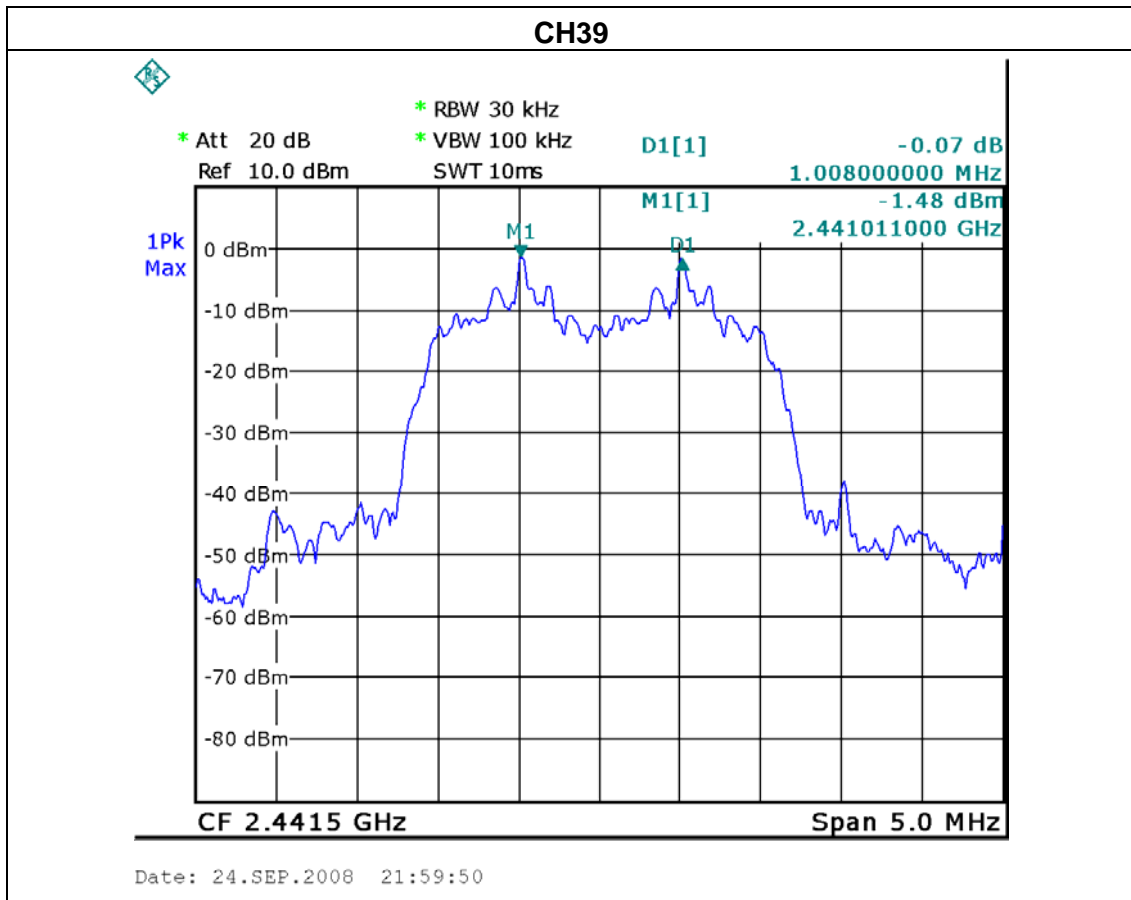

8. BANDWIDTH TEST

8.1 APPLIED PROCEDURES / LIMIT

FCC Part15 (15.247) , Subpart C				
Section	Test Item	Limit	Frequency Range (MHz)	Result
15.247 (a)(2)	Bandwidth	<= 1 MHz (20dB bandwidth)	2400-2483.5	PASS

8.1.1 MEASUREMENT INSTRUMENTS LIST AND SETTING

Item	Kind of Equipment	Manufacturer	Type No.	Serial No.	Calibrated until
1	Spectrum Analyzer	R&S	FSP_40	100129	Jan. 07, 2009

Remark: " N/A" denotes No Model Name , Serial No. or No Calibration specified.

Spectrum Parameter	Setting
Attenuation	Auto
Span Frequency	> Measurement Bandwidth or Channel Separation
RB	30 kHz (20dB Bandwidth) / 100 kHz (Channel Separation)
VB	100 kHz (20dB Bandwidth) / 300 kHz (Channel Separation)
Detector	Peak
Trace	Max Hold
Sweep Time	Auto

8.1.2 TEST PROCEDURE

- a. The EUT was directly connected to the spectrum analyzer and antenna output port as show in the block diagram below,
- b. Spectrum Setting : RBW= 100KHz, VBW=100KHz, Sweep time = Auto.

8.1.3 DEVIATION FROM STANDARD

No deviation.

8.1.4 TEST SETUP



8.1.5 EUT OPERATION CONDITIONS

The EUT tested system was configured as the statements of 4.1.6 Unless otherwise a special operating condition is specified in the follows during the testing.

8.1.6 TEST RESULTS

EUT :	Bluetooth Headset	Model Name :	SK-BTH-015A
Temperature :	25 °C	Relative Humidity :	60%
Pressure :	1012 hPa	Test Voltage :	Li-ion Battery 3.7Vdc
Test Mode :	CH00 / CH39 /CH78 -1 Mbps		

Frequency	20dB Bandwidth (kHz)	Channel Separation (MHz)	Result
2402 MHz	858.30	<= 1MHz	PASS
2441 MHz	834.31	<= 1MHz	PASS
2480 MHz	842.30	<= 1MHz	PASS

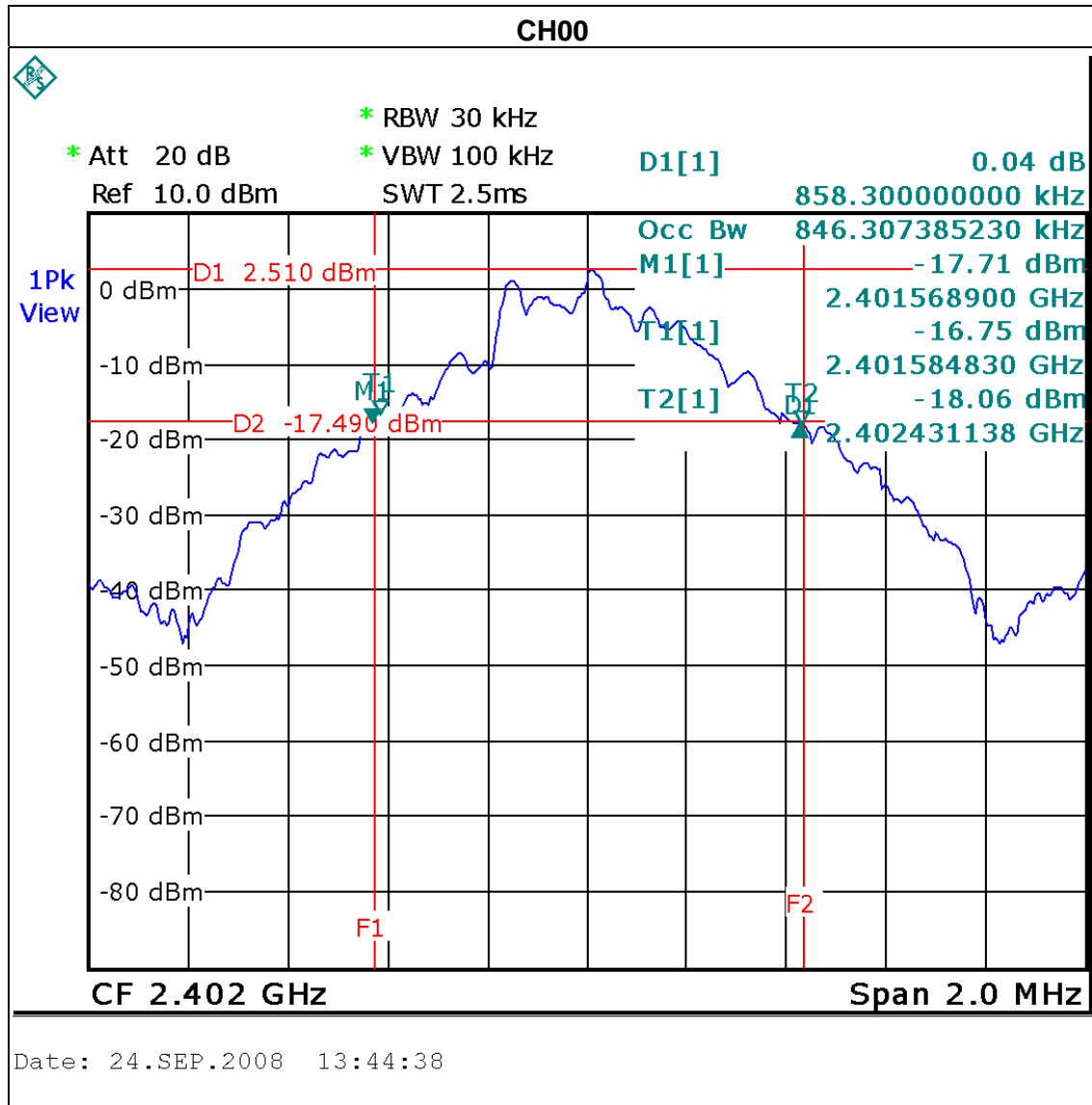

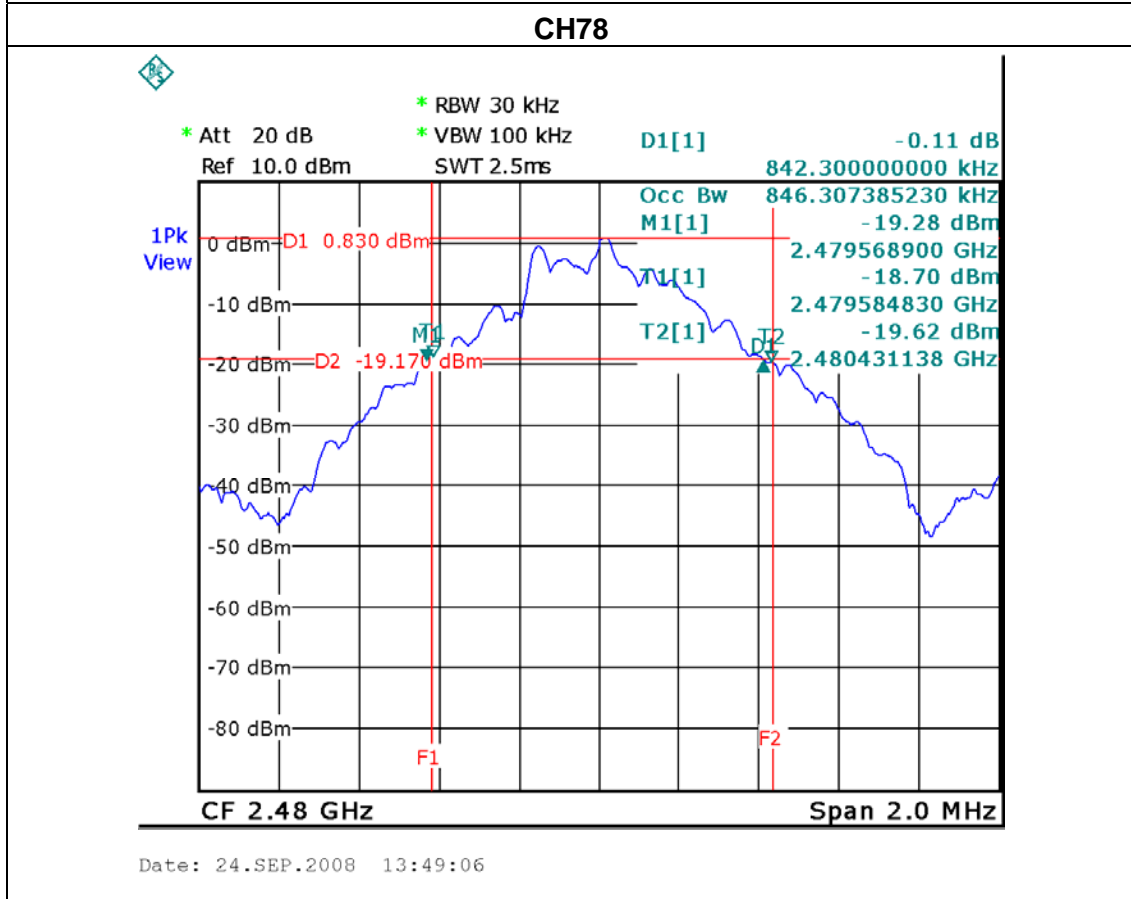
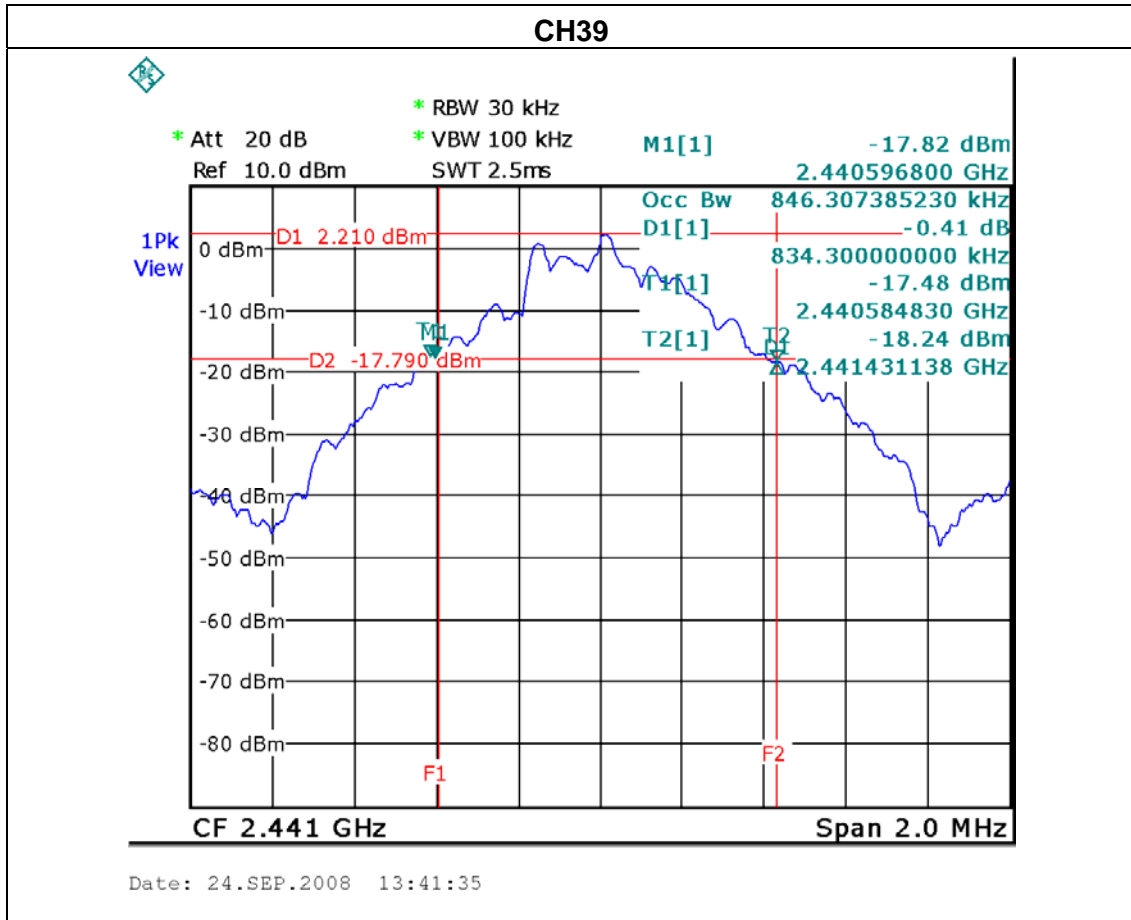

EUT :	Bluetooth Headset	Model Name :	SK-BTH-015A
Temperature :	25 °C	Relative Humidity :	60%
Pressure :	1012 hPa	Test Voltage :	Li-ion Battery 3.7Vdc
Test Mode :	CH00 / CH39 /CH78 3 Mbps		

Frequency	20dB Bandwidth (kHz)	Channel Separation (MHz)	Result
2402 MHz	1.210	<= 1MHz	PASS
2441 MHz	1.210	<= 1MHz	PASS
2480 MHz	1.202	<= 1MHz	PASS

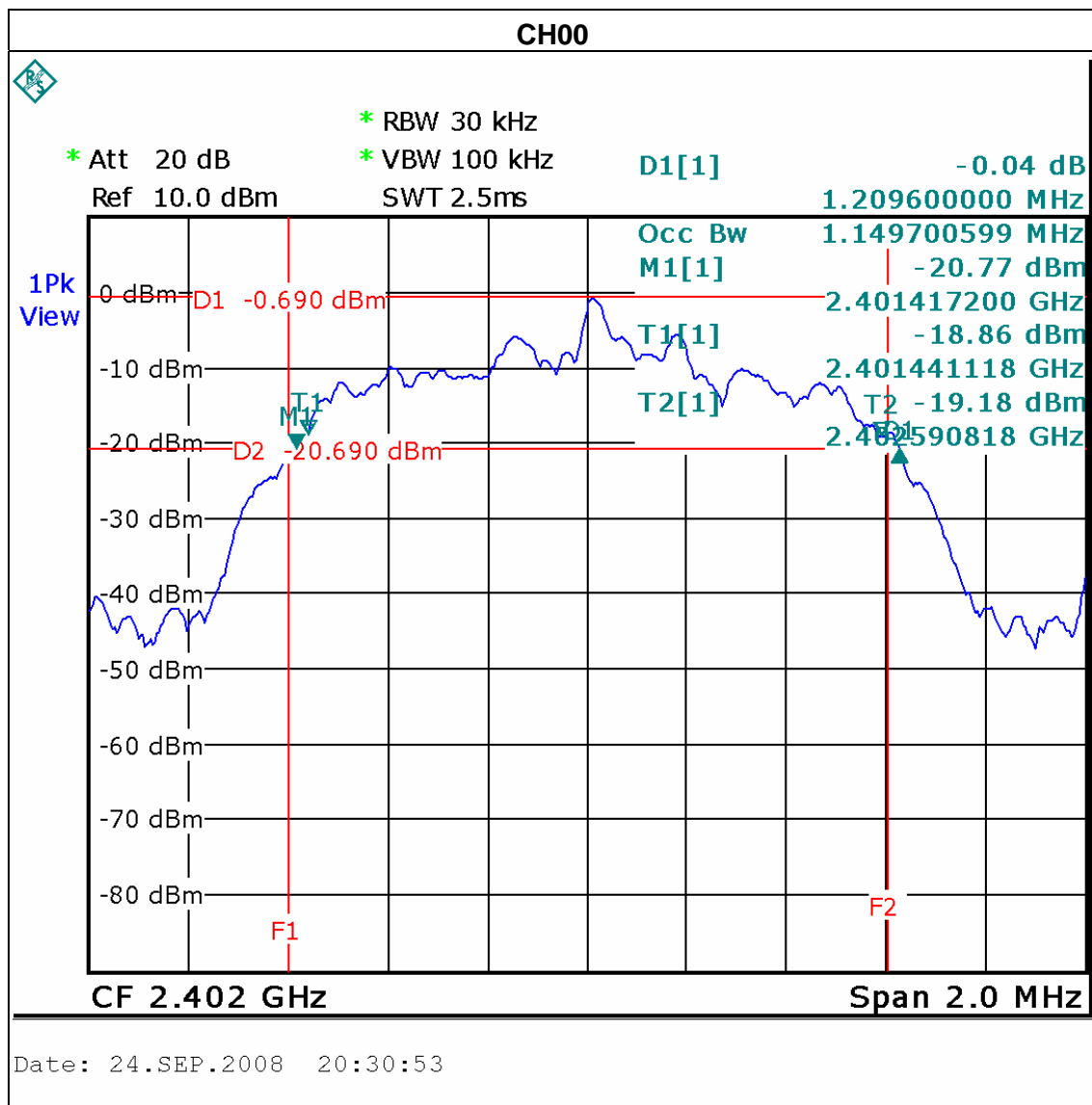

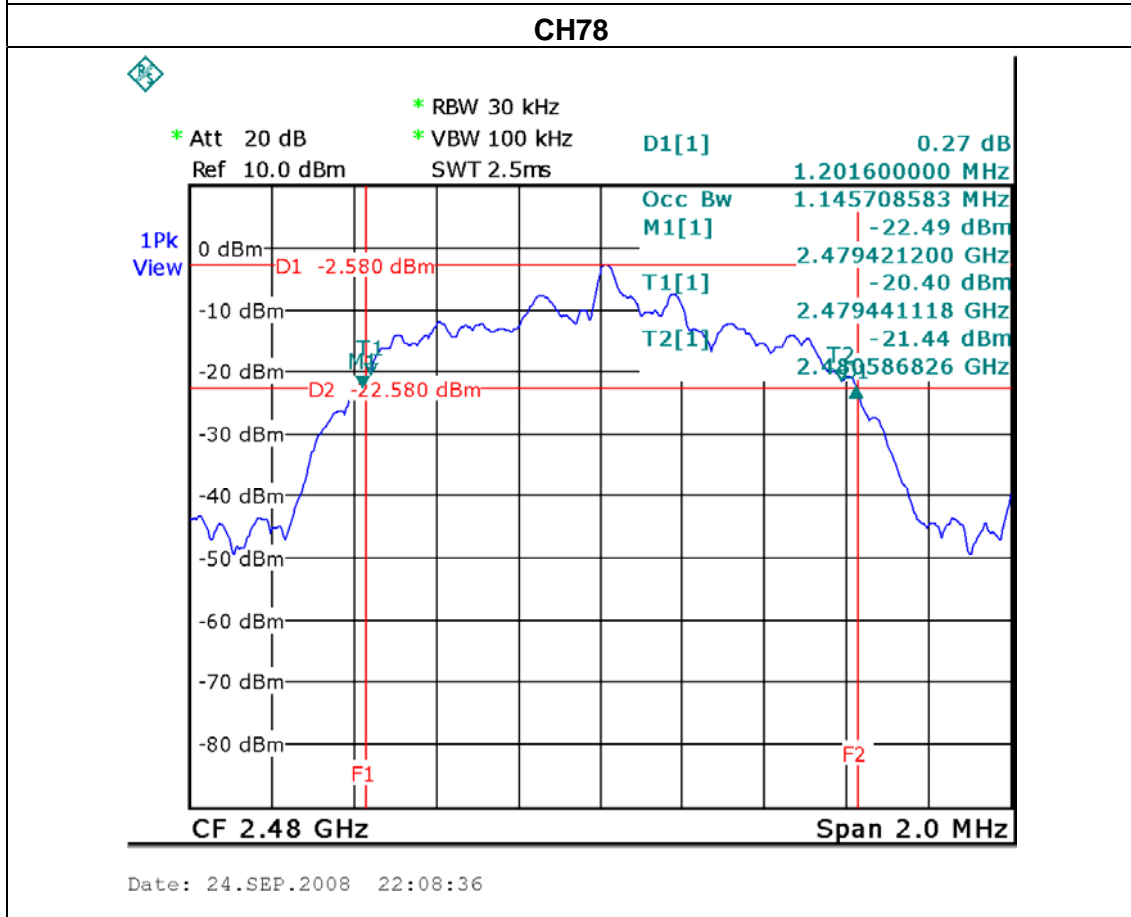
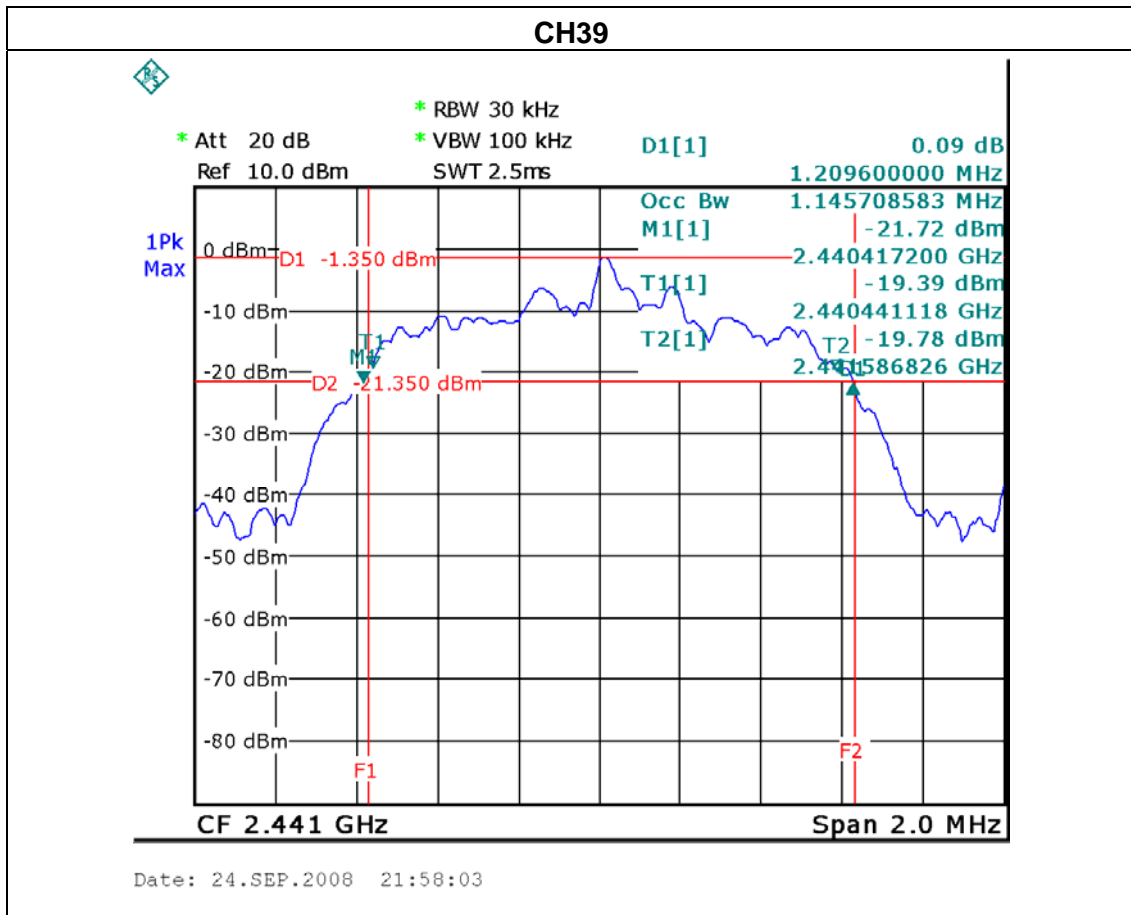

9. PEAK OUTPUT POWER TEST

9.1 APPLIED PROCEDURES / LIMIT

FCC Part15 (15.247) , Subpart C				
Section	Test Item	Limit	Frequency Range (MHz)	Result
15.247 (b)(1)	Peak Output Power	1 watt or 30dBm	2400-2483.5	PASS

9.1.1 MEASUREMENT INSTRUMENTS LIST AND SETTING

Item	Kind of Equipment	Manufacturer	Type No.	Serial No.	Calibrated until
1	Spectrum Analyzer	R&S	FSP_40	100129	Jan. 07, 2009

Remark: " N/A" denotes No Model Name , Serial No. or No Calibration specified.

9.1.2 TEST PROCEDURE

- a. The EUT was directly connected to the spectrum analyzer and antenna output port as show in the block diagram below,
- b. Spectrum Setting : RBW= 1MHz, VBW= 1MHz, Sweep time = Auto.

9.1.3 DEVIATION FROM STANDARD

No deviation.

9.1.4 TEST SETUP

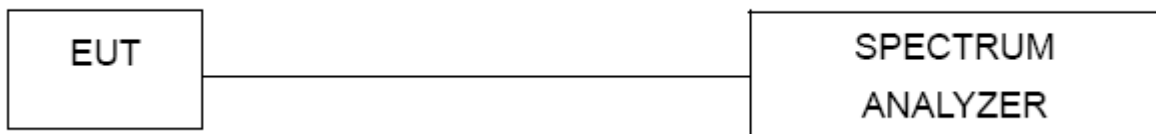

9.1.5 EUT OPERATION CONDITIONS

The EUT tested system was configured as the statements of 4.1.6 Unless otherwise a special operating condition is specified in the follows during the testing.

9.1.6 TEST RESULTS

EUT :	Bluetooth Headset	Model Name :	SK-BTH-015A
Temperature :	25 °C	Relative Humidity :	60%
Pressure :	1012 hPa	Test Voltage :	Li-ion Battery 3.7Vdc
Test Mode :	CH00/ CH39 /CH78 -1 Mbps		

Test Channel	Frequency (MHz)	Peak Output Power (dBm)	LIMIT (dBm)	LIMIT (W)
CH00	2402	-0.36	30	1
CH39	2441	-0.67	30	1
CH78	2480	-1.56	30	1

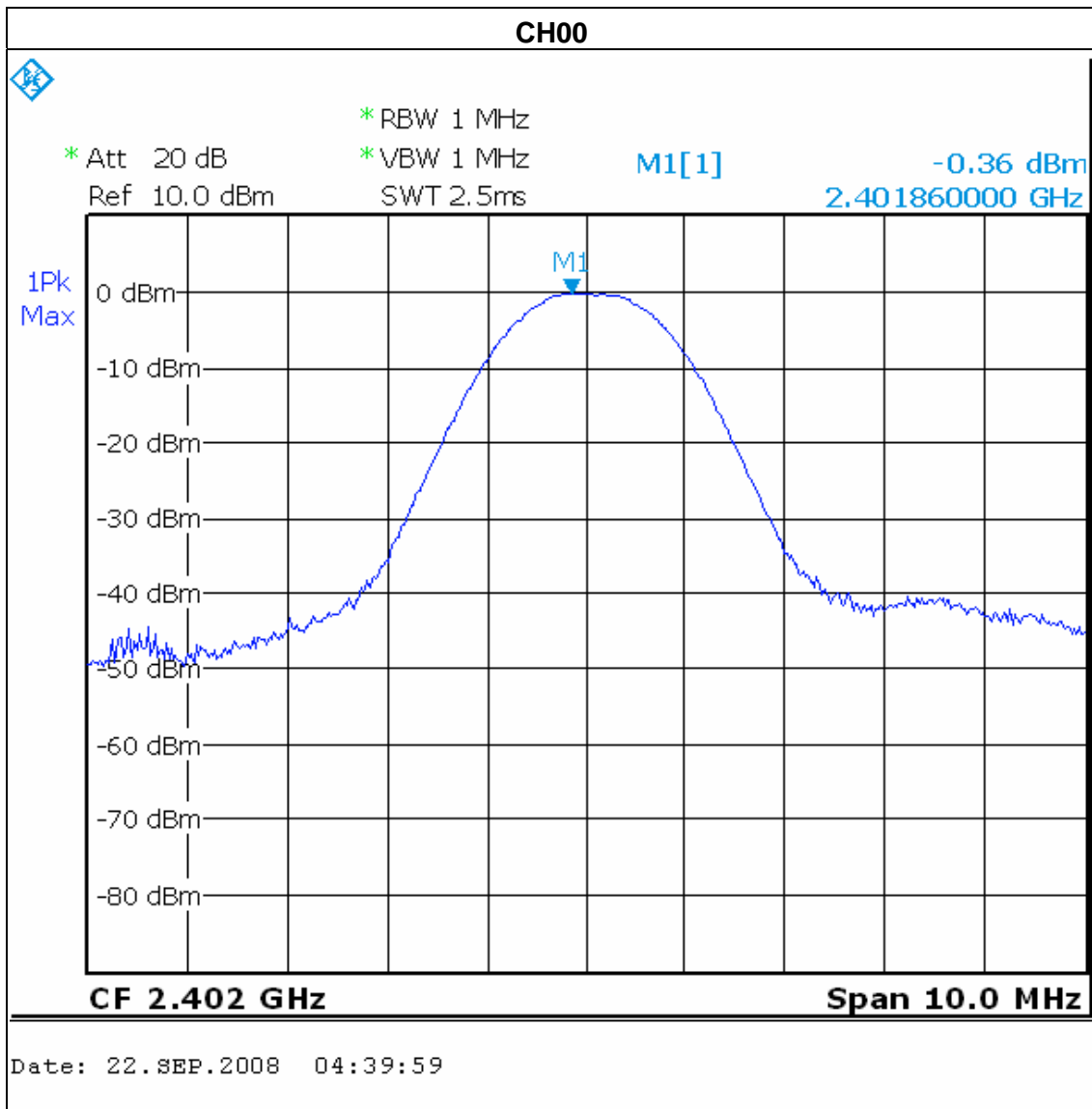

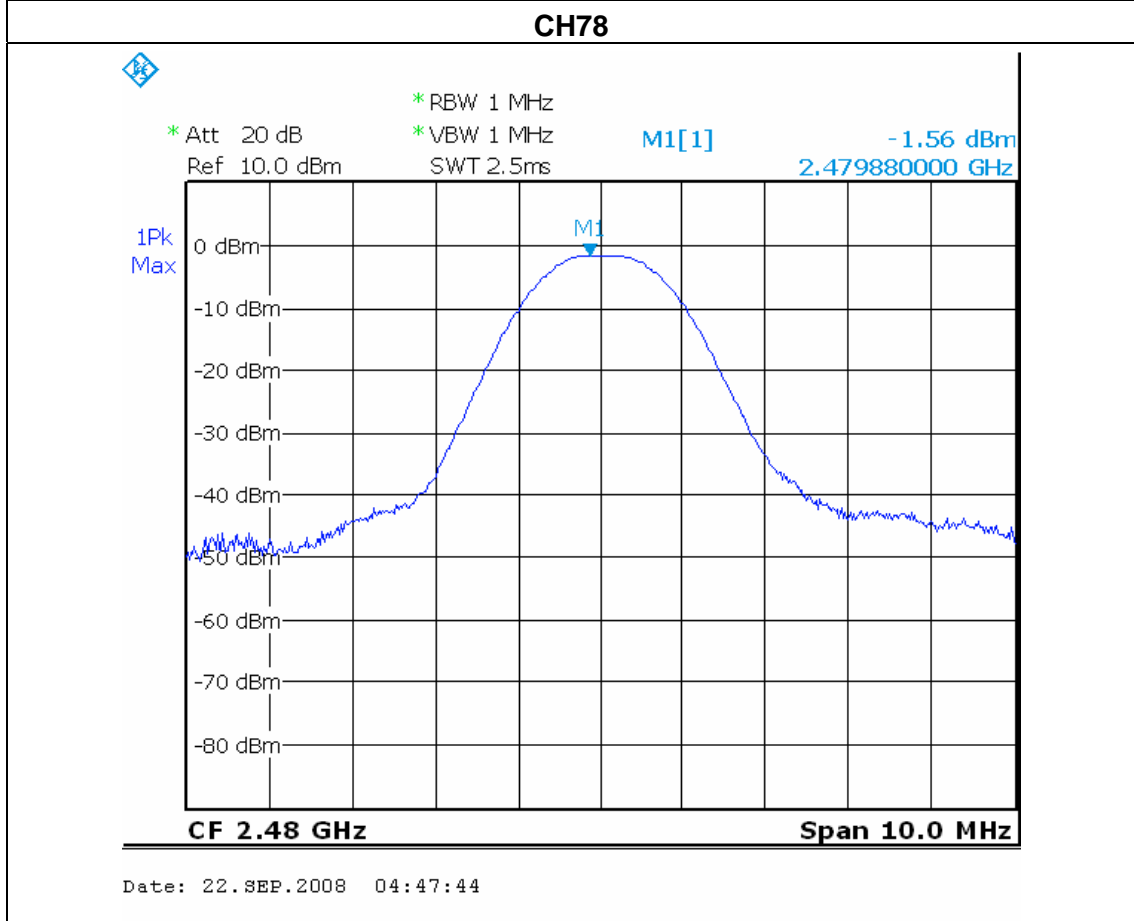
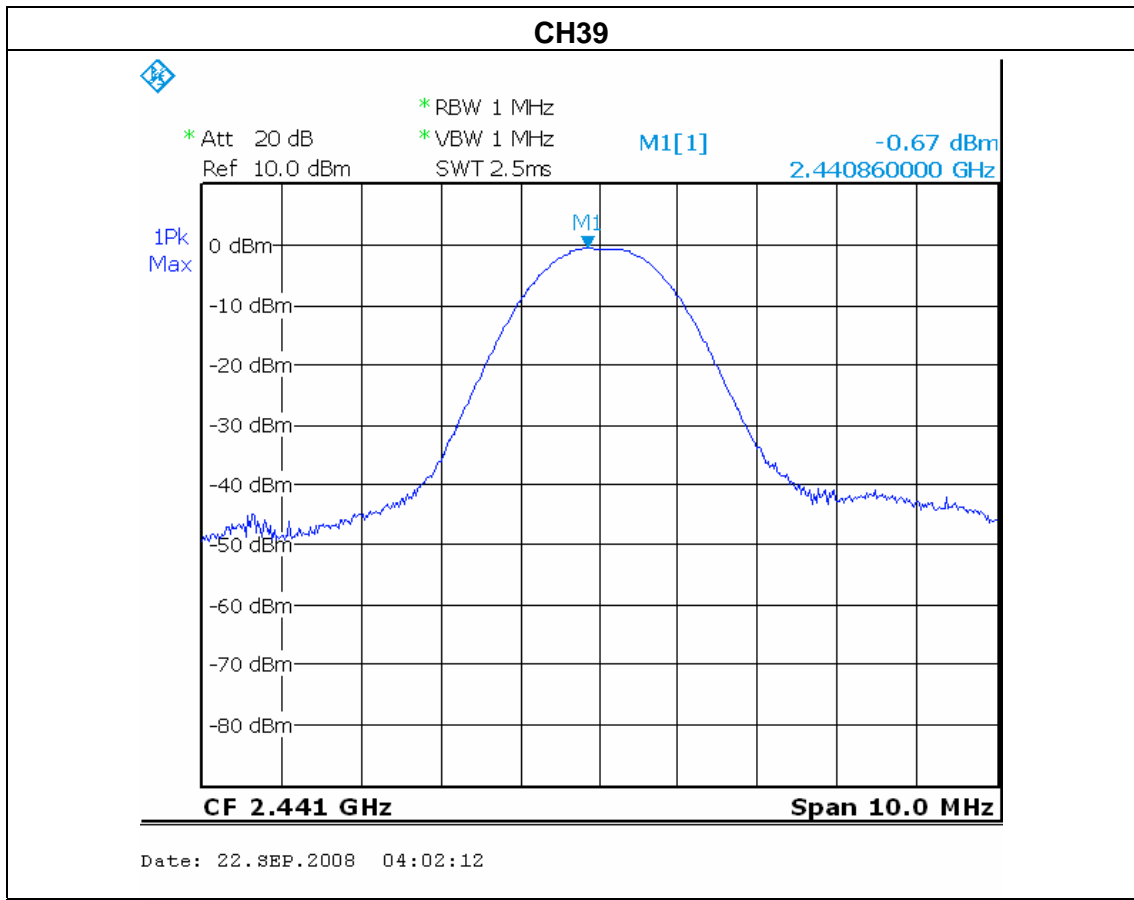

EUT :	Bluetooth Headset	Model Name :	SK-BTH-015A
Temperature :	25 °C	Relative Humidity :	60%
Pressure :	1012 hPa	Test Voltage :	Li-ion Battery 3.7Vdc
Test Mode :	CH00/ CH39 /CH78 -3 Mbps		

Test Channel	Frequency (MHz)	Peak Output Power (dBm)	LIMIT (dBm)	LIMIT (W)
CH00	2402	-0.11	30	1
CH39	2441	-0.74	30	1
CH78	2480	-2.15	30	1

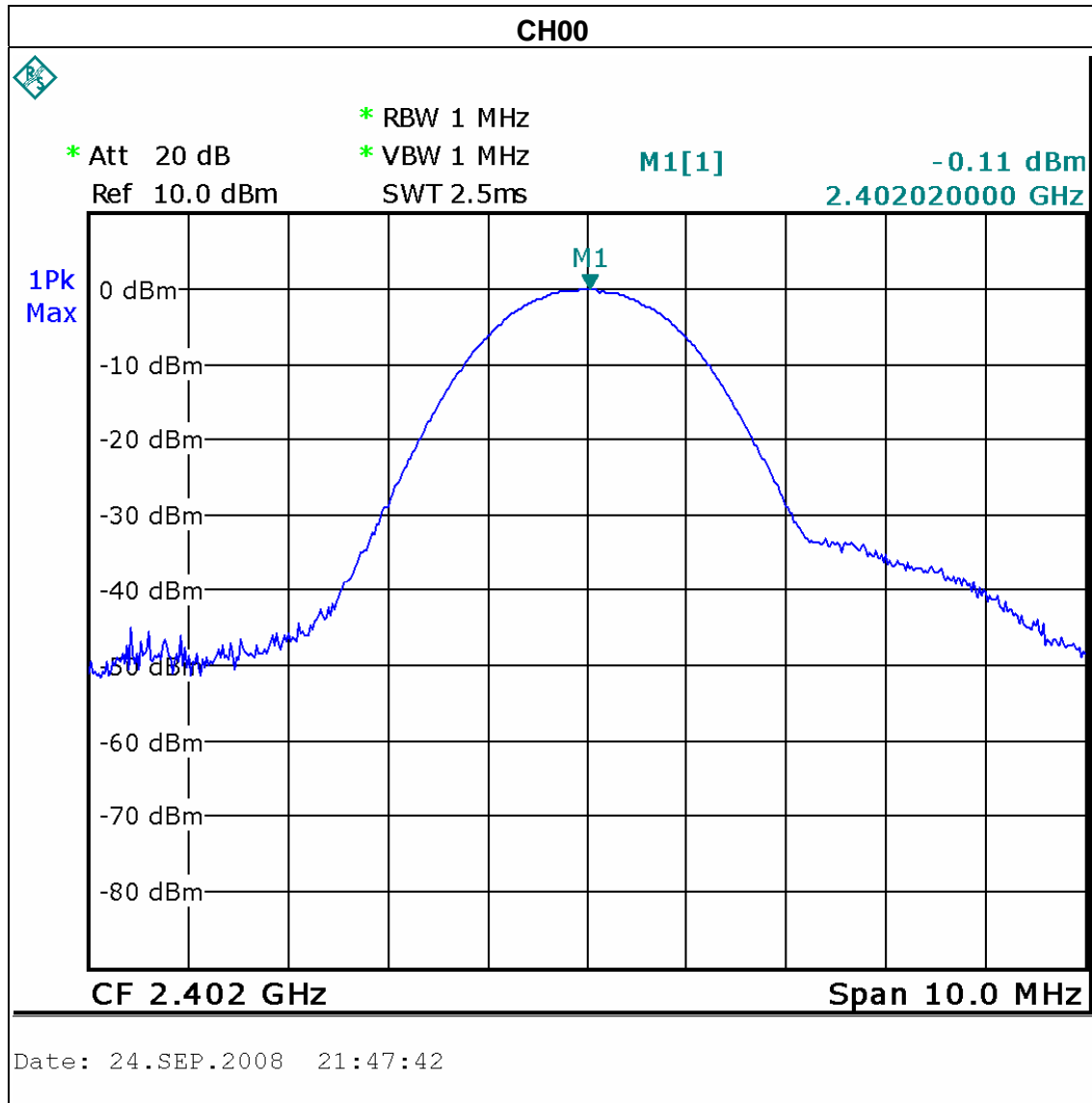

10. ANTENNA CONDUCTED SPURIOUS EMISSION

10.1 APPLIED PROCEDURES / LIMIT

20dBc in any 100 kHz bandwidth outside the operating frequency band. In case the emission fall within the restricted band specified on 15.205(a), then the 15.209(a) limit in the table below has to be followed.

Frequencies (MHz)	Field Strength (micorvolts/meter)	Measurement Distance (meters)
0.009~0.490	2400/F(KHz)	300
0.490~1.705	24000/F(KHz)	30
1.705~30.0	30	30
30~88	100	3
88~216	150	3
216~960	200	3
Above 960	500	3

10.1.1 MEASUREMENT INSTRUMENTS LIST AND SETTING

Item	Kind of Equipment	Manufacturer	Type No.	Serial No.	Calibrated until
1	Spectrum Analyzer	R&S	FSP_40	100129	Jan. 07, 2009

Remark: " N/A" denotes No Model Name , Serial No. or No Calibration specified.

The following table is the setting of the spectrum analyzer.

Spectrum Parameter	Setting
Attenuation	Auto
Span Frequency	100 MHz
RB / VB (emission in restricted band)	1MHz / 1MHz for Peak, 1 MHz / 10Hz for Average
RB / VB (other emission)	100 KHz /100 KHz for Peak

10.1.2 TEST PROCEDURE

- a. The EUT was directly connected to the spectrum analyzer and antenna output port as show in the block diagram below,
- b. Spectrum Setting : RBW= 100KHz, VBW=100KHz, Sweep time = Auto.

10.1.3 DEVIATION FROM STANDARD

No deviation.

10.1.4 TEST SETUP**10.1.5 EUT OPERATION CONDITIONS**

The EUT tested system was configured as the statements of 4.1.6 Unless otherwise a special operating condition is specified in the follows during the testing.

10.1.6 TEST RESULTS

EUT :	Bluetooth Headset	Model Name :	SK-BTH-015A
Temperature :	25 °C	Relative Humidity :	60%
Pressure :	1012 hPa	Test Voltage :	Li-ion Battery 3.7Vdc
Test Mode :	CH00 / CH78 -1Mbps		

The max. radio frequency power in any 100kHz bandwidth outside the frequency band		The max. radio frequency power in any 100 kHz bandwidth within the frequency band.	
FREQUENCY(MHz)	POWER(dBm)	FREQUENCY(MHz)	POWER(dBm)
2386.14	-58.71	2484.49	-49.53

Result

In any 100kHz bandwidth outside the frequency band, the radio frequency power is at least 20dB below that in the 100kHz bandwidth within the band that contains the highest level of the desired power.

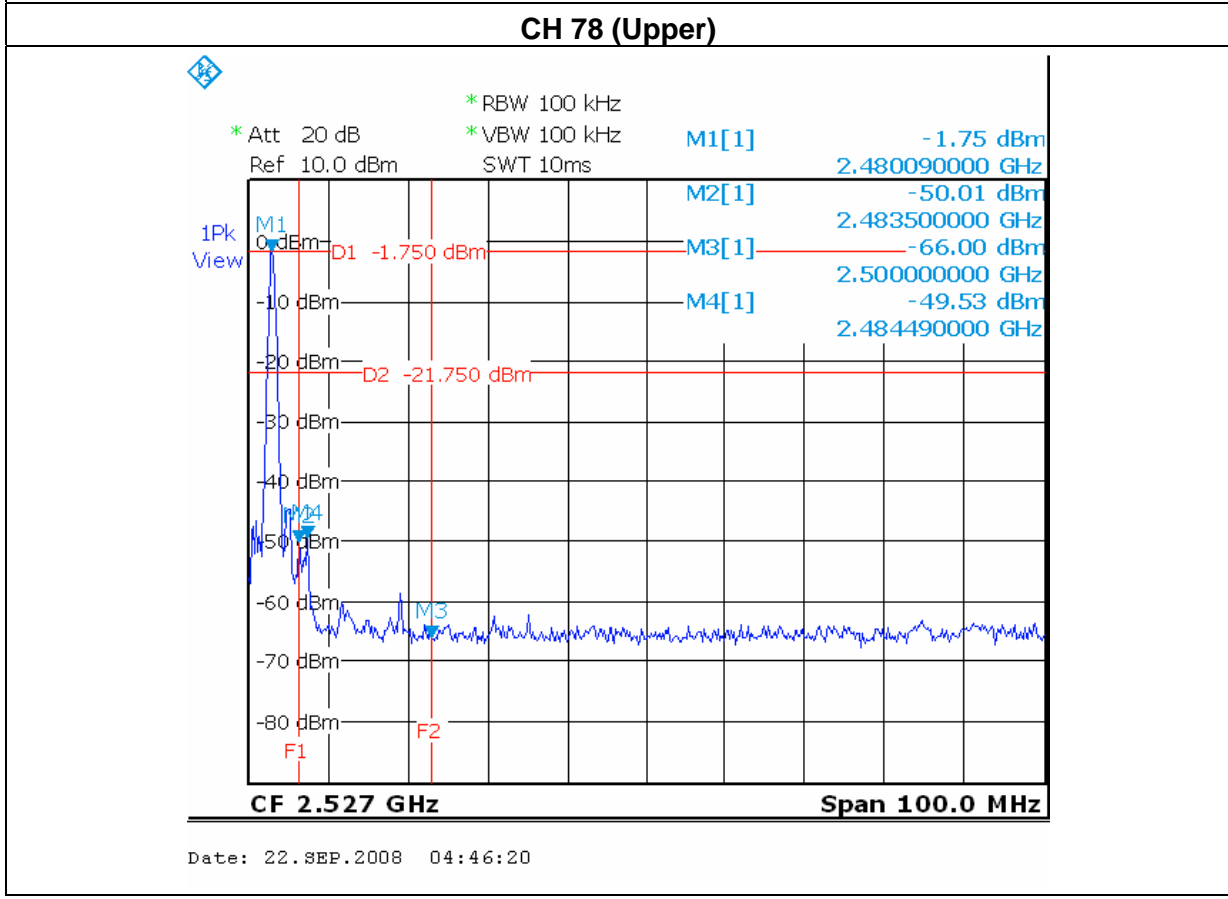
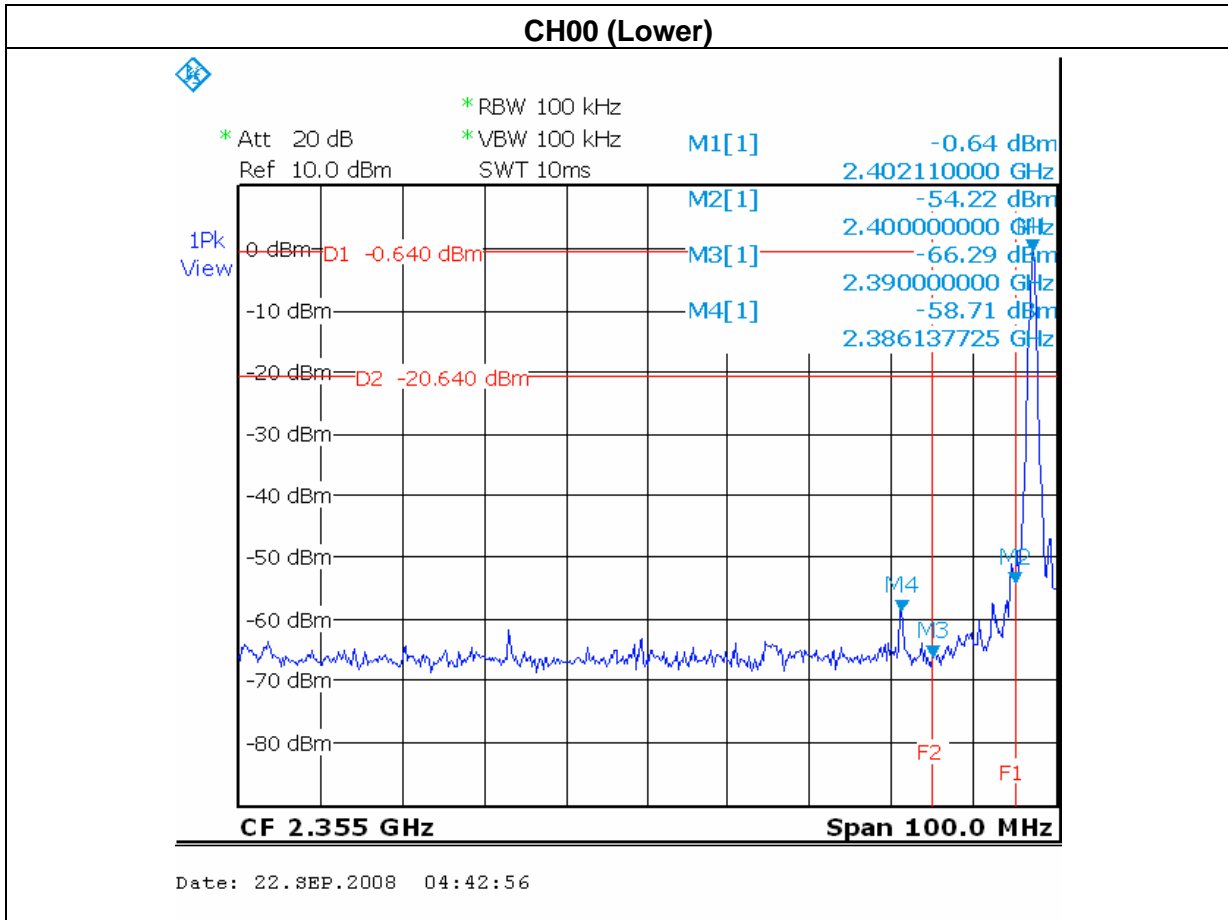

EUT :	Bluetooth Headset	Model Name :	SK-BTH-015A
Temperature :	25 °C	Relative Humidity :	60%
Pressure :	1012 hPa	Test Voltage :	Li-ion Battery 3.7Vdc
Test Mode :	CH00 / CH78 -3Mbps		

The max. radio frequency power in any 100kHz bandwidth outside the frequency band		The max. radio frequency power in any 100 kHz bandwidth within the frequency band.	
FREQUENCY(MHz)	POWER(dBm)	FREQUENCY(MHz)	POWER(dBm)
2386.14	-56.88	2483.50	-47.22

Result

In any 100kHz bandwidth outside the frequency band, the radio frequency power is at least 20dB below that in the 100kHz bandwidth within the band that contains the highest level of the desired power.

CH00 (Lower) -8-DPSK

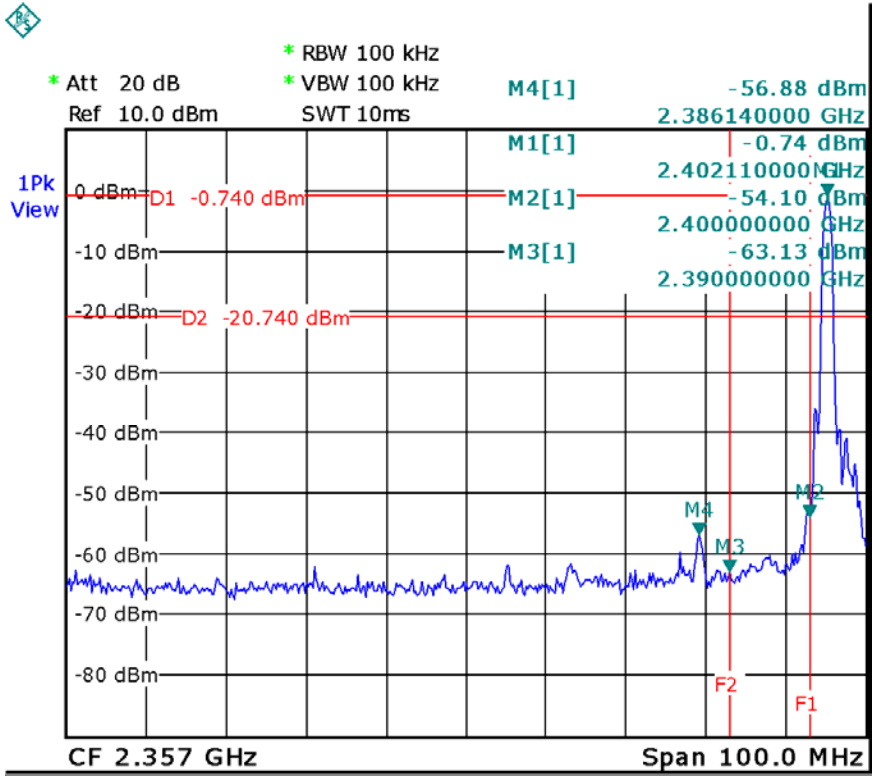

Date: 24.SEP.2008 21:43:38

CH 78 (Upper) -8-DPSK

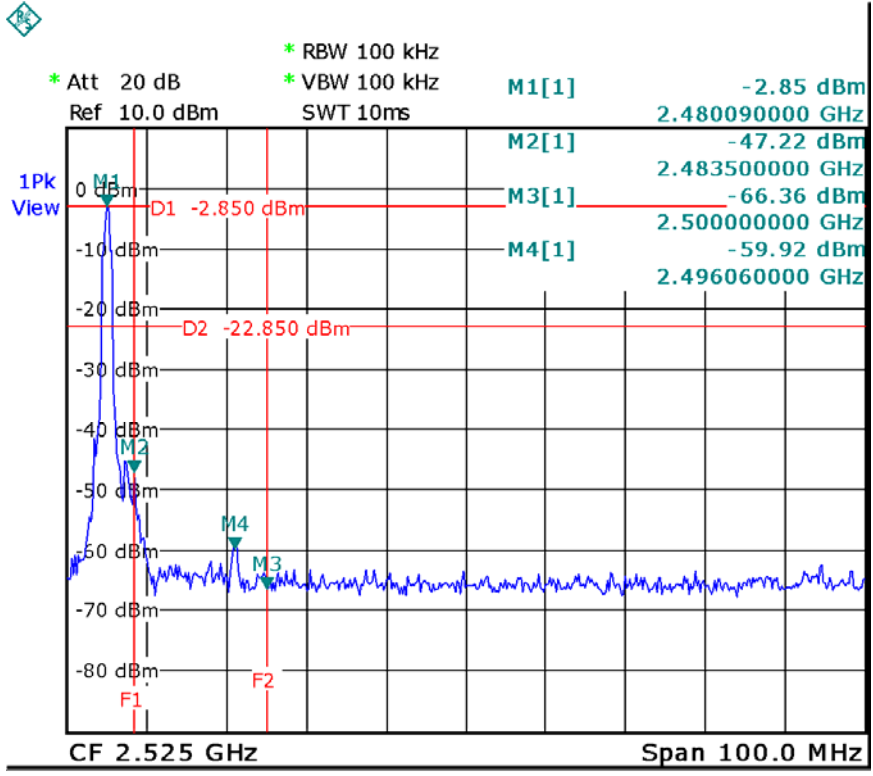

Date: 24.SEP.2008 22:12:17

11. RF EXPOSURE TEST

11.1 APPLIED PROCEDURES / LIMIT

These devices are not exempted from compliance does not exceed the Commission's RF exposure guidelines. Unless a device operates at substantially low power levels, with a low gain antenna(s), supporting information is generally needed to establish the various potential operating configurations and exposure conditions of a transmitter and its antenna(s) in order to determine compliance with the RF exposure guidelines.

In order to demonstrate compliance with MPE requirement (see Section 2.1091), the following information is typically needed:

Calculation that estimates the minimum separation distance (20 cm or more) between an antenna and persons required to satisfy power density limits defined for free space.

Antenna installation and device operating instructions for installers (professional/unskilled users), and the parties responsible for ensuring compliance with the RF exposure requirement. Any caution statements and/or warning labels that are necessary in order to comply with the exposure limits. Any other RF exposure related issues that may affect MPE compliance.

FCC 1.1310: The criteria listed in the following table shall be used to evaluate the environmental impact of human exposure to radio-frequency (RF) radiation as specified in 1.1307(b).

(A) Limits for Occupational / Controlled Exposure

Frequency Range (MHz)	Electric Field Strength (E) (V/m)	Magnetic Field Strength (H) (A/m)	Power Density (S) (mW/cm ²)	Averaging Time E ² , H ² or S (minutes)
0.3-3.0	614	1.63	(100)*	6
3.0-30	1842 / f	4.89 / f	(900 / f)*	6
30-300	61.4	0.163	1.0	6
300-1500			F/300	6
1500-100,000			5	6

(B) Limits for General Population / Uncontrolled Exposure

Frequency Range (MHz)	Electric Field Strength (E) (V/m)	Magnetic Field Strength (H) (A/m)	Power Density (S) (mW/cm ²)	Averaging Time E ² , H ² or S (minutes)
0.3-1.34	614	1.63	(100)*	30
1.34-30	824/f	2.19/f	(180/f)*	30
30-300	27.5	0.073	0.2	30
300-1500			F/1500	30
1500-100,000			1.0	30

Note: f = frequency in MHz ; *Plane-wave equivalent power density

11.1.1 MEASUREMENT INSTRUMENTS LIST

Item	Kind of Equipment	Manufacturer	Type No.	Serial No.	Calibrated until
1	Spectrum Analyzer	R&S	FSP_40	100129	Jan. 07, 2009

Remark: " N/A" denotes No Model Name , Serial No. or No Calibration specified.

11.1.2 MPE CALCULATION METHOD

Calculation Method of RF Safety Distance:

$$S = \frac{PG}{4\pi \cdot r^2} = \frac{EIRP}{4\pi \cdot r^2}$$

- P :power input to the antenna in mW
- EIRP :Equivalent(effective) isotropic radiated power.
- S :power density mW/ cm²
- G ;numeric gain of antenna relative to isotropic radiator
- R :distance to centre of radiation in cm

FCC radio frequency exposure limits may be exceeded at distances closer than r cm from the antenna of this device

$$r = \sqrt{\frac{PG}{4\pi S}} = \sqrt{\frac{EIRP}{4\pi S}}$$

Note:

1. s=1.0 mW /cm² for limits for General Population/Uncontrolled Exposures.
2. The time averaged power over 30 minutes will be equaled Output Power.
3. For portable device,the power limit is 60/f(in GHz) mW
4. For limit 60/f is equal:
 - 60/2.402=24.98 mW
 - 60/2.441=24.58 mW
 - 60/2.480=24.19 mW
5. The max.output power E.I.R.P is 1.8323 mW
So it is complied with the limit,SAR report is not required.

11.1.3 DEVIATION FROM STANDARD

No deviation.

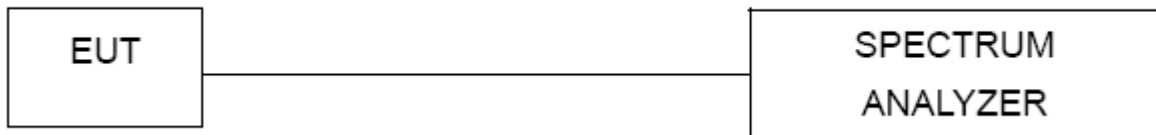
11.1.4 TEST SETUP**11.1.5 EUT OPERATION CONDITIONS**

The EUT tested system was configured as the statements of 4.1.6 Unless otherwise a special operating condition is specified in the follows during the testing.

12. EUT TEST PHOTO

**Conducted Measurement Photos
Normal Link with charge mode**



Radiated Measurement Photos

