



# FCC RF Test Report

**APPLICANT** : Doro AB  
**EQUIPMENT** : GSM/WCDMA/LTE Mobile Telephone  
**BRAND NAME** : doro  
**MODEL NAME** : DSB-0010  
**FCC ID** : WS5DSB0010  
**STANDARD** : 47 CFR Part 2, 27(M)  
**CLASSIFICATION** : PCS Licensed Transmitter Held to Ear (PCE)

The product testing was completed on Jul. 19, 2016. We, SPORTON INTERNATIONAL (KUNSHAN) INC., would like to declare that the tested sample has been evaluated in accordance with the test procedures given in ANSI / TIA / EIA-603-D-2010 and the testing has shown the tested sample to be in compliance with the applicable technical standards. The test results in this report apply exclusively to the tested model / sample. Without written approval of SPORTON INTERNATIONAL (KUNSHAN) INC., the test report shall not be reproduced except in full.

Reviewed by: Joseph Lin / Supervisor

Approved by: Jones Tsai / Manager



**SPORTON INTERNATIONAL (KUNSHAN) INC.**  
**No. 3-2, PingXiang Road, Kunshan, Jiangsu Province, P. R. China**



TABLE OF CONTENTS

REVISION HISTORY.....3
SUMMARY OF TEST RESULT .....4
1 GENERAL DESCRIPTION .....5
1.1 Applicant .....5
1.2 Manufacturer.....5
1.3 Product Feature of Equipment Under Test.....5
1.4 Product Specification subjective to this standard .....5
1.5 Modification of EUT .....6
1.6 Maximum Emission Designator, Frequency Tolerance, and EIRP Power .....6
1.7 Testing Location .....7
1.8 Applicable Standards.....7
2 TEST CONFIGURATION OF EQUIPMENT UNDER TEST .....8
2.1 Test Mode .....8
2.2 Connection Diagram of Test System.....9
2.3 Support Unit used in test configuration and system .....10
2.4 Measurement Results Explanation Example.....10
3 CONDUCTED TEST ITEMS .....12
3.1 Measuring Instruments .....12
3.2 Test Setup .....12
3.3 Test Result of Conducted Test .....12
3.4 Conducted Output Power .....13
3.5 Peak-to-Average Ratio .....14
3.6 99% Occupied Bandwidth and 26dB Bandwidth Measurement.....15
3.7 Conducted Band Edge .....16
3.8 Conducted Spurious Emission .....18
3.9 Frequency Stability .....19
4 RADIATED TEST ITEMS .....20
4.1 Measuring Instruments .....20
4.2 Test Setup .....20
4.3 Test Result of Radiated Test .....20
4.4 Effective Isotropic Radiated Power.....21
4.5 Radiated Spurious Emission .....23
5 LIST OF MEASURING EQUIPMENT .....25
6 UNCERTAINTY OF EVALUATION .....26
APPENDIX A. TEST RESULTS OF CONDUCTED TEST
APPENDIX B. TEST RESULTS OF RADIATED TEST
APPENDIX C. TEST SETUP PHOTOGRAPHS
APPENDIX D. PHOTOGRAPHS OF EUT



### REVISION HISTORY

REPORT NO.	VERSION	DESCRIPTION	ISSUED DATE
FG570906-04B	Rev. 01	Initial issue of report	Aug. 05, 2016



### SUMMARY OF TEST RESULT

Report Section	FCC Rule	Description	Limit	Result	Remark
3.4	§2.1046	Conducted Output Power	Reporting Only	PASS	-
3.5	N/A	Peak-to-Average Ratio	Reporting Only	PASS	-
3.6	§2.1049	99% Occupied Bandwidth and 26dB Bandwidth	Reporting Only	PASS	-
3.7	§2.1051 §27.53(m)(4)	Conducted Band Edge Measurement (Band 7)	§27.53(m)(4)	PASS	-
3.8	§2.1051 §27.53(m)(4)	Conducted Spurious Emission (Band 7)	$< 55+10\log_{10}(P[\text{Watts}])$	PASS	-
3.9	§2.1055 §27.54	Frequency Stability Temperature & Voltage	Within Authorized Band	PASS	-
4.4	§27.50(h)(2)	Equivalent Isotropic Radiated Power (Band 7)	EIRP < 2Watt	PASS	-
4.5	§2.1053 §27.53(m)(4)	Radiated Spurious Emission (Band 7)	$< 55+10\log_{10}(P[\text{Watts}])$	PASS	Under limit 14.35 dB at 7580.000 MHz



# 1 General Description

## 1.1 Applicant

Doro AB  
Magistratsvägen 10 SE-226 43 Lund Sweden

## 1.2 Manufacturer

BYD PRECISION MFR CO., LTD  
No.3001, Baohe Road, Baolong Industrial, Longgang, Shenzhen, 518116, P.R.China

## 1.3 Product Feature of Equipment Under Test

Product Feature	
Equipment	GSM/WCDMA/LTE Mobile Telephone
Brand Name	doro
Model Name	DSB-0010
FCC ID	WS5DSB0010
EUT supports Radios application	GSM/GPRS/EGPRS/WCDMA/HSPA/ HSPA+(16QAM is not supported)/DC-HSDPA/LTE/ WLAN 2.4GHz 802.11b/g/n HT20/ Bluetooth v3.0 + EDR/Bluetooth v4.1 LE
IMEI Code	Conducted: 351512080000861 Radiation: 351512080000630 EIRP: 351512080000671
HW Version	DIVA-V2.1
SW Version	DSB0010_EU_RET_02.16.00_USER_160705
EUT Stage	Identical Prototype

## 1.4 Product Specification subjective to this standard

Product Specification subjective to this standard	
Tx Frequency	LTE Band 7 : 2502.5 MHz ~ 2567.5 MHz
Rx Frequency	LTE Band 7 : 2622.5MHz ~ 2687.5 MHz
Bandwidth	LTE Band 7 : 5MHz/ 10MHz / 15MHz / 20MHz
Maximum Output Power to Antenna	LTE Band 7 : 22.49 dBm
Type of Modulation	QPSK / 16QAM



### 1.5 Modification of EUT

No modifications are made to the EUT during all test items.

### 1.6 Maximum Emission Designator, Frequency Tolerance, and EIRP Power

LTE Band 7 BW(MHz)	QPSK			16QAM		
	Emission Designator (99%OBW)	Frequency Tolerance (ppm)	Maximum EIRP(W)	Emission Designator (99%OBW)	Frequency Tolerance (ppm)	Maximum EIRP(W)
			AVG.			AVG.
5	4M51G7D	-	0.4093	4M51W7D	-	0.3673
10	9M07G7D	0.0022	0.4375	9M03W7D	-	0.4227
15	13M5G7D	-	0.3972	13M5W7D	-	0.4198
20	18M5G7D	-	0.3908	18M4W7D	-	0.4305



### 1.7 Testing Location

<b>Test Site</b>	SPORTON INTERNATIONAL (KUNSHAN) INC.		
<b>Test Site Location</b>	No. 3-2, PingXiang Road, Kunshan, Jiangsu Province, P. R. China TEL: +86-0512-5790-0158 FAX: +86-0512-5790-0958		
<b>Test Site No.</b>	<b>Sporton Site No.</b>		<b>FCC Registration No.</b>
	TH01-KS	03CH02-KS	418269

**Note:** The test site complies with ANSI C63.4 2014 requirement.

### 1.8 Applicable Standards

According to the specifications of the manufacturer, the EUT must comply with the requirements of the following standards:

- 47 CFR Part 2, 27(M)
- ANSI / TIA / EIA-603-D-2010
- FCC KDB 971168 D01 Power Meas. License Digital Systems v02r02

**Remark:**

1. All test items were verified and recorded according to the standards and without any deviation during the test.
2. This EUT has also been tested and complied with the requirements of FCC Part 15, Subpart B, recorded in a separate test report.



## 2 Test Configuration of Equipment Under Test

### 2.1 Test Mode

Antenna port conducted and radiated test items listed below are performed according to KDB 971168 D01 Power Meas. License Digital Systems v02r02 with maximum output power.

Radiated measurements are performed by rotating the EUT in three different orthogonal test planes to find the maximum emission.

Test Items	Band	Bandwidth (MHz)						Modulation		RB #			Test Channel		
		1.4	3	5	10	15	20	QPSK	16QAM	1	Half	Full	L	M	H
Max. Output Power	7	-	-	v	v	v	v	v	v	v	v	v	v	v	v
Peak-to-Average Ratio	7	-	-				v	v	v	v		v	v	v	v
26dB and 99% Bandwidth	7	-	-	v	v	v	v	v	v			v	v	v	v
Conducted Band Edge	7	-	-	v	v	v	v	v	v	v		v	v		v
Conducted Spurious Emission	7	-	-	v	v	v	v	v	v	v	v		v	v	v
Frequency Stability	7	-	-		v			v				v		v	
E.I.R.P.	7	-	-	v	v	v	v	v	v	v	v		v	v	v
Radiated Spurious Emission	7	-	-	v	v	v	v	v		v				v	
Note	<ol style="list-style-type: none"> <li>The mark "v" means that this configuration is chosen for testing</li> <li>The mark "-" means that this bandwidth is not supported.</li> <li>The device is investigated from 30MHz to 10 times of fundamental signal for radiated spurious emission test under different RB size/offset and modulations in exploratory test. Subsequently, only the worst case emissions are reported.</li> </ol>														



## 2.2 Connection Diagram of Test System

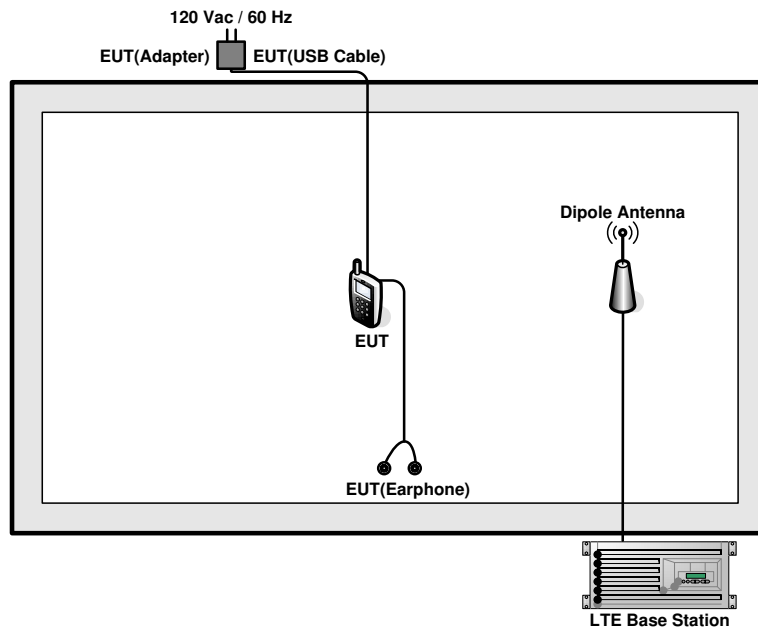



### 2.3 Support Unit used in test configuration and system

Item	Equipment	Trade Name	Model No.	FCC ID	Data Cable	Power Cord
1.	DC Power Supply	GW INSTEK	GPS-3030D	N/A	N/A	Unshielded, 1.8 m
2.	LTE Base Station	Anritsu	MT8820C	N/A	N/A	Unshielded, 1.8 m

### 2.4 Measurement Results Explanation Example

For all conducted test items:

The offset level is set in the spectrum analyzer to compensate the RF cable loss between EUT conducted output port and spectrum analyzer. With the offset compensation, the spectrum analyzer reading level is exactly the EUT RF output level.

The spectrum analyzer offset is derived from RF cable loss.

*Offset = RF cable loss + attenuator factor.*

Following shows an offset computation example with cable loss 5.0 dB.

Example :

$$\begin{aligned} \text{Offset(dB)} &= \text{RF cable loss(dB)}. \\ &= 5.0 \text{ (dB)} \end{aligned}$$



## 2.5 Frequency List of Low/Middle/High Channels

LTE Band 7 Channel and Frequency List				
BW [MHz]	Channel/Frequency(MHz)	Lowest	Middle	Highest
20	Channel	20850	21100	21350
	Frequency	2510	2535	2560
15	Channel	20825	21100	21375
	Frequency	2507.5	2535	2562.5
10	Channel	20800	21100	21400
	Frequency	2505	2535	2565
5	Channel	20775	21100	21425
	Frequency	2502.5	2535	2567.5

### 3 Conducted Test Items

#### 3.1 Measuring Instruments

See list of measuring instruments of this test report.

#### 3.2 Test Setup

##### 3.2.1 Conducted Output Power

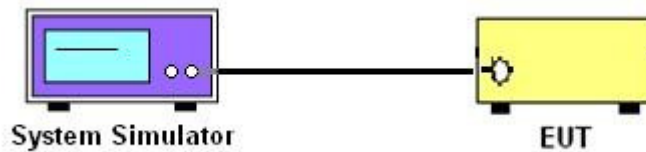

##### 3.2.2 Peak-to-Average Ratio, Occupied Bandwidth ,Conducted Band-Edge and Conducted Spurious Emission

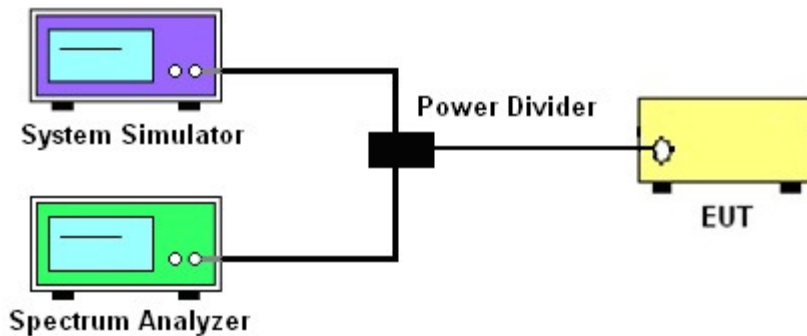

##### 3.2.3 Frequency Stability

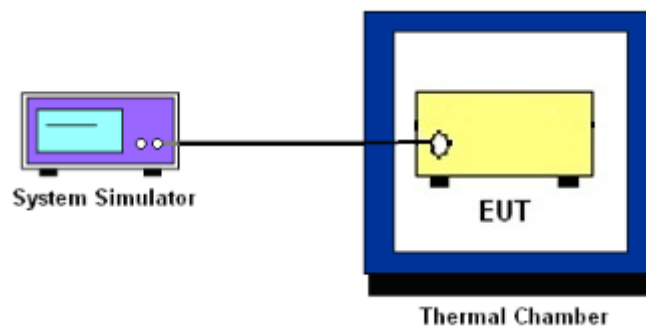

### 3.3 Test Result of Conducted Test

Please refer to Appendix A.



## **3.4 Conducted Output Power**

### **3.4.1 Description of the Conducted Output Power Measurement**

A system simulator was used to establish communication with the EUT. Its parameters were set to force the EUT transmitting at maximum output power. The measured power in the radio frequency on the transmitter output terminals shall be reported.

### **3.4.2 Test Procedures**

1. The transmitter output port was connected to the system simulator.
2. Set EUT at maximum power through the system simulator.
3. Select lowest, middle, and highest channels for each band and different modulation.
4. Measure and record the power level from the system simulator.



## **3.5 Peak-to-Average Ratio**

### **3.5.1 Description of the PAR Measurement**

Power Complementary Cumulative Distribution Function (CCDF) curves provide a means for characterizing the power peaks of a digitally modulated signal on a statistical basis. A CCDF curve depicts the probability of the peak signal amplitude exceeding the average power level. Most contemporary measurement instrumentation include the capability to produce CCDF curves for an input signal provided that the instrument's resolution bandwidth can be set wide enough to accommodate the entire input signal bandwidth. In measuring transmissions in this band using an average power technique, the peak-to-average ratio (PAR) of the transmission may not exceed 13 dB.

### **3.5.2 Test Procedures**

1. The testing follows FCC KDB 971168 v02r02 Section 5.7.1.
2. The EUT was connected to spectrum and system simulator via a power divider.
3. Set the CCDF (Complementary Cumulative Distribution Function) option in spectrum analyzer.
4. The highest RF powers were measured and recorded the maximum PAPR level associated with a probability of 0.1 %.
5. Record the deviation as Peak to Average Ratio.



## **3.6 99% Occupied Bandwidth and 26dB Bandwidth Measurement**

### **3.6.1 Description of 99% Occupied Bandwidth and 26dB Bandwidth Measurement**

The occupied bandwidth is the width of a frequency band such that, below the lower and above the upper frequency limits, the mean powers emitted are each equal to a specified percentage 0.5% of the total mean transmitted power.

The 26 dB emission bandwidth is defined as the frequency range between two points, one above and one below the carrier frequency, at which the spectral density of the emission is attenuated 26 dB below the maximum in-band spectral density of the modulated signal. Spectral density (power per unit bandwidth) is to be measured with a detector of resolution bandwidth equal to approximately 1.0% of the emission bandwidth.

### **3.6.2 Test Procedures**

1. The testing follows FCC KDB 971168 v02r02 Section 4.2.
2. The EUT was connected to spectrum analyzer and system simulator via a power divider.



### 3.7 Conducted Band Edge

#### 3.7.1 Description of Conducted Band Edge Measurement

27.53(m)(4)

For mobile digital stations, the attenuation factor shall be not less than  $40 + 10 \log (P)$  dB on all frequencies between the channel edge and 5 megahertz from the channel edge,  $43 + 10 \log (P)$  dB on all frequencies between 5 megahertz and X megahertz from the channel edge, and  $55 + 10 \log (P)$  dB on all frequencies more than X megahertz from the channel edge, where X is the greater of 6 megahertz or the actual emission bandwidth as defined in paragraph (m)(6) of this section. In addition, the attenuation factor shall not be less that  $43 + 10 \log (P)$  dB on all frequencies between 2490.5 MHz and 2496 MHz and  $55 + 10 \log (P)$  dB at or below 2490.5 MHz. Mobile Satellite Service licensees operating on frequencies below 2495 MHz may also submit a documented interference complaint against BRS licensees operating on channel BRS Channel 1 on the same terms and conditions as adjacent channel BRS or EBS licensees.





### 3.7.2 Test Procedures

1. The testing follows FCC KDB 971168 v02r02 Section 6.0.
2. The EUT was connected to spectrum analyzer and system simulator via a power divider.
3. The band edges of low and high channels for the highest RF powers were measured. Set RBW  $\geq 1\%$  EBW in the 1MHz band immediately outside and adjacent to the band edge.
4. Set spectrum analyzer with RMS detector.
5. The RF fundamental frequency should be excluded against the limit line in the operating frequency band.
6. The limit line is derived from  $43 + 10\log(P)$ dB below the transmitter power P(Watts)  
 $= P(W) - [43 + 10\log(P)]$  (dB)  
 $= [30 + 10\log(P)]$  (dBm) -  $[43 + 10\log(P)]$  (dB)  
 $= -13$ dBm.  
<For Band 7>
  - 1) The limit line is derived from  $40 + 10\log(P)$ dB below the transmitter power P(Watts)  
 $= P(W) - [40 + 10\log(P)]$  (dB)  
 $= [30 + 10\log(P)]$  (dBm) -  $[40 + 10\log(P)]$  (dB)  
 $= -10$ dBm.
  - 2) The limit line is derived from  $43 + 10\log(P)$ dB below the transmitter power P(Watts)  
 $= P(W) - [43 + 10\log(P)]$  (dB)  
 $= [30 + 10\log(P)]$  (dBm) -  $[43 + 10\log(P)]$  (dB)  
 $= -13$ dBm.
  - 3) The limit line is derived from  $55 + 10\log(P)$ dB below the transmitter power P(Watts)  
 $= P(W) - [55 + 10\log(P)]$  (dB)  
 $= [30 + 10\log(P)]$  (dBm) -  $[55 + 10\log(P)]$  (dB)  
 $= -25$ dBm.



### 3.8 Conducted Spurious Emission

#### 3.8.1 Description of Conducted Spurious Emission Measurement

The power of any emission outside of the authorized operating frequency ranges must be lower than the transmitter power (P) by a factor of at least  $43 + 10 \log (P)$  dB.

For Band 7:

The power of any emission outside of the authorized operating frequency ranges must be lower than the transmitter power (P) by a factor of at least  $55 + 10 \log (P)$  dB.

It is measured by means of a calibrated spectrum analyzer and scanned from 30 MHz up to a frequency including its 10<sup>th</sup> harmonic.

#### 3.8.2 Test Procedures

1. The testing follows FCC KDB 971168 v02r02 Section 6.0.
2. The EUT was connected to spectrum analyzer and system simulator via a power divider.
3. The RF output of EUT was connected to the spectrum analyzer by RF cable and attenuator. The path loss was compensated to the results for each measurement.
4. The middle channel for the highest RF power within the transmitting frequency was measured.
5. The conducted spurious emission for the whole frequency range was taken.
6. Make the measurement with the spectrum analyzer's RBW = 1MHz, VBW = 3MHz, taking the record of maximum spurious emission.
7. The RF fundamental frequency should be excluded against the limit line in the operating frequency band.
8. The limit line is derived from  $43 + 10\log(P)$ dB below the transmitter power P(Watts)  
=  $P(W) - [43 + 10\log(P)]$  (dB)  
=  $[30 + 10\log(P)]$  (dBm) -  $[43 + 10\log(P)]$  (dB)  
= -13dBm.
9. For Band 7  
The limit line is derived from  $55 + 10\log(P)$ dB below the transmitter power P(Watts)  
=  $P(W) - [55 + 10\log(P)]$  (dB)  
=  $[30 + 10\log(P)]$  (dBm) -  $[55 + 10\log(P)]$  (dB)  
= -25dBm



### **3.9 Frequency Stability**

#### **3.9.1 Description of Frequency Stability Measurement**

The frequency stability shall be measured by variation of ambient temperature and variation of primary supply voltage to ensure that the fundamental emission stays within the authorized frequency block. The frequency stability of the transmitter shall be maintained within  $\pm 0.00025\%$  ( $\pm 2.5\text{ppm}$ ) of the center frequency.

#### **3.9.2 Test Procedures for Temperature Variation**

1. The EUT was set up in the thermal chamber and connected with the system simulator.
2. With power OFF, the temperature was decreased to  $-30^{\circ}\text{C}$  and the EUT was stabilized before testing. Power was applied and the maximum change in frequency was recorded within one minute.
3. With power OFF, the temperature was raised in  $10^{\circ}\text{C}$  step up to  $50^{\circ}\text{C}$ . The EUT was stabilized at each step for at least half an hour. Power was applied and the maximum frequency change was recorded within one minute.

#### **3.9.3 Test Procedures for Voltage Variation**

1. The testing follows FCC KDB 971168 v02r02 Section 9.0.
2. The EUT was placed in a temperature chamber at  $25\pm 5^{\circ}\text{C}$  and connected with the system simulator.
3. The power supply voltage to the EUT was varied from 85% to 115% of the nominal value measured at the input to the EUT.
4. The variation in frequency was measured for the worst case.

## 4 Radiated Test Items

### 4.1 Measuring Instruments

See list of measuring instruments of this test report.

### 4.2 Test Setup

#### 4.2.1 For radiated test from 30MHz to 1GHz

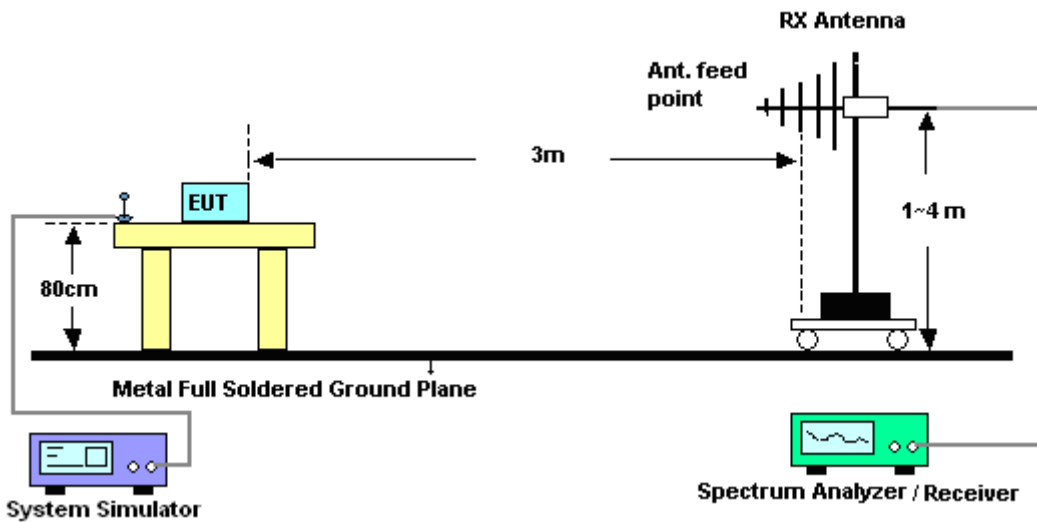

#### 4.2.2 For radiated test above 1GHz

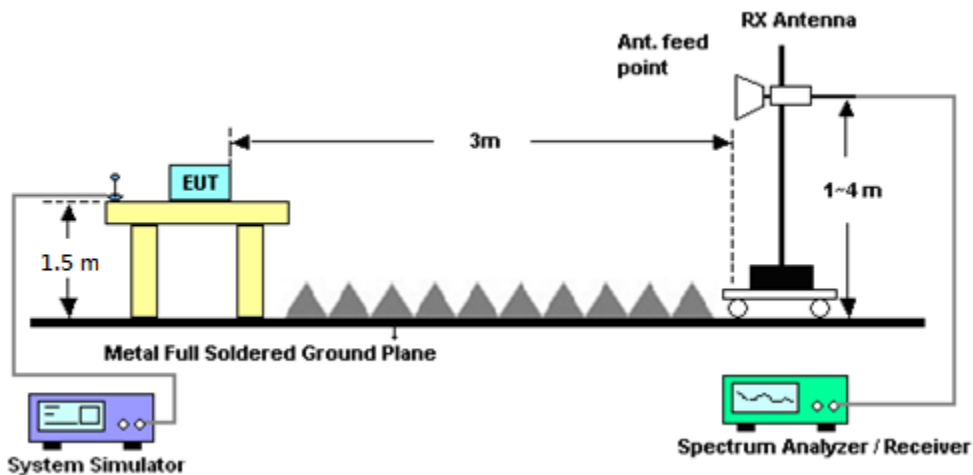

### 4.3 Test Result of Radiated Test

Please refer to Appendix B.



## 4.4 Effective Isotropic Radiated Power

### 4.4.1 Description of the EIRP Measurement

Equivalent isotropic radiated power output measurements by substitution method according to ANSI / TIA / EIA-603-D-2010, and the spectrum analyzer configuration follows KDB 971168 D01 Power Meas. License Digital Systems v02r02. Mobile and portable (hand-held) stations operating are limited to average EIRP of 2 watts with LTE band 7.

### 4.4.2 Test Procedures

1. The EUT was placed on a non-conductive rotating platform 0.8 meters high in a semi-anechoic chamber. The radiated emission at the fundamental frequency was measured at 3 m with a test antenna and a spectrum analyzer with RMS detector per section 5. of KDB 971168 D01.
2. During the measurement, the system simulator parameters were set to force the EUT transmitting at maximum output power. The maximum emission was recorded from analyzer power level (LVL) from the 360 degrees rotation of the turntable and the test antenna raised and lowered over a range from 1 to 4 meters in both horizontally and vertically polarized orientations.
3. Effective Isotropic Radiated Power (EIRP) was measured by substitution method according to TIA/EIA-603-D. The EUT was replaced by the substitution antenna at same location, and then a known power from S.G. was applied into the dipole antenna through a Tx cable, and then recorded the maximum Analyzer reading through raised and lowered the test antenna. The correction factor (in dB) = S.G. - Tx Cable loss + Substitution antenna gain - Analyzer reading. Then the EUT's EIRP was calculated with the correction factor,  $EIRP = LVL + \text{Correction factor}$  and  $ERP = EIRP - 2.15$ . Take the record of the output power at substitution antenna.



	LTE Average					
LTE BW	1.4M	3M	5M	10M	15M	20M
Span	3MHz	6MHz	10MHz	20MHz	30MHz	40MHz
RBW	30kHz	100kHz	100kHz	300kHz	300kHz	300kHz
VBW	100kHz	300kHz	300kHz	1MHz	1MHz	1MHz
Detector	RMS	RMS	RMS	RMS	RMS	RMS
Trace	Average	Average	Average	Average	Average	Average
Average Type	Power	Power	Power	Power	Power	Power
Sweep Count	100	100	100	100	100	100



## **4.5 Radiated Spurious Emission**

### **4.5.1 Description of Radiated Spurious Emission**

The radiated spurious emission was measured by substitution method according to ANSI / TIA / EIA-603-D-2010. The power of any emission outside of the authorized operating frequency ranges must be attenuated below the transmitter power (P) by a factor of at least  $43 + 10 \log (P)$  dB.

For Band 7

The power of any emission outside of the authorized operating frequency ranges must be attenuated below the transmitter power (P) by a factor of at least  $55 + 10 \log (P)$  dB.

The spectrum is scanned from 30 MHz up to a frequency including its 10th harmonic.



#### 4.5.2 Test Procedures

1. The testing follows FCC KDB 971168 v02r02 Section 5.8 and ANSI / TIA-603-D-2010 Section 2.2.12.
2. The EUT was placed on a turntable with 0.8 meter for frequency below 1GHz and 1.5 meter for frequency above 1GHz respectively above ground.
3. The EUT was set 3 meters from the receiving antenna, which was mounted on the antenna tower.
4. The table was rotated 360 degrees to determine the position of the highest spurious emission.
5. The height of the receiving antenna is varied between one meter and four meters to search the maximum spurious emission for both horizontal and vertical polarizations.
6. Make the measurement with the spectrum analyzer's RBW = 1MHz, VBW = 3MHz, taking the record of maximum spurious emission.
7. A horn antenna was substituted in place of the EUT and was driven by a signal generator.
8. Tune the output power of signal generator to the same emission level with EUT maximum spurious emission.
9. Taking the record of output power at antenna port.
10. Repeat step 7 to step 8 for another polarization.
11. The RF fundamental frequency should be excluded against the limit line in the operating frequency band.

The limit line is derived from  $43 + 10\log(P)$ dB below the transmitter power P(Watts)  
=  $P(W) - [43 + 10\log(P)]$  (dB)  
=  $[30 + 10\log(P)]$  (dBm) -  $[43 + 10\log(P)]$  (dB)  
= -13dBm.

For Band 7:

The limit line is derived from  $55 + 10\log(P)$ dB below the transmitter power P(Watts)  
=  $P(W) - [55 + 10\log(P)]$  (dB)  
=  $[30 + 10\log(P)]$  (dBm) -  $[55 + 10\log(P)]$  (dB)  
= -25dBm

12. EIRP (dBm) = S.G. Power – Tx Cable Loss + Tx Antenna Gain
13. ERP (dBm) = EIRP - 2.15





## 5 List of Measuring Equipment

Instrument	Manufacturer	Model No.	Serial No.	Characteristics	Calibration Date	Test Date	Due Date	Remark
Spectrum Analyzer	R&S	FSV30	101338	9kHz~30GHz	May 04, 2015	Aug. 30, 2015	May 03, 2016	Conducted (TH01-KS)
Thermal Chamber	Ten Billion	TTC-B3S	TBN-960502	-40~+150°C	Oct. 25, 2014	Aug. 30, 2015	Oct. 24, 2015	Conducted (TH01-KS)
EMI Test Receiver	R&S	ESR7	101403	9kHz~7GHz; Max 30dBm	Sep. 10, 2015	Jul. 19, 2016	Sep. 09, 2016	Radiation (03CH02-KS)
EXA Spectrum Analyzer	Keysight	N9010A	MY5515020	10Hz~44GHz; Max 30dB	Apr. 22, 2016	Jul. 19, 2016	Apr. 21, 2017	Radiation (03CH02-KS)
Bilog Antenna	TeseQ	CBL6112D	37879	30MHz~2GHz	Sep. 12, 2015	Jul. 19, 2016	Sep. 11, 2016	Radiation (03CH02-KS)
Double Ridge Horn Antenna	ETS-Lindgren	3117	75957	1GHz~18GHz	Nov. 07, 2015	Jul. 19, 2016	Nov. 06, 2016	Radiation (03CH02-KS)
SHF-EHF Horn	com-power	AH-840	101070	18GHz~40GHz	Oct. 10, 2015	Jul. 19, 2016	Oct. 09, 2016	Radiation (03CH02-KS)
Amplifier	com-power	PA-103A	161069	1kHz~1000MHz / 32 dB	Apr. 22, 2016	Jul. 19, 2016	Apr. 21, 2017	Radiation (03CH02-KS)
High Gain Amplifier	MITEQ	AMF-7D-00101 800-30-10P	1865802	1GHz~18GHz	Jan. 20, 2016	Jul. 19, 2016	Jan. 19, 2017	Radiation (03CH02-KS)
Amplifier	Agilent	8449B	3008A02384	1~26.5GHz Gain 30dB	Oct. 24, 2015	Jul. 19, 2016	Oct. 23, 2016	Radiation (03CH02-KS)
Amplifier	MITEQ	TTA1840-35-H G	1887435	18GHz~40GHz	Jan. 20, 2016	Jul. 19, 2016	Jan. 19, 2017	Radiation (03CH02-KS)
AC Power Source	Chroma	61601	6160100024 73	N/A	NCR	Jul. 19, 2016	NCR	Radiation (03CH02-KS)
Turn Table	MF	MF7802	N/A	0~360 degree	NCR	Jul. 19, 2016	NCR	Radiation (03CH02-KS)
Antenna Mast	MF	MF7802	N/A	1 m~4 m	NCR	Jul. 19, 2016	NCR	Radiation (03CH02-KS)



## 6 Uncertainty of Evaluation

### Uncertainty of Radiated Emission Measurement (30 MHz ~ 1000 MHz)

Measuring Uncertainty for a Level of Confidence of 95% ( $U = 2Uc(y)$ )	5.1dB
---	-------

### Uncertainty of Radiated Emission Measurement (1GHz ~ 18GHz)

Measuring Uncertainty for a Level of Confidence of 95% ( $U = 2Uc(y)$ )	4.5dB
---	-------

### Uncertainty of Radiated Emission Measurement (18GHz ~ 40GHz)

Measuring Uncertainty for a Level of Confidence of 95% ( $U = 2Uc(y)$ )	5.1dB
---	-------



### Appendix A. Test Results of Conducted Test

#### Conducted Output Power(Average power)

LTE Band 7 Maximum Average Power [dBm]						
BW [MHz]	RB Size	RB Offset	Mod	Lowest	Middle	Highest
5	1	0	QPSK	22.38	22.38	22.35
5	1	12		22.40	22.44	22.42
5	1	24		22.14	22.22	22.22
5	12	0		21.44	21.36	21.42
5	12	6		21.18	21.28	21.40
5	12	11		21.18	21.29	21.30
5	25	0		21.34	21.34	21.43
5	1	0	16-QAM	21.70	21.70	21.93
5	1	12		21.47	21.55	21.58
5	1	24		21.37	21.56	21.51
5	12	0		20.38	20.26	20.33
5	12	6		20.26	20.26	20.43
5	12	11		20.26	20.19	20.34
5	25	0		20.26	20.33	20.41
10	1	0	QPSK	22.34	21.93	22.15
10	1	24		22.15	22.48	22.31
10	1	49		22.17	22.45	22.09
10	25	0		21.27	21.40	21.31
10	25	12		21.18	21.40	21.39
10	25	24		21.21	21.29	21.41
10	50	0		21.24	21.28	21.42
10	1	0	16-QAM	21.28	21.88	21.48
10	1	24		21.10	21.94	21.59
10	1	49		21.05	21.53	21.02
10	25	0		20.36	20.48	20.50
10	25	12		20.38	20.49	20.43
10	25	24		20.18	20.43	20.47
10	50	0		20.29	20.44	20.38



LTE Band 7 Maximum Average Power [dBm]						
BW [MHz]	RB Size	RB Offset	Mod	Lowest	Middle	Highest
15	1	0	QPSK	22.48	22.45	22.49
15	1	37		22.28	22.49	22.41
15	1	74		22.33	22.35	22.30
15	36	0		21.38	21.45	21.45
15	36	18		21.37	21.40	21.32
15	36	37		21.29	21.39	21.39
15	75	0		21.39	21.49	21.48
15	1	0	16-QAM	21.89	21.96	21.78
15	1	37		21.59	21.68	21.60
15	1	74		21.64	21.34	21.66
15	36	0		20.36	20.48	20.39
15	36	18		20.38	20.30	20.38
15	36	37		20.35	20.40	20.36
15	75	0		20.45	20.40	20.41
20	1	0	QPSK	22.32	22.39	22.36
20	1	49		22.30	22.33	22.30
20	1	99		21.88	22.22	22.20
20	50	0		21.20	21.38	21.35
20	50	24		21.12	21.31	21.25
20	50	49		21.05	21.21	21.32
20	100	0		21.13	21.28	21.27
20	1	0	16-QAM	21.48	21.86	21.69
20	1	49		21.31	21.46	21.70
20	1	99		21.24	21.47	21.36
20	50	0		20.22	20.38	20.33
20	50	24		20.14	20.24	20.22
20	50	49		20.17	20.25	20.24
20	100	0		20.14	20.39	20.26



**Peak-to-Average Ratio**

Mode	LTE Band 7 / 20MHz				
Mod.	QPSK		16QAM		Limit: 13dB
RB Size	1RB	Full RB	1RB	RB Size	Result
Lowest CH	3.25	4.2	4.23	5.1	PASS
Middle CH	3.45	4.23	4.93	5.04	
Highest CH	3.86	4.43	4.72	5.51	



LTE Band 7 / 20MHz / QPSK

Lowest Channel / 1RB

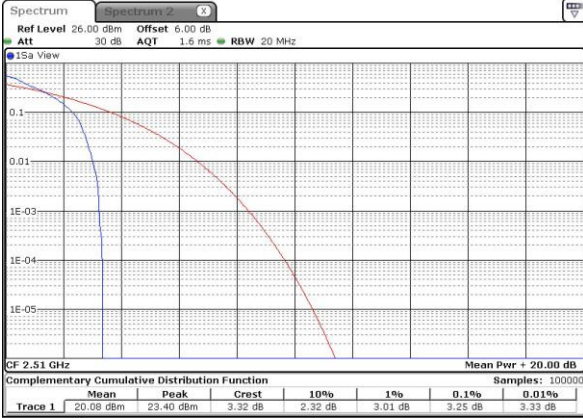

Date: 31 AUG 2015 01:16:05

Lowest Channel / Full RB

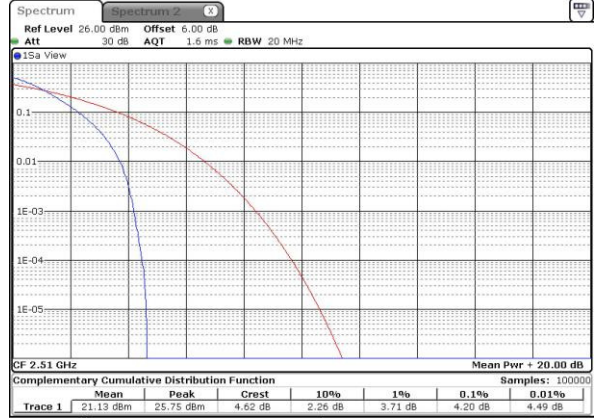

Date: 31 AUG 2015 01:16:16

Middle Channel / 1RB

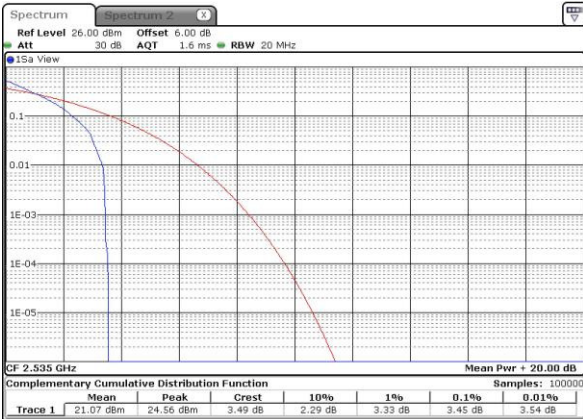

Date: 31 AUG 2015 01:16:37

Middle Channel / Full RB

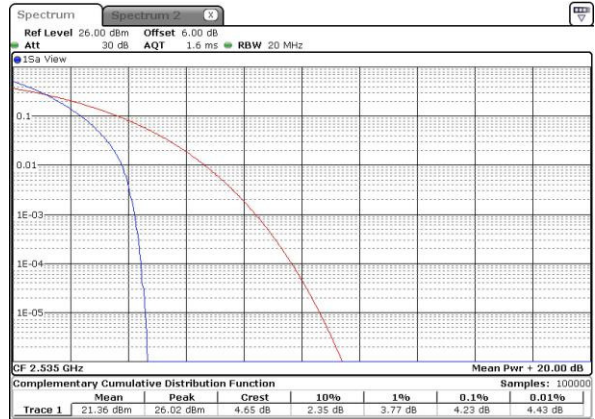

Date: 31 AUG 2015 01:17:32

Highest Channel / 1RB

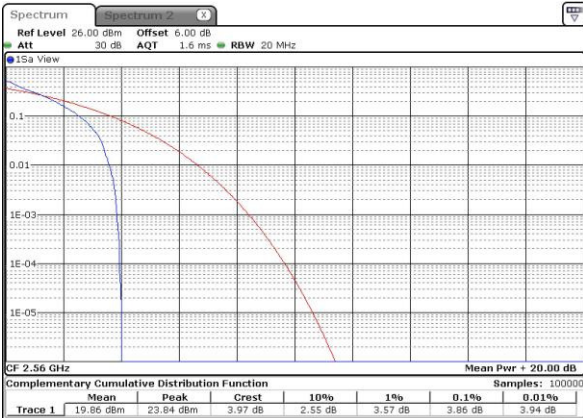

Date: 31 AUG 2015 01:17:45

Highest Channel / Full RB

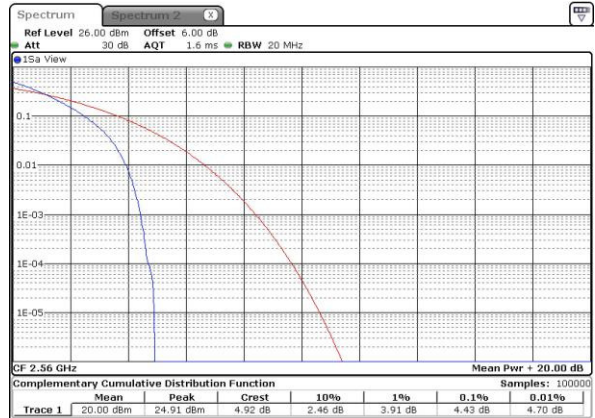

Date: 31 AUG 2015 01:17:57



LTE Band 7 / 20MHz / 16QAM

Lowest Channel / 1RB



Date: 31 AUG 2015 01:05:27

Lowest Channel / Full RB



Date: 31 AUG 2015 01:11:49

Middle Channel / 1RB



Date: 31 AUG 2015 01:12:01

Middle Channel / Full RB



Date: 31 AUG 2015 01:12:12

Highest Channel / 1RB



Date: 31 AUG 2015 01:14:28

Highest Channel / Full RB

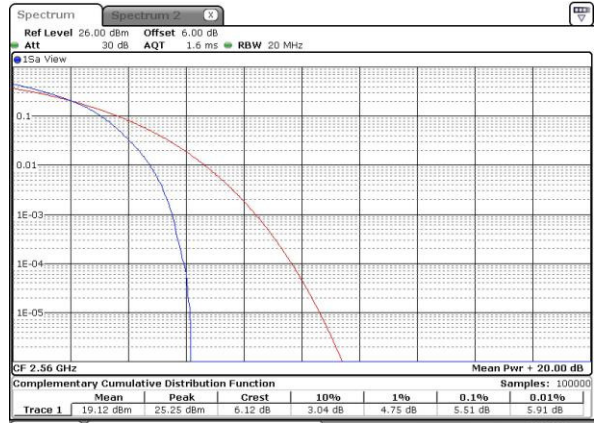

Date: 31 AUG 2015 01:27:21



**26dB Bandwidth**

Mode	LTE Band 7 : 26dB BW(MHz)											
	1.4MHz		3MHz		5MHz		10MHz		15MHz		20MHz	
BW	QPSK	16QAM	QPSK	16QAM	QPSK	16QAM	QPSK	16QAM	QPSK	16QAM	QPSK	16QAM
Mod.	QPSK	16QAM	QPSK	16QAM	QPSK	16QAM	QPSK	16QAM	QPSK	16QAM	QPSK	16QAM
Lowest CH	-	-	-	-	5.08	5.06	10.09	10.03	14.66	14.72	20.38	20.38
Middle CH	-	-	-	-	5.08	5.04	10.09	10.03	14.75	14.75	20.42	20.26
Highest CH	-	-	-	-	5.05	5.06	10.07	9.95	14.63	14.75	20.38	20.18





LTE Band 7

Lowest Channel / 5MHz / QPSK

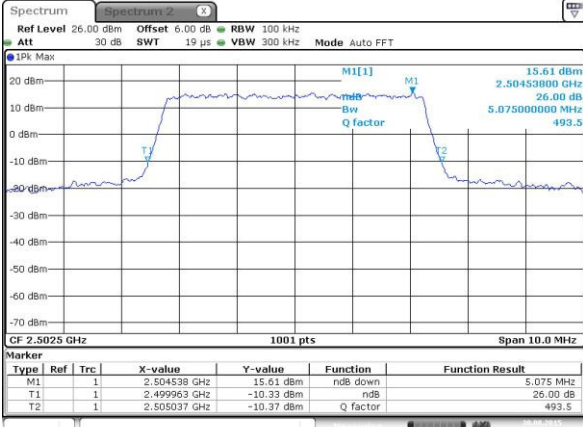

Date: 30 AUG 2015 22:21:54

Lowest Channel / 5MHz / 16QAM

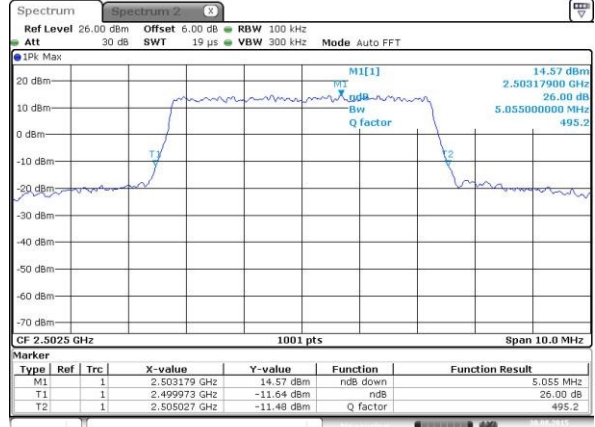

Date: 30 AUG 2015 22:22:06

Middle Channel / 5MHz / QPSK

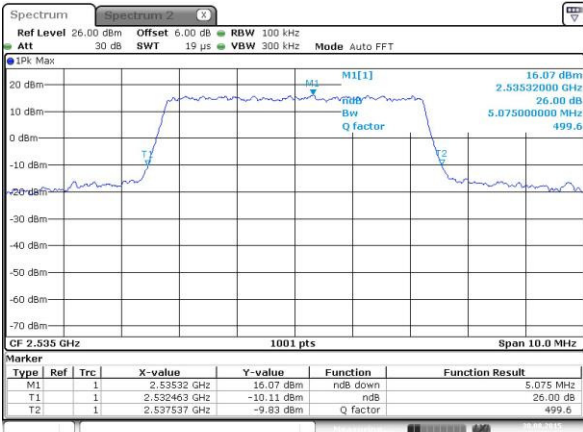

Date: 30 AUG 2015 22:29:34

Middle Channel / 5MHz / 16QAM

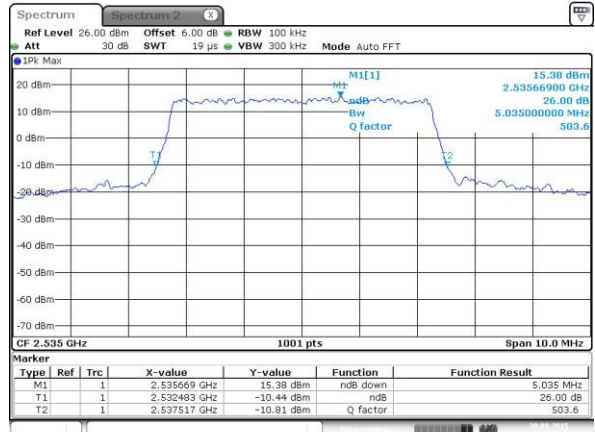

Date: 30 AUG 2015 22:29:46

Highest Channel / 5MHz / QPSK

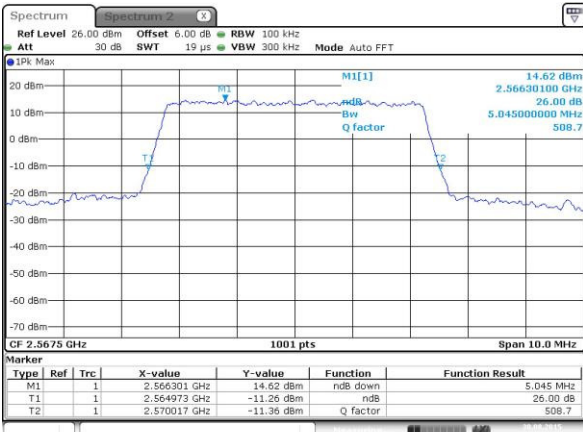

Date: 30 AUG 2015 22:32:39

Highest Channel / 5MHz / 16QAM

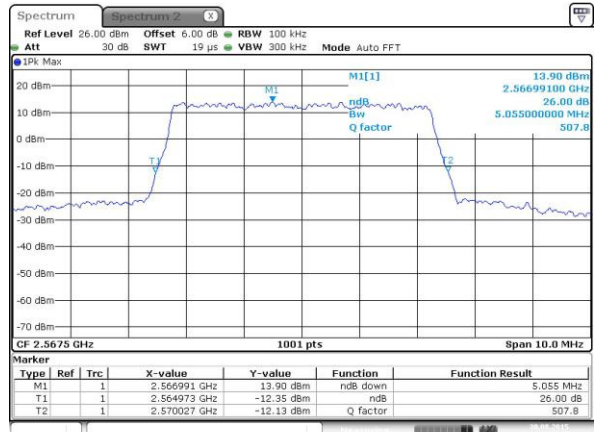

Date: 30 AUG 2015 22:32:52



LTE Band 7

Lowest Channel / 10MHz / QPSK

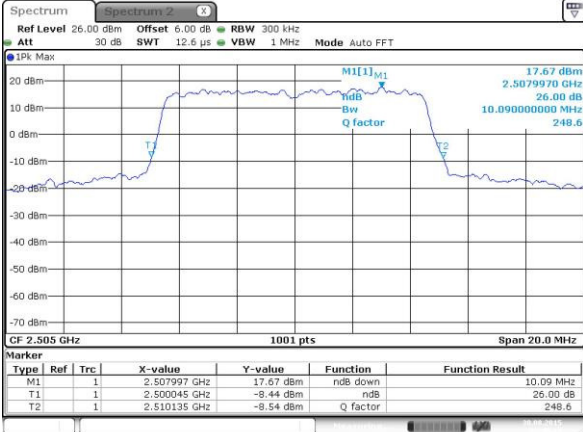

Date: 30 AUG 2015 22:40:19

Lowest Channel / 10MHz / 16QAM

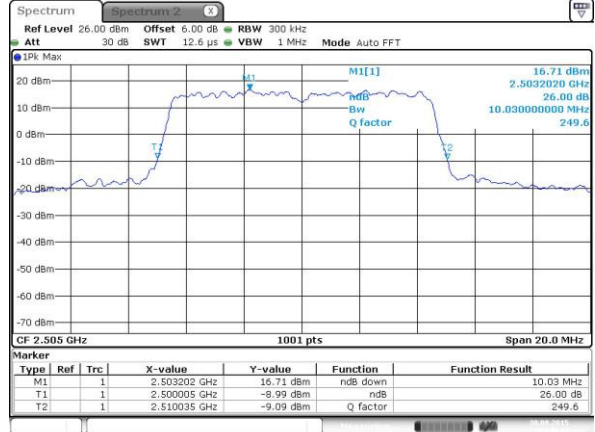

Date: 30 AUG 2015 22:40:32

Middle Channel / 10MHz / QPSK

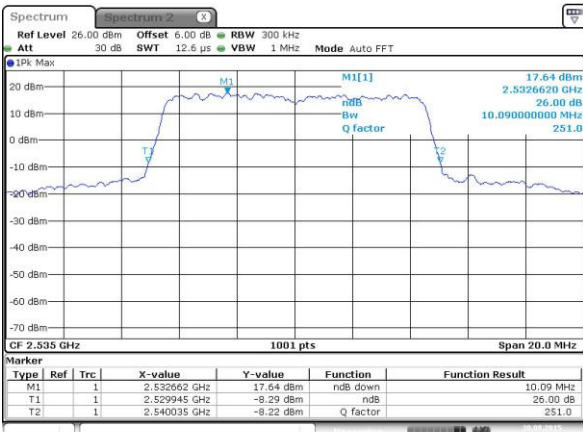

Date: 30 AUG 2015 22:47:59

Middle Channel / 10MHz / 16QAM

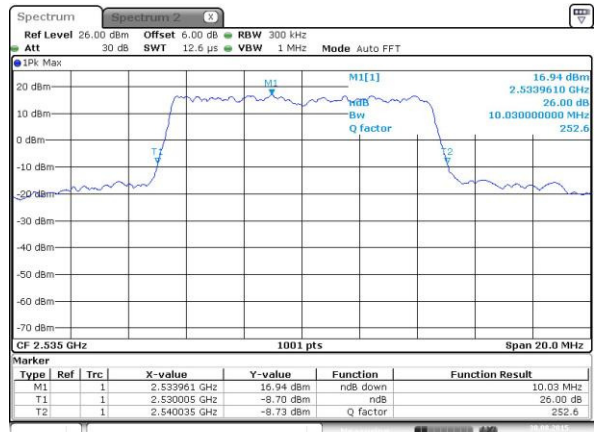

Date: 30 AUG 2015 22:48:12

Highest Channel / 10MHz / QPSK

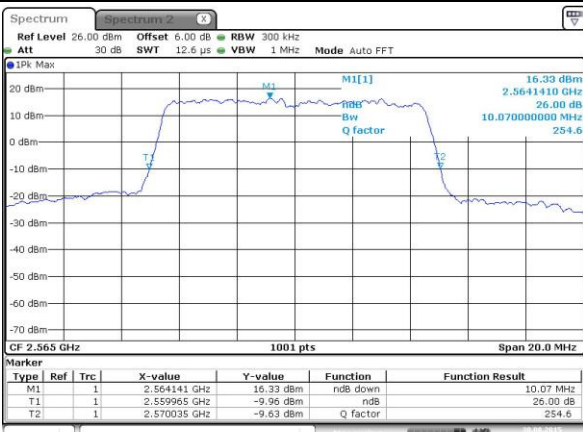

Date: 30 AUG 2015 22:51:05

Highest Channel / 10MHz / 16QAM

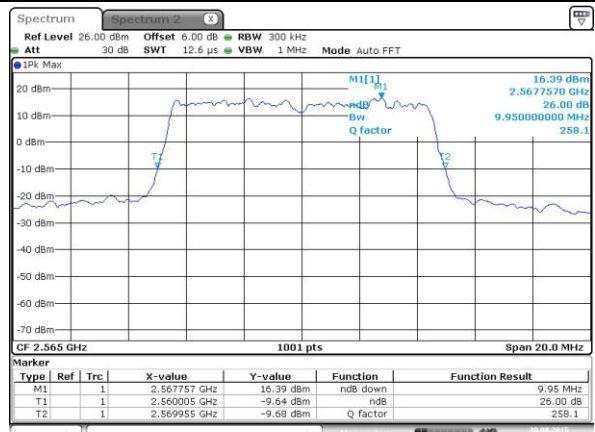

Date: 30 AUG 2015 22:51:17



LTE Band 7

Lowest Channel / 15MHz / QPSK

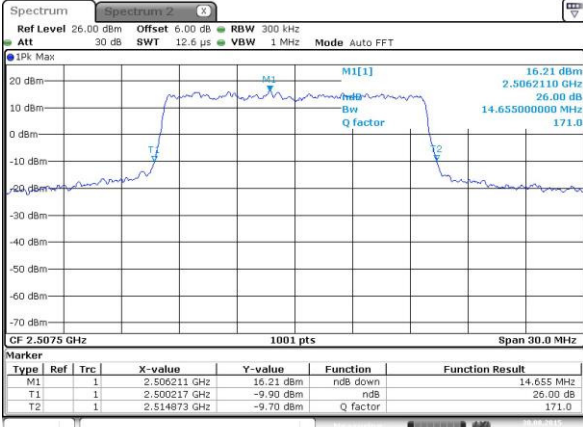

Date: 30 AUG 2015 22:58:45

Lowest Channel / 15MHz / 16QAM

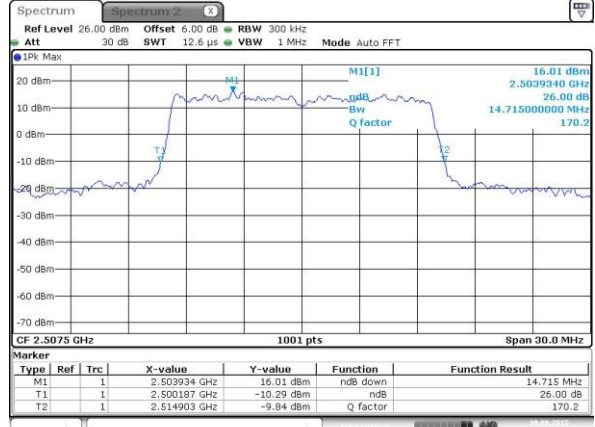

Date: 30 AUG 2015 22:58:57

Middle Channel / 15MHz / QPSK

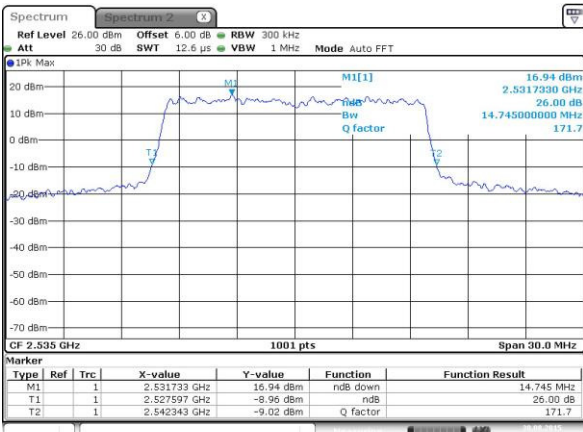

Date: 30 AUG 2015 23:06:25

Middle Channel / 15MHz / 16QAM

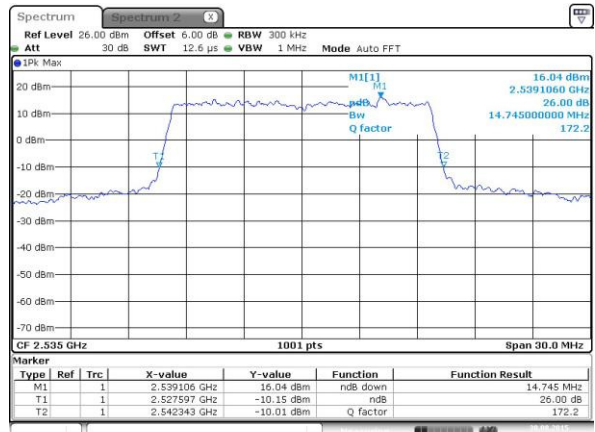

Date: 30 AUG 2015 23:06:38

Highest Channel / 15MHz / QPSK

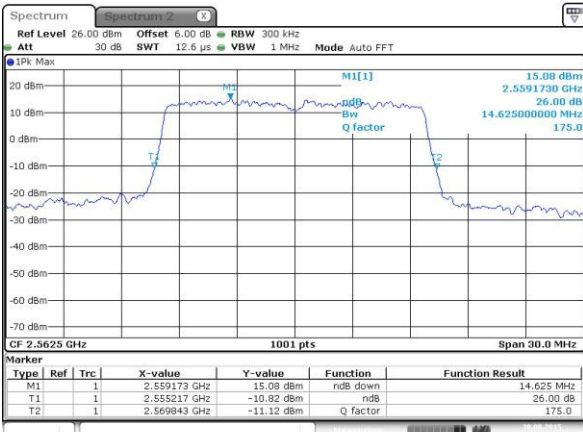

Date: 30 AUG 2015 23:09:31

Highest Channel / 15MHz / 16QAM

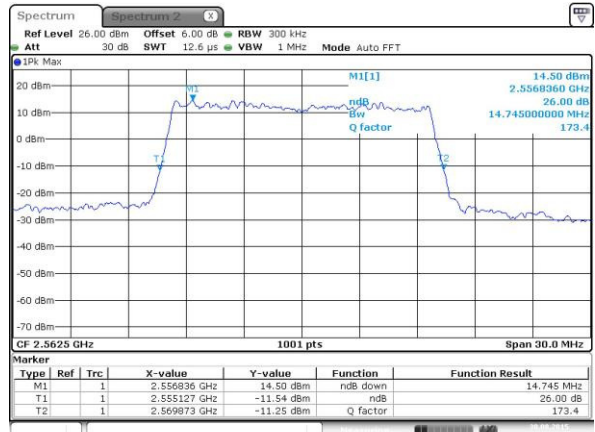

Date: 30 AUG 2015 23:09:43



LTE Band 7

Lowest Channel / 20MHz / QPSK

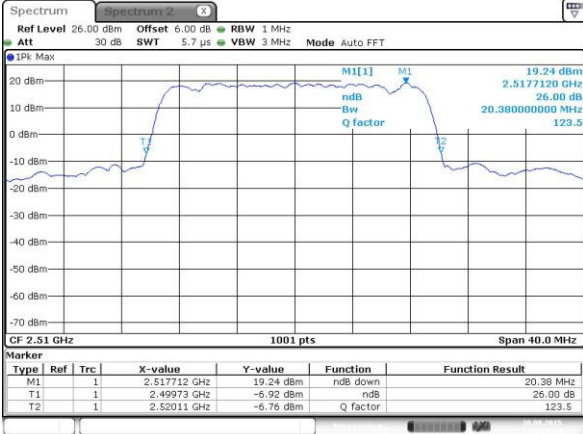

Date: 30 AUG 2015 23:17:11

Lowest Channel / 20MHz / 16QAM



Date: 30 AUG 2015 23:17:23

Middle Channel / 20MHz / QPSK

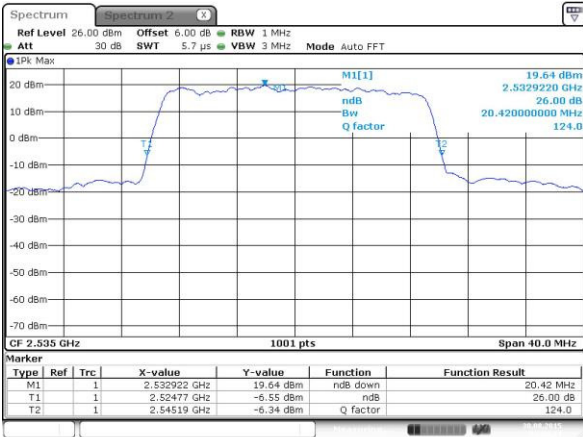

Date: 30 AUG 2015 23:24:51

Middle Channel / 20MHz / 16QAM



Date: 30 AUG 2015 23:25:03

Highest Channel / 20MHz / QPSK

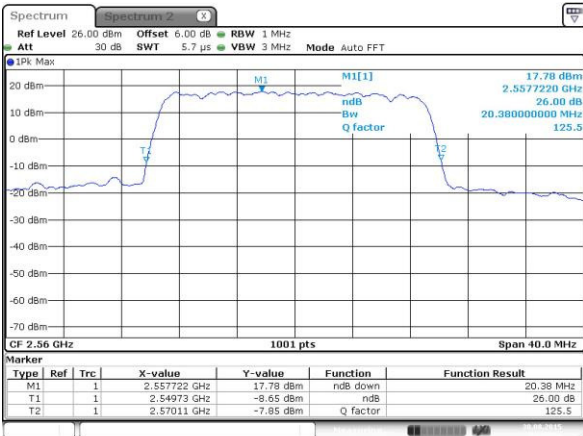

Date: 30 AUG 2015 23:27:56

Highest Channel / 20MHz / 16QAM

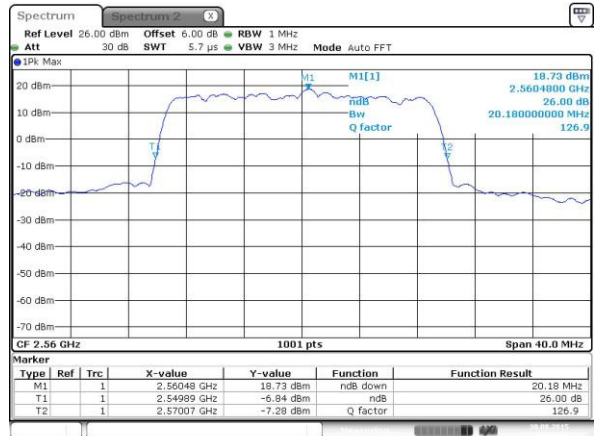

Date: 30 AUG 2015 23:28:09



### Occupied Bandwidth

Mode	LTE Band 7 : 99%OBW(MHz)											
	1.4MHz		3MHz		5MHz		10MHz		15MHz		20MHz	
BW	QPSK	16QAM	QPSK	16QAM	QPSK	16QAM	QPSK	16QAM	QPSK	16QAM	QPSK	16QAM
Lowest CH	-	-	-	-	4.51	4.51	9.07	9.01	13.43	13.46	18.46	18.42
Middle CH	-	-	-	-	4.51	4.50	9.05	9.03	13.49	13.49	18.50	18.38
Highest CH	-	-	-	-	4.51	4.51	9.05	9.03	13.49	13.43	18.34	18.38



LTE Band 7

Lowest Channel / 5MHz / QPSK

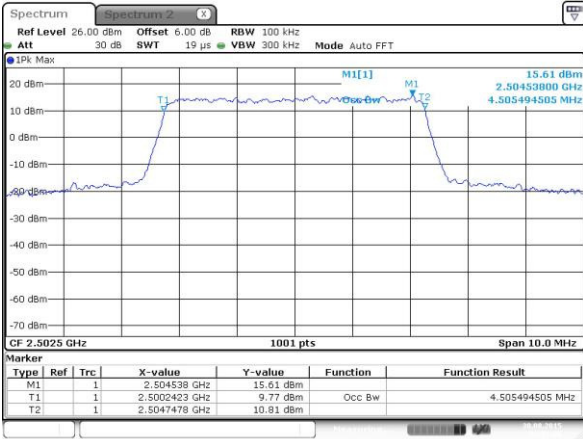

Date: 30 AUG 2015 22:21:30

Lowest Channel / 5MHz / 16QAM

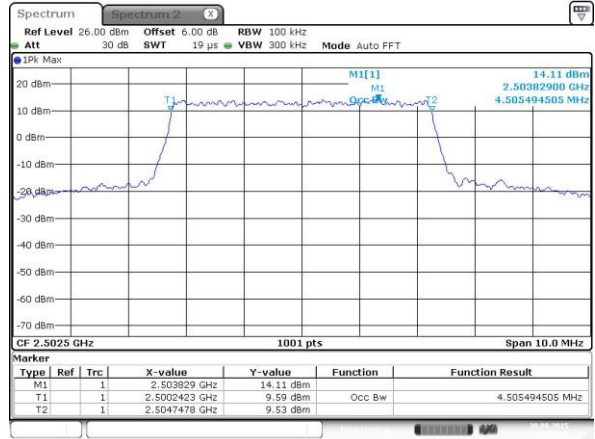

Date: 30 AUG 2015 22:21:41

Middle Channel / 5MHz / QPSK

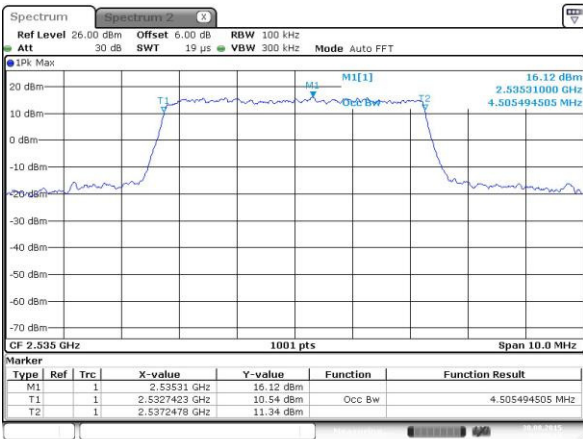

Date: 30 AUG 2015 22:29:10

Middle Channel / 5MHz / 16QAM

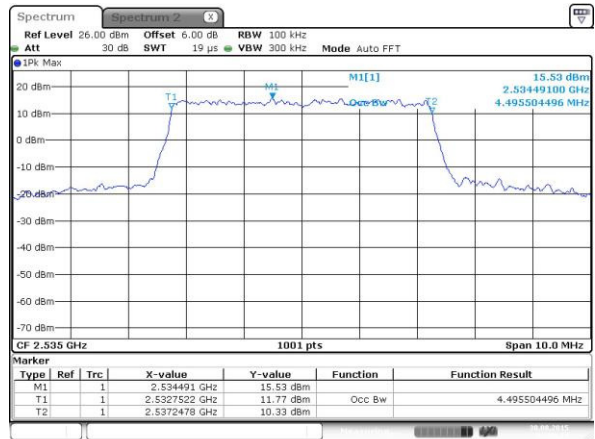

Date: 30 AUG 2015 22:29:21

Highest Channel / 5MHz / QPSK

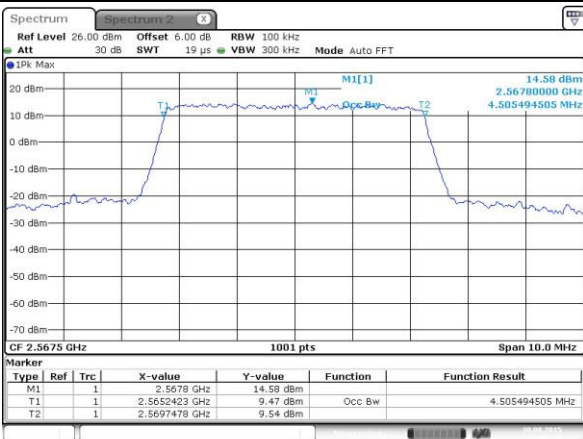

Date: 30 AUG 2015 22:32:16

Highest Channel / 5MHz / 16QAM

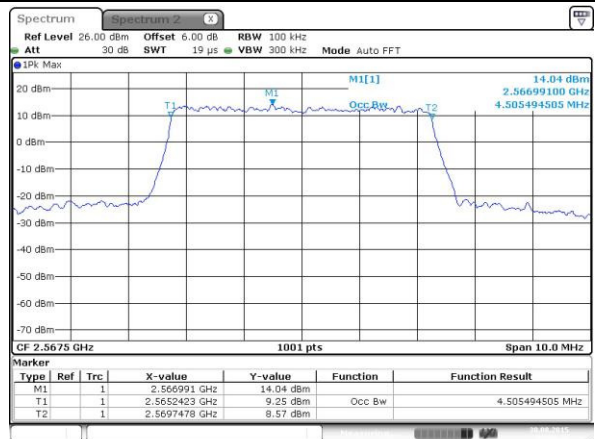

Date: 30 AUG 2015 22:32:27





LTE Band 7

Lowest Channel / 10MHz / QPSK

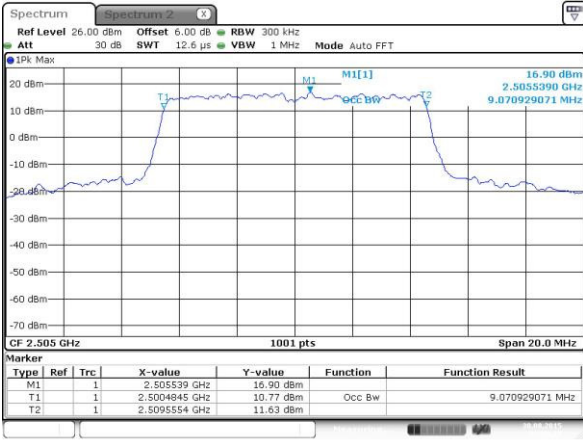

Date: 30 AUG 2015 22:39:56

Lowest Channel / 10MHz / 16QAM

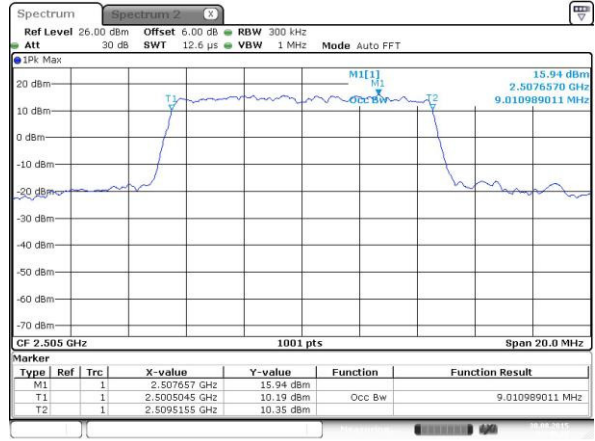

Date: 30 AUG 2015 22:40:06

Middle Channel / 10MHz / QPSK

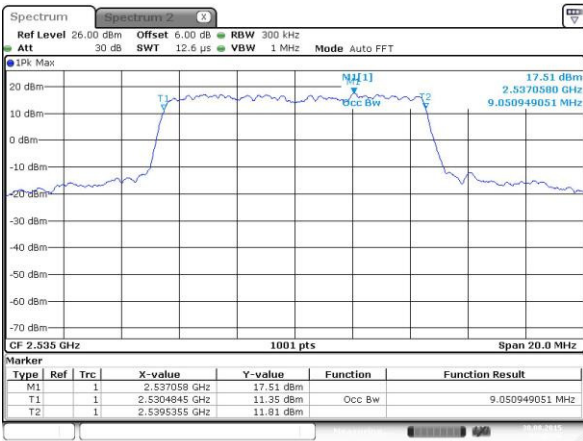

Date: 30 AUG 2015 22:47:36

Middle Channel / 10MHz / 16QAM

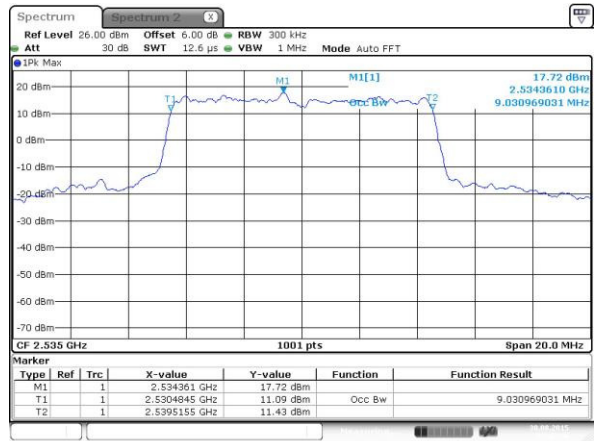

Date: 30 AUG 2015 22:47:46

Highest Channel / 10MHz / QPSK

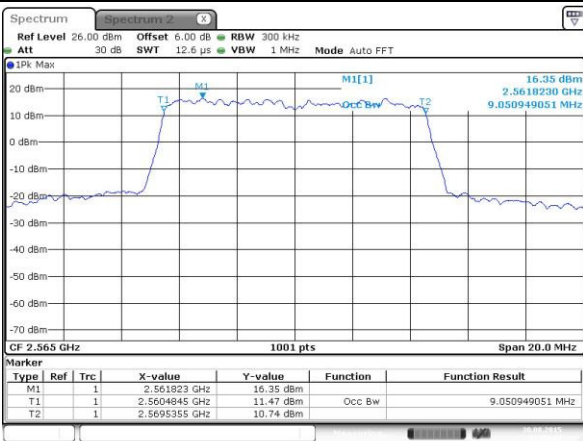

Date: 30 AUG 2015 22:50:41

Highest Channel / 10MHz / 16QAM

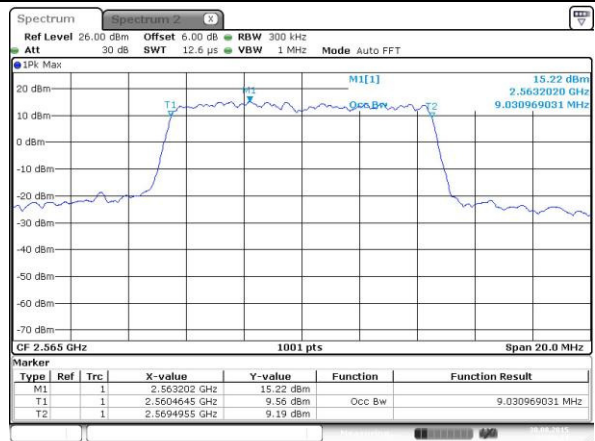

Date: 30 AUG 2015 22:50:52



LTE Band 7

Lowest Channel / 15MHz / QPSK

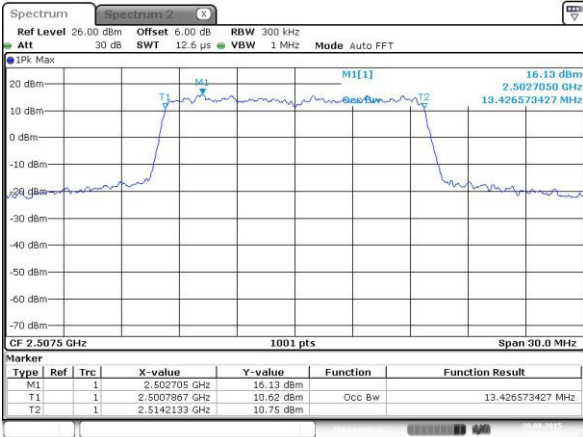

Date: 30 AUG 2015 22:58:21

Lowest Channel / 15MHz / 16QAM

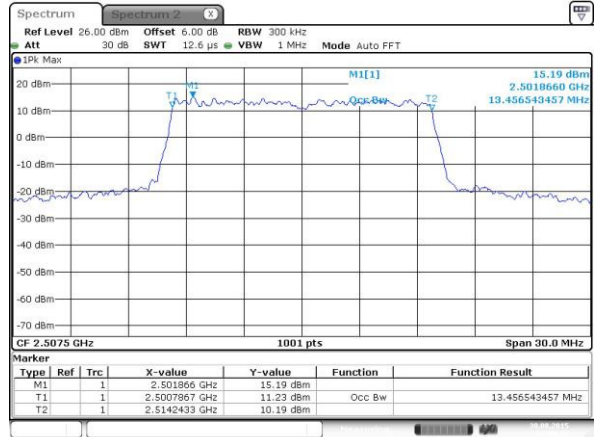

Date: 30 AUG 2015 22:58:32

Middle Channel / 15MHz / QPSK

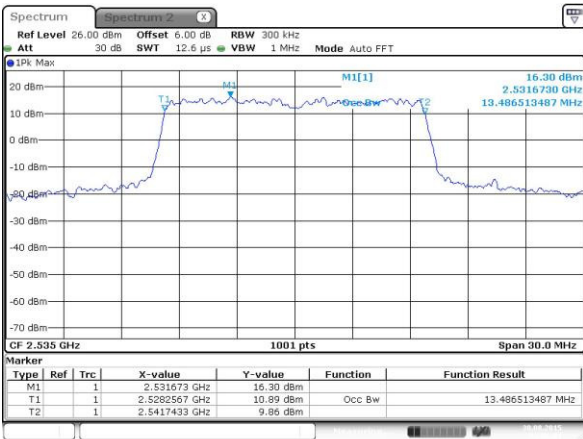

Date: 30 AUG 2015 23:06:01

Middle Channel / 15MHz / 16QAM

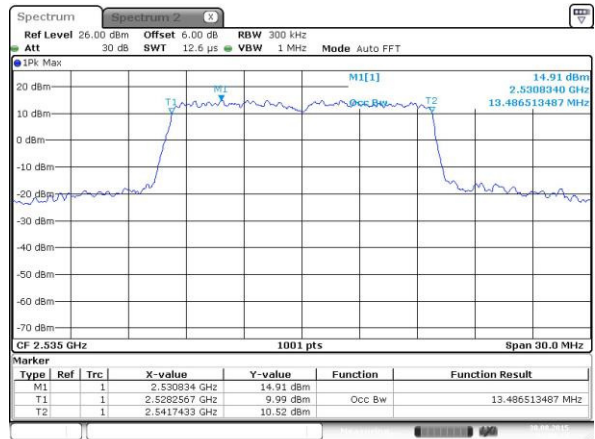

Date: 30 AUG 2015 23:06:12

Highest Channel / 15MHz / QPSK

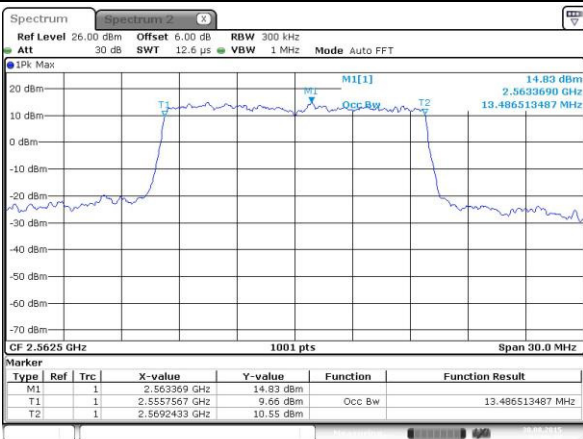

Date: 30 AUG 2015 23:09:07

Highest Channel / 15MHz / 16QAM

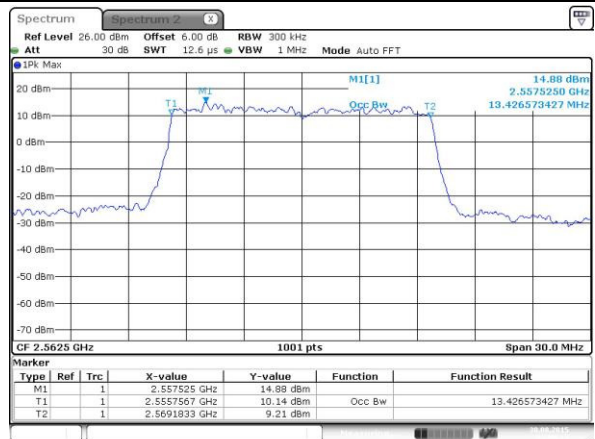

Date: 30 AUG 2015 23:09:18





LTE Band 7

Lowest Channel / 20MHz / QPSK

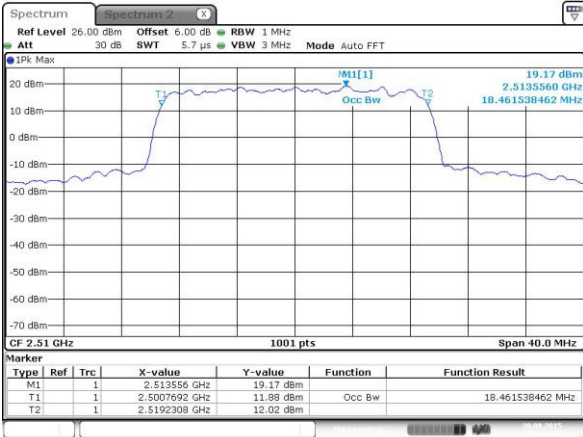

Date: 30 AUG 2015 23:16:47

Lowest Channel / 20MHz / 16QAM

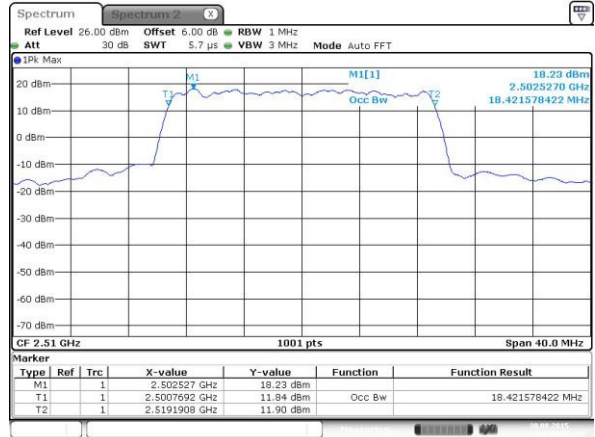

Date: 30 AUG 2015 23:16:58

Middle Channel / 20MHz / QPSK

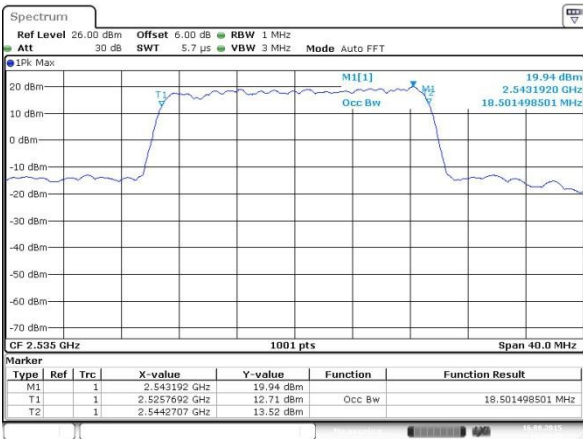

Date: 16 AUG 2015 18:31:45

Middle Channel / 20MHz / 16QAM

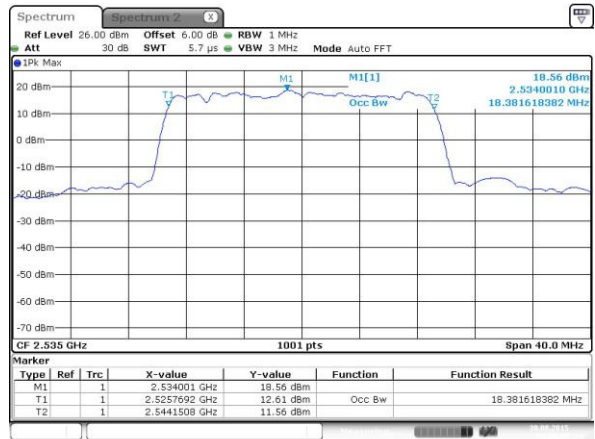

Date: 30 AUG 2015 23:24:38

Highest Channel / 20MHz / QPSK

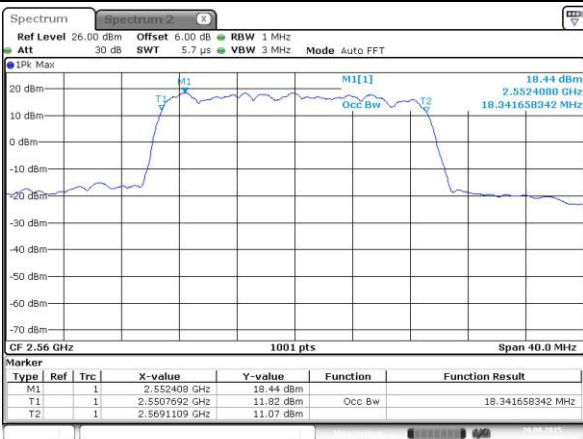

Date: 30 AUG 2015 23:27:33

Highest Channel / 20MHz / 16QAM

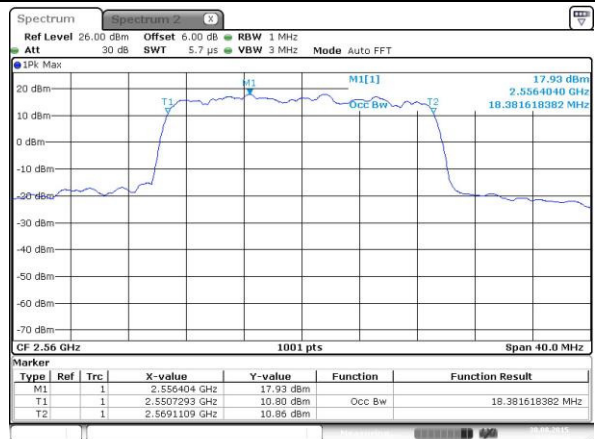

Date: 30 AUG 2015 23:27:44



# Conducted Band Edge

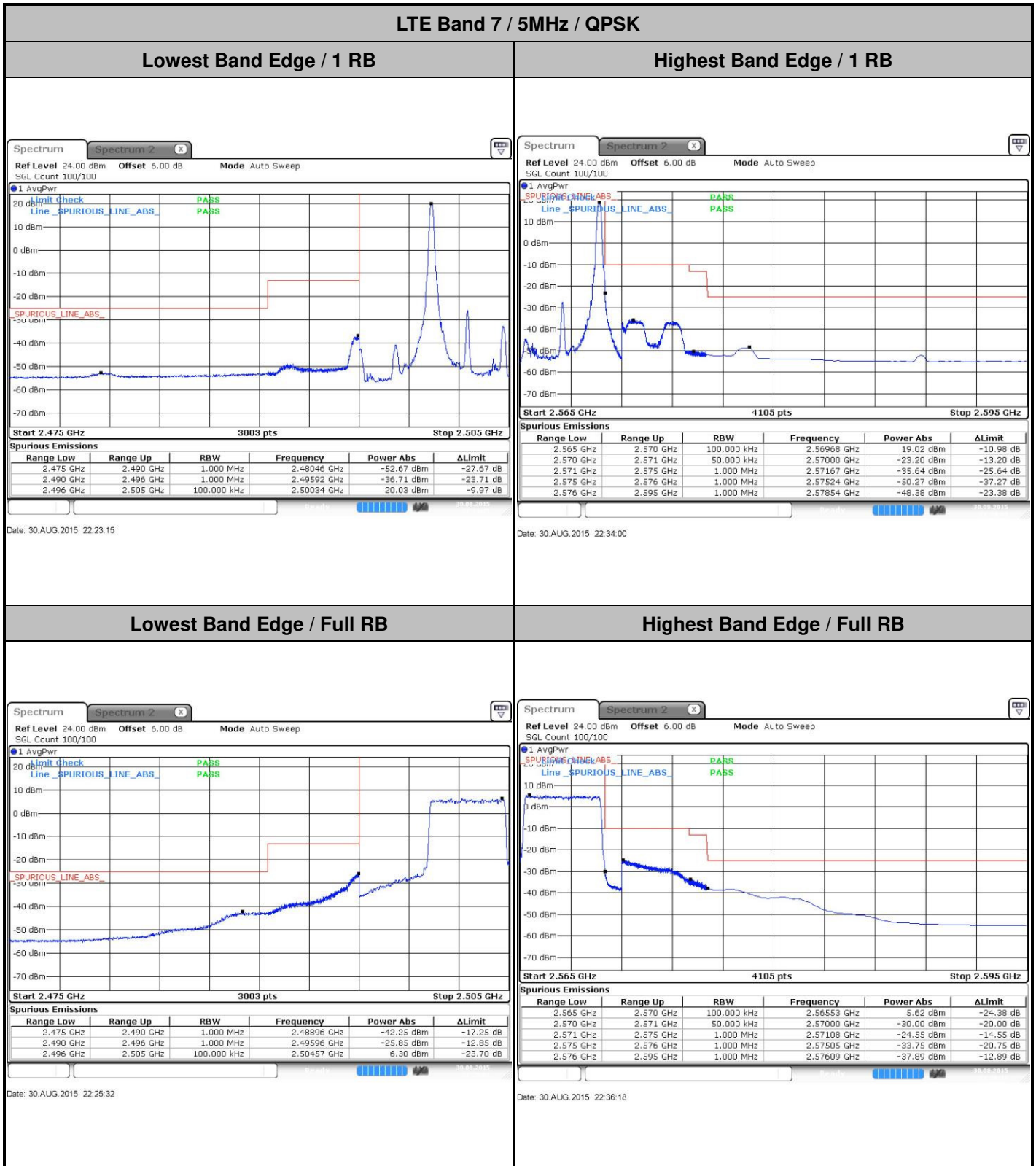



LTE Band 7 / 5MHz / 16QAM

Lowest Band Edge / 1 RB

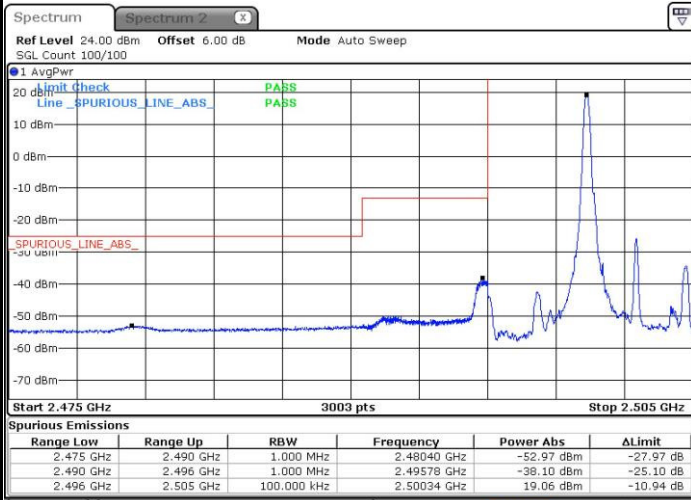

Date: 30 AUG 2015 22:24:23

Highest Band Edge / 1 RB

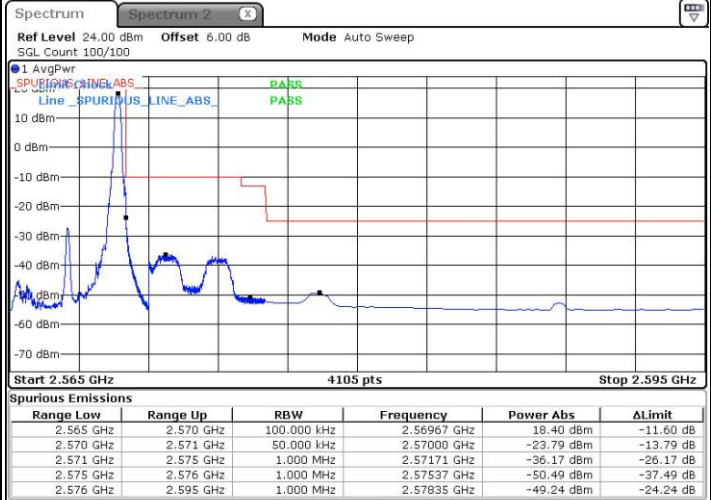

Date: 30 AUG 2015 22:35:09

Lowest Band Edge / Full RB

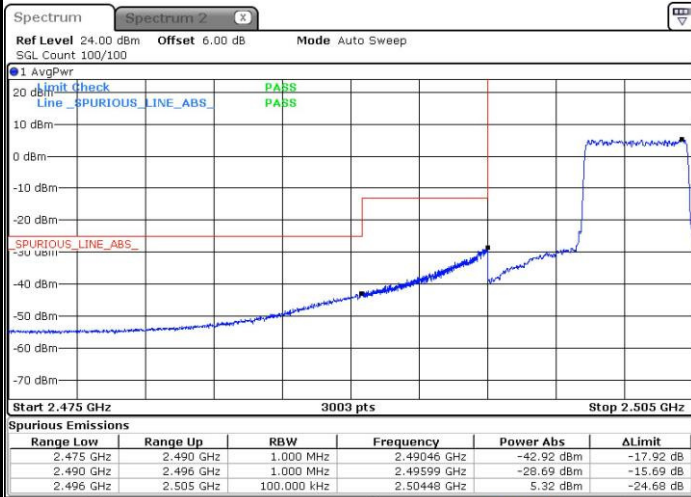

Date: 30 AUG 2015 22:26:41

Highest Band Edge / Full RB

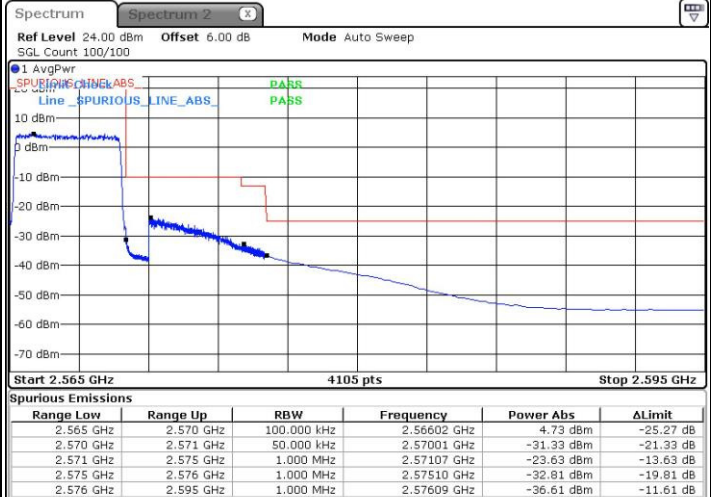

Date: 30 AUG 2015 22:37:26



LTE Band 7 / 10MHz / QPSK

Lowest Band Edge / 1 RB

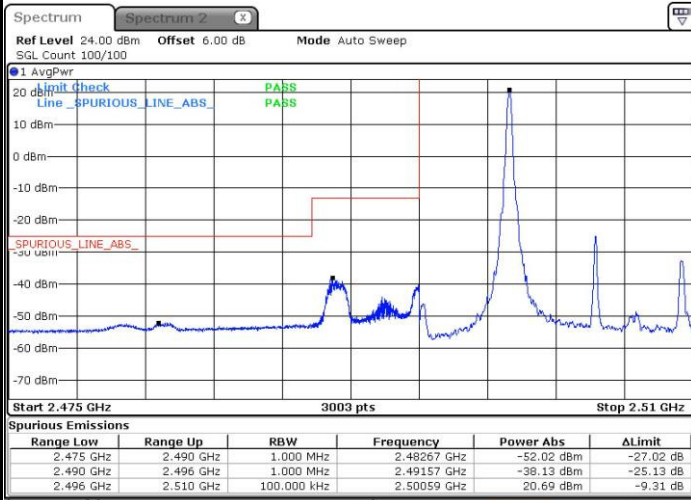

Date: 30 AUG 2015 22:41:40

Highest Band Edge / 1 RB



Date: 31 AUG 2015 01:24:48

Lowest Band Edge / Full RB



Date: 30 AUG 2015 22:43:57

Highest Band Edge / Full RB

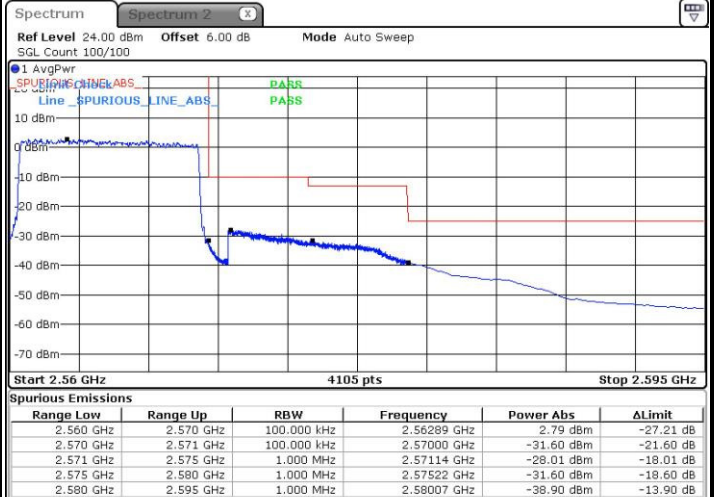

Date: 30 AUG 2015 22:54:43