



FCC RF Test Report

APPLICANT : Doro AB
EQUIPMENT : GSM /WCDMA Mobile Telephone
BRAND NAME : doro
MODEL NAME : Doro Liberto 820 Mini
FCC ID : WS5DORO820M
STANDARD : FCC Part 15 Subpart C §15.247
CLASSIFICATION : (DSS) Spread Spectrum Transmitter

The product was received on Nov. 14, 2014 and testing was completed on Dec. 17, 2014. We, SPORTON INTERNATIONAL (SHENZHEN) INC., would like to declare that the tested sample has been evaluated in accordance with the test procedures and has been in compliance with the applicable technical standards.

The test results in this report apply exclusively to the tested model / sample. Without written approval of SPORTON INTERNATIONAL (SHENZHEN) INC., the test report shall not be reproduced except in full.

Reviewed by: Joseph Lin / Supervisor

Approved by: Jones Tsai / Manager



SPORTON INTERNATIONAL (SHENZHEN) INC.

1F & 2F, Building A, Morning Business Center, No. 4003 ShiGu Rd., Xili Town,

Nanshan District, Shenzhen, Guangdong, P. R. China



TABLE OF CONTENTS

REVISION HISTORY..... 3

SUMMARY OF TEST RESULT 4

1 GENERAL DESCRIPTION..... 5

 1.1 Applicant.....5

 1.2 Manufacturer.....5

 1.3 Product Feature of Equipment Under Test.....5

 1.4 Product Specification subjective to this standard5

 1.5 Modification of EUT6

 1.6 Component list.....6

 1.7 Testing Location7

 1.8 Applicable Standards.....7

2 TEST CONFIGURATION OF EQUIPMENT UNDER TEST..... 8

 2.1 Descriptions of Test Mode.....8

 2.2 Test Mode.....9

 2.3 Connection Diagram of Test System.....10

 2.4 Support Unit used in test configuration and system11

 2.5 EUT Operation Test Setup11

 2.6 Measurement Results Explanation Example.....12

3 TEST RESULT 13

 3.1 Number of Channel Measurement13

 3.2 Hopping Channel Separation Measurement15

 3.3 Dwell Time Measurement.....22

 3.4 20dB Bandwidth Measurement25

 3.5 Peak Output Power Measurement32

 3.6 Conducted Band Edges Measurement34

 3.7 Conducted Spurious Emission Measurement41

 3.8 Radiated Band Edges and Spurious Emission Measurement51

 3.9 AC Conducted Emission Measurement.....57

 3.10 Antenna Requirements.....62

4 LIST OF MEASURING EQUIPMENT..... 63

5 UNCERTAINTY OF EVALUATION..... 64

APPENDIX A. RADIATED SPURIOUS EMISSION

APPENDIX B. SETUP PHOTOGRAPHS

APPENDIX C. PHOTOGRAPHS OF EUT

**SUMMARY OF TEST RESULT**

Report Section	FCC Rule	Description	Limit	Result	Remark
3.1	15.247(a)(1)	Number of Channels	≥ 15 Chs	Pass	-
3.2	15.247(a)(1)	Hopping Channel Separation	$\geq 2/3$ of 20dB BW	Pass	-
3.3	15.247(a)(1)	Dwell Time of Each Channel	≤ 0.4 sec in 31.6sec period	Pass	-
3.4	15.247(a)(1)	20dB Bandwidth	NA	Pass	-
3.5	15.247(b)(1)	Peak Output Power	≤ 125 mW	Pass	-
3.6	15.247(d)	Conducted Band Edges	≤ 20 dBc	Pass	-
3.7	15.247(d)	Conducted Spurious Emission	≤ 20 dBc	Pass	-
3.8	15.247(d)	Radiated Band Edges and Radiated Spurious Emission	15.209(a) & 15.247(d)	Pass	Under limit 13.07 dB at 60.070 MHz
3.9	15.207	AC Conducted Emission	15.207(a)	Pass	Under limit 8.84 dB at 3.380 MHz
3.10	15.203 & 15.247(b)	Antenna Requirement	N/A	Pass	-



1 General Description

1.1 Applicant

Doro AB
Magistratsvägen 10 SE-226 43 Lund Sweden

1.2 Manufacturer

CK TELECOM LTD.
Technology Road.High-Tech Development Zone. Heyuan, Guangdong, P.R.China

1.3 Product Feature of Equipment Under Test

Product Feature	
Equipment	GSM /WCDMA Mobile Telephone
Brand Name	doro
Model Name	Doro Liberto 820 Mini
FCC ID	WS5DORO820M
EUT supports Radios application	GSM/GPRS/EGPRS (Downlink Only)/ WLAN 2.4GHz 802.11b/g/n HT20/HT40 Bluetooth v3.0 + EDR/Bluetooth v4.0 LE
HW Version	HOPE-V2.0
SW Version	HOPE01A-S01A_DORO_L32EN_203_USER_141213
EUT Stage	Production Unit

Remark: The above EUT's information was declared by manufacturer. Please refer to the specifications or user's manual for more detailed description.

1.4 Product Specification subjective to this standard

Product Specification subjective to this standard	
Tx/Rx Frequency Range	2402 MHz ~ 2480 MHz
Number of Channels	79
Carrier Frequency of Each Channel	2402+n*1 MHz; n=0~78
Maximum Output Power to Antenna	Bluetooth BR(1Mbps) : 8.15 dBm (0.00653 W) Bluetooth EDR (2Mbps) : 7.89 dBm (0.00615 W) Bluetooth EDR (3Mbps) : 8.08 dBm (0.00643 W)
Antenna Type/Gain	Dipole Antenna with gain -2 dBi
Type of Modulation	Bluetooth BR (1Mbps) : GFSK Bluetooth EDR (2Mbps) : $\pi/4$ -DQPSK Bluetooth EDR (3Mbps) : 8-DPSK



1.5 Modification of EUT

No modifications are made to the EUT during all test items.

1.6 Component list

Component	Sample 1	Sample 2
Flash memory	TYC0FH121638RA	H9TP32A4GDCCPR-KGM
Rear camera	F5645BL	GDF140501
USB connector	UAF95-05164-S129	MCB04-5K22000
SIM card connector	CAF99-08153-010603	SIM40-8K13001-QH
T-Flash connector	KM100846M171R	TFS23-9K23000
HW code	1011	1021

Note: There are two types of EUT sample 1 and sample 2 which cover all the listed different critical components as declared by manufacturer. But for RF test, we only fully tested the sample 1.



1.7 Testing Location

Test Site	SPORTON INTERNATIONAL (SHENZHEN) INC.	
Test Site Location	1F & 2F, Building A, Morning Business Center, No. 4003 ShiGu Rd., Xili Town, Nanshan District, Shenzhen, Guangdong, P. R. China TEL: +86-755-8637-9589 FAX: +86-755-8637-9595	
Test Site No.	Sporton Site No.	
	TH01-SZ	CO01-SZ

Test Site	SPORTON INTERNATIONAL (SHENZHEN) INC.	
Test Site Location	No. 3 Building, the third floor of south, Shahe River west, Fengzeyuan warehouse, Nanshan District, Shenzhen, Guangdong, P. R. China TEL: +86-755- 3320-2398	
Test Site No.	Sporton Site No.	FCC Registration No.
	03CH01-SZ	831040

Note: The test site complies with ANSI C63.4 2009 requirement.

1.8 Applicable Standards

According to the specifications of the manufacturer, the EUT must comply with the requirements of the following standards:

- ♦ FCC Part 15 Subpart C §15.247
- ♦ FCC Public Notice DA 00-705
- ♦ ANSI C63.10-2009
- ♦ ANSI C63.4-2009

Remark:

1. All test items were verified and recorded according to the standards and without any deviation during the test.
2. This EUT has also been tested and complied with the requirements of FCC Part 15, Subpart B, recorded in a separate test report.

2 Test Configuration of Equipment Under Test

2.1 Descriptions of Test Mode

Preliminary tests were performed in different data rates and recorded the RF output power in the following table:

Channel	Frequency	Bluetooth RF Output Power		
		Data Rate / Modulation		
		GFSK	$\pi/4$ -DQPSK	8-DPSK
		1Mbps	2Mbps	3Mbps
Ch00	2402MHz	7.80 dBm	7.65 dBm	7.74 dBm
Ch39	2441MHz	8.13 dBm	7.77 dBm	8.06 dBm
Ch78	2480MHz	8.15 dBm	7.89 dBm	8.08 dBm

Remark:

1. All the test data for each data rate were verified, but only the worst case was reported.
 2. The data rate was set in 1Mbps for all the test items due to the highest RF output power.
- a. The EUT has been associated with peripherals and configuration operated in a manner tended to maximize its emission characteristics in a typical application. Frequency range investigated: conduction (150 kHz to 30 MHz), radiation (9 kHz to the 10th harmonic of the highest fundamental frequency or to 40 GHz, whichever is lower). Pre-scanned tests, X, Y, Z in three orthogonal panels, and different data rates were conducted to determine the final configuration (Y plane as worst plane) from all possible combinations, and the worst mode of radiated spurious emissions is Bluetooth 1Mbps mode, and recorded in this report.
- b. AC power line Conducted Emission was tested under maximum output power.



2.2 Test Mode

The following summary table is showing all test modes to demonstrate in compliance with the standard.

Summary table of Test Cases			
Test Item	Data Rate / Modulation		
	Bluetooth BR 1Mbps GFSK	Bluetooth EDR 2Mbps $\pi/4$ -DQPSK	Bluetooth EDR 3Mbps 8-DPSK
Conducted Test Cases	Mode 1: CH00_2402 MHz Mode 2: CH39_2441 MHz Mode 3: CH78_2480 MHz	Mode 4: CH00_2402 MHz Mode 5: CH39_2441 MHz Mode 6: CH78_2480 MHz	Mode 7: CH00_2402 MHz Mode 8: CH39_2441 MHz Mode 9: CH78_2480 MHz
Radiated Test Cases	Bluetooth BR 1Mbps GFSK		
	Mode 1: CH00_2402 MHz Mode 2: CH39_2441 MHz Mode 3: CH78_2480 MHz		
AC Conducted Emission	Mode 1 :GSM850 Idle + Bluetooth Link + WLAN Link + Earphone 2 + USB Cable (Charging from Adapter 2) + Cradle for Sample 1		
Remark:			
<ol style="list-style-type: none"> For radiated test cases, the worst mode data rate 1Mbps was reported only, because this data rate has the highest RF output power at preliminary tests, and no other significantly frequencies found in conducted spurious emission. For Radiated Test Cases, The tests were performance with Adapter 1, Earphone 1, and USB Cable. All the radiated test cases were performance with Sample 1. 			

2.3 Connection Diagram of Test System

<Bluetooth Tx Mode>

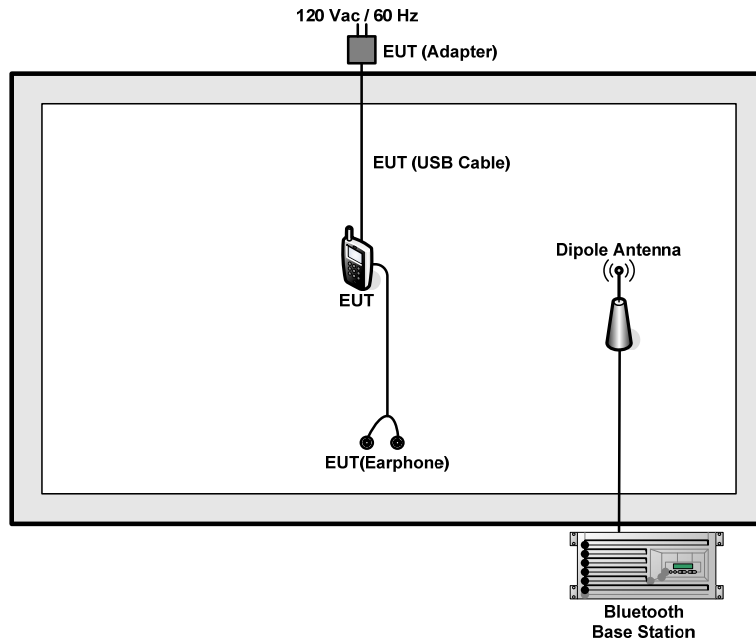

<AC Conducted Emission Mode>

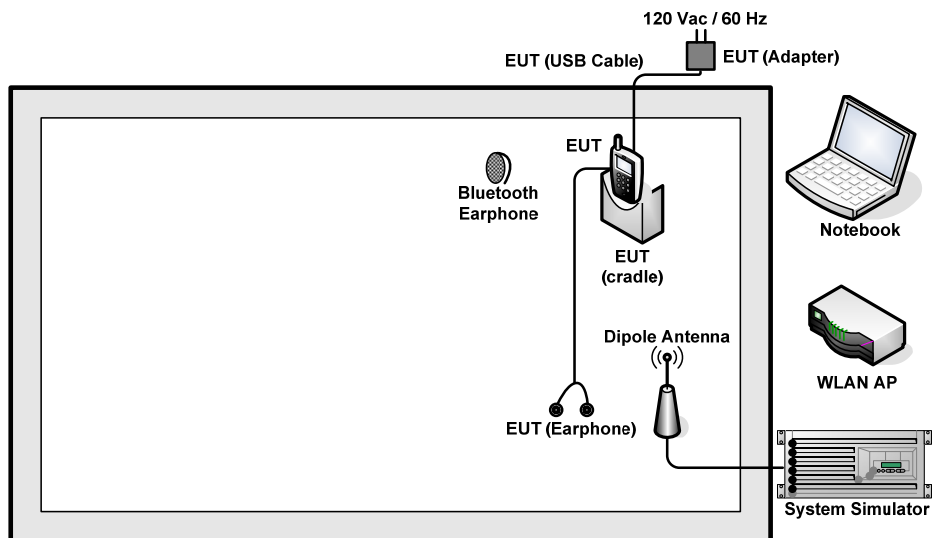

2.4 Support Unit used in test configuration and system

Item	Equipment	Trade Name	Model Name	FCC ID	Data Cable	Power Cord
1.	Bluetooth Base Station	R&S	CBT32	N/A	N/A	Unshielded, 1.8 m
2.	System Simulator	R&S	CMU 200	N/A	N/A	N/A
3.	WLAN AP	D-Link	DIR-815	KA2IR815A1	N/A	Unshielded, 1.8 m
4.	Notebook	DELL	Vostro 1440	FCC DoC	N/A	AC I/P: Unshielded, 1.2 m DC O/P: Shielded, 1.8 m
5.	Bluetooth Earphone	Nokia	BH-108	PYAHS-107W	N/A	N/A

2.5 EUT Operation Test Setup

For Bluetooth function, the engineering test program was provided and enabled to make EUT connect with Bluetooth base station to continuous transmit/receive.

For AC power line conducted emissions, the EUT was set to connect with the WLAN AP under large package sizes transmission.



2.6 Measurement Results Explanation Example

For all conducted test items:

The offset level is set in the spectrum analyzer to compensate the RF cable loss and attenuator factor between EUT conducted output port and spectrum analyzer. With the offset compensation, the spectrum analyzer reading level is exactly the EUT RF output level.

Example:

The spectrum analyzer offset is derived from RF cable loss and attenuator factor.

Offset = RF cable loss + attenuator factor.

Following shows an offset computation example with cable loss 5.0dB and 10dB attenuator.

$$\begin{aligned} \text{Offset(dB)} &= \text{RF cable loss(dB)} + \text{attenuator factor(dB)}. \\ &= 5.0 + 10 = 15.0 \text{ (dB)} \end{aligned}$$

3 Test Result

3.1 Number of Channel Measurement

3.1.1 Limits of Number of Hopping Frequency

Frequency hopping systems in the 2400-2483.5 MHz band shall use at least 15 channels.

3.1.2 Measuring Instruments

The measuring equipment is listed in the section 4 of this test report.

3.1.3 Test Procedure

1. The testing follows FCC Public Notice DA 00-705 Measurement Guidelines.
2. The RF output of EUT was connected to the spectrum analyzer by RF cable and attenuator. The path loss was compensated to the results for each measurement.
3. Set to the maximum power setting and enable the EUT transmit continuously.
4. Enable the EUT hopping function.
5. Use the following spectrum analyzer settings: Span = the frequency band of operation; RBW \geq 1% of the span; VBW \geq RBW; Sweep = auto; Detector function = peak; Trace = max hold.
6. The number of hopping frequency used is defined as the number of total channel.
7. Record the measurement data derived from spectrum analyzer.

3.1.4 Test Setup

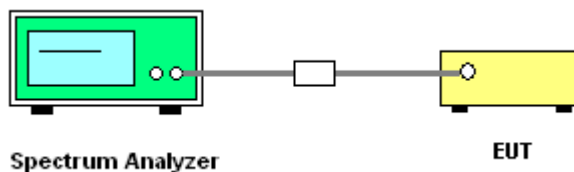

3.1.5 Test Result of Number of Hopping Frequency

Test Mode :	1 Mbps	Temperature :	24~26°C
Test Engineer :	Ting You	Relative Humidity :	50~53%
Number of Hopping (Channel)	Adaptive Frequency Hopping (Channel)	Limits (Channel)	Pass/Fail
79	20	> 15	Pass



Number of Hopping Channel Plot on Channel 00 - 78

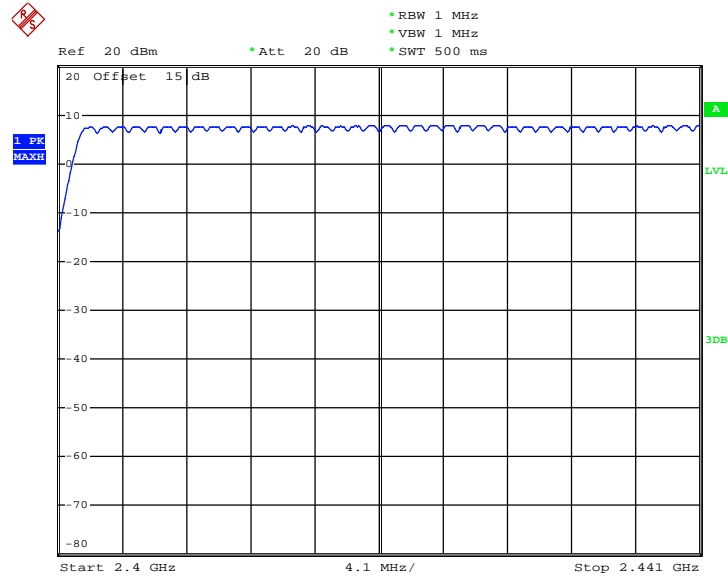

Date: 28.NOV.2014 14:52:23

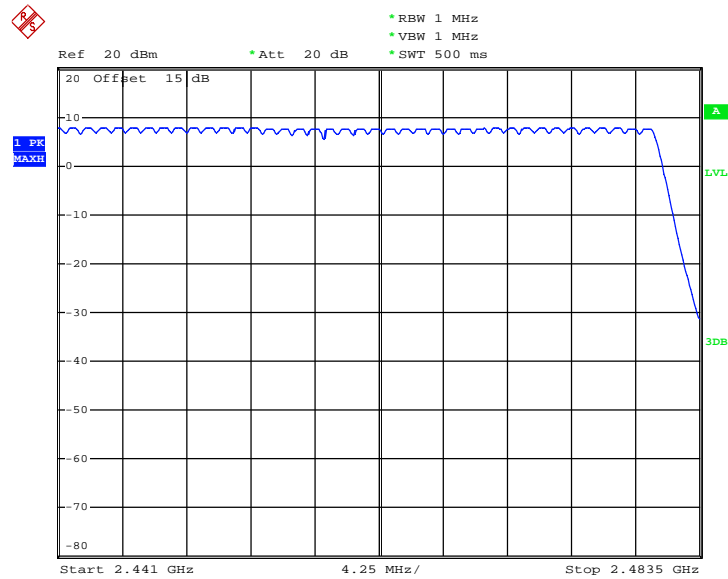

Date: 28.NOV.2014 14:56:38

3.2 Hopping Channel Separation Measurement

3.2.1 Limit of Hopping Channel Separation

Frequency hopping systems operating in the 2400-2483.5 MHz band may have hopping channel carrier frequencies that are separated by 25 kHz or two-thirds of the 20 dB bandwidth of the hopping channel, whichever is greater.

3.2.2 Measuring Instruments

The measuring equipment is listed in the section 4 of this test report.

3.2.3 Test Procedures

1. The testing follows FCC Public Notice DA 00-705 Measurement Guidelines.
2. The RF output of EUT was connected to the spectrum analyzer by RF cable and attenuator. The path loss was compensated to the results for each measurement.
3. Set to the maximum power setting and enable the EUT transmit continuously.
4. Enable the EUT hopping function.
5. Use the following spectrum analyzer settings:
Span = wide enough to capture the peaks of two adjacent channels; RBW \geq 1% of the span;
VBW \geq RBW; Sweep = auto; Detector function = peak; Trace = max hold.
6. Measure and record the results in the test report.

3.2.4 Test Setup

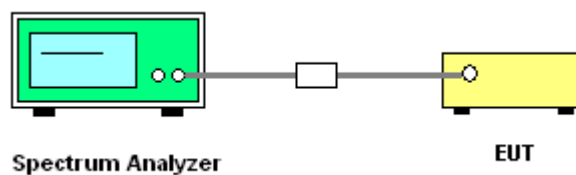



3.2.5 Test Result of Hopping Channel Separation

Test Mode :	1Mbps	Temperature :	24~26°C
Test Engineer :	Ting You	Relative Humidity :	50~53%

Channel	Frequency (MHz)	Frequency Separation (MHz)	(2/3 of 20dB BW) Limits (MHz)	Pass/Fail
00	2402	1.002	0.6187	Pass
39	2441	0.996	0.6187	Pass
78	2480	1.002	0.5680	Pass

Channel Separation Plot on Channel 00 - 01

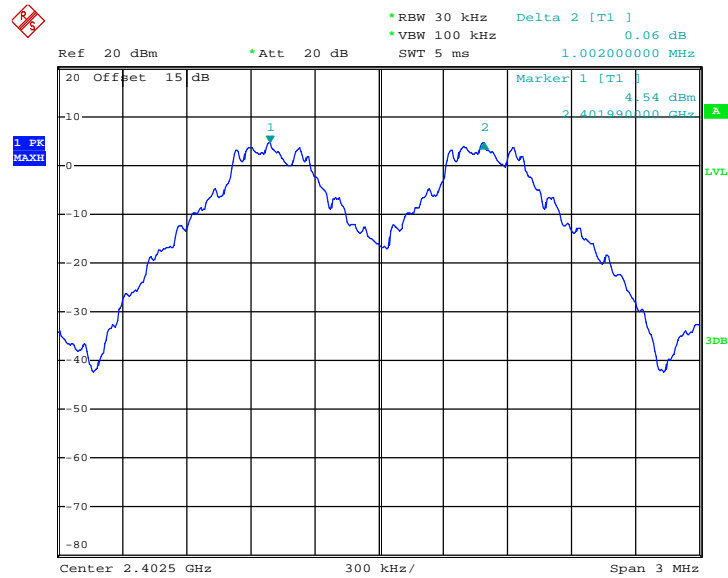

Date: 28.NOV.2014 14:09:12



Channel Separation Plot on Channel 39 - 40

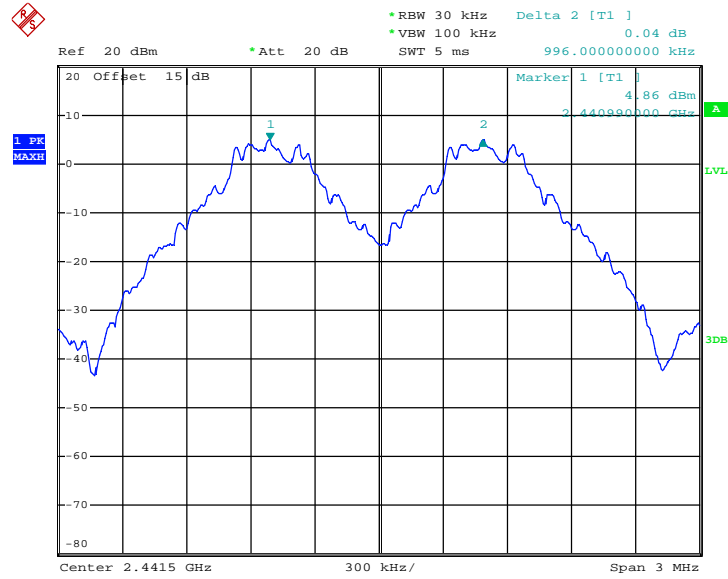

Date: 28.NOV.2014 14:10:01

Channel Separation Plot on Channel 77 - 78

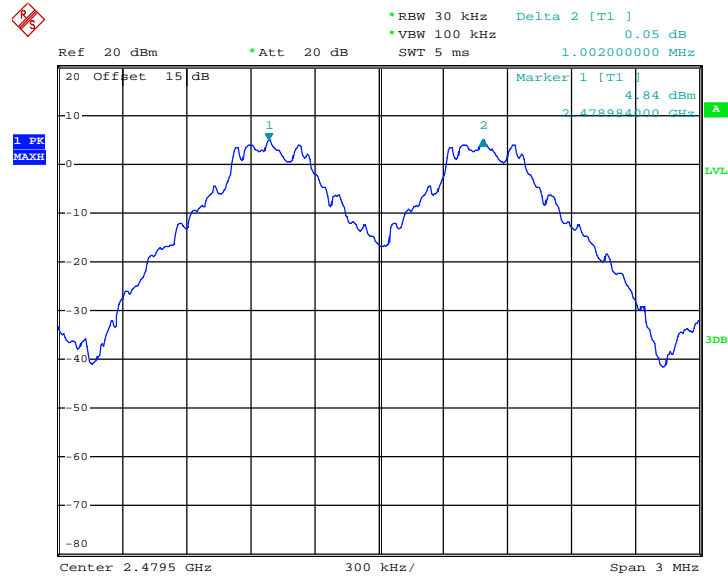

Date: 28.NOV.2014 14:10:41



Test Mode :	2Mbps	Temperature :	24~26°C
Test Engineer :	Ting You	Relative Humidity :	50~53%

Channel	Frequency (MHz)	Frequency Separation (MHz)	(2/3 of 20dB BW) Limits (MHz)	Pass/Fail
00	2402	1.002	0.8480	Pass
39	2441	1.008	0.8480	Pass
78	2480	1.002	0.8240	Pass

Channel Separation Plot on Channel 00 - 01

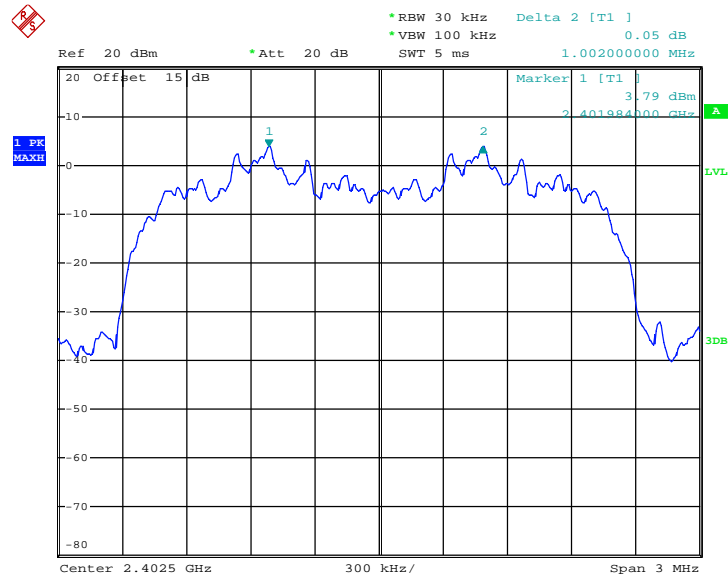

Date: 28.NOV.2014 15:14:58



Channel Separation Plot on Channel 39 - 40

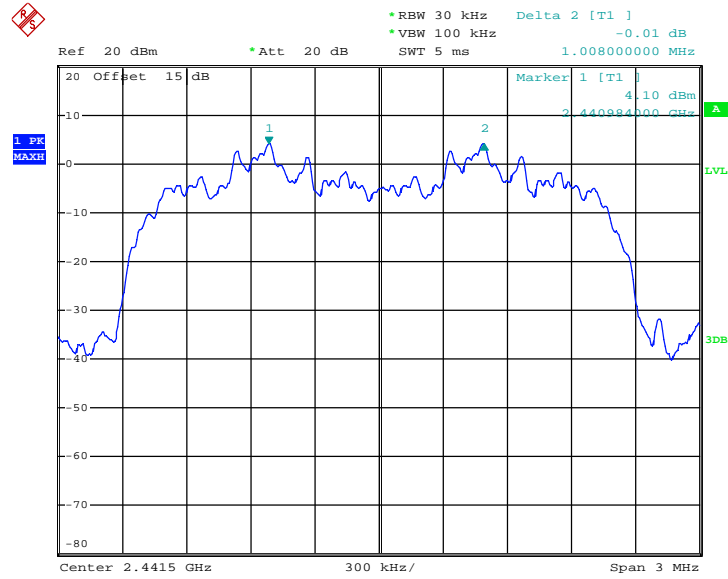

Date: 28.NOV.2014 14:12:09

Channel Separation Plot on Channel 77 - 78

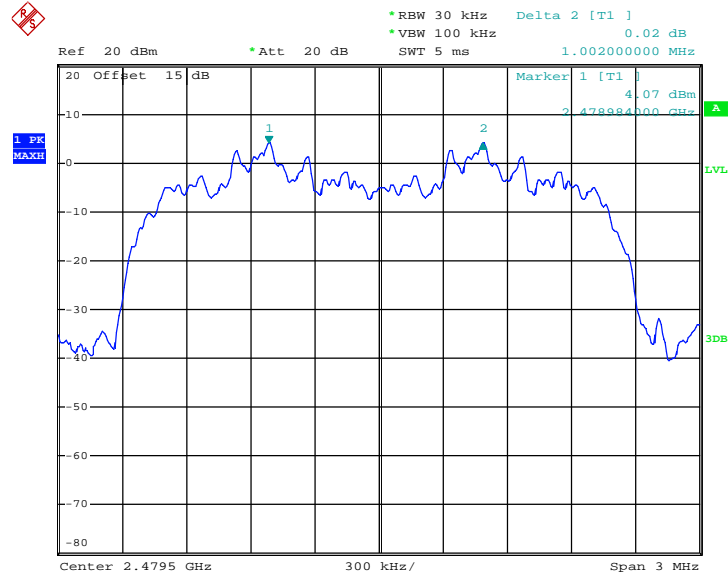

Date: 28.NOV.2014 14:12:56



Test Mode :	3Mbps	Temperature :	24~26°C
Test Engineer :	Ting You	Relative Humidity :	50~53%

Channel	Frequency (MHz)	Frequency Separation (MHz)	(2/3 of 20dB BW) Limits (MHz)	Pass/Fail
00	2402	0.996	0.8320	Pass
39	2441	0.996	0.8360	Pass
78	2480	0.996	0.8360	Pass

Channel Separation Plot on Channel 00 - 01

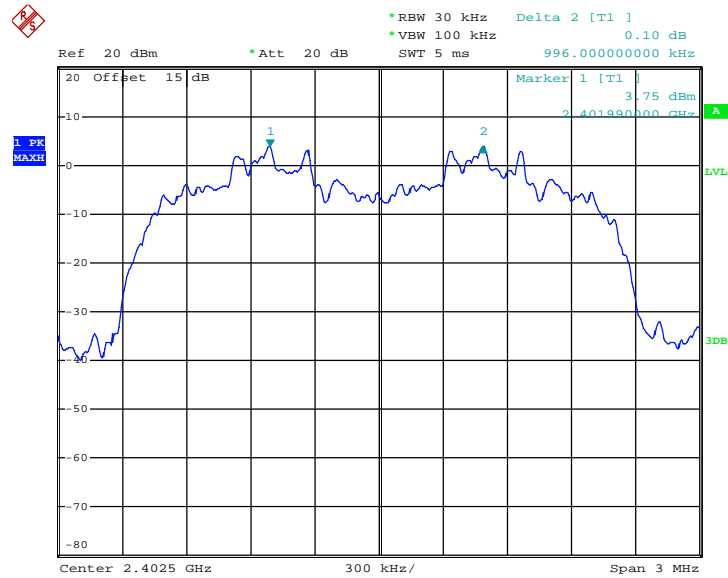

Date: 28.NOV.2014 14:17:24



Channel Separation Plot on Channel 39 - 40

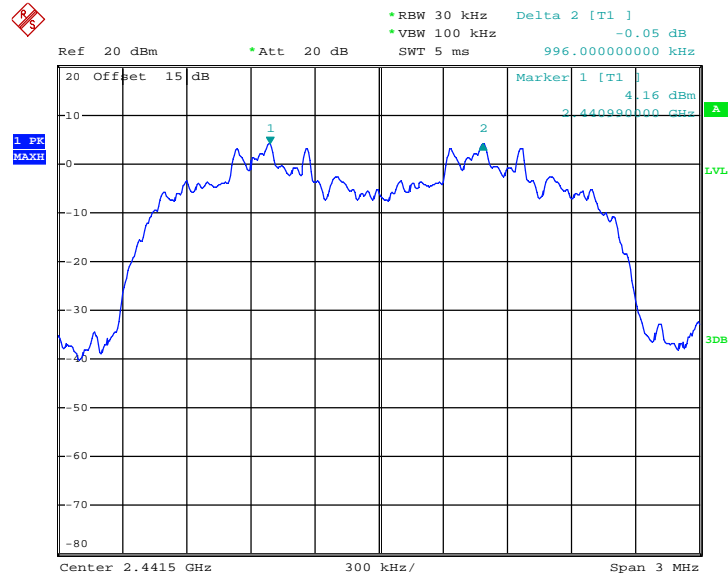

Date: 28.NOV.2014 14:18:06

Channel Separation Plot on Channel 77 - 78

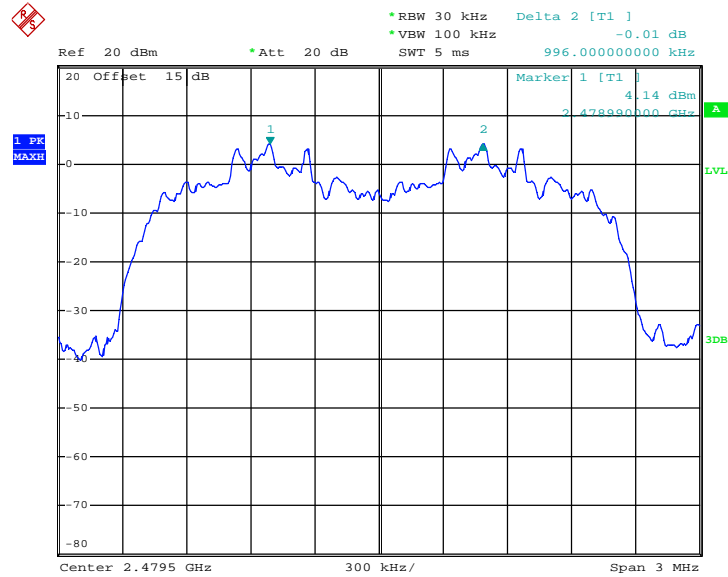

Date: 28.NOV.2014 14:18:46

3.3 Dwell Time Measurement

3.3.1 Limit of Dwell Time

The average time of occupancy on any channel shall not be greater than 0.4 seconds within a period of 0.4 seconds multiplied by the number of hopping channels employed.

3.3.2 Measuring Instruments

The measuring equipment is listed in the section 4 of this test report.

3.3.3 Test Procedures

1. The testing follows FCC Public Notice DA 00-705 Measurement Guidelines.
2. The RF output of EUT was connected to the spectrum analyzer by RF cable and attenuator. The path loss was compensated to the results for each measurement.
3. Set to the maximum power setting and enable the EUT transmit continuously.
4. Enable the EUT hopping function.
5. Use the following spectrum analyzer settings: Span = zero span, centered on a hopping channel; RBW = 1 MHz; VBW \geq RBW; Sweep = as necessary to capture the entire dwell time per hopping channel; Detector function = peak; Trace = max hold.
6. Measure and record the results in the test report.

3.3.4 Test Setup

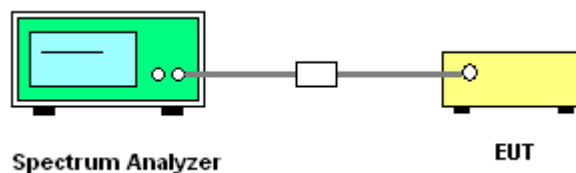



3.3.5 Test Result of Dwell Time

Test Mode :	DH5	Temperature :	24~26°C
Test Engineer :	Ting You	Relative Humidity :	50~53%

Mode	Hopping Channel Number	Hops Over Occupancy Time(hops)	Package Transfer Time (msec)	Dwell Time (sec)	Limits (sec)	Pass/Fail
Normal	79	106.67	2.890	0.31	0.4	Pass
AFH	20	53.33	2.890	0.15	0.4	Pass

Remark:

1. In normal mode, hopping rate is 1600 hops/s with 6 slots in 79 hopping channels.
 With channel hopping rate (1600 / 6 / 79) in Occupancy Time Limit (0.4 x 79) (s),
 Hops Over Occupancy Time comes to (1600 / 6 / 79) x (0.4 x 79) = 106.67 hops.
2. In AFH mode, hopping rate is 800 hops/s with 6 slots in 20 hopping channels.
 With channel hopping rate (800 / 6 / 20) in Occupancy Time Limit (0.4 x 20) (s),
 Hops Over Occupancy Time comes to (800 / 6 / 20) x (0.4 x 20) = 53.33 hops.
3. Dwell Time(s) = Hops Over Occupancy Time (hops) x Package Transfer Time



Package Transfer Time Plot

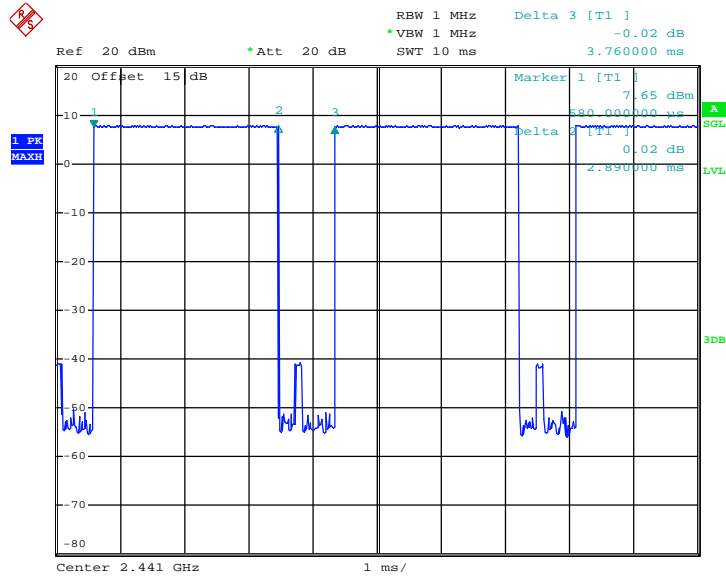

Date: 27.NOV.2014 09:48:39

3.4 20dB Bandwidth Measurement

3.4.1 Limit of 20dB Bandwidth

Reporting only

3.4.2 Measuring Instruments

The measuring equipment is listed in the section 4 of this test report.

3.4.3 Test Procedures

1. The testing follows FCC Public Notice DA 00-705 Measurement Guidelines.
2. The RF output of EUT was connected to the spectrum analyzer by RF cable and attenuator. The path loss was compensated to the results for each measurement.
3. Set to the maximum power setting and enable the EUT transmit continuously.
4. Use the following spectrum analyzer settings for 20dB Bandwidth measurement.
Span = approximately 2 to 3 times the 20 dB bandwidth, centered on a hopping channel;
RBW \geq 1% of the 20 dB bandwidth; VBW \geq RBW; Sweep = auto; Detector function = peak;
Trace = max hold.
5. Measure and record the results in the test report.

3.4.4 Test Setup

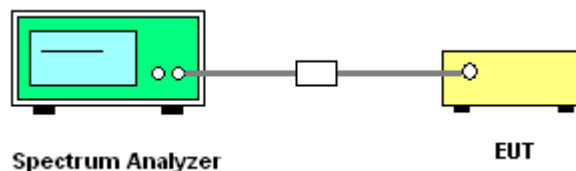



3.4.5 Test Result of 20dB Bandwidth

Test Mode :	1Mbps	Temperature :	24~26°C
Test Engineer :	Ting You	Relative Humidity :	50~53%

Channel	Frequency (MHz)	20dB Bandwidth (MHz)
00	2402	0.928
39	2441	0.928
78	2480	0.852

20 dB Bandwidth Plot on Channel 00

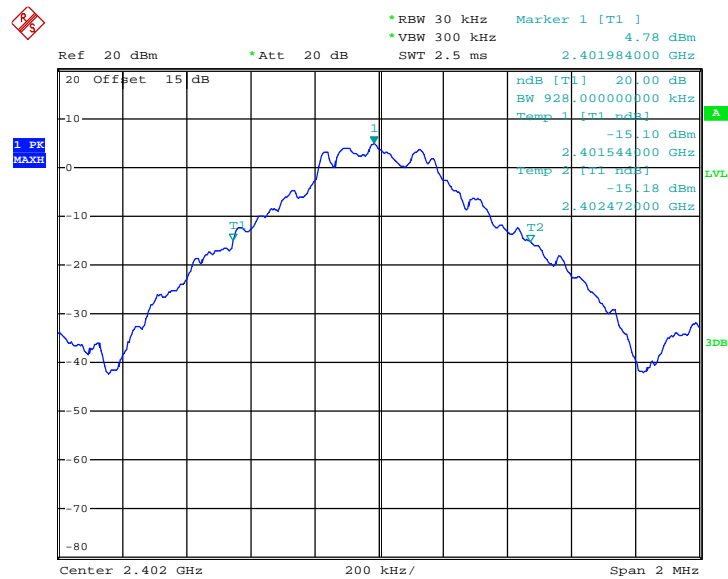

Date: 28.NOV.2014 14:22:56



20 dB Bandwidth Plot on Channel 39

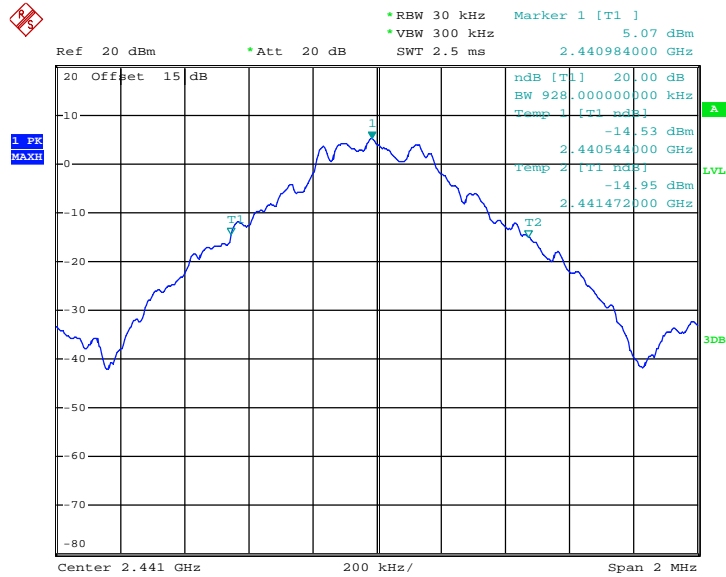

Date: 28.NOV.2014 14:25:50

20 dB Bandwidth Plot on Channel 78

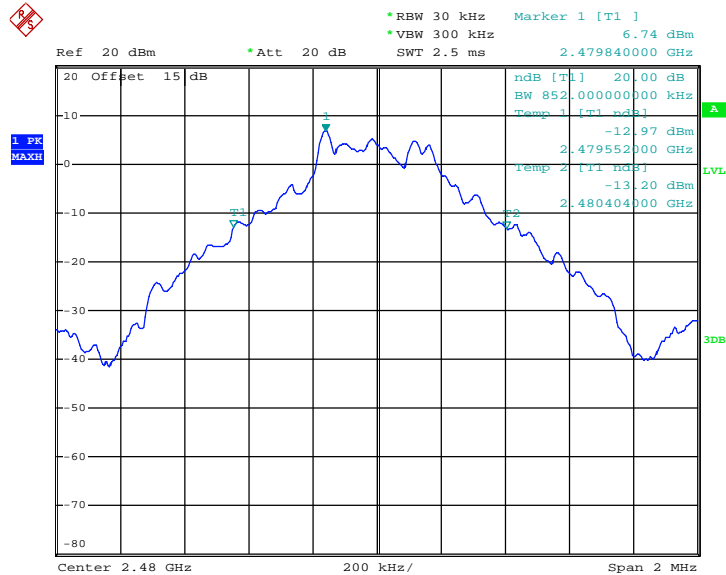

Date: 28.NOV.2014 14:26:30



Test Mode :	2Mbps	Temperature :	24~26°C
Test Engineer :	Ting You	Relative Humidity :	50~53%

Channel	Frequency (MHz)	20dB Bandwidth (MHz)
00	2402	1.272
39	2441	1.272
78	2480	1.236

20 dB Bandwidth Plot on Channel 00

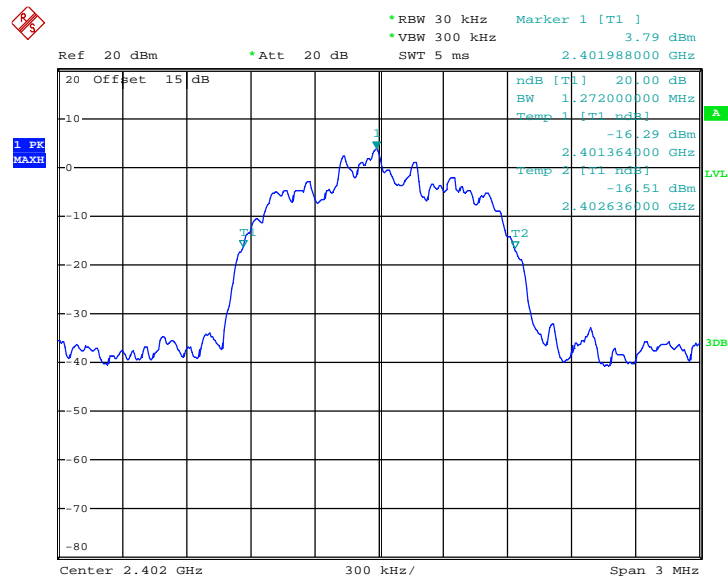

Date: 28.NOV.2014 14:27:09



20 dB Bandwidth Plot on Channel 39

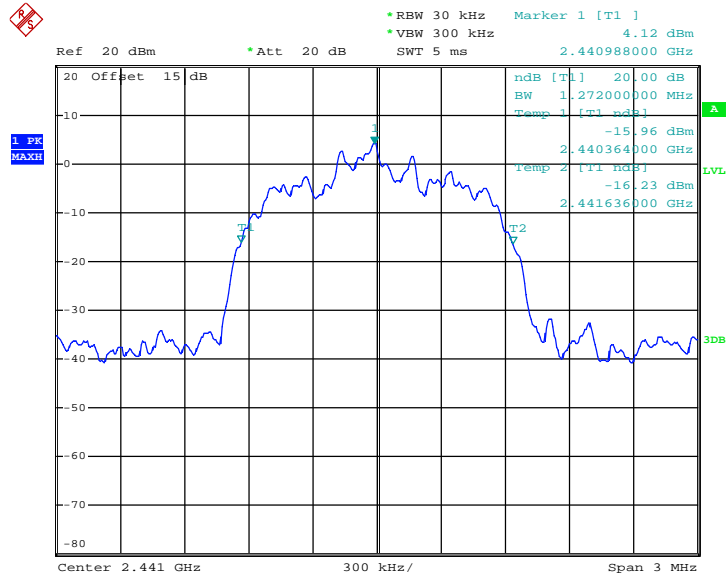

Date: 28.NOV.2014 14:27:40

20 dB Bandwidth Plot on Channel 78

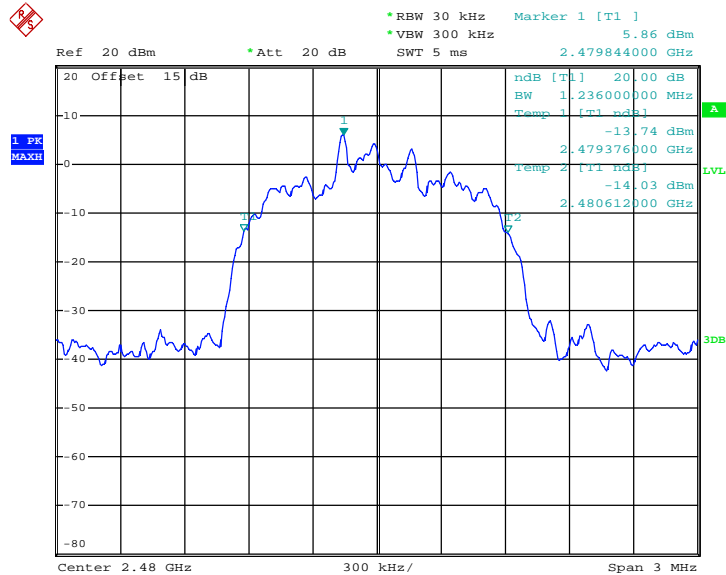

Date: 28.NOV.2014 14:27:59



Test Mode :	3Mbps	Temperature :	24~26°C
Test Engineer :	Ting You	Relative Humidity :	50~53%

Channel	Frequency (MHz)	20dB Bandwidth (MHz)
00	2402	1.248
39	2441	1.254
78	2480	1.254

20 dB Bandwidth Plot on Channel 00

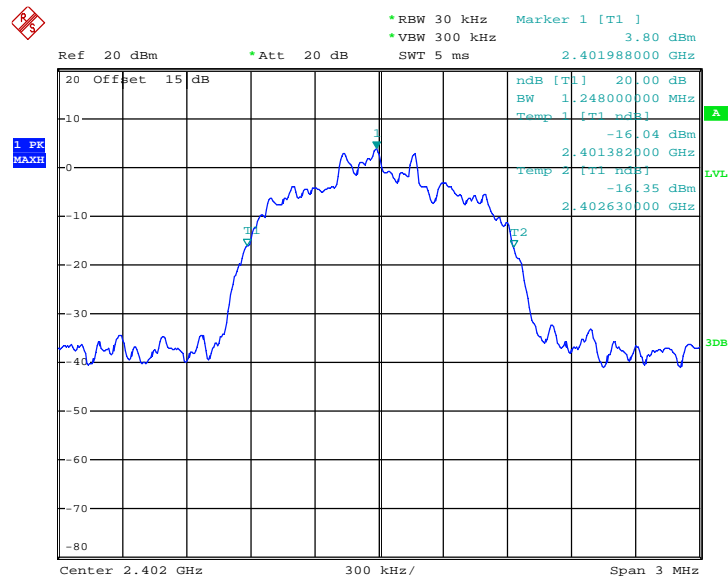

Date: 28.NOV.2014 14:28:29



20 dB Bandwidth Plot on Channel 39

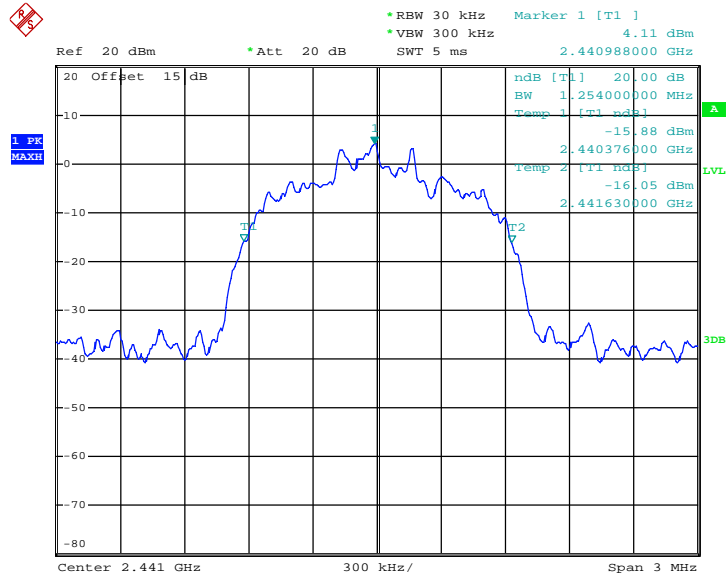

Date: 28.NOV.2014 14:28:43

20 dB Bandwidth Plot on Channel 78

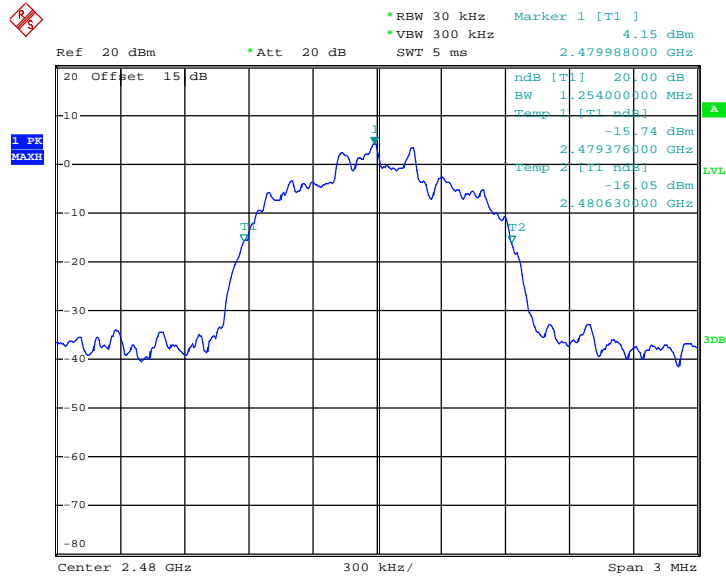

Date: 28.NOV.2014 14:35:48

3.5 Peak Output Power Measurement

3.5.1 Limit of Peak Output Power

Section 15.247 (b) The maximum peak conducted output power of the intentional radiator shall not exceed the following: (1) For frequency hopping systems operating in the 2400-2483.5 MHz band employing at least 75 non-overlapping hopping channels, and all frequency hopping systems in the 5725-5850 MHz band: 1 watt. For all other frequency hopping systems in the 2400-2483.5 MHz band 0.125 watts.

3.5.2 Measuring Instruments

The measuring equipment is listed in the section 4 of this test report.

3.5.3 Test Procedures

1. The testing follows FCC Public Notice DA 00-705 Measurement Guidelines.
2. The RF output of EUT was connected to the power meter by RF cable and attenuator. The path loss was compensated to the results for each measurement.
3. Set to the maximum power setting and enable the EUT transmit continuously.
4. Measure the conducted output power with cable loss and record the results in the test report.
5. Measure and record the results in the test report.

3.5.4 Test Setup

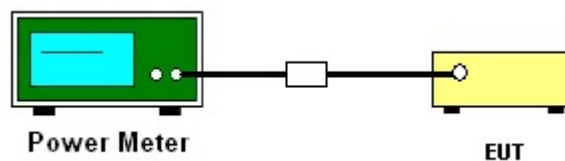



3.5.5 Test Result of Peak Output Power

Test Mode :	1Mbps	Temperature :	24~26°C
Test Engineer :	Ting You	Relative Humidity :	50~53%

Channel	Frequency (MHz)	RF Power (dBm)		
		GFSK	Max. Limits (dBm)	Pass/Fail
		1 Mbps		
00	2402	7.80	20.97	Pass
39	2441	8.13	20.97	Pass
78	2480	8.15	20.97	Pass

Test Mode :	2Mbps	Temperature :	24~26°C
Test Engineer :	Ting You	Relative Humidity :	50~53%

Channel	Frequency (MHz)	RF Power (dBm)		
		$\pi/4$ -DQPSK	Max. Limits (dBm)	Pass/Fail
		2 Mbps		
00	2402	7.65	20.97	Pass
39	2441	7.77	20.97	Pass
78	2480	7.89	20.97	Pass

Test Mode :	3Mbps	Temperature :	24~26°C
Test Engineer :	Ting You	Relative Humidity :	50~53%

Channel	Frequency (MHz)	RF Power (dBm)		
		8-DPSK	Max. Limits (dBm)	Pass/Fail
		3 Mbps		
00	2402	7.74	20.97	Pass
39	2441	8.06	20.97	Pass
78	2480	8.08	20.97	Pass

3.6 Conducted Band Edges Measurement

3.6.1 Limit of Band Edges

In any 100 kHz bandwidth outside the intentional radiation frequency band, the radio frequency power shall be at least 20 dB below the highest level of the radiated power. In addition, radiated emissions which fall in the restricted bands must also comply with the radiated emission limits.

3.6.2 Measuring Instruments

The measuring equipment is listed in the section 4 of this test report.

3.6.3 Test Procedures

1. The testing follows the guidelines in Band-edge Compliance of RF Conducted Emissions of FCC Public Notice DA 00-705 Measurement Guidelines.
2. Set to the maximum power setting and enable the EUT transmit continuously.
3. Set RBW = 100kHz ($\geq 1\%$ span=10MHz), VBW = 300kHz (\geq RBW). Band edge emissions must be at least 20 dB down from the highest emission level within the authorized band as measured with a 100kHz RBW. The attenuation shall be 30 dB instead of 20 dB when RMS conducted output power procedure is used.
4. Enable hopping function of the EUT and then repeat step 2. and 3.
5. Measure and record the results in the test report.

3.6.4 Test Setup

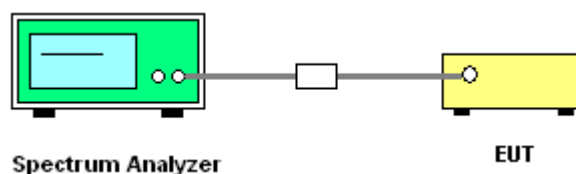



3.6.5 Test Result of Conducted Band Edges

Test Mode :	1Mbps	Temperature :	24~26°C
Test Channel :	00 and 78	Relative Humidity :	50~53%
		Test Engineer :	Ting You

Low Band Edge Plot on Channel 00

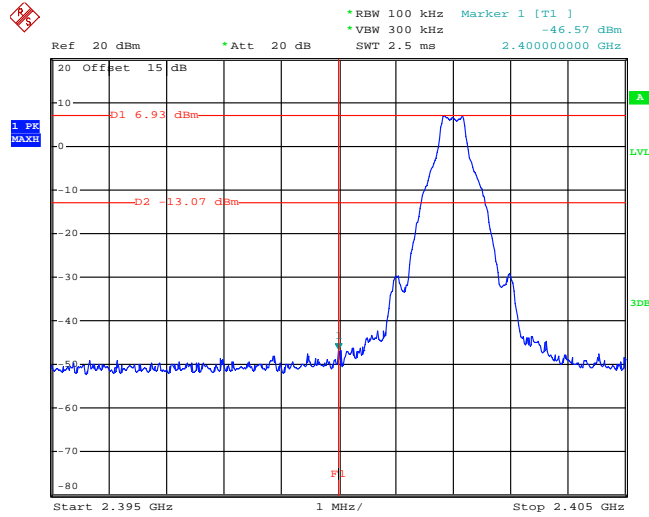

Date: 28.NOV.2014 17:37:33

High Band Edge Plot on Channel 78

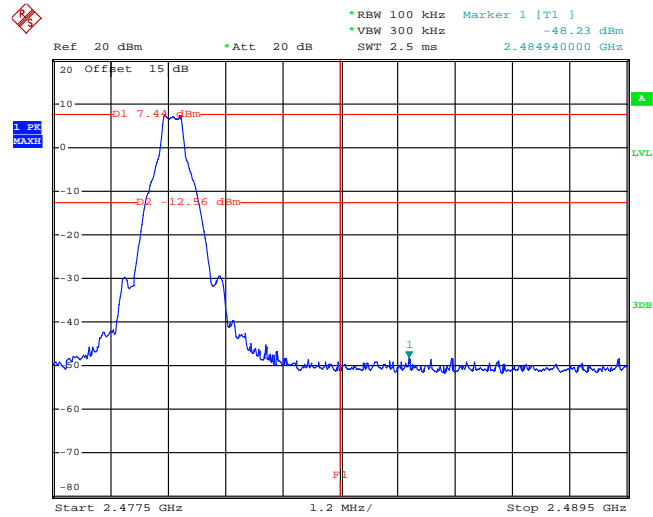

Date: 28.NOV.2014 17:40:47



Test Mode :	2Mbps	Temperature :	24~26°C
Test Channel :	00 and 78	Relative Humidity :	50~53%
		Test Engineer :	Ting You

Low Band Edge Plot on Channel 00

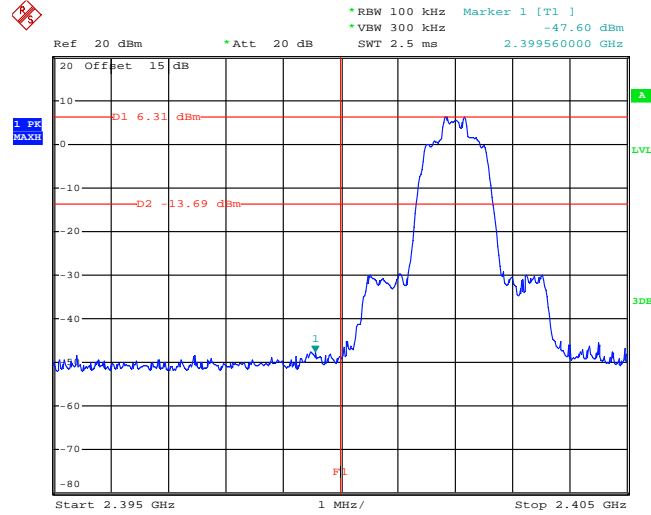

Date: 28.NOV.2014 17:38:14

High Band Edge Plot on Channel 78

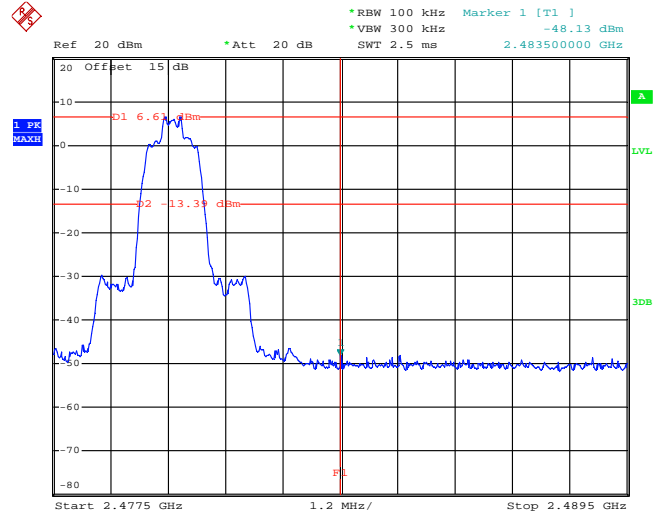

Date: 28.NOV.2014 17:39:58



Test Mode :	3Mbps	Temperature :	24~26°C
Test Channel :	00 and 78	Relative Humidity :	50~53%
		Test Engineer :	Ting You

Low Band Edge Plot on Channel 00

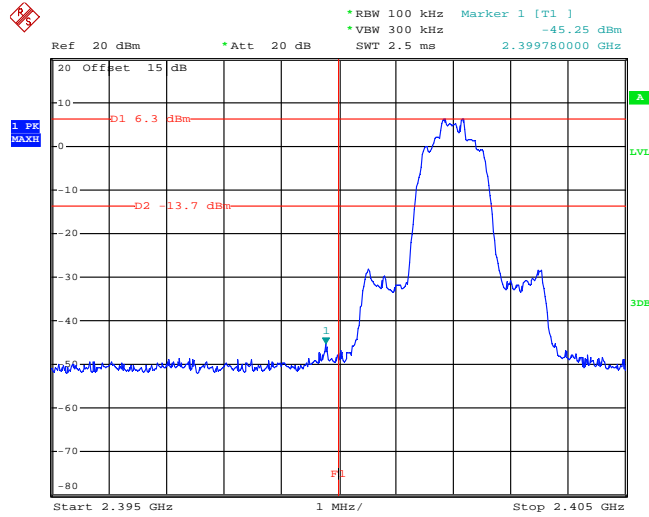

Date: 28.NOV.2014 17:38:39

High Band Edge Plot on Channel 78

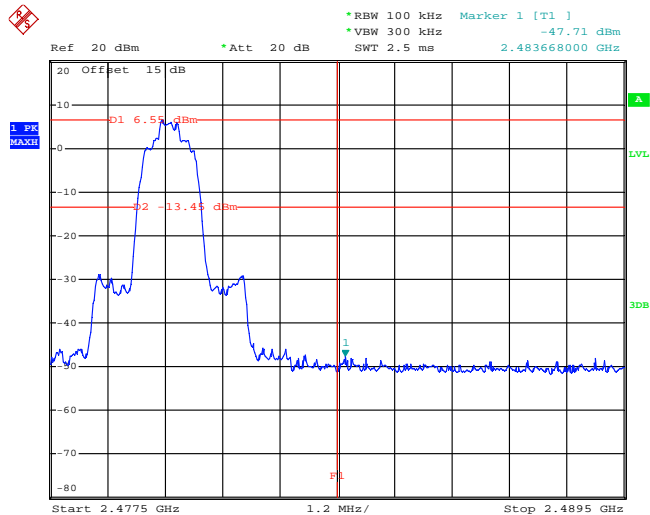

Date: 28.NOV.2014 17:39:26



3.6.6 Test Result of Conducted Hopping Mode Band Edges

Test Mode :	1Mbps	Temperature :	24~26°C
Test Engineer :	Ting You	Relative Humidity :	50~53%

1Mbps Hopping Mode Low Band Edge Plot

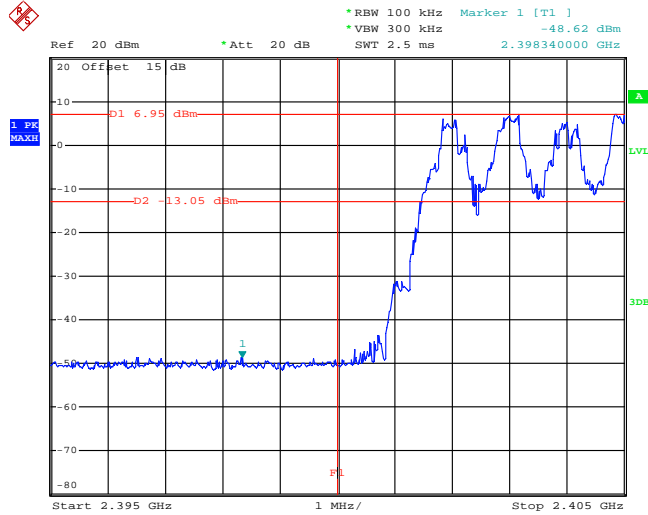

Date: 28.NOV.2014 17:55:39

1Mbps Hopping Mode High Band Edge Plot

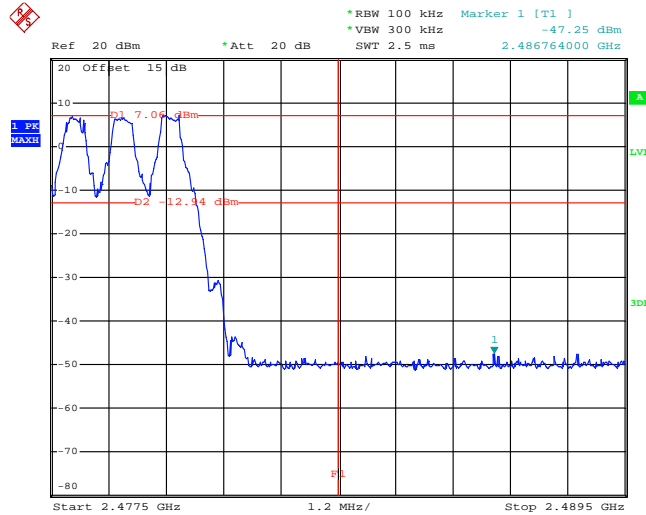

Date: 28.NOV.2014 17:43:59



Test Mode :	2Mbps	Temperature :	24~26°C
Test Engineer :	Ting You	Relative Humidity :	50~53%

2Mbps Hopping Mode Low Band Edge Plot

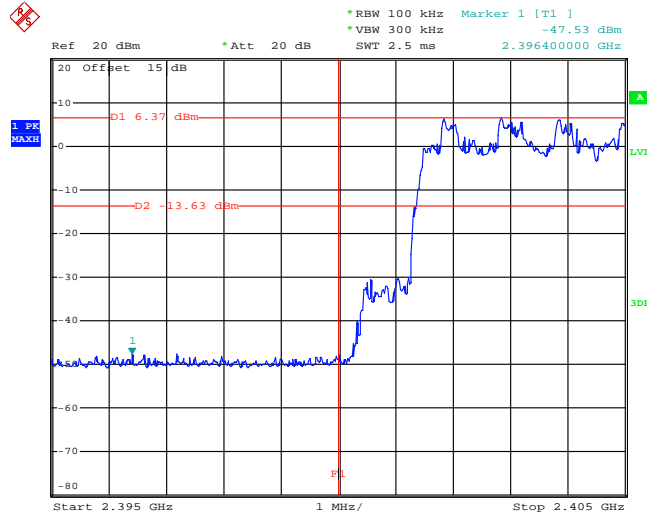

Date: 28.NOV.2014 17:59:04

2Mbps Hopping Mode High Band Edge Plot

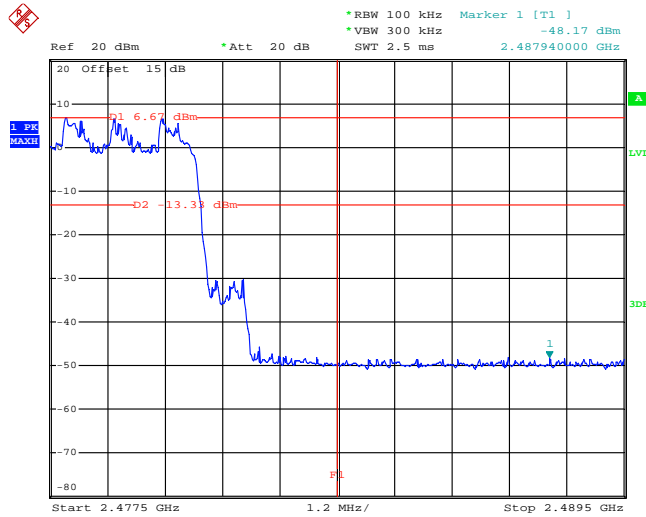

Date: 28.NOV.2014 17:46:38



Test Mode :	3Mbps	Temperature :	24~26°C
Test Engineer :	Ting You	Relative Humidity :	50~53%

3Mbps Hopping Mode Low Band Edge Plot

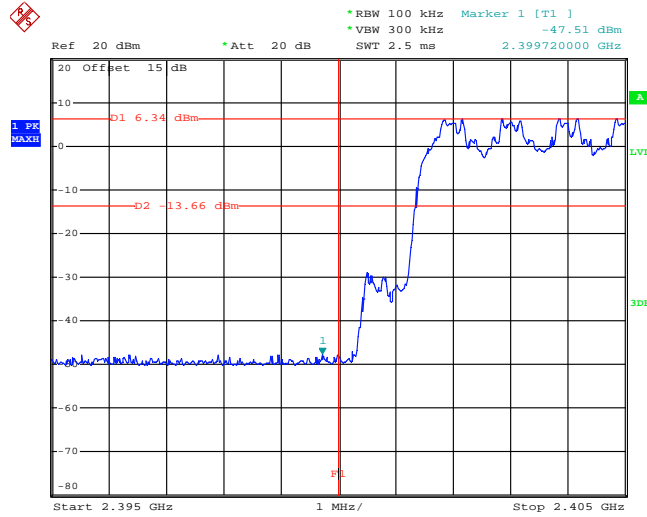

Date: 28.NOV.2014 17:53:49

3Mbps Hopping Mode High Band Edge Plot

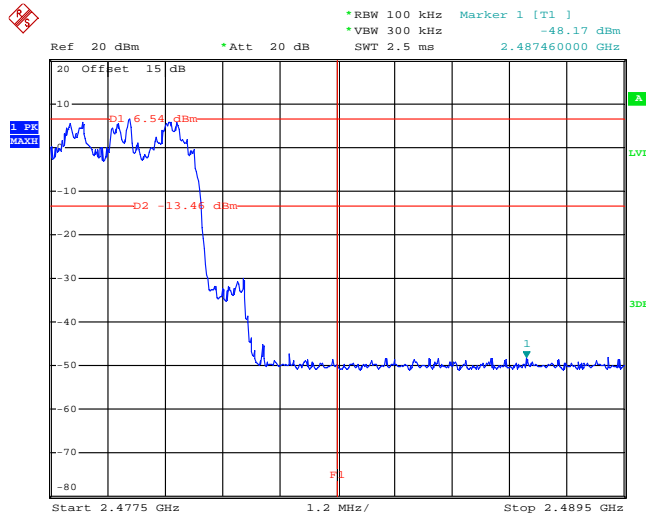

Date: 28.NOV.2014 17:48:00

3.7 Conducted Spurious Emission Measurement

3.7.1 Limit of Spurious Emission Measurement

In any 100 kHz bandwidth outside the intentional radiation frequency band, the radio frequency power shall be at least 20 dB below the highest level of the radiated power. In addition, radiated emissions which fall in the restricted bands must also comply with the radiated emission limits.

3.7.2 Measuring Instruments

The measuring equipment is listed in the section 4 of this test report.

3.7.3 Test Procedure

1. The testing follows the guidelines in Spurious RF Conducted Emissions of FCC Public Notice DA 00-705 Measurement Guidelines
2. The RF output of EUT was connected to the spectrum analyzer by RF cable and attenuator. The path loss was compensated to the results for each measurement.
3. Set to the maximum power setting and enable the EUT transmit continuously.
4. Set RBW = 100 kHz, VBW = 300kHz, scan up through 10th harmonic. All harmonics / spurs must be at least 20 dB down from the highest emission level within the authorized band as measured with a 100 kHz RBW.
5. Measure and record the results in the test report.
6. The RF fundamental frequency should be excluded against the limit line in the operating frequency band.

3.7.4 Test Setup

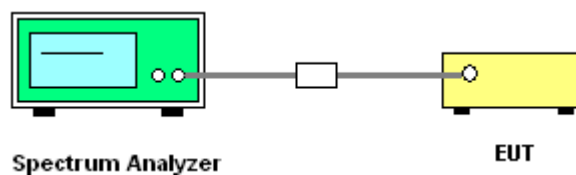



3.7.5 Test Result of Conducted Spurious Emission

Test Mode :	1Mbps	Temperature :	24~26°C
Test Channel :	00	Relative Humidity :	50~53%
		Test Engineer :	Ting You

1Mbps CSE Plot on Ch 00 between 30MHz ~ 3 GHz

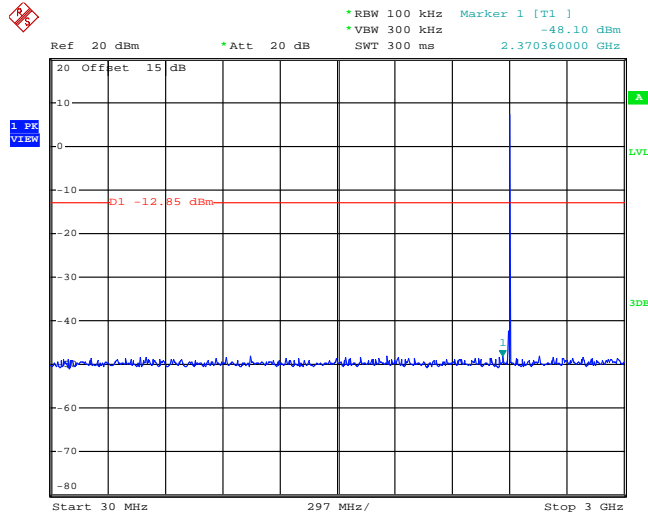

Date: 28.NOV.2014 14:42:10

1Mbps CSE Plot on Ch 00 between 2 GHz ~ 25 GHz

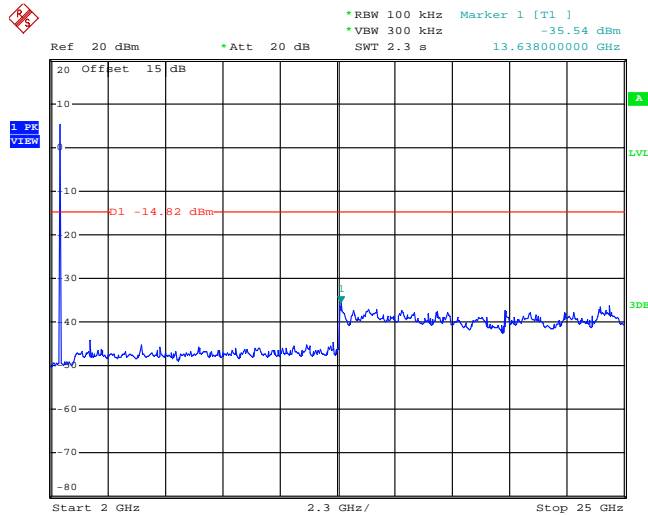

Date: 28.NOV.2014 14:43:02



Test Mode :	1Mbps	Temperature :	24~26°C
Test Channel :	39	Relative Humidity :	50~53%
		Test Engineer :	Ting You

1Mbps CSE Plot on Ch 39 between 30MHz ~ 3 GHz

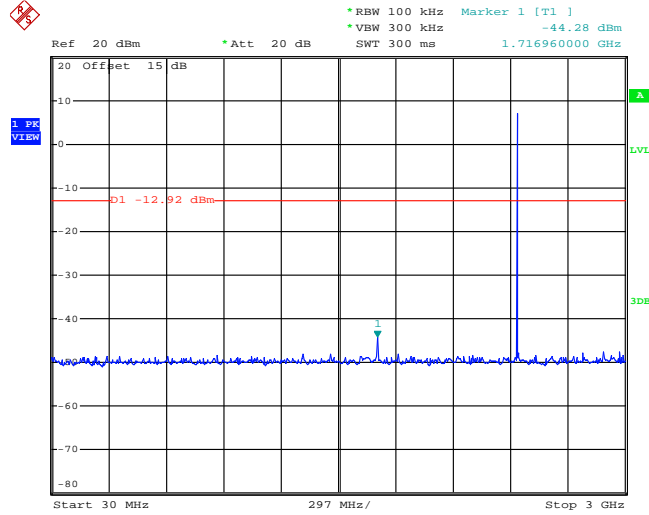

Date: 28.NOV.2014 14:43:55

1Mbps CSE Plot on Ch 39 between 2 GHz ~ 25 GHz

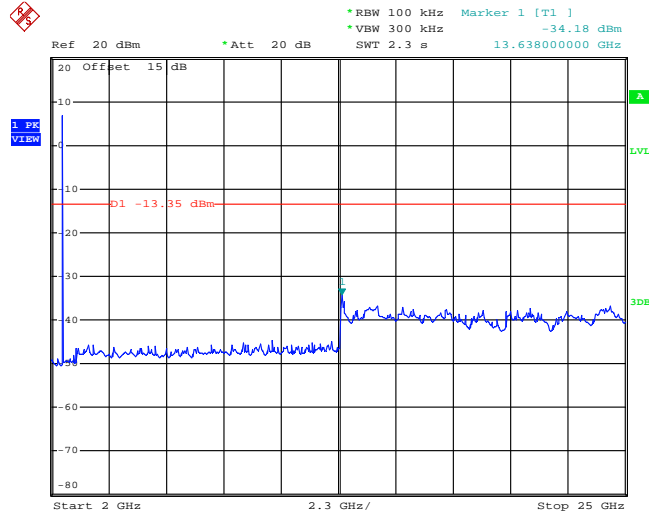

Date: 28.NOV.2014 14:44:47



Test Mode :	1Mbps	Temperature :	24~26°C
Test Channel :	78	Relative Humidity :	50~53%
		Test Engineer :	Ting You

1Mbps CSE Plot on Ch 78 between 30MHz ~ 3 GHz

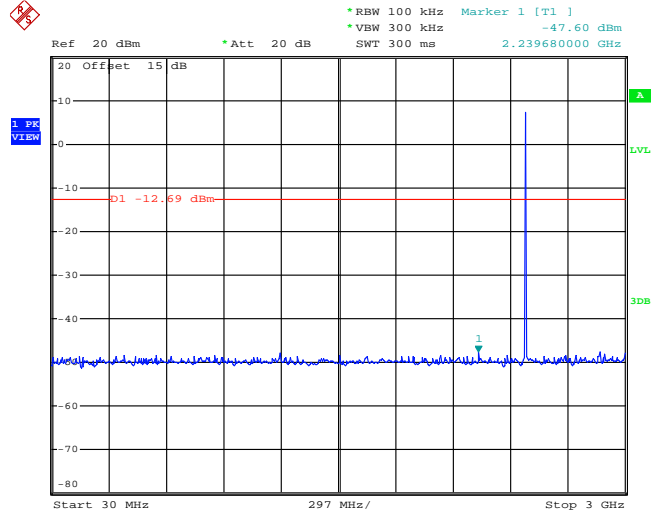

Date: 28.NOV.2014 14:45:39

1Mbps CSE Plot on Ch 78 between 2 GHz ~ 25 GHz

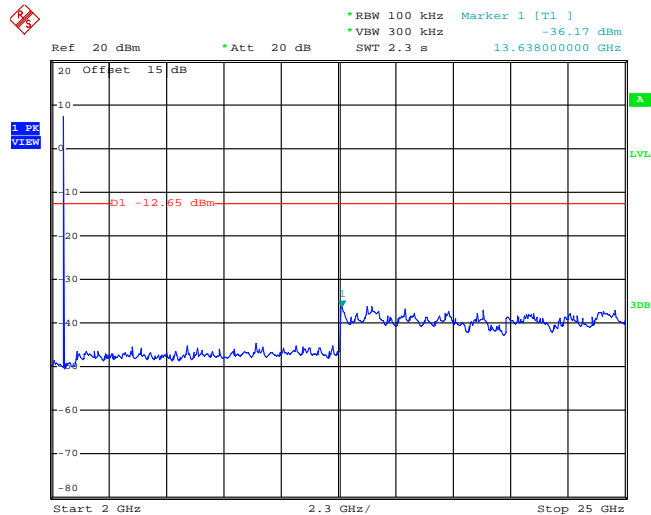

Date: 28.NOV.2014 14:46:31



Test Mode :	2Mbps	Temperature :	24~26°C
Test Channel :	00	Relative Humidity :	50~53%
		Test Engineer :	Ting You

2Mbps CSE Plot on Ch 00 between 30MHz ~ 3 GHz

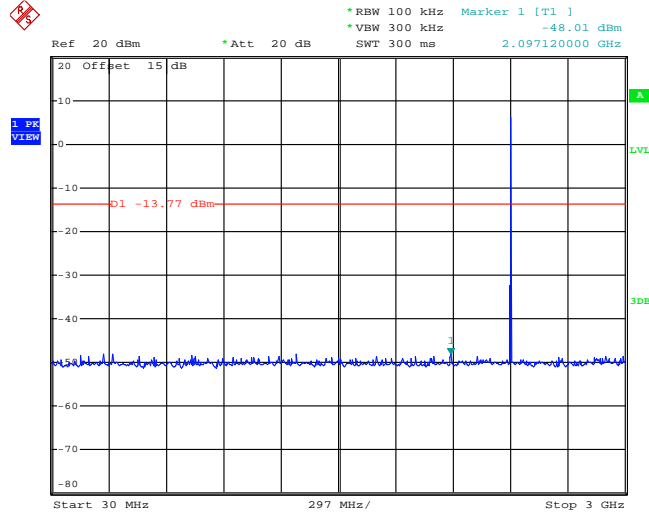

Date: 28.NOV.2014 17:25:11

2Mbps CSE Plot on Ch 00 between 2 GHz ~ 25 GHz

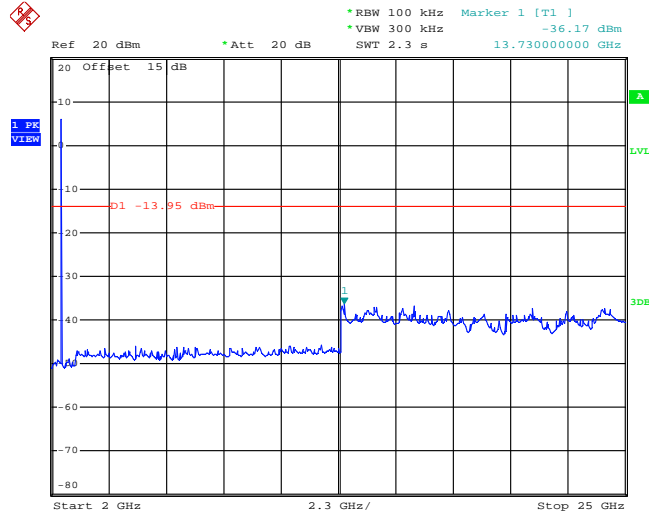

Date: 28.NOV.2014 17:25:32



Test Mode :	2Mbps	Temperature :	24~26°C
Test Channel :	39	Relative Humidity :	50~53%
		Test Engineer :	Ting You

2Mbps CSE Plot on Ch 39 between 30MHz ~ 3 GHz

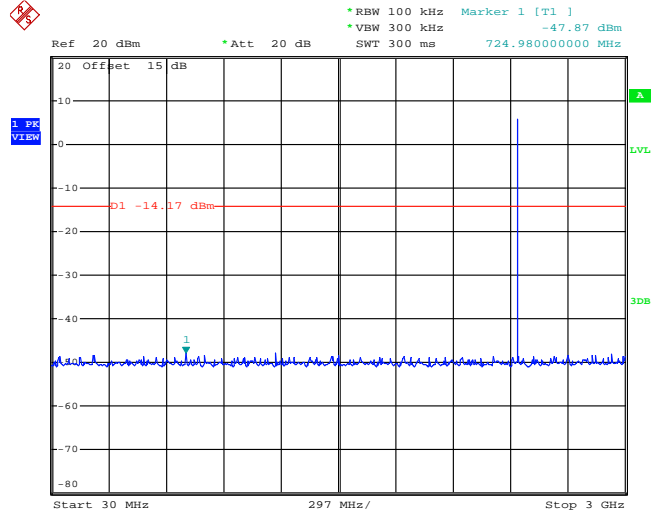

Date: 28.NOV.2014 15:34:40

2Mbps CSE Plot on Ch 39 between 2 GHz ~ 25 GHz

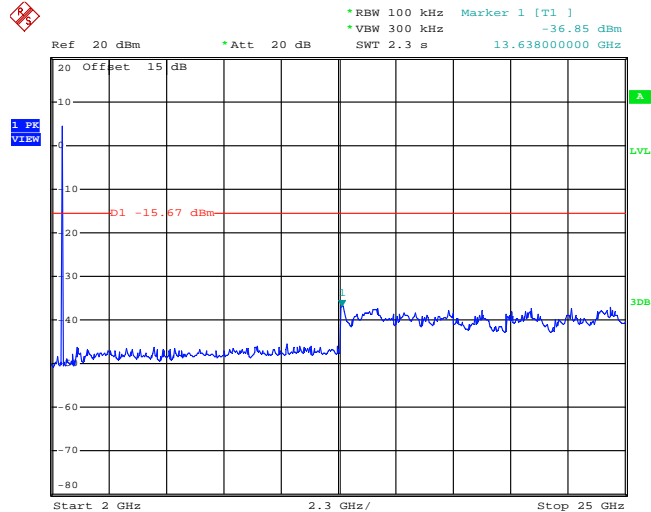

Date: 28.NOV.2014 15:35:02



Test Mode :	2Mbps	Temperature :	24~26°C
Test Channel :	78	Relative Humidity :	50~53%
		Test Engineer :	Ting You

2Mbps CSE Plot on Ch 78 between 30MHz ~ 3 GHz

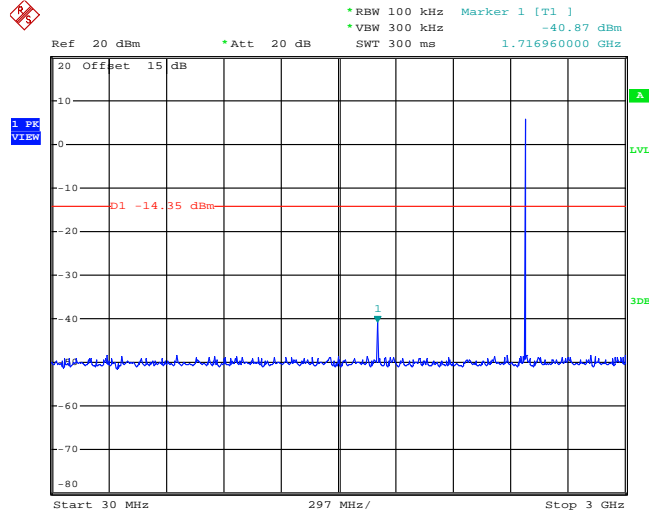

Date: 28.NOV.2014 15:35:31

2Mbps CSE Plot on Ch 78 between 2 GHz ~ 25 GHz

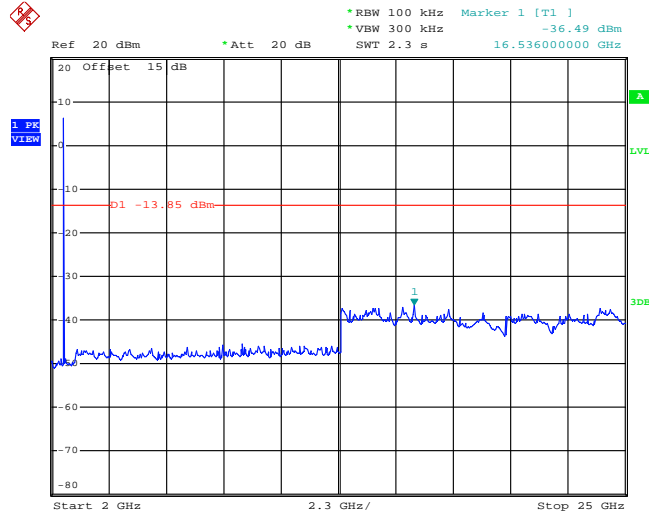

Date: 28.NOV.2014 15:35:53



Test Mode :	3Mbps	Temperature :	24~26°C
Test Channel :	00	Relative Humidity :	50~53%
		Test Engineer :	Ting You

3Mbps CSE Plot on Ch 00 between 30MHz ~ 3 GHz

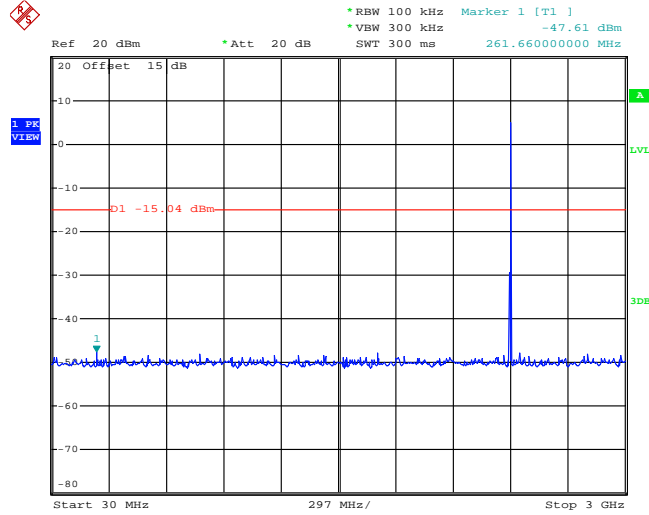

Date: 28.NOV.2014 17:34:55

3Mbps CSE Plot on Ch 00 between 2 GHz ~ 25 GHz

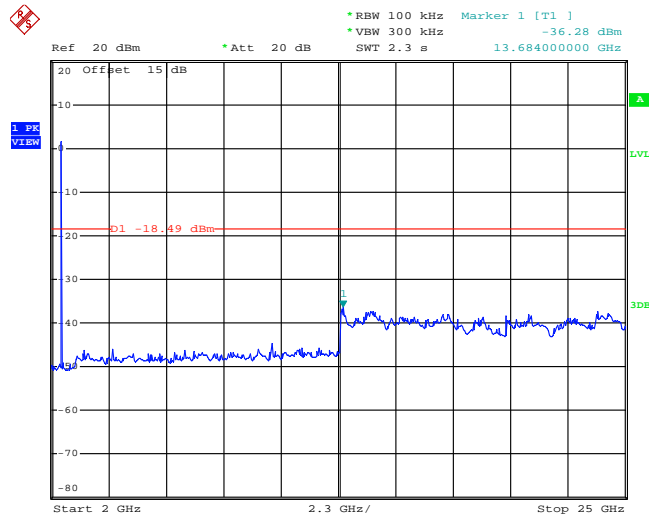

Date: 28.NOV.2014 17:35:17



Test Mode :	3Mbps	Temperature :	24~26°C
Test Channel :	39	Relative Humidity :	50~53%
		Test Engineer :	Ting You

3Mbps CSE Plot on Ch 39 between 30MHz ~ 3 GHz

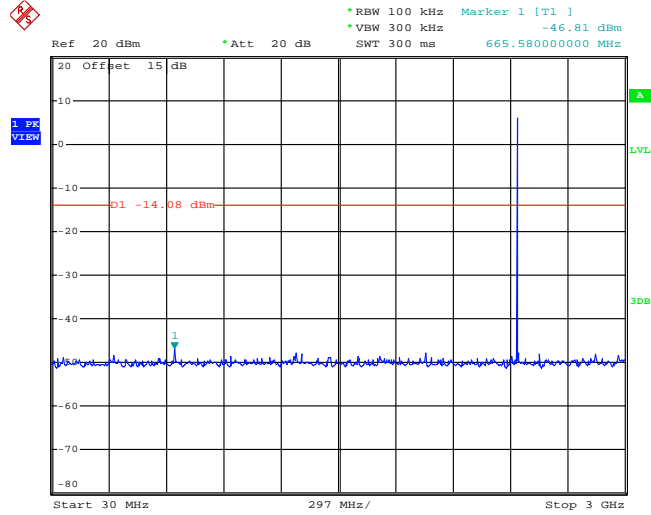

Date: 28.NOV.2014 15:42:15

3Mbps CSE Plot on Ch 39 between 2 GHz ~ 25 GHz

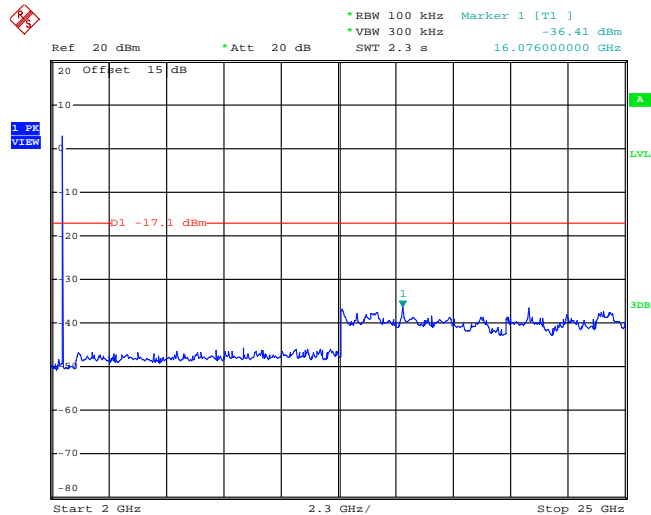

Date: 28.NOV.2014 15:42:36



Test Mode :	3Mbps	Temperature :	24~26°C
Test Channel :	78	Relative Humidity :	50~53%
		Test Engineer :	Ting You

3Mbps CSE Plot on Ch 78 between 30MHz ~ 3 GHz

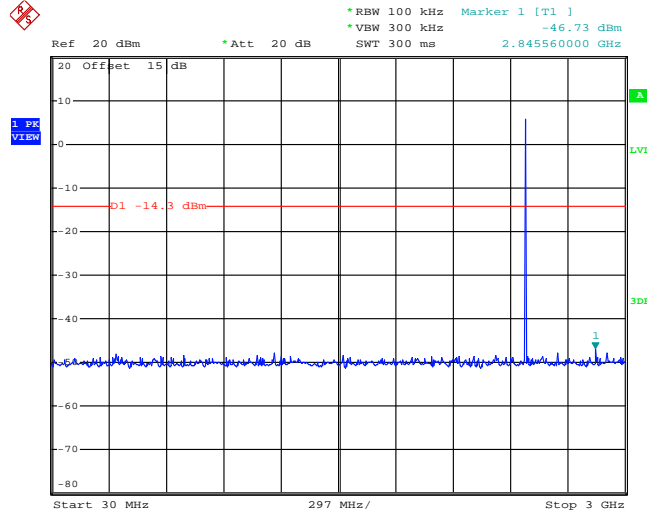

Date: 28.NOV.2014 15:43:14

3Mbps CSE Plot on Ch 78 between 2 GHz ~ 25 GHz

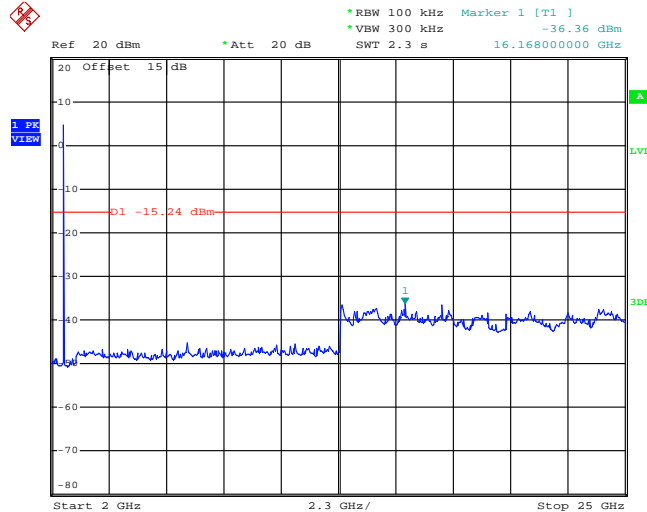

Date: 28.NOV.2014 15:43:36



3.8 Radiated Band Edges and Spurious Emission Measurement

3.8.1 Limit of Radiated Band Edges and Spurious Emission

In any 100 kHz bandwidth outside the intentional radiator frequency band, all harmonics/spurious must be at least 20 dB below the highest emission level within the authorized band. In addition, radiated emissions which fall in the restricted bands must also comply with the FCC section 15.209 limits as below.

Frequency (MHz)	Field Strength (microvolts/meter)	Measurement Distance (meters)
0.009 – 0.490	2400/F(kHz)	300
0.490 – 1.705	24000/F(kHz)	30
1.705 – 30.0	30	30
30 – 88	100	3
88 – 216	150	3
216 - 960	200	3
Above 960	500	3

3.8.2 Measuring Instruments

The measuring equipment is listed in the section 4 of this test report.



3.8.3 Test Procedures

1. The testing follows the guidelines in Spurious Radiated Emissions of FCC Public Notice DA 00-705 Measurement Guidelines.
2. The EUT was placed on a turntable with 0.8 meter above ground.
3. The EUT was set 3 meters from the interference receiving antenna, which was mounted on the top of a variable height antenna tower.
4. For each suspected emission, the EUT was arranged to its worst case and then tune the Antenna tower (from 1 m to 4 m) and turntable (from 0 degree to 360 degrees) to find the maximum reading. A pre-amp and a high pass filter are used for the test in order to get better signal level to comply with the guidelines.
5. Set to the maximum power setting and enable the EUT transmit continuously.
6. Use the following spectrum analyzer settings:
 - (1) Span shall wide enough to fully capture the emission being measured;
 - (2) Set RBW=100 kHz for $f < 1$ GHz, RBW=1MHz for $f > 1$ GHz ; VBW \geq RBW; Sweep = auto; Detector function = peak; Trace = max hold for peak
 - (3) For average measurement: use duty cycle correction factor method per 15.35(c).
Duty cycle = On time/100 milliseconds
On time = $N_1 * L_1 + N_2 * L_2 + \dots + N_{n-1} * L_{n-1} + N_n * L_n$
Where N_1 is number of type 1 pulses, L_1 is length of type 1 pulses, etc.
Average Emission Level = Peak Emission Level + $20 * \log(\text{Duty cycle})$
7. Corrected Reading: Antenna Factor + Cable Loss + Read Level - Preamp Factor = Level

Note: The average levels were calculated from the peak level corrected with duty cycle correction factor (-24.82dB) derived from $20 \log(\text{dwell time}/100\text{ms})$. This correction is only for signals that hop with the fundamental signal, such as band-edge and harmonic. Other spurious signals that are independent of the hopping signal would not use this correction.

3.8.4 Test Setup

For radiated emissions below 30MHz

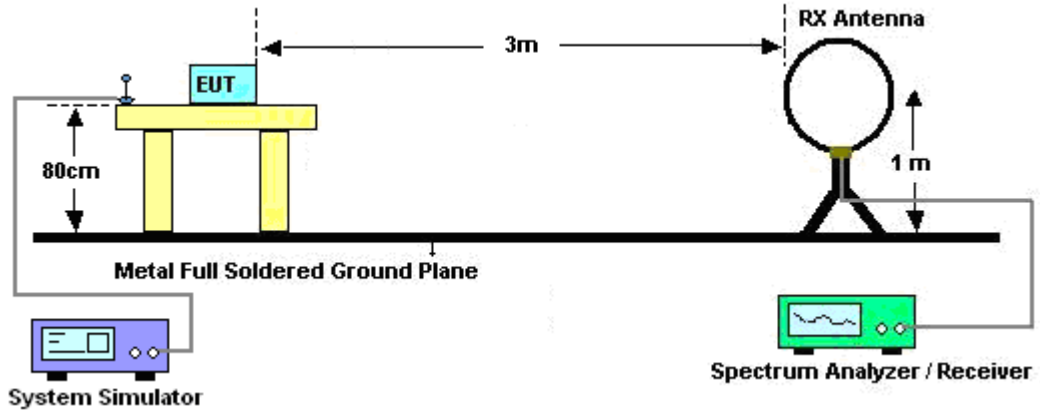

For radiated emissions from 30MHz to 1GHz

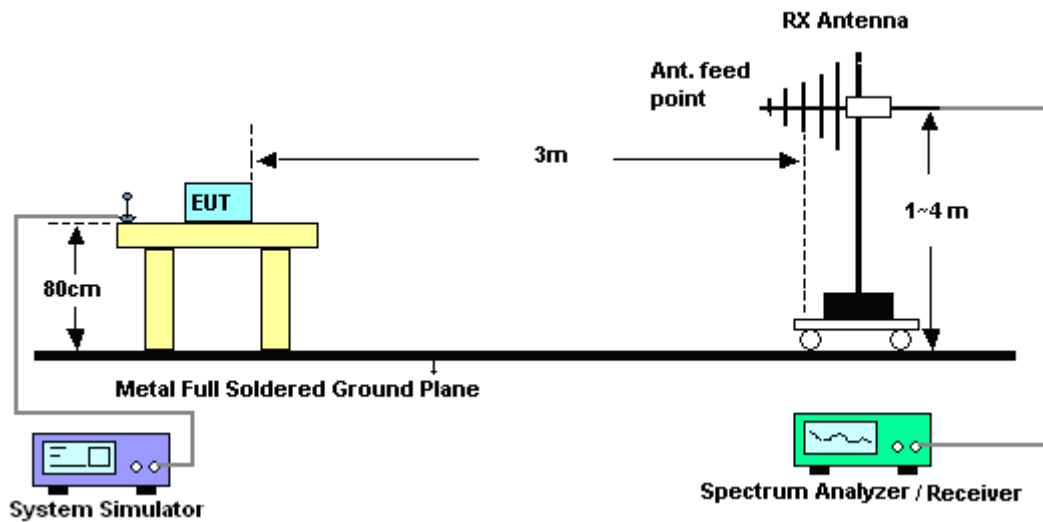

For radiated emissions above 1GHz

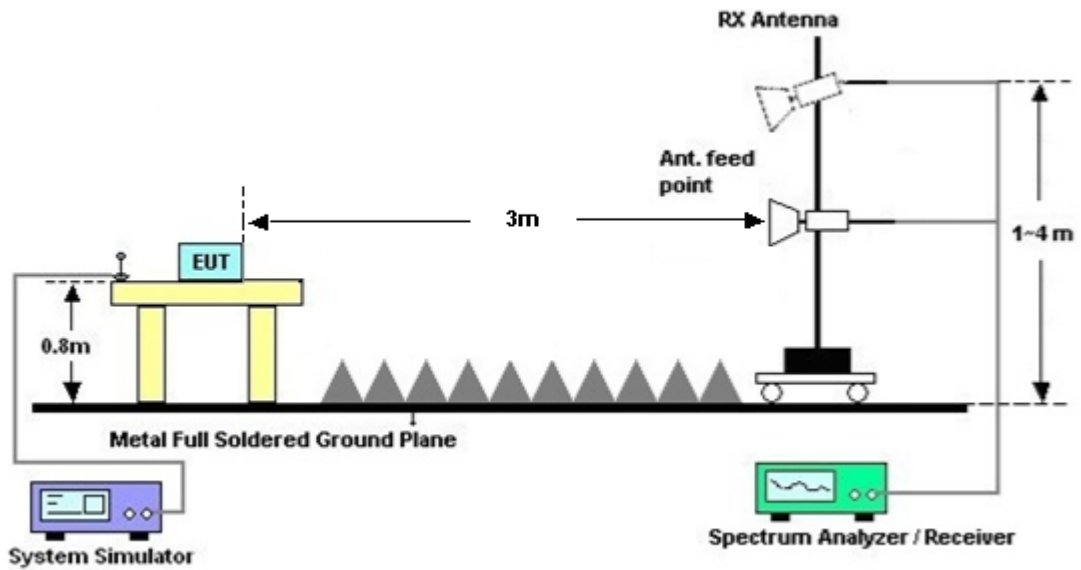

3.8.5 Test Results of Radiated Spurious Emissions (9 kHz ~ 30 MHz)

The low frequency, which started from 9 kHz to 30MHz, was pre-scanned and the result which was 20dB lower than the limit line per 15.31(o) was not reported.



3.8.6 Duty cycle correction factor for average measurement

DH5 on time (One Pulse) Plot on Channel 39

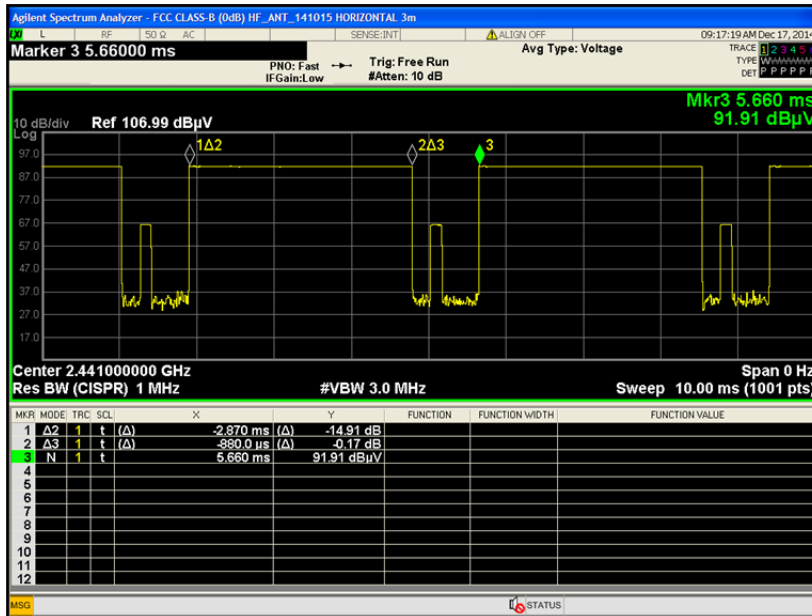

DH5 on time (Count Pulses) Plot on Channel 39

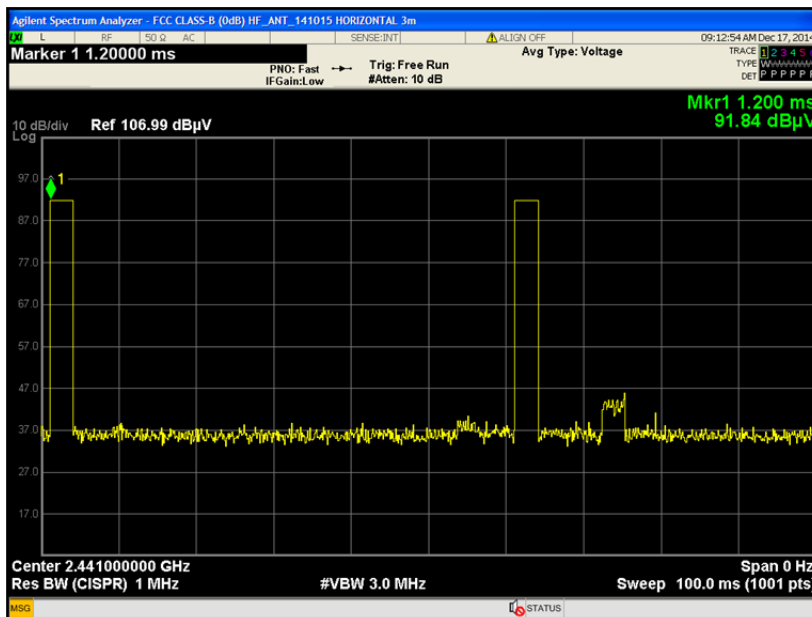

Note:

1. Worst case Duty cycle = on time/100 milliseconds = $2 * 2.87 / 100 = 5.74 \%$
2. Worst case Duty cycle correction factor = $20 * \log(\text{Duty cycle}) = -24.82 \text{ dB}$
3. DH5 has the highest duty cycle worst case and is reported.



Duty Cycle Correction Factor Consideration for AFH mode:

Bluetooth normal hopping rate is 1600Hz and reduced to 800Hz in AFH mode; due to the reduced number of hopping frequencies, with the same packet configuration the dwell time in each channel frequency within 100msec period is longer in AFH mode than normal mode.

In AFH mode, the minimum hopping frequencies are 20, to get the longest dwell time DH5 packet is observed; the period to have DH5 packet completing one hopping sequence is

$$2.87 \text{ ms} \times 20 \text{ channels} = 57.4 \text{ ms}$$

There cannot be 2 complete hopping sequences within 100ms period, considering the random hopping behavior, maximum 2 hops can be possibly observed within the period. $[100\text{ms} / 57.6\text{ms}] = 2$ hops

Thus, the maximum possible ON time:

$$2.87 \text{ ms} \times 2 = 5.74 \text{ ms}$$

Worst case Duty Cycle Correction factor, which is derived from the maximum possible ON time,

$$20 \times \log(5.74 \text{ ms}/100\text{ms}) = -24.82 \text{ dB}$$

3.8.7 Test Result of Radiated Spurious at Band Edges

Please refer to Appendix A.

3.8.8 Test Result of Radiated Spurious Emission (30MHz ~ 10th Harmonic)

Please refer to Appendix A.

3.9 AC Conducted Emission Measurement

3.9.1 Limit of AC Conducted Emission

For equipment that is designed to be connected to the public utility (AC) power line, the radio frequency voltage that is conducted back onto the AC power line on any frequency or frequencies within the band 150 kHz to 30 MHz shall not exceed the limits in the following table.

Frequency of emission (MHz)	Conducted limit (dB μ V)	
	Quasi-peak	Average
0.15-0.5	66 to 56*	56 to 46*
0.5-5	56	46
5-30	60	50

*Decreases with the logarithm of the frequency.

3.9.2 Measuring Instruments

The measuring equipment is listed in the section 4 of this test report.

3.9.3 Test Procedures

1. The EUT was placed 0.4 meter from the conducting wall of the shielding room was kept at least 80 centimeters from any other grounded conducting surface.
2. Connect EUT to the power mains through a line impedance stabilization network (LISN).
3. All the support units are connecting to the other LISN.
4. The LISN provides 50 ohm coupling impedance for the measuring instrument.
5. The FCC states that a 50 ohm, 50 microhenry LISN should be used.
6. Both sides of AC line were checked for maximum conducted interference.
7. The frequency range from 150 kHz to 30 MHz was searched.
8. Set the test-receiver system to Peak Detect Function and specified bandwidth (IF Bandwidth = 9kHz) with Maximum Hold Mode. Then measurement is also conducted by Average Detector and Quasi-Peak Detector Function respectively.

3.9.4 Test Setup

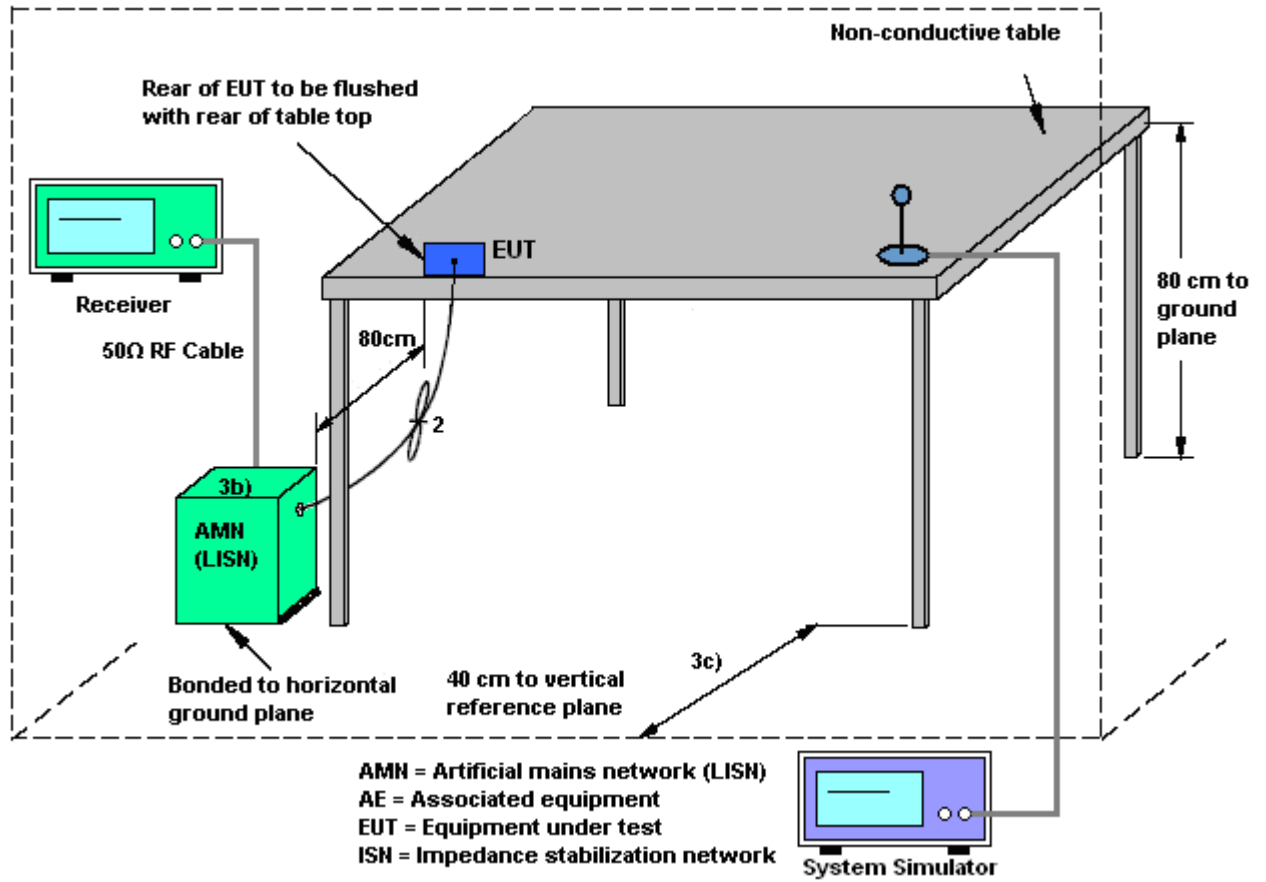



3.9.5 Test Result of AC Conducted Emission

Test Mode :	Mode 1	Temperature :	21~22°C
Test Engineer :	Jack Tian	Relative Humidity :	41~42%
Test Voltage :	120Vac / 60Hz	Phase :	Line
Function Type :	GSM850 Idle + Bluetooth Link + WLAN Link + Earphone 2 + USB Cable (Charging from Adapter 2) + Cradle for Sample 1		

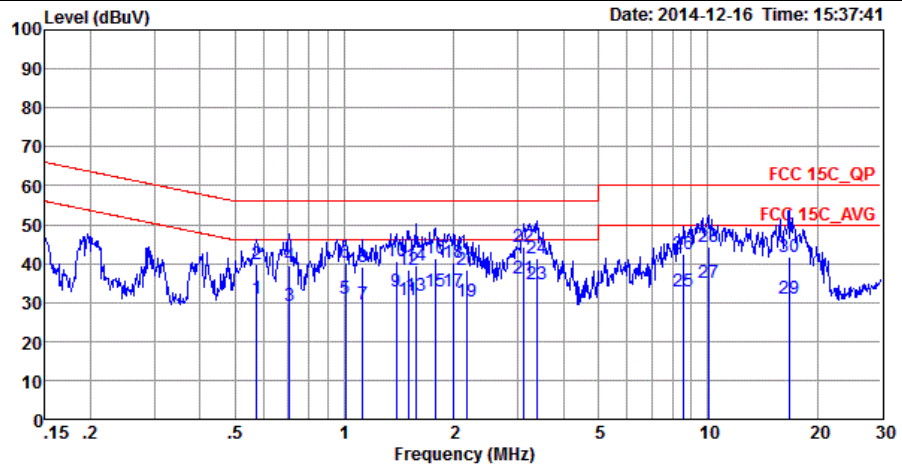

Site : C001-SZ
 Condition: FCC 15C_QP LISN_L_20140304 LINE
 Project : (FR)4N1402
 Mode : Mode 1
 IMEI : 354661060011146

	Freq	Level	Over	Limit	Read	LISN	Cable	
	MHz	dBuV	Limit	Line	Level	Factor	Loss	Remark
			dB	dBuV	dBuV	dB	dB	
1	0.57	31.10	-14.90	46.00	20.70	0.25	10.15	Average
2	0.57	40.00	-16.00	56.00	29.60	0.25	10.15	QP
3	0.70	29.23	-16.77	46.00	18.90	0.18	10.15	Average
4	0.70	39.63	-16.37	56.00	29.30	0.18	10.15	QP
5	1.00	31.11	-14.89	46.00	20.70	0.26	10.15	Average
6	1.00	40.21	-15.79	56.00	29.80	0.26	10.15	QP
7	1.12	29.41	-16.59	46.00	19.00	0.25	10.16	Average
8	1.12	39.21	-16.79	56.00	28.80	0.25	10.16	QP
9	1.39	32.71	-13.29	46.00	22.30	0.24	10.17	Average
10	1.39	40.61	-15.39	56.00	30.20	0.24	10.17	QP
11	1.50	30.71	-15.29	46.00	20.30	0.24	10.17	Average
12	1.50	38.51	-17.49	56.00	28.10	0.24	10.17	QP
13	1.57	31.81	-14.19	46.00	21.40	0.23	10.18	Average
14	1.57	39.51	-16.49	56.00	29.10	0.23	10.18	QP
15	1.78	32.81	-13.19	46.00	22.40	0.23	10.18	Average
16	1.78	41.31	-14.69	56.00	30.90	0.23	10.18	QP
17	1.99	33.01	-12.99	46.00	22.60	0.22	10.19	Average
18	1.99	40.11	-15.89	56.00	29.70	0.22	10.19	QP
19	2.18	30.23	-15.77	46.00	19.80	0.24	10.19	Average
20	2.18	38.23	-17.77	56.00	27.80	0.24	10.19	QP
21 *	3.12	36.13	-9.87	46.00	25.60	0.32	10.21	Average
22	3.12	44.23	-11.77	56.00	33.70	0.32	10.21	QP
23	3.40	34.76	-11.24	46.00	24.20	0.34	10.22	Average
24	3.40	41.26	-14.74	56.00	30.70	0.34	10.22	QP
25	8.59	32.94	-17.06	50.00	22.11	0.53	10.30	Average
26	8.59	42.44	-17.56	60.00	31.61	0.53	10.30	QP
27	10.02	34.97	-15.03	50.00	24.00	0.65	10.32	Average
28	10.02	44.27	-15.73	60.00	33.30	0.65	10.32	QP
29	16.75	31.10	-18.90	50.00	18.99	1.54	10.57	Average
30	16.75	41.60	-18.40	60.00	29.49	1.54	10.57	QP



Test Mode :	Mode 1	Temperature :	21~22°C
Test Engineer :	Jack Tian	Relative Humidity :	41~42%
Test Voltage :	120Vac / 60Hz	Phase :	Neutral
Function Type :	GSM850 Idle + Bluetooth Link + WLAN Link + Earphone 2 + USB Cable (Charging from Adapter 2) + Cradle for Sample 1		

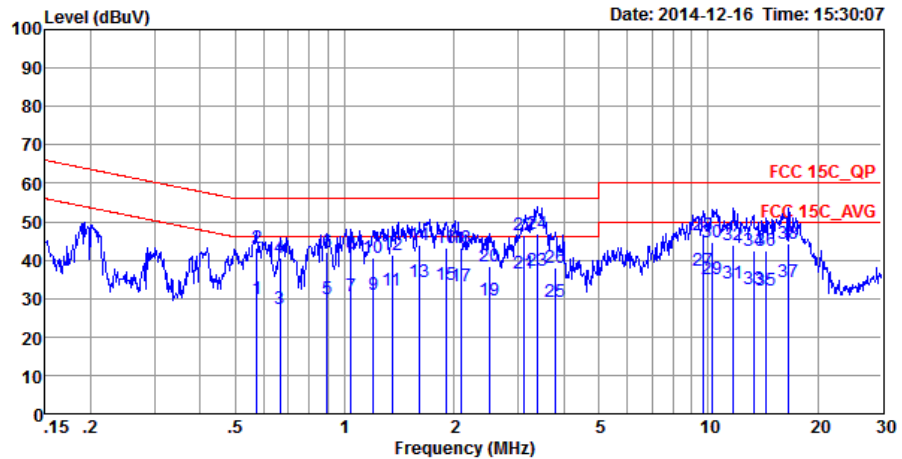

Site : CO01-SZ
 Condition: FCC 15C_QP LISN_N_20140304 NEUTRAL
 Mode : Mode 1

	Freq	Level	Over Limit	Limit Line	Read Level	LISN Factor	Cable Loss	Remark
	MHz	dBuV	dB	dBuV	dBuV	dB	dB	
1	0.57	29.90	-16.10	46.00	19.40	0.35	10.15	Average
2	0.57	43.20	-12.80	56.00	32.70	0.35	10.15	QP
3	0.66	27.13	-18.87	46.00	16.70	0.28	10.15	Average
4	0.66	40.43	-15.57	56.00	30.00	0.28	10.15	QP
5	0.89	29.95	-16.05	46.00	19.50	0.30	10.15	Average
6	0.89	42.15	-13.85	56.00	31.70	0.30	10.15	QP
7	1.04	30.68	-15.32	46.00	20.20	0.33	10.15	Average
8	1.04	41.78	-14.22	56.00	31.30	0.33	10.15	QP
9	1.20	30.90	-15.10	46.00	20.40	0.34	10.16	Average
10	1.20	40.60	-15.40	56.00	30.10	0.34	10.16	QP
11	1.35	32.11	-13.89	46.00	21.59	0.35	10.17	Average
12	1.35	41.41	-14.59	56.00	30.89	0.35	10.17	QP
13	1.61	34.13	-11.87	46.00	23.59	0.36	10.18	Average
14	1.61	43.83	-12.17	56.00	33.29	0.36	10.18	QP
15	1.90	33.75	-12.25	46.00	23.19	0.37	10.19	Average
16	1.90	43.05	-12.95	56.00	32.49	0.37	10.19	QP
17	2.09	33.37	-12.63	46.00	22.80	0.38	10.19	Average
18	2.09	43.17	-12.83	56.00	32.60	0.38	10.19	QP
19	2.50	29.70	-16.30	46.00	19.10	0.40	10.20	Average
20	2.50	38.40	-17.60	56.00	27.80	0.40	10.20	QP
21	3.11	36.64	-9.36	46.00	26.00	0.43	10.21	Average
22	3.11	46.44	-9.56	56.00	35.80	0.43	10.21	QP
23 *	3.38	37.16	-8.84	46.00	26.50	0.44	10.22	Average
24	3.38	46.76	-9.24	56.00	36.10	0.44	10.22	QP
25	3.78	28.98	-17.02	46.00	18.31	0.45	10.22	Average
26	3.78	38.18	-17.82	56.00	27.51	0.45	10.22	QP
27	9.71	37.11	-12.89	50.00	26.10	0.69	10.32	Average
28	9.71	46.31	-13.69	60.00	35.30	0.69	10.32	QP
29	10.29	35.01	-14.99	50.00	23.91	0.77	10.33	Average



Test Mode :	Mode 1	Temperature :	21~22°C
Test Engineer :	Jack Tian	Relative Humidity :	41~42%
Test Voltage :	120Vac / 60Hz	Phase :	Neutral
Function Type :	GSM850 Idle + Bluetooth Link + WLAN Link + Earphone 2 + USB Cable (Charging from Adapter 2) + Cradle for Sample 1		

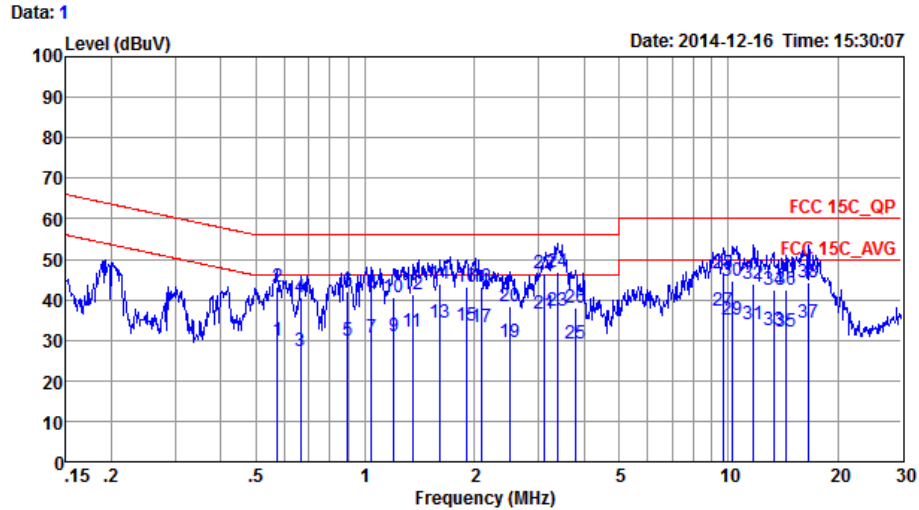

Site : C001-SZ
 Condition: FCC 15C_QP LISN_N_20140304 NEUTRAL

Mode : Mode 1

	Freq	Level	Over Limit	Limit Line	Read Level	LISN Factor	Cable Loss	Remark
	MHz	dBuV	dB	dBuV	dBuV	dB	dB	
30	10.29	44.51	-15.49	60.00	33.41	0.77	10.33	QP
31	11.74	33.96	-16.04	50.00	22.50	1.06	10.40	Average
32	11.74	43.76	-16.24	60.00	32.30	1.06	10.40	QP
33	13.34	32.32	-17.68	50.00	20.50	1.35	10.47	Average
34	13.34	42.42	-17.58	60.00	30.60	1.35	10.47	QP
35	14.36	31.92	-18.08	50.00	19.90	1.51	10.51	Average
36	14.36	42.52	-17.48	60.00	30.50	1.51	10.51	QP
37	16.66	34.22	-15.78	50.00	22.00	1.65	10.57	Average
38	16.66	44.42	-15.58	60.00	32.20	1.65	10.57	QP



3.10 Antenna Requirements

3.10.1 Standard Applicable

If directional gain of transmitting antennas is greater than 6dBi, the power shall be reduced by the same level in dB comparing to gain minus 6dBi. The use of a permanently attached antenna or of an antenna that uses a unique coupling to the intentional radiator shall be considered sufficient to comply with the FCC rule.

3.10.2 Antenna Anti-Replacement Construction

An embedded-in antenna design is used.

3.10.3 Antenna Gain

The antenna peak gain of EUT is less than 6 dBi. Therefore, it is not necessary to reduce maximum peak output power limit.



4 List of Measuring Equipment

Instrument	Manufacturer	Model No.	Serial No.	Characteristics	Calibration Date	Test Date	Due Date	Remark
Spectrum Analyzer	R&S	FSP30	101400	9kHz~30GHz	Mar. 03, 2014	Nov. 27, 2014 Nov. 28, 2014	Mar. 02, 2015	Conducted (TH01-SZ)
Power Meter	Anritsu	ML2495A	1218010	13dBm ~-20dBm	Mar. 03, 2014	Nov. 27, 2014 Nov. 28, 2014	Mar. 02, 2015	Conducted (TH01-SZ)
Power Sensor	Dare	RPR3006W	TH01SZ00 019	0.3GHz~6GHz	Mar. 14, 2014	Nov. 27, 2014 Nov. 28, 2014	Mar. 13, 2015	Conducted (TH01-SZ)
ESCIO TEST Receiver	R&S	ESCI	100724	9kHz~3GHz	Feb. 21, 2014	Dec. 17, 2014	Feb. 20, 2015	Radiation (03CH01-SZ)
Spectrum Analyzer	Agilent Technologies	N9038A	MY522601 85	20Hz~26.5GHz	May 26, 2014	Dec. 17, 2014	May 25, 2015	Radiation (03CH01-SZ)
Loop Antenna	R&S	HFH2-Z2	100354	9kHz~30MHz	May 09, 2014	Dec. 17, 2014	May 08, 2015	Radiation (03CH01-SZ)
Bilog Antenna	TESEQ	CBL 6112D	37877	30MHz~2GHz	Oct. 15, 2014	Dec. 17, 2014	Oct. 14, 2015	Radiation (03CH01-SZ)
Double Ridge Horn Antenna	ETS Lindgren	3117	00119436	1GHz~18GHz	Oct. 15, 2014	Dec. 17, 2014	Oct. 14, 2015	Radiation (03CH01-SZ)
Double Ridged Horn Antenna	COM-POWER	AH-840	101073	18GHz~40GHz	Jun. 09, 2014	Dec. 17, 2014	Jun. 08, 2015	Radiation (03CH01-SZ)
Amplifier	ADVANTEST	BB525C	E9007003	9kHz~3000MHz	Feb. 21, 2014	Dec. 17, 2014	Feb. 20, 2015	Radiation (03CH01-SZ)
Amplifier	Yiai	AV3860B	04030	2GHz~26.5GHz	May 08, 2014	Dec. 17, 2014	May 07, 2015	Radiation (03CH01-SZ)
AC Source(AVR)	Chroma	61601	616010001 985	100Vac~250Vac	Mar. 25, 2014	Dec. 17, 2014	Mar. 24, 2015	Radiation (03CH01-SZ)
Turn Table	EM Electronics	EM 1000	N/A	0~360 degree	NCR	Dec. 17, 2014	NCR	Radiation (03CH01-SZ)
Antenna Mast	EM Electronics	EM 1000	N/A	1 m~4 m	NCR	Dec. 17, 2014	NCR	Radiation (03CH01-SZ)
ESCIO TEST Receiver	R&S	ESCI	100724	9kHz~3GHz	Feb. 21, 2014	Dec. 16, 2014	Feb. 20, 2015	Conduction (CO01-SZ)
AC LISN	EMCO	3816/2SH	00103912	9kHz~30MHz	Mar. 04, 2014	Dec. 16, 2014	Mar. 03, 2015	Conduction (CO01-SZ)
AC LISN (for auxiliary equipment)	EMCO	3816/2SH	00103892	9kHz~30MHz	Mar. 04, 2014	Dec. 16, 2014	Mar. 03, 2015	Conduction (CO01-SZ)
AC Power Source	Chroma	61602	616020000 891	100Vac~250Vac	Sep. 29, 2014	Dec. 16, 2014	Sep. 28, 2015	Conduction (CO01-SZ)



5 Uncertainty of Evaluation

Uncertainty of Conducted Emission Measurement (150 kHz ~ 30 MHz)

Measuring Uncertainty for a Level of Confidence of 95% ($U = 2Uc(y)$)	2.3dB
---	-------

Uncertainty of Radiated Emission Measurement (30 MHz ~ 1000 MHz)

Measuring Uncertainty for a Level of Confidence of 95% ($U = 2Uc(y)$)	3.9 dB
---	--------



Appendix A Radiated Spurious Emission

15C 2.4GHz 2400~2483.5MHz

BT (Band Edge @ 3m)

BT	Note	Frequency	Level	Over	Limit	Read	Antenna	Cable	Preamp	Ant	Table	Peak	Pol.
		(MHz)	(dBμV/m)	(dB)	(dBμV/m)	(dBμV)	(dB/m)	(dB)	(dB)	(cm)	(deg)	(P/A)	(H/V)
BT CH00 2402MHz		2369.8	50.5	-23.5	74	38.63	32.58	8.51	29.22	190	17	P	H
		2369.80	25.68	-28.32	54	-	-	-	-	190	17	A	H
	*	2402.00	104.7	-	-	92.76	32.6	8.6	29.26	190	17	P	H
	*	2402.00	79.88	-	-	-	-	-	-	190	17	A	H
		2362.26	50.74	-23.26	74	38.85	32.56	8.51	29.18	169	0	P	V
		2362.26	25.92	-28.08	54	-	-	-	-	169	0	A	V
	*	2402	99.33	-	-	87.39	32.6	8.6	29.26	169	0	P	V
	*	2402.00	74.51	-	-	-	-	-	-	169	0	A	V
BT CH 39 2441MHz		2364.91	50.94	-23.06	74	39.05	32.56	8.51	29.18	148	17	P	H
		2364.91	26.12	-27.88	54	-	-	-	-	148	17	A	H
	*	2441.00	104.39	-	-	92.25	32.65	8.69	29.2	148	17	P	H
	*	2441.00	79.57	-	-	-	-	-	-	148	17	A	H
		2485.75	51.33	-22.67	74	39.03	32.68	8.78	29.16	148	17	P	H
		2485.75	26.51	-27.49	54	-	-	-	-	148	17	A	H
		2365.48	50.81	-23.19	74	38.92	32.56	8.51	29.18	169	0	P	V
		2365.48	25.99	-28.01	54	-	-	-	-	169	0	A	V
	*	2441.00	99.6	-	-	87.46	32.65	8.69	29.2	169	0	P	V
	*	2441.00	74.78	-	-	-	-	-	-	169	0	A	V
		2498.29	50.27	-23.73	74	37.93	32.7	8.78	29.14	169	0	P	V
		2498.29	25.45	-28.55	54	-	-	-	-	169	0	A	V



BT CH 78 2480MHz	*	2480.00	105.41	-	-	93.11	32.68	8.78	29.16	190	17	P	H
	*	2480.00	80.59	-	-	-	-	-	-	190	17	A	H
		2483.9	53.42	-20.58	74	41.12	32.68	8.78	29.16	190	17	P	H
		2483.9	28.60	-25.40	54	-	-	-	-	190	17	A	H
	*	2480.00	99.83	-	-	87.53	32.68	8.78	29.16	100	312	P	V
	*	2480.00	75.01	-	-	-	-	-	-	100	312	A	V
		2492.16	51.66	-22.34	74	39.32	32.7	8.78	29.14	100	312	P	V
		2492.16	26.84	-27.16	54	-	-	-	-	100	312	A	V

Remark	<ol style="list-style-type: none"> All results are PASS against Peak and Average limit line. Frequency range of Radiated Band Edge is from 2310-2390 MHz and 2483.5-2500 MHz. Above only list the worst result in these frequency ranges. 												
--------	--	--	--	--	--	--	--	--	--	--	--	--	--



15C 2.4GHz 2400~2483.5MHz
BT (Harmonic @ 3m)

BT	Note	Frequency	Level	Over	Limit	Read	Antenna	Cable	Preamp	Ant	Table	Peak	Pol.
				Limit	Line	Level	Factor	Loss	Factor	Pos	Pos	Avg.	
		(MHz)	(dBμV/m)	(dB)	(dBμV/m)	(dBμV)	(dB/m)	(dB)	(dB)	(cm)	(deg)	(P/A)	(H/V)
BT CH 00 2402MHz		4804	39.3	-34.7	74	42.85	34.39	12.86	50.8	151	219	P	H
		4804	14.48	-39.52	54	-	-	-	-	151	219	A	H
		4804	39.45	-34.55	74	43	34.39	12.86	50.8	151	219	P	V
		4804	14.63	-39.37	54	-	-	-	-	151	219	A	V
BT CH 39 2441MHz		4882	43.03	-30.97	74	46.2	34.43	12.98	50.58	115	258	P	H
		4882	18.21	-35.79	54	-	-	-	-	115	258	A	H
		7323	45.02	-28.98	74	44.96	36.23	14.71	50.88	152	309	P	H
		7323	20.20	-33.80	54	-	-	-	-	152	309	A	H
		4882	42.98	-31.02	74	46.15	34.43	12.98	50.58	115	258	P	V
		4882	18.16	-35.84	54	-	-	-	-	115	258	A	V
		7323	45.03	-28.97	74	44.97	36.23	14.71	50.88	152	309	P	V
		7323	20.21	-33.79	54	-	-	-	-	152	309	A	V
BT CH 78 2480MHz		4960	38.44	-35.56	74	41.17	34.48	13.1	50.31	118	289	P	H
		4960	13.62	-40.38	54	-	-	-	-	118	289	A	H
		7440	45.25	-28.75	74	45.08	36.28	14.77	50.88	158	273	P	H
		7440	20.43	-33.57	54	-	-	-	-	158	273	A	H
		4960	38.36	-35.64	74	41.09	34.48	13.1	50.31	118	289	P	V
		4960	13.54	-40.46	54	-	-	-	-	118	289	A	V
		7440	43.92	-30.08	74	43.75	36.28	14.77	50.88	158	273	P	V
		7440	19.1	-34.9	54	-	-	-	-	158	273	A	V
Remark	1. Other harmonics are lower than background noise. 2. All results are PASS against Peak and Average limit line.												



15C Emission below 1GHz

2.4GHz BT (LF)

BT	Note	Frequency	Level	Over	Limit	Read	Antenna	Cable	Preamp	Ant	Table	Peak	Pol.
		(MHz)	(dBμV/m)	(dB)	(dBμV/m)	(dBμV)	(dB/m)	(dB)	(dB)	(cm)	(deg)	(P/A)	(H/V)
2.4GHz BT LF		30	21.67	-18.33	40	32.66	18.9	0.85	30.74	200	0	P	H
		103.72	20.24	-23.26	43.5	37.91	11.52	1.57	30.76	-	-	P	H
		267.65	26.09	-19.91	46	41.87	12.2	2.57	30.55	-	-	P	H
		485.9	21.9	-24.1	46	31.18	17.28	3.54	30.1	-	-	P	H
		739.07	26.53	-19.47	46	31.5	20.2	4.44	29.61	-	-	P	H
		966.05	27.53	-26.47	54	29.84	21.3	5.09	28.7	-	-	P	H
		60.07	26.93	-13.07	40	51.72	4.8	1.18	30.77	100	0	P	V
		266.68	21.54	-24.46	46	37.27	12.25	2.57	30.55	-	-	P	V
		472.32	23.32	-22.68	46	32.86	17.16	3.47	30.17	-	-	P	V
		653.71	24.97	-21.03	46	31.63	18.56	4.23	29.45	-	-	P	V
		858.38	26.77	-19.23	46	30.25	20.78	4.83	29.09	-	-	P	V
	897.18	30.02	-15.98	46	33.51	20.68	4.86	29.03	-	-	P	V	

Remark	1. All results are PASS against limit line.												
--------	---	--	--	--	--	--	--	--	--	--	--	--	--



Note symbol

*	Fundamental Frequency which can be ignored. However, the level of any unwanted emissions shall not exceed the level of the fundamental frequency per 15.209(c).
!	Test result is over limit line.
P/A	Peak or Average
H/V	Horizontal or Vertical



A calculation example for radiated spurious emission is shown as below:

WIFI	Note	Frequency	Level	Over	Limit	Read	Antenna	Cable	Preamp	Ant	Table	Peak	Pol.
Ant.				Limit	Line	Level	Factor	Loss	Factor	Pos	Pos	Avg.	
1+2		(MHz)	(dBμV/m)	(dB)	(dBμV/m)	(dBμV)	(dB/m)	(dB)	(dB)	(cm)	(deg)	(P/A)	(H/V)
802.11b		2390	55.45	-18.55	74	54.51	32.22	4.58	35.86	103	308	P	H
CH 01													
2412MHz		2390	43.54	-10.46	54	42.6	32.22	4.58	35.86	103	308	A	H

1. Level(dBμV/m) =

Antenna Factor(dB/m) + Cable Loss(dB) + Read Level(dBμV) - Preamp Factor(dB)

2. Over Limit(dB) = Level(dBμV/m) – Limit Line(dBμV/m)

For Peak Limit @ 2390MHz:

1. Level(dBμV/m)

= Antenna Factor(dB/m) + Cable Loss(dB) + Read Level(dBμV) - Preamp Factor(dB)

= 32.22(dB/m) + 4.58(dB) + 54.51(dBμV) – 35.86 (dB)

= 55.45 (dBμV/m)

2. Over Limit(dB)

= Level(dBμV/m) – Limit Line(dBμV/m)

= 55.45(dBμV/m) – 74(dBμV/m)

= -18.55(dB)

For Average Limit @ 2390MHz:

1. Level(dBμV/m)

= Antenna Factor(dB/m) + Cable Loss(dB) + Read Level(dBμV) - Preamp Factor(dB)

= 32.22(dB/m) + 4.58(dB) + 42.6(dBμV) – 35.86 (dB)

= 43.54 (dBμV/m)

2. Over Limit(dB)

= Level(dBμV/m) – Limit Line(dBμV/m)

= 43.54(dBμV/m) – 54(dBμV/m)

= -10.46(dB)

Both peak and average measured complies with the limit line, so test result is “PASS”.



Appendix C. Photographs of EUT

Please refer to Sporton report number EP4N1402 which is issued separately.