



# FCC SAR Test Report

**APPLICANT** : Doro AB  
**EQUIPMENT** : Mobile Telephone  
**BRAND NAME** : Doro  
**MODEL NAME** : Doro PhoneEasy 615  
**FCC ID** : WS5DORO615W  
**STANDARD** : FCC 47 CFR Part 2 (2.1093)  
ANSI/IEEE C95.1-1992  
IEEE 1528-2003  
FCC OET Bulletin 65 Supplement C (Edition 01-01)

The product was completely tested on Jan. 29, 2013. We, SPORTON INTERNATIONAL (SHENZHEN) INC., would like to declare that the tested sample has been evaluated in accordance with the procedures and shown the compliance with the applicable technical standards.

The test results in this report apply exclusively to the tested model / sample. Without written approval of SPORTON INTERNATIONAL (SHENZHEN) INC., the test report shall not be reproduced except in full.

Reviewed by:

Jones Tsai / Manager



Testing Laboratory  
2353

## **SPORTON INTERNATIONAL (SHENZHEN) INC.**

No. 101, Complex Building C, Guanglong Village, Xili Town, Nanshan District, Shenzhen, Guangdong, P.R.C.

SPORTON INTERNATIONAL (SHENZHEN) INC.

TEL : 86-755-8637-9589

FAX : 86-755-8637-9595

FCC ID : WS5DORO615W

Page Number : 1 of 37

Report Issued Date : Feb. 19, 2013

Report Version : Rev. 01



Table of Contents

1. Statement of Compliance .....4
2. Administration Data .....5
2.1 Testing Laboratory.....5
2.2 Applicant .....5
2.3 Manufacturer.....5
2.4 Application Details.....5
3. General Information .....6
3.1 Description of Equipment Under Test (EUT) .....6
3.2 Maximum RF output power among production units.....7
3.3 Product Photos .....7
3.4 Applied Standard.....7
3.5 Device Category and SAR Limits .....8
3.6 Test Conditions.....8
4. Specific Absorption Rate (SAR).....9
4.1 Introduction .....9
4.2 SAR Definition.....9
5. SAR Measurement System.....10
5.1 E-Field Probe .....11
5.2 Data Acquisition Electronics (DAE) .....11
5.3 Robot .....12
5.4 Measurement Server.....12
5.5 Phantom.....13
5.6 Device Holder .....13
5.7 Data Storage and Evaluation .....14
5.8 Test Equipment List.....16
6. Tissue Simulating Liquids.....17
7. SAR System Validation.....18
7.1 Purpose of System Performance check .....18
7.2 System Setup.....18
7.3 SAR System Verification Results .....19
8. EUT Testing Position .....20
8.1 Define two imaginary lines on the handset.....20
8.2 Cheek Position .....21
8.3 Tilted Position.....21
8.4 Body Worn Position.....22
9. Measurement Procedures .....23
9.1 Spatial Peak SAR Evaluation.....23
9.2 Power Reference Measurement.....24
9.3 Area & Zoom Scan Procedures.....24
9.4 Volume Scan Procedures.....25
9.5 SAR Averaged Methods.....25
9.6 Power Drift Monitoring.....25
10. Exposure Positions Consideration.....26
11. Conducted RF Output Power (Unit: dBm).....27
12. SAR Test Results .....28
12.1 Test Records for Head SAR Test.....28
12.2 Test Records for Body-worn SAR Test .....29
12.3 Repeated SAR Measurement .....29
12.4 Highest SAR Plot .....30
12.5 Simultaneous Multi-band Transmission Analysis .....33
13. Uncertainty Assessment .....35
14. References.....37
Appendix A. Plots of System Performance Check
Appendix B. Plots of SAR Measurement
Appendix C. DASY Calibration Certificate
Appendix D. Product Photos
Appendix E. Test Setup Photos



### Revision History

REPORT NO.	VERSION	DESCRIPTION	ISSUED DATE
FA222402-01	Rev. 01	Initial issue of report	Feb. 19, 2013



### 1. Statement of Compliance

The maximum results of Specific Absorption Rate (SAR) found during testing for **Doro AB DUT: Mobile Telephone, Brand Name: Doro, Model Name: Doro PhoneEasy 615** are as follows.

**<Highest Reported standalone SAR Summary>**

Exposure Position	Frequency Band	Highest Reported 1g-SAR (W/kg)	Equipment Class	Highest Reported 1g-SAR (W/kg)
Head	GSM1900	0.11	PCE	0.44
	WCDMA Band V	0.44		
Body-worn (1.5cm Gap)	GSM1900	0.39	PCE	1.43
	WCDMA Band V	1.43		

**<Highest Simultaneous transmission SAR>**

Frequency Band	Equipment Class	Exposure Position	Highest Reported Simultaneous Transmission 1g-SAR (W/kg)
WCDMA Band V	PCE	Body	1.52
Bluetooth 2.4GHz	DSS		

**Remark:** The highest simultaneous transmission is scalar summation of reported standalone SAR per FCC KDB 690783 D01 v01r02, and scalar SAR summation of all possible simultaneous transmission scenarios are < 1.6W/kg.

This device is in compliance with Specific Absorption Rate (SAR) for general population/uncontrolled exposure limits (1.6 W/kg) specified in FCC 47 CFR part 2 (2.1093) and ANSI/IEEE C95.1-1992, and had been tested in accordance with the measurement methods and procedures specified in IEEE 1528-2003 and FCC OET Bulletin 65 Supplement C (Edition 01-01).



## 2. Administration Data

### 2.1 Testing Laboratory

Test Site	SPORTON INTERNATIONAL (SHENZHEN) INC.
Test Site Location	No. 101, Complex Building C, Guanglong Village, Xili Town, Nanshan District, Shenzhen, Guangdong, P.R.C. TEL: +86-755-8637-9589 FAX: +86-755-8637-9595

### 2.2 Applicant

Company Name	Doro AB
Address	Magistratsvägen 10 SE-226 44 Lund Sweden

### 2.3 Manufacturer

Company Name	CK TELECOM LTD.
Address	Technology Road, High-Tech Development Zone, Heyuan, Guangdong, P.R.China.

### 2.4 Application Details

Date of Start during the Test	Jan. 29, 2013
Date of End during the Test	Jan. 29, 2013

**3. General Information**

**3.1 Description of Equipment Under Test (EUT)**

Product Feature & Specification	
<b>DUT</b>	Mobile Telephone
<b>Brand Name</b>	Doro
<b>Model Name</b>	Doro PhoneEasy 615
<b>FCC ID</b>	WS5DORO615W
<b>IMEI Code</b>	352095050070642
<b>TX Frequency</b>	GSM1900: 1850.2 MHz ~ 1909.8 MHz WCDMA Band V: 826.4 MHz ~ 846.6 MHz Bluetooth: 2402 MHz ~ 2480 MHz
<b>Antenna Type</b>	WWAN: Fixed Internal Antenna Bluetooth: PIFA Antenna
<b>HW Version</b>	BOAT-V3.0
<b>SW Version</b>	BOAT-S05B_DORO615_L18EN_202_130130
<b>Uplink Modulations</b>	GSM/GPRS: GMSK WCDMA (Rel 99): QPSK Bluetooth BDR : GFSK Bluetooth EDR : $\pi/4$ -DQPSK, 8-DPSK
<b>Remark:</b> The above EUT's information was declared by manufacturer. Please refer to the specifications or user's manual for more detailed description.	

**3.2 Maximum RF output power among production units**

Mode	GSM 1900
	Average power(dBm)
GSM (GMSK, 1 Tx slot)	31
GPRS (GMSK, 1 Tx slot)	30
GPRS (GMSK, 2 Tx slots)	29.5
GPRS (GMSK, 3 Tx slots)	27.5
GPRS/ (GMSK, 4 Tx slots)	26.5

Mode	WCDMA Band V
	Average power(dBm)
AMR	23.5
RMC 12.2Kbps	24

Bluetooth average power(dBm)			
Mode/Band	1Mbps (GMSK)	2Mbps ( $\pi/4$ -DQPSK)	3Mbps (8-DPSK)
2.4 GHz Bluetooth	8	6.5	6.5

**3.3 Product Photos**

Please refer to Appendix D.

**3.4 Applied Standard**

The Specific Absorption Rate (SAR) testing specification, method, and procedure for this device is in accordance with the following standards:

- FCC 47 CFR Part 2 (2.1093)
- ANSI/IEEE C95.1-1992
- IEEE 1528-2003
- FCC OET Bulletin 65 Supplement C (Edition 01-01)
- FCC KDB 447498 D01 v05
- FCC KDB 648474 D04v01
- FCC KDB 941225 D01 v02
- FCC KDB 941225 D03 v01
- FCC KDB 865664 D01 v01

### **3.5 Device Category and SAR Limits**

This device belongs to portable device category because its radiating structure is allowed to be used within 20 centimeters of the body of the user. Limit for General Population/Uncontrolled exposure should be applied for this device, it is 1.6 W/kg as averaged over any 1 gram of tissue.

### **3.6 Test Conditions**

#### **3.6.1 Ambient Condition**

<b>Ambient Temperature</b>	20 to 24 °C
<b>Humidity</b>	< 60 %

#### **3.6.2 Test Configuration**

For WWAN SAR testing, the device was controlled by using a base station emulator. Communication between the device and the emulator was established by air link. The distance between the EUT and the antenna of the emulator is larger than 50 cm and the output power radiated from the emulator antenna is at least 30 dB smaller than the output power of EUT.



## **4. Specific Absorption Rate (SAR)**

### **4.1 Introduction**

SAR is related to the rate at which energy is absorbed per unit mass in an object exposed to a radio field. The SAR distribution in a biological body is complicated and is usually carried out by experimental techniques or numerical modeling. The standard recommends limits for two tiers of groups, occupational/controlled and general population/uncontrolled, based on a person's awareness and ability to exercise control over his or her exposure. In general, occupational/controlled exposure limits are higher than the limits for general population/uncontrolled.

### **4.2 SAR Definition**

The SAR definition is the time derivative (rate) of the incremental energy (dW) absorbed by (dissipated in) an incremental mass (dm) contained in a volume element (dv) of a given density ( $\rho$ ). The equation description is as below:

$$\text{SAR} = \frac{d}{dt} \left( \frac{dW}{dm} \right) = \frac{d}{dt} \left( \frac{dW}{\rho dv} \right)$$

SAR is expressed in units of Watts per kilogram (W/kg)

SAR measurement can be either related to the temperature elevation in tissue by

$$\text{SAR} = c \left( \frac{\delta T}{\delta t} \right)$$

Where: C is the specific heat capacity,  $\delta T$  is the temperature rise and  $\delta t$  is the exposure duration, or related to the electrical field in the tissue by

$$\text{SAR} = \frac{\sigma |E|^2}{\rho}$$

Where:  $\sigma$  is the conductivity of the tissue,  $\rho$  is the mass density of the tissue and E is the RMS electrical field strength.

However for evaluating SAR of low power transmitter, electrical field measurement is typically applied.

## 5. SAR Measurement System

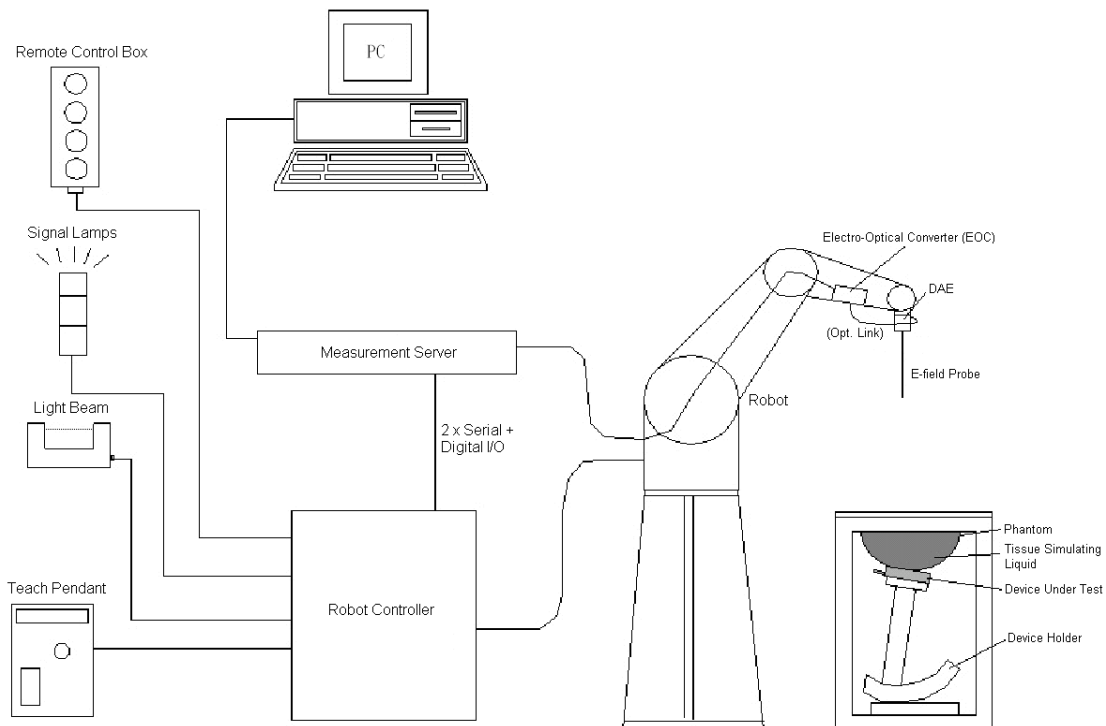

**Fig 5.1 SPEAG DASY System Configurations**

The DASY system for performance compliance tests is illustrated above graphically. This system consists of the following items:

- A standard high precision 6-axis robot with controller, a teach pendant and software
- A data acquisition electronic (DAE) attached to the robot arm extension
- A dosimetric probe equipped with an optical surface detector system
- The electro-optical converter (EOC) performs the conversion between optical and electrical signals
- A measurement server performs the time critical tasks such as signal filtering, control of the robot operation and fast movement interrupts.
- A probe alignment unit which improves the accuracy of the probe positioning
- A computer operating Windows XP
- DASY software
- Remote control with teach pendant and additional circuitry for robot safety such as warning lamps, etc.
- The SAM twin phantom
- A device holder
- Tissue simulating liquid
- Dipole for evaluating the proper functioning of the system

Component details are described in in the following sub-sections.

**5.1 E-Field Probe**

The SAR measurement is conducted with the dosimetric probe (manufactured by SPEAG). The probe is specially designed and calibrated for use in liquid with high permittivity. The dosimetric probe has special calibration in liquid at different frequency. This probe has a built in optical surface detection system to prevent from collision with phantom.

**5.1.1 E-Field Probe Specification**

**<EX3DV4 Probe>**

<b>Construction</b>	Symmetrical design with triangular core Built-in shielding against static charges PEEK enclosure material (resistant to organic solvents, e.g., DGBE)	
<b>Frequency</b>	10 MHz to 6 GHz; Linearity: $\pm 0.2$ dB	
<b>Directivity</b>	$\pm 0.3$ dB in HSL (rotation around probe axis) $\pm 0.5$ dB in tissue material (rotation normal to probe axis)	
<b>Dynamic Range</b>	10 $\mu$ W/g to 100 mW/g; Linearity: $\pm 0.2$ dB (noise: typically $< 1 \mu$ W/g)	
<b>Dimensions</b>	Overall length: 330 mm (Tip: 20 mm) Tip diameter: 2.5 mm (Body: 12 mm) Typical distance from probe tip to dipole centers: 1 mm	

**Fig 5.2 Photo of EX3DV4**

**5.1.2 E-Field Probe Calibration**

Each probe needs to be calibrated according to a dosimetric assessment procedure with accuracy better than  $\pm 10\%$ . The spherical isotropy shall be evaluated and within  $\pm 0.25$ dB. The sensitivity parameters (NormX, NormY, and NormZ), the diode compression parameter (DCP) and the conversion factor (ConvF) of the probe are tested. The calibration data can be referred to appendix C of this report.

**5.2 Data Acquisition Electronics (DAE)**

The data acquisition electronics (DAE) consists of a highly sensitive electrometer-grade preamplifier with auto-zeroing, a channel and gain-switching multiplexer, a fast 16 bit AD-converter and a command decoder and control logic unit. Transmission to the measurement server is accomplished through an optical downlink for data and status information as well as an optical uplink for commands and the clock. The input impedance of the DAE is 200 MOhm; the inputs are symmetrical and floating. Common mode rejection is above 80 dB.



**Fig 5.3 Photo of DAE**

### 5.3 Robot

The SPEAG DASY system uses the high precision robots (DASY5: TX90XL) type from Stäubli SA (France). For the 6-axis controller system, the robot controller version (DASY5: CS8c) from Stäubli is used. The Stäubli robot series have many features that are important for our application:

- High precision (repeatability  $\pm 0.035$  mm)
- High reliability (industrial design)
- Jerk-free straight movements
- Low ELF interference (the closed metallic construction shields against motor control fields)



Fig 5.4 Photo of DASY5

### 5.4 Measurement Server

The measurement server is based on a PC/104 CPU board with CPU (DASY5: 400 MHz, Intel Celeron), chipdisk (DASY5: 128 MB), RAM (DASY5: 128 MB). The necessary circuits for communication with the DAE electronic box, as well as the 16 bit AD converter system for optical detection and digital I/O interface are contained on the DASY I/O board, which is directly connected to the PC/104 bus of the CPU board.

The measurement server performs all the real-time data evaluation for field measurements and surface detection, controls robot movements and handles safety operations.



Fig 5.5 Photo of Server for DASY5

**5.5 Phantom**

**<SAM Twin Phantom>**

<b>Shell Thickness</b>	2 ± 0.2 mm; Center ear point: 6 ± 0.2 mm
<b>Filling Volume</b>	Approx. 25 liters
<b>Dimensions</b>	Length: 1000 mm; Width: 500 mm; Height: adjustable feet
<b>Measurement Areas</b>	Left Hand, Right Hand, Flat Phantom



**Fig 5.6 Photo of SAM Phantom**

The bottom plate contains three pair of bolts for locking the device holder. The device holder positions are adjusted to the standard measurement positions in the three sections. A white cover is provided to tap the phantom during off-periods to prevent water evaporation and changes in the liquid parameters. On the phantom top, three reference markers are provided to identify the phantom position with respect to the robot.

**5.6 Device Holder**

**<Device Holder for SAM Twin Phantom>**

The SAR in the phantom is approximately inversely proportional to the square of the distance between the source and the liquid surface. For a source at 5 mm distance, a positioning uncertainty of ± 0.5 mm would produce a SAR uncertainty of ± 20 %. Accurate device positioning is therefore crucial for accurate and repeatable measurements. The positions in which the devices must be measured are defined by the standards.

The DASY device holder is designed to cope with different positions given in the standard. It has two scales for the device rotation (with respect to the body axis) and the device inclination (with respect to the line between the ear reference points). The rotation center for both scales is the ear reference point (ERP). Thus the device needs no repositioning when changing the angles.

The DASY device holder is constructed of low-loss POM material having the following dielectric parameters: relative permittivity  $\epsilon = 3$  and loss tangent  $\delta = 0.02$ . The amount of dielectric material has been reduced in the closest vicinity of the device, since measurements have suggested that the influence of the clamp on the test results could thus be lowered.



**Fig 5.7 Device Holder**

## 5.7 Data Storage and Evaluation

### 5.7.1 Data Storage

The DASY software stores the assessed data from the data acquisition electronics as raw data (in microvolt readings from the probe sensors), together with all the necessary software parameters for the data evaluation (probe calibration data, liquid parameters and device frequency and modulation data) in measurement files. The post-processing software evaluates the desired unit and format for output each time the data is visualized or exported. This allows verification of the complete software setup even after the measurement and allows correction of erroneous parameter settings. For example, if a measurement has been performed with an incorrect crest factor parameter in the device setup, the parameter can be corrected afterwards and the data can be reevaluated.

The measured data can be visualized or exported in different units or formats, depending on the selected probe type (e.g., [V/m], [A/m], [mW/g]). Some of these units are not available in certain situations or give meaningless results, e.g., a SAR-output in a non-lose media, will always be zero. Raw data can also be exported to perform the evaluation with other software packages.

### 5.7.2 Data Evaluation

The DASY post-processing software (SEMCAD) automatically executes the following procedures to calculate the field units from the microvolt readings at the probe connector. The parameters used in the evaluation are stored in the configuration modules of the software :

<b>Probe parameters :</b>	- Sensitivity	Norm <sub>i</sub> , a <sub>i0</sub> , a <sub>i1</sub> , a <sub>i2</sub>
	- Conversion factor	ConvF <sub>i</sub>
	- Diode compression point	dcp <sub>i</sub>
<b>Device parameters :</b>	- Frequency	f
	- Crest factor	cf
	<b>Media parameters :</b>	- Conductivity
	- Density	ρ

These parameters must be set correctly in the software. They can be found in the component documents or they can be imported into the software from the configuration files issued for the DASY components. In the direct measuring mode of the multi-meter option, the parameters of the actual system setup are used. In the scan visualization and export modes, the parameters stored in the corresponding document files are used.

The first step of the evaluation is a linearization of the filtered input signal to account for the compression characteristics of the detector diode. The compensation depends on the input signal, the diode type and the DC-transmission factor from the diode to the evaluation electronics. If the exciting field is pulsed, the crest factor of the signal must be known to correctly compensate for peak power.

The formula for each channel can be given as :

$$V_i = U_i + U_i^2 \cdot \frac{cf}{dcp_i}$$

with  $V_i$  = compensated signal of channel  $i$ , ( $i = x, y, z$ )  
 $U_i$  = input signal of channel  $i$ , ( $i = x, y, z$ )  
 $cf$  = crest factor of exciting field (DASY parameter)  
 $dcp_i$  = diode compression point (DASY parameter)

From the compensated input signals, the primary field data for each channel can be evaluated :

$$\text{E-field Probes : } E_i = \sqrt{\frac{V_i}{\text{Norm}_i \cdot \text{ConvF}}}$$

$$\text{H-field Probes : } H_i = \sqrt{V_i \cdot \frac{a_{i0} + a_{i1}f + a_{i2}f^2}{f}}$$

with  $V_i$  = compensated signal of channel  $i$ , ( $i = x, y, z$ )  
 $\text{Norm}_i$  = sensor sensitivity of channel  $i$ , ( $i = x, y, z$ ),  $\mu\text{V}/(\text{V/m})^2$  for E-field Probes  
 $\text{ConvF}$  = sensitivity enhancement in solution  
 $a_{ij}$  = sensor sensitivity factors for H-field probes  
 $f$  = carrier frequency [GHz]  
 $E_i$  = electric field strength of channel  $i$  in V/m  
 $H_i$  = magnetic field strength of channel  $i$  in A/m

The RSS value of the field components gives the total field strength (Hermitian magnitude) :

$$E_{\text{tot}} = \sqrt{E_x^2 + E_y^2 + E_z^2}$$

The primary field data are used to calculate the derived field units.

$$\text{SAR} = E_{\text{tot}}^2 \cdot \frac{\sigma}{\rho \cdot 1000}$$

with SAR = local specific absorption rate in mW/g  
 $E_{\text{tot}}$  = total field strength in V/m  
 $\sigma$  = conductivity in [mho/m] or [Siemens/m]  
 $\rho$  = equivalent tissue density in  $\text{g}/\text{cm}^3$

Note that the density is set to 1, to account for actual head tissue density rather than the density of the tissue simulating liquid.



**5.8 Test Equipment List**

Manufacturer	Name of Equipment	Type/Model	Serial Number	Calibration	
				Last Cal.	Due Date
SPEAG	835MHz System Validation Kit	D835V2	4d091	Nov. 18, 2011	Nov. 16, 2013
SPEAG	1900MHz System Validation Kit	D1900V2	5d118	Nov. 21, 2011	Nov. 16, 2013
SPEAG	Data Acquisition Electronics	DAE4	1303	Nov. 22, 2012	Nov. 21, 2013
SPEAG	Dosimetric E-Field Probe	EX3DV4	3819	Nov. 26, 2012	Nov. 25, 2013
SPEAG	SAM Twin Phantom	QD 000 P40 CD	TP-1670	NCR	NCR
SPEAG	SAM Twin Phantom	QD 000 P40 CD	TP-1671	NCR	NCR
SPEAG	Phone Positioner	N/A	N/A	NCR	NCR
Agilent	Base Station	E5515C	MY50267224	Dec. 29, 2012	Dec. 28, 2013
Agilent	ENA Series Network Analyzer	E5071C	MY46111157	Apr. 13, 2012	Apr. 12, 2013
Anritsu	Power Meter	ML2495A	1218010	May. 07, 2012	May. 06, 2013
Anritsu	Power Sensor	MA2411B	1207253	May. 08, 2012	May. 07, 2013
Agilent	Dual Directional Coupler	778D	50422	Note 4	
Woken	Attenuator 1	WK0602-XX	N/A	Note 4	
PE	Attenuator 2	PE7005-10	N/A	Note 4	
PE	Attenuator 3	PE7005-3	N/A	Note 4	
Agilent	Dielectric Probe Kit	85070D	US01440205	Note 5	
AR	Power Amplifier	5S1G4M2	0328767	Note 6	
R&S	Spectrum Analyzer	FSP30	101400	Jun. 01, 2012	May 31, 2013

**Table 5.1 Test Equipment List**

**Note:**

1. The calibration certificate of DASY can be referred to appendix C of this report.
2. Referring to KDB 865664 D01v01, the dipole calibration interval can be extended to 3 years with justification. The dipoles are also not physically damaged, or repaired during the interval.
3. The justification data of dipole D835V2, SN: 4d091, D1900V2, SN: 5d118 can be found in appendix C. The return loss is < -20dB, within 20% of prior calibration, the impedance is within 5 ohm of prior calibration.
4. The Insertion Loss calibration of Dual Directional Coupler and Attenuator were characterized via the network analyzer and compensated during system check.
5. The dielectric probe kit was calibrated via the network analyzer, with the specified procedure (calibrated in pure water) and calibration kit (standard) short circuit, before the dielectric measurement. The specific procedure and calibration kit are provided by Agilent.
6. In system check we need to monitor the level on the power meter, and adjust the power amplifier level to have precise power level to the dipole; the measured SAR will be normalized to 1W input power according to the ratio of 1W to the input power to the dipole. For system check, the calibration of the power amplifier is deemed not critically required for correct measurement; the power meter is critical and we do have calibration for it
7. Attenuator 1 insertion loss is calibrated by the network Analyzer, which the calibration is valid, before system check.



## 6. Tissue Simulating Liquids

For the measurement of the field distribution inside the SAM phantom with DASY, the phantom must be filled with around 25 liters of homogeneous body tissue simulating liquid. For head SAR testing, the liquid height from the ear reference point (ERP) of the phantom to the liquid top surface is larger than 15 cm, which is shown in Fig. 6.1. For body SAR testing, the liquid height from the center of the flat phantom to the liquid top surface is larger than 15 cm, which is shown in Fig. 6.2.



Fig 6.1 Photo of Liquid Height for Head SAR



Fig 6.2 Photo of Liquid Height for Body SAR

The following table gives the recipes for tissue simulating liquid.

Frequency (MHz)	Water (%)	Sugar (%)	Cellulose (%)	Salt (%)	Preventol (%)	DGBE (%)	Conductivity ( $\sigma$ )	Permittivity ( $\epsilon_r$ )
<b>For Head</b>								
835	40.3	57.9	0.2	1.4	0.2	0	0.90	41.5
1800, 1900, 2000	55.2	0	0	0.3	0	44.5	1.40	40.0
<b>For Body</b>								
835	50.8	48.2	0	0.9	0.1	0	0.97	55.2
1800, 1900, 2000	70.2	0	0	0.4	0	29.4	1.52	53.3

Table 6.1 Recipes of Tissue Simulating Liquid

The dielectric parameters of the liquids were verified prior to the SAR evaluation using an Agilent 85070D Dielectric Probe Kit and an Agilent Network Analyzer.

The following table shows the measuring results for simulating liquid.

Frequency (MHz)	Liquid Type	Liquid Temp. (°C)	Conductivity ( $\sigma$ )	Permittivity ( $\epsilon_r$ )	Conductivity Target ( $\sigma$ )	Permittivity Target ( $\epsilon_r$ )	Delta ( $\sigma$ ) (%)	Delta ( $\epsilon_r$ ) (%)	Limit (%)	Date
835	Head	21.3	0.901	40.589	0.90	41.5	0.11	-2.20	±5	Jan. 29, 2013
1900	Head	21.6	1.427	41.191	1.40	40.0	1.93	2.98	±5	Jan. 29, 2013
835	Body	21.5	0.97	56.499	0.97	55.2	0.00	2.35	±5	Jan. 29, 2013
1900	Body	21.5	1.501	53.849	1.52	53.3	-1.25	1.03	±5	Jan. 29, 2013

Table 6.2 Measuring Results for Simulating Liquid

## 7. SAR System Validation

Each DASY system is equipped with one or more system validation kits. These units, together with the predefined measurement procedures within the DASY software, enable the user to conduct the system performance check and system validation. System validation kit includes a dipole, tripod holder to fix it underneath the flat phantom and a corresponding distance holder.

### 7.1 Purpose of System Performance check

The system performance check verifies that the system operates within its specifications. System and operator errors can be detected and corrected. It is recommended that the system performance check be performed prior to any usage of the system in order to guarantee reproducible results. The system performance check uses normal SAR measurements in a simplified setup with a well characterized source. This setup was selected to give a high sensitivity to all parameters that might fail or vary over time. The system check does not intend to replace the calibration of the components, but indicates situations where the system uncertainty is exceeded due to drift or failure.

### 7.2 System Setup

In the simplified setup for system evaluation, the EUT is replaced by a calibrated dipole and the power source is replaced by a continuous wave that comes from a signal generator. The calibrated dipole must be placed beneath the flat phantom section of the SAM twin phantom with the correct distance holder. The distance holder should touch the phantom surface with a light pressure at the reference marking and be oriented parallel to the long side of the phantom. The equipment setup is shown below:

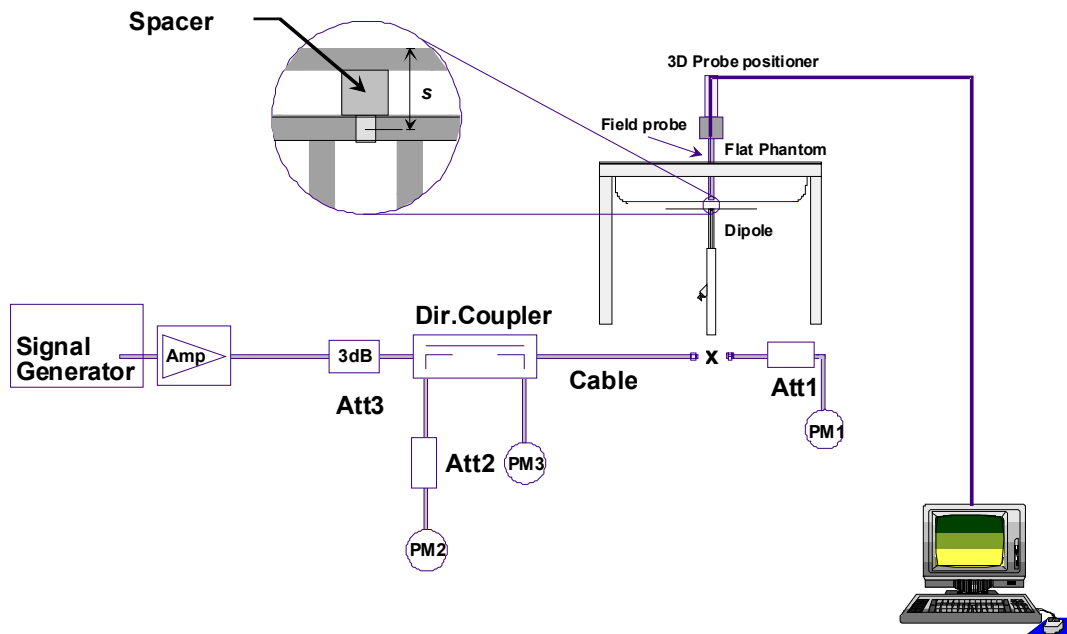

Fig 7.1 System Setup for System Evaluation

1. Signal Generator
2. Amplifier
3. Directional Coupler
4. Power Meter
5. Calibrated Dipole



**Fig 7.2 Photo of Dipole Setup**

**7.3 SAR System Verification Results**

Comparing to the original SAR value provided by SPEAG, the verification data should be within its specification of 10 %. Table 7.1 shows the target SAR and measured SAR after normalized to 1W input power. The table below indicates the system performance check can meet the variation criterion and the plots can be referred to Appendix A of this report.

Frequency (MHz)	Liquid Type	Power fed onto reference dipole (mW)	Target SAR (W/kg)	Measured SAR (W/kg)	Normalized SAR (W/kg)	Deviation (%)
835	Head	250	9.40	2.34	9.36	-0.43
1900	Head	250	40.3	10.1	40.4	0.25
835	Body	250	9.42	2.41	9.64	2.34
1900	Body	250	41.8	10.2	40.8	-2.39

**Table 7.1 Target and Measurement SAR after Normalized**

## 8. EUT Testing Position

This EUT was tested in ten different positions. They are right cheek, right cheek in mouth area, right tilted, right tilted in mouth area, left cheek, left cheek in mouth area, left tilted, left tilted in mouth area, Front of the DUT with phantom 1.5 cm gap, and Back of the DUT with phantom 1.5 cm gap, as illustrated below.

### 8.1 Define two imaginary lines on the handset

- The vertical centerline passes through two points on the front side of the handset - the midpoint of the width  $w_t$  of the handset at the level of the acoustic output, and the midpoint of the width  $w_b$  of the bottom of the handset.
- The horizontal line is perpendicular to the vertical centerline and passes through the center of the acoustic output. The horizontal line is also tangential to the face of the handset at point A.
- The two lines intersect at point A. Note that for many handsets, point A coincides with the center of the acoustic output; however, the acoustic output may be located elsewhere on the horizontal line. Also note that the vertical centerline is not necessarily parallel to the front face of the handset, especially for clamshell handsets, handsets with flip covers, and other irregularly shaped handsets.

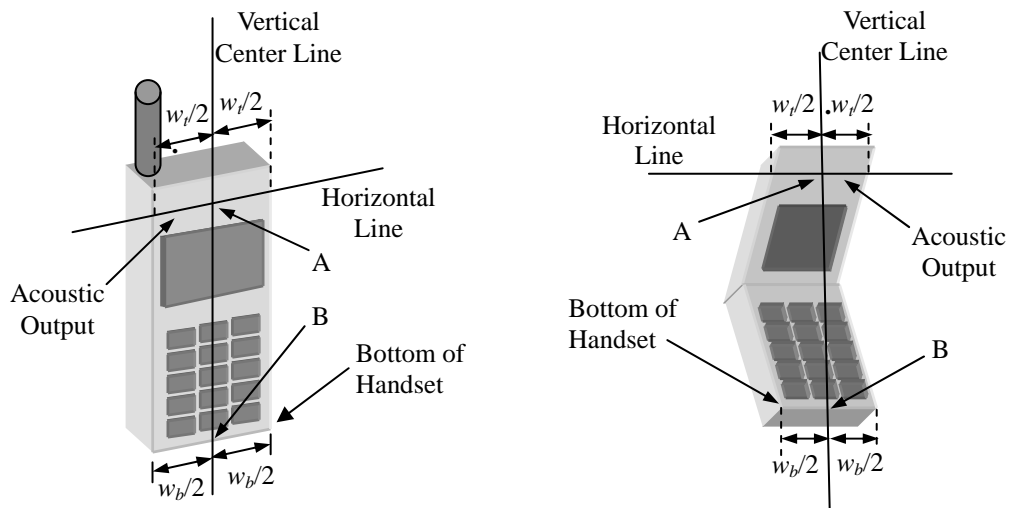

Fig 8.1 Illustration for Handset Vertical and Horizontal Reference Lines

**8.2 Cheek Position**

- (a) To position the device with the vertical center line of the body of the device and the horizontal line crossing the center piece in a plane parallel to the sagittal plane of the phantom. While maintaining the device in this plane, align the vertical center line with the reference plane containing the three ear and mouth reference point (M: Mouth, RE: Right Ear, and LE: Left Ear) and align the center of the ear piece with the line RE-LE.
- (b) To move the device towards the phantom with the ear piece aligned with the line LE-RE until the phone touched the ear. While maintaining the device in the reference plane and maintaining the phone contact with the ear, move the bottom of the phone until any point on the front side is in contact with the cheek of the phantom or until contact with the ear is lost (see Fig. 8.2).

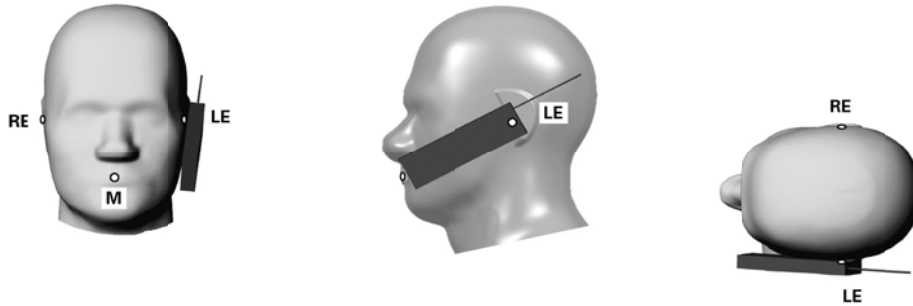

Fig 8.2 Illustration for Cheek Position

**8.3 Tilted Position**

- (a) To position the device in the “cheek” position described above.
- (b) While maintaining the device the reference plane described above and pivoting against the ear, moves it outward away from the mouth by an angle of 15 degrees or until contact with the ear is lost (see Fig. 8.3).

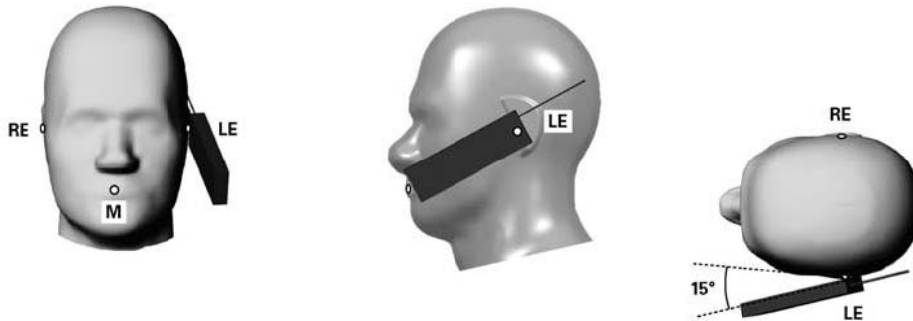
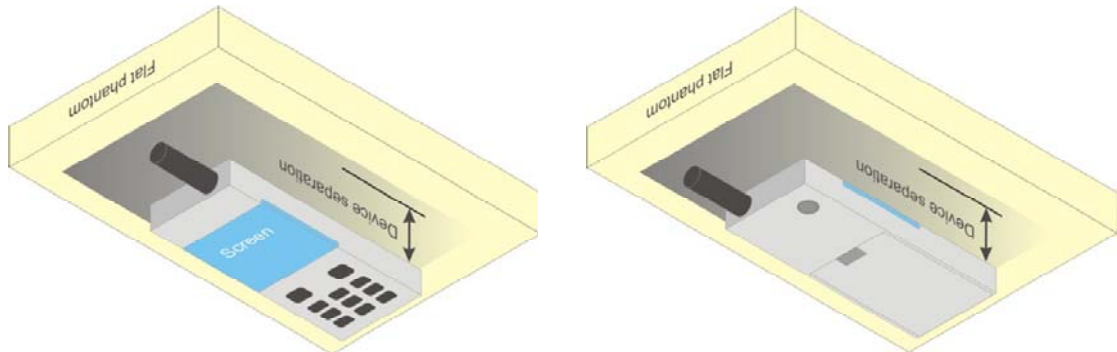

Fig 8.3 Illustration for Tilted Position

### 8.4 Body Worn Position

- (a) To position the device parallel to the phantom surface with either keypad up or down.
- (b) To adjust the device parallel to the flat phantom.
- (c) To adjust the distance between the device surface and the flat phantom to 1.5 cm.



**Fig 8.4 Illustration for Body Worn Position**

#### <EUT Setup Photos>

Please refer to Appendix E for the test setup photos.

## 9. Measurement Procedures

The measurement procedures are as follows:

### <Conducted power measurement>

- (a) For WWAN power measurement, use base station simulator to configure EUT WWAN transmission in conducted connection with RF cable, at maximum power in each supported wireless interface and frequency band.
- (b) Read the WWAN RF power level from the base station simulator.
- (c) For WLAN/BT power measurement, use engineering software to configure EUT WLAN/BT continuously transmission, at maximum RF power in each supported wireless interface and frequency band
- (d) Connect EUT RF port through RF cable to the power meter, and measure WLAN/BT output power

### <SAR measurement>

- (a) Use base station simulator to configure EUT WWAN transmission in radiated connection, and engineering software to configure EUT WLAN/BT continuously transmission, at maximum RF power, in the highest power channel.
- (b) Place the EUT in the positions as Appendix E demonstrates.
- (c) Set scan area, grid size and other setting on the DASY software.
- (d) Measure SAR results for the highest power channel on each testing position.
- (e) Find out the largest SAR result on these testing positions of each band
- (f) Measure SAR results for other channels in worst SAR testing position if the reported SAR of highest power channel is larger than 0.8 W/kg

According to the test standard, the recommended procedure for assessing the peak spatial-average SAR value consists of the following steps:

- (a) Power reference measurement
- (b) Area scan
- (c) Zoom scan
- (d) Power drift measurement

### 9.1 Spatial Peak SAR Evaluation

The procedure for spatial peak SAR evaluation has been implemented according to the test standard. It can be conducted for 1g and 10g, as well as for user-specific masses. The DASY software includes all numerical procedures necessary to evaluate the spatial peak SAR value.

The base for the evaluation is a "cube" measurement. The measured volume must include the 1g and 10g cubes with the highest averaged SAR values. For that purpose, the center of the measured volume is aligned to the interpolated peak SAR value of a previously performed area scan.

The entire evaluation of the spatial peak values is performed within the post-processing engine (SEMCAD). The system always gives the maximum values for the 1g and 10g cubes. The algorithm to find the cube with highest averaged SAR is divided into the following stages:

- (a) Extraction of the measured data (grid and values) from the Zoom Scan
- (b) Calculation of the SAR value at every measurement point based on all stored data (A/D values and measurement parameters)
- (c) Generation of a high-resolution mesh within the measured volume
- (d) Interpolation of all measured values from the measurement grid to the high-resolution grid
- (e) Extrapolation of the entire 3-D field distribution to the phantom surface over the distance from sensor to surface
- (f) Calculation of the averaged SAR within masses of 1g and 10g



### 9.2 Power Reference Measurement

The Power Reference Measurement and Power Drift Measurements are for monitoring the power drift of the device under test in the batch process. The minimum distance of probe sensors to surface determines the closest measurement point to phantom surface. This distance cannot be smaller than the distance of sensor calibration points to probe tip as defined in the probe properties.

### 9.3 Area & Zoom Scan Procedures

First Area Scan is used to locate the approximate location(s) of the local peak SAR value(s). The measurement grid within an Area Scan is defined by the grid extent, grid step size and grid offset. Next, in order to determine the EM field distribution in a three-dimensional spatial extension, Zoom Scan is required. The Zoom Scan is performed around the highest E-field value to determine the averaged SAR-distribution over 10 g. Area scan and zoom scan resolution setting follows KDB 865664 D01v01 quoted below.

For any secondary peaks found in the area scan which are within 2 dB of the maximum peak and are not within this zoom scan, the zoom scan should be repeated

		≤ 3 GHz	> 3 GHz
Maximum distance from closest measurement point (geometric center of probe sensors) to phantom surface		5 ± 1 mm	½·δ·ln(2) ± 0.5 mm
Maximum probe angle from probe axis to phantom surface normal at the measurement location		30° ± 1°	20° ± 1°
Maximum area scan spatial resolution: Δx <sub>Area</sub> , Δy <sub>Area</sub>		≤ 2 GHz: ≤ 15 mm 2 – 3 GHz: ≤ 12 mm	3 – 4 GHz: ≤ 12 mm 4 – 6 GHz: ≤ 10 mm
		When the x or y dimension of the test device, in the measurement plane orientation, is smaller than the above, the measurement resolution must be ≤ the corresponding x or y dimension of the test device with at least one measurement point on the test device.	
Maximum zoom scan spatial resolution: Δx <sub>Zoom</sub> , Δy <sub>Zoom</sub>		≤ 2 GHz: ≤ 8 mm 2 – 3 GHz: ≤ 5 mm*	3 – 4 GHz: ≤ 5 mm* 4 – 6 GHz: ≤ 4 mm*
Maximum zoom scan spatial resolution, normal to phantom surface	uniform grid: Δz <sub>Zoom(n)</sub>	≤ 5 mm	3 – 4 GHz: ≤ 4 mm 4 – 5 GHz: ≤ 3 mm 5 – 6 GHz: ≤ 2 mm
	graded grid Δz <sub>Zoom(1)</sub> : between 1 <sup>st</sup> two points closest to phantom surface	≤ 4 mm	3 – 4 GHz: ≤ 3 mm 4 – 5 GHz: ≤ 2.5 mm 5 – 6 GHz: ≤ 2 mm
	Δz <sub>Zoom(n&gt;1)</sub> : between subsequent points	≤ 1.5·Δz <sub>Zoom(n-1)</sub>	
Minimum zoom scan volume	x, y, z	≥ 30 mm	3 – 4 GHz: ≥ 28 mm 4 – 5 GHz: ≥ 25 mm 5 – 6 GHz: ≥ 22 mm
<p>Note: δ is the penetration depth of a plane-wave at normal incidence to the tissue medium; see draft standard IEEE P1528-2011 for details.</p> <p>* When zoom scan is required and the <i>reported</i> SAR from the area scan based <i>I-g SAR estimation</i> procedures of KDB 447498 is ≤ 1.4 W/kg, ≤ 8 mm, ≤ 7 mm and ≤ 5 mm zoom scan resolution may be applied, respectively, for 2 GHz to 3 GHz, 3 GHz to 4 GHz and 4 GHz to 6 GHz.</p>			





### **9.4 Volume Scan Procedures**

The volume scan is used for assess overlapping SAR distributions for antennas transmitting in different frequency bands. It is equivalent to an oversized zoom scan used in standalone measurements. The measurement volume will be used to enclose all the simultaneous transmitting antennas. For antennas transmitting simultaneously in different frequency bands, the volume scan is measured separately in each frequency band. In order to sum correctly to compute the 1g aggregate SAR, the EUT remain in the same test position for all measurements and all volume scan use the same spatial resolution and grid spacing. When all volume scan were completed, the software, SEMCAD postprocessor can combine and subsequently superpose these measurement data to calculating the multiband SAR.

### **9.5 SAR Averaged Methods**

In DASYS, the interpolation and extrapolation are both based on the modified Quadratic Shepard's method. The interpolation scheme combines a least-square fitted function method and a weighted average method which are the two basic types of computational interpolation and approximation.

Extrapolation routines are used to obtain SAR values between the lowest measurement points and the inner phantom surface. The extrapolation distance is determined by the surface detection distance and the probe sensor offset. The uncertainty increases with the extrapolation distance. To keep the uncertainty within 1% for the 1 g and 10 g cubes, the extrapolation distance should not be larger than 5 mm.

### **9.6 Power Drift Monitoring**

All SAR testing is under the EUT install full charged battery and transmit maximum output power. In DASYS measurement software, the power reference measurement and power drift measurement procedures are used for monitoring the power drift of EUT during SAR test. Both these procedures measure the field at a specified reference position before and after the SAR testing. The software will calculate the field difference in dB. If the power drifts more than 5%, the SAR will be retested.

### 10. Exposure Positions Consideration

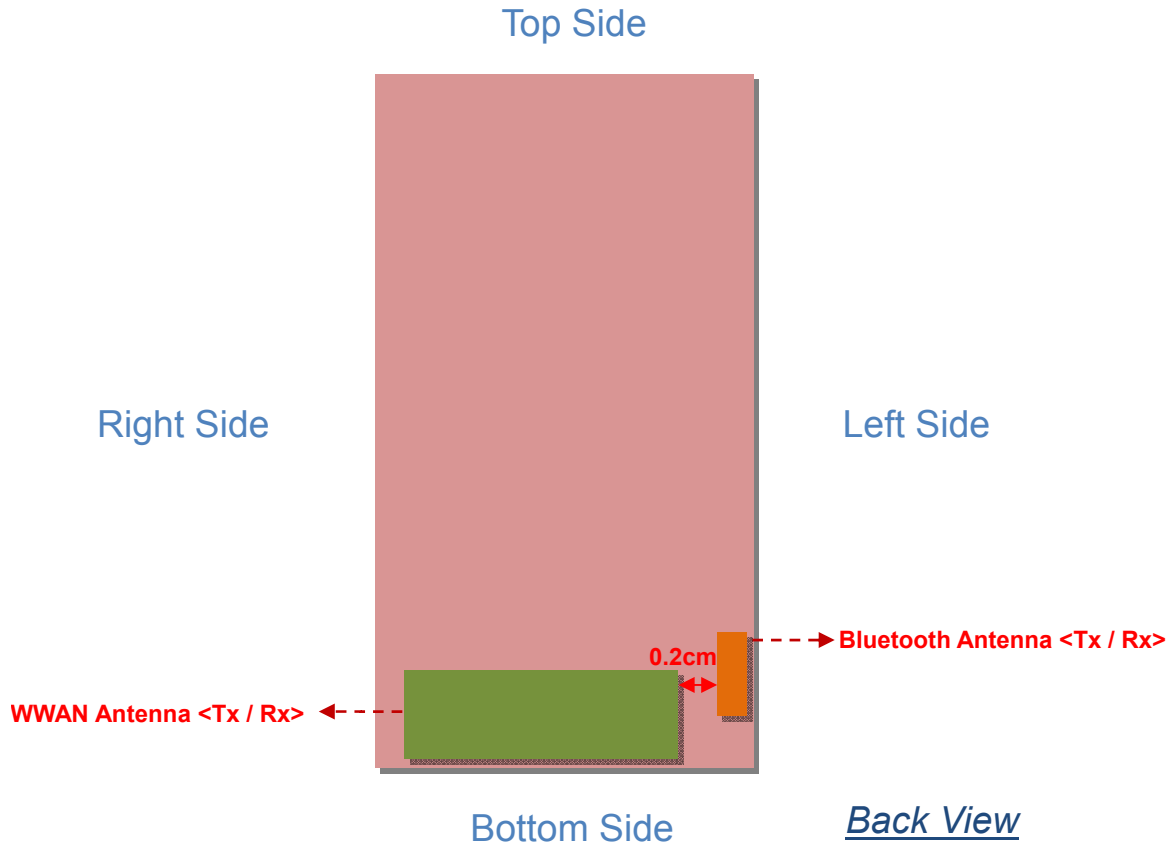

Antennas	Wireless Interface
WWAN Antenna (Tx / Rx)	GSM1900, WCDMA Band V
Bluetooth Antenna (Tx / Rx)	Bluetooth



## 11. Conducted RF Output Power (Unit: dBm)

### <GSM Conducted Power>

**General Note:**

1. Per KDB 447498 D01v05, the maximum output power channel is used for SAR testing and for further SAR test reduction.
2. The EUT do not support DTM function.

Band: GSM1900	Burst Average Power (dBm)			Frame-Average Power (dBm)		
	Channel	512	661	810	512	661
Frequency (MHz)	1850.2	1880.0	1909.8	1850.2	1880.0	1909.8
GSM (GMSK, 1 Tx slot)	29.69	29.59	29.79	20.69	20.59	20.79
GPRS (GMSK, 1 Tx slot) – CS1	29.69	29.58	29.78	20.69	20.58	20.78
GPRS (GMSK, 2 Tx slots) – CS1	28.95	28.86	29.13	22.95	22.86	23.13
GPRS (GMSK, 3 Tx slots) – CS1	27.15	27.06	27.35	22.89	22.80	23.09
GPRS (GMSK, 4 Tx slots) – CS1	26.05	25.97	26.26	23.05	22.97	23.26

**Remark:** The frame-averaged power is linearly scaled the maximum burst averaged power over 8 time slots.  
The calculated method are shown as below:  
Frame-averaged power = Maximum burst averaged power (1 Tx Slot) - 9 Db  
Frame-averaged power = Maximum burst averaged power (2 Tx Slots) - 6 dB  
Frame-averaged power = Maximum burst averaged power (3 Tx Slots) - 4.26 dB  
Frame-averaged power = Maximum burst averaged power (4 Tx Slots) - 3 dB

**Note:**

1. For Head SAR testing, GSM should be evaluated, therefore the EUT was set in GSM Voice for GSM1900 due to its highest frame-average power.
2. For Body worn SAR testing, GSM should be evaluated, therefore the EUT was set in GSM Voice for GSM1900 due to its highest frame-average power.

### <WCDMA Conducted Power>

**Note:**

1. Per KDB 941225 D01, RMC 12.2kbps setting is used to evaluate SAR. If AMR 12.2kbps power is < 0.25dB higher than RMC 12.2kbps, SAR tests with AMR 12.2kbps can be excluded.
2. By design, AMR RF power will not be larger than RMC 12.2kbps, detailed information is included in Tune-up Procure exhibit.

WCDMA Average power (dBm)			
Band	WCDMA Band V		
Channel	4132	4182	4233
Frequency (MHz)	826.4	836.4	846.6
3GPP Rel 99	AMR 12.2K	23.07	23.09
3GPP Rel 99	RMC 12.2K	23.08	23.10
			22.94

### <Bluetooth Conducted Power>

Average Power (dBm)										
Channel	Frequency (MHz)	Packet Type								
		DH1	DH3	DH5	2DH1	2DH3	2DH5	3DH1	3DH3	3DH5
CH 00	2402	7.28	7.19	7.06	5.54	5.56	5.39	6.22	5.66	5.40
CH 39	2441	7.50	7.43	7.32	6.47	5.85	5.71	6.45	5.88	5.59
CH 78	2480	6.20	6.12	6.14	5.22	4.56	4.32	5.19	4.54	4.28

## 12. SAR Test Results

### <General Note>

- Per KDB 447498 D01v05, the reported SAR is the measured SAR value adjusted for maximum tune-up tolerance.  
 $Scaling\ Factor = \frac{tune-up\ limit\ power\ (mW)}{EUT\ RF\ power\ (mW)}$ , where tune-up limit is the maximum rated power among all production units.  
 $Reported\ SAR\ (W/kg) = Measured\ SAR(W/kg) * Scaling\ Factor$
- Per KDB 447498 D01v05, for each exposure position, if the highest output channel reported SAR  $\leq 0.8W/kg$ , other channels SAR testing are not necessary

### 12.1 Test Records for Head SAR Test

#### <GSM SAR>

Plot No.	Band	Mode	Test Position	DUT	Ch.	Freq. (MHz)	Burst Average Power (dBm)	Tune-Up Limit (dBm)	Scaling Factor	Power Drift (dB)	Measured SAR <sub>1g</sub> (W/kg)	Reported SAR <sub>1g</sub> (W/kg)
9	GSM1900	GSM Voice	Right Cheek	Slide Up	810	1909.8	29.79	31	1.321	0.09	0.082	0.108
10	GSM1900	GSM Voice	Right Tilted	Slide Up	810	1909.8	29.79	31	1.321	-0.10	0.030	0.040
11	GSM1900	GSM Voice	Left Cheek	Slide Up	810	1909.8	29.79	31	1.321	0.02	0.062	0.082
12	GSM1900	GSM Voice	Left Tilted	Slide Up	810	1909.8	29.79	31	1.321	-0.03	0.026	0.034
13	GSM1900	GSM Voice	Right Cheek-SAR in mouth area	Slide Up	810	1909.8	29.79	31	1.321	-0.10	0.024	0.032
14	GSM1900	GSM Voice	Right Tilted-SAR in mouth area	Slide Up	810	1909.8	29.79	31	1.321	-0.04	0.00833	0.011
15	GSM1900	GSM Voice	Left Cheek-SAR in mouth area	Slide Up	810	1909.8	29.79	31	1.321	-0.07	0.028	0.037
16	GSM1900	GSM Voice	Left Tilted-SAR in mouth area	Slide Up	810	1909.8	29.79	31	1.321	-0.07	0.00827	0.011

#### <WCDMA SAR>

Plot No.	Band	Mode	Test Position	DUT	Ch.	Freq. (MHz)	Burst Average Power (dBm)	Tune-Up Limit (dBm)	Scaling Factor	Power Drift (dB)	Measured SAR <sub>1g</sub> (W/kg)	Reported SAR <sub>1g</sub> (W/kg)
17	WCDMA Band V	RMC 12.2K	Right Cheek	Slide Up	4182	836.4	23.1	24	1.230	0.08	0.250	0.308
18	WCDMA Band V	RMC 12.2K	Right Tilted	Slide Up	4182	836.4	23.1	24	1.230	0.01	0.045	0.055
19	WCDMA Band V	RMC 12.2K	Left Cheek	Slide Up	4182	836.4	23.1	24	1.230	0.05	0.354	0.436
20	WCDMA Band V	RMC 12.2K	Left Tilted	Slide Up	4182	836.4	23.1	24	1.230	0.12	0.079	0.097
21	WCDMA Band V	RMC 12.2K	Right Cheek-SAR in mouth area	Slide Up	4182	836.4	23.1	24	1.230	-0.05	0.136	0.167
22	WCDMA Band V	RMC 12.2K	Right Tilted-SAR in mouth area	Slide Up	4182	836.4	23.1	24	1.230	-0.04	0.030	0.037
23	WCDMA Band V	RMC 12.2K	Left Cheek-SAR in mouth area	Slide Up	4182	836.4	23.1	24	1.230	-0.02	0.160	0.197
24	WCDMA Band V	RMC 12.2K	Left Tilted-SAR in mouth area	Slide Up	4182	836.4	23.1	24	1.230	0.01	0.027	0.033

**12.2 Test Records for Body-worn SAR Test**

**Note:**

1. For Body-worn SAR testing: "V" in the Headset column means the Headset is plugged during SAR testing
2. Body-worn exposure conditions are intended to voice call operations, therefore GSM voice call mode is selected to be tested.
3. Pre KDB648474 D04v01, When the reported SAR for a body-worn accessory, measured without a headset connected to the handset, is > 1.2 W/kg, the highest reported SAR configuration for that wireless mode and frequency band should be repeated for that body-worn accessory with a headset attached to the handset.

**<GSM SAR>**

Plot No.	Band	Mode	Test Position	Gap (cm)	DUT	Headset	Ch.	Freq. (MHz)	Burst Average Power (dBm)	Tune-Up Limit (dBm)	Scaling Factor	Power Drift (dB)	Measured SAR <sub>1g</sub> (W/kg)	Reported SAR <sub>1g</sub> (W/kg)
25	GSM1900	GSM Voice	Front	1.5	Slide Off	-	810	1909.8	29.79	31	1.321	-0.05	0.050	0.066
26	GSM1900	GSM Voice	Back	1.5	Slide Off	-	810	1909.8	29.79	31	1.321	-0.05	0.293	0.387

**<WCDMA SAR>**

Plot No.	Band	Mode	Test Position	Gap (cm)	DUT	Headset	Ch.	Freq. (MHz)	Burst Average Power (dBm)	Tune-Up Limit (dBm)	Scaling Factor	Power Drift (dB)	Measured SAR <sub>1g</sub> (W/kg)	Reported SAR <sub>1g</sub> (W/kg)
1	WCDMA Band V	RMC 12.2K	Front	1.5	Slide Off	-	4182	836.4	23.1	24	1.230	-0.10	0.433	0.533
2	WCDMA Band V	RMC 12.2K	Back	1.5	Slide Off	-	4182	836.4	23.1	24	1.230	-0.04	1.030	1.267
3	WCDMA Band V	RMC 12.2K	Back	1.5	Slide Off	-	4132	826.4	23.08	24	1.236	-0.01	0.874	1.080
4	WCDMA Band V	RMC 12.2K	Back	1.5	Slide Off	-	4233	846.6	22.94	24	1.276	0.01	1.120	1.430
5	WCDMA Band V	RMC 12.2K	Back	1.5	Slide Off	v	4233	846.6	22.94	24	1.276	-0.02	0.980	1.251
6	WCDMA Band V	RMC 12.2K	Back	1.5	Slide Off	v	4132	826.4	23.08	24	1.236	-0.01	0.738	0.912
7	WCDMA Band V	RMC 12.2K	Back	1.5	Slide Off	v	4182	836.4	23.1	24	1.230	0.01	0.853	1.049

**12.3 Repeated SAR Measurement**

Plot No.	Band	Mode	Test Position	Gap (cm)	DUT	Ch.	Freq. (MHz)	Burst Average Power (dBm)	Tune-Up Limit (dBm)	Scaling Factor	Power Drift (dB)	Measured SAR <sub>1g</sub> (W/kg)	Ratio	Reported SAR <sub>1g</sub> (W/kg)
4	WCDMA Band V	RMC 12.2K	Back	1.5	Slide Off	4233	846.6	22.94	24	1.276	0.01	1.120	1	1.430
8	WCDMA Band V	RMC 12.2K	Back	1.5	Slide Off	4233	846.6	22.94	24	1.276	0.05	0.987	1.135	1.260

**Note:**

1. Per KDB 865664 D01v01, for each frequency band, repeated SAR measurement is required only when the measured SAR is ≥0.8W/kg
2. Per KDB 865664 D01v01, if the deviation among the repeated measurement is ≤20% and the measured SAR <1.45W/kg, only one repeated measurement is required.
3. The deviation is the difference in percentage between original and repeated measured SAR.
4. All measurement SAR result is scaled-up to account for tune-up tolerance and is compliant.



12.4 Highest SAR Plot

Plot No.	Band	Mode	Test Position	Gap (cm)	DUT	Headset	Ch.	Freq. (MHz)	Burst Average Power (dBm)	Tune-Up Limit (dBm)	Scaling Factor	Power Drift (dB)	Measured SAR <sub>1g</sub> (W/kg)	Reported SAR <sub>1g</sub> (W/kg)
26	GSM1900	GSM Voice	Back	1.5	Slide Off	-	810	1909.8	29.79	31	1.321	-0.05	0.293	0.387
4	WCDMA Band V	RMC 12.2K	Back	1.5	Slide Off	-	4233	846.6	22.94	24	1.276	0.01	1.120	1.430

Test Laboratory: Sporton International Inc. SAR/HAC Testing Lab

Date: 29.01.2013

**26 GSM1900\_GSM Voice\_Back\_1.5cm\_Ch810****DUT: 222402-01**

Communication System: Generic GSM; Frequency: 1909.8 MHz; Duty Cycle: 1:8.3  
Medium: MSL\_1900\_130129 Medium parameters used:  $f = 1910$  MHz;  $\sigma = 1.511$  mho/m;  $\epsilon_r = 53.819$ ;  $\rho = 1000$  kg/m<sup>3</sup>  
Ambient Temperature : 23.3 °C; Liquid Temperature : 21.5 °C

DASY5 Configuration:

- Probe: EX3DV4 - SN3819; ConvF(7.67, 7.67, 7.67); Calibrated: 26.11.2012;
- Sensor-Surface: 2mm (Mechanical Surface Detection)
- Electronics: DAE4 Sn1303; Calibrated: 22.11.2012
- Phantom: SAM1; Type: QD000P40CD; Serial: TP:1670
- Measurement SW: DASY52, Version 52.8 (2); SEMCAD X Version 14.6.6 (6824)

**Ch810/Area Scan (51x81x1):** Interpolated grid: dx=15mm, dy=15mm

Maximum value of SAR (interpolated) = 0.417 W/kg

**Ch810/Zoom Scan (5x5x7)/Cube 0:** Measurement grid: dx=8mm, dy=8mm, dz=5mm

Reference Value = 16.630 V/m; Power Drift = -0.05 dB

Peak SAR (extrapolated) = 0.503 mW/g

**SAR(1 g) = 0.293 mW/g; SAR(10 g) = 0.164 mW/g**

Maximum value of SAR (measured) = 0.398 W/kg

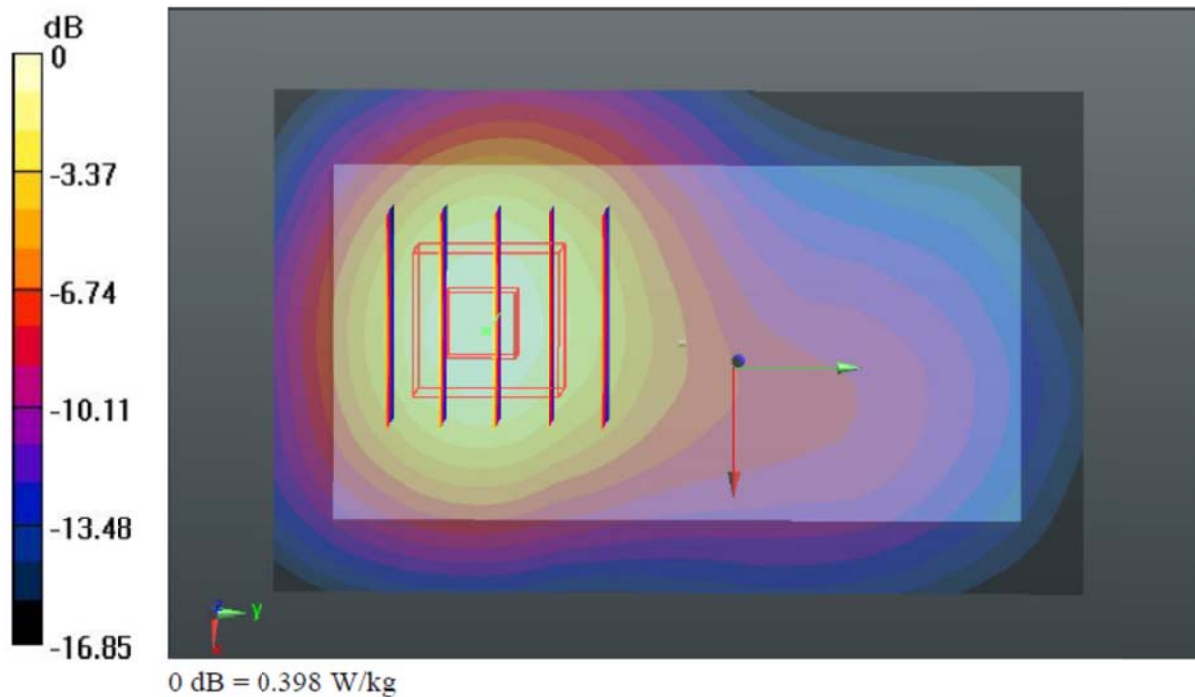



Test Laboratory: Sporton International Inc. SAR/HAC Testing Lab

Date: 29.01.2013

**04 WCDMA Band V\_RMC 12.2K\_Back\_1.5cm\_Ch4233**

**DUT: 222402-01**

Communication System: UMTS; Frequency: 846.6 MHz; Duty Cycle: 1:1

Medium: MSL\_835\_130129 Medium parameters used:  $f = 847$  MHz;  $\sigma = 0.981$  mho/m;  $\epsilon_r = 56.389$ ;

$\rho = 1000$  kg/m<sup>3</sup>

Ambient Temperature : 23.5 °C; Liquid Temperature : 21.5 °C

DASY5 Configuration:

- Probe: EX3DV4 - SN3819; ConvF(9.5, 9.5, 9.5); Calibrated: 26.11.2012;
- Sensor-Surface: 2mm (Mechanical Surface Detection)
- Electronics: DAE4 Sn1303; Calibrated: 22.11.2012
- Phantom: SAM2; Type: QD000P40CD; Serial: TP:1671
- Measurement SW: DASY52, Version 52.8 (2); SEMCAD X Version 14.6.6 (6824)

**Ch4233/Area Scan (51x81x1):** Interpolated grid: dx=15mm, dy=15mm

Maximum value of SAR (interpolated) = 1.31 W/kg

**Ch4233/Zoom Scan (5x5x7)/Cube 0:** Measurement grid: dx=8mm, dy=8mm, dz=5mm

Reference Value = 37.560 V/m; Power Drift = 0.01 dB

Peak SAR (extrapolated) = 1.482 mW/g

**SAR(1 g) = 1.12 mW/g; SAR(10 g) = 0.803 mW/g**

Maximum value of SAR (measured) = 1.32 W/kg

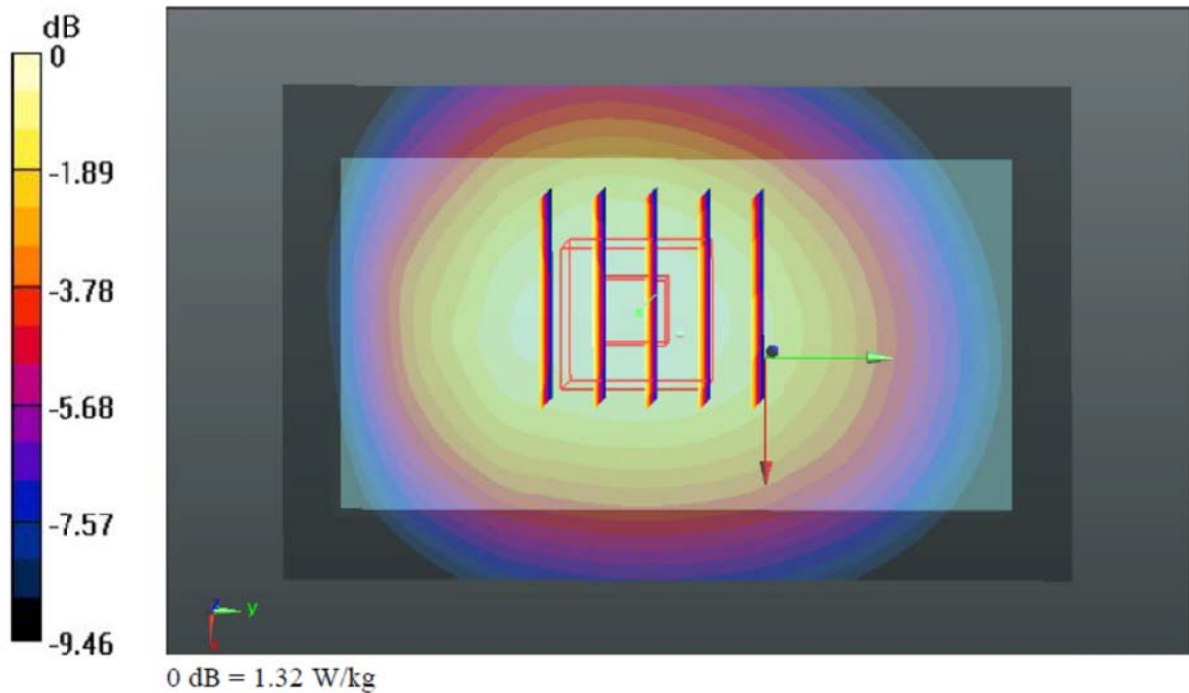



**12.5 Simultaneous Multi-band Transmission Analysis**

No.	Applicable Simultaneous Transmission Combination
1.	GSM (Voice) + BT
2.	WCDMA + BT

**Note:**

1. This device does not support hotspot mode.
2. Base on KDB 447498 D01 v05, BT SAR is excluded as below table.
3. The Scaled SAR summation is calculated based on the same configuration and test position.
4. Per KDB 447498 D01v05, for handsets the *test separation distance* is determined by the smallest distance between the outer surface of the device and the user; which is 0mm for head SAR, 15mm for body-worn SAR.
5. If the test separation distance (antenna-user) is < 5mm, 5mm is used for excluded SAR calculation
6. For minimum test separation distance ≤50mm, Bluetooth standalone SAR is excluded according to  

$$[(\text{max. power of channel, including tune-up tolerance, mW}) / (\text{min. test separation distance, mm})] \cdot [\sqrt{f(\text{GHz})}] \leq 3.0$$
for 1-g SAR and  $\leq 7.5$  for 10-g extremity SAR

	Wireless Interface	Bluetooth
	Tune-up Maximum power (dBm)	8
	Tune-up Maximum rated power (mW)	6.31
Head	Antenna to user (mm)	5
	SAR exclusion threshold (mW)	10
	SAR testing required?	<b>NO</b>
Body	Antenna to user (mm)	15
	SAR exclusion threshold (mW)	29
	SAR testing required?	<b>NO</b>

7. For simultaneous transmission analysis, Bluetooth SAR is estimated per KDB 447498 D01v05 based on the formula below.
  - i)  $(\text{max. power of channel, including tune-up tolerance, mW}) / (\text{min. test separation distance, mm}) \cdot [\sqrt{f(\text{GHz})} / x]$  W/kg for *test separation distances* ≤ 50 mm; where  $x = 7.5$  for 1-g SAR, and  $x = 18.75$  for 10-g SAR.
  - ii) 0.4 W/kg for 1-g SAR and 1.0 W/kg for 10-g SAR, when the *test separation distances* is > 50 mm.

	Max power (dBm)	Head (0cm gap)	Body (1.5cm gap)
Estimated SAR (W/kg)	8dBm	0.263W/kg	0.088 W/kg

8. Per KDB 447498 D01v05, simultaneous transmission SAR is compliant if,
  - (i) Scalar SAR summation < 1.6W/kg.
  - (ii)  $\text{SPLSR} = (\text{SAR}_1 + \text{SAR}_2)^{1.5} / (\text{min. separation distance, mm})$ , and the peak separation distance is determined from the square root of  $[(x_1-x_2)^2 + (y_1-y_2)^2 + (z_1-z_2)^2]$ , where  $(x_1, y_1, z_1)$  and  $(x_2, y_2, z_2)$  are the coordinates of the extrapolated peak SAR locations in the zoom scan  
If  $\text{SPLSR} \leq 0.04$ , simultaneously transmission SAR measurement is not necessary
  - (iii) Simultaneously transmission SAR measurement, and the reported multi-band SAR < 1.6W/kg



<Head SAR>

Position	WWAN-PCE			Bluetooth-DSS	WWAN + Bluetooth (W/kg)	SPLSR ≤ 0.04	Case No.
	WWAN Band	Plot No	Max. WWAN SAR (W/kg)	Estimated SAR (W/kg)			
Right Cheek	GSM1900	9	0.108	0.263	0.37	-	-
	WCDAM Band V	17	0.308	0.263	0.57	-	-
Right Cheek-SAR in mouth area	GSM1900	13	0.032	0.263	0.30		
	WCDAM Band V	21	0.167	0.263	0.43		
Right Tilted	GSM1900	10	0.040	0.263	0.30	-	-
	WCDAM Band V	18	0.055	0.263	0.32	-	-
Right Tilted-SAR in mouth area	GSM1900	14	0.011	0.263	0.27		
	WCDAM Band V	22	0.037	0.263	0.30		
Left Cheek	GSM1900	11	0.082	0.263	0.35	-	-
	WCDAM Band V	19	0.436	0.263	0.70	-	-
Left Cheek-SAR in mouth area	GSM1900	15	0.037	0.263	0.30		
	WCDAM Band V	23	0.197	0.263	0.46		
Left Tilted	GSM1900	12	0.034	0.263	0.30	-	-
	WCDAM Band V	20	0.097	0.263	0.36	-	-
Left Tilted-SAR in mouth area	GSM1900	16	0.011	0.263	0.27		
	WCDAM Band V	24	0.033	0.263	0.30		

<Body-worn SAR>

Position	WWAN-PCE			Bluetooth-DSS	WWAN + Bluetooth (W/kg)	SPLSR ≤ 0.04	Case No.
	WWAN Band	Plot No	Max. WWAN SAR (W/kg)	Estimated SAR (W/kg)			
Front	GSM1900	25	0.066	0.088	0.15	-	-
	WCDAM Band V	1	0.533	0.088	0.62	-	-
Back	GSM1900	26	0.387	0.088	0.48	-	-
	WCDAM Band V	4	1.430	0.088	1.52	-	-
Back (w/headset)	GSM1900	-	-	0.088	0.09		
	WCDAM Band V	5	1.251	0.088	1.34		

Test Engineer : Krin Wu

### 13. Uncertainty Assessment

The component of uncertainty may generally be categorized according to the methods used to evaluate them. The evaluation of uncertainty by the statistical analysis of a series of observations is termed a Type A evaluation of uncertainty. The evaluation of uncertainty by means other than the statistical analysis of a series of observation is termed a Type B evaluation of uncertainty. Each component of uncertainty, however evaluated, is represented by an estimated standard deviation, termed standard uncertainty, which is determined by the positive square root of the estimated variance.

A Type A evaluation of standard uncertainty may be based on any valid statistical method for treating data. This includes calculating the standard deviation of the mean of a series of independent observations; using the method of least squares to fit a curve to the data in order to estimate the parameter of the curve and their standard deviations; or carrying out an analysis of variance in order to identify and quantify random effects in certain kinds of measurement.

A type B evaluation of standard uncertainty is typically based on scientific judgment using all of the relevant information available. These may include previous measurement data, experience, and knowledge of the behavior and properties of relevant materials and instruments, manufacture’s specification, data provided in calibration reports and uncertainties assigned to reference data taken from handbooks. Broadly speaking, the uncertainty is either obtained from an outdoor source or obtained from an assumed distribution, such as the normal distribution, rectangular or triangular distributions indicated in Table 12.1

Uncertainty Distributions	Normal	Rectangular	Triangular	U-Shape
Multi-plying Factor <sup>(a)</sup>	1/k <sup>(b)</sup>	1/√3	1/√6	1/√2

(a) standard uncertainty is determined as the product of the multiplying factor and the estimated range of variations in the measured quantity

(b)  $\kappa$  is the coverage factor

**Table 12.1 Standard Uncertainty for Assumed Distribution**

The combined standard uncertainty of the measurement result represents the estimated standard deviation of the result. It is obtained by combining the individual standard uncertainties of both Type A and Type B evaluation using the usual “root-sum-squares” (RSS) methods of combining standard deviations by taking the positive square root of the estimated variances.

Expanded uncertainty is a measure of uncertainty that defines an interval about the measurement result within which the measured value is confidently believed to lie. It is obtained by multiplying the combined standard uncertainty by a coverage factor. Typically, the coverage factor ranges from 2 to 3. Using a coverage factor allows the true value of a measured quantity to be specified with a defined probability within the specified uncertainty range. For purpose of this document, a coverage factor two is used, which corresponds to confidence interval of about 95 %. The DASY uncertainty Budget is shown in the following tables.



Error Description	Uncertainty	Probability	Divisor	Ci	Ci	Standard	Standard
	Value (±%)	Distribution		(1g)	(10g)	Uncertainty (1g)	Uncertainty (10g)
<b>Measurement System</b>							
Probe Calibration	6.0	Normal	1	1	1	± 6.0 %	± 6.0 %
Axial Isotropy	4.7	Rectangular	√3	0.7	0.7	± 1.9 %	± 1.9 %
Hemispherical Isotropy	9.6	Rectangular	√3	0.7	0.7	± 3.9 %	± 3.9 %
Boundary Effects	1.0	Rectangular	√3	1	1	± 0.6 %	± 0.6 %
Linearity	4.7	Rectangular	√3	1	1	± 2.7 %	± 2.7 %
System Detection Limits	1.0	Rectangular	√3	1	1	± 0.6 %	± 0.6 %
Readout Electronics	0.3	Normal	1	1	1	± 0.3 %	± 0.3 %
Response Time	0.8	Rectangular	√3	1	1	± 0.5 %	± 0.5 %
Integration Time	2.6	Rectangular	√3	1	1	± 1.5 %	± 1.5 %
RF Ambient Noise	3.0	Rectangular	√3	1	1	± 1.7 %	± 1.7 %
RF Ambient Reflections	3.0	Rectangular	√3	1	1	± 1.7 %	± 1.7 %
Probe Positioner	0.4	Rectangular	√3	1	1	± 0.2 %	± 0.2 %
Probe Positioning	2.9	Rectangular	√3	1	1	± 1.7 %	± 1.7 %
Max. SAR Eval.	1.0	Rectangular	√3	1	1	± 0.6 %	± 0.6 %
<b>Test Sample Related</b>							
Device Positioning	2.9	Normal	1	1	1	± 2.9 %	± 2.9 %
Device Holder	3.6	Normal	1	1	1	± 3.6 %	± 3.6 %
Power Drift	5.0	Rectangular	√3	1	1	± 2.9 %	± 2.9 %
<b>Phantom and Setup</b>							
Phantom Uncertainty	4.0	Rectangular	√3	1	1	± 2.3 %	± 2.3 %
Liquid Conductivity (Target)	5.0	Rectangular	√3	0.64	0.43	± 1.8 %	± 1.2 %
Liquid Conductivity (Meas.)	2.5	Normal	1	0.64	0.43	± 1.6 %	± 1.1 %
Liquid Permittivity (Target)	5.0	Rectangular	√3	0.6	0.49	± 1.7 %	± 1.4 %
Liquid Permittivity (Meas.)	2.5	Normal	1	0.6	0.49	± 1.5 %	± 1.2 %
<b>Combined Standard Uncertainty</b>						± 11.0 %	± 10.8 %
<b>Coverage Factor for 95 %</b>						K=2	
<b>Expanded Uncertainty</b>						± 22.0 %	± 21.5 %

Table 12.2 Uncertainty Budget of DASY for frequency range 300 MHz to 3 GHz according to IEEE 1528-2003



## **14. References**

- [1] FCC 47 CFR Part 2 “Frequency Allocations and Radio Treaty Matters; General Rules and Regulations”
- [2] ANSI/IEEE Std. C95.1-1992, “IEEE Standard for Safety Levels with Respect to Human Exposure to Radio Frequency Electromagnetic Fields, 3 kHz to 300 GHz”, September 1992
- [3] IEEE Std. 1528-2003, “Recommended Practice for Determining the Peak Spatial-Average Specific Absorption Rate (SAR) in the Human Head from Wireless Communications Devices: Measurement Techniques”, December 2003
- [4] FCC OET Bulletin 65 (Edition 97-01) Supplement C (Edition 01-01), “Evaluating Compliance with FCC Guidelines for Human Exposure to Radiofrequency Electromagnetic Fields”, June 2001
- [5] SPEAG DASY System Handbook
- [6] FCC KDB 447498 D01 v05, “Mobile and Portable Device RF Exposure Procedures and Equipment Authorization Policies”, October 2012
- [7] FCC KDB 648474 D04 v01, “SAR Evaluation Considerations for Handsets with Multiple Transmitters and Antennas”, October 2012
- [8] FCC KDB 941225 D01 v02, “SAR Measurement Procedures for 3G Devices – CDMA 2000 / Ev-Do / WCDMA / HSDPA / HSPA”, October 2007
- [9] FCC KDB 941225 D03 v01, “Recommended SAR Test Reduction Procedures for GSM / GPRS / EDGE”, December 2008
- [10] FCC KDB 865664 D01 v01” SAR Measurement Requirements for 100 MHz to 6 GHz” , October 2012



## ***Appendix A. Plots of System Performance Check***

The plots are shown as follows.

### System Check\_Head\_835MHz\_130129

**DUT: D835V2 - SN: 4d091**

Communication System: CW; Frequency: 835 MHz; Duty Cycle: 1:1

Medium: HSL\_835\_130129 Medium parameters used:  $f = 835 \text{ MHz}$ ;  $\sigma = 0.901 \text{ mho/m}$ ;  $\epsilon_r = 40.589$ ;  $\rho = 1000 \text{ kg/m}^3$

Ambient Temperature :  $23.5 \text{ }^\circ\text{C}$  ; Liquid Temperature :  $21.3 \text{ }^\circ\text{C}$

DASY5 Configuration:

- Probe: EX3DV4 - SN3819; ConvF(9.56, 9.56, 9.56); Calibrated: 26.11.2012;
- Sensor-Surface: 2mm (Mechanical Surface Detection)
- Electronics: DAE4 Sn1303; Calibrated: 22.11.2012
- Phantom: SAM2; Type: QD000P40CD; Serial: TP:1671
- Measurement SW: DASY52, Version 52.8 (2); SEMCAD X Version 14.6.6 (6824)

**Pin=250mW/Area Scan (61x61x1):** Interpolated grid:  $dx=15\text{mm}$ ,  $dy=15\text{mm}$

Maximum value of SAR (interpolated) =  $2.97 \text{ W/kg}$

**Pin=250mW/Zoom Scan (5x5x7)/Cube 0:** Measurement grid:  $dx=8\text{mm}$ ,  $dy=8\text{mm}$ ,  $dz=5\text{mm}$

Reference Value =  $58.282 \text{ V/m}$ ; Power Drift =  $-0.01 \text{ dB}$

Peak SAR (extrapolated) =  $3.518 \text{ mW/g}$

**SAR(1 g) =  $2.34 \text{ mW/g}$ ; SAR(10 g) =  $1.53 \text{ mW/g}$**

Maximum value of SAR (measured) =  $2.98 \text{ W/kg}$

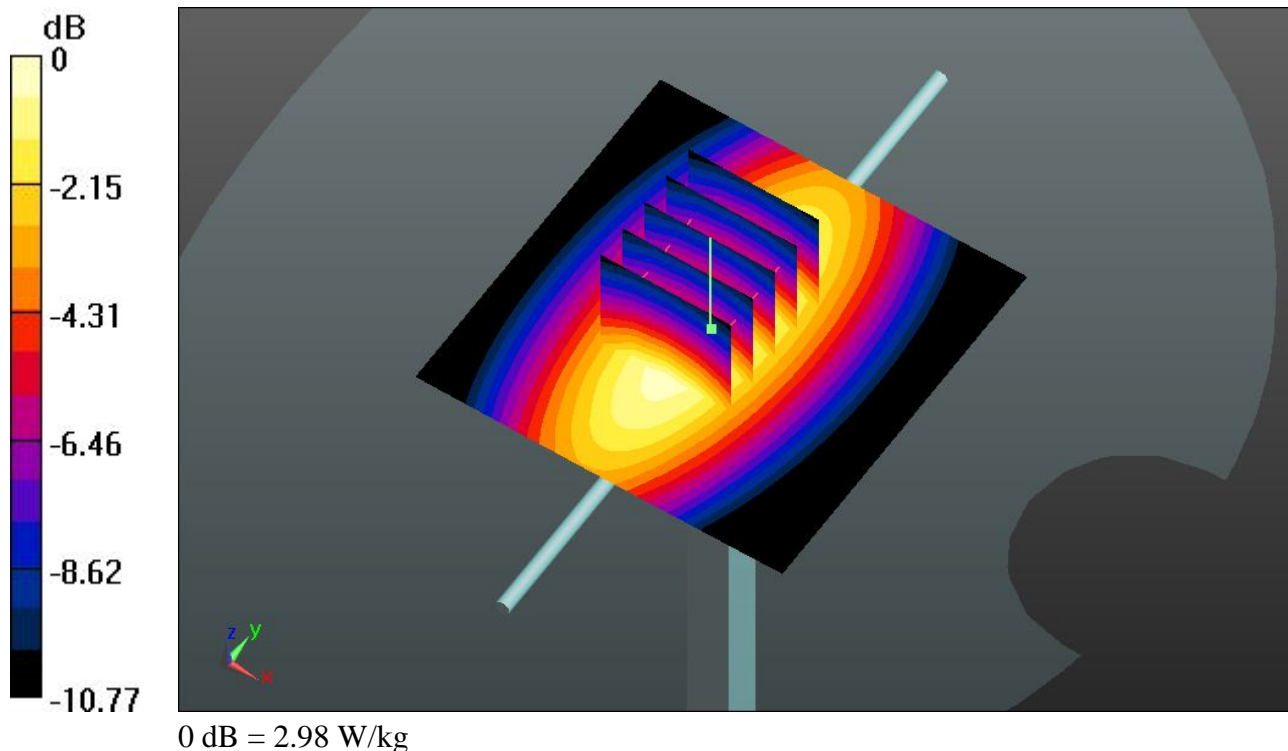

**System Check\_Head\_1900MHz\_130129**

**DUT: D1900V2 - SN: 5d118**

Communication System: CW; Frequency: 1900 MHz; Duty Cycle: 1:1

Medium: HSL\_1900\_130129 Medium parameters used:  $f = 1900 \text{ MHz}$ ;  $\sigma = 1.427 \text{ mho/m}$ ;  $\epsilon_r =$

$41.191$ ;  $\rho = 1000 \text{ kg/m}^3$

Ambient Temperature :  $23.6 \text{ }^\circ\text{C}$  ; Liquid Temperature :  $21.6 \text{ }^\circ\text{C}$

DASY5 Configuration:

- Probe: EX3DV4 - SN3819; ConvF(7.84, 7.84, 7.84); Calibrated: 26.11.2012;
- Sensor-Surface: 2mm (Mechanical Surface Detection)
- Electronics: DAE4 Sn1303; Calibrated: 22.11.2012
- Phantom: SAM1; Type: QD000P40CD; Serial: TP:1670
- Measurement SW: DASY52, Version 52.8 (2); SEMCAD X Version 14.6.6 (6824)

**Pin=250mW/Area Scan (61x61x1):** Interpolated grid:  $dx=15\text{mm}$ ,  $dy=15\text{mm}$

Maximum value of SAR (interpolated) =  $14.5 \text{ W/kg}$

**Pin=250mW/Zoom Scan (5x5x7)/Cube 0:** Measurement grid:  $dx=8\text{mm}$ ,  $dy=8\text{mm}$ ,  $dz=5\text{mm}$

Reference Value =  $101.6 \text{ V/m}$ ; Power Drift =  $0.02 \text{ dB}$

Peak SAR (extrapolated) =  $18.759 \text{ mW/g}$

**SAR(1 g) =  $10.1 \text{ mW/g}$ ; SAR(10 g) =  $5.17 \text{ mW/g}$**

Maximum value of SAR (measured) =  $14.1 \text{ W/kg}$

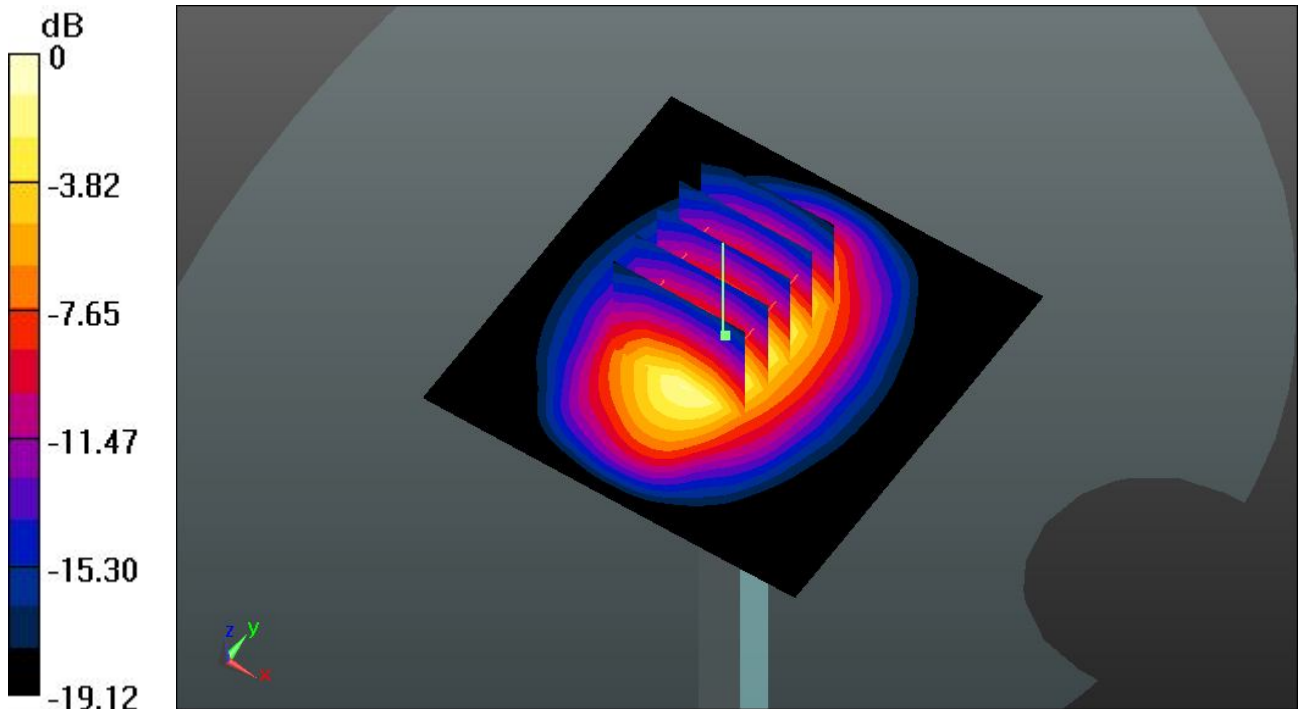

0 dB =  $14.1 \text{ W/kg}$



**System Check\_Body\_835MHz\_130129**

**DUT: D835V2 - SN: 4d091**

Communication System: CW; Frequency: 835 MHz; Duty Cycle: 1:1

Medium: MSL\_835\_130129 Medium parameters used:  $f = 835 \text{ MHz}$ ;  $\sigma = 0.97 \text{ mho/m}$ ;  $\epsilon_r = 56.499$ ;  $\rho = 1000 \text{ kg/m}^3$

Ambient Temperature :  $23.5 \text{ }^\circ\text{C}$  ; Liquid Temperature :  $21.5 \text{ }^\circ\text{C}$

DASY5 Configuration:

- Probe: EX3DV4 - SN3819; ConvF(9.5, 9.5, 9.5); Calibrated: 26.11.2012;
- Sensor-Surface: 2mm (Mechanical Surface Detection)
- Electronics: DAE4 Sn1303; Calibrated: 22.11.2012
- Phantom: SAM1; Type: QD000P40CD; Serial: TP:1670
- Measurement SW: DASY52, Version 52.8 (2); SEMCAD X Version 14.6.6 (6824)

**Pin=250mW/Area Scan (61x61x1):** Interpolated grid:  $dx=15\text{mm}$ ,  $dy=15\text{mm}$

Maximum value of SAR (interpolated) =  $2.60 \text{ W/kg}$

**Pin=250mW/Zoom Scan (5x5x7)/Cube 0:** Measurement grid:  $dx=8\text{mm}$ ,  $dy=8\text{mm}$ ,  $dz=5\text{mm}$

Reference Value =  $52.017 \text{ V/m}$ ; Power Drift =  $-0.01 \text{ dB}$

Peak SAR (extrapolated) =  $3.540 \text{ mW/g}$

**SAR(1 g) =  $2.41 \text{ mW/g}$ ; SAR(10 g) =  $1.59 \text{ mW/g}$**

Maximum value of SAR (measured) =  $2.58 \text{ W/kg}$

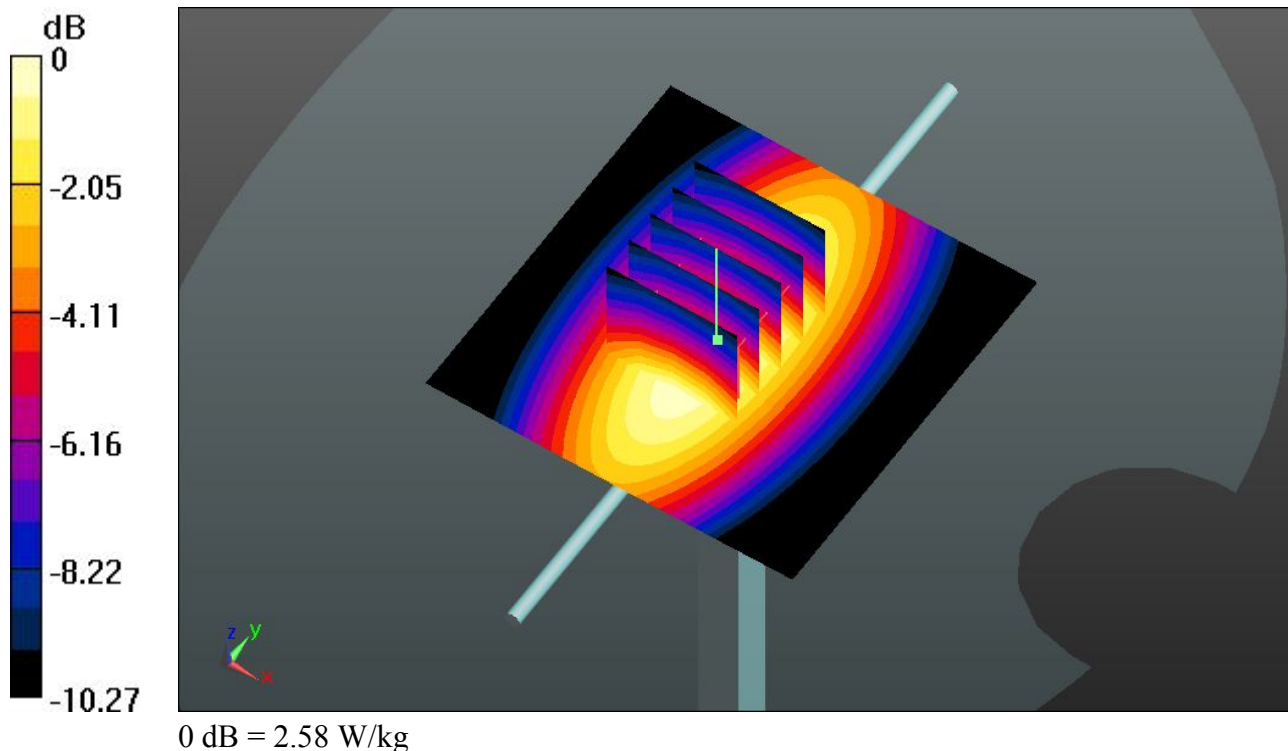

**System Check\_Body\_1900MHz\_130129**

**DUT: D1900V2 - SN: 5d118**

Communication System: CW; Frequency: 1900 MHz; Duty Cycle: 1:1

Medium: MSL\_1900\_130129 Medium parameters used:  $f = 1900 \text{ MHz}$ ;  $\sigma = 1.501 \text{ mho/m}$ ;  $\epsilon_r =$

$53.849$ ;  $\rho = 1000 \text{ kg/m}^3$

Ambient Temperature :  $23.3 \text{ }^\circ\text{C}$  ; Liquid Temperature :  $21.5 \text{ }^\circ\text{C}$

DASY5 Configuration:

- Probe: EX3DV4 - SN3819; ConvF(7.67, 7.67, 7.67); Calibrated: 26.11.2012;
- Sensor-Surface: 2mm (Mechanical Surface Detection)
- Electronics: DAE4 Sn1303; Calibrated: 22.11.2012
- Phantom: SAM1; Type: QD000P40CD; Serial: TP:1670
- Measurement SW: DASY52, Version 52.8 (2); SEMCAD X Version 14.6.6 (6824)

**Pin=250mW/Area Scan (61x61x1):** Interpolated grid:  $dx=15\text{mm}$ ,  $dy=15\text{mm}$

Maximum value of SAR (interpolated) =  $14.6 \text{ W/kg}$

**Pin=250mW/Zoom Scan (5x5x7)/Cube 0:** Measurement grid:  $dx=8\text{mm}$ ,  $dy=8\text{mm}$ ,  $dz=5\text{mm}$

Reference Value =  $86.965 \text{ V/m}$ ; Power Drift =  $0.02 \text{ dB}$

Peak SAR (extrapolated) =  $18.476 \text{ mW/g}$

**SAR(1 g) =  $10.2 \text{ mW/g}$ ; SAR(10 g) =  $5.29 \text{ mW/g}$**

Maximum value of SAR (measured) =  $14.6 \text{ W/kg}$

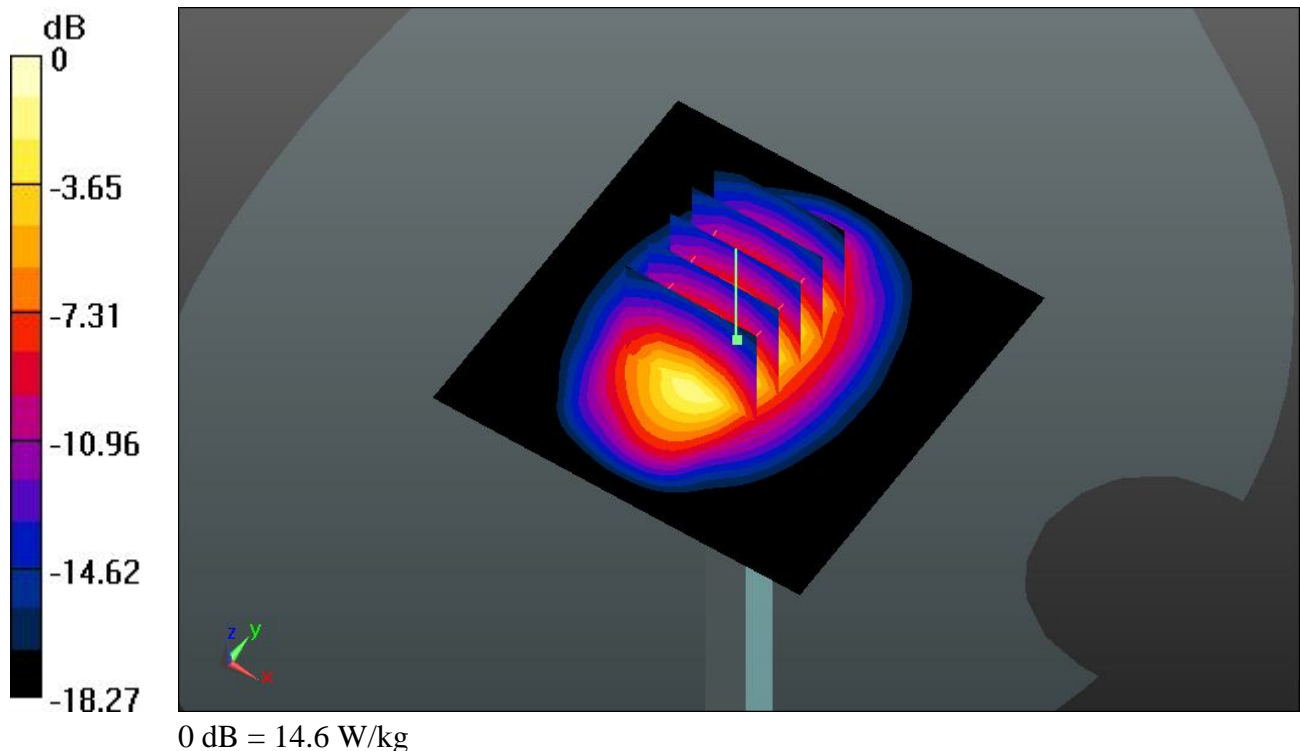



## ***Appendix B. Plots of SAR Measurement***

The plots are shown as follows.

**09 GSM1900\_GSM Voice\_Right Cheek\_Ch810**

**DUT: 222402-01**

Communication System: Generic GSM; Frequency: 1909.8 MHz; Duty Cycle: 1:8.3

Medium: HSL\_1900\_130129 Medium parameters used:  $f = 1910$  MHz;  $\sigma = 1.436$  mho/m;  $\epsilon_r = 41.187$ ;  $\rho = 1000$  kg/m<sup>3</sup>

Ambient Temperature : 23.6 °C ; Liquid Temperature : 21.6 °C

DASY5 Configuration:

- Probe: EX3DV4 - SN3819; ConvF(7.84, 7.84, 7.84); Calibrated: 26.11.2012;
- Sensor-Surface: 2mm (Mechanical Surface Detection)
- Electronics: DAE4 Sn1303; Calibrated: 22.11.2012
- Phantom: SAM1; Type: QD000P40CD; Serial: TP:1670
- Measurement SW: DASY52, Version 52.8 (2); SEMCAD X Version 14.6.6 (6824)

**Ch810/Area Scan (51x141x1):** Interpolated grid: dx=15mm, dy=15mm

Maximum value of SAR (interpolated) = 0.159 W/kg

**Ch810/Zoom Scan (5x5x7)/Cube 0:** Measurement grid: dx=8mm, dy=8mm, dz=5mm

Reference Value = 0.580 V/m; Power Drift = 0.09 dB

Peak SAR (extrapolated) = 0.142 mW/g

**SAR(1 g) = 0.082 mW/g; SAR(10 g) = 0.045 mW/g**

Maximum value of SAR (measured) = 0.113 W/kg

**Ch810/Zoom Scan (5x5x7)/Cube 1:** Measurement grid: dx=8mm, dy=8mm, dz=5mm

Reference Value = 0.580 V/m; Power Drift = 0.09 dB

Peak SAR (extrapolated) = 0.127 mW/g

**SAR(1 g) = 0.074 mW/g; SAR(10 g) = n.a.**

Maximum value of SAR (measured) = 0.102 W/kg

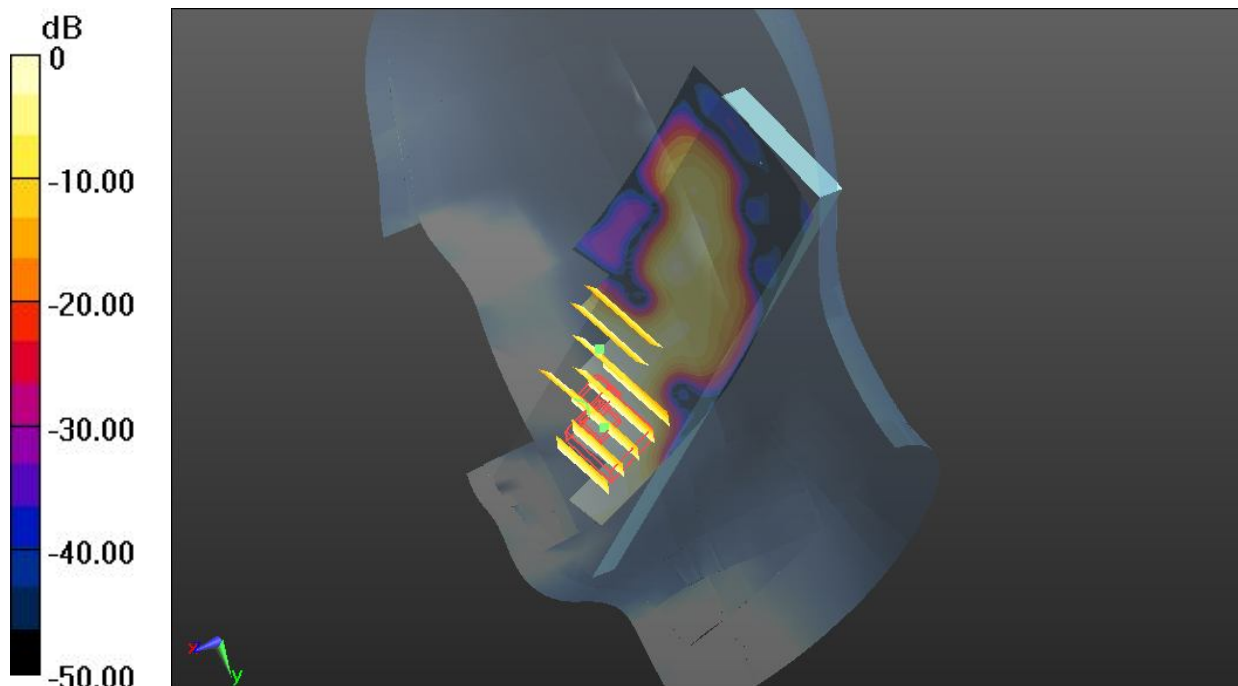

0 dB = 0.102 W/kg

### 10 GSM1900\_GSM Voice\_Right Tilted\_Ch810

**DUT: 222402-01**

Communication System: Generic GSM; Frequency: 1909.8 MHz; Duty Cycle: 1:8.3

Medium: HSL\_1900\_130129 Medium parameters used:  $f = 1910$  MHz;  $\sigma = 1.436$  mho/m;  $\epsilon_r =$

41.187;  $\rho = 1000$  kg/m<sup>3</sup>

Ambient Temperature : 23.6 °C ; Liquid Temperature : 21.6 °C

DASY5 Configuration:

- Probe: EX3DV4 - SN3819; ConvF(7.84, 7.84, 7.84); Calibrated: 26.11.2012;
- Sensor-Surface: 2mm (Mechanical Surface Detection)
- Electronics: DAE4 Sn1303; Calibrated: 22.11.2012
- Phantom: SAM1; Type: QD000P40CD; Serial: TP:1670
- Measurement SW: DASY52, Version 52.8 (2); SEMCAD X Version 14.6.6 (6824)

**Ch810/Area Scan (51x141x1):** Interpolated grid: dx=15mm, dy=15mm

Maximum value of SAR (interpolated) = 0.0456 W/kg

**Ch810/Zoom Scan (5x5x7)/Cube 0:** Measurement grid: dx=8mm, dy=8mm, dz=5mm

Reference Value = 5.173 V/m; Power Drift = -0.10 dB

Peak SAR (extrapolated) = 0.046 mW/g

**SAR(1 g) = 0.030 mW/g; SAR(10 g) = 0.018 mW/g**

Maximum value of SAR (measured) = 0.0386 W/kg

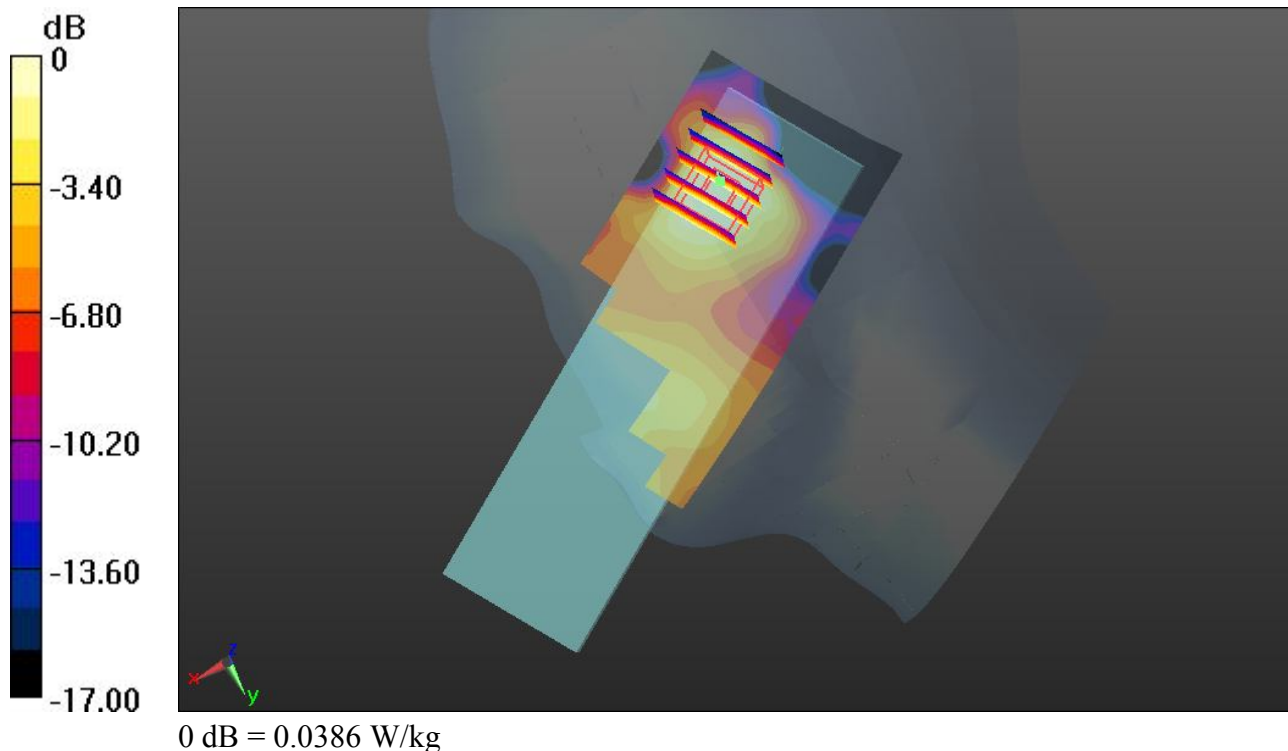

### 11 GSM1900\_GSM Voice\_Left Cheek\_Ch810

**DUT: 222402-01**

Communication System: Generic GSM; Frequency: 1909.8 MHz; Duty Cycle: 1:8.3

Medium: HSL\_1900\_130129 Medium parameters used:  $f = 1910$  MHz;  $\sigma = 1.436$  mho/m;  $\epsilon_r =$

41.187;  $\rho = 1000$  kg/m<sup>3</sup>

Ambient Temperature : 23.6 °C ; Liquid Temperature : 21.6 °C

DASY5 Configuration:

- Probe: EX3DV4 - SN3819; ConvF(7.84, 7.84, 7.84); Calibrated: 26.11.2012;
- Sensor-Surface: 2mm (Mechanical Surface Detection)
- Electronics: DAE4 Sn1303; Calibrated: 22.11.2012
- Phantom: SAM1; Type: QD000P40CD; Serial: TP:1670
- Measurement SW: DASY52, Version 52.8 (2); SEMCAD X Version 14.6.6 (6824)

**Ch810/Area Scan (51x141x1):** Interpolated grid: dx=15mm, dy=15mm

Maximum value of SAR (interpolated) = 0.0784 W/kg

**Ch810/Zoom Scan (5x5x7)/Cube 0:** Measurement grid: dx=8mm, dy=8mm, dz=5mm

Reference Value = 7.449 V/m; Power Drift = 0.02 dB

Peak SAR (extrapolated) = 0.104 mW/g

**SAR(1 g) = 0.062 mW/g; SAR(10 g) = 0.039 mW/g**

Maximum value of SAR (measured) = 0.0822 W/kg

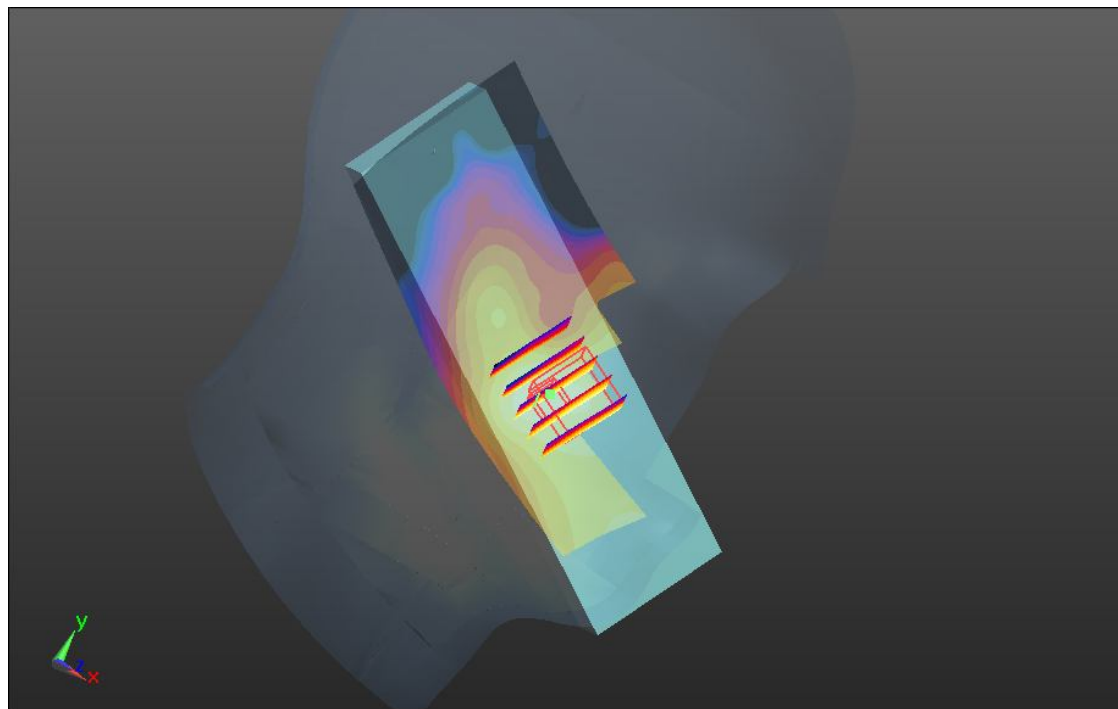
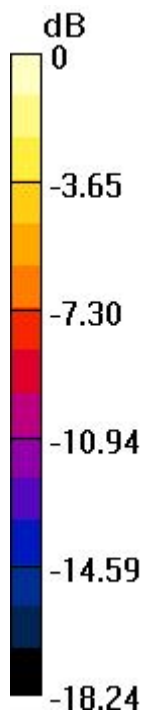

0 dB = 0.0822 W/kg

## 12 GSM1900\_GSM Voice\_Left Tilted\_Ch810

**DUT: 222402-01**

Communication System: Generic GSM; Frequency: 1909.8 MHz; Duty Cycle: 1:8.3

Medium: HSL\_1900\_130129 Medium parameters used:  $f = 1910$  MHz;  $\sigma = 1.436$  mho/m;  $\epsilon_r =$

41.187;  $\rho = 1000$  kg/m<sup>3</sup>

Ambient Temperature : 23.6 °C ; Liquid Temperature : 21.6 °C

DASY5 Configuration:

- Probe: EX3DV4 - SN3819; ConvF(7.84, 7.84, 7.84); Calibrated: 26.11.2012;
- Sensor-Surface: 2mm (Mechanical Surface Detection)
- Electronics: DAE4 Sn1303; Calibrated: 22.11.2012
- Phantom: SAM1; Type: QD000P40CD; Serial: TP:1670
- Measurement SW: DASY52, Version 52.8 (2); SEMCAD X Version 14.6.6 (6824)

**Ch810/Area Scan (51x141x1):** Interpolated grid: dx=15mm, dy=15mm

Maximum value of SAR (interpolated) = 0.0506 W/kg

**Ch810/Zoom Scan (5x5x7)/Cube 0:** Measurement grid: dx=8mm, dy=8mm, dz=5mm

Reference Value = 4.402 V/m; Power Drift = -0.03 dB

Peak SAR (extrapolated) = 0.041 mW/g

**SAR(1 g) = 0.026 mW/g; SAR(10 g) = 0.015 mW/g**

Maximum value of SAR (measured) = 0.0337 W/kg

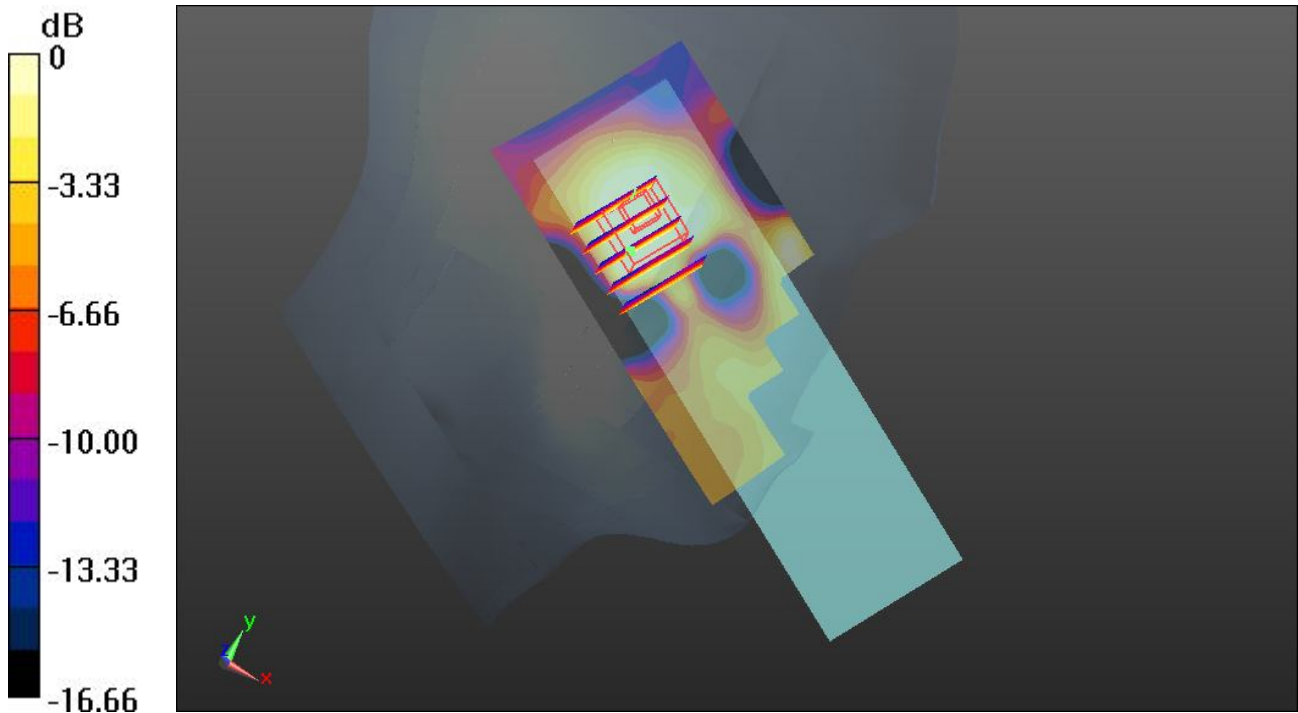

0 dB = 0.0337 W/kg



**13 GSM1900\_GSM Voice\_Right Cheek-SAR in mouth area\_3.5cm\_Ch810**

**DUT: 222402-01**

Communication System: Generic GSM; Frequency: 1909.8 MHz; Duty Cycle: 1:8.3

Medium: HSL\_1900\_130129 Medium parameters used:  $f = 1910$  MHz;  $\sigma = 1.436$  mho/m;  $\epsilon_r =$

41.187;  $\rho = 1000$  kg/m<sup>3</sup>

Ambient Temperature : 23.6 °C ; Liquid Temperature : 21.6 °C

DASY5 Configuration:

- Probe: EX3DV4 - SN3819; ConvF(7.84, 7.84, 7.84); Calibrated: 26.11.2012;
- Sensor-Surface: 2mm (Mechanical Surface Detection)
- Electronics: DAE4 Sn1303; Calibrated: 22.11.2012
- Phantom: SAM1; Type: QD000P40CD; Serial: TP:1670
- Measurement SW: DASY52, Version 52.8 (2); SEMCAD X Version 14.6.6 (6824)

**Ch810/Area Scan (81x51x1):** Interpolated grid: dx=15mm, dy=15mm

Maximum value of SAR (interpolated) = 0.0302 W/kg

**Ch810/Zoom Scan (5x5x7)/Cube 0:** Measurement grid: dx=8mm, dy=8mm, dz=5mm

Reference Value = 4.646 V/m; Power Drift = -0.10 dB

Peak SAR (extrapolated) = 0.038 mW/g

**SAR(1 g) = 0.024 mW/g; SAR(10 g) = 0.015 mW/g**

Maximum value of SAR (measured) = 0.0305 W/kg

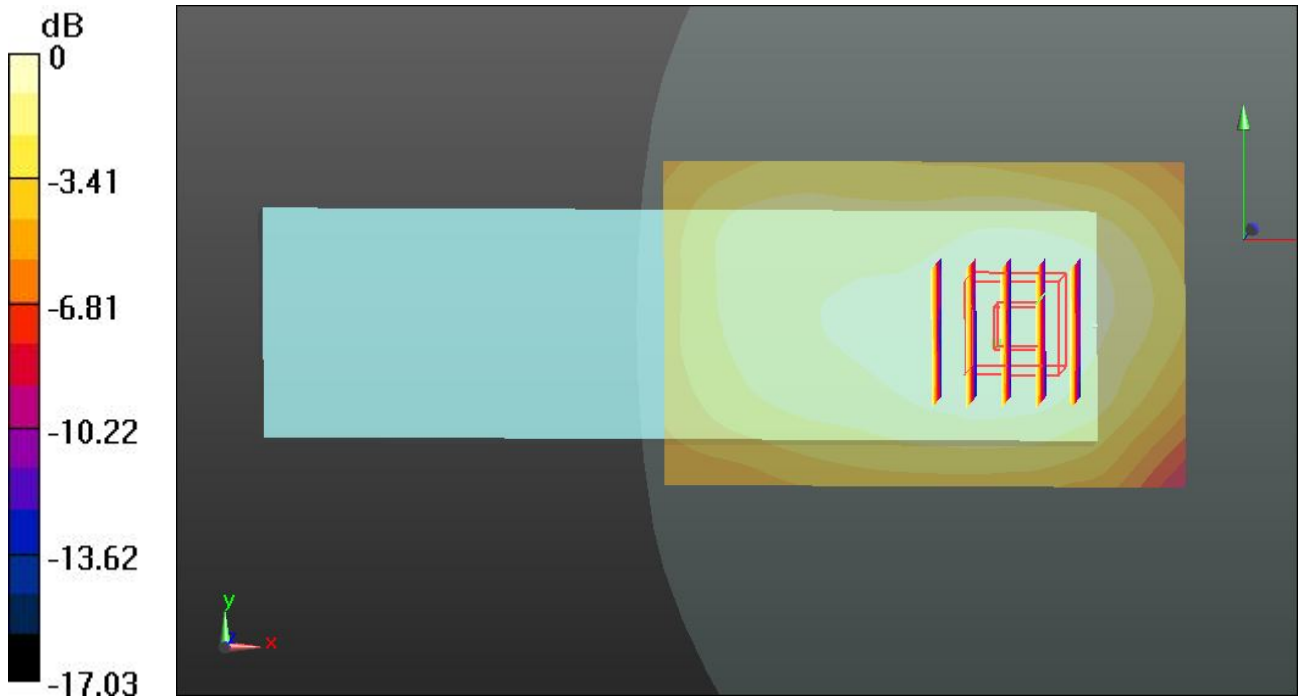

0 dB = 0.0305 W/kg



**14 GSM1900\_GSM Voice\_Right Tilted-SAR in mouth area\_6.5cm\_Ch810**

**DUT: 222402-01**

Communication System: Generic GSM; Frequency: 1909.8 MHz; Duty Cycle: 1:8.3

Medium: HSL\_1900\_130129 Medium parameters used:  $f = 1910$  MHz;  $\sigma = 1.436$  mho/m;  $\epsilon_r = 41.187$ ;  $\rho$

$= 1000$  kg/m<sup>3</sup>

Ambient Temperature : 23.6 °C ; Liquid Temperature : 21.6 °C

DASY5 Configuration:

- Probe: EX3DV4 - SN3819; ConvF(7.84, 7.84, 7.84); Calibrated: 26.11.2012;
- Sensor-Surface: 2mm (Mechanical Surface Detection)
- Electronics: DAE4 Sn1303; Calibrated: 22.11.2012
- Phantom: SAM1; Type: QD000P40CD; Serial: TP:1670
- Measurement SW: DASY52, Version 52.8 (2); SEMCAD X Version 14.6.6 (6824)

**Ch810/Area Scan (81x51x1):** Interpolated grid: dx=15mm, dy=15mm

Maximum value of SAR (interpolated) = 0.0100 W/kg

**Ch810/Zoom Scan (5x5x7)/Cube 0:** Measurement grid: dx=8mm, dy=8mm, dz=5mm

Reference Value = 2.605 V/m; Power Drift = -0.04 dB

Peak SAR (extrapolated) = 0.013 mW/g

**SAR(1 g) = 0.00833 mW/g; SAR(10 g) = 0.00522 mW/g**

Maximum value of SAR (measured) = 0.0110 W/kg

**Ch810/Zoom Scan (5x5x7)/Cube 1:** Measurement grid: dx=8mm, dy=8mm, dz=5mm

Reference Value = 2.605 V/m; Power Drift = -0.04 dB

Peak SAR (extrapolated) = 0.014 mW/g

**SAR(1 g) = 0.00696 mW/g; SAR(10 g) = 0.00437 mW/g**

Maximum value of SAR (measured) = 0.00992 W/kg

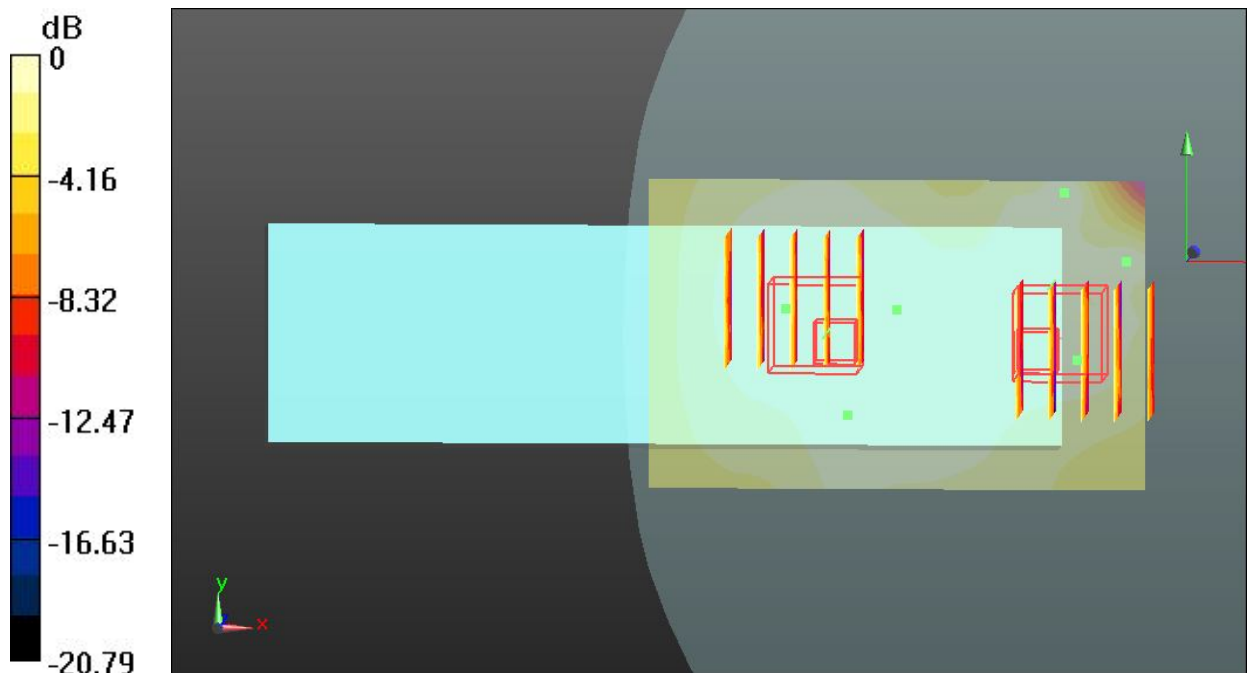

0 dB = 0.00992 W/kg

**15 GSM1900\_GSM Voice\_Left Cheek-SAR in mouth area\_3.4cm\_Ch810**

**DUT: 222402-01**

Communication System: Generic GSM; Frequency: 1909.8 MHz; Duty Cycle: 1:8.3

Medium: HSL\_1900\_130129 Medium parameters used:  $f = 1910 \text{ MHz}$ ;  $\sigma = 1.436 \text{ mho/m}$ ;  $\epsilon_r =$

$41.187$ ;  $\rho = 1000 \text{ kg/m}^3$

Ambient Temperature :  $23.6 \text{ }^\circ\text{C}$  ; Liquid Temperature :  $21.6 \text{ }^\circ\text{C}$

DASY5 Configuration:

- Probe: EX3DV4 - SN3819; ConvF(7.84, 7.84, 7.84); Calibrated: 26.11.2012;
- Sensor-Surface: 2mm (Mechanical Surface Detection)
- Electronics: DAE4 Sn1303; Calibrated: 22.11.2012
- Phantom: SAM1; Type: QD000P40CD; Serial: TP:1670
- Measurement SW: DASY52, Version 52.8 (2); SEMCAD X Version 14.6.6 (6824)

**Ch810/Area Scan (81x51x1):** Interpolated grid:  $dx=15\text{mm}$ ,  $dy=15\text{mm}$

Maximum value of SAR (interpolated) =  $0.0363 \text{ W/kg}$

**Ch810/Zoom Scan (5x5x7)/Cube 0:** Measurement grid:  $dx=8\text{mm}$ ,  $dy=8\text{mm}$ ,  $dz=5\text{mm}$

Reference Value =  $5.189 \text{ V/m}$ ; Power Drift =  $-0.07 \text{ dB}$

Peak SAR (extrapolated) =  $0.047 \text{ mW/g}$

**SAR(1 g) =  $0.028 \text{ mW/g}$ ; SAR(10 g) =  $0.018 \text{ mW/g}$**

Maximum value of SAR (measured) =  $0.0367 \text{ W/kg}$

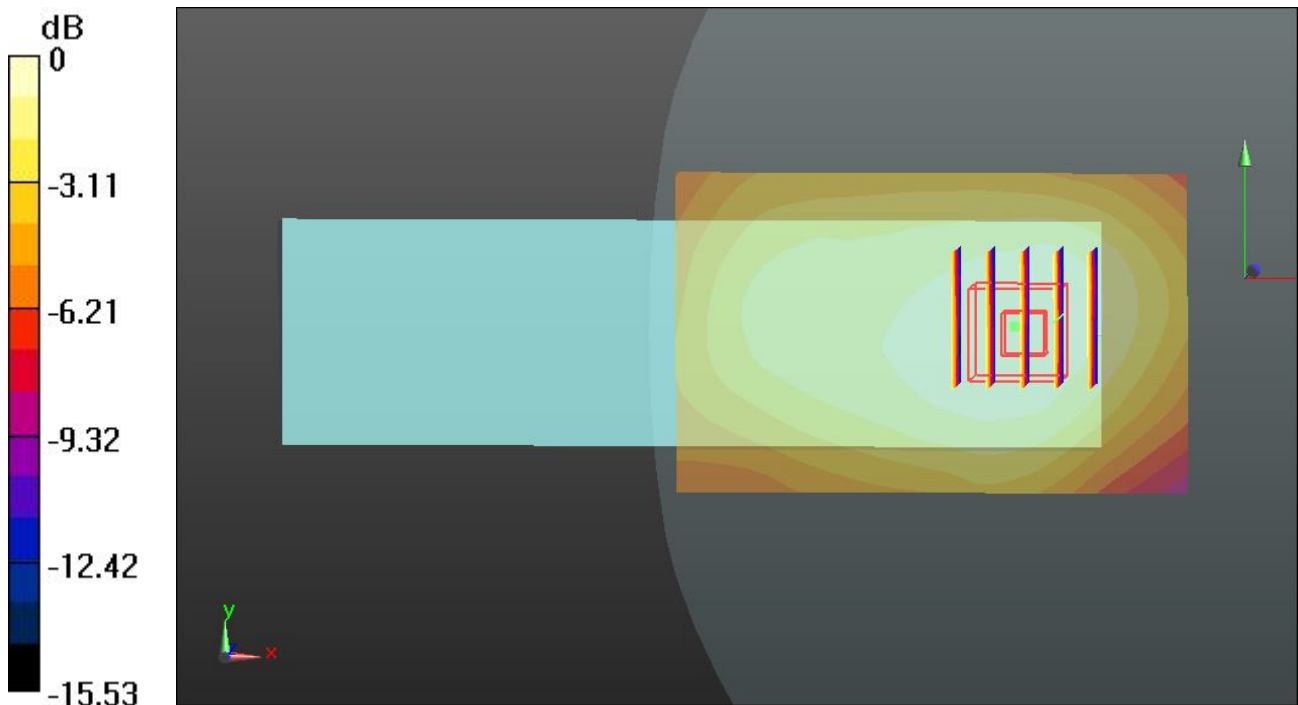

0 dB =  $0.0367 \text{ W/kg}$

**16 GSM1900\_GSM Voice\_Left Tilted-SAR in mouth area\_6.6cm\_Ch810**

**DUT: 222402-01**

Communication System: Generic GSM; Frequency: 1909.8 MHz; Duty Cycle: 1:8.3

Medium: HSL\_1900\_130129 Medium parameters used:  $f = 1910 \text{ MHz}$ ;  $\sigma = 1.436 \text{ mho/m}$ ;  $\epsilon_r = 41.187$ ;  $\rho$

$= 1000 \text{ kg/m}^3$

Ambient Temperature :  $23.6 \text{ }^\circ\text{C}$ ; Liquid Temperature :  $21.6 \text{ }^\circ\text{C}$

DASY5 Configuration:

- Probe: EX3DV4 - SN3819; ConvF(7.84, 7.84, 7.84); Calibrated: 26.11.2012;
- Sensor-Surface: 2mm (Mechanical Surface Detection)
- Electronics: DAE4 Sn1303; Calibrated: 22.11.2012
- Phantom: SAM1; Type: QD000P40CD; Serial: TP:1670
- Measurement SW: DASY52, Version 52.8 (2); SEMCAD X Version 14.6.6 (6824)

**Ch810/Area Scan (81x51x1):** Interpolated grid:  $dx=15\text{mm}$ ,  $dy=15\text{mm}$

Maximum value of SAR (interpolated) =  $0.00994 \text{ W/kg}$

**Ch810/Zoom Scan (5x5x7)/Cube 0:** Measurement grid:  $dx=8\text{mm}$ ,  $dy=8\text{mm}$ ,  $dz=5\text{mm}$

Reference Value =  $2.562 \text{ V/m}$ ; Power Drift =  $-0.07 \text{ dB}$

Peak SAR (extrapolated) =  $0.014 \text{ mW/g}$

**SAR(1 g) =  $0.00827 \text{ mW/g}$ ; SAR(10 g) =  $0.00528 \text{ mW/g}$**

Maximum value of SAR (measured) =  $0.0112 \text{ W/kg}$

**Ch810/Zoom Scan (5x5x7)/Cube 1:** Measurement grid:  $dx=8\text{mm}$ ,  $dy=8\text{mm}$ ,  $dz=5\text{mm}$

Reference Value =  $2.562 \text{ V/m}$ ; Power Drift =  $-0.07 \text{ dB}$

Peak SAR (extrapolated) =  $0.015 \text{ mW/g}$

**SAR(1 g) =  $0.00761 \text{ mW/g}$ ; SAR(10 g) =  $0.00479 \text{ mW/g}$**

Maximum value of SAR (measured) =  $0.0110 \text{ W/kg}$

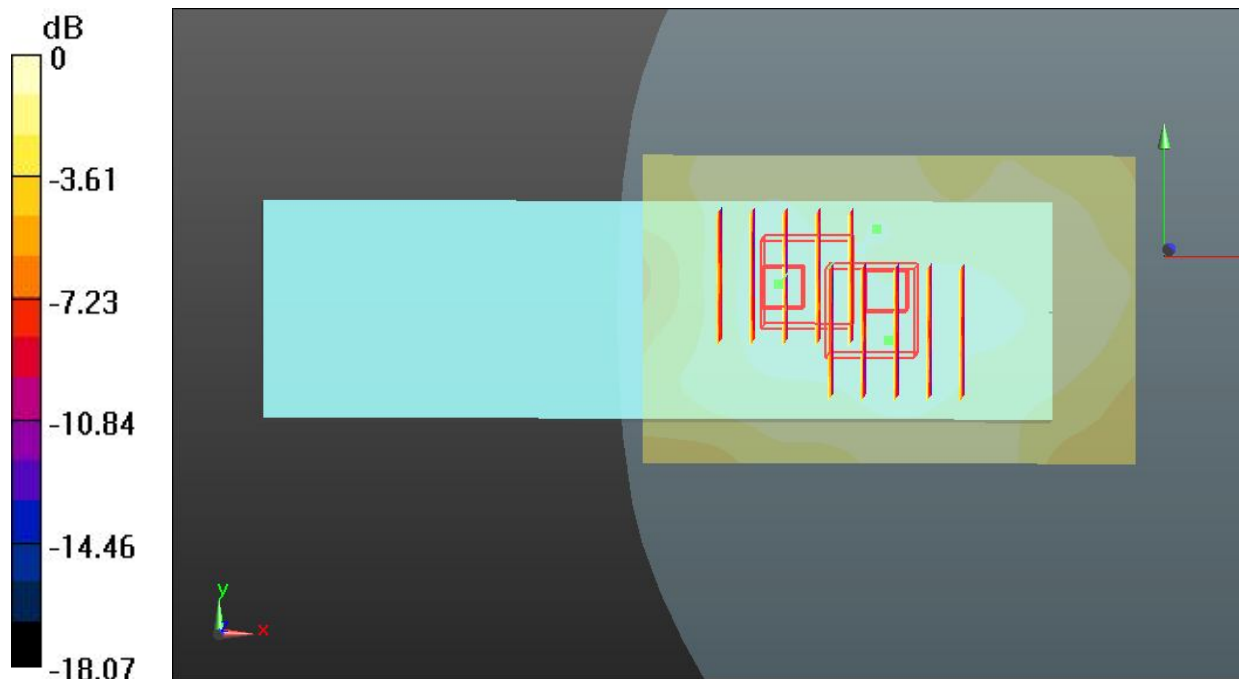

0 dB =  $0.0110 \text{ W/kg}$

### 17 WCDMA Band V\_RMC 12.2K\_Right Cheek\_Ch4182

**DUT: 222402-01**

Communication System: UMTS; Frequency: 836.4 MHz; Duty Cycle: 1:1

Medium: HSL\_835\_130129 Medium parameters used:  $f = 836.4$  MHz;  $\sigma = 0.902$  mho/m;  $\epsilon_r = 40.572$ ;

$\rho = 1000$  kg/m<sup>3</sup>

Ambient Temperature : 23.5 °C ; Liquid Temperature : 21.3 °C

DASY5 Configuration:

- Probe: EX3DV4 - SN3819; ConvF(9.56, 9.56, 9.56); Calibrated: 26.11.2012;
- Sensor-Surface: 2mm (Mechanical Surface Detection)
- Electronics: DAE4 Sn1303; Calibrated: 22.11.2012
- Phantom: SAM2; Type: QD000P40CD; Serial: TP:1671
- Measurement SW: DASY52, Version 52.8 (2); SEMCAD X Version 14.6.6 (6824)

**Ch4182/Area Scan (51x141x1):** Interpolated grid: dx=15mm, dy=15mm

Maximum value of SAR (interpolated) = 0.329 W/kg

**Ch4182/Zoom Scan (5x5x7)/Cube 0:** Measurement grid: dx=8mm, dy=8mm, dz=5mm

Reference Value = 18.130 V/m; Power Drift = 0.08 dB

Peak SAR (extrapolated) = 0.424 mW/g

**SAR(1 g) = 0.250 mW/g; SAR(10 g) = 0.143 mW/g**

Maximum value of SAR (measured) = 0.314 W/kg

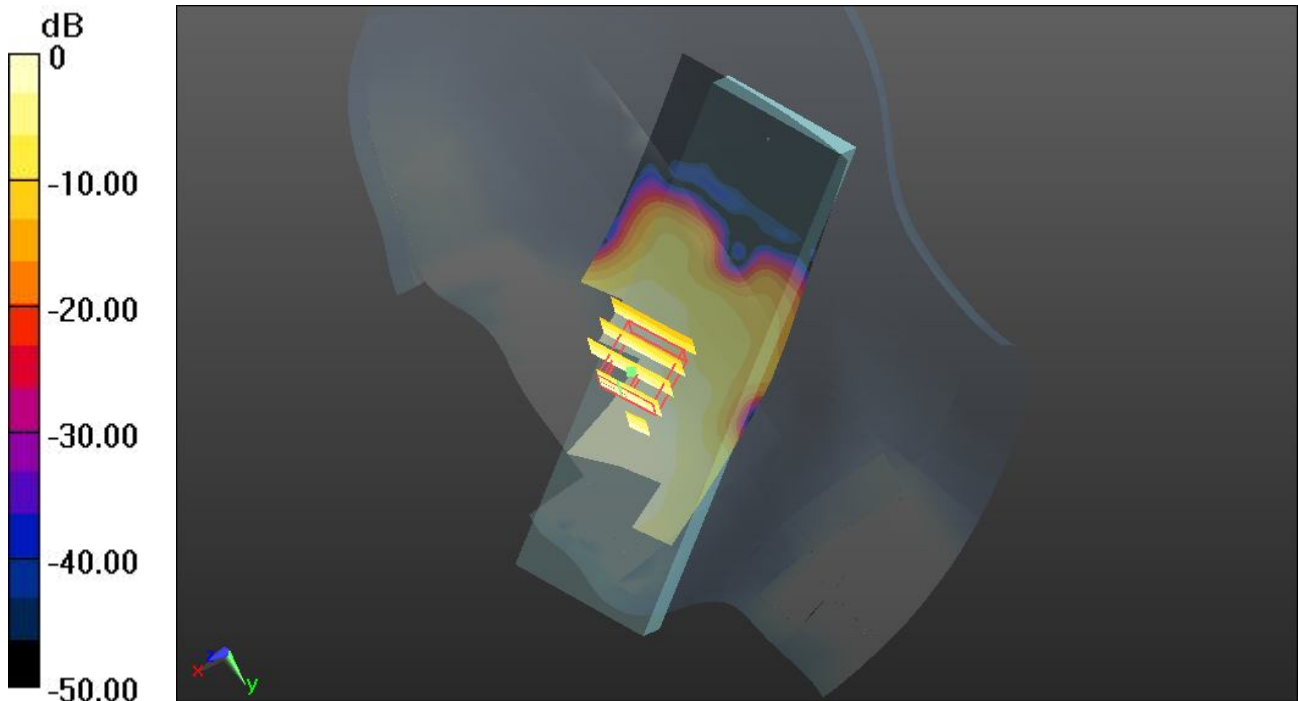

0 dB = 0.314 W/kg

### 18 WCDMA Band V\_RMC 12.2K\_Right Tilted\_Ch4182

**DUT: 222402-01**

Communication System: UMTS; Frequency: 836.4 MHz; Duty Cycle: 1:1

Medium: HSL\_835\_130129 Medium parameters used:  $f = 836.4$  MHz;  $\sigma = 0.902$  mho/m;  $\epsilon_r = 40.572$ ;  $\rho = 1000$  kg/m<sup>3</sup>

Ambient Temperature : 23.5 °C ; Liquid Temperature : 21.3 °C

DASY5 Configuration:

- Probe: EX3DV4 - SN3819; ConvF(9.56, 9.56, 9.56); Calibrated: 26.11.2012;
- Sensor-Surface: 2mm (Mechanical Surface Detection)
- Electronics: DAE4 Sn1303; Calibrated: 22.11.2012
- Phantom: SAM2; Type: QD000P40CD; Serial: TP:1671
- Measurement SW: DASY52, Version 52.8 (2); SEMCAD X Version 14.6.6 (6824)

**Ch4182/Area Scan (51x141x1):** Interpolated grid: dx=15mm, dy=15mm

Maximum value of SAR (interpolated) = 0.0516 W/kg

**Ch4182/Zoom Scan (5x5x7)/Cube 0:** Measurement grid: dx=8mm, dy=8mm, dz=5mm

Reference Value = 7.687 V/m; Power Drift = 0.01 dB

Peak SAR (extrapolated) = 0.059 mW/g

**SAR(1 g) = 0.045 mW/g; SAR(10 g) = 0.032 mW/g**

Maximum value of SAR (measured) = 0.0528 W/kg

**Ch4182/Zoom Scan (5x5x7)/Cube 1:** Measurement grid: dx=8mm, dy=8mm, dz=5mm

Reference Value = 7.687 V/m; Power Drift = 0.01 dB

Peak SAR (extrapolated) = 0.065 mW/g

**SAR(1 g) = 0.044 mW/g; SAR(10 g) = 0.029 mW/g**

Maximum value of SAR (measured) = 0.0522 W/kg

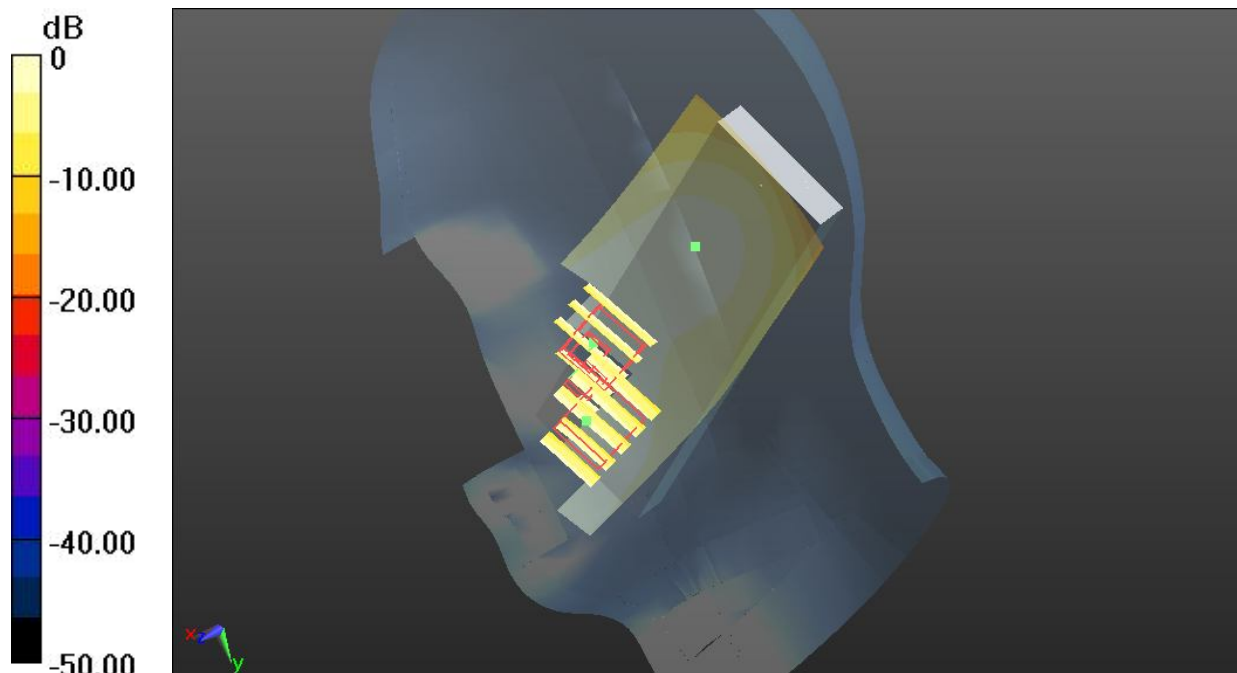

0 dB = 0.0522 W/kg

### 19 WCDMA Band V\_RMC 12.2K\_Left Cheek\_Ch4182

**DUT: 222402-01**

Communication System: UMTS; Frequency: 836.4 MHz; Duty Cycle: 1:1

Medium: HSL\_835\_130129 Medium parameters used:  $f = 836.4$  MHz;  $\sigma = 0.902$  mho/m;  $\epsilon_r = 40.572$ ;

$\rho = 1000$  kg/m<sup>3</sup>

Ambient Temperature : 23.5 °C ; Liquid Temperature : 21.3 °C

DASY5 Configuration:

- Probe: EX3DV4 - SN3819; ConvF(9.56, 9.56, 9.56); Calibrated: 26.11.2012;
- Sensor-Surface: 2mm (Mechanical Surface Detection)
- Electronics: DAE4 Sn1303; Calibrated: 22.11.2012
- Phantom: SAM2; Type: QD000P40CD; Serial: TP:1671
- Measurement SW: DASY52, Version 52.8 (2); SEMCAD X Version 14.6.6 (6824)

**Ch4182/Area Scan (51x141x1):** Interpolated grid: dx=15mm, dy=15mm

Maximum value of SAR (interpolated) = 0.489 W/kg

**Ch4182/Zoom Scan (5x5x7)/Cube 0:** Measurement grid: dx=8mm, dy=8mm, dz=5mm

Reference Value = 20.965 V/m; Power Drift = 0.05 dB

Peak SAR (extrapolated) = 0.763 mW/g

**SAR(1 g) = 0.354 mW/g; SAR(10 g) = 0.208 mW/g**

Maximum value of SAR (measured) = 0.542 W/kg

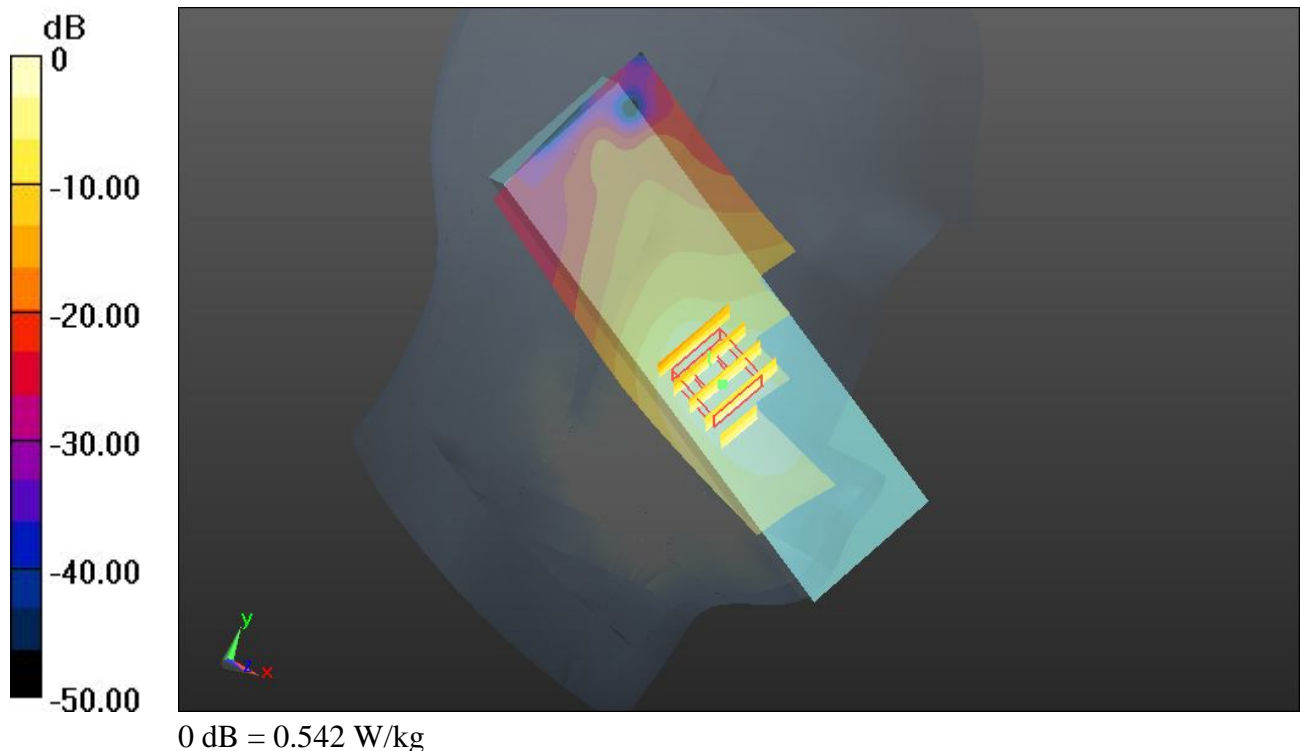

## 20 WCDMA Band V\_RMC 12.2K\_Left Tilted\_Ch4182

**DUT: 222402-01**

Communication System: UMTS; Frequency: 836.4 MHz; Duty Cycle: 1:1

Medium: HSL\_835\_130129 Medium parameters used:  $f = 836.4$  MHz;  $\sigma = 0.902$  mho/m;  $\epsilon_r = 40.572$ ;

$\rho = 1000$  kg/m<sup>3</sup>

Ambient Temperature : 23.5 °C ; Liquid Temperature : 21.3 °C

DASY5 Configuration:

- Probe: EX3DV4 - SN3819; ConvF(9.56, 9.56, 9.56); Calibrated: 26.11.2012;
- Sensor-Surface: 2mm (Mechanical Surface Detection)
- Electronics: DAE4 Sn1303; Calibrated: 22.11.2012
- Phantom: SAM2; Type: QD000P40CD; Serial: TP:1671
- Measurement SW: DASY52, Version 52.8 (2); SEMCAD X Version 14.6.6 (6824)

**Ch4182/Area Scan (51x141x1):** Interpolated grid: dx=15mm, dy=15mm

Maximum value of SAR (interpolated) = 0.0916 W/kg

**Ch4182/Zoom Scan (5x5x7)/Cube 0:** Measurement grid: dx=8mm, dy=8mm, dz=5mm

Reference Value = 10.363 V/m; Power Drift = 0.12 dB

Peak SAR (extrapolated) = 0.104 mW/g

**SAR(1 g) = 0.079 mW/g; SAR(10 g) = 0.058 mW/g**

Maximum value of SAR (measured) = 0.0934 W/kg

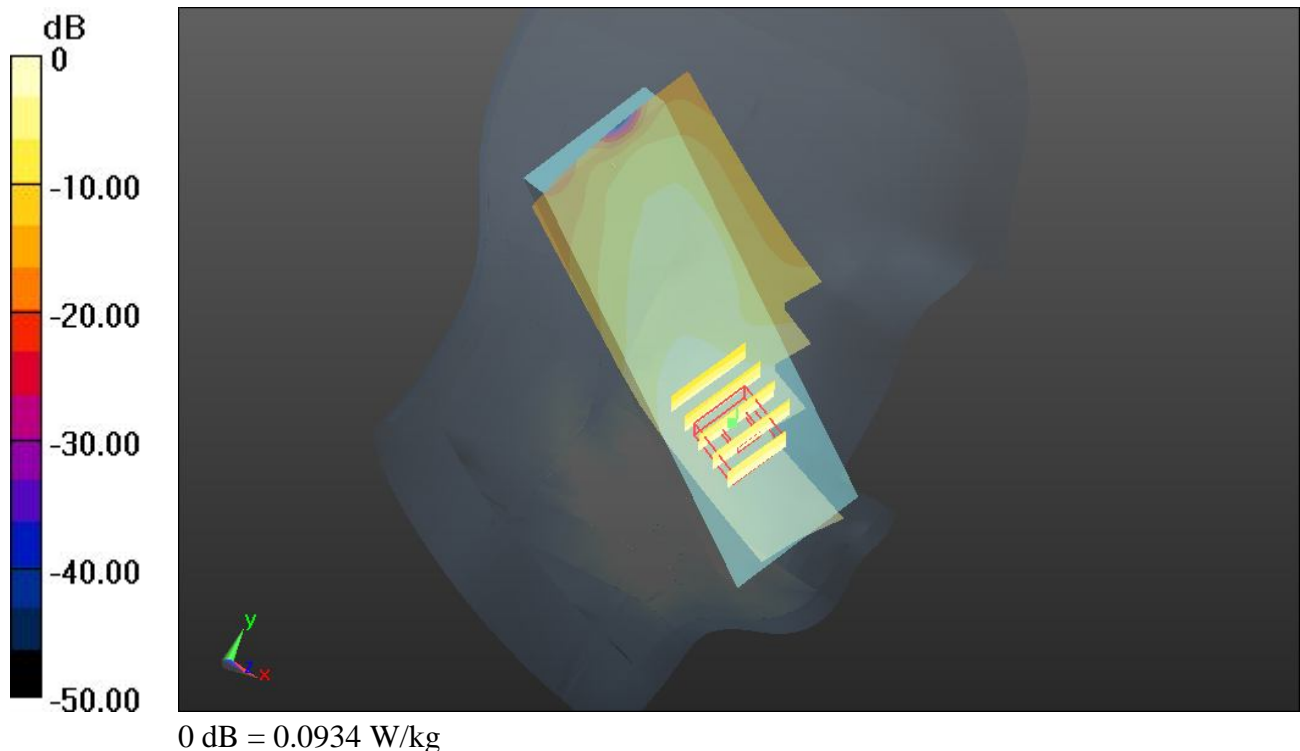



### 21 WCDMA Band V\_RMC 12.2K\_Right Cheek-SAR in mouth area\_3.5cm\_Ch4182

**DUT: 222402-01**

Communication System: UMTS; Frequency: 836.4 MHz; Duty Cycle: 1:1

Medium: HSL\_835\_130129 Medium parameters used:  $f = 836.4$  MHz;  $\sigma = 0.902$  mho/m;  $\epsilon_r = 40.572$ ;

$\rho = 1000$  kg/m<sup>3</sup>

Ambient Temperature : 23.5 °C ; Liquid Temperature : 21.3 °C

DASY5 Configuration:

- Probe: EX3DV4 - SN3819; ConvF(9.56, 9.56, 9.56); Calibrated: 26.11.2012;
- Sensor-Surface: 2mm (Mechanical Surface Detection)
- Electronics: DAE4 Sn1303; Calibrated: 22.11.2012
- Phantom: SAM2; Type: QD000P40CD; Serial: TP:1671
- Measurement SW: DASY52, Version 52.8 (2); SEMCAD X Version 14.6.6 (6824)

**Ch4182/Area Scan (81x51x1):** Interpolated grid: dx=15mm, dy=15mm

Maximum value of SAR (interpolated) = 0.161 W/kg

**Ch4182/Zoom Scan (5x5x7)/Cube 0:** Measurement grid: dx=8mm, dy=8mm, dz=5mm

Reference Value = 13.664 V/m; Power Drift = -0.05 dB

Peak SAR (extrapolated) = 0.182 mW/g

**SAR(1 g) = 0.136 mW/g; SAR(10 g) = 0.099 mW/g**

Maximum value of SAR (measured) = 0.161 W/kg

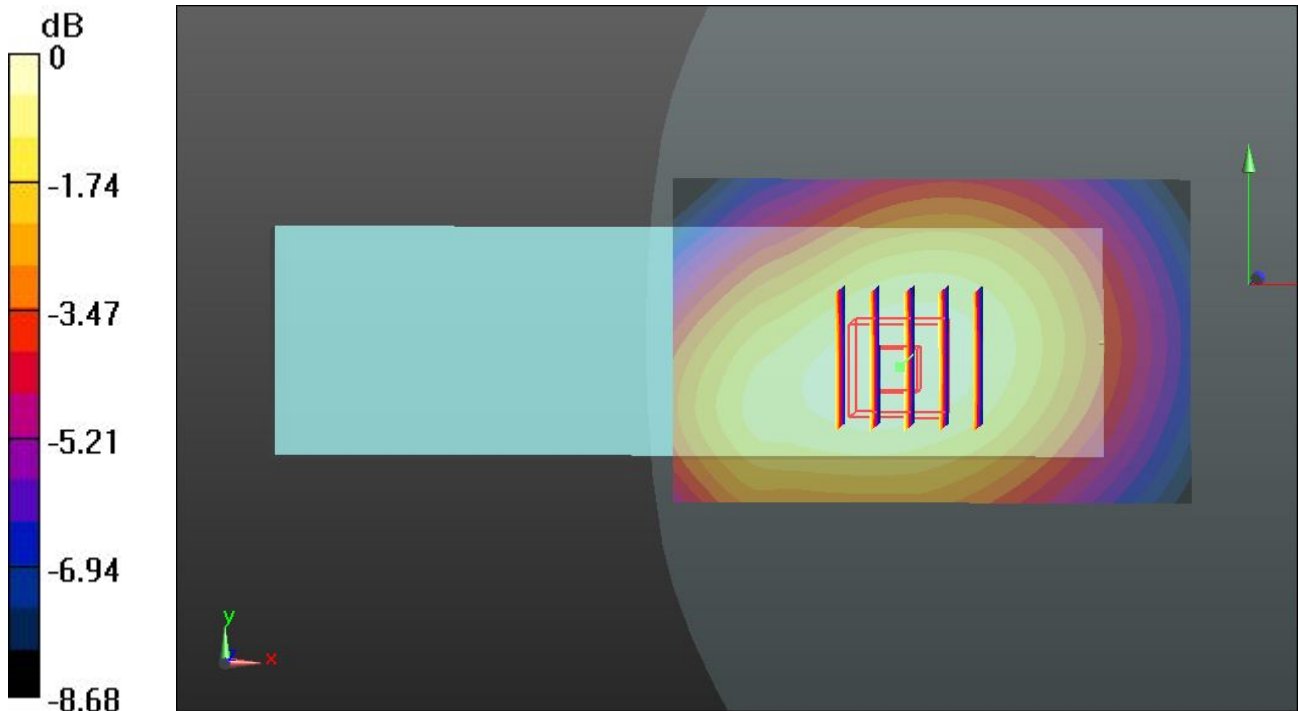

0 dB = 0.161 W/kg



**22 WCDMA Band V\_RMC 12.2K\_Right Tilted-SAR in mouth area\_6.5cm\_Ch4182**

**DUT: 222402-01**

Communication System: UMTS; Frequency: 836.4 MHz; Duty Cycle: 1:1

Medium: HSL\_835\_130129 Medium parameters used:  $f = 836.4$  MHz;  $\sigma = 0.902$  mho/m;  $\epsilon_r = 40.572$ ;  $\rho = 1000$  kg/m<sup>3</sup>

Ambient Temperature : 23.5 °C ; Liquid Temperature : 21.3 °C

DASY5 Configuration:

- Probe: EX3DV4 - SN3819; ConvF(9.56, 9.56, 9.56); Calibrated: 26.11.2012;
- Sensor-Surface: 2mm (Mechanical Surface Detection)
- Electronics: DAE4 Sn1303; Calibrated: 22.11.2012
- Phantom: SAM2; Type: QD000P40CD; Serial: TP:1671
- Measurement SW: DASY52, Version 52.8 (2); SEMCAD X Version 14.6.6 (6824)

**Ch4182/Area Scan (81x51x1):** Interpolated grid: dx=15mm, dy=15mm  
 Maximum value of SAR (interpolated) = 0.0348 W/kg

**Ch4182/Zoom Scan (5x5x7)/Cube 0:** Measurement grid: dx=8mm, dy=8mm, dz=5mm  
 Reference Value = 6.332 V/m; Power Drift = -0.04 dB  
 Peak SAR (extrapolated) = 0.040 mW/g  
**SAR(1 g) = 0.030 mW/g; SAR(10 g) = 0.022 mW/g**  
 Maximum value of SAR (measured) = 0.0351 W/kg

**Ch4182/Zoom Scan (5x5x7)/Cube 1:** Measurement grid: dx=8mm, dy=8mm, dz=5mm  
 Reference Value = 6.332 V/m; Power Drift = -0.04 dB  
 Peak SAR (extrapolated) = 0.037 mW/g  
**SAR(1 g) = 0.027 mW/g; SAR(10 g) = 0.021 mW/g**  
 Maximum value of SAR (measured) = 0.0320 W/kg

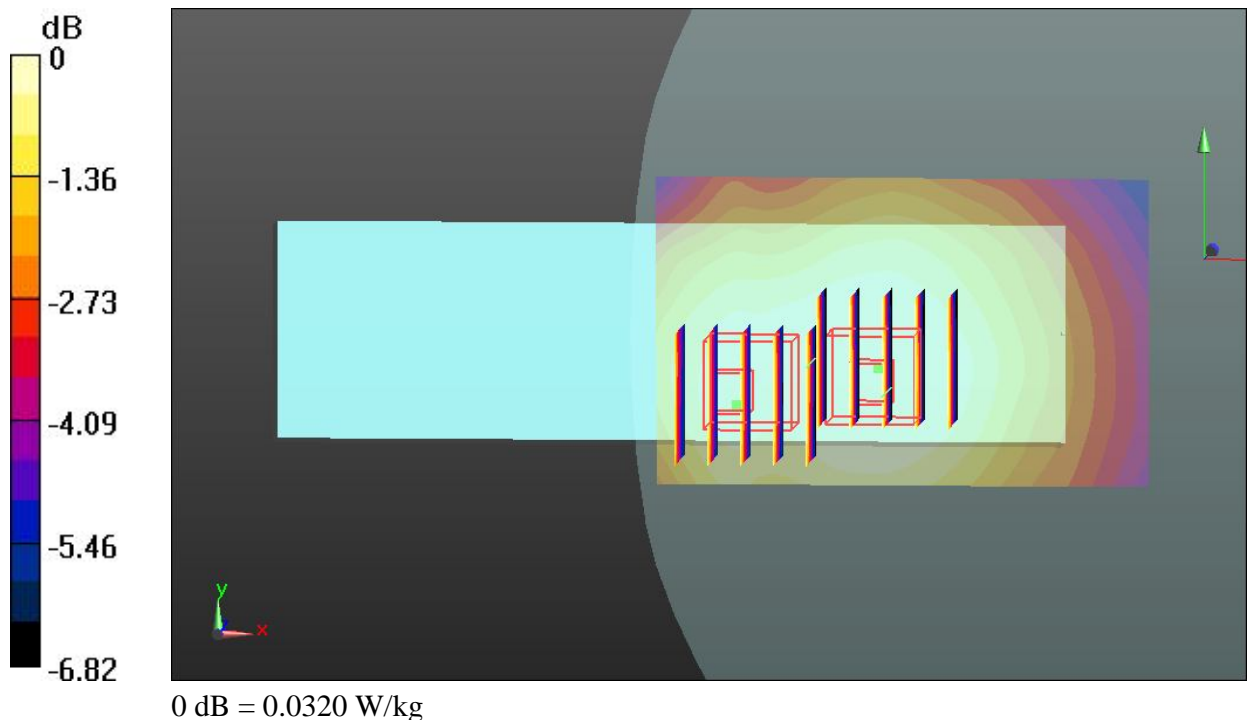

**23 WCDMA Band V\_RMC 12.2K\_Left Cheek-SAR in mouth area\_3.4cm\_Ch4182**

**DUT: 222402-01**

Communication System: UMTS; Frequency: 836.4 MHz; Duty Cycle: 1:1

Medium: HSL\_835\_130129 Medium parameters used:  $f = 836.4$  MHz;  $\sigma = 0.902$  mho/m;  $\epsilon_r = 40.572$ ;

$\rho = 1000$  kg/m<sup>3</sup>

Ambient Temperature : 23.5 °C ; Liquid Temperature : 21.3 °C

DASY5 Configuration:

- Probe: EX3DV4 - SN3819; ConvF(9.56, 9.56, 9.56); Calibrated: 26.11.2012;
- Sensor-Surface: 2mm (Mechanical Surface Detection)
- Electronics: DAE4 Sn1303; Calibrated: 22.11.2012
- Phantom: SAM2; Type: QD000P40CD; Serial: TP:1671
- Measurement SW: DASY52, Version 52.8 (2); SEMCAD X Version 14.6.6 (6824)

**Ch4182/Area Scan (81x51x1):** Interpolated grid: dx=15mm, dy=15mm

Maximum value of SAR (interpolated) = 0.192 W/kg

**Ch4182/Zoom Scan (5x5x7)/Cube 0:** Measurement grid: dx=8mm, dy=8mm, dz=5mm

Reference Value = 14.896 V/m; Power Drift = -0.02 dB

Peak SAR (extrapolated) = 0.216 mW/g

**SAR(1 g) = 0.160 mW/g; SAR(10 g) = 0.117 mW/g**

Maximum value of SAR (measured) = 0.191 W/kg

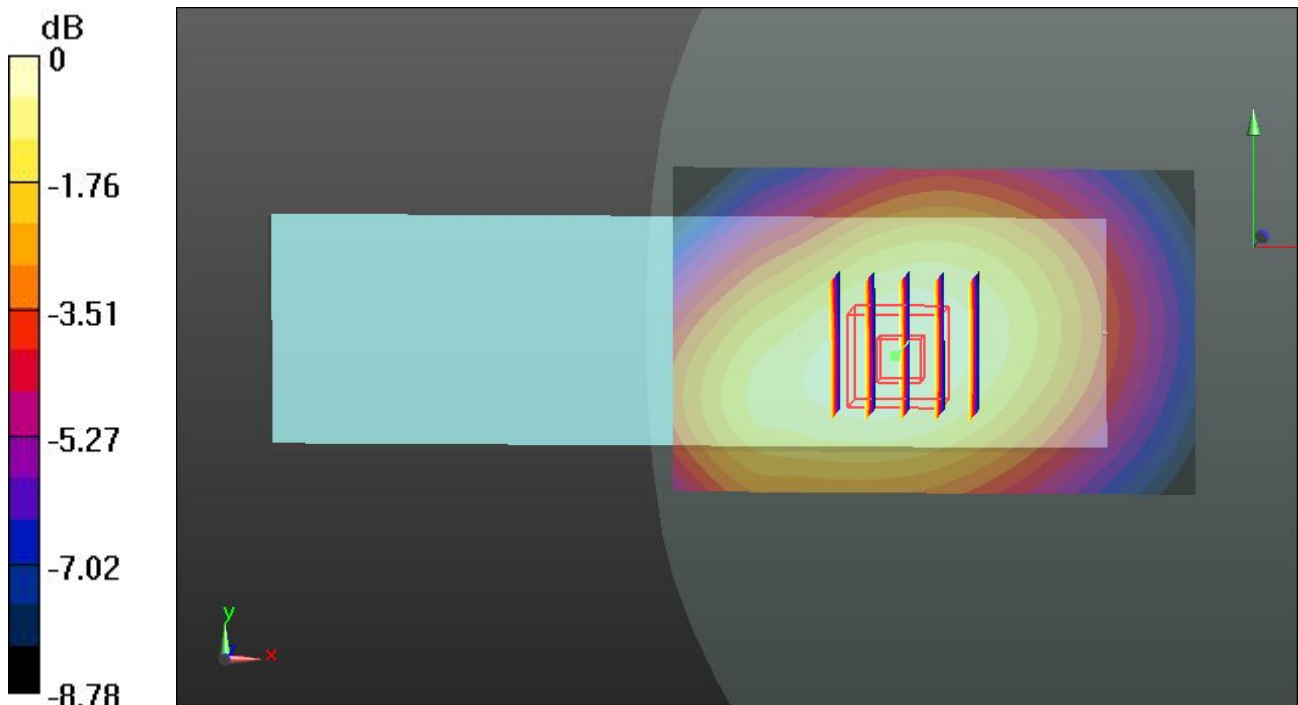

0 dB = 0.191 W/kg

**24 WCDMA Band V\_RMC 12.2K\_Left Tilted-SAR in mouth area\_6.6cm\_Ch4182**

**DUT: 222402-01**

Communication System: UMTS; Frequency: 836.4 MHz; Duty Cycle: 1:1

Medium: HSL\_835\_130129 Medium parameters used:  $f = 836.4$  MHz;  $\sigma = 0.902$  mho/m;  $\epsilon_r = 40.572$ ;  $\rho = 1000$  kg/m<sup>3</sup>

Ambient Temperature : 23.5 °C ; Liquid Temperature : 21.3 °C

DASY5 Configuration:

- Probe: EX3DV4 - SN3819; ConvF(9.56, 9.56, 9.56); Calibrated: 26.11.2012;
- Sensor-Surface: 2mm (Mechanical Surface Detection)
- Electronics: DAE4 Sn1303; Calibrated: 22.11.2012
- Phantom: SAM2; Type: QD000P40CD; Serial: TP:1671
- Measurement SW: DASY52, Version 52.8 (2); SEMCAD X Version 14.6.6 (6824)

**Ch4182/Area Scan (81x51x1):** Interpolated grid: dx=15mm, dy=15mm

Maximum value of SAR (interpolated) = 0.0320 W/kg

**Ch4182/Zoom Scan (5x5x7)/Cube 0:** Measurement grid: dx=8mm, dy=8mm, dz=5mm

Reference Value = 6.047 V/m; Power Drift = 0.01 dB

Peak SAR (extrapolated) = 0.036 mW/g

**SAR(1 g) = 0.027 mW/g; SAR(10 g) = 0.020 mW/g**

Maximum value of SAR (measured) = 0.0312 W/kg

**Ch4182/Zoom Scan (5x5x7)/Cube 1:** Measurement grid: dx=8mm, dy=8mm, dz=5mm

Reference Value = 6.047 V/m; Power Drift = 0.01 dB

Peak SAR (extrapolated) = 0.033 mW/g

**SAR(1 g) = 0.024 mW/g; SAR(10 g) = 0.019 mW/g**

Maximum value of SAR (measured) = 0.0292 W/kg

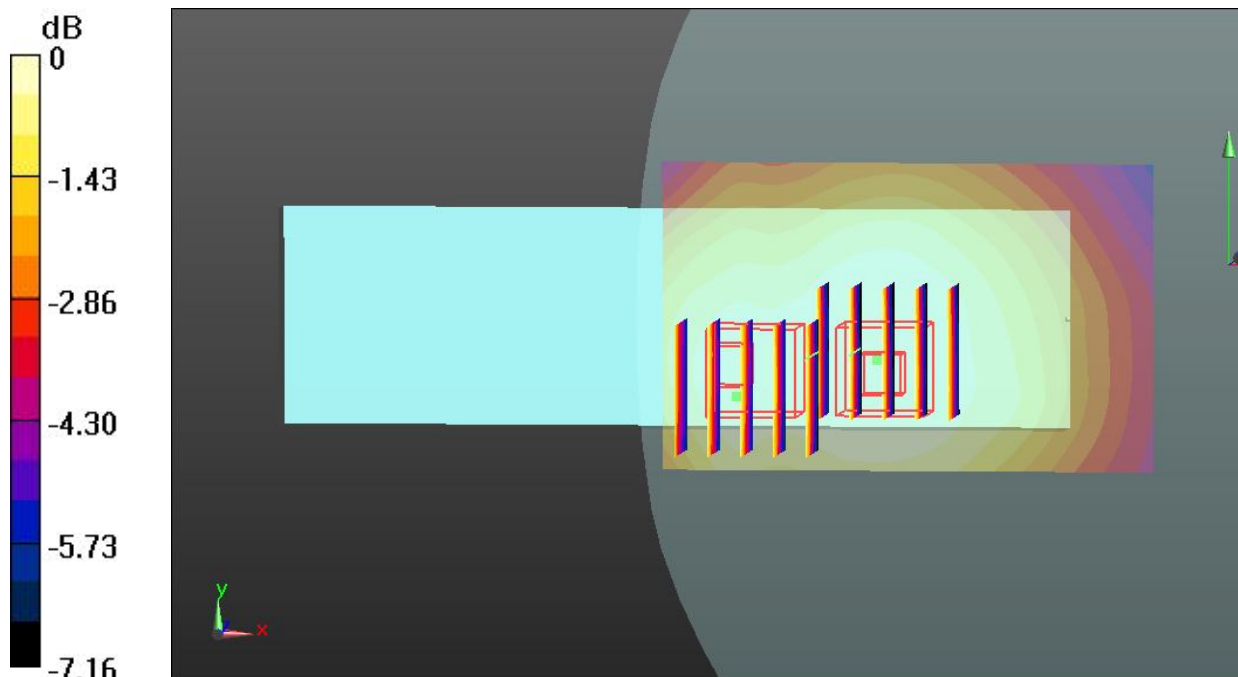

0 dB = 0.0292 W/kg

**25 GSM1900\_GSM Voice\_Front\_1.5cm\_Ch810**

**DUT: 222402-01**

Communication System: Generic GSM; Frequency: 1909.8 MHz; Duty Cycle: 1:8.3

Medium: MSL\_1900\_130129 Medium parameters used:  $f = 1910$  MHz;  $\sigma = 1.511$  mho/m;  $\epsilon_r = 53.819$ ;  $\rho = 1000$  kg/m<sup>3</sup>

Ambient Temperature : 23.3 °C ; Liquid Temperature : 21.5 °C

DASY5 Configuration:

- Probe: EX3DV4 - SN3819; ConvF(7.67, 7.67, 7.67); Calibrated: 26.11.2012;
- Sensor-Surface: 2mm (Mechanical Surface Detection)
- Electronics: DAE4 Sn1303; Calibrated: 22.11.2012
- Phantom: SAM1; Type: QD000P40CD; Serial: TP:1670
- Measurement SW: DASY52, Version 52.8 (2); SEMCAD X Version 14.6.6 (6824)

**Ch810/Area Scan (51x81x1):** Interpolated grid: dx=15mm, dy=15mm

Maximum value of SAR (interpolated) = 0.0652 W/kg

**Ch810/Zoom Scan (5x5x7)/Cube 0:** Measurement grid: dx=8mm, dy=8mm, dz=5mm

Reference Value = 6.579 V/m; Power Drift = -0.05 dB

Peak SAR (extrapolated) = 0.077 mW/g

**SAR(1 g) = 0.050 mW/g; SAR(10 g) = 0.031 mW/g**

Maximum value of SAR (measured) = 0.0638 W/kg

**Ch810/Zoom Scan (5x5x7)/Cube 1:** Measurement grid: dx=8mm, dy=8mm, dz=5mm

Reference Value = 6.579 V/m; Power Drift = -0.05 dB

Peak SAR (extrapolated) = 0.072 mW/g

**SAR(1 g) = 0.048 mW/g; SAR(10 g) = 0.030 mW/g**

Maximum value of SAR (measured) = 0.0606 W/kg

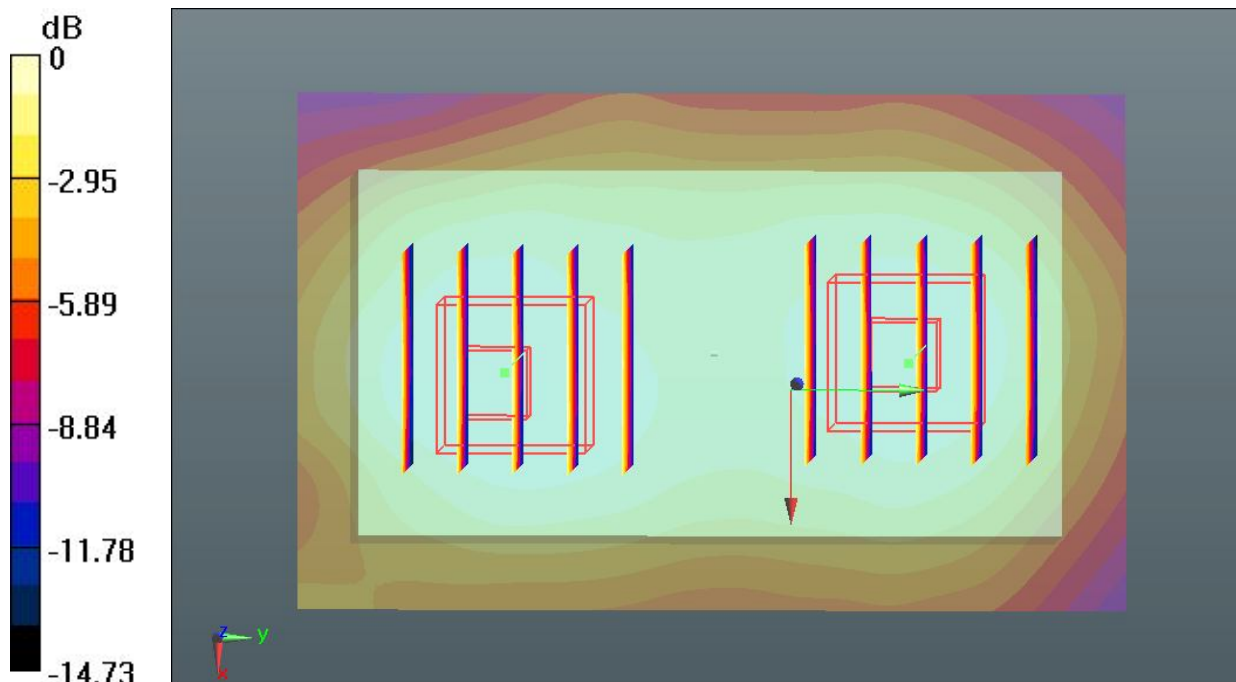

0 dB = 0.0606 W/kg

**26 GSM1900\_GSM Voice\_Back\_1.5cm\_Ch810**

**DUT: 222402-01**

Communication System: Generic GSM; Frequency: 1909.8 MHz; Duty Cycle: 1:8.3  
 Medium: MSL\_1900\_130129 Medium parameters used:  $f = 1910$  MHz;  $\sigma = 1.511$  mho/m;  $\epsilon_r = 53.819$ ;  $\rho = 1000$  kg/m<sup>3</sup>  
 Ambient Temperature : 23.3 °C ; Liquid Temperature : 21.5 °C

DASY5 Configuration:

- Probe: EX3DV4 - SN3819; ConvF(7.67, 7.67, 7.67); Calibrated: 26.11.2012;
- Sensor-Surface: 2mm (Mechanical Surface Detection)
- Electronics: DAE4 Sn1303; Calibrated: 22.11.2012
- Phantom: SAM1; Type: QD000P40CD; Serial: TP:1670
- Measurement SW: DASY52, Version 52.8 (2); SEMCAD X Version 14.6.6 (6824)

**Ch810/Area Scan (51x81x1):** Interpolated grid: dx=15mm, dy=15mm

Maximum value of SAR (interpolated) = 0.417 W/kg

**Ch810/Zoom Scan (5x5x7)/Cube 0:** Measurement grid: dx=8mm, dy=8mm, dz=5mm

Reference Value = 16.630 V/m; Power Drift = -0.05 dB

Peak SAR (extrapolated) = 0.503 mW/g

**SAR(1 g) = 0.293 mW/g; SAR(10 g) = 0.164 mW/g**

Maximum value of SAR (measured) = 0.398 W/kg

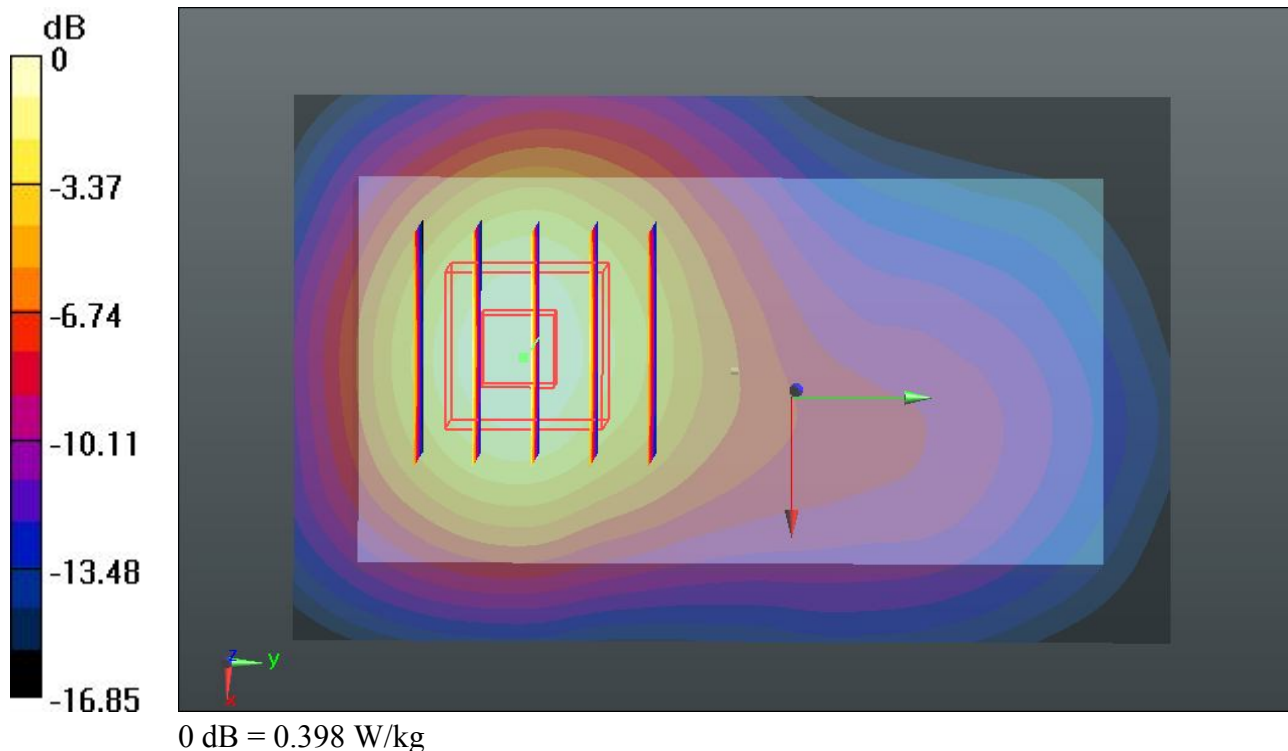

**01 WCDMA Band V\_RMC 12.2K\_Front\_1.5cm\_Ch4182**

**DUT: 222402-01**

Communication System: UMTS; Frequency: 836.4 MHz; Duty Cycle: 1:1

Medium: MSL\_835\_130129 Medium parameters used:  $f = 836.4 \text{ MHz}$ ;  $\sigma = 0.972 \text{ mho/m}$ ;  $\epsilon_r =$

$56.486$ ;  $\rho = 1000 \text{ kg/m}^3$

Ambient Temperature :  $23.5 \text{ }^\circ\text{C}$  ; Liquid Temperature :  $21.5 \text{ }^\circ\text{C}$

DASY5 Configuration:

- Probe: EX3DV4 - SN3819; ConvF(9.5, 9.5, 9.5); Calibrated: 26.11.2012;
- Sensor-Surface: 2mm (Mechanical Surface Detection)
- Electronics: DAE4 Sn1303; Calibrated: 22.11.2012
- Phantom: SAM2; Type: QD000P40CD; Serial: TP:1671
- Measurement SW: DASY52, Version 52.8 (2); SEMCAD X Version 14.6.6 (6824)

**Ch4182/Area Scan (51x81x1):** Interpolated grid:  $dx=15\text{mm}$ ,  $dy=15\text{mm}$

Maximum value of SAR (interpolated) =  $0.530 \text{ W/kg}$

**Ch4182/Zoom Scan (5x5x7)/Cube 0:** Measurement grid:  $dx=8\text{mm}$ ,  $dy=8\text{mm}$ ,  $dz=5\text{mm}$

Reference Value =  $23.377 \text{ V/m}$ ; Power Drift =  $-0.10 \text{ dB}$

Peak SAR (extrapolated) =  $0.558 \text{ mW/g}$

**SAR(1 g) =  $0.433 \text{ mW/g}$ ; SAR(10 g) =  $0.318 \text{ mW/g}$**

Maximum value of SAR (measured) =  $0.504 \text{ W/kg}$

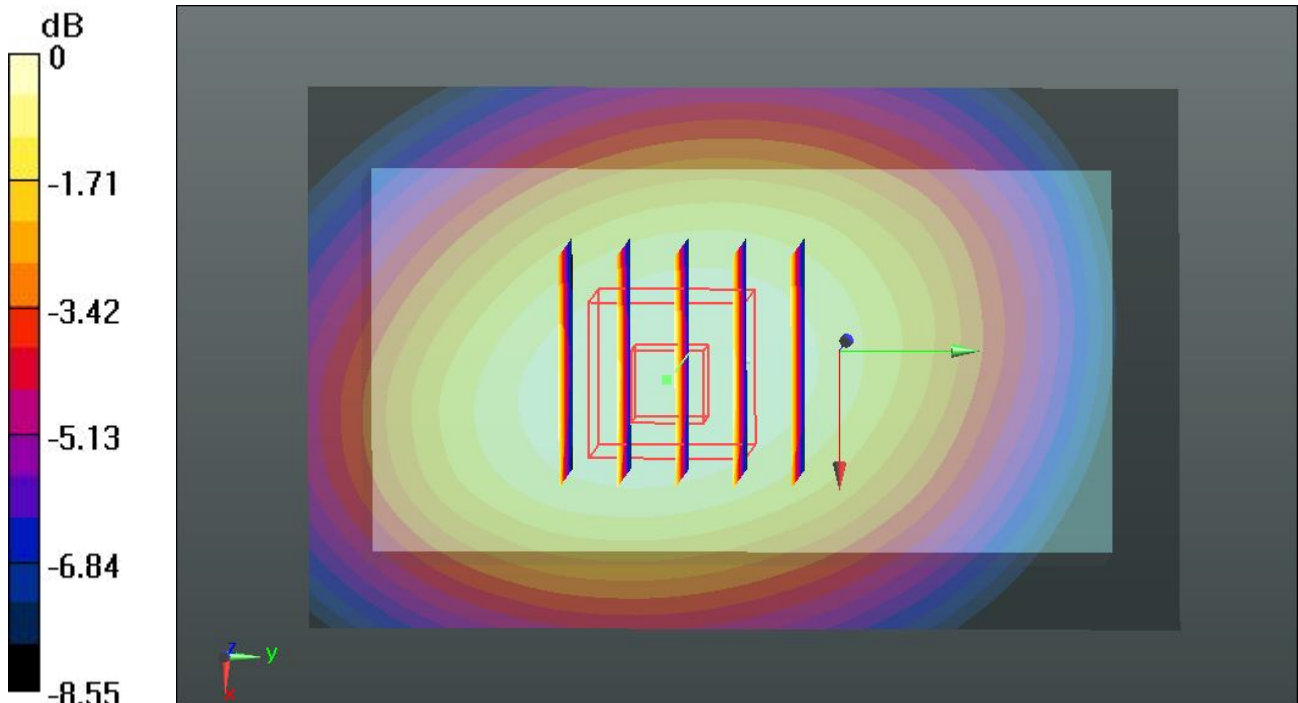

0 dB =  $0.504 \text{ W/kg}$



### 02 WCDMA Band V\_RMC 12.2K\_Back\_1.5cm\_Ch4182

**DUT: 222402-01**

Communication System: UMTS; Frequency: 836.4 MHz; Duty Cycle: 1:1  
Medium: MSL\_835\_130129 Medium parameters used:  $f = 836.4 \text{ MHz}$ ;  $\sigma = 0.972 \text{ mho/m}$ ;  $\epsilon_r = 56.486$ ;  $\rho = 1000 \text{ kg/m}^3$   
Ambient Temperature :  $23.5 \text{ }^\circ\text{C}$  ; Liquid Temperature :  $21.5 \text{ }^\circ\text{C}$

DASY5 Configuration:

- Probe: EX3DV4 - SN3819; ConvF(9.5, 9.5, 9.5); Calibrated: 26.11.2012;
- Sensor-Surface: 2mm (Mechanical Surface Detection)
- Electronics: DAE4 Sn1303; Calibrated: 22.11.2012
- Phantom: SAM2; Type: QD000P40CD; Serial: TP:1671
- Measurement SW: DASY52, Version 52.8 (2); SEMCAD X Version 14.6.6 (6824)

**Ch4182/Area Scan (51x81x1):** Interpolated grid:  $dx=15\text{mm}$ ,  $dy=15\text{mm}$   
Maximum value of SAR (interpolated) =  $1.20 \text{ W/kg}$

**Ch4182/Zoom Scan (5x5x7)/Cube 0:** Measurement grid:  $dx=8\text{mm}$ ,  $dy=8\text{mm}$ ,  $dz=5\text{mm}$   
Reference Value =  $36.180 \text{ V/m}$ ; Power Drift =  $-0.04 \text{ dB}$   
Peak SAR (extrapolated) =  $1.357 \text{ mW/g}$   
**SAR(1 g) =  $1.03 \text{ mW/g}$ ; SAR(10 g) =  $0.742 \text{ mW/g}$**   
Maximum value of SAR (measured) =  $1.21 \text{ W/kg}$

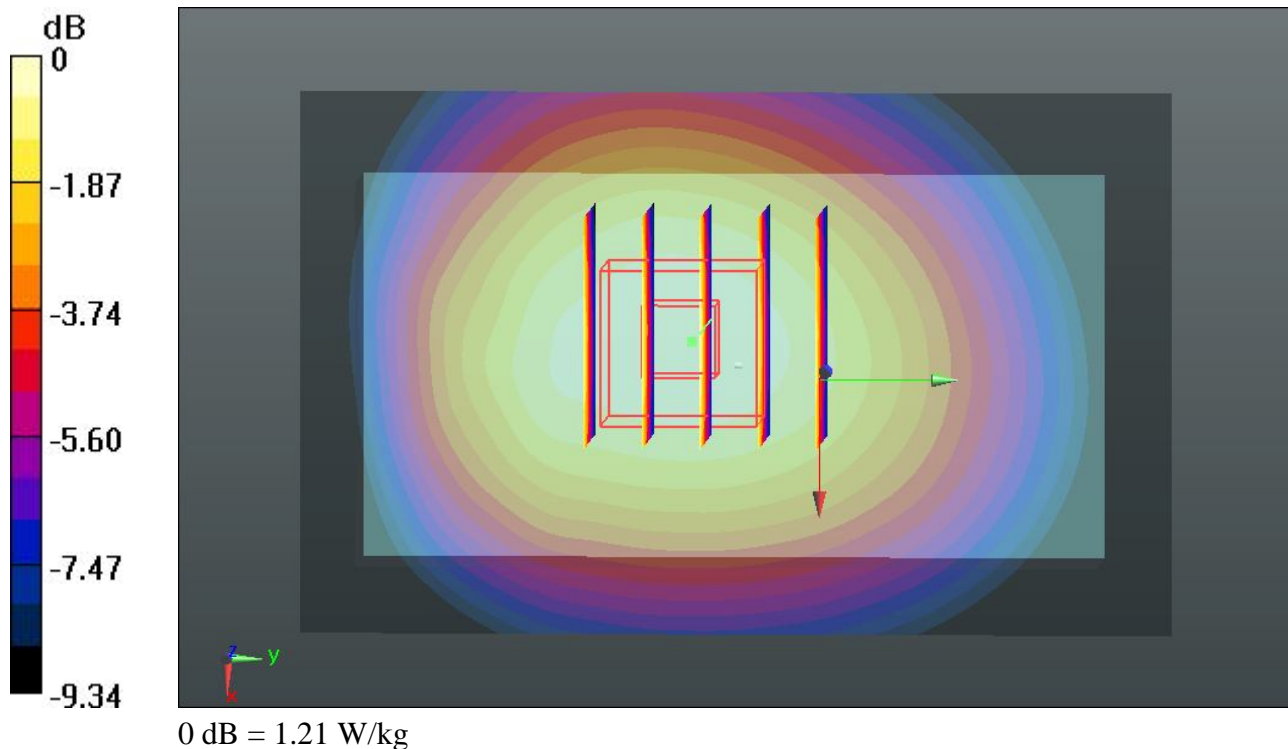

**03 WCDMA Band V\_RMC 12.2K\_Back\_1.5cm\_Ch4132**

**DUT: 222402-01**

Communication System: UMTS; Frequency: 826.4 MHz; Duty Cycle: 1:1

Medium: MSL\_835\_130129 Medium parameters used:  $f = 826.4 \text{ MHz}$ ;  $\sigma = 0.962 \text{ mho/m}$ ;  $\epsilon_r = 56.57$ ;

$\rho = 1000 \text{ kg/m}^3$

Ambient Temperature :  $23.5 \text{ }^\circ\text{C}$  ; Liquid Temperature :  $21.5 \text{ }^\circ\text{C}$

DASY5 Configuration:

- Probe: EX3DV4 - SN3819; ConvF(9.5, 9.5, 9.5); Calibrated: 26.11.2012;
- Sensor-Surface: 2mm (Mechanical Surface Detection)
- Electronics: DAE4 Sn1303; Calibrated: 22.11.2012
- Phantom: SAM2; Type: QD000P40CD; Serial: TP:1671
- Measurement SW: DASY52, Version 52.8 (2); SEMCAD X Version 14.6.6 (6824)

**Ch4132/Area Scan (51x81x1):** Interpolated grid:  $dx=15\text{mm}$ ,  $dy=15\text{mm}$

Maximum value of SAR (interpolated) =  $1.02 \text{ W/kg}$

**Ch4132/Zoom Scan (5x5x7)/Cube 0:** Measurement grid:  $dx=8\text{mm}$ ,  $dy=8\text{mm}$ ,  $dz=5\text{mm}$

Reference Value =  $33.523 \text{ V/m}$ ; Power Drift =  $-0.01 \text{ dB}$

Peak SAR (extrapolated) =  $1.152 \text{ mW/g}$

**SAR(1 g) =  $0.874 \text{ mW/g}$ ; SAR(10 g) =  $0.633 \text{ mW/g}$**

Maximum value of SAR (measured) =  $1.03 \text{ W/kg}$

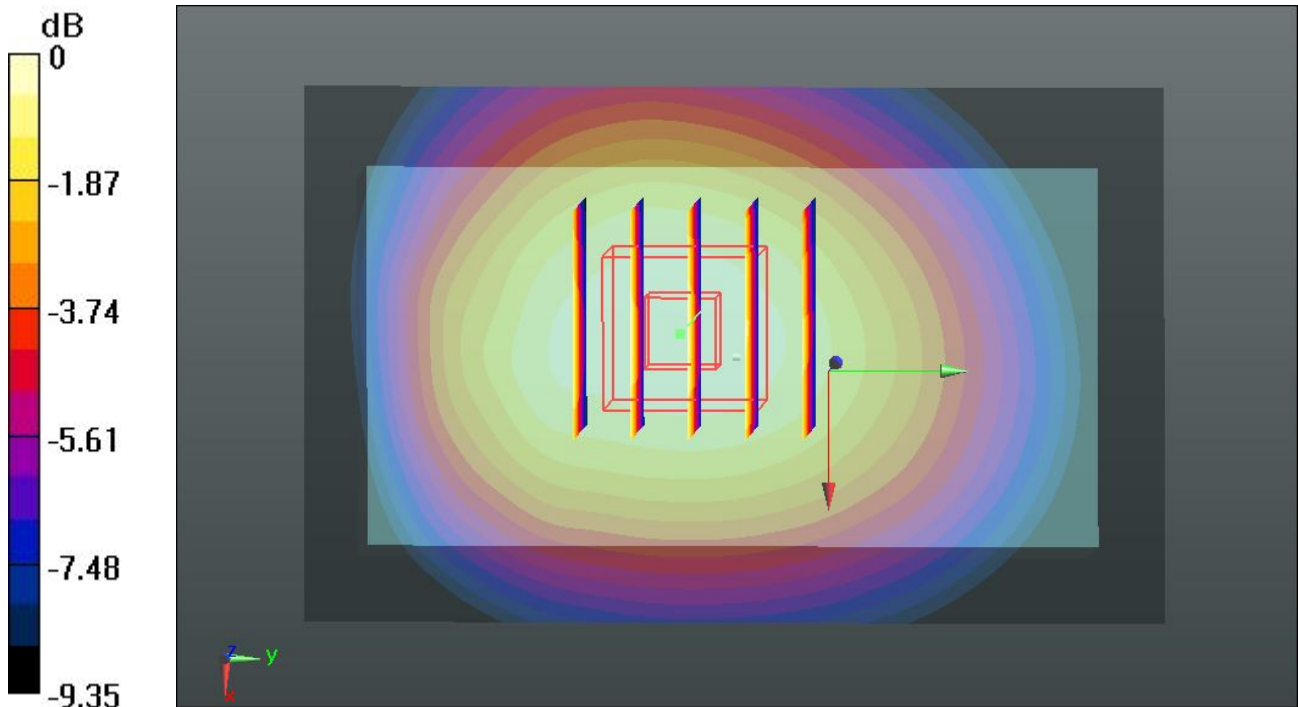

0 dB =  $1.03 \text{ W/kg}$



**04 WCDMA Band V\_RMC 12.2K\_Back\_1.5cm\_Ch4233**

**DUT: 222402-01**

Communication System: UMTS; Frequency: 846.6 MHz; Duty Cycle: 1:1

Medium: MSL\_835\_130129 Medium parameters used:  $f = 847$  MHz;  $\sigma = 0.981$  mho/m;  $\epsilon_r = 56.389$ ;

$\rho = 1000$  kg/m<sup>3</sup>

Ambient Temperature : 23.5 °C ; Liquid Temperature : 21.5 °C

DASY5 Configuration:

- Probe: EX3DV4 - SN3819; ConvF(9.5, 9.5, 9.5); Calibrated: 26.11.2012;
- Sensor-Surface: 2mm (Mechanical Surface Detection)
- Electronics: DAE4 Sn1303; Calibrated: 22.11.2012
- Phantom: SAM2; Type: QD000P40CD; Serial: TP:1671
- Measurement SW: DASY52, Version 52.8 (2); SEMCAD X Version 14.6.6 (6824)

**Ch4233/Area Scan (51x81x1):** Interpolated grid: dx=15mm, dy=15mm

Maximum value of SAR (interpolated) = 1.31 W/kg

**Ch4233/Zoom Scan (5x5x7)/Cube 0:** Measurement grid: dx=8mm, dy=8mm, dz=5mm

Reference Value = 37.560 V/m; Power Drift = 0.01 dB

Peak SAR (extrapolated) = 1.482 mW/g

**SAR(1 g) = 1.12 mW/g; SAR(10 g) = 0.803 mW/g**

Maximum value of SAR (measured) = 1.32 W/kg

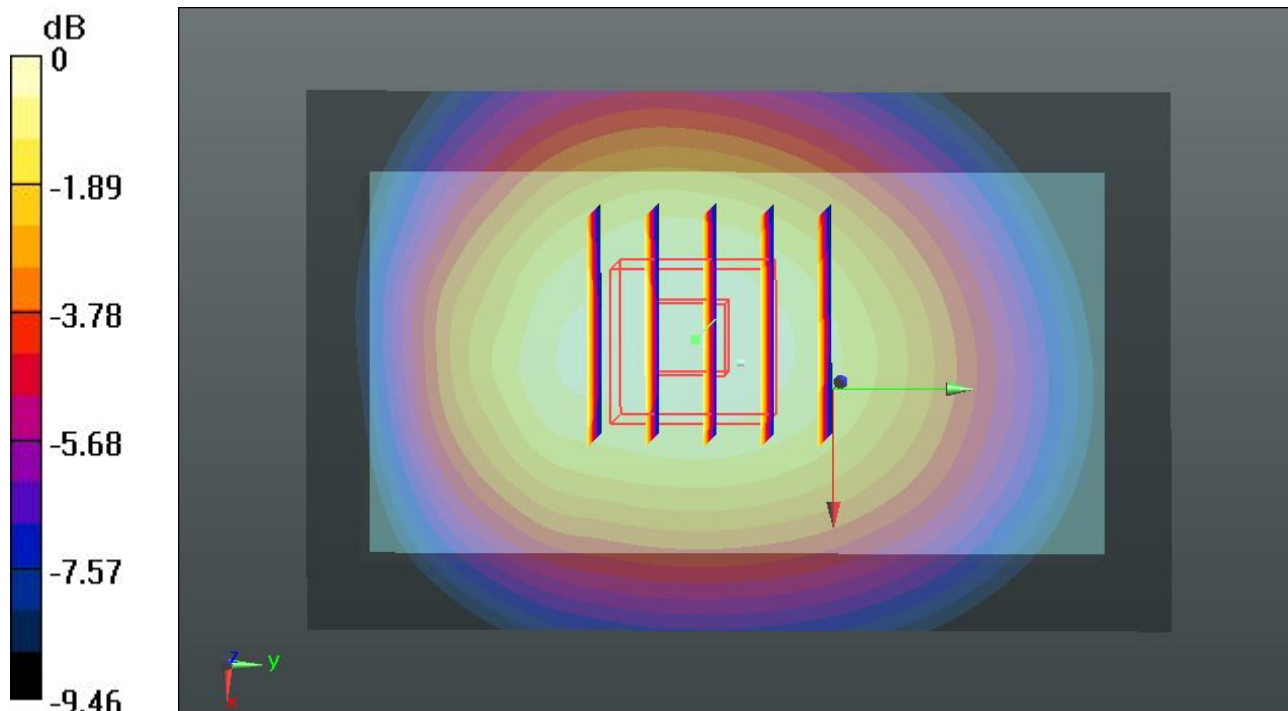

0 dB = 1.32 W/kg

**08 WCDMA Band V\_RMC 12.2K\_Back\_1.5cm\_Ch4233\_Repeat SAR**

**DUT: 222402-01**

Communication System: UMTS; Frequency: 846.6 MHz; Duty Cycle: 1:1

Medium: MSL\_835\_130129 Medium parameters used:  $f = 847 \text{ MHz}$ ;  $\sigma = 0.981 \text{ mho/m}$ ;  $\epsilon_r = 56.389$ ;

$\rho = 1000 \text{ kg/m}^3$

Ambient Temperature :  $23.5 \text{ }^\circ\text{C}$  ; Liquid Temperature :  $21.5 \text{ }^\circ\text{C}$

DASY5 Configuration:

- Probe: EX3DV4 - SN3819; ConvF(9.5, 9.5, 9.5); Calibrated: 26.11.2012;
- Sensor-Surface: 2mm (Mechanical Surface Detection)
- Electronics: DAE4 Sn1303; Calibrated: 22.11.2012
- Phantom: SAM2; Type: QD000P40CD; Serial: TP:1671
- Measurement SW: DASY52, Version 52.8 (2); SEMCAD X Version 14.6.6 (6824)

**Ch4233/Area Scan (51x81x1):** Interpolated grid:  $dx=15\text{mm}$ ,  $dy=15\text{mm}$

Maximum value of SAR (interpolated) =  $1.20 \text{ W/kg}$

**Ch4233/Zoom Scan (5x5x7)/Cube 0:** Measurement grid:  $dx=8\text{mm}$ ,  $dy=8\text{mm}$ ,  $dz=5\text{mm}$

Reference Value =  $35.103 \text{ V/m}$ ; Power Drift =  $0.05 \text{ dB}$

Peak SAR (extrapolated) =  $1.309 \text{ mW/g}$

**SAR(1 g) =  $0.987 \text{ mW/g}$ ; SAR(10 g) =  $0.712 \text{ mW/g}$**

Maximum value of SAR (measured) =  $1.17 \text{ W/kg}$

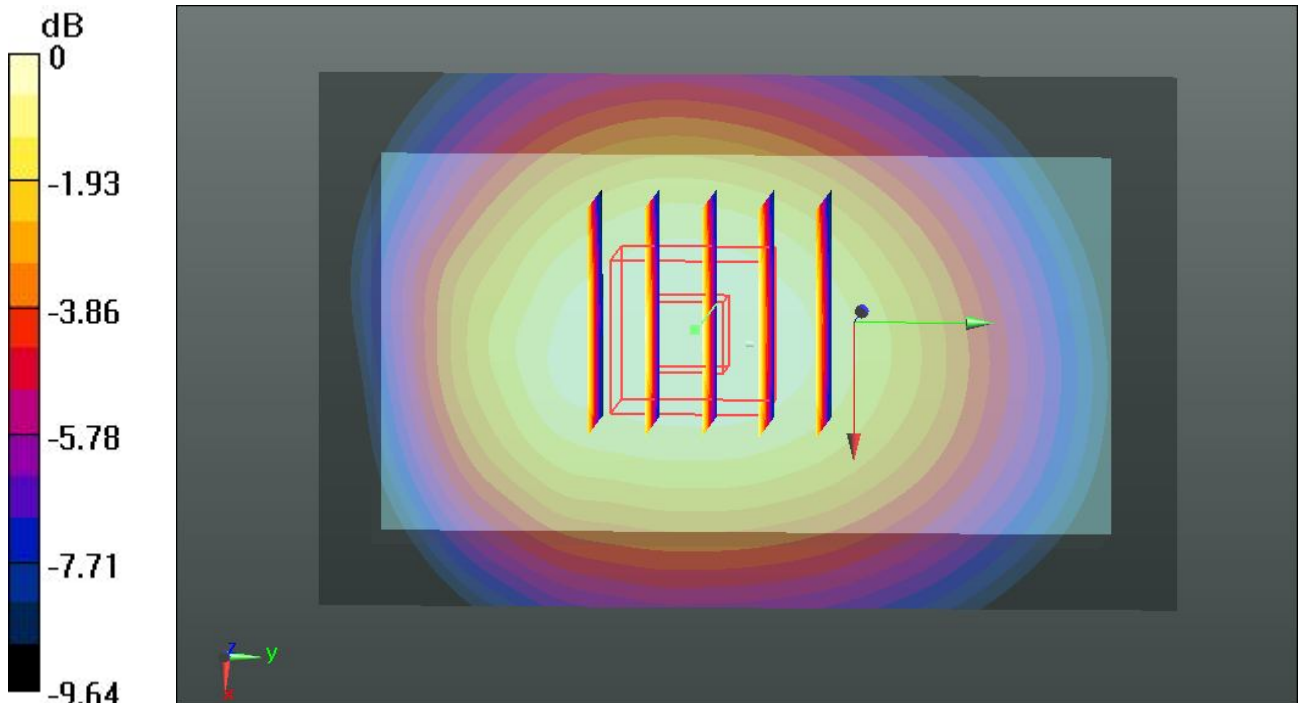

0 dB =  $1.17 \text{ W/kg}$

**05 WCDMA Band V\_RMC 12.2K\_Back\_1.5cm\_Ch4233\_Headset**

**DUT: 222402-01**

Communication System: UMTS; Frequency: 846.6 MHz; Duty Cycle: 1:1

Medium: MSL\_835\_130129 Medium parameters used:  $f = 847 \text{ MHz}$ ;  $\sigma = 0.981 \text{ mho/m}$ ;  $\epsilon_r = 56.389$ ;

$\rho = 1000 \text{ kg/m}^3$

Ambient Temperature :  $23.5 \text{ }^\circ\text{C}$  ; Liquid Temperature :  $21.5 \text{ }^\circ\text{C}$

DASY5 Configuration:

- Probe: EX3DV4 - SN3819; ConvF(9.5, 9.5, 9.5); Calibrated: 26.11.2012;
- Sensor-Surface: 2mm (Mechanical Surface Detection)
- Electronics: DAE4 Sn1303; Calibrated: 22.11.2012
- Phantom: SAM2; Type: QD000P40CD; Serial: TP:1671
- Measurement SW: DASY52, Version 52.8 (2); SEMCAD X Version 14.6.6 (6824)

**Ch4233/Area Scan (51x81x1):** Interpolated grid:  $dx=15\text{mm}$ ,  $dy=15\text{mm}$

Maximum value of SAR (interpolated) =  $1.21 \text{ W/kg}$

**Ch4233/Zoom Scan (5x5x7)/Cube 0:** Measurement grid:  $dx=8\text{mm}$ ,  $dy=8\text{mm}$ ,  $dz=5\text{mm}$

Reference Value =  $35.291 \text{ V/m}$ ; Power Drift =  $-0.02 \text{ dB}$

Peak SAR (extrapolated) =  $1.296 \text{ mW/g}$

**SAR(1 g) =  $0.980 \text{ mW/g}$ ; SAR(10 g) =  $0.709 \text{ mW/g}$**

Maximum value of SAR (measured) =  $1.16 \text{ W/kg}$

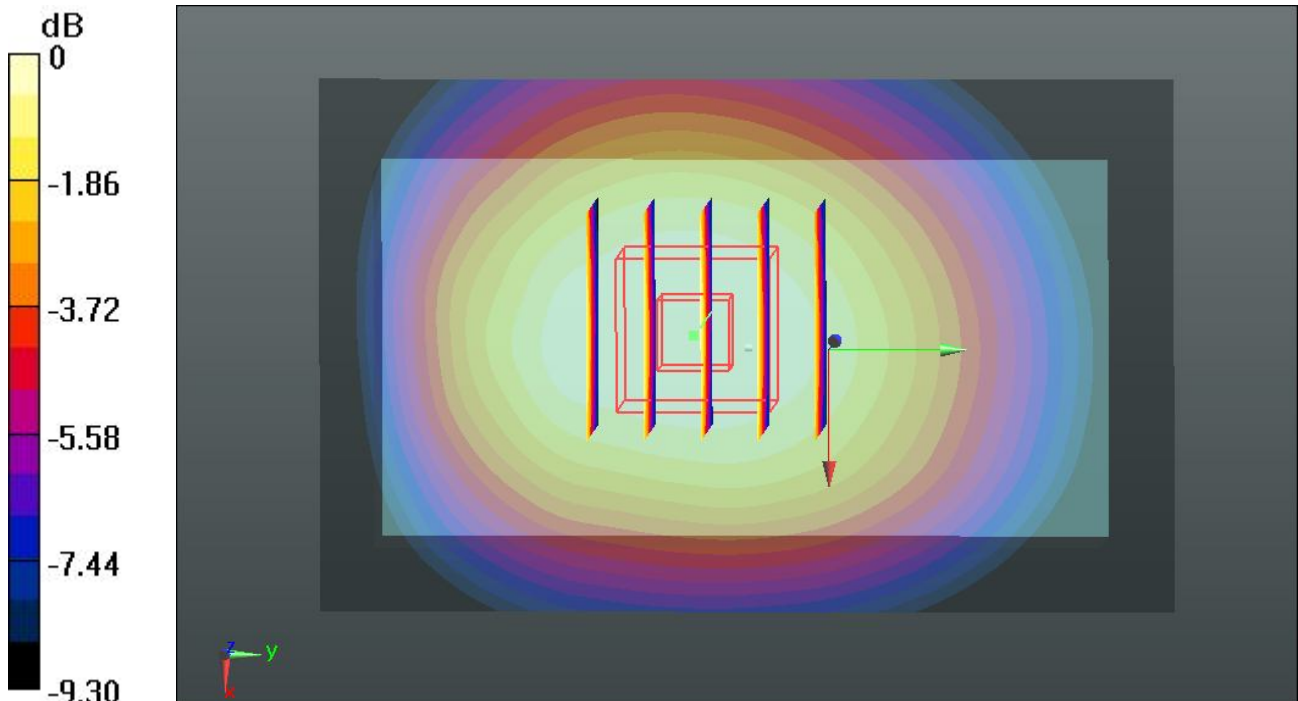

0 dB =  $1.16 \text{ W/kg}$

### 06 WCDMA Band V\_RMC 12.2K\_Back\_1.5cm\_Ch4132\_Headset

**DUT: 222402-01**

Communication System: UMTS; Frequency: 826.4 MHz; Duty Cycle: 1:1

Medium: MSL\_835\_130129 Medium parameters used:  $f = 826.4$  MHz;  $\sigma = 0.962$  mho/m;  $\epsilon_r = 56.57$ ;

$\rho = 1000$  kg/m<sup>3</sup>

Ambient Temperature : 23.5 °C ; Liquid Temperature : 21.5 °C

DASY5 Configuration:

- Probe: EX3DV4 - SN3819; ConvF(9.5, 9.5, 9.5); Calibrated: 26.11.2012;
- Sensor-Surface: 2mm (Mechanical Surface Detection)
- Electronics: DAE4 Sn1303; Calibrated: 22.11.2012
- Phantom: SAM2; Type: QD000P40CD; Serial: TP:1671
- Measurement SW: DASY52, Version 52.8 (2); SEMCAD X Version 14.6.6 (6824)

**Ch4132/Area Scan (51x81x1):** Interpolated grid: dx=15mm, dy=15mm

Maximum value of SAR (interpolated) = 0.863 W/kg

**Ch4132/Zoom Scan (5x5x7)/Cube 0:** Measurement grid: dx=8mm, dy=8mm, dz=5mm

Reference Value = 30.807 V/m; Power Drift = -0.01 dB

Peak SAR (extrapolated) = 0.970 mW/g

**SAR(1 g) = 0.738 mW/g; SAR(10 g) = 0.537 mW/g**

Maximum value of SAR (measured) = 0.868 W/kg

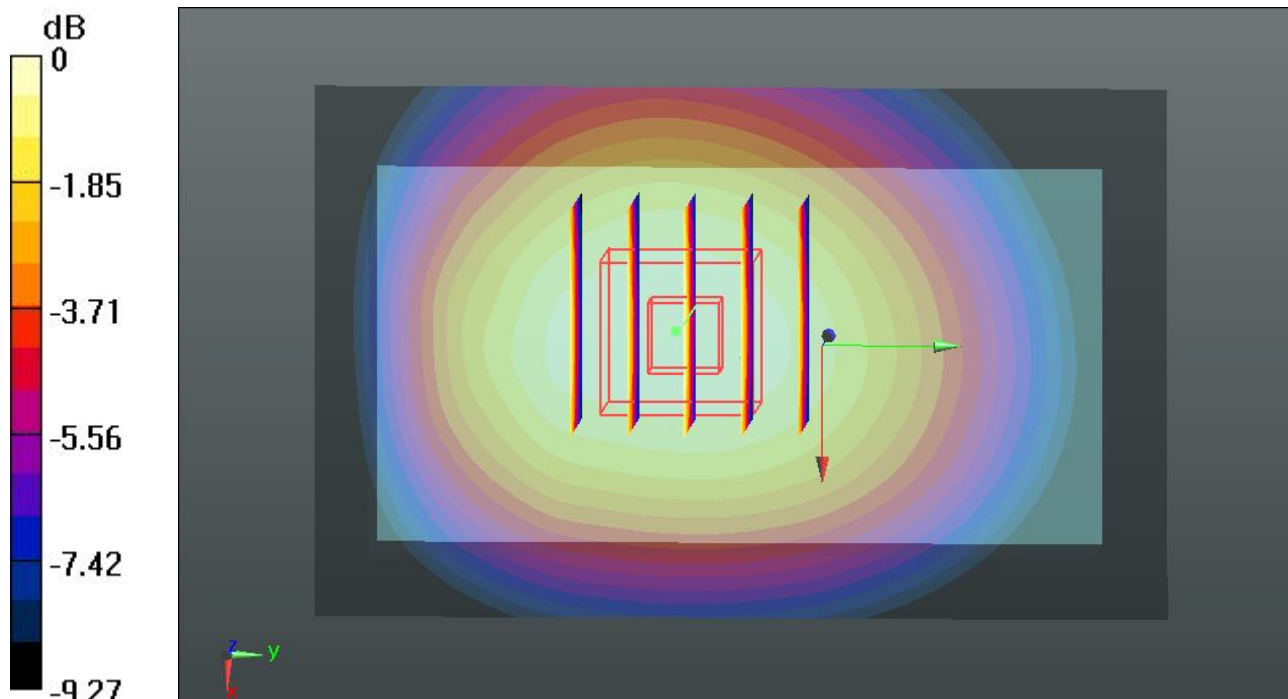

0 dB = 0.868 W/kg

**07 WCDMA Band V\_RMC 12.2K\_Back\_1.5cm\_Ch4182\_Headset**

**DUT: 222402-01**

Communication System: UMTS; Frequency: 836.4 MHz; Duty Cycle: 1:1

Medium: MSL\_835\_130129 Medium parameters used:  $f = 836.4 \text{ MHz}$ ;  $\sigma = 0.972 \text{ mho/m}$ ;  $\epsilon_r =$

$56.486$ ;  $\rho = 1000 \text{ kg/m}^3$

Ambient Temperature :  $23.5 \text{ }^\circ\text{C}$  ; Liquid Temperature :  $21.5 \text{ }^\circ\text{C}$

DASY5 Configuration:

- Probe: EX3DV4 - SN3819; ConvF(9.5, 9.5, 9.5); Calibrated: 26.11.2012;
- Sensor-Surface: 2mm (Mechanical Surface Detection)
- Electronics: DAE4 Sn1303; Calibrated: 22.11.2012
- Phantom: SAM2; Type: QD000P40CD; Serial: TP:1671
- Measurement SW: DASY52, Version 52.8 (2); SEMCAD X Version 14.6.6 (6824)

**Ch4182/Area Scan (51x81x1):** Interpolated grid:  $dx=15\text{mm}$ ,  $dy=15\text{mm}$

Maximum value of SAR (interpolated) =  $0.997 \text{ W/kg}$

**Ch4182/Zoom Scan (5x5x7)/Cube 0:** Measurement grid:  $dx=8\text{mm}$ ,  $dy=8\text{mm}$ ,  $dz=5\text{mm}$

Reference Value =  $32.964 \text{ V/m}$ ; Power Drift =  $0.01 \text{ dB}$

Peak SAR (extrapolated) =  $1.124 \text{ mW/g}$

**SAR(1 g) =  $0.853 \text{ mW/g}$ ; SAR(10 g) =  $0.619 \text{ mW/g}$**

Maximum value of SAR (measured) =  $1.01 \text{ W/kg}$

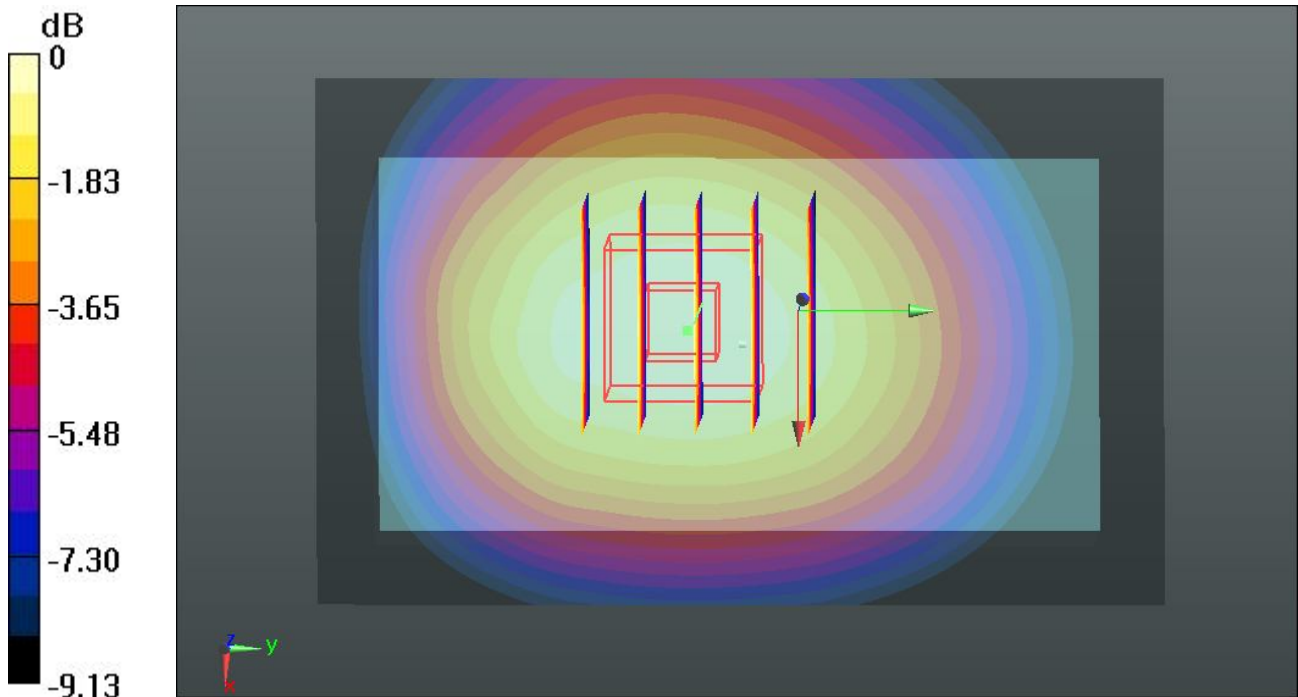

0 dB =  $1.01 \text{ W/kg}$