



Hearing Aid Compatibility (HAC) RF Emissions Test Report

APPLICANT : Doro AB
EQUIPMENT : Mobile Telephone
BRAND NAME : Doro
MODEL NAME : Doro PhoneEasy 520X
FCC ID : WS5DORO520X
STANDARD : FCC 47 CFR §20.19
ANSI C63.19-2007
M CATEGORY : M3

The product was completely tested on Mar. 02, 2013. We, SPORTON INTERNATIONAL (SHENZHEN) INC., would like to declare that the tested sample has been evaluated in accordance with the procedures and shown the compliance with the applicable technical standards.

The test results in this report apply exclusively to the tested model / sample. Without written approval of SPORTON INTERNATIONAL (SHENZHEN) INC., the test report shall not be reproduced except in full.

Reviewed by:

Jones Tsai / Manager



SPORTON INTERNATIONAL (SHENZHEN) INC.

No. 101, Complex Building C, Guanglong Village, Xili Town, Nanshan District, Shenzhen, Guangdong, P.R.C.



Table of Contents

Revision History.....3
1. Statement of Compliance.....4
2. Administration Data.....5
2.1 Testing Laboratory.....5
2.2 Applicant.....5
2.3 Manufacturer.....5
2.4 Application Details.....5
3. General Information.....6
3.1 Description of Device Under Test (DUT).....6
3.2 Product Photos.....7
3.3 Applied Standards.....7
3.4 Test Conditions.....8
3.4.1 Ambient Condition.....8
3.4.2 Test Configuration.....8
4. Hearing Aid Compliance (HAC).....9
4.1 Introduction.....9
5. HAC RF Emission Measurement Setup.....10
5.1 E-Field and H-Field Probe System.....11
5.1.1 E-Field Probe Specification.....11
5.1.2 H-Field Probe Description.....11
5.1.3 Probe Tip Description.....12
5.2 DATA Acquisition Electronics (DAE).....13
5.3 Robot.....14
5.4 Measurement Server.....14
5.5 Phone Positioner.....15
5.6 Test Arch Phantom.....15
5.7 Data Storage and Evaluation.....16
5.7.1 Data Storage.....16
5.7.2 Data Evaluation.....16
5.8 Test Equipment List.....18
6. Uncertainty Assessment.....19
7. HAC RF Emission Measurement Evaluation.....21
7.1 Purpose of System Performance Check.....21
7.2 System Setup.....21
7.3 Validation Results.....22
8. RF Field Probe Modulation Factor.....23
9. Description for DUT Testing Position.....27
10. RF Emissions Test Procedure.....29
11. HAC RF Emission Test Results.....30
11.1 Conducted Power (Unit: dBm).....30
11.2 E-Field Emission.....31
11.3 H-Field Emission.....31
12. References.....32
Appendix A. Plots of System Performance Check
Appendix B. Plots of RF Emission Measurement
Appendix C. DASy Calibration Certificate
Appendix D. Product Photos
Appendix E. Test Setup Photos



1. Statement of Compliance

The maximum results of RF Emission of Hearing Aid Compliance (HAC) found during testing for the **Doro AB DUT: Mobile Telephone, Brand Name: Doro, Model Name: Doro PhoneEasy 520X** are follows (with expanded uncertainty $\pm 30.4\%$ for E-field and $\pm 21.6\%$ for H-field):

Band	HAC RF Emission Test Result		M Rating
GSM850	E-Field (V/m)	235.8	M3
	H-Field (A/m)	0.479	M3
GSM1900	E-Field (V/m)	77.241	M3
	H-Field (A/m)	0.207	M3
WCDMA Band V	E-Field (V/m)	90.319	M4
	H-Field (A/m)	0.152	M4
WCDMA Band II	E-Field (V/m)	32.867	M4
	H-Field (A/m)	0.076	M4

They are in compliance with HAC limits (HAC Rated category M3) specified in guidelines FCC 47 CFR §20.19 and ANSI Standard ANSI C63.19.

Results Summary : M Category = M3 (ANSI C63.19-2007)



2. Administration Data

2.1 Testing Laboratory

Test Site	SPORTON INTERNATIONAL (SHENZHEN) INC.
Test Site Location	No. 101, Complex Building C, Guanglong Village, Xili Town, Nanshan District, Shenzhen, Guangdong, P.R.C. TEL: +86-755-8637-9589 FAX: +86-755-8637-9595
Test Site No.	Sporton Site No. : SAR01-SZ

2.2 Applicant

Company Name	Doro AB
Address	Magistratsvägen 10 SE-226 43 Lund Sweden

2.3 Manufacturer

Company Name	CK TELECOM LTD.
Address	Technology Road, High-Tech Development Zone, Heyuan, Guangdong, P.R.China.

2.4 Application Details

Date of Start during the Test	Mar. 02, 2013
Date of End during the Test	Mar. 02, 2013

3. General Information

3.1 Description of Device Under Test (DUT)

Product Feature & Specification	
DUT Type	Mobile Telephone
Brand Name	Doro
Model Name	Doro PhoneEasy 520X
FCC ID	WS5DORO520X
IMEI Code	355560050002660
Tx Frequency	GSM850 : 824.2 MHz ~ 848.8 MHz GSM1900 : 1850.2 MHz ~ 1909.8 MHz WCDMA Band V : 826.4 MHz ~ 846.6 MHz WCDMA Band II : 1852.4 MHz ~ 1907.6 MHz
Rx Frequency	GSM850 : 869.2 MHz ~ 893.8 MHz GSM1900 : 1930.2 MHz ~ 1989.8 MHz WCDMA Band V : 871.4 MHz ~ 891.6 MHz WCDMA Band II : 1932.4 MHz ~ 1987.6 MHz
Maximum Output Power to Antenna	GSM850 : 32.33 dBm GSM1900 : 30.66 dBm WCDMA Band V : 23.02 dBm WCDMA Band II : 21.86 dBm
Antenna Type	Fixed Internal Antenna
HW Version	CANDY-V2.0
SW Version	CANDY-S04A_DORO520X_L17EN_107_130306
Type of Modulation	GSM : GMSK GPRS : GMSK EDGE : GMSK / 8PSK (Downlink only) WCDMA : QPSK (Uplink) HSDPA : QPSK (Uplink) HSUPA: QPSK (Uplink)
DUT Stage	Identical Prototype

List of air interfaces / frequency bands:

Air Interface	Band (MHz)	Voice/Data	C63.19-2007 Tested	Concurrent connections	Reduced power 20.19 (c)(1)
GSM	850,1900	Voice	Yes	BT	No
WCDMA	Band V, Band II	Voice	Yes	BT	No
BT	2450	Data(*)	No	GSM, WCDMA	No

Note:

- (*): The voice function maybe be activated via 3rd party software application.
- Per KDB 285076 D01 7(a), during RF test, concurrent transmission is disabled.



3.2 Product Photos

Refer to Appendix D.

3.3 Applied Standards

The ANSI Standard ANSI C63.19-2007 represents performance requirements for acceptable interoperability of hearing aids with wireless communications devices. When these parameters are met, a hearing aid operates acceptably in close proximity to a wireless communications device.

The following AWF factors shall be used for the standard transmission protocols:

Standard	Technology	AWF (dB)
TIA/EIA/IS-2000	CDMA	0
TIA/EIA-136	TDMA (50 Hz)	0
J-STD-007	GSM (217)	-5
T1/T1P1/3GPP	UMTS (WCDMA)	0
iDENTM	TDMA (22 and 11 Hz)	0

Table 3.1 Articulation Weighting Factor (AWF)

Category	Telephone RF Parameters			
	Near Field	AWF	E-Field Emissions	H-Field Emissions
< 960 MHz				
Category M1	0		631.0 – 1122.0 V/m	1.91 – 3.39 A/m
	-5		473.2 – 841.4 V/m	1.43 – 2.54 A/m
Category M2	0		354.8 – 631.0 V/m	1.07 – 1.91 A/m
	-5		266.1 – 473.2 V/m	0.80 – 1.43 A/m
Category M3	0		199.5 – 354.8 V/m	0.6 – 1.07 A/m
	-5		149.6 – 266.1 V/m	0.45 – 0.80 A/m
Category M4	0		< 199.5 V/m	< 0.60 A/m
	-5		< 149.6 V/m	< 0.45 A/m
> 960 MHz				
Category M1	0		199.5 – 354.8 V/m	0.60 – 1.07 A/m
	-5		149.6 – 266.1 V/m	0.45 – 0.80 A/m
Category M2	0		112.2 – 199.5 V/m	0.34 – 0.60 A/m
	-5		84.1 – 149.6 V/m	0.25 – 0.45 A/m
Category M3	0		63.1 – 112.2 V/m	0.19 – 0.34 A/m
	-5		47.3 – 84.1 V/m	0.14 – 0.25 A/m
Category M4	0		< 63.1 V/m	< 0.19 A/m
	-5		< 47.3 V/m	< 0.14 A/m

Table 3.2 Telephone near-field categories in linear units



3.4 Test Conditions

3.4.1 Ambient Condition

Ambient Temperature	20 to 24 °C
Humidity	< 60 %

3.4.2 Test Configuration

The device was controlled by using a base station emulator R&S CMU200. Communication between the device and the emulator was established by air link. Measurements were performed on the low, middle and high channels of all bands. The DUT was set from the emulator to radiate maximum output power during all tests.



4. Hearing Aid Compliance (HAC)

4.1 Introduction

The federal communication commission (FCC) adopted ANSI C63.19 as HAC test standard.

5. HAC RF Emission Measurement Setup

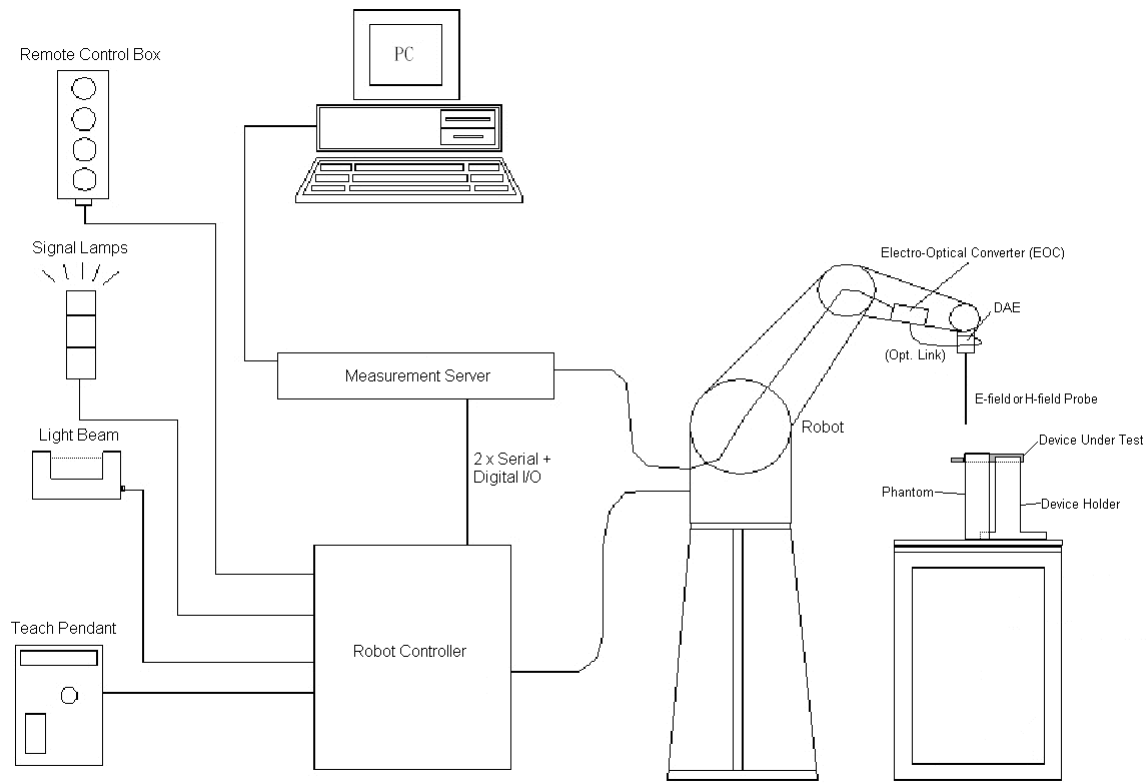

Fig 5.1 SPEAG DASY4 or DASY5 System Configurations

The DASY4 or DASY5 system for performance compliance tests is illustrated above graphically. This system consists of the following items:

- A standard high precision 6-axis robot with controller, a teach pendant and software
- A data acquisition electronic (DAE) attached to the robot arm extension
- A dosimetric probe equipped with an optical surface detector system
- The electro-optical converter (EOC) performs the conversion between optical and electrical signals
- A measurement server performs the time critical tasks such as signal filtering, control of the robot operation and fast movement interrupts.
- A probe alignment unit which improves the accuracy of the probe positioning
- A computer operating Windows XP
- DASY4 or DASY5 software
- Remote control with teach pendant and additional circuitry for robot safety such as warning lamps, etc.
- A device holder
- Dipole for evaluating the proper functioning of the system
- Test Arch Phantom

Detail component information are described in the following sub-clauses.

5.1 E-Field and H-Field Probe System

The HAC measurement is conducted with the dosimetric probe ER3DV6 and H3DV6 (manufactured by SPEAG). The probe is specially designed and calibrated. This probe has a built in optical surface detection system to prevent from collision with DUT.

5.1.1 E-Field Probe Specification

<ER3DV6>

Construction	One dipole parallel, two dipoles normal to probe axis Built-in shielding against static charges
Calibration	In air from 100 MHz to 3.0 GHz (absolute accuracy $\pm 6.0\%$, $k=2$)
Frequency	100 MHz to 6 GHz; Linearity: ± 2.0 dB (100 MHz to 3 GHz)
Directivity	± 0.2 dB in air (rotation around probe axis) ± 0.4 dB in air (rotation normal to probe axis)
Dynamic Range	2 V/m to 1000 V/m (M3 or better device readings fall well below diode compression point)
Linearity	± 0.2 dB
Dimensions	Overall length: 330 mm (Tip: 16 mm) Tip diameter: 8 mm (Body: 12 mm) Distance from probe tip to dipole centers: 2.5 mm



Fig 5.2 Photo of E-field Probe

5.1.2 H-Field Probe Description

<H3DV6>

Construction	Three concentric loop sensors with 3.8 mm loop diameters Resistively loaded detector diodes for linear response Built-in shielding against static charges
Frequency	200 MHz to 3 GHz (absolute accuracy $\pm 6.0\%$, $k=2$); Output linearized
Directivity	± 0.25 dB (spherical isotropy error)
Dynamic Range	10 m A/m to 2 A/m at 1 GHz (M3 or better device readings fall well below diode compression point)
Dimensions	Overall length: 330 mm (Tip: 40 mm) Tip diameter: 6 mm (Body: 12 mm) Distance from probe tip to dipole centers: 3 mm
E-Field Interference	$< 10\%$ at 3 GHz (for plane wave)



Fig 5.3 Photo of H-field Probe

5.1.3 Probe Tip Description

HAC field measurements take place in the close near field with high gradients. Increasing the measuring distance from the source will generally decrease the measured field values (in case of the validation dipole approx. 10% per mm).

Magnetic field sensors are measuring the integral of the H-field across their sensor area surrounded by the loop. They are calibrated in a precise, homogeneous field. When measuring a gradient field, the result will be very close to the field in the center of the loop which is equivalent to the value of a homogeneous field equivalent to the center value. But it will be different from the field at the field at the border of the loop.

Consequently, two sensors with different loop diameters – both calibrated ideally – would give different results when measuring from the edge of the probe sensor elements. The behavior for electrically small E-field sensors is equivalent. See below for distance plots from a WD which show the conservative nature of field readings at the probe element center vs. measurements at the sensor end:

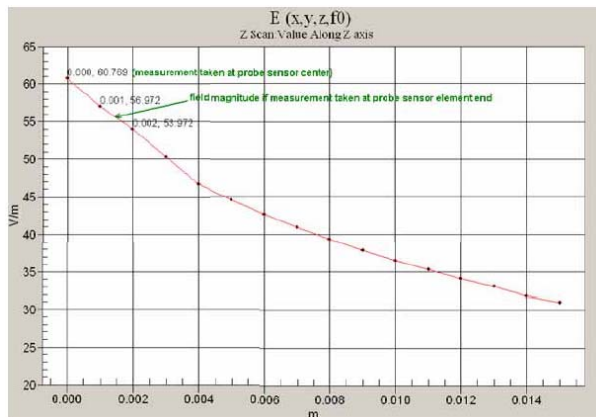

Fig 5.4 Z-Axis Scan at maximum point above a typical wireless device for E-field

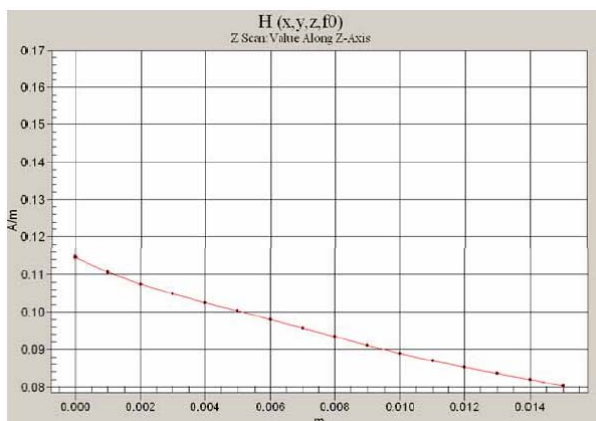

Fig 5.5 Z-Axis Scan at maximum point above a typical wireless device for H-field

The magnetic field loops of the H3D probes are concentric, with the center 3mm from the tip for H3DV6. Their radius is 1.9 mm.

The electric field probes have a more irregular internal geometry because it is physically not possible to have the 3 orthogonal sensors situated with the same center. The effect of the different sensor centers is accounted for in the HAC uncertainty budget ("sensor displacement"). Their geometric center is at 2.5 mm from the tip, and the element ends are 1.1 mm closer to the tip.

Where:

Peak Field = Peak field (in dB V/m or dB A/m)

Raw = Raw field measurement from the measurement system (in V/m or A/m).

PMF = Probe Modulation Factor (in Linear units). See Chapter 8 of test report.

5.2 DATA Acquisition Electronics (DAE)

The data acquisition electronics (DAE) consists of a highly sensitive electrometer-grade preamplifier with auto-zeroing, a channel and gain-switching multiplexer, a fast 16 bit AD-converter and a command decoder and control logic unit. Transmission to the measurement server is accomplished through an optical downlink for data and status information as well as an optical uplink for commands and the clock.

The input impedance of the DAE is 200 MOhm; the inputs are symmetrical and floating. Common mode rejection is above 80 dB.



Fig 5.6 Photo of DAE

5.3 Robot

The SPEAG DASY system uses the high precision robots (DASY5: TX90XL) type from Stäubli SA (France). For the 6-axis controller system, the robot controller version (DASY5: CS8c) from Stäubli is used. The Stäubli robot series have many features that are important for our application:

- High precision (repeatability ± 0.035 mm)
- High reliability (industrial design)
- Jerk-free straight movements
- Low ELF interference (the closed metallic construction shields against motor control fields)
- 6-axis controller



Fig 5.7 Photo of DASY5

5.4 Measurement Server

The measurement server is based on a PC/104 CPU board with CPU (DASY5: 400 MHz, Intel Celeron), chipdisk (DASY5: 128 MB), RAM (DASY5: 128 MB). The necessary circuits for communication with the DAE electronic box, as well as the 16 bit AD converter system for optical detection and digital I/O interface are contained on the DASY I/O board, which is directly connected to the PC/104 bus of the CPU board.

The measurement server performs all the real-time data evaluation for field measurements and surface detection, controls robot movements and handles safety operations.



Fig 5.8 Photo of Server for DASY5

5.5 Phone Positioner

The phone positioner shown in Fig. 5.11 is used to adjust DUT to the suitable position.



Fig 5.9 Phone Positioner

5.6 Test Arch Phantom

<p>Construction :</p>	<p>Enables easy and well defined positioning of the phone and validation dipoles as well as simple teaching of the robot.</p>	
<p>Dimensions :</p>	<p>370 x 370 x 370 mm</p>	

Fig 5.10 Photo of Arch Phantom

5.7 Data Storage and Evaluation

5.7.1 Data Storage

The DASY software stores the assessed data from the data acquisition electronics as raw data (in microvolt readings from the probe sensors), together with all the necessary software parameters for the data evaluation (probe calibration data, and device frequency and modulation data) in measurement files. The post-processing software evaluates the desired unit and format for output each time the data is visualized or exported. This allows verification of the complete software setup even after the measurement and allows correction of erroneous parameter settings.

5.7.2 Data Evaluation

The DASY post-processing software (SEMCAD) automatically executes the following procedures to calculate the field units from the microvolt readings at the probe connector. The parameters used in the evaluation are stored in the configuration modules of the software :

Probe parameters :	- Sensitivity	Norm _i , a _{i0} , a _{i1} , a _{i2}
	- Conversion factor	ConvF _i
	- Diode compression point	dcp _i
Device parameters :	- Frequency	f
	- Crest factor	cf
Media parameters :	- Conductivity	σ
	- Density	ρ

These parameters must be set correctly in the software. They can be found in the component documents or they can be imported into the software from the configuration files issued for the DASY components. In the direct measuring mode of the multi-meter option, the parameters of the actual system setup are used. In the scan visualization and export modes, the parameters stored in the corresponding document files are used.

The first step of the evaluation is a linearization of the filtered input signal to account for the compression characteristics of the detector diode. The compensation depends on the input signal, the diode type and the DC-transmission factor from the diode to the evaluation electronics. If the exciting field is pulsed, the crest factor of the signal must be known to correctly compensate for peak power. The formula for each channel can be given as :

$$V_i = U_i + U_i^2 \cdot \frac{cf}{dcp_i}$$

with V_i = compensated signal of channel i , ($i = x, y, z$)
 U_i = input signal of channel i , ($i = x, y, z$)
 cf = crest factor of exciting field (DASY parameter)
 dcp_i = diode compression point (DASY parameter)

From the compensated input signals, the primary field data for each channel can be evaluated :

$$\text{E-field Probes : } \mathbf{E}_i = \sqrt{\frac{V_i}{\text{Norm}_i \cdot \text{ConvF}}}$$

$$\text{H-field Probes : } \mathbf{H}_i = \sqrt{V_i} \cdot \frac{a_{i0} + a_{i1}f + a_{i2}f^2}{f}$$

with V_i = compensated signal of channel i , ($i = x, y, z$)

Norm_i = sensor sensitivity of channel i , ($i = x, y, z$), $\mu\text{V}/(\text{V}/\text{m})^2$ for E-field Probes

ConvF = sensitivity enhancement in solution

a_{ij} = sensor sensitivity factors for H-field probes

f = carrier frequency [GHz]

E_i = electric field strength of channel i in V/m

H_i = magnetic field strength of channel i in A/m

The RSS value of the field components gives the total field strength (Hermitian magnitude) :

$$\mathbf{E}_{\text{tot}} = \sqrt{\mathbf{E}_x^2 + \mathbf{E}_y^2 + \mathbf{E}_z^2}$$

The primary field data are used to calculate the derived field units.

The measurement/integration time per point, as specified by the system manufacturer is > 500 ms. The signal response time is evaluated as the time required by the system to reach 90% of the expected final value after an on/off switch of the power source with an integration time of 500 ms and a probe response time of < 5 ms. In the current implementation, DASYS waits longer than 100 ms after having reached the grid point before starting a measurement, i.e., the response time uncertainty is negligible.

If the device under test does not emit a CW signal, the integration time applied to measure the electric field at a specific point may introduce additional uncertainties due to the discretization. The tolerances for the different systems had the worst-case of 2.6%.



5.8 Test Equipment List

Manufacturer	Name of Equipment	Type/Model	Serial Number	Calibration	
				Last Cal.	Due Date
SPEAG	Dipole	CD835V3	1184	Apr. 11, 2012	Apr. 10, 2013
SPEAG	Dipole	CD1880V3	1170	Apr. 11, 2012	Apr. 10, 2013
SPEAG	Data Acquisition Electronics	DAE4	1303	Nov. 22, 2012	Nov. 21, 2013
SPEAG	Probe	H3DV6	6342	Apr. 10, 2012	Apr. 09, 2013
SPEAG	probe	ER3DV6	2528	Apr. 10, 2012	Apr. 09, 2013
SPEAG	Test Arch Phantom	Par phantom	1105	NCR	NCR
SPEAG	Phone Positioner	N/A	N/A	NCR	NCR
R&S	Universal Radio Communication Tester	CMU200	102049	Jun. 29, 2012	Jun. 28, 2013
Agilent	Wireless Communication Test Set	E5515C	MY50267224	Dec. 29, 2012	Dec. 28, 2013
AR	Amplifier	551G4	333096	NCR	NCR
Anritsu	Power Meter	ML2495A	1218010	May 07, 2012	May 06, 2013
Anritsu	Power Sensor	MA2411B	1207253	May 08, 2012	May 07, 2013
ARRA	Power Divider	A3200-2	N/A	NA	NA
MCL	Attenuation	BW-S10W5	N/A	NA	NA
R&S	Spectrum Analyzer	FSP30	101400	Jun. 01, 2012	May 31, 2013

Table 5.1 Test Equipment List

6. Uncertainty Assessment

The component of uncertainty may generally be categorized according to the methods used to evaluate them. The evaluation of uncertainty by the statistical analysis of a series of observations is termed a Type A evaluation of uncertainty. The evaluation of uncertainty by means other than the statistical analysis of a series of observation is termed a Type B evaluation of uncertainty. Each component of uncertainty, however evaluated, is represented by an estimated standard deviation, termed standard uncertainty, which is determined by the positive square root of the estimated variance.

A Type A evaluation of standard uncertainty may be based on any valid statistical method for treating data. This includes calculating the standard deviation of the mean of a series of independent observations; using the method of least squares to fit a curve to the data in order to estimate the parameter of the curve and their standard deviations; or carrying out an analysis of variance in order to identify and quantify random effects in certain kinds of measurement.

A type B evaluation of standard uncertainty is typically based on scientific judgment using all of the relevant information available. These may include previous measurement data, experience and knowledge of the behavior and properties of relevant materials and instruments, manufacture’s specification, data provided in calibration reports and uncertainties assigned to reference data taken from handbooks. Broadly speaking, the uncertainty is either obtained from an outdoor source or obtained from an assumed distribution, such as the normal distribution, rectangular or triangular distributions indicated in Table 6.1.

Uncertainty Distributions	Normal	Rectangular	Triangular	U-Shape
Multi-plying Factor ^(a)	1/k ^(b)	1/√3	1/√6	1/√2

(a) standard uncertainty is determined as the product of the multiplying factor and the estimated range of variations in the measured quantity

(b) κ is the coverage factor

Table 6.1 Multiplying Factions for Various Distributions

The combined standard uncertainty of the measurement result represents the estimated standard deviation of the result. It is obtained by combining the individual standard uncertainties of both Type A and Type B evaluation using the usual “root-sum-squares” (RSS) methods of combining standard deviations by taking the positive square root of the estimated variances.

Expanded uncertainty is a measure of uncertainty that defines an interval about the measurement result within which the measured value is confidently believed to lie. It is obtained by multiplying the combined standard uncertainty by a coverage factor. Typically, the coverage factor ranges from 2 to 3. Using a coverage factor allows the true value of a measured quantity to be specified with a defined probability within the specified uncertainty range. For purpose of this document, a coverage factor two is used, which corresponds to confidence interval of about 95 %. The DASY uncertainty Budget is showed in Table 6.2.



Error Description	Uncertainty Value (±%)	Probability Distribution	Divisor	Ci (E)	Ci (H)	Standard Uncertainty (E)	Standard Uncertainty (H)
Measurement System							
Probe Calibration	5.1	Normal	1	1	1	± 5.1 %	± 5.1 %
Axial Isotropy	4.7	Rectangular	√3	1	1	± 2.7 %	± 2.7 %
Sensor Displacement	16.5	Rectangular	√3	1	0.145	± 9.5 %	± 1.4 %
Test Arch	7.2	Rectangular	√3	1	0	± 4.1 %	± 0.0 %
Linearity	4.7	Rectangular	√3	1	1	± 2.7 %	± 2.7 %
Scaling to Peak Envelope Power	0.0	Rectangular	√3	1	1	± 0.0 %	± 0.0 %
System Detection Limit	1.0	Rectangular	√3	1	1	± 0.6 %	± 0.6 %
Readout Electronics	0.3	Normal	1	1	1	± 0.3 %	± 0.3 %
Response Time	0.8	Rectangular	√3	1	1	± 0.5 %	± 0.5 %
Integration Time	2.6	Rectangular	√3	1	1	± 1.5 %	± 1.5 %
RF Ambient Conditions	3.0	Rectangular	√3	1	1	± 1.7 %	± 1.7 %
RF Reflections	12.0	Rectangular	√3	1	1	± 6.9 %	± 6.9 %
Probe Positioner	1.2	Rectangular	√3	1	0.67	± 0.7 %	± 0.5 %
Probe Positioning	4.7	Rectangular	√3	1	0.67	± 2.7 %	± 1.8 %
Extrap. and Interpolation	1.0	Rectangular	√3	1	1	± 0.6 %	± 0.6 %
Test Sample Related							
Device Positioning Vertical	4.7	Rectangular	√3	1	0.67	± 2.7 %	± 1.8 %
Device Positioning Lateral	1.0	Rectangular	√3	1	1	± 0.6 %	± 0.6 %
Device Holder and Phantom	2.4	Rectangular	√3	1	1	± 1.4 %	± 1.4 %
Power Drift	5.0	Rectangular	√3	1	1	± 2.9 %	± 2.9 %
Phantom and Setup Related							
Phantom Thickness	2.4	Rectangular	√3	1	0.67	± 1.4 %	± 0.9 %
Combined Standard Uncertainty						± 15.2 %	± 10.8 %
Coverage Factor for 95 %						K = 2	
Expanded Uncertainty						± 30.4 %	± 21.6 %

Table 6.2 Uncertainty Budget of DASYS

7. HAC RF Emission Measurement Evaluation

Each DASy system is equipped with one or more system validation kits. These units, together with the predefined measurement procedures within the DASy software, enable the user to conduct the system performance check and system validation. System validation kit includes a dipole, tripod holder to fix it underneath the test Arch and a corresponding distance holder.

7.1 Purpose of System Performance Check

The system performance check verifies that the system operates within its specifications. System and operator errors can be detected and corrected. It is recommended that the system performance check be performed prior to any usage of the system in order to guarantee reproducible results. The system performance check uses normal HAC measurements in a simplified setup with a well characterized source. This setup was selected to give a high sensitivity to all parameters that might fail or vary over time. The system check does not intend to replace the calibration of the components, but indicates situations where the system uncertainty is exceeded due to drift or failure.

7.2 System Setup

In the simplified setup for system evaluation, the DUT is replaced by a calibrated dipole and the power source is replaced by a continuous wave which comes from a signal generator. The calibrated dipole must be placed beneath the arch phantom. The equipment setup is shown below:

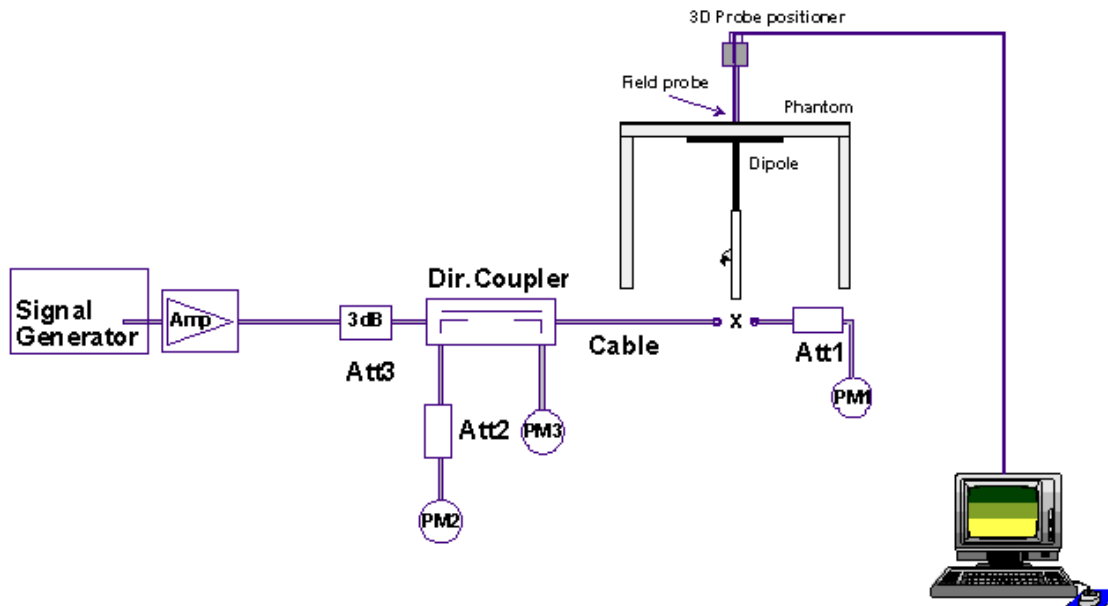

Fig. 7.1 System Setup of System Evaluation

1. Signal Generator
2. Amplifier
3. Directional Coupler
4. Power Meter
5. Calibrated Dipole

The output power on dipole port must be calibrated to 20dBm (100mW) before dipole is connected.

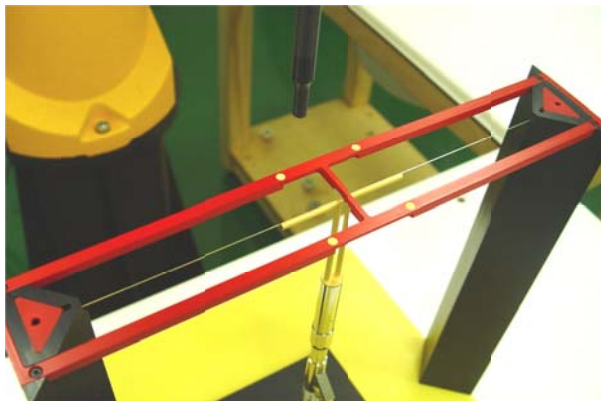

Fig 7.2 Dipole Setup

7.3 Validation Results

Comparing to the original E-field or H-field value provided by SPEAG, the validation data should be within its specification of 25 %. Table 7.1 shows the target value and measured value. The table below indicates the system performance check can meet the variation criterion and the plots can be referred to appendix A of this report.

Frequency (MHz)	Input Power (dBm)	Target Value (V/m)	E-Field 1 (V/m)	E-Field 2 (V/m)	Average Value (V/m)	Deviation (%)	Date
835	20	165.1	173.1	156.5	164.8	-0.18	Mar. 02, 2013
1880	20	137.9	139.4	130.8	135.1	-2.03	Mar. 02, 2013
Frequency (MHz)	Input Power (dBm)	Target Value (A/m)	H-Field (A/m)		Deviation (%)	Date	
835	20	0.461	0.444		-3.69	Mar. 02, 2013	
1880	20	0.465	0.481		3.44	Mar. 02, 2013	

Table 7.1 Test Results of System Validation

Note: Deviation = ((E or H-field Result) - (Target field)) / (Target field) * 100%

8. RF Field Probe Modulation Factor

A calibration shall be made of the modulation response of the probe and its instrumentation chain. This calibration shall be performed with the field probe, attached to the instrumentation that is to be used with it during the measurement. The response of the probe system to a CW field at the frequency(s) of interest is compared to its response to a modulated signal with equal peak amplitude. The field level of the test signals shall be more than 10 dB above the ambient level and the noise floor of the instrumentation being used. The ratio of the CW reading to that taken with a modulated field shall be applied to the readings taken of modulated fields of the specified type.

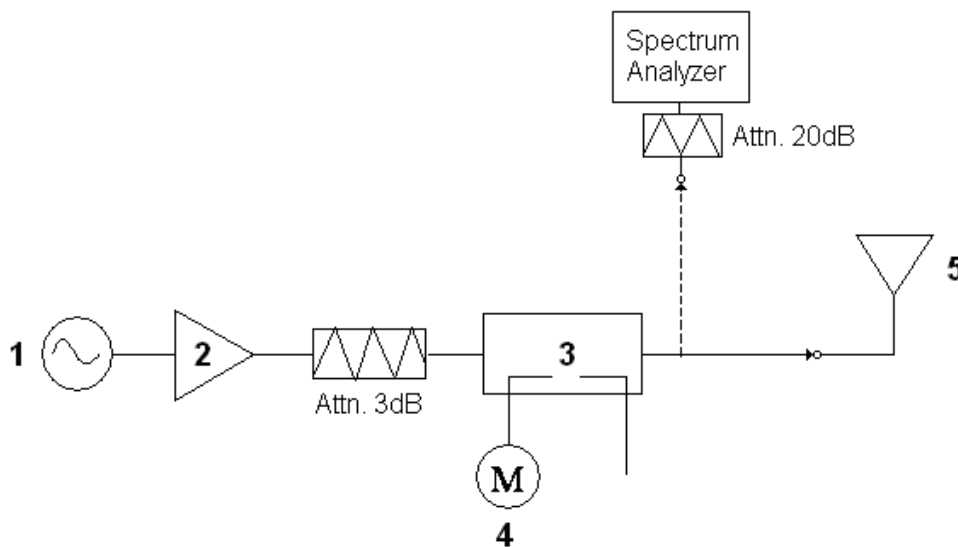

Fig. 8.1 System Calibration

This was done using the following procedure:

1. Fixing the probe in a set location relative to a field generating device.
2. Illuminate the probe with a CW signal at the intended measurement frequency.
3. Record the reading of the probe measurement system of the CW signal.
4. Determine the level of the CW signal being used to drive the field generating device.
5. Substitute a signal using the same modulation as that used by the intended WD for the CW signal.
6. Set the peak amplitude during transmission of the modulated signal to equal the amplitude of the CW signal.
7. Record the reading of the probe measurement system of the modulated signal.
8. The ratio of the CW to modulated signal reading is the modulation factor.
9. Repeat 2~8 steps at intended measurement frequency for both E and H field probe.



PMF Measurement Summary:

For GSM:

Frequency (MHz)	Functions	E-field	H-field	PMF	
		V/m	A/m	E-field	H-field
835	CW	661.0	3.112	-	-
835	AM 80%	416.0	1.450	1.59	2.15
835	GSM	251.0	1.197	2.63	2.60
1880	CW	532.7	3.616	-	-
1880	AM 80%	330.8	1.471	1.61	2.46
1880	GSM	199.9	1.470	2.66	2.46

For WCDMA:

Frequency (MHz)	Functions	E-field	H-field	PMF	
		V/m	A/m	E-field	H-field
835	CW	296.7	0.613	-	-
835	AM 80%	194.7	0.432	1.52	1.42
835	WCDMA	296.9	0.736	1.00	0.83
1880	CW	196.6	0.942	-	-
1880	AM 80%	131.7	0.512	1.49	1.84
1880	WCDMA	187.6	1.095	1.05	0.86



Zero span Spectrum Plots for RF Field Probe Modulation Factor
For GSM:

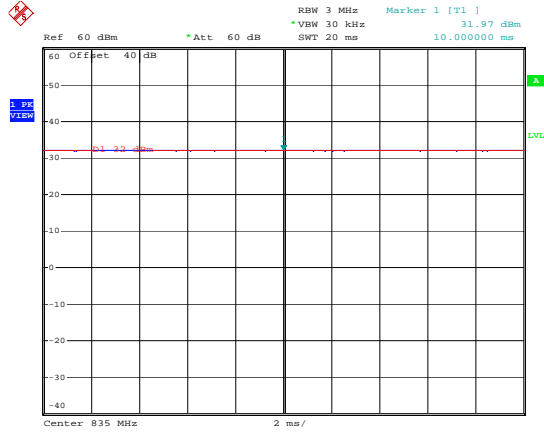

835MHz - CW

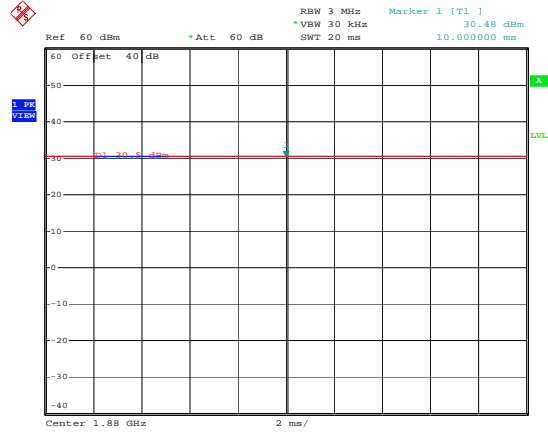

1880MHz - CW

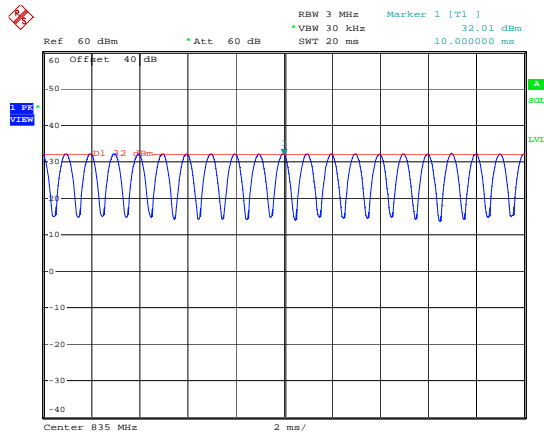

835MHz - 80% AM

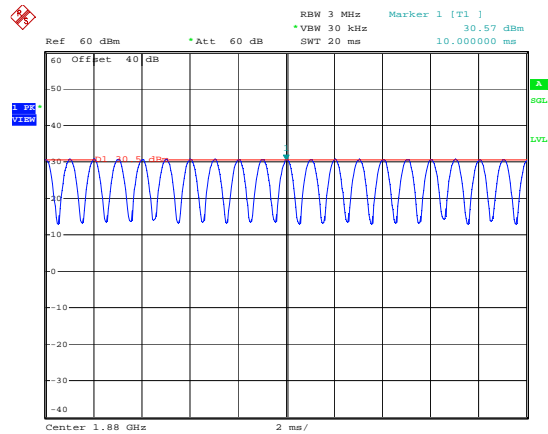

1880MHz - 80% AM

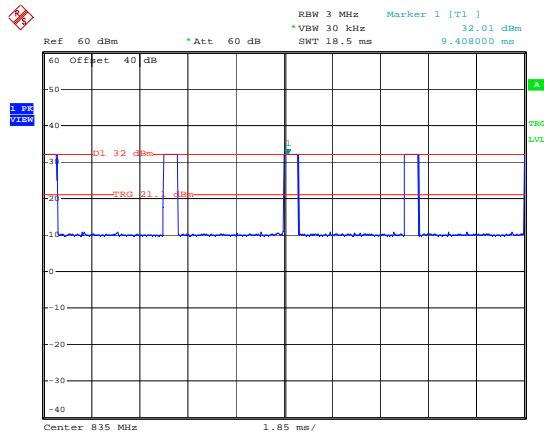

835MHz - GSM

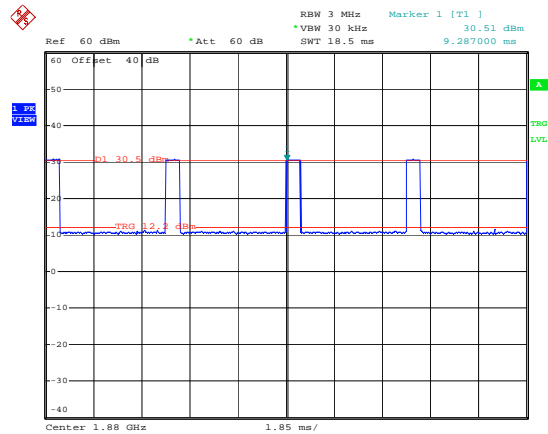

1880MHz - GSM



For WCDMA:

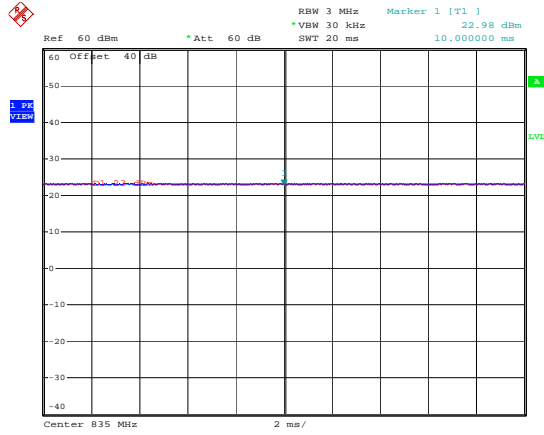

835MHz - CW

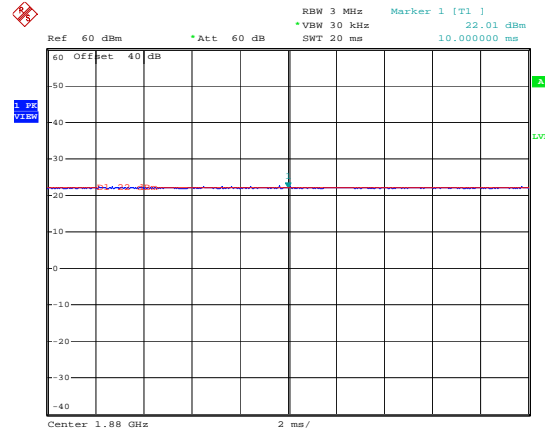

1880MHz - CW

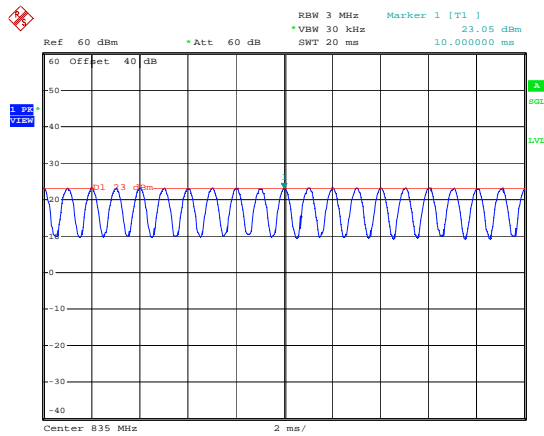

835MHz - 80% AM

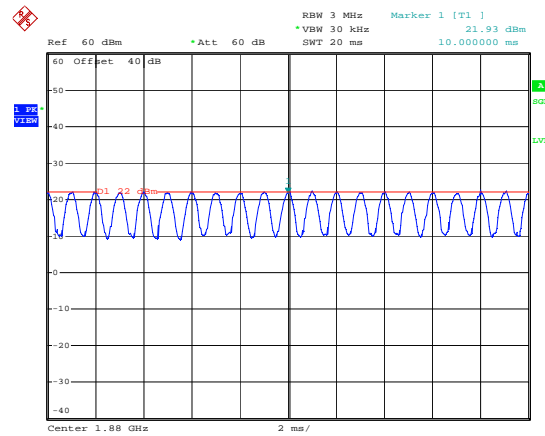

1880MHz - 80% AM

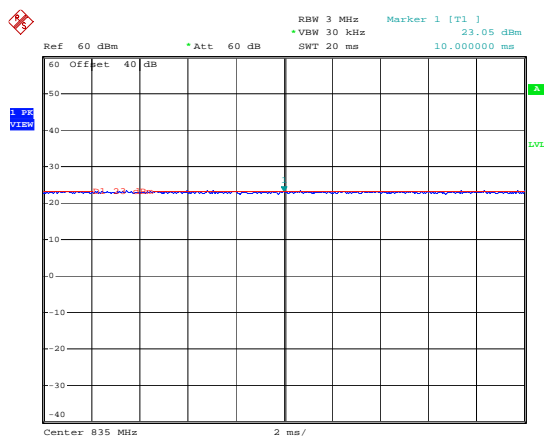

835MHz - WCDMA

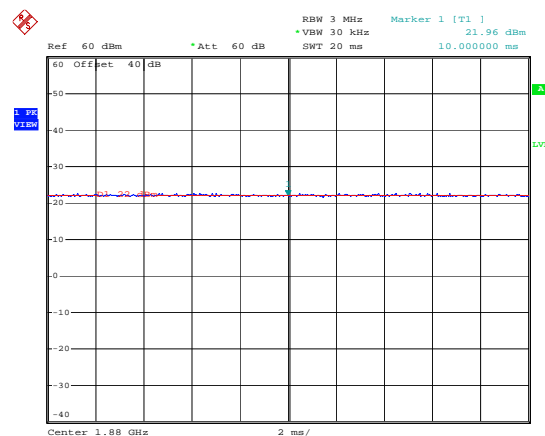

1880MHz - WCDMA

9. Description for DUT Testing Position

The DUT was put on device holder and adjusted to the accurate and reliable position. Please refer to Appendix E for the Setup photographs.

Fig. 9.1 illustrate the references and reference plane that shall be used in a typical DUT emissions measurement. The principle of this section is applied to DUT with similar geometry.

- The grid is 5 cm by 5 cm area that is divided into 9 evenly sized blocks or sub-grids.
- The grid is centered on the audio frequency output transducer of the DUT.
- The grid is in a reference plane, which is defined as the planar area that contains the highest point in the area of the phone that normally rests against the user's ear. It is parallel to the centerline of the receiver area of the phone and is defined by the points of the receiver-end of the DUT handset, which, in normal handset use, rest against the ear.
- The measurement plane is parallel to, and 15 mm in front of, the reference plane.



Fig 9.1 A typical DUT reference and plane for HAC measurements

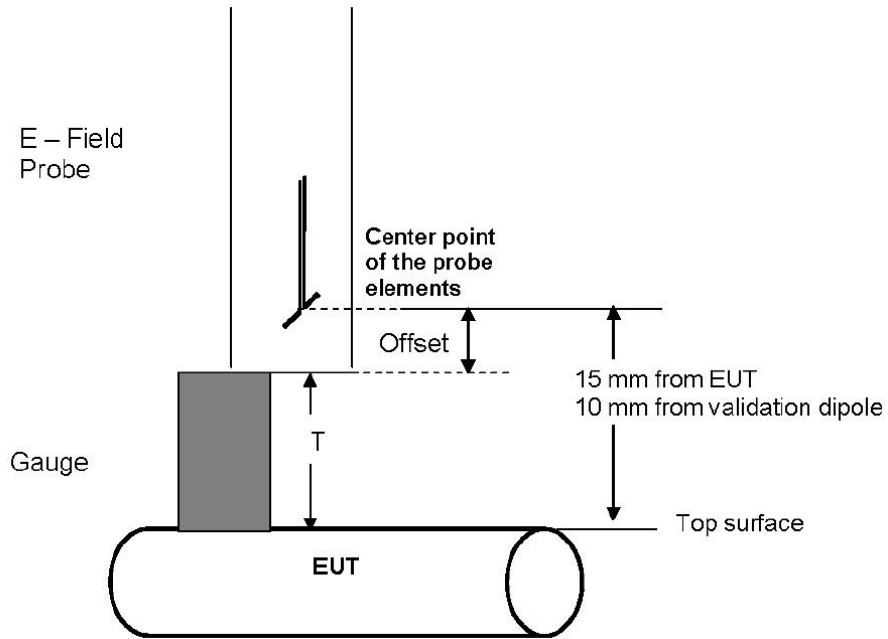

Fig. 9.2 Gauge block with E-field probe

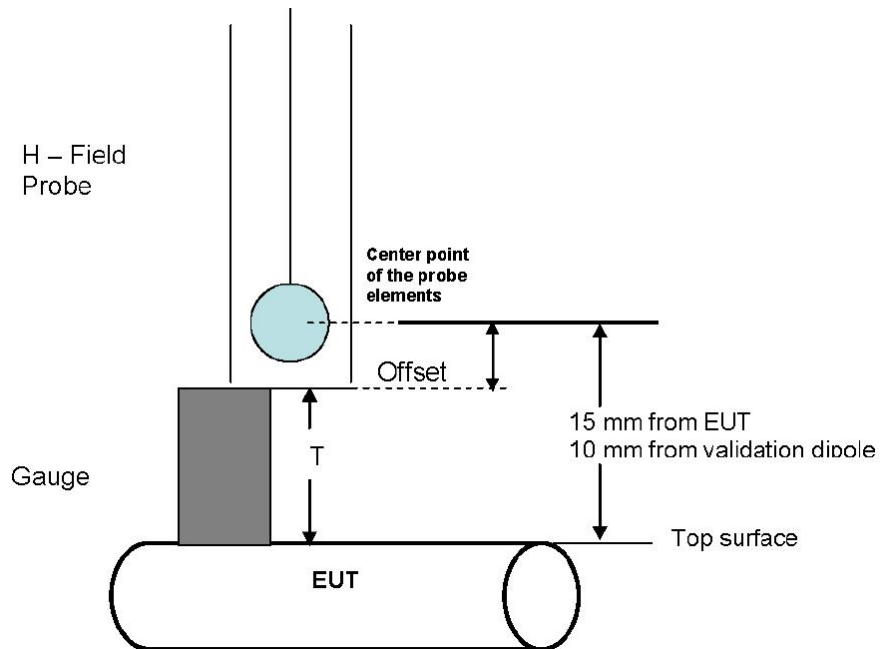

Fig. 9.3 Gauge block with H-field probe



10. RF Emissions Test Procedure

The following illustrate a typical RF emissions test scan over a wireless communications device:

1. Proper operation of the field probe, probe measurement system, other instrumentation, and the positioning system was confirmed.
2. DUT is positioned in its intended test position, acoustic output point of the device perpendicular to the field probe.
3. The DUT operation for maximum rated RF output power was configured and confirmed with the base station simulator, at the test channel and other normal operating parameters as intended for the test. The battery was ensured to be fully charged before each test.
4. The center sub-grid was centered over the center of the acoustic output (also audio band magnetic output, if applicable). The DUT audio output was positioned tangent (as physically possible) to the measurement plane.
5. A surface calibration was performed before each setup change to ensure repeatable spacing and proper maintenance of the measurement plane using the test Arch.
6. The measurement system measured the field strength at the reference location.
7. Measurements at 5 mm increments in the 5 x 5 cm region were performed and recorded. A 360° rotation about the azimuth axis at the maximum interpolated position was measured. For the worst-case condition, the peak reading from this rotation was used in re-evaluating the HAC category.
8. The system performed a drift evaluation by measuring the field at the reference location.
9. Steps 1 ~ 8 were done for both the E and H-Field measurements.



11. HAC RF Emission Test Results

11.1 Conducted Power (Unit: dBm)

<GSM>

Band	Burst Average Power					
	GSM850			GSM1900		
Channel	128	189	251	512	661	810
Frequency (MHz)	824.2	836.4	848.8	1850.2	1880.0	1909.8
GSM (GMSK, 1 Tx slot)	32.09	32.25	32.33	30.18	30.38	30.66
GPRS (GMSK, 1 Tx slot) – CS1	32.04	32.19	32.29	30.17	30.35	30.65
GPRS (GMSK, 2 Tx slots) – CS1	31.25	31.40	31.51	29.22	29.40	29.70
GPRS (GMSK, 3 Tx slots) – CS1	29.61	29.80	29.93	27.23	27.41	27.74
GPRS (GMSK, 4 Tx slots) – CS1	28.80	28.99	29.13	26.16	26.36	26.68

<WCDMA>

Band	WCDMA Band V			WCDMA Band II		
	4132	4182	4233	9262	9400	9538
Channel	4132	4182	4233	9262	9400	9538
Frequency (MHz)	826.4	836.4	846.6	1852.4	1880.0	1907.6
AMR 12.2k	22.86	23.01	22.86	21.74	21.85	21.83
RMC 12.2k	22.87	23.02	22.88	21.76	21.86	21.85
HSDPA Subtest-1	22.84	23.01	22.89	21.46	21.57	21.45
HSDPA Subtest-2	22.06	22.04	22.05	20.40	20.49	20.36
HSDPA Subtest-3	21.62	21.60	21.60	19.90	19.99	19.85
HSDPA Subtest-4	21.57	21.54	21.53	19.86	19.98	19.84
HSUPA Subtest-1	20.82	20.85	20.81	19.34	19.46	19.37
HSUPA Subtest-2	20.10	20.09	20.08	18.55	18.67	18.54
HSUPA Subtest-3	20.48	20.44	20.43	18.96	19.05	18.91
HSUPA Subtest-4	20.76	20.75	20.75	19.37	19.44	19.31
HSUPA Subtest-5	20.91	20.92	20.90	19.41	19.53	19.40



11.2 E-Field Emission

Plot No.	Band	Mode	Channel	PMF	Peak E-Field (V/m)	M-Rating
1	GSM850	GSM Voice	128	2.63	220.1	M3
2	GSM850	GSM Voice	189	2.63	235.1	M3
3	GSM850	GSM Voice	251	2.63	235.8	M3
4	GSM1900	GSM Voice	512	2.66	77.241	M3
5	GSM1900	GSM Voice	661	2.66	73.357	M3
6	GSM1900	GSM Voice	810	2.66	70.158	M3
7	WCDMA Band V	RMC12.2Kbps	4132	1.00	84.592	M4
8	WCDMA Band V	RMC12.2Kbps	4182	1.00	90.319	M4
9	WCDMA Band V	RMC12.2Kbps	4233	1.00	87.978	M4
10	WCDMA Band II	RMC12.2Kbps	9262	1.05	32.867	M4
11	WCDMA Band II	RMC12.2Kbps	9400	1.05	30.453	M4
12	WCDMA Band II	RMC12.2Kbps	9538	1.05	29.448	M4

11.3 H-Field Emission

Plot No.	Band	Mode	Channel	PMF	Peak H-Field (A/m)	M-Rating
1	GSM850	GSM Voice	128	2.60	0.424	M4
2	GSM850	GSM Voice	189	2.60	0.458	M3
3	GSM850	GSM Voice	251	2.60	0.479	M3
4	GSM1900	GSM Voice	512	2.46	0.207	M3
5	GSM1900	GSM Voice	661	2.46	0.201	M3
6	GSM1900	GSM Voice	810	2.46	0.204	M3
7	WCDMA Band V	RMC12.2Kbps	4132	0.83	0.140	M4
8	WCDMA Band V	RMC12.2Kbps	4182	0.83	0.152	M4
9	WCDMA Band V	RMC12.2Kbps	4233	0.83	0.152	M4
10	WCDMA Band II	RMC12.2Kbps	9262	0.86	0.076	M4
11	WCDMA Band II	RMC12.2Kbps	9400	0.86	0.071	M4
12	WCDMA Band II	RMC12.2Kbps	9538	0.86	0.071	M4

Remark:

1. The volume was adjusted to maximum level and the backlight turned off during RF Emission testing.
2. There is no special HAC mode software on this DUT.
3. Test Engineer : Jeme Li



12. References

- [1] ANSI C63.19-2007, "American National Standard for Methods of Measurement of Compatibility between Wireless Communications Devices and Hearing Aids", 8 June 2007
- [2] SPEAG DASY System Handbook



Appendix A. Plots of System Performance Check

The plots are shown as follows.

HAC-RF_CD835V3_E_130302

DUT: HAC-Dipole 835 MHz

Communication System: CW; Frequency: 835 MHz; Duty Cycle: 1:1

Medium: Air Medium parameters used: $\sigma = 0$ mho/m, $\epsilon_r = 1$; $\rho = 0$ kg/m³

Ambient Temperature : 23.7 °C

DASY5 Configuration:

- Probe: ER3DV6 - SN2528; ConvF(1, 1, 1); Calibrated: 10.04.2012
- Electronics: DAE4 Sn1303; Calibrated: 22.11.2012
- Phantom: HAC Test Arch with AMCC; Type: SD HAC P01 BA;
- Measurement SW: DASY52, Version 52.8 (2); SEMCAD X Version 14.4.5 (3634)

E Scan - measurement distance from the probe sensor center to CD835 = 10mm/Hearing Aid Compatibility Test at 10mm distance (41x361x1): Measurement

grid: dx=5mm, dy=5mm

Maximum value of peak Total field = 173.1 V/m

Device Reference Point: 0, 0, -6.3 mm

Reference Value = 118.2 V/m; Power Drift = -0.03 dB

Hearing Aid Near-Field Category: M4 (AWF 0 dB)

Peak E-field in V/m

Grid 1 165.7 M4	Grid 2 173.1 M4	Grid 3 166.0 M4
Grid 4 81.055 M4	Grid 5 85.375 M4	Grid 6 84.158 M4
Grid 7 148.5 M4	Grid 8 156.5 M4	Grid 9 154.0 M4

Cursor:

Total = 173.1 V/m

E Category: M4

Location: 0, -79, 4.7 mm

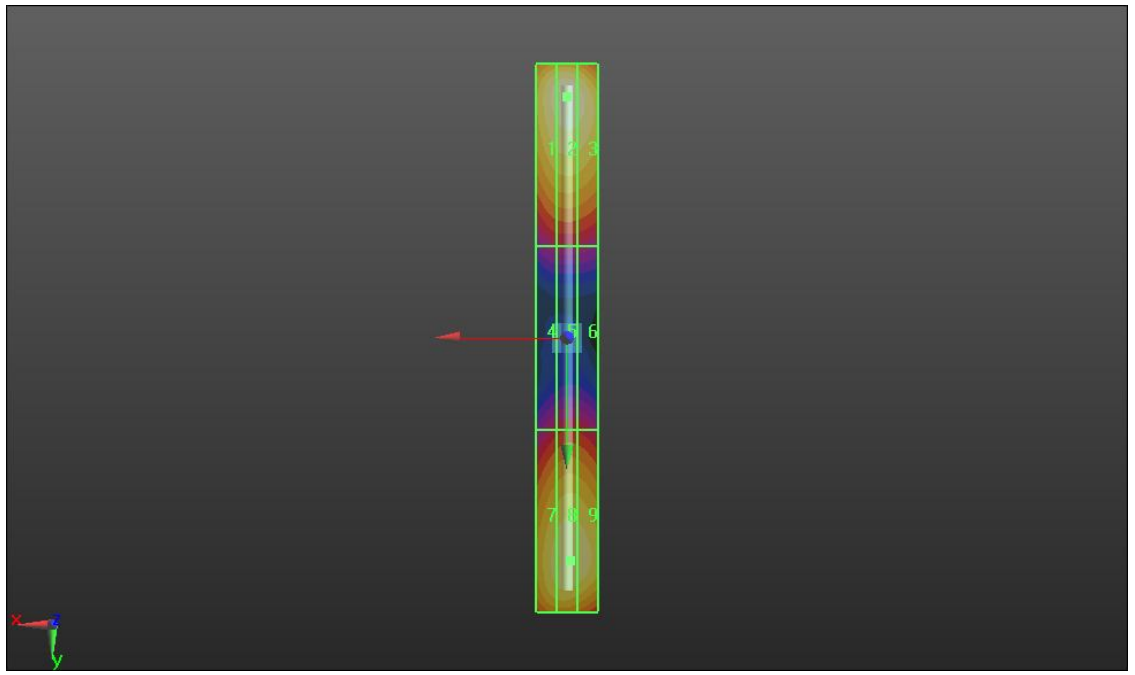
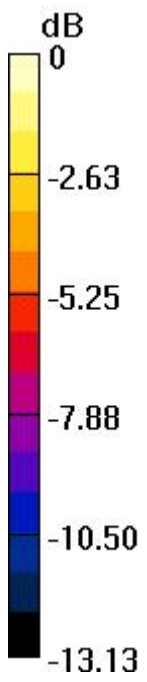

0 dB = 173.1V/m

HAC-RF_CD835V3_H_130302

DUT: HAC-Dipole 835 MHz

Communication System: CW; Frequency: 835 MHz; Duty Cycle: 1:1

Medium: Air Medium parameters used: $\sigma = 0$ mho/m, $\epsilon_r = 1$; $\rho = 0$ kg/m³

Ambient Temperature : 23.6 °C

DASY5 Configuration:

- Probe: H3DV6 - SN6342; ; Calibrated: 10.04.2012
- Electronics: DAE4 Sn1303; Calibrated: 22.11.2012
- Phantom: HAC Test Arch with AMCC; Type: SD HAC P01 BA;
- Measurement SW: DASY52, Version 52.8 (2); SEMCAD X Version 14.4.5 (3634)

H Scan - measurement distance from the probe sensor center to CD835 Dipole = 10mm/Hearing Aid Compatibility Test (41x361x1): Measurement grid: dx=5mm, dy=5mm

Maximum value of peak Total field = 0.444 A/m

Device Reference Point: 0, 0, -6.3 mm

Reference Value = 0.472 A/m; Power Drift = -0.06 dB

Hearing Aid Near-Field Category: M4 (AWF 0 dB)

Peak H-field in A/m

Grid 1 0.380 M4	Grid 2 0.396 M4	Grid 3 0.379 M4
Grid 4 0.427 M4	Grid 5 0.444 M4	Grid 6 0.428 M4
Grid 7 0.375 M4	Grid 8 0.393 M4	Grid 9 0.380 M4

Cursor:

Total = 0.444 A/m

H Category: M4

Location: 0, -1, 5.3 mm

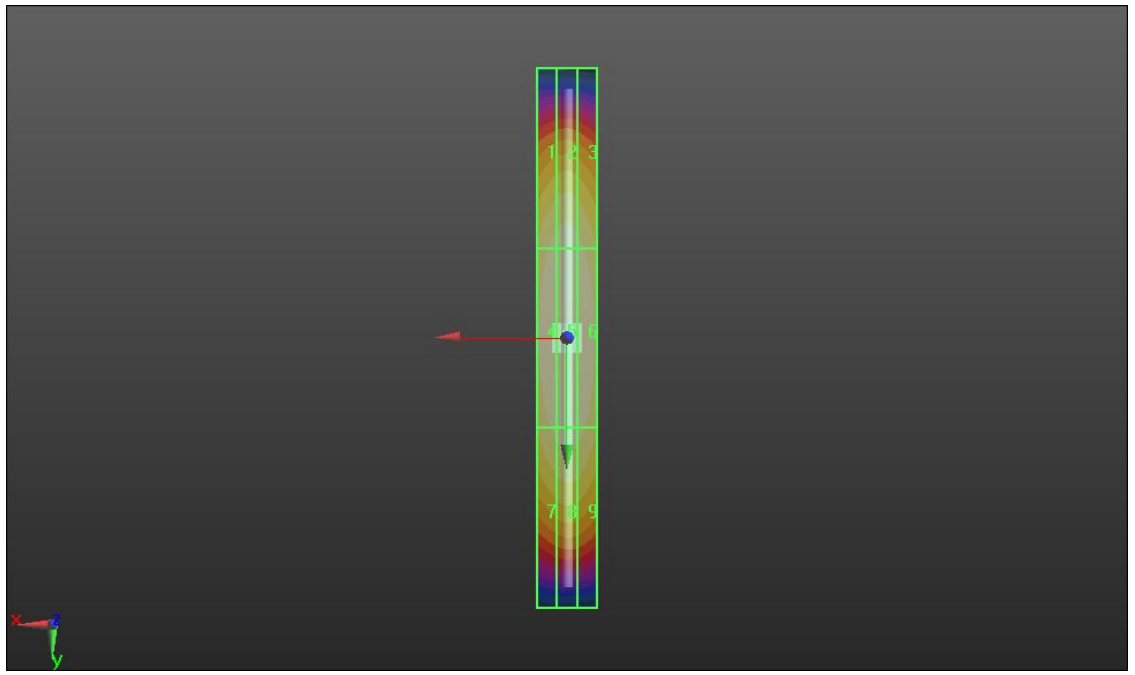
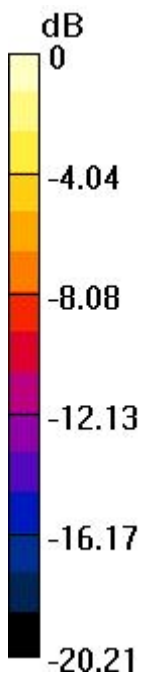

0 dB = 0.420A/m

HAC-RF_CD1880V3_E_130302

DUT: HAC Dipole 1880 MHz

Communication System: CW; Frequency: 1880 MHz; Duty Cycle: 1:1

Medium: Air Medium parameters used: $\sigma = 0$ mho/m, $\epsilon_r = 1$; $\rho = 0$ kg/m³

Ambient Temperature : 23.7 °C

DASY5 Configuration:

- Probe: ER3DV6 - SN2528; ConvF(1, 1, 1); Calibrated: 10.04.2012
- Electronics: DAE4 Sn1303; Calibrated: 22.11.2012
- Phantom: HAC Test Arch with AMCC; Type: SD HAC P01 BA;
- Measurement SW: DASY52, Version 52.8 (2); SEMCAD X Version 14.4.5 (3634)

E Scan - measurement distance from the probe sensor center to CD1880 = 10mm/Hearing Aid Compatibility Test at 10mm distance (41x361x1): Measurement grid: dx=5mm, dy=5mm

Maximum value of peak Total field = 139.4 V/m

Device Reference Point: 0, 0, -6.3 mm

Reference Value = 133.1 V/m; Power Drift = 0.01 dB

Hearing Aid Near-Field Category: M2 (AWF 0 dB)

Peak E-field in V/m

Grid 1 134.3 M2	Grid 2 139.4 M2	Grid 3 132.0 M2
Grid 4 124.0 M2	Grid 5 129.6 M2	Grid 6 126.8 M2
Grid 7 126.0 M2	Grid 8 130.8 M2	Grid 9 127.6 M2

Cursor:

Total = 139.4 V/m

E Category: M2

Location: 0.5, -38.5, 4.7 mm

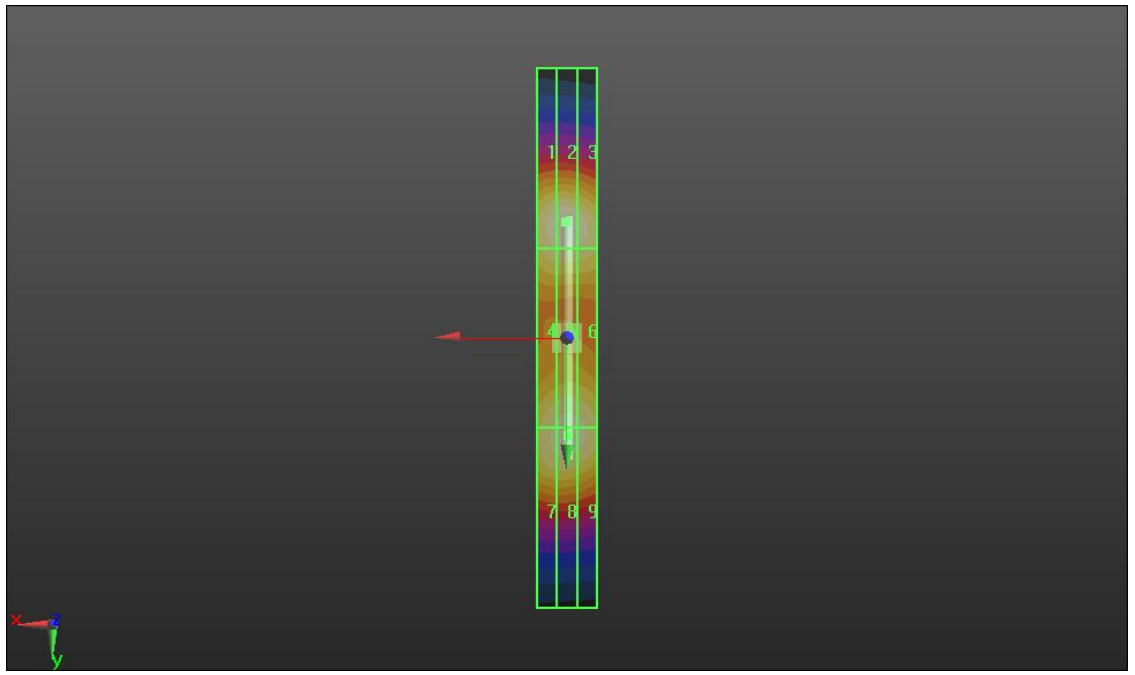
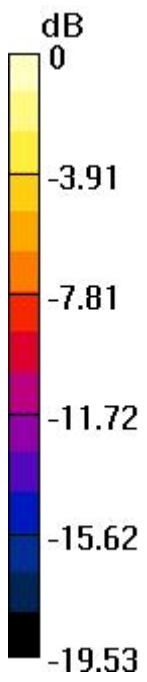

0 dB = 139.4V/m

HAC-RF_CD1880V3_H_130302

DUT: HAC Dipole 1880 MHz

Communication System: CW; Frequency: 1880 MHz; Duty Cycle: 1:1

Medium: Air Medium parameters used: $\sigma = 0$ mho/m, $\epsilon_r = 1$; $\rho = 0$ kg/m³

Ambient Temperature : 23.6 °C

DASY5 Configuration:

- Probe: H3DV6 - SN6342; ; Calibrated: 10.04.2012
- Electronics: DAE4 Sn1303; Calibrated: 22.11.2012
- Phantom: HAC Test Arch with AMCC; Type: SD HAC P01 BA;
- Measurement SW: DASY52, Version 52.8 (2); SEMCAD X Version 14.4.5 (3634)

H Scan - measurement distance from the probe sensor center to CD1880 Dipole = 10mm/Hearing Aid Compatibility Test (41x361x1): Measurement grid: dx=5mm, dy=5mm

Maximum value of peak Total field = 0.481 A/m

Device Reference Point: 0, 0, -6.3 mm

Reference Value = 0.459 A/m; Power Drift = 0.0061 dB

Hearing Aid Near-Field Category: M2 (AWF 0 dB)

Peak H-field in A/m

Grid 1 0.277 M3	Grid 2 0.281 M3	Grid 3 0.267 M3
Grid 4 0.467 M2	Grid 5 0.481 M2	Grid 6 0.462 M2
Grid 7 0.289 M3	Grid 8 0.297 M3	Grid 9 0.287 M3

Cursor:

Total = 0.481 A/m

H Category: M2

Location: 0.5, 0.5, 5.3 mm

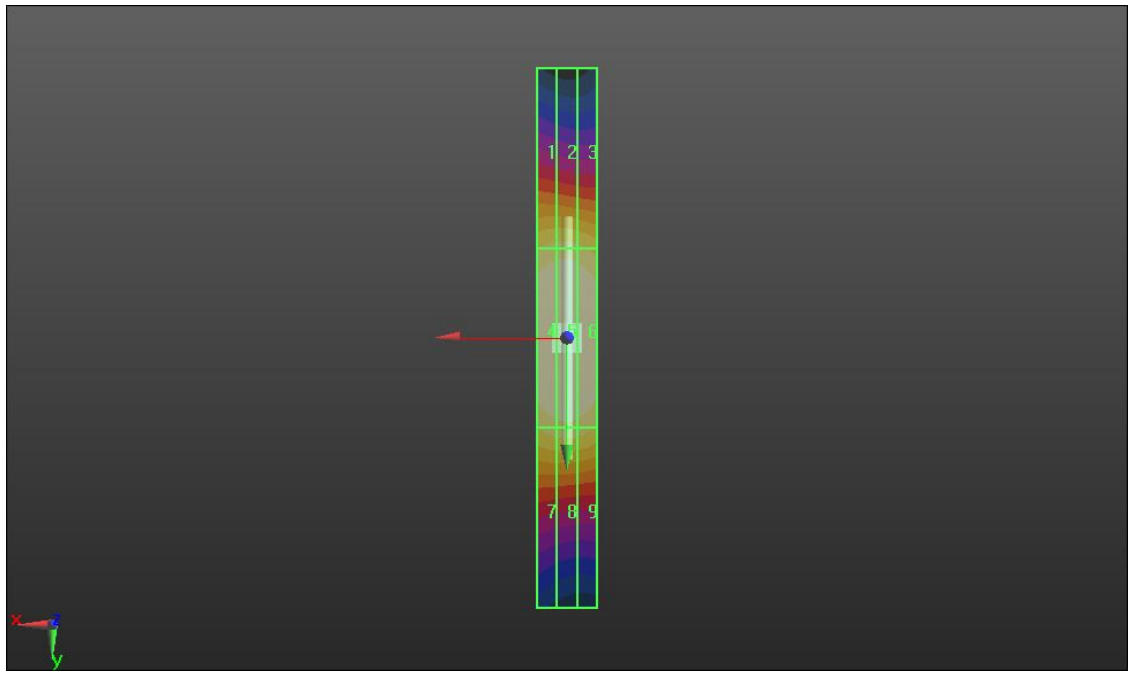
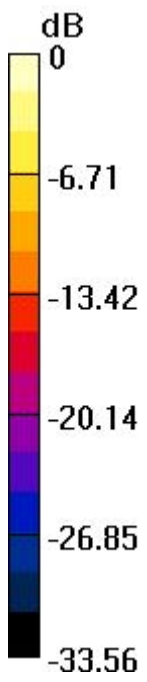

0 dB = 0.420A/m



Appendix B. Plots of RF Emission Measurement

The plots are shown as follows.

01 RF_GSM850_GSM Voice_Ch128_E

DUT: 312310A

Communication System: Generic GSM; Frequency: 824.2 MHz; Duty Cycle: 1:8.3

Medium: Air Medium parameters used: $\sigma = 0$ mho/m, $\epsilon_r = 1$; $\rho = 0$ kg/m³

Ambient Temperature : 23.7 °C

DASY5 Configuration:

- Probe: ER3DV6 - SN2528; ConvF(1, 1, 1); Calibrated: 10.04.2012
- Electronics: DAE4 Sn1303; Calibrated: 22.11.2012
- Phantom: HAC Test Arch with AMCC; Type: SD HAC P01 BA;
- Measurement SW: DASY52, Version 52.8 (2); SEMCAD X Version 14.4.5 (3634)

Ch128/Hearing Aid Compatibility Test (101x101x1): Measurement grid: dx=5mm, dy=5mm

Maximum value of peak Total field = 220.1 V/m

Device Reference Point: 0, 0, -6.3 mm

Reference Value = 112.6 V/m; Power Drift = -0.02 dB

Hearing Aid Near-Field Category: M3 (AWF -5 dB)

Peak E-field in V/m

Grid 1 204.2 M3	Grid 2 216.4 M3	Grid 3 204.6 M3
Grid 4 206.5 M3	Grid 5 220.1 M3	Grid 6 208.7 M3
Grid 7 191.1 M3	Grid 8 203.2 M3	Grid 9 194.2 M3

Cursor:

Total = 220.1 V/m

E Category: M3

Location: -1, -3.5, 8.7 mm

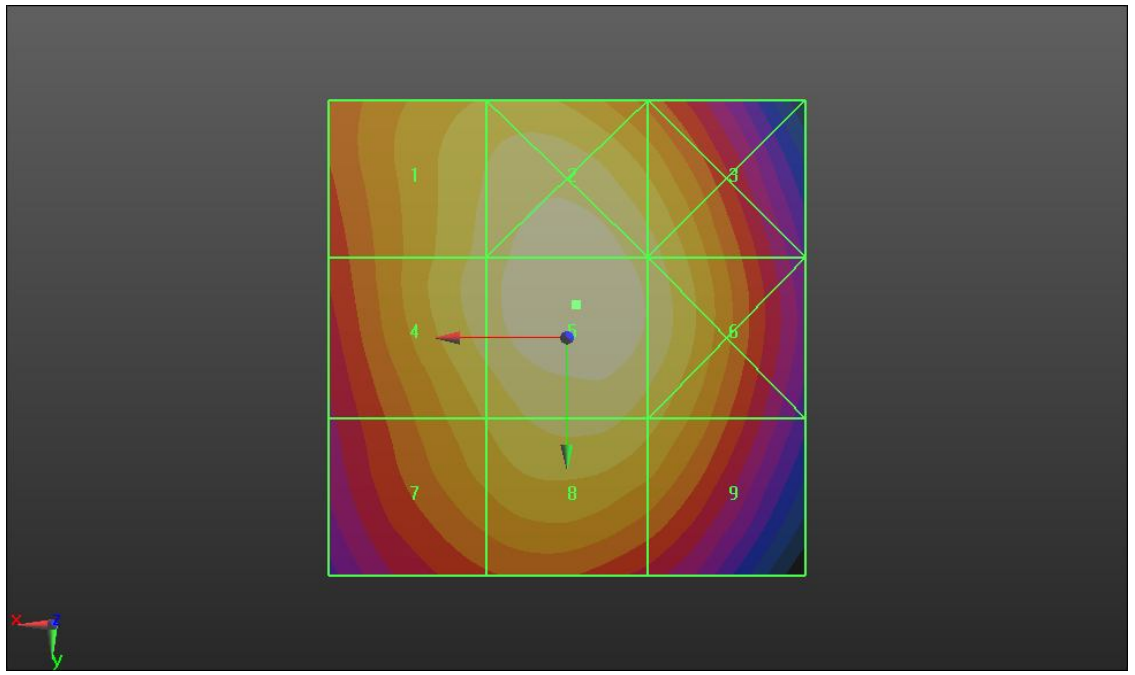
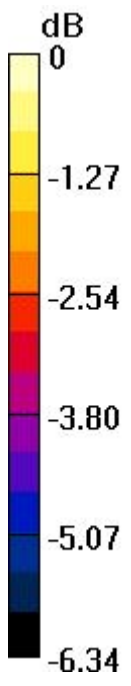

0 dB = 220.1V/m

01 RF_GSM850_GSM Voice_Ch128_H

DUT: 312310A

Communication System: Generic GSM; Frequency: 824.2 MHz; Duty Cycle: 1:8.3

Medium: Air Medium parameters used: $\sigma = 0$ mho/m, $\epsilon_r = 1$; $\rho = 0$ kg/m³

Ambient Temperature : 23.6 °C

DASY5 Configuration:

- Probe: H3DV6 - SN6342; ; Calibrated: 10.04.2012
- Electronics: DAE4 Sn1303; Calibrated: 22.11.2012
- Phantom: HAC Test Arch with AMCC; Type: SD HAC P01 BA;
- Measurement SW: DASY52, Version 52.8 (2); SEMCAD X Version 14.4.5 (3634)

Ch128/Hearing Aid Compatibility Test (101x101x1): Measurement grid: dx=5mm, dy=5mm

Maximum value of peak Total field = 0.424 A/m

Device Reference Point: 0, 0, -6.3 mm

Reference Value = 0.086 A/m; Power Drift = -0.07 dB

Hearing Aid Near-Field Category: M4 (AWF -5 dB)

Peak H-field in A/m

Grid 1 0.417 M4	Grid 2 0.275 M4	Grid 3 0.163 M4
Grid 4 0.418 M4	Grid 5 0.279 M4	Grid 6 0.158 M4
Grid 7 0.424 M4	Grid 8 0.283 M4	Grid 9 0.166 M4

Cursor:

Total = 0.424 A/m

H Category: M4

Location: 25, 17.5, 8.7 mm

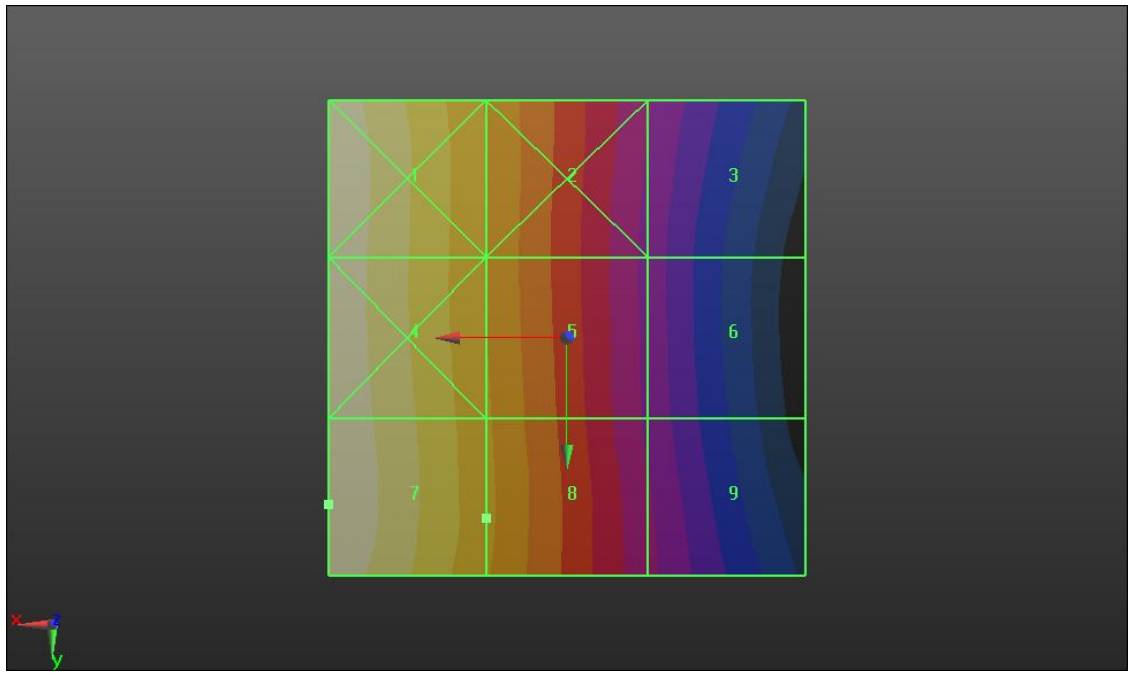
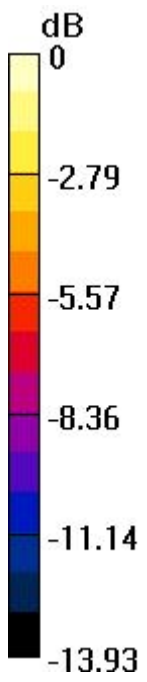

0 dB = 0.420A/m

02 RF_GSM850_GSM Voice_Ch189_E

DUT: 312310A

Communication System: Generic GSM; Frequency: 836.4 MHz; Duty Cycle: 1:8.3

Medium: Air Medium parameters used: $\sigma = 0$ mho/m, $\epsilon_r = 1$; $\rho = 0$ kg/m³

Ambient Temperature : 23.7 °C

DASY5 Configuration:

- Probe: ER3DV6 - SN2528; ConvF(1, 1, 1); Calibrated: 10.04.2012
- Electronics: DAE4 Sn1303; Calibrated: 22.11.2012
- Phantom: HAC Test Arch with AMCC; Type: SD HAC P01 BA;
- Measurement SW: DASY52, Version 52.8 (2); SEMCAD X Version 14.4.5 (3634)

Ch189/Hearing Aid Compatibility Test (101x101x1): Measurement grid: dx=5mm, dy=5mm

Maximum value of peak Total field = 235.1 V/m

Device Reference Point: 0, 0, -6.3 mm

Reference Value = 119.2 V/m; Power Drift = 0.04 dB

Hearing Aid Near-Field Category: M3 (AWF -5 dB)

Peak E-field in V/m

Grid 1 216.3 M3	Grid 2 230.7 M3	Grid 3 219.5 M3
Grid 4 218.8 M3	Grid 5 235.1 M3	Grid 6 223.8 M3
Grid 7 201.9 M3	Grid 8 216.3 M3	Grid 9 206.9 M3

Cursor:

Total = 235.1 V/m

E Category: M3

Location: -0.5, -4.5, 8.7 mm

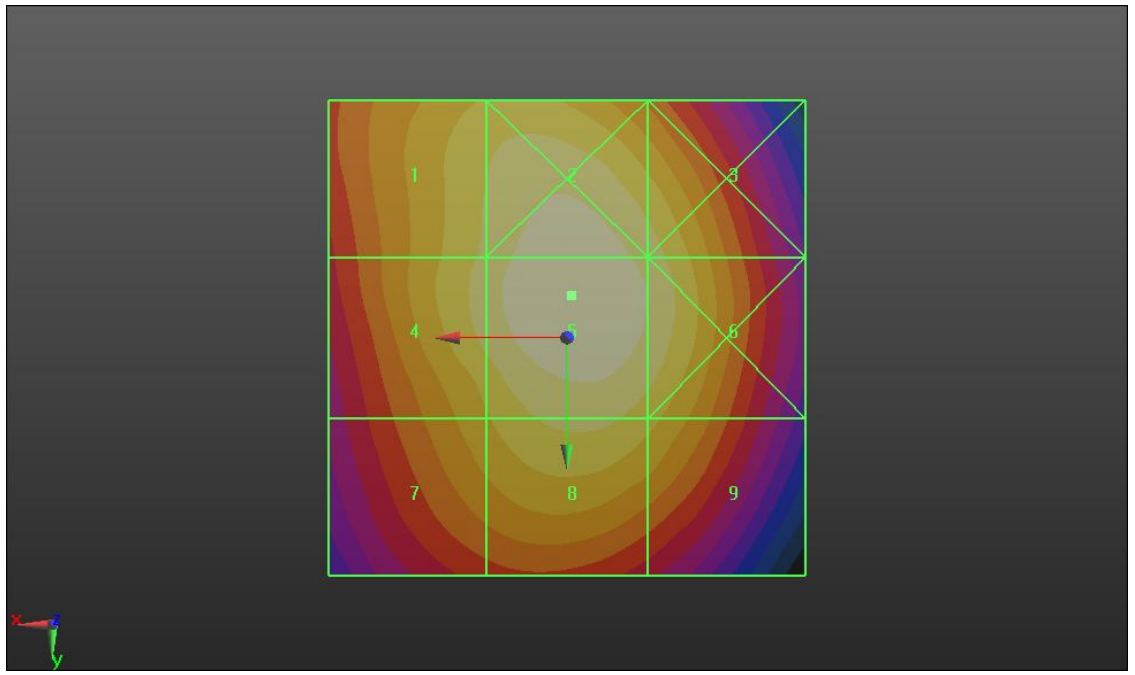
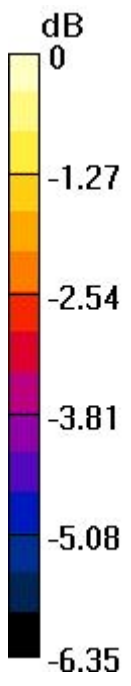

0 dB = 235.1V/m

02 RF_GSM850_GSM Voice_Ch189_H

DUT: 312310A

Communication System: Generic GSM; Frequency: 836.4 MHz; Duty Cycle: 1:8.3

Medium: Air Medium parameters used: $\sigma = 0$ mho/m, $\epsilon_r = 1$; $\rho = 0$ kg/m³

Ambient Temperature : 23.6 °C

DASY5 Configuration:

- Probe: H3DV6 - SN6342; ; Calibrated: 10.04.2012
- Electronics: DAE4 Sn1303; Calibrated: 22.11.2012
- Phantom: HAC Test Arch with AMCC; Type: SD HAC P01 BA;
- Measurement SW: DASY52, Version 52.8 (2); SEMCAD X Version 14.4.5 (3634)

Ch189/Hearing Aid Compatibility Test (101x101x1): Measurement grid: dx=5mm, dy=5mm

Maximum value of peak Total field = 0.458 A/m

Device Reference Point: 0, 0, -6.3 mm

Reference Value = 0.093 A/m; Power Drift = -0.01 dB

Hearing Aid Near-Field Category: M3 (AWF -5 dB)

Peak H-field in A/m

Grid 1 0.448 M4	Grid 2 0.296 M4	Grid 3 0.174 M4
Grid 4 0.454 M3	Grid 5 0.303 M4	Grid 6 0.172 M4
Grid 7 0.458 M3	Grid 8 0.308 M4	Grid 9 0.181 M4

Cursor:

Total = 0.458 A/m

H Category: M3

Location: 25, 15, 8.7 mm

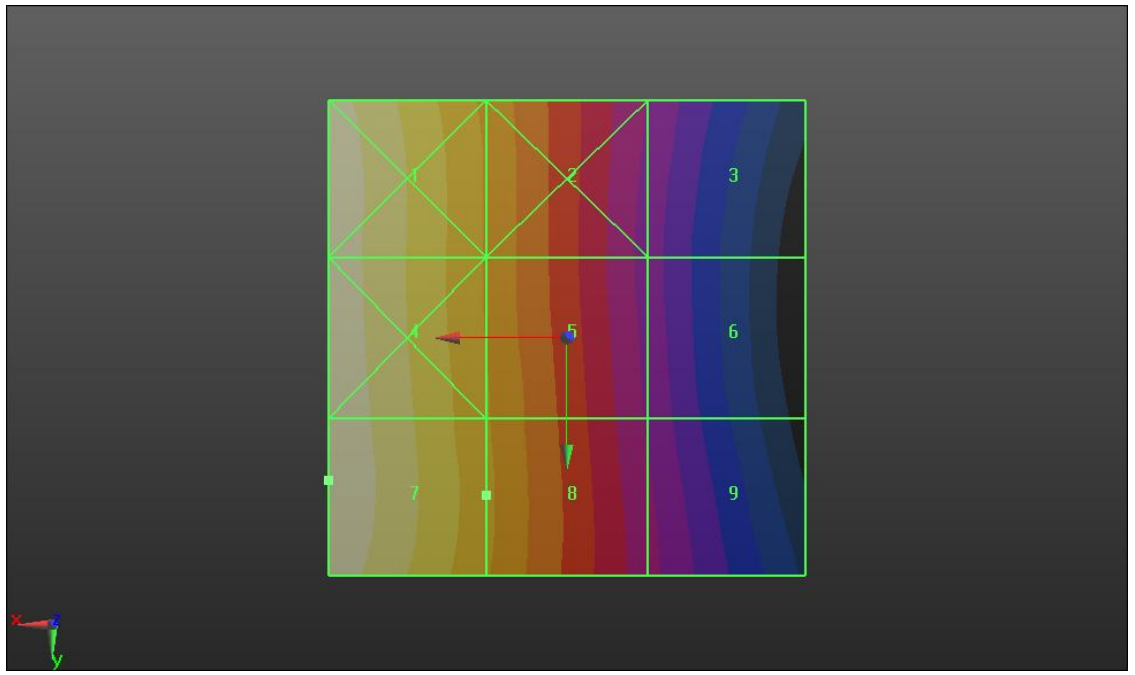
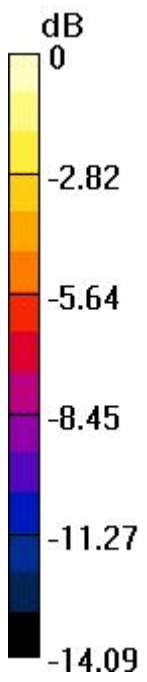

0 dB = 0.460A/m

03 RF_GSM850_GSM Voice_Ch251_E

DUT: 312310A

Communication System: Generic GSM; Frequency: 848.8 MHz; Duty Cycle: 1:8.3

Medium: Air Medium parameters used: $\sigma = 0$ mho/m, $\epsilon_r = 1$; $\rho = 0$ kg/m³

Ambient Temperature : 23.7 °C

DASY5 Configuration:

- Probe: ER3DV6 - SN2528; ConvF(1, 1, 1); Calibrated: 10.04.2012
- Electronics: DAE4 Sn1303; Calibrated: 22.11.2012
- Phantom: HAC Test Arch with AMCC; Type: SD HAC P01 BA;
- Measurement SW: DASY52, Version 52.8 (2); SEMCAD X Version 14.4.5 (3634)

Ch251/Hearing Aid Compatibility Test (101x101x1): Measurement grid: dx=5mm, dy=5mm

Maximum value of peak Total field = 235.8 V/m

Device Reference Point: 0, 0, -6.3 mm

Reference Value = 121.1 V/m; Power Drift = -0.06 dB

Hearing Aid Near-Field Category: M3 (AWF -5 dB)

Peak E-field in V/m

Grid 1 216.0 M3	Grid 2 231.8 M3	Grid 3 220.3 M3
Grid 4 219.4 M3	Grid 5 235.8 M3	Grid 6 224.8 M3
Grid 7 201.7 M3	Grid 8 216.5 M3	Grid 9 208.5 M3

Cursor:

Total = 235.8 V/m

E Category: M3

Location: -1, -4, 8.7 mm

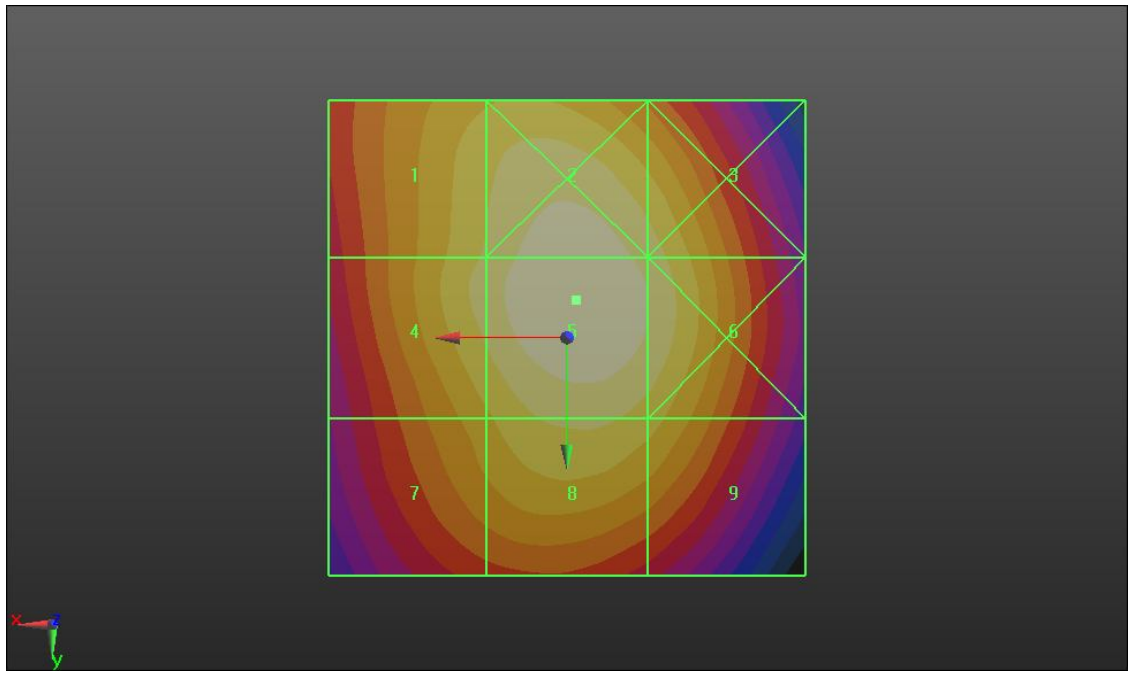
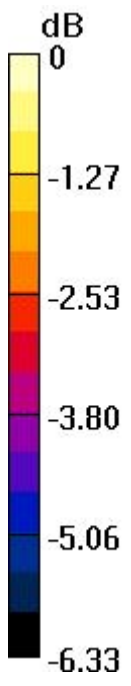

0 dB = 235.8V/m

03 RF_GSM850_GSM Voice_Ch251_H

DUT: 312310A

Communication System: Generic GSM; Frequency: 848.8 MHz; Duty Cycle: 1:8.3

Medium: Air Medium parameters used: $\sigma = 0$ mho/m, $\epsilon_r = 1$; $\rho = 0$ kg/m³

Ambient Temperature : 23.6 °C

DASY5 Configuration:

- Probe: H3DV6 - SN6342; ; Calibrated: 10.04.2012
- Electronics: DAE4 Sn1303; Calibrated: 22.11.2012
- Phantom: HAC Test Arch with AMCC; Type: SD HAC P01 BA;
- Measurement SW: DASY52, Version 52.8 (2); SEMCAD X Version 14.4.5 (3634)

Ch251/Hearing Aid Compatibility Test (101x101x1): Measurement grid: dx=5mm, dy=5mm

Maximum value of peak Total field = 0.479 A/m

Device Reference Point: 0, 0, -6.3 mm

Reference Value = 0.098 A/m; Power Drift = 0.03 dB

Hearing Aid Near-Field Category: M3 (AWF -5 dB)

Peak H-field in A/m

Grid 1 0.462 M3	Grid 2 0.309 M4	Grid 3 0.176 M4
Grid 4 0.474 M3	Grid 5 0.320 M4	Grid 6 0.182 M4
Grid 7 0.479 M3	Grid 8 0.324 M4	Grid 9 0.193 M4

Cursor:

Total = 0.479 A/m

H Category: M3

Location: 25, 15, 8.7 mm

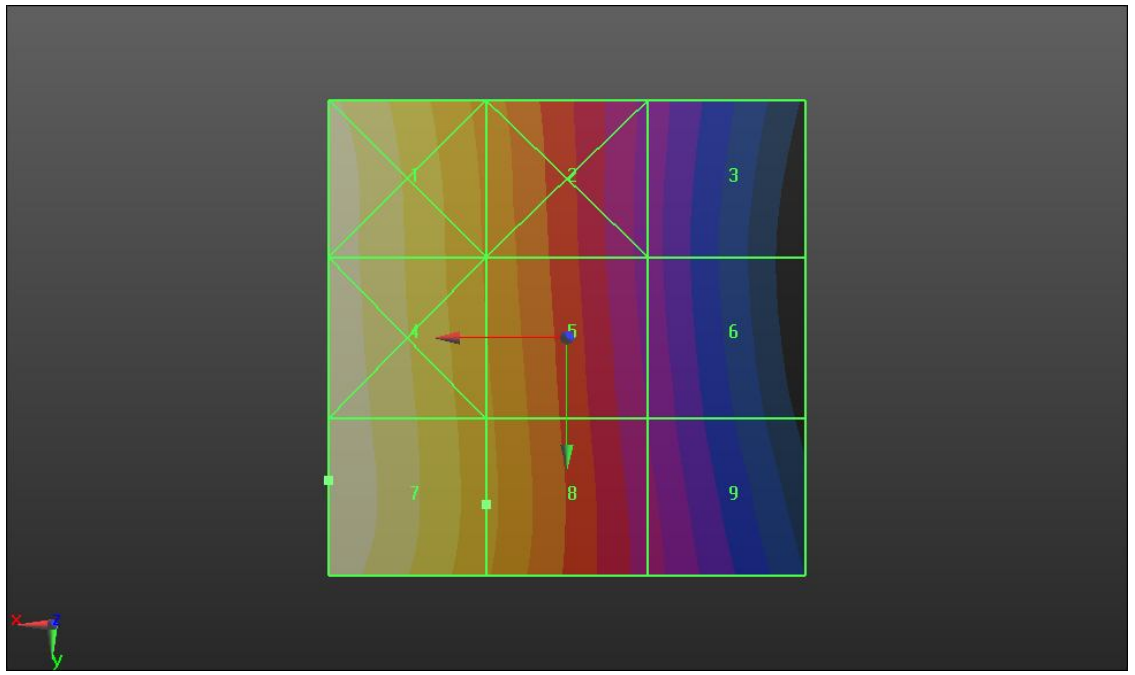
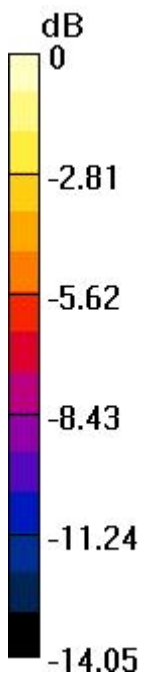

0 dB = 0.480A/m

04 RF_GSM1900_GSM Voice_Ch512_E

DUT: 312310A

Communication System: Generic GSM; Frequency: 1850.2 MHz; Duty Cycle: 1:8.3

Medium: Air Medium parameters used: $\sigma = 0$ mho/m, $\epsilon_r = 1$; $\rho = 0$ kg/m³

Ambient Temperature : 23.7 °C

DASY5 Configuration:

- Probe: ER3DV6 - SN2528; ConvF(1, 1, 1); Calibrated: 10.04.2012
- Electronics: DAE4 Sn1303; Calibrated: 22.11.2012
- Phantom: HAC Test Arch with AMCC; Type: SD HAC P01 BA;
- Measurement SW: DASY52, Version 52.8 (2); SEMCAD X Version 14.4.5 (3634)

Ch512/Hearing Aid Compatibility Test (101x101x1): Measurement grid: dx=5mm, dy=5mm

Maximum value of peak Total field = 77.241 V/m

Device Reference Point: 0, 0, -6.3 mm

Reference Value = 15.815 V/m; Power Drift = -0.10 dB

Hearing Aid Near-Field Category: M3 (AWF -5 dB)

Peak E-field in V/m

Grid 1 76.306 M3	Grid 2 77.241 M3	Grid 3 71.724 M3
Grid 4 53.214 M3	Grid 5 60.264 M3	Grid 6 60.879 M3
Grid 7 87.275 M2	Grid 8 77.205 M3	Grid 9 62.141 M3

Cursor:

Total = 87.276 V/m

E Category: M2

Location: 25, 25, 8.7 mm

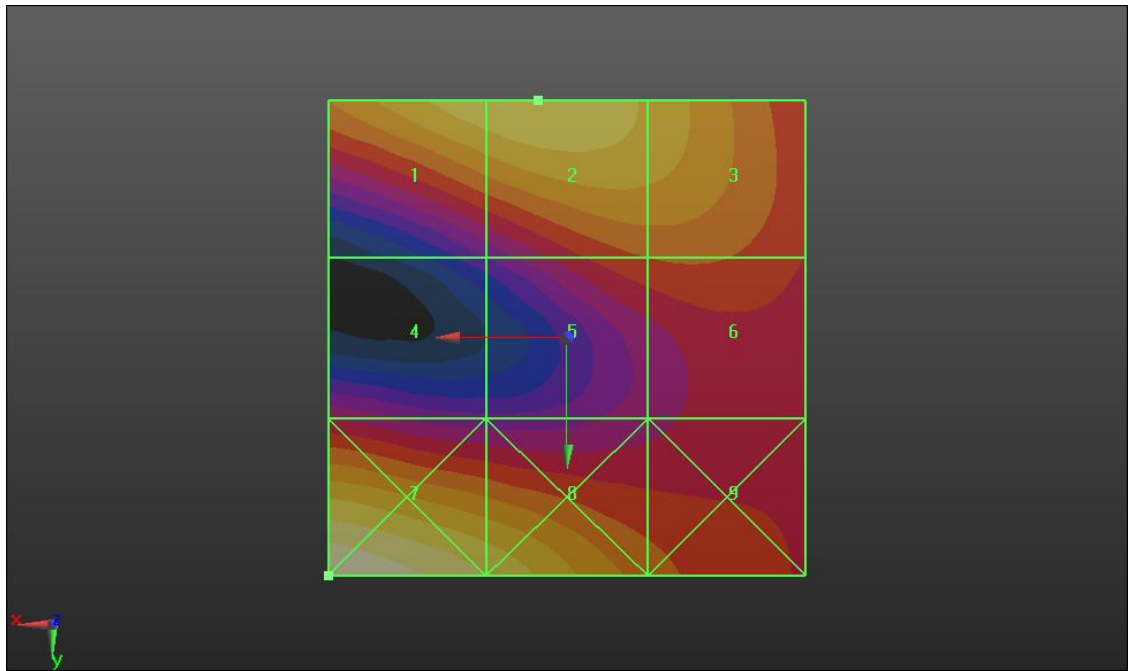
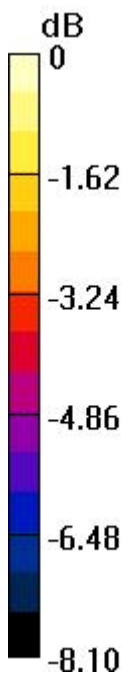

0 dB = 87.280V/m

04 RF_GSM1900_GSM Voice_Ch512_H

DUT: 312310A

Communication System: Generic GSM; Frequency: 1850.2 MHz; Duty Cycle: 1:8.3

Medium: Air Medium parameters used: $\sigma = 0$ mho/m, $\epsilon_r = 1$; $\rho = 0$ kg/m³

Ambient Temperature : 23.6 °C

DASY5 Configuration:

- Probe: H3DV6 - SN6342; ; Calibrated: 10.04.2012
- Electronics: DAE4 Sn1303; Calibrated: 22.11.2012
- Phantom: HAC Test Arch with AMCC; Type: SD HAC P01 BA;
- Measurement SW: DASY52, Version 52.8 (2); SEMCAD X Version 14.4.5 (3634)

Ch512/Hearing Aid Compatibility Test (101x101x1): Measurement grid: dx=5mm, dy=5mm

Maximum value of peak Total field = 0.207 A/m

Device Reference Point: 0, 0, -6.3 mm

Reference Value = 0.088 A/m; Power Drift = -0.07 dB

Hearing Aid Near-Field Category: M3 (AWF -5 dB)

Peak H-field in A/m

Grid 1 0.192 M3	Grid 2 0.169 M3	Grid 3 0.166 M3
Grid 4 0.201 M3	Grid 5 0.207 M3	Grid 6 0.202 M3
Grid 7 0.229 M3	Grid 8 0.210 M3	Grid 9 0.203 M3

Cursor:

Total = 0.229 A/m

H Category: M3

Location: 25, 25, 8.7 mm

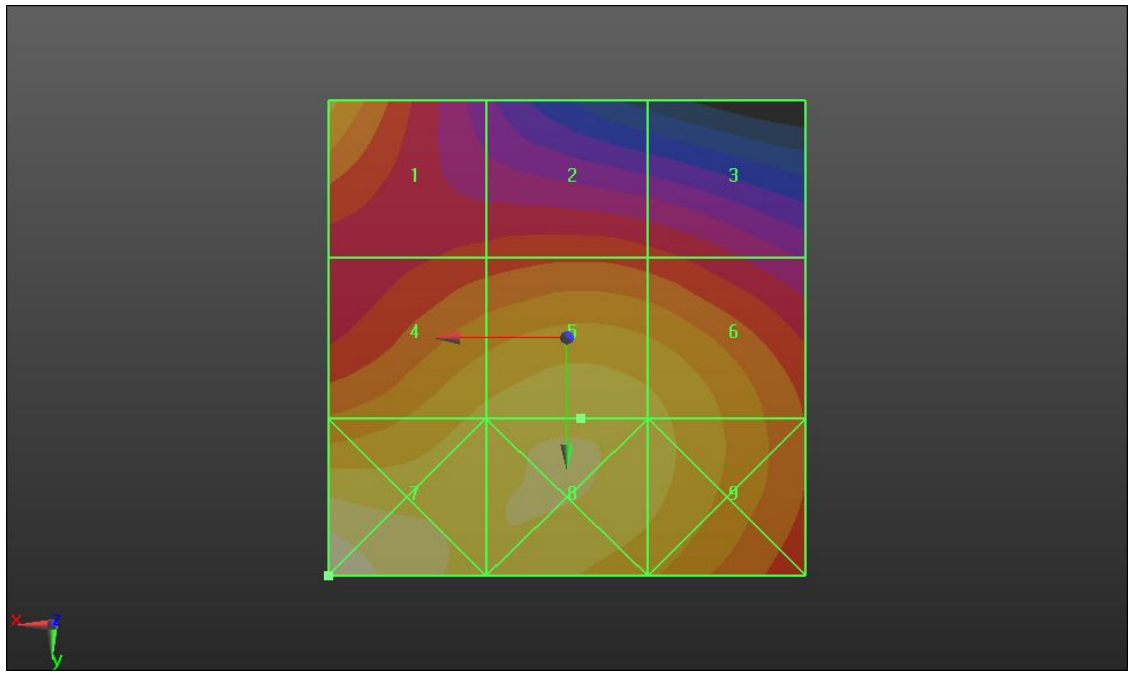
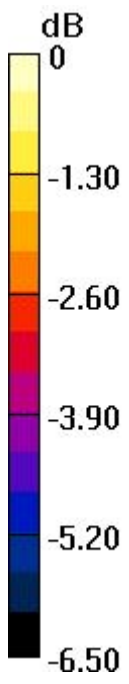

0 dB = 0.230A/m

05 RF_GSM1900_GSM Voice_Ch661_E

DUT: 312310A

Communication System: Generic GSM; Frequency: 1880 MHz; Duty Cycle: 1:8.3

Medium: Air Medium parameters used: $\sigma = 0$ mho/m, $\epsilon_r = 1$; $\rho = 0$ kg/m³

Ambient Temperature : 23.7 °C

DASY5 Configuration:

- Probe: ER3DV6 - SN2528; ConvF(1, 1, 1); Calibrated: 10.04.2012
- Electronics: DAE4 Sn1303; Calibrated: 22.11.2012
- Phantom: HAC Test Arch with AMCC; Type: SD HAC P01 BA;
- Measurement SW: DASY52, Version 52.8 (2); SEMCAD X Version 14.4.5 (3634)

Ch661/Hearing Aid Compatibility Test (101x101x1): Measurement grid: dx=5mm, dy=5mm

Maximum value of peak Total field = 73.357 V/m

Device Reference Point: 0, 0, -6.3 mm

Reference Value = 15.483 V/m; Power Drift = 0.04 dB

Hearing Aid Near-Field Category: M3 (AWF -5 dB)

Peak E-field in V/m

Grid 1 71.939 M3	Grid 2 73.357 M3	Grid 3 68.641 M3
Grid 4 51.989 M3	Grid 5 56.927 M3	Grid 6 57.607 M3
Grid 7 86.388 M2	Grid 8 78.145 M3	Grid 9 62.643 M3

Cursor:

Total = 86.388 V/m

E Category: M2

Location: 25, 25, 8.7 mm

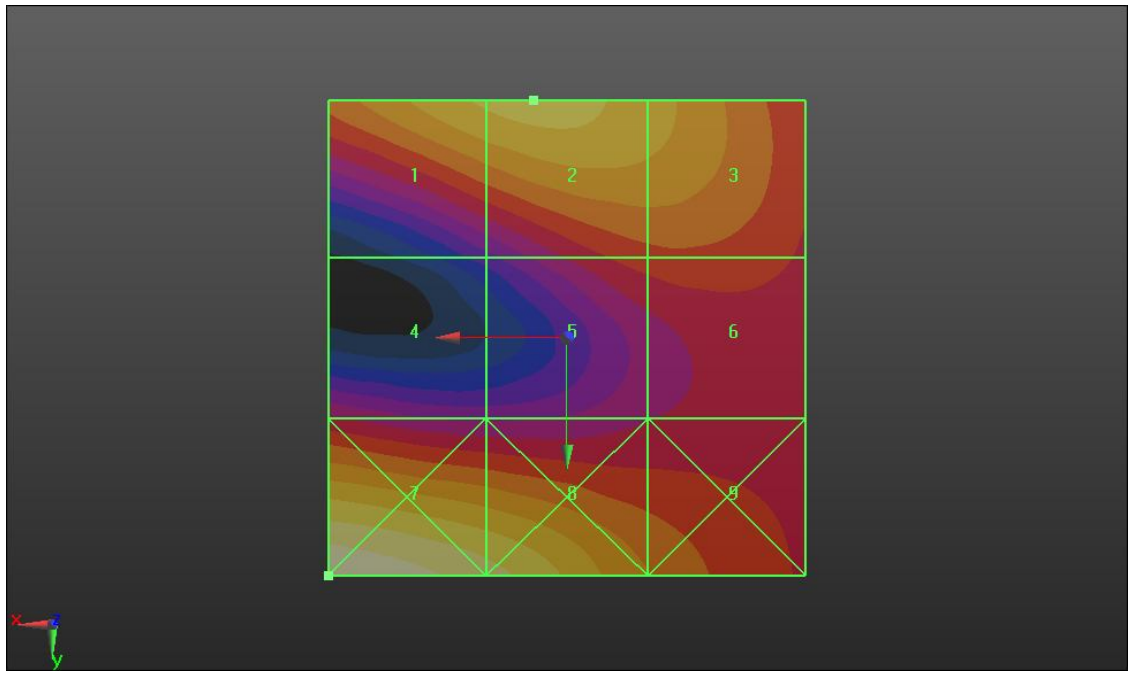
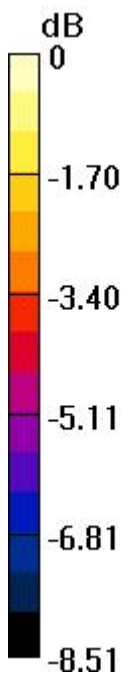

0 dB = 86.390V/m

05 RF_GSM1900_GSM Voice_Ch661_H

DUT: 312310A

Communication System: Generic GSM; Frequency: 1880 MHz;Duty Cycle: 1:8.3

Medium: Air Medium parameters used: $\sigma = 0$ mho/m, $\epsilon_r = 1$; $\rho = 0$ kg/m³

Ambient Temperature : 23.6 °C

DASY5 Configuration:

- Probe: H3DV6 - SN6342; ; Calibrated: 10.04.2012
- Electronics: DAE4 Sn1303; Calibrated: 22.11.2012
- Phantom: HAC Test Arch with AMCC; Type: SD HAC P01 BA;
- Measurement SW: DASY52, Version 52.8 (2); SEMCAD X Version 14.4.5 (3634)

Ch661/Hearing Aid Compatibility Test (101x101x1): Measurement grid: dx=5mm, dy=5mm

Maximum value of peak Total field = 0.201 A/m

Device Reference Point: 0, 0, -6.3 mm

Reference Value = 0.086 A/m; Power Drift = -0.04 dB

Hearing Aid Near-Field Category: M3 (AWF -5 dB)

Peak H-field in A/m

Grid 1 0.175 M3	Grid 2 0.165 M3	Grid 3 0.164 M3
Grid 4 0.193 M3	Grid 5 0.201 M3	Grid 6 0.199 M3
Grid 7 0.228 M3	Grid 8 0.203 M3	Grid 9 0.201 M3

Cursor:

Total = 0.228 A/m

H Category: M3

Location: 25, 25, 8.7 mm

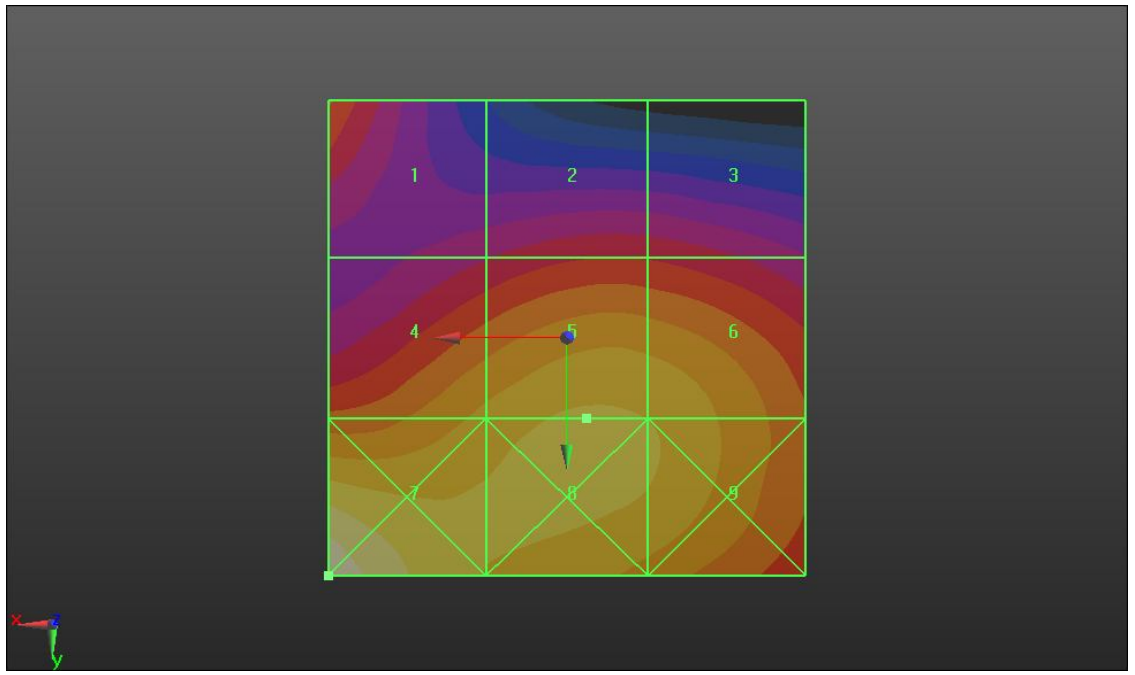
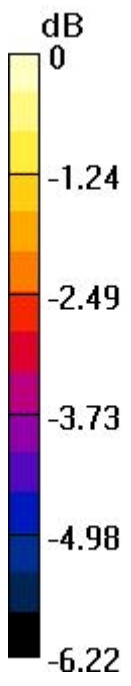

0 dB = 0.230A/m

06 RF_GSM1900_GSM Voice_Ch810_E

DUT: 312310A

Communication System: Generic GSM; Frequency: 1909.8 MHz; Duty Cycle: 1:8.3

Medium: Air Medium parameters used: $\sigma = 0$ mho/m, $\epsilon_r = 1$; $\rho = 0$ kg/m³

Ambient Temperature : 23.7 °C

DASY5 Configuration:

- Probe: ER3DV6 - SN2528; ConvF(1, 1, 1); Calibrated: 10.04.2012
- Electronics: DAE4 Sn1303; Calibrated: 22.11.2012
- Phantom: HAC Test Arch with AMCC; Type: SD HAC P01 BA;
- Measurement SW: DASY52, Version 52.8 (2); SEMCAD X Version 14.4.5 (3634)

Ch810/Hearing Aid Compatibility Test (101x101x1): Measurement grid: dx=5mm, dy=5mm

Maximum value of peak Total field = 70.158 V/m

Device Reference Point: 0, 0, -6.3 mm

Reference Value = 15.402 V/m; Power Drift = -0.12 dB

Hearing Aid Near-Field Category: M3 (AWF -5 dB)

Peak E-field in V/m

Grid 1 69.597 M3	Grid 2 70.158 M3	Grid 3 63.337 M3
Grid 4 56.940 M3	Grid 5 52.467 M3	Grid 6 52.484 M3
Grid 7 90.814 M2	Grid 8 82.818 M3	Grid 9 65.519 M3

Cursor:

Total = 90.814 V/m

E Category: M2

Location: 25, 25, 8.7 mm

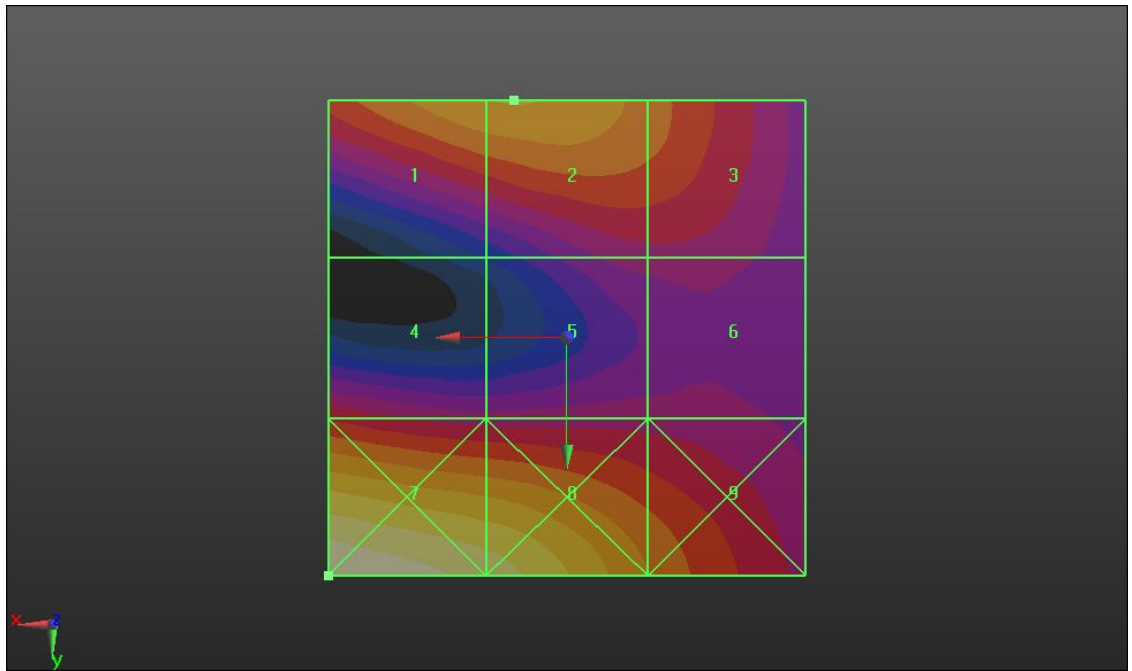
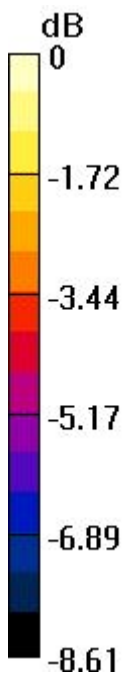

0 dB = 90.810V/m

06 RF_GSM1900_GSM Voice_Ch810_H

DUT: 312310A

Communication System: Generic GSM; Frequency: 1909.8 MHz; Duty Cycle: 1:8.3

Medium: Air Medium parameters used: $\sigma = 0$ mho/m, $\epsilon_r = 1$; $\rho = 0$ kg/m³

Ambient Temperature : 23.6 °C

DASY5 Configuration:

- Probe: H3DV6 - SN6342; ; Calibrated: 10.04.2012
- Electronics: DAE4 Sn1303; Calibrated: 22.11.2012
- Phantom: HAC Test Arch with AMCC; Type: SD HAC P01 BA;
- Measurement SW: DASY52, Version 52.8 (2); SEMCAD X Version 14.4.5 (3634)

Ch810/Hearing Aid Compatibility Test (101x101x1): Measurement grid: dx=5mm, dy=5mm

Maximum value of peak Total field = 0.204 A/m

Device Reference Point: 0, 0, -6.3 mm

Reference Value = 0.086 A/m; Power Drift = 0.02 dB

Hearing Aid Near-Field Category: M3 (AWF -5 dB)

Peak H-field in A/m

Grid 1 0.172 M3	Grid 2 0.167 M3	Grid 3 0.164 M3
Grid 4 0.201 M3	Grid 5 0.204 M3	Grid 6 0.198 M3
Grid 7 0.255 M2	Grid 8 0.212 M3	Grid 9 0.199 M3

Cursor:

Total = 0.255 A/m

H Category: M2

Location: 25, 25, 8.7 mm

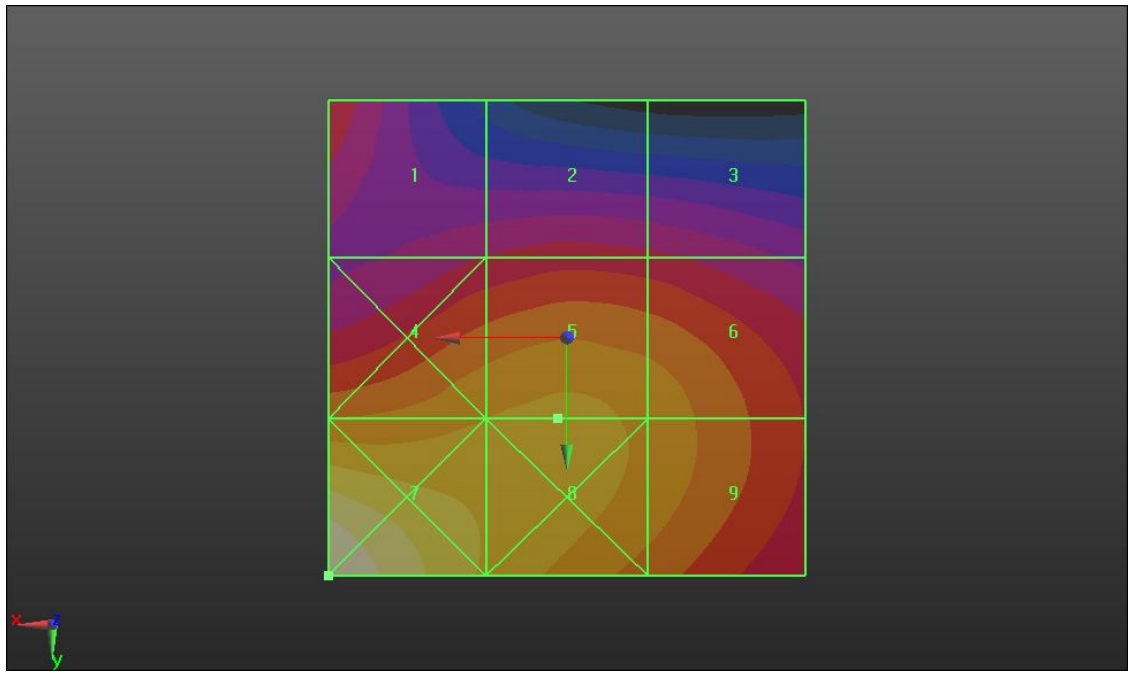
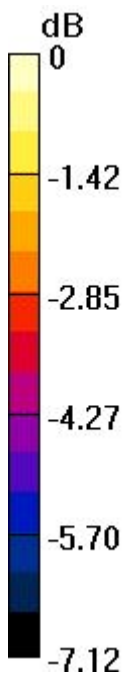

0 dB = 0.250A/m

07 RF_WCDMA Band V_RMC 12.2Kbps_Ch4132_E

DUT: 312310A

Communication System: UMTS; Frequency: 826.4 MHz; Duty Cycle: 1:1

Medium: Air Medium parameters used: $\sigma = 0$ mho/m, $\epsilon_r = 1$; $\rho = 0$ kg/m³

Ambient Temperature : 23.7 °C

DASY5 Configuration:

- Probe: ER3DV6 - SN2528; ConvF(1, 1, 1); Calibrated: 10.04.2012
- Electronics: DAE4 Sn1303; Calibrated: 22.11.2012
- Phantom: HAC Test Arch with AMCC; Type: SD HAC P01 BA;
- Measurement SW: DASY52, Version 52.8 (2); SEMCAD X Version 14.4.5 (3634)

Ch4132/Hearing Aid Compatibility Test (101x101x1): Measurement grid: dx=5mm, dy=5mm

Maximum value of peak Total field = 84.592 V/m

Device Reference Point: 0, 0, -6.3 mm

Reference Value = 111.0 V/m; Power Drift = -0.02 dB

Hearing Aid Near-Field Category: M4 (AWF 0 dB)

Peak E-field in V/m

Grid 1 77.829 M4	Grid 2 83.470 M4	Grid 3 79.993 M4
Grid 4 78.584 M4	Grid 5 84.592 M4	Grid 6 81.435 M4
Grid 7 72.845 M4	Grid 8 78.344 M4	Grid 9 75.742 M4

Cursor:

Total = 84.592 V/m

E Category: M4

Location: -1.5, -4.5, 8.7 mm

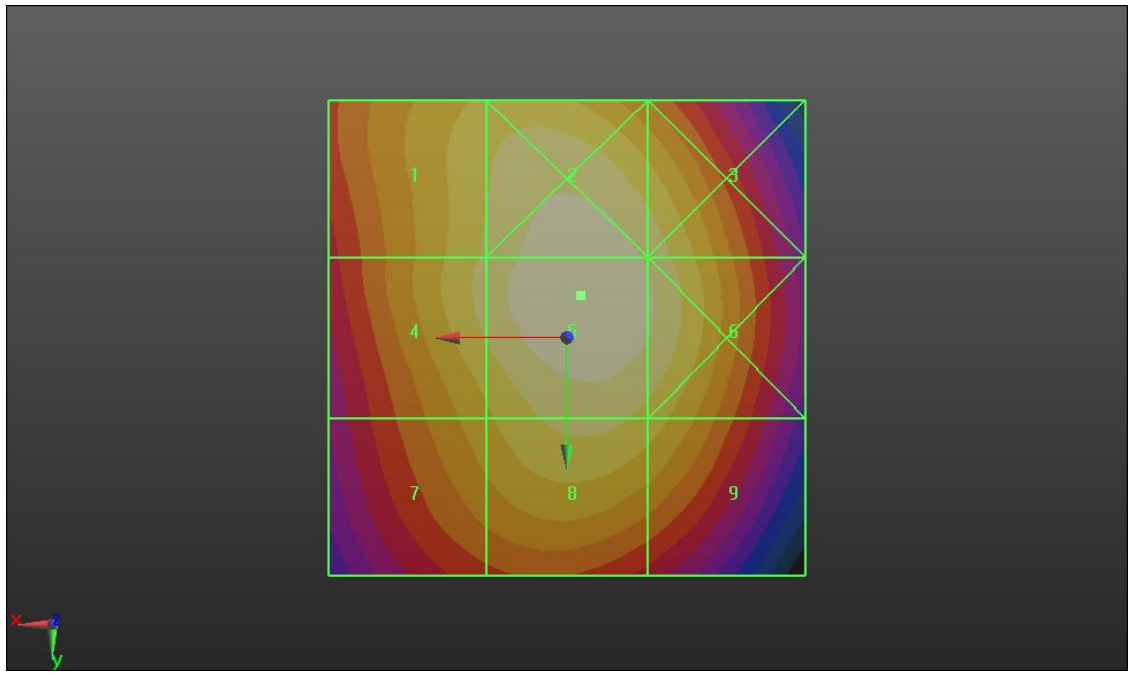
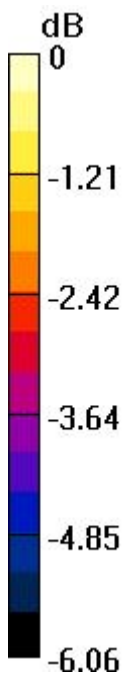

0 dB = 84.590V/m

07 RF_WCDMA Band V_RMC 12.2Kbps_Ch4132_H

DUT: 312310A

Communication System: UMTS; Frequency: 826.4 MHz; Duty Cycle: 1:1

Medium: Air Medium parameters used: $\sigma = 0$ mho/m, $\epsilon_r = 1$; $\rho = 0$ kg/m³

Ambient Temperature : 23.6 °C

DASY5 Configuration:

- Probe: H3DV6 - SN6342; ; Calibrated: 10.04.2012
- Electronics: DAE4 Sn1303; Calibrated: 22.11.2012
- Phantom: HAC Test Arch with AMCC; Type: SD HAC P01 BA;
- Measurement SW: DASY52, Version 52.8 (2); SEMCAD X Version 14.4.5 (3634)

Ch4132/Hearing Aid Compatibility Test (101x101x1): Measurement grid: dx=5mm, dy=5mm

Maximum value of peak Total field = 0.140 A/m

Device Reference Point: 0, 0, -6.3 mm

Reference Value = 0.093 A/m; Power Drift = 0.03 dB

Hearing Aid Near-Field Category: M4 (AWF 0 dB)

Peak H-field in A/m

Grid 1 0.137 M4	Grid 2 0.094 M4	Grid 3 0.057 M4
Grid 4 0.137 M4	Grid 5 0.096 M4	Grid 6 0.056 M4
Grid 7 0.140 M4	Grid 8 0.098 M4	Grid 9 0.060 M4

Cursor:

Total = 0.140 A/m

H Category: M4

Location: 25, 18, 8.7 mm

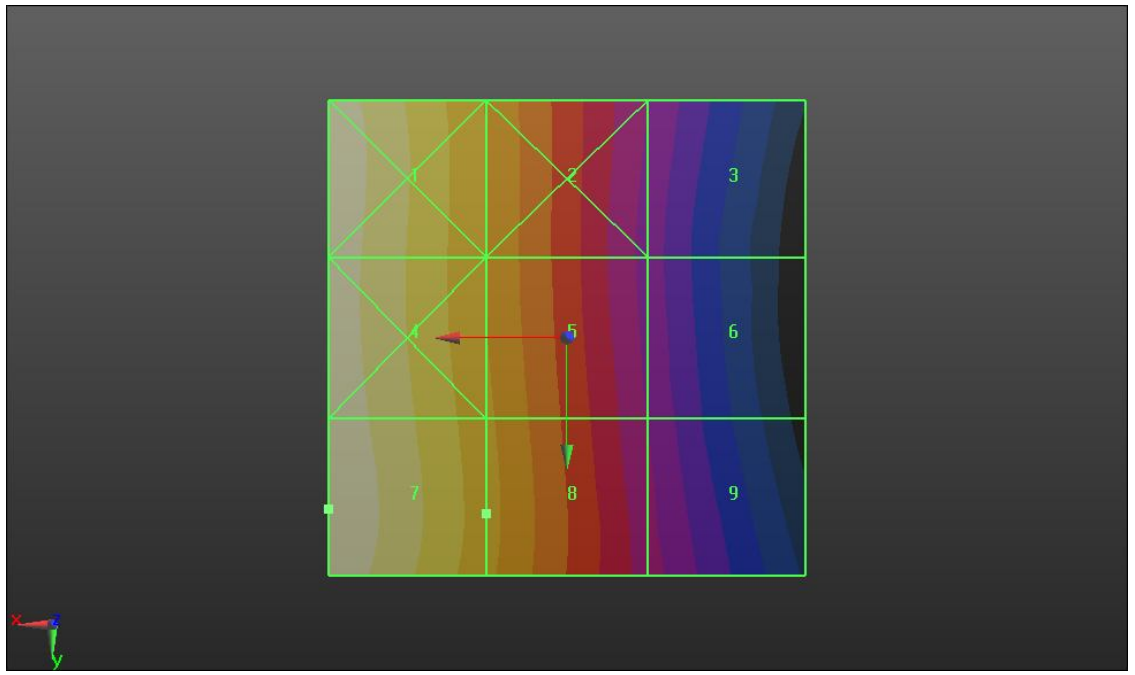
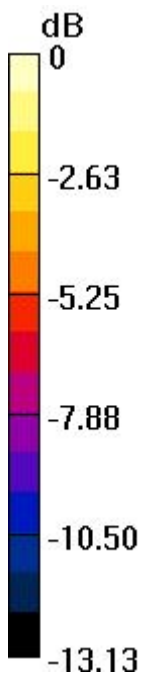

0 dB = 0.140A/m

08 RF_WCDMA Band V_RMC 12.2Kbps_Ch4182_E

DUT: 312310A

Communication System: UMTS; Frequency: 836.4 MHz; Duty Cycle: 1:1

Medium: Air Medium parameters used: $\sigma = 0$ mho/m, $\epsilon_r = 1$; $\rho = 0$ kg/m³

Ambient Temperature : 23.7 °C

DASY5 Configuration:

- Probe: ER3DV6 - SN2528; ConvF(1, 1, 1); Calibrated: 10.04.2012
- Electronics: DAE4 Sn1303; Calibrated: 22.11.2012
- Phantom: HAC Test Arch with AMCC; Type: SD HAC P01 BA;
- Measurement SW: DASY52, Version 52.8 (2); SEMCAD X Version 14.4.5 (3634)

Ch4182/Hearing Aid Compatibility Test (101x101x1): Measurement grid: dx=5mm, dy=5mm

Maximum value of peak Total field = 90.319 V/m

Device Reference Point: 0, 0, -6.3 mm

Reference Value = 118.5 V/m; Power Drift = 0.01 dB

Hearing Aid Near-Field Category: M4 (AWF 0 dB)

Peak E-field in V/m

Grid 1 82.930 M4	Grid 2 89.117 M4	Grid 3 85.810 M4
Grid 4 83.680 M4	Grid 5 90.319 M4	Grid 6 87.166 M4
Grid 7 77.350 M4	Grid 8 83.399 M4	Grid 9 81.034 M4

Cursor:

Total = 90.319 V/m

E Category: M4

Location: -2.5, -4, 8.7 mm

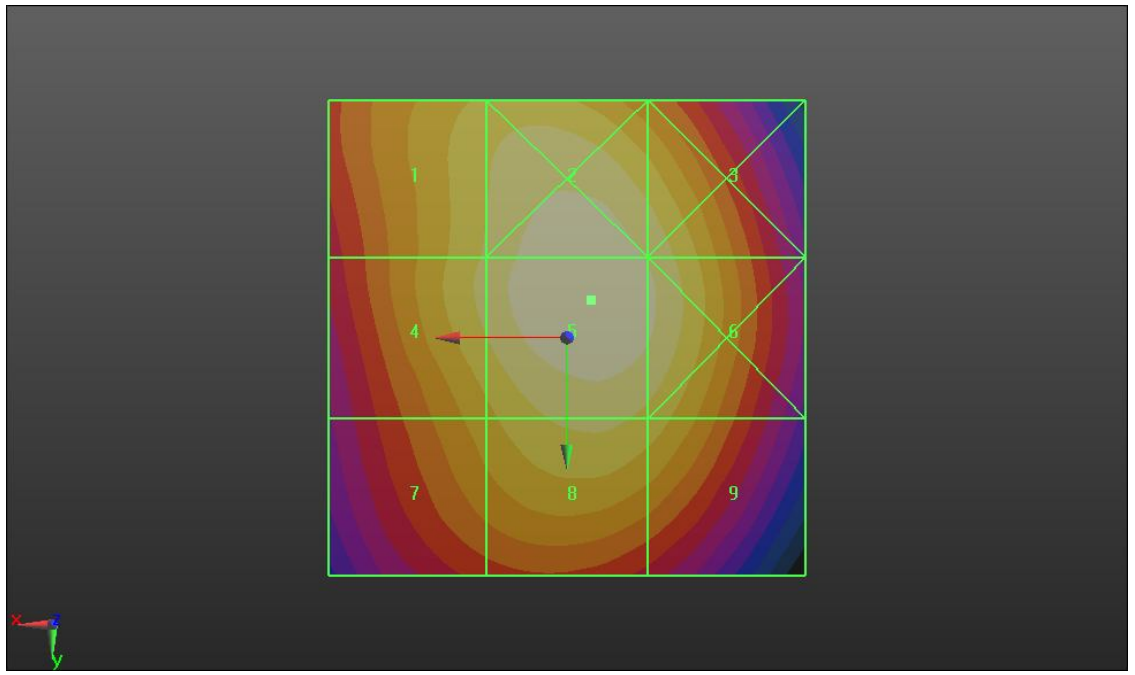
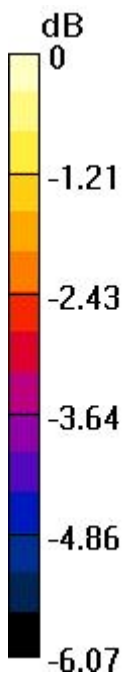

0 dB = 90.320V/m

08 RF_WCDMA Band V_RMC 12.2Kbps_Ch4182_H

DUT: 312310A

Communication System: UMTS; Frequency: 836.4 MHz; Duty Cycle: 1:1

Medium: Air Medium parameters used: $\sigma = 0$ mho/m, $\epsilon_r = 1$; $\rho = 0$ kg/m³

Ambient Temperature : 23.6 °C

DASY5 Configuration:

- Probe: H3DV6 - SN6342; ; Calibrated: 10.04.2012
- Electronics: DAE4 Sn1303; Calibrated: 22.11.2012
- Phantom: HAC Test Arch with AMCC; Type: SD HAC P01 BA;
- Measurement SW: DASY52, Version 52.8 (2); SEMCAD X Version 14.4.5 (3634)

Ch4182/Hearing Aid Compatibility Test (101x101x1): Measurement grid: dx=5mm, dy=5mm

Maximum value of peak Total field = 0.152 A/m

Device Reference Point: 0, 0, -6.3 mm

Reference Value = 0.101 A/m; Power Drift = 0.07 dB

Hearing Aid Near-Field Category: M4 (AWF 0 dB)

Peak H-field in A/m

Grid 1 0.147 M4	Grid 2 0.101 M4	Grid 3 0.061 M4
Grid 4 0.149 M4	Grid 5 0.105 M4	Grid 6 0.062 M4
Grid 7 0.152 M4	Grid 8 0.107 M4	Grid 9 0.065 M4

Cursor:

Total = 0.152 A/m

H Category: M4

Location: 25, 18, 8.7 mm

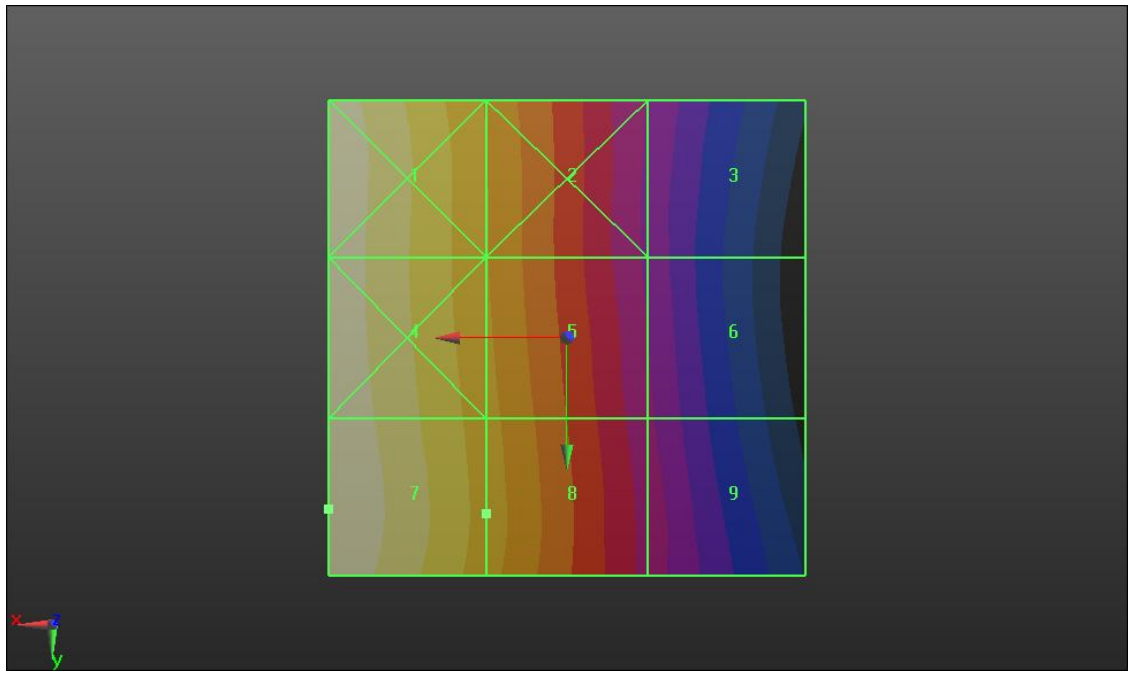
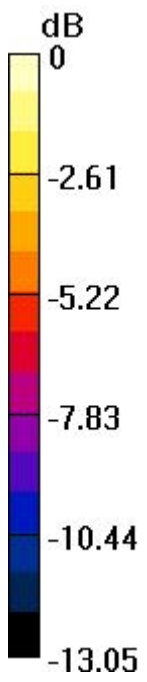

0 dB = 0.150A/m

09 RF_WCDMA Band V_RMC 12.2Kbps_Ch4233_E

DUT: 312310A

Communication System: UMTS; Frequency: 846.6 MHz; Duty Cycle: 1:1

Medium: Air Medium parameters used: $\sigma = 0$ mho/m, $\epsilon_r = 1$; $\rho = 0$ kg/m³

Ambient Temperature : 23.7 °C

DASY5 Configuration:

- Probe: ER3DV6 - SN2528; ConvF(1, 1, 1); Calibrated: 10.04.2012
- Electronics: DAE4 Sn1303; Calibrated: 22.11.2012
- Phantom: HAC Test Arch with AMCC; Type: SD HAC P01 BA;
- Measurement SW: DASY52, Version 52.8 (2); SEMCAD X Version 14.4.5 (3634)

Ch4233/Hearing Aid Compatibility Test (101x101x1): Measurement grid: dx=5mm, dy=5mm

Maximum value of peak Total field = 87.978 V/m

Device Reference Point: 0, 0, -6.3 mm

Reference Value = 115.9 V/m; Power Drift = -0.04 dB

Hearing Aid Near-Field Category: M4 (AWF 0 dB)

Peak E-field in V/m

Grid 1 80.473 M4	Grid 2 86.900 M4	Grid 3 83.796 M4
Grid 4 81.283 M4	Grid 5 87.978 M4	Grid 6 85.109 M4
Grid 7 75.219 M4	Grid 8 81.520 M4	Grid 9 79.052 M4

Cursor:

Total = 87.978 V/m

E Category: M4

Location: -2, -4.5, 8.7 mm

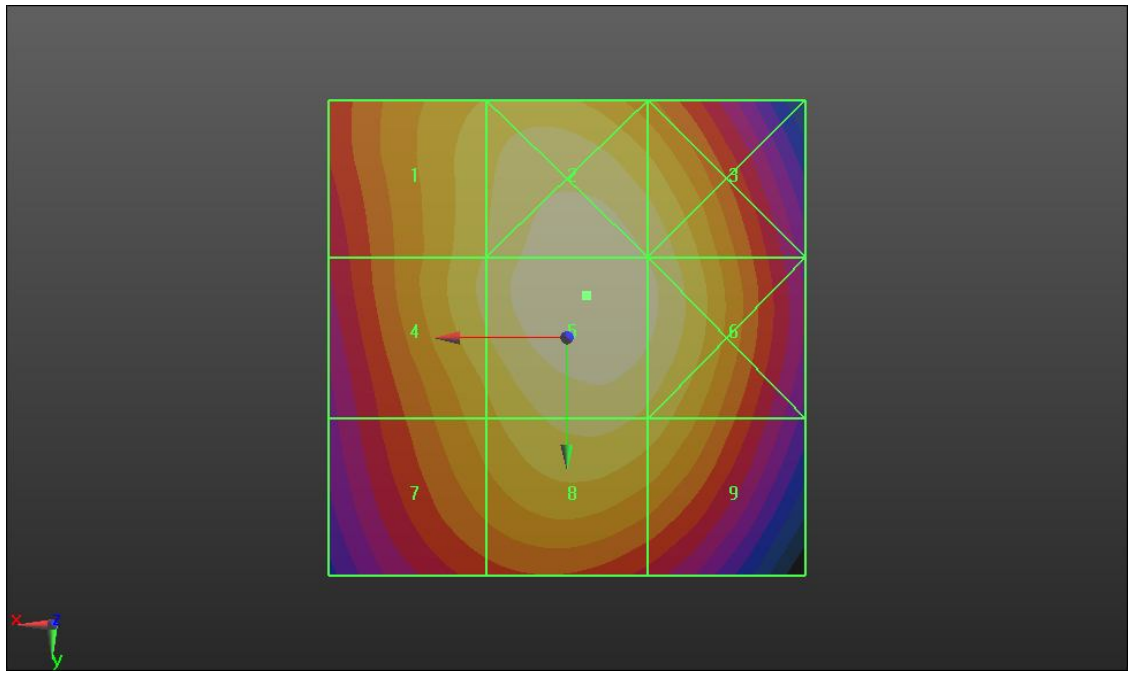
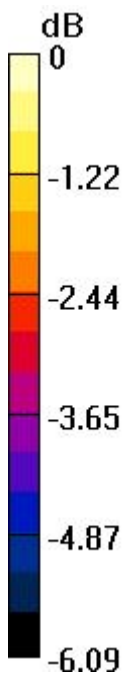

0 dB = 87.980V/m

09 RF_WCDMA Band V_RMC 12.2Kbps_Ch4233_H

DUT: 312310A

Communication System: UMTS; Frequency: 846.6 MHz; Duty Cycle: 1:1

Medium: Air Medium parameters used: $\sigma = 0$ mho/m, $\epsilon_r = 1$; $\rho = 0$ kg/m³

Ambient Temperature : 23.6 °C

DASY5 Configuration:

- Probe: H3DV6 - SN6342; ; Calibrated: 10.04.2012
- Electronics: DAE4 Sn1303; Calibrated: 22.11.2012
- Phantom: HAC Test Arch with AMCC; Type: SD HAC P01 BA;
- Measurement SW: DASY52, Version 52.8 (2); SEMCAD X Version 14.4.5 (3634)

Ch4233/Hearing Aid Compatibility Test (101x101x1): Measurement grid: dx=5mm, dy=5mm

Maximum value of peak Total field = 0.152 A/m

Device Reference Point: 0, 0, -6.3 mm

Reference Value = 0.103 A/m; Power Drift = -0.01 dB

Hearing Aid Near-Field Category: M4 (AWF 0 dB)

Peak H-field in A/m

Grid 1 0.147 M4	Grid 2 0.102 M4	Grid 3 0.060 M4
Grid 4 0.150 M4	Grid 5 0.106 M4	Grid 6 0.064 M4
Grid 7 0.152 M4	Grid 8 0.108 M4	Grid 9 0.066 M4

Cursor:

Total = 0.152 A/m

H Category: M4

Location: 25, 18.5, 8.7 mm

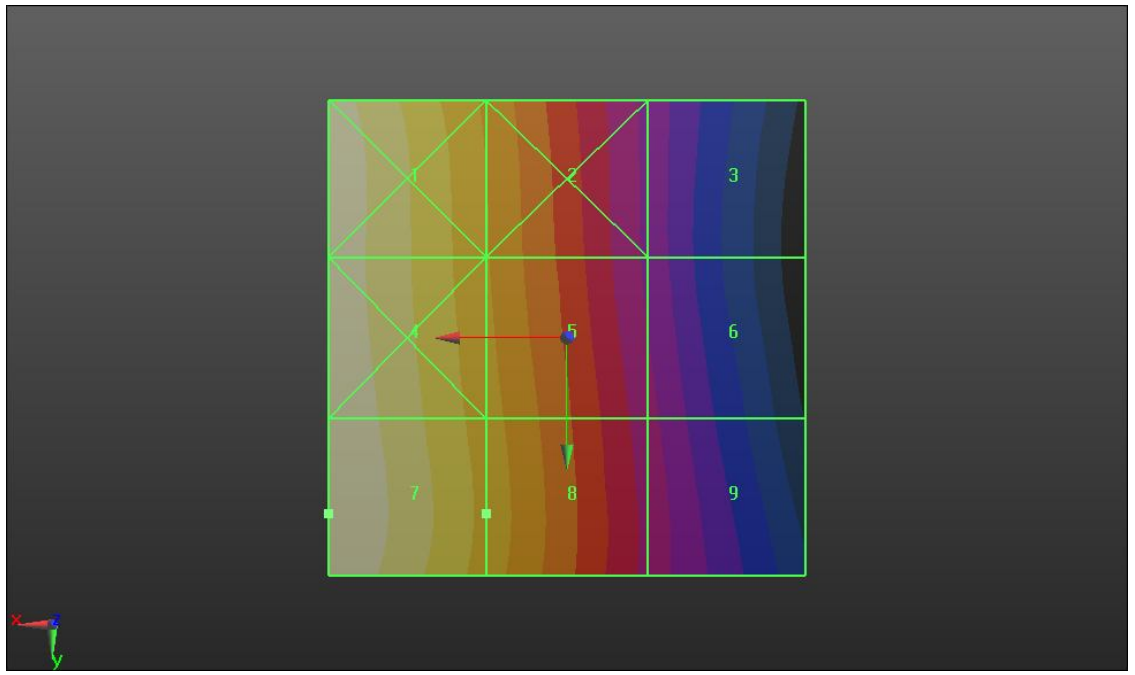
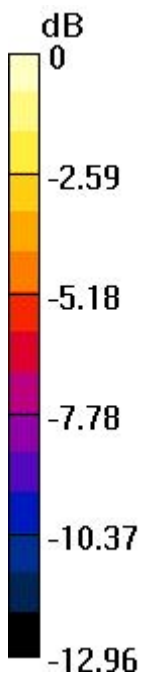

0 dB = 0.150A/m

10 RF_WCDMA Band II_RMC 12.2Kbps_Ch9262_E

DUT: 312310A

Communication System: UMTS; Frequency: 1852.4 MHz; Duty Cycle: 1:1

Medium: Air Medium parameters used: $\sigma = 0$ mho/m, $\epsilon_r = 1$; $\rho = 0$ kg/m³

Ambient Temperature : 23.7 °C

DASY5 Configuration:

- Probe: ER3DV6 - SN2528; ConvF(1, 1, 1); Calibrated: 10.04.2012
- Electronics: DAE4 Sn1303; Calibrated: 22.11.2012
- Phantom: HAC Test Arch with AMCC; Type: SD HAC P01 BA;
- Measurement SW: DASY52, Version 52.8 (2); SEMCAD X Version 14.4.5 (3634)

Ch9262/Hearing Aid Compatibility Test (101x101x1): Measurement grid: dx=5mm, dy=5mm

Maximum value of peak Total field = 32.867 V/m

Device Reference Point: 0, 0, -6.3 mm

Reference Value = 17.046 V/m; Power Drift = -0.06 dB

Hearing Aid Near-Field Category: M4 (AWF 0 dB)

Peak E-field in V/m

Grid 1 32.306 M4	Grid 2 32.867 M4	Grid 3 30.799 M4
Grid 4 23.275 M4	Grid 5 25.610 M4	Grid 6 25.975 M4
Grid 7 37.745 M4	Grid 8 33.490 M4	Grid 9 26.946 M4

Cursor:

Total = 37.745 V/m

E Category: M4

Location: 25, 25, 8.7 mm

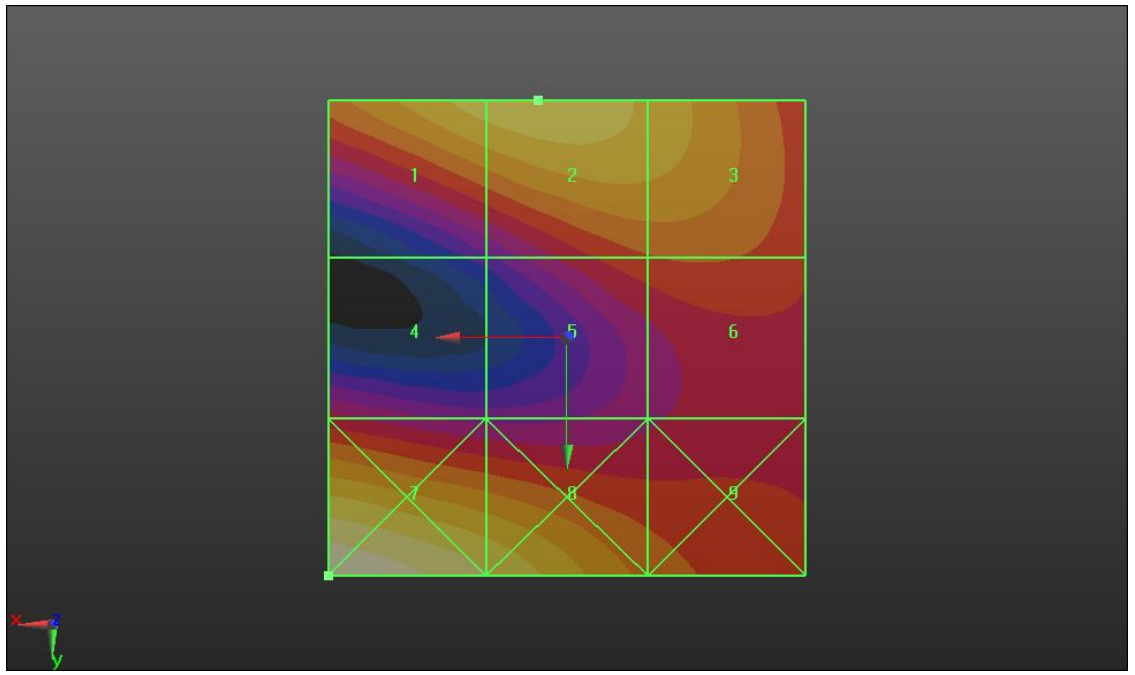
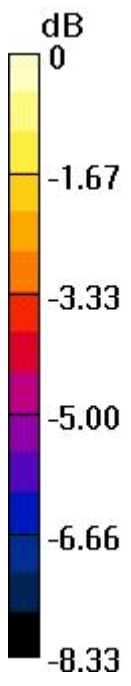

0 dB = 37.740V/m

10 RF_WCDMA Band II_RMC 12.2Kbps_Ch9262_H

DUT: 312310A

Communication System: UMTS; Frequency: 1852.4 MHz; Duty Cycle: 1:1

Medium: Air Medium parameters used: $\sigma = 0$ mho/m, $\epsilon_r = 1$; $\rho = 0$ kg/m³

Ambient Temperature : 23.6 °C

DASY5 Configuration:

- Probe: H3DV6 - SN6342; ; Calibrated: 10.04.2012
- Electronics: DAE4 Sn1303; Calibrated: 22.11.2012
- Phantom: HAC Test Arch with AMCC; Type: SD HAC P01 BA;
- Measurement SW: DASY52, Version 52.8 (2); SEMCAD X Version 14.4.5 (3634)

Ch9262/Hearing Aid Compatibility Test (101x101x1): Measurement grid: dx=5mm, dy=5mm

Maximum value of peak Total field = 0.076 A/m

Device Reference Point: 0, 0, -6.3 mm

Reference Value = 0.092 A/m; Power Drift = 0.00084 dB

Hearing Aid Near-Field Category: M4 (AWF 0 dB)

Peak H-field in A/m

Grid 1 0.070 M4	Grid 2 0.063 M4	Grid 3 0.062 M4
Grid 4 0.074 M4	Grid 5 0.076 M4	Grid 6 0.074 M4
Grid 7 0.087 M4	Grid 8 0.077 M4	Grid 9 0.074 M4

Cursor:

Total = 0.087 A/m

H Category: M4

Location: 25, 25, 8.7 mm

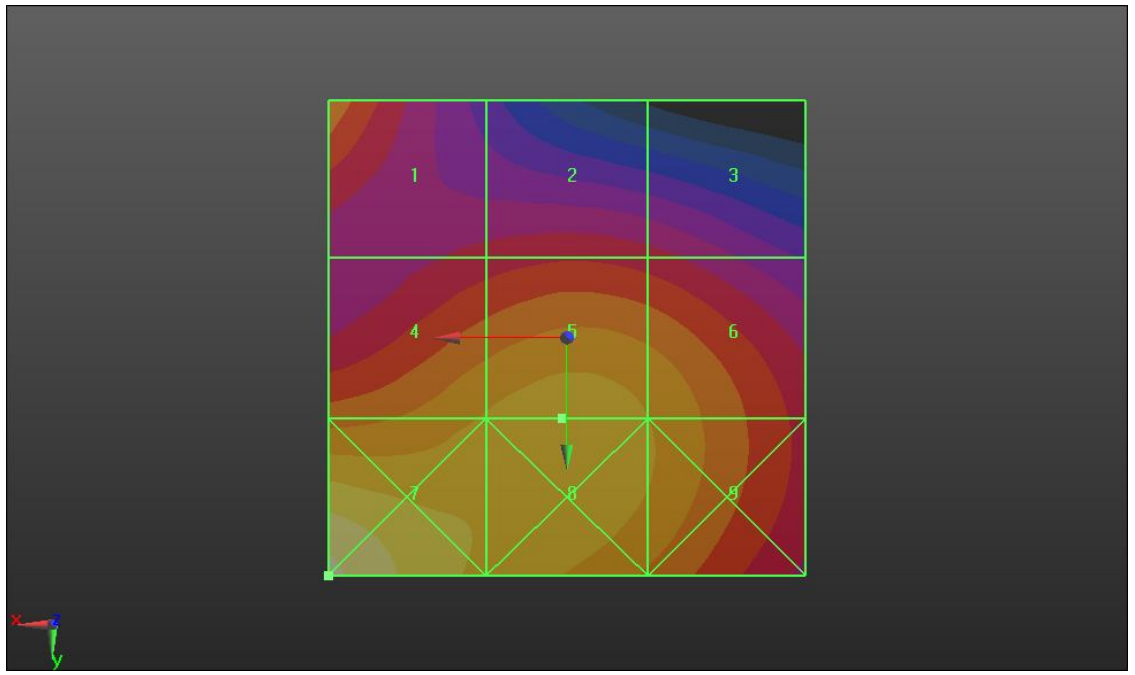
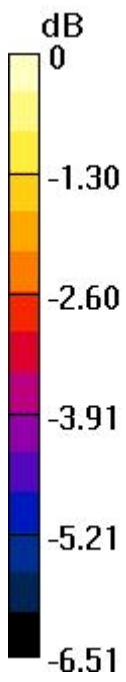

0 dB = 0.090A/m

11 RF_WCDMA Band II_RMC 12.2Kbps_Ch9400_E

DUT: 312310A

Communication System: UMTS; Frequency: 1880 MHz; Duty Cycle: 1:1

Medium: Air Medium parameters used: $\sigma = 0$ mho/m, $\epsilon_r = 1$; $\rho = 0$ kg/m³

Ambient Temperature : 23.7 °C

DASY5 Configuration:

- Probe: ER3DV6 - SN2528; ConvF(1, 1, 1); Calibrated: 10.04.2012
- Electronics: DAE4 Sn1303; Calibrated: 22.11.2012
- Phantom: HAC Test Arch with AMCC; Type: SD HAC P01 BA;
- Measurement SW: DASY52, Version 52.8 (2); SEMCAD X Version 14.4.5 (3634)

Ch9400/Hearing Aid Compatibility Test (101x101x1): Measurement grid: dx=5mm, dy=5mm

Maximum value of peak Total field = 30.453 V/m

Device Reference Point: 0, 0, -6.3 mm

Reference Value = 16.695 V/m; Power Drift = 0.10 dB

Hearing Aid Near-Field Category: M4 (AWF 0 dB)

Peak E-field in V/m

Grid 1 29.849 M4	Grid 2 30.453 M4	Grid 3 28.571 M4
Grid 4 21.942 M4	Grid 5 23.901 M4	Grid 6 24.229 M4
Grid 7 36.236 M4	Grid 8 32.650 M4	Grid 9 26.196 M4

Cursor:

Total = 36.235 V/m

E Category: M4

Location: 25, 25, 8.7 mm

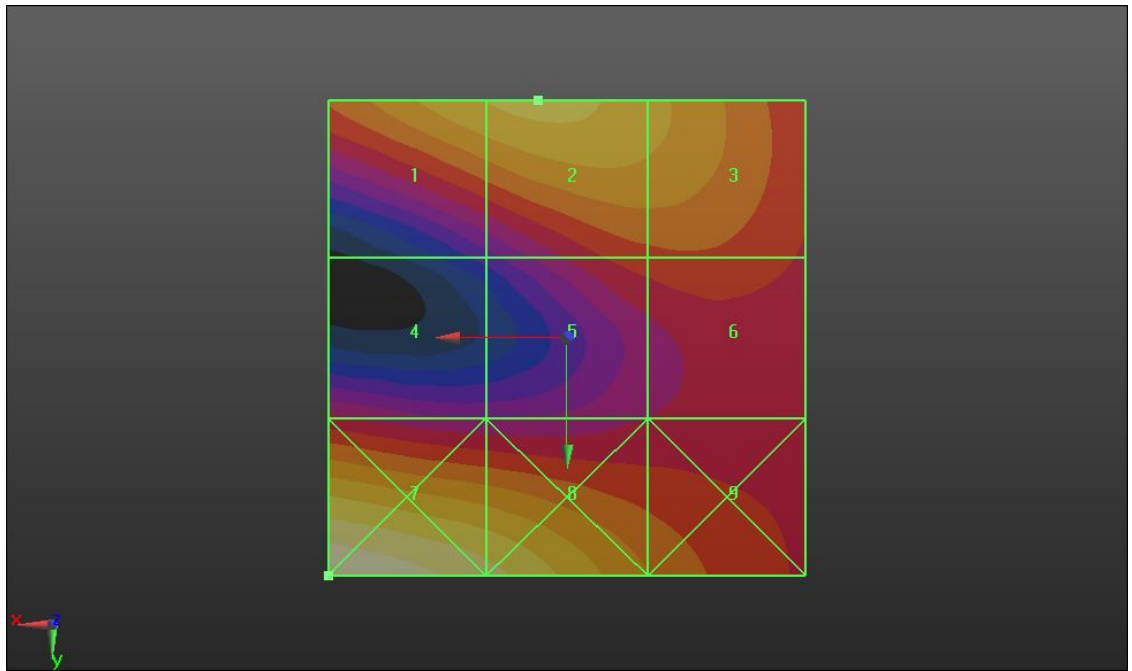
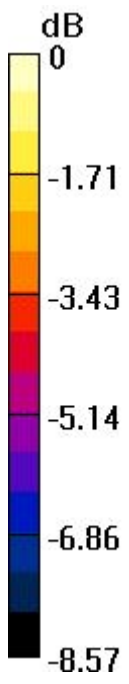

0 dB = 36.240V/m

11 RF_WCDMA Band II_RMC 12.2Kbps_Ch9400_H

DUT: 312310A

Communication System: UMTS; Frequency: 1880 MHz; Duty Cycle: 1:1

Medium: Air Medium parameters used: $\sigma = 0$ mho/m, $\epsilon_r = 1$; $\rho = 0$ kg/m³

Ambient Temperature : 23.6 °C

DASY5 Configuration:

- Probe: H3DV6 - SN6342; ; Calibrated: 10.04.2012
- Electronics: DAE4 Sn1303; Calibrated: 22.11.2012
- Phantom: HAC Test Arch with AMCC; Type: SD HAC P01 BA;
- Measurement SW: DASY52, Version 52.8 (2); SEMCAD X Version 14.4.5 (3634)

Ch9400/Hearing Aid Compatibility Test (101x101x1): Measurement grid: dx=5mm, dy=5mm

Maximum value of peak Total field = 0.071 A/m

Device Reference Point: 0, 0, -6.3 mm

Reference Value = 0.086 A/m; Power Drift = 0.0021 dB

Hearing Aid Near-Field Category: M4 (AWF 0 dB)

Peak H-field in A/m

Grid 1 0.062 M4	Grid 2 0.059 M4	Grid 3 0.058 M4
Grid 4 0.069 M4	Grid 5 0.071 M4	Grid 6 0.070 M4
Grid 7 0.082 M4	Grid 8 0.073 M4	Grid 9 0.071 M4

Cursor:

Total = 0.082 A/m

H Category: M4

Location: 25, 25, 8.7 mm

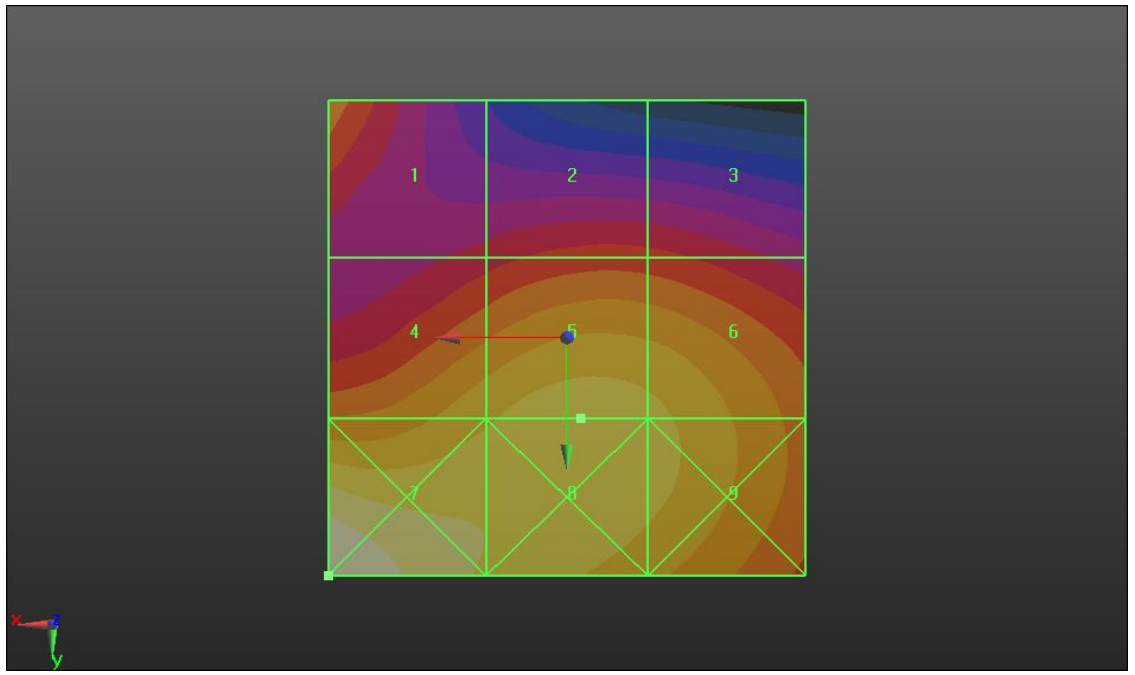
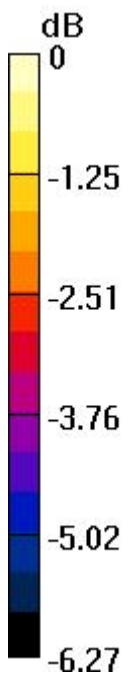

0 dB = 0.080A/m

12 RF_WCDMA Band II_RMC 12.2Kbps_Ch9538_E

DUT: 312310A

Communication System: UMTS; Frequency: 1907.6 MHz; Duty Cycle: 1:1

Medium: Air Medium parameters used: $\sigma = 0$ mho/m, $\epsilon_r = 1$; $\rho = 0$ kg/m³

Ambient Temperature : 23.7 °C

DASY5 Configuration:

- Probe: ER3DV6 - SN2528; ConvF(1, 1, 1); Calibrated: 10.04.2012
- Electronics: DAE4 Sn1303; Calibrated: 22.11.2012
- Phantom: HAC Test Arch with AMCC; Type: SD HAC P01 BA;
- Measurement SW: DASY52, Version 52.8 (2); SEMCAD X Version 14.4.5 (3634)

Ch9538/Hearing Aid Compatibility Test (101x101x1): Measurement grid: dx=5mm, dy=5mm

Maximum value of peak Total field = 29.448 V/m

Device Reference Point: 0, 0, -6.3 mm

Reference Value = 17.108 V/m; Power Drift = -0.09 dB

Hearing Aid Near-Field Category: M4 (AWF 0 dB)

Peak E-field in V/m

Grid 1 29.101 M4	Grid 2 29.448 M4	Grid 3 26.848 M4
Grid 4 24.505 M4	Grid 5 22.111 M4	Grid 6 22.243 M4
Grid 7 38.350 M4	Grid 8 34.404 M4	Grid 9 27.131 M4

Cursor:

Total = 38.350 V/m

E Category: M4

Location: 25, 25, 8.7 mm

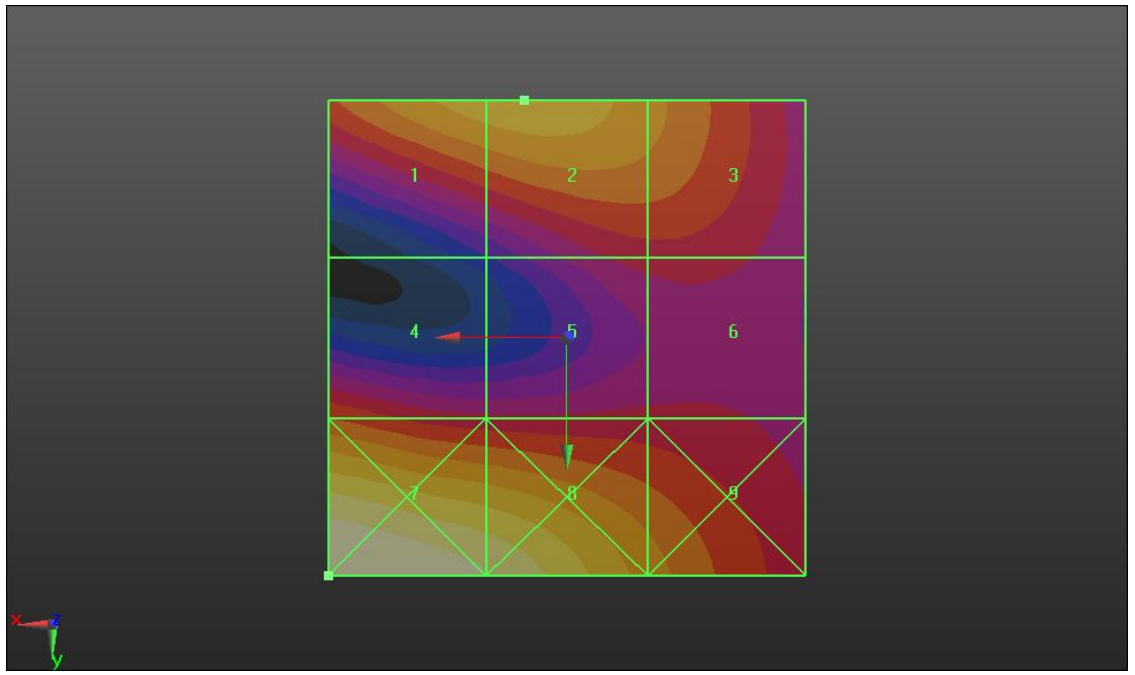
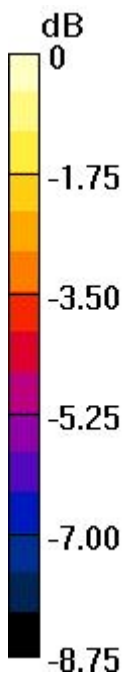

0 dB = 36.520V/m

12 RF_WCDMA Band II_RMC 12.2Kbps_Ch9538_H

DUT: 312310A

Communication System: UMTS; Frequency: 1907.6 MHz; Duty Cycle: 1:1

Medium: Air Medium parameters used: $\sigma = 0$ mho/m, $\epsilon_r = 1$; $\rho = 0$ kg/m³

Ambient Temperature : 23.6 °C

DASY5 Configuration:

- Probe: H3DV6 - SN6342; ; Calibrated: 10.04.2012
- Electronics: DAE4 Sn1303; Calibrated: 22.11.2012
- Phantom: HAC Test Arch with AMCC; Type: SD HAC P01 BA;
- Measurement SW: DASY52, Version 52.8 (2); SEMCAD X Version 14.4.5 (3634)

Ch9538/Hearing Aid Compatibility Test (101x101x1): Measurement grid: dx=5mm, dy=5mm

Maximum value of peak Total field = 0.071 A/m

Device Reference Point: 0, 0, -6.3 mm

Reference Value = 0.086 A/m; Power Drift = -0.02 dB

Hearing Aid Near-Field Category: M4 (AWF 0 dB)

Peak H-field in A/m

Grid 1 0.063 M4	Grid 2 0.059 M4	Grid 3 0.058 M4
Grid 4 0.070 M4	Grid 5 0.071 M4	Grid 6 0.068 M4
Grid 7 0.088 M4	Grid 8 0.074 M4	Grid 9 0.069 M4

Cursor:

Total = 0.088 A/m

H Category: M4

Location: 25, 25, 8.7 mm

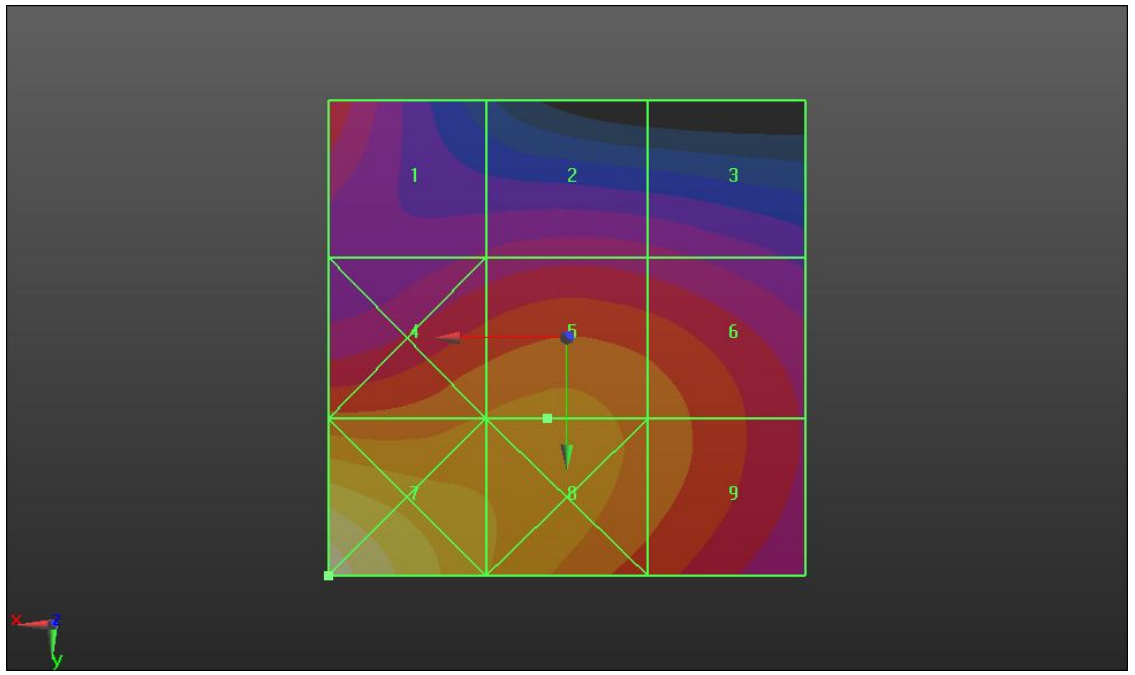
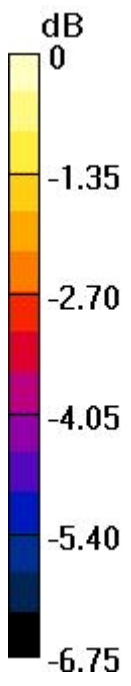

0 dB = 0.090A/m