



FCC Test Report

EQUIPMENT : GSM Digital Mobile Telephone
BRAND NAME : Doro
MODEL NAME : Doro PhoneEasy 345gsm
FCC ID : WS5DORO345G
STANDARD : 47 CFR Part 2, 22(H), 24(E)
CLASSIFICATION : PCS Licensed Transmitter Held to Ear (PCE)
Tx/Rx FREQUENCY RANGE : GSM850 : 824.2 ~ 848.8 MHz /
869.2 ~ 893.8 MHz
GSM1900 : 1850.2 ~ 1909.8 MHz /
1930.2 ~ 1989.8 MHz
MAX. ERP/EIRP POWER : GSM850 : 1.39 W
GSM1900 : 0.77 W
EMISSION DESIGNATOR : 246KGXW
APPLICANT : Doro AB
Magistratsvägen 10, SE-226 43 Lund, Sweden

The product sample received on Mar. 09, 2009 and completely tested on Mar. 18, 2009. We, SPORTON INTERNATIONAL INC., would like to declare that the tested sample has been evaluated in accordance with the procedures given in ANSI C63.4-2003 and shown compliance with the applicable technical standards.

The test results in this report apply exclusively to the tested model / sample. Without written approval of SPORTON INTERNATIONAL INC., the test report shall not be reproduced except in full.

Reviewed by: Roy Wu / Manager



SPORTON INTERNATIONAL (KUNSHAN) INC.
No. 3-2, PingXiang Road, Kunshan, Jiangsu Province, P.R.C.



TABLE OF CONTENTS

REVISION HISTORY.....	3
SUMMARY OF TEST RESULT	4
1 GENERAL DESCRIPTION	5
1.1 Applicant.....	5
1.2 Manufacturer	5
1.3 Feature of Equipment Under Test.....	5
1.4 Testing Site	6
1.5 Applied Standards	6
1.6 Ancillary Equipment List.....	7
2 TEST CONFIGURATION OF EQUIPMENT UNDER TEST	8
2.1 Test Mode.....	8
2.2 Connection Diagram of Test System	9
3 TEST RESULT.....	10
3.1 Conducted Output Power Measurement.....	10
3.2 Effective Radiated Power and Effective Isotropic Radiated Power Measurement	12
3.3 Occupied Bandwidth and Band Edge Measurement	15
3.4 Conducted Emission Measurement	20
3.5 Field Strength of Spurious Radiation Measurement	26
3.6 Frequency Stability Measurement.....	34
4 LIST OF MEASURING EQUIPMENT	37
5 UNCERTAINTY OF EVALUATION.....	38
6 CERTIFICATION OF TAF ACCREDITATION	39
APPENDIX A. PHOTOGRAPHS OF EUT	
APPENDIX B. SETUP PHOTOGRAPHS	



SUMMARY OF TEST RESULT

Report Section	FCC Rule	IC Rule	Description	Limit	Result
3.1	§2.1046	N/A	Conducted Output Power	N/A	PASS
3.2	§22.913(a)(2)	RSS-132(4.4) SRSP-503(5.1.3)	Effective Radiated Power	< 7 Watts for FCC (<6.3 Watts for IC)	PASS
3.2	§24.232(c)	RSS-133 (6.4) SRSP-510(5.1.2)	Equivalent Isotropic Radiated Power	< 2 Watts	PASS
3.3	§2.1049 §22.917(a) §24.238(a)	N/A	Occupied Bandwidth	N/A	PASS
3.4	§2.1051 §22.917(a) §24.238(a)	RSS-132 (4.5.1) RSS-133 (6.5.1)	Band Edge Measurement	< 43+10log ₁₀ (P[Watts])	PASS
3.5	§2.1051 §22.917(a) §24.238(a)	RSS-132 (4.5.1) RSS-133 (6.5.1)	Conducted Emission	< 43+10log ₁₀ (P[Watts])	PASS
3.6	§2.1053 §22.917(a) §24.238(a)	RSS-132 (4.5.1) RSS-133 (6.5.1)	Field Strength of Spurious Radiation	< 43+10log ₁₀ (P[Watts])	PASS
3.7	§2.1055 §22.355 §24.235	RSS-132(4.3) RSS-133(6.3)	Frequency Stability for Temperature & Voltage	< 2.5 ppm	PASS

1 General Description

1.1 Applicant

Doro AB
Magistratsvägen 10, SE-226 43 Lund, Sweden

1.2 Manufacturer

CK TELECOM LTD.
Technology Road, High-Tech Development Zone, Heyuan, Guangdong, P.R.C.

1.3 Feature of Equipment Under Test

Product Feature & Specification	
Equipment	GSM Digital Mobile Telephone
Brand Name	Doro
Model Name	Doro PhoneEasy 345gsm
FCC ID	WS5DORO345G
Tx Frequency	GSM850 : 824 MHz ~ 849 MHz GSM1900 : 1850 MHz ~ 1910 MHz
Rx Frequency	GSM850 : 869 MHz ~ 894 MHz GSM1900 : 1930 MHz ~ 1990 MHz
Maximum Output Power to Antenna	GSM850: 31.72 dBm GSM1900: 29.71 dBm
Maximum ERP/EIRP	GSM850(GSM) : 1.39 W (31.44 dBm) GSM1900(GSM) : 0.77 W (28.84 dBm)
Antenna Type	Fixed Internal Antenna
HW Version	CARE-V2.0
SW Version	CARE-S06_DORO345_L14EN_201_090223_MCP128+32_BT_FM
Type of Modulation	GSM : GMSK
Type of Emission	GSM : 24K6XW
EUT Stage	Identical Prototype

List of Accessory:

Accessories Specification		
AC Adapter	Brand Name	Doro
	Model Name	HKC0055365-2A
	Power Rating	I/P:100-240Vac, 50-60Hz, 0.2A; O/P: 5.3Vdc, 650mA
	AC Power Cord Type	1.56 meter non-shielded cable without ferrite core
Battery	Brand Name	Doro
	Model Name	01.10.CAREP0103
	Power Rating	3.7Vdc, 850mAh
	Type	Li-ion

Remark:

1. The above EUT's information was declared by manufacturer. Please refer to the specifications or user's manual for more detailed description.
2. For accessories equipped with this EUT, please refer to the appendix of the external photo.

1.4 Testing Site

Test Site	SPORTON INTERNATIONAL (KUNSHAN) INC.	
Test Site Location	No. 3-2, PingXiang Road, Kunshan, Jiangsu Province, P.R.C. TEL: +86-0512-5790-0158 FAX: +86-0512-5790-0958	
Test Site No.	Sporton Site No.	
	TH01-KS	03CH01-KS

1.5 Applied Standards

According to the specifications of the manufacturer, the EUT must comply with the requirements of the following standards:

- ♦ 47 CFR Part 2, 22(H), 24(E)
- ♦ ANSI C63.4-2003
- ♦ ANSI / TIA / EIA-603-C-2004
- ♦ IC RSS-132 Issue 2
- ♦ IC RSS-133 Issue 5

Remark:

1. All test items were verified and recorded according to the standards and without any deviation during the test.
2. This EUT has also been tested and complied with the requirements of FCC Part 15, Subpart B (DoC), recorded in a separate test report.



1.6 Ancillary Equipment List

Item	Equipment	Trade Name	Model No.	FCC ID	Data Cable	Power Cord
1.	System Simulator	R&S	CMU200	N/A	N/A	Unshielded, 1.8 m
2.	Bluetooth Earphone	Nokia	HS.12W	PYAHS.12W	N/A	N/A

2 Test Configuration of Equipment Under Test

2.1 Test Mode

During all testing, EUT is in link mode with base station emulator at maximum power level. The spurious emission measurements were carried out in semi-anechoic chamber with 3-meter test range, and EUT is rotated on three test planes to find out the worst emission.

Frequency range investigated for radiated emission is as follows:

1. 30 MHz to 9000 MHz for GSM850.
2. 30MHz to 19000 MHz for GSM1900.

Test Modes		
Band	Radiated TCs	Conducted TCs
GSM 850	<ul style="list-style-type: none"> ■ GSM Link ■ GSM Link + BT Link 	<ul style="list-style-type: none"> ■ GSM Link
GSM 1900	<ul style="list-style-type: none"> ■ GSM Link 	<ul style="list-style-type: none"> ■ GSM Link

2.2 Connection Diagram of Test System

<GSM Link Mode>

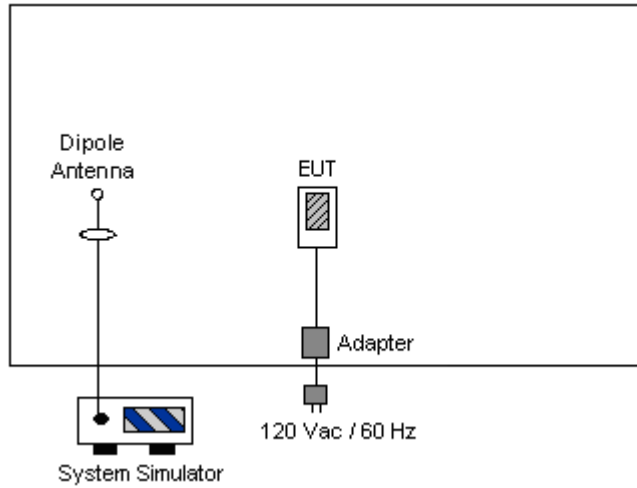

<Co-location with BT Mode>

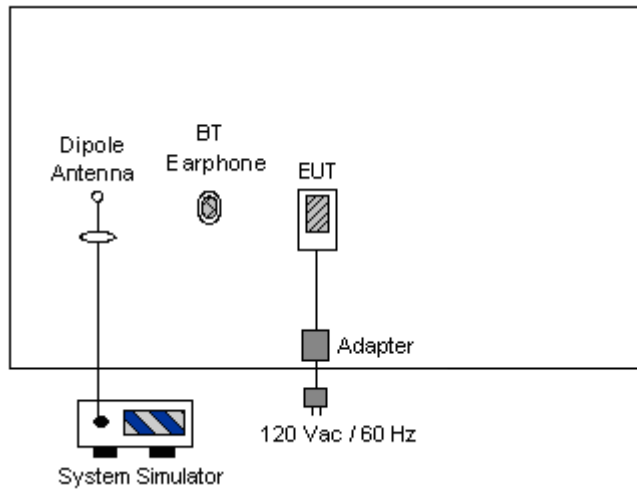

3 Test Result

3.1 Conducted Output Power Measurement

3.1.1 Description of the Conducted Output Power Measurement

A base station simulator was used to establish communication with the EUT. Its parameters were set to transmit the maximum power on the EUT. The measured power in the radio frequency on the transmitter output terminals shall be reported.

3.1.2 Measuring Instruments

See list of measuring instruments of this test report.

3.1.3 Test Procedures

1. The transmitter output port was connected to base station.
2. Set EUT at maximum power through base station.
3. Select lowest, middle, and highest channels for each band and different modulation.

3.1.4 Test Setup

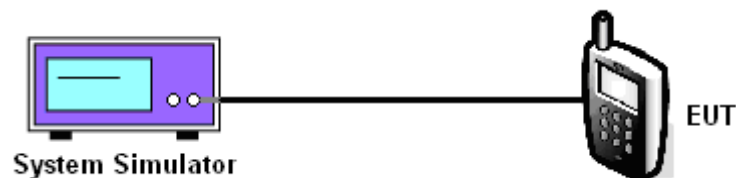

3.1.5 Test Result of Conducted Output Power

Cellular Band				
Modes	Channel	Frequency (MHz)	Conducted Power	
			(dBm)	(Watts)
GSM	128 (Low)	824.2	31.67	1.47
	189 (Mid)	836.4	31.66	1.47
	251 (High)	848.8	31.72	1.49

PCS Band				
Modes	Channel	Frequency (MHz)	Conducted Power	
			(dBm)	(Watts)
GSM	512 (Low)	1850.2	29.71	0.94
	661 (Mid)	1880.0	29.31	0.85
	810 (High)	1909.8	28.94	0.78

3.2 Effective Radiated Power and Effective Isotropic Radiated Power Measurement

3.2.1 Description of the ERP/EIRP Measurement

ERP/EIRP is measured by substitution method according to ANSI / TIA / EIA-603-C-2004. The ERP of mobile transmitters must not exceed 7 Watts and the EIRP of mobile transmitters are limited to 2 Watts.

3.2.2 Measuring Instruments

See list of measuring instruments of this test report.

3.2.3 Test Procedures

1. The EUT was placed on a turntable with 1.0 meter height in a fully anechoic chamber.
2. The EUT was set at 1.2 meters from the receiving antenna, which was mounted on the antenna tower.
3. The table was rotated 360 degrees to determine the position of the highest radiated power.
4. The height of the receiving antenna is adjusted to look for the maximum ERP/EIRP.
5. Taking the record of maximum ERP/EIRP.
6. A dipole antenna was substituted in place of the EUT and was driven by a signal generator.
7. The conducted power at the terminal of the dipole antenna is measured.
8. Repeat step 3 to step 5 to get the maximum ERP/EIRP of the substitution antenna.
9. $ERP/EIRP = P_s + E_t - E_s + G_s = P_s + R_t - R_s + G_s$
 P_s (dBm) : Input power to substitution antenna.
 G_s (dBi or dBd) : Substitution antenna Gain.
 $E_t = R_t + AF$
 $E_s = R_s + AF$
 AF (dB/m) : Receive antenna factor
 R_t : The highest received signal in spectrum analyzer for EUT.
 R_s : The highest received signal in spectrum analyzer for substitution antenna.

3.2.4 Test Setup

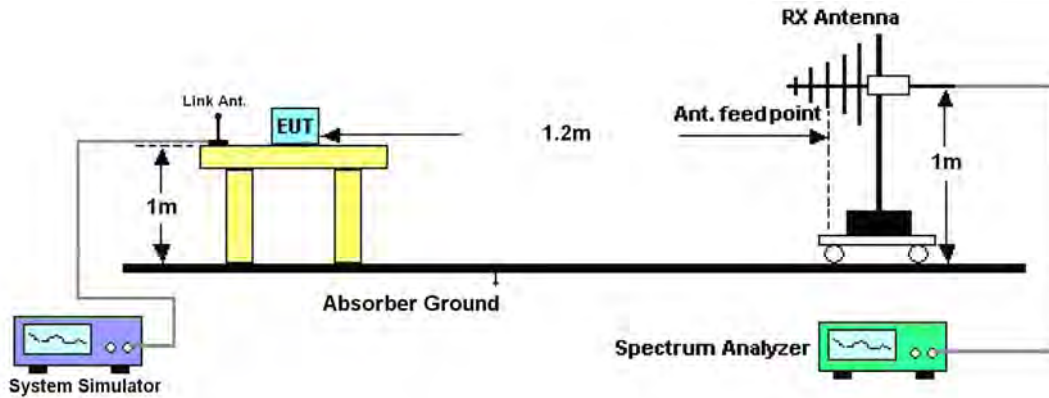

3.2.5 Test Result of ERP

GSM850 (GSM) Radiated Power ERP						
Horizontal Polarization						
Frequency (MHz)	Rt (dBm)	Rs (dBm)	Ps (dBm)	Gs (dBd)	ERP (dBm)	ERP (W)
826.40	-32.80	-48.12	0.00	-1.08	14.24	0.03
836.40	-32.82	-48.28	0.00	-0.93	14.53	0.03
846.60	-32.45	-48.35	0.00	-0.76	15.14	0.03
Vertical Polarization						
Frequency (MHz)	Rt (dBm)	Rs (dBm)	Ps (dBm)	Gs (dBd)	ERP (dBm)	ERP (W)
826.40	-15.45	-47.97	0.00	-1.08	31.44	1.39
836.40	-17.77	-48.01	0.00	-0.93	29.31	0.85
846.60	-18.24	-48.05	0.00	-0.76	29.05	0.80



3.2.6 Test Result of EIRP

GSM1900 (GSM) Radiated Power EIRP						
Horizontal Polarization						
Frequency (MHz)	Rt (dBm)	Rs (dBm)	Ps (dBm)	Gs (dBi)	EIRP (dBm)	EIRP (W)
1852.40	-27.85	-51.88	0.00	1.96	25.99	0.40
1880.00	-28.93	-52.99	0.00	2.00	26.06	0.40
1907.60	-29.68	-54.28	0.00	1.98	26.58	0.45
Vertical Polarization						
Frequency (MHz)	Rt (dBm)	Rs (dBm)	Ps (dBm)	Gs (dBi)	EIRP (dBm)	EIRP (W)
1852.40	-25.25	-52.13	0.00	1.96	28.84	0.77
1880.00	-26.89	-53.17	0.00	2.00	28.28	0.67
1907.60	-27.98	-54.13	0.00	1.98	28.13	0.65

3.3 Occupied Bandwidth and Band Edge Measurement

3.3.1 Description of Occupied Bandwidth and Band Edge Measurement

The power of any emission outside of the authorized operating frequency ranges must be lower than the transmitter power (P) by a factor of at least $43 + 10 \log (P)$ dB.

The emission bandwidth is defined as the width of the signal between two points, located at the 2 sides of the carrier frequency, outside of which all emissions are attenuated at least 26 dB below the transmitter power.

3.3.2 Measuring Instruments

See list of measuring instruments of this test report.

3.3.3 Test Procedures

1. The EUT was connected to Spectrum Analyzer and Base Station via power divider.
2. The 99% and 26 dB occupied bandwidth (BW) of the middle channel for the highest RF powers were measured.
3. The band edges of low and high channels for the highest RF powers were measured. Setting RBW as roughly BW/100.
4. The RBW was replaced by 10 kHz, due to the spectrum analyzer IF-Filter including an excess of the limit. A worst case correction factor of $10 \log (1\% \text{ BW}/\text{measurement RBW})$ was implemented.

3.3.4 Test Setup

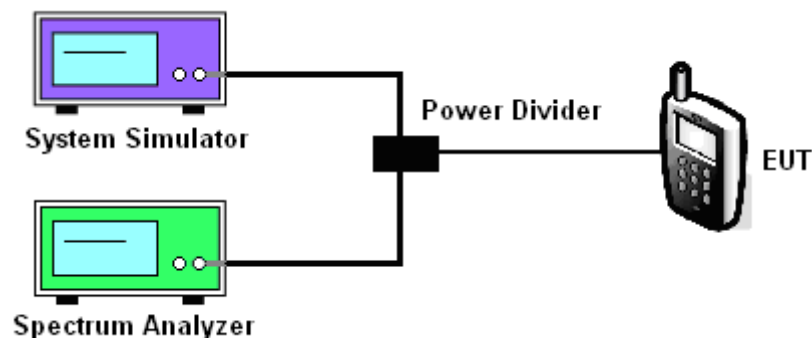



3.3.5 Test Result (Plots) of Occupied Bandwidth

Band :	GSM 850	Power Stage :	High
Test Mode :	GSM Link		

99% Occupied Bandwidth Plot on Channel 189

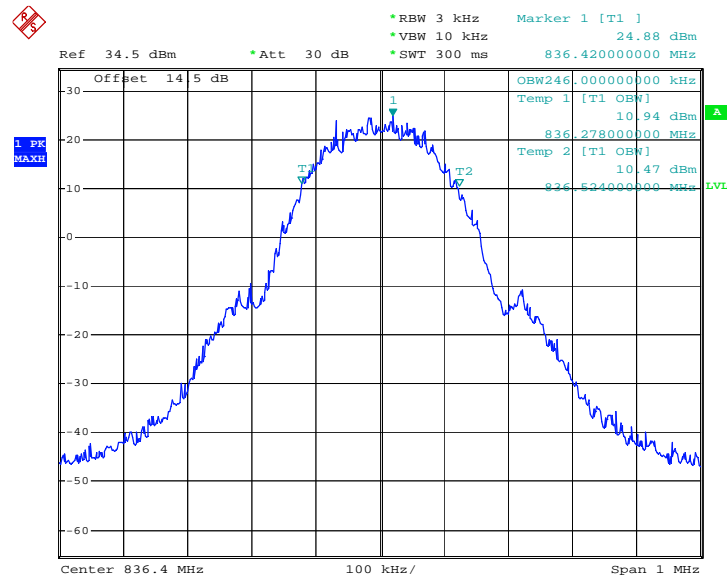

Date: 11.MAR.2009 23:06:54

26dB Bandwidth Plot on Channel 189

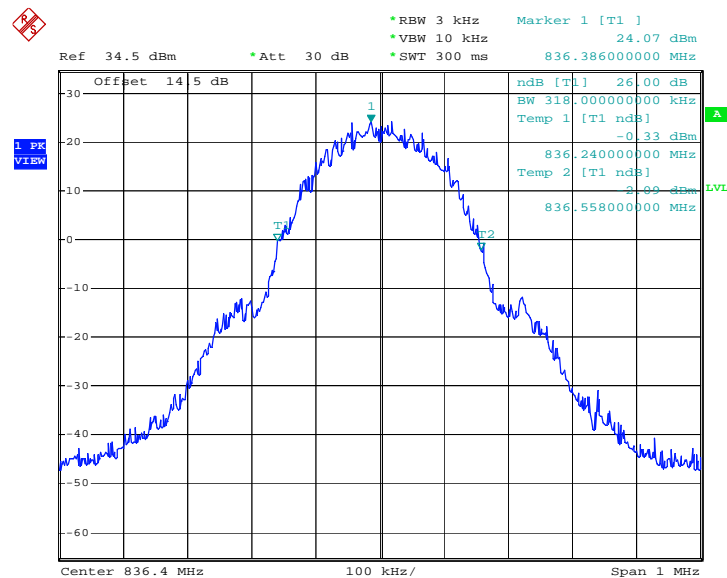

Date: 11.MAR.2009 22:56:40



Band :	GSM 1900	Power Stage :	High
Test Mode :	GSM Link		

99% Occupied Bandwidth Plot on Channel 661

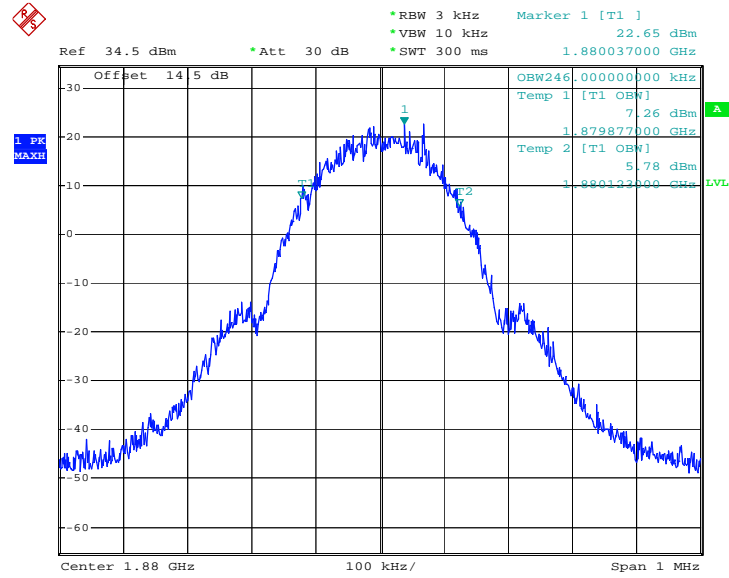

Date: 11.MAR.2009 12:46:00

26dB Bandwidth Plot on Channel 661

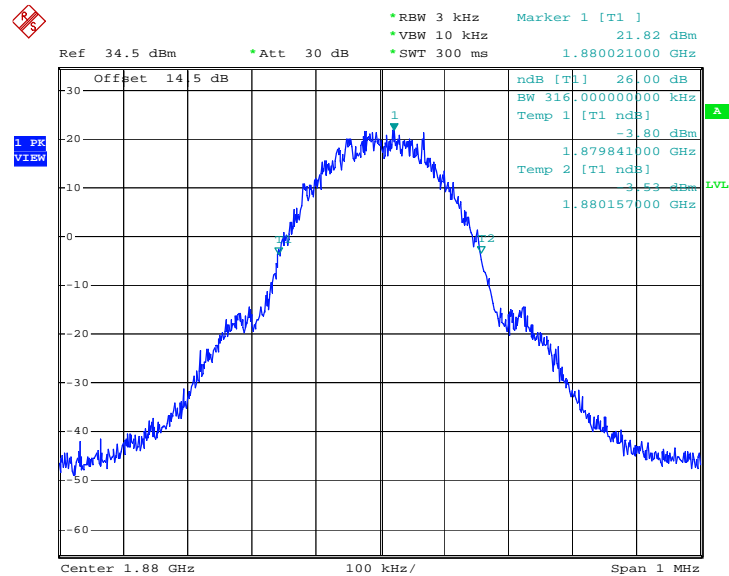

Date: 11.MAR.2009 12:37:06



3.3.6 Test Result (Plots) of Conducted Band Edges

Band :	GSM850	Power Stage :	High
Test Mode :	GSM Link		

Lower Band Edge Plot on Channel 128

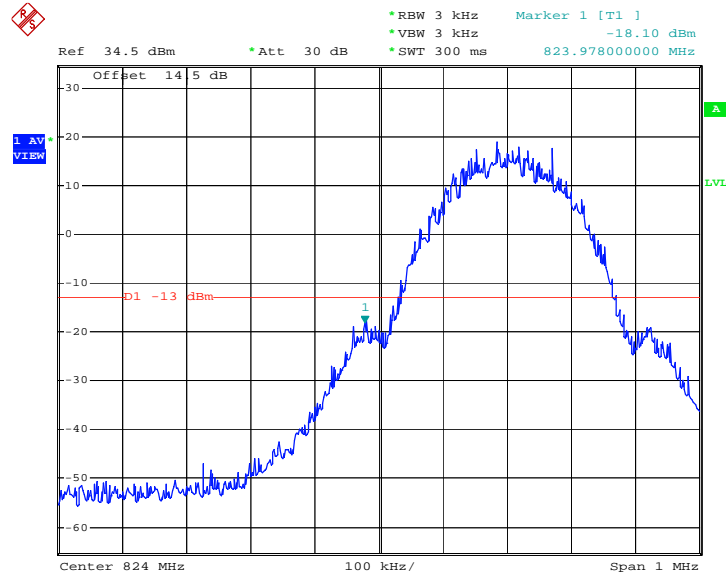

Date: 11.MAR.2009 23:03:16

Higher Band Edge Plot on Channel 251

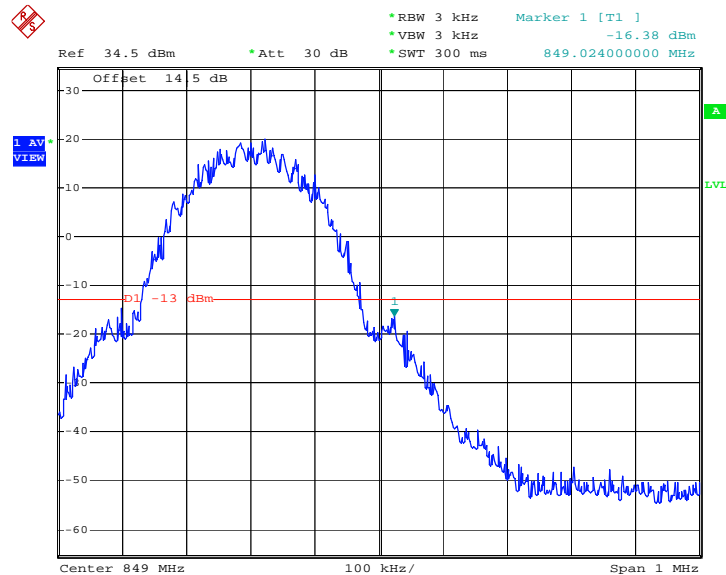

Date: 11.MAR.2009 23:00:51



Band :	GSM1900	Power Stage :	High
Test Mode :	GSM Link		

Lower Band Edge Plot on Channel 512

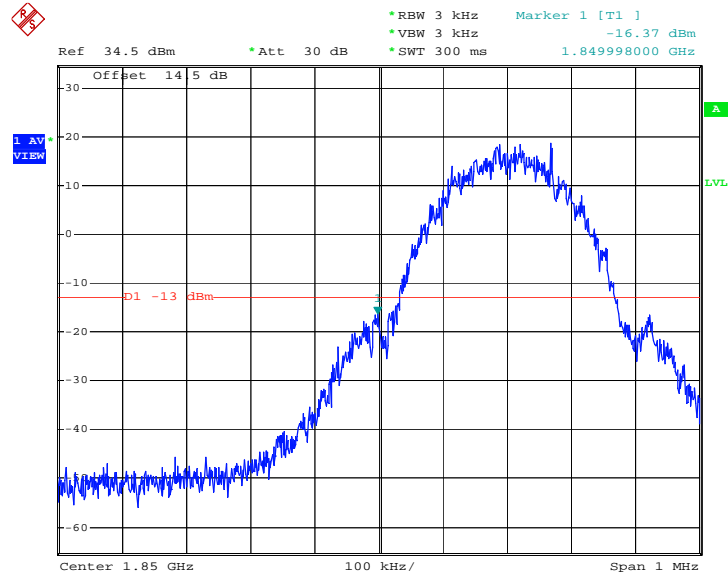

Date: 11.MAR.2009 12:42:35

Higher Band Edge Plot on Channel 810

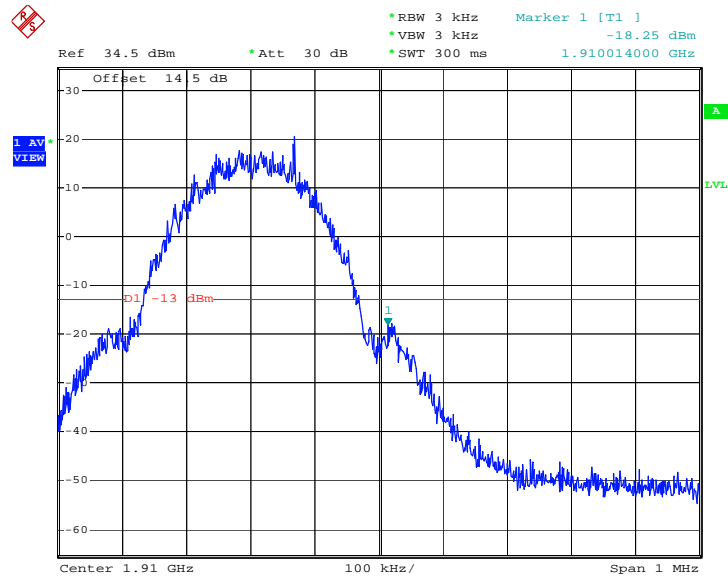

Date: 11.MAR.2009 12:41:07

3.4 Conducted Emission Measurement

3.4.1 Description of Conducted Emission Measurement

The power of any emission outside of the authorized operating frequency ranges must be lower than the transmitter power (P) by a factor of at least $43 + 10 \log (P)$ dB.

It is measured by means of a calibrated spectrum analyzer and scanned from 30 MHz up to a frequency including its 10th harmonic.

3.4.2 Measuring Instruments

See list of measuring instruments of this test report.

3.4.3 Test Procedures

1. The EUT was connected to spectrum analyzer and base station via power divider.
2. The middle channel for the highest RF power within the transmitting frequency was measured.
3. The conducted spurious emission for the whole frequency range was taken.

3.4.4 Test Setup

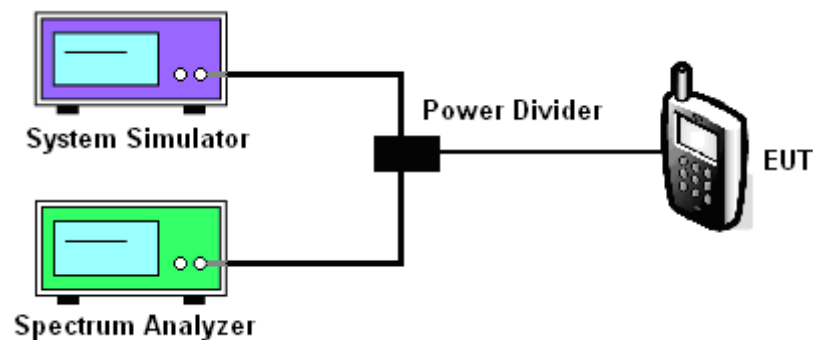



3.4.5 Test Result (Plots) of Conducted Emission

Band :	GSM850	Channel :	CH189
Test Mode :	GSM Link		

Conducted Emission Plot between 30M-1G

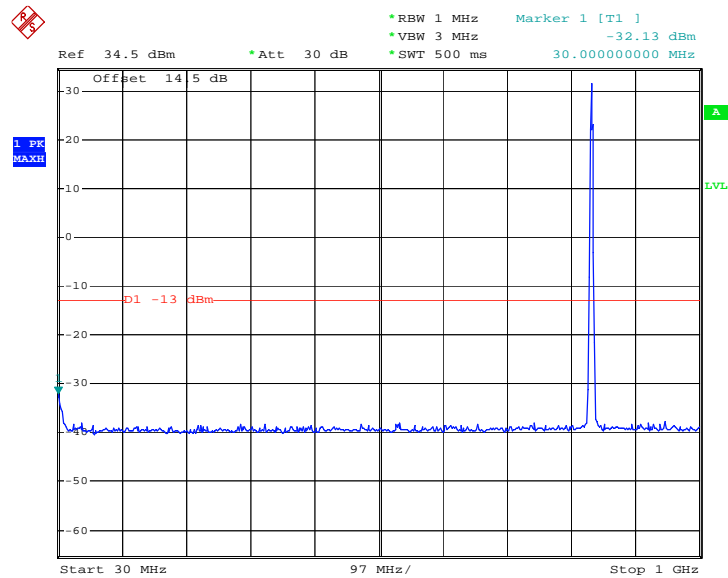

Date: 11.MAR.2009 22:39:56

Conducted Emission Plot between 1GHz ~ 3GHz

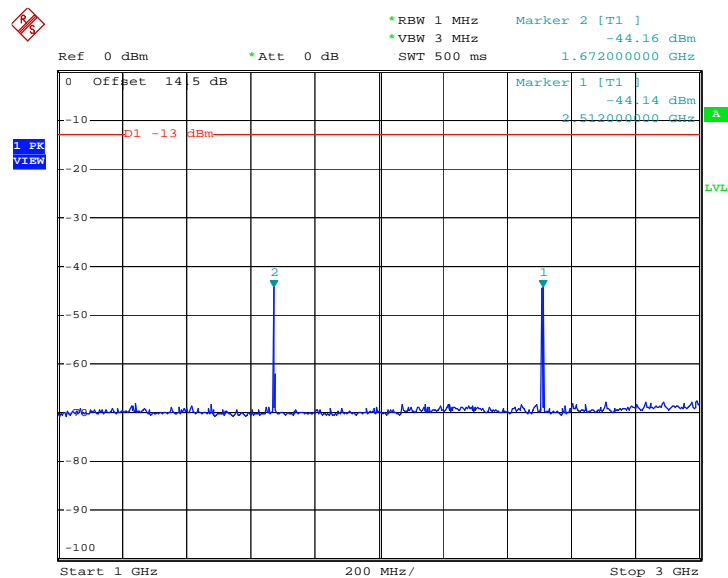

Date: 11.MAR.2009 22:47:48



Conducted Emission Plot between 3GHz ~ 7GHz

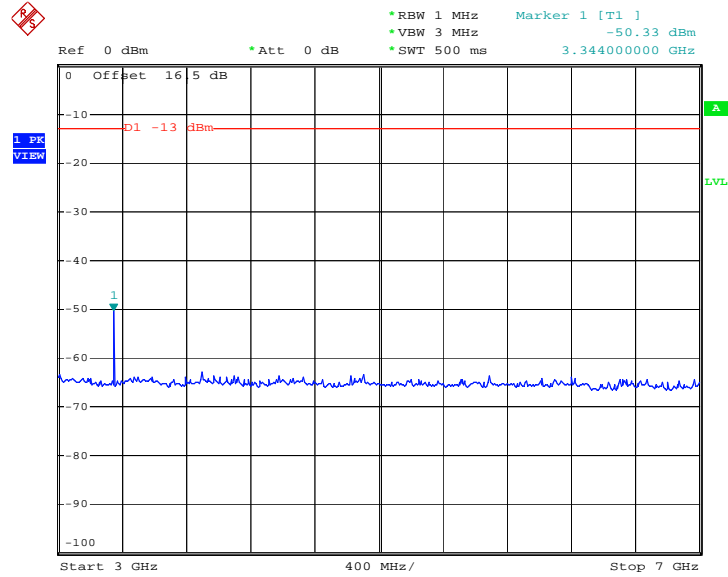

Date: 11.MAR.2009 22:50:21

Conducted Emission Plot between 7GHz ~ 9GHz

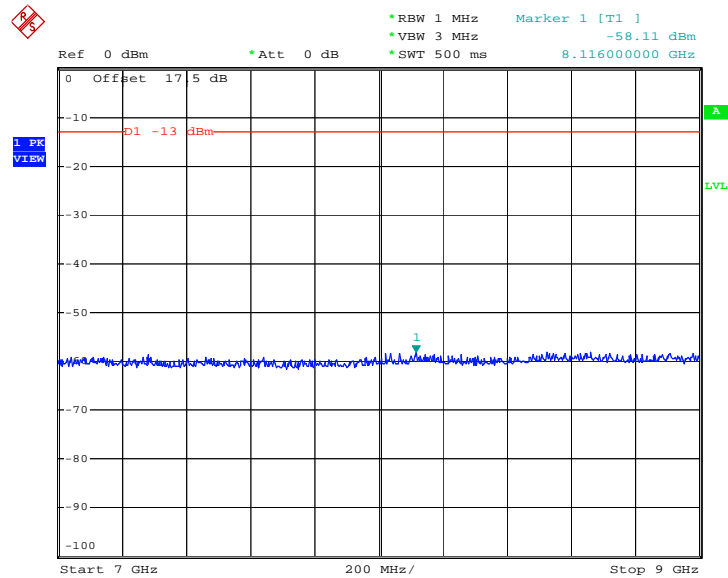

Date: 11.MAR.2009 11:38:29



Band :	GSM1900	Channel :	CH661
Test Mode :	GSM Link		

Conducted Emission Plot between 30M-1G

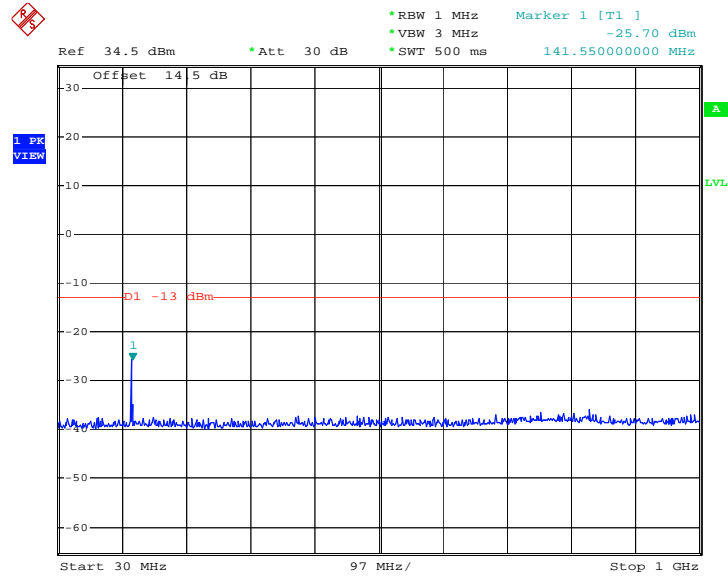

Date: 11.MAR.2009 12:57:01

Conducted Emission Plot between 1GHz ~ 3GHz

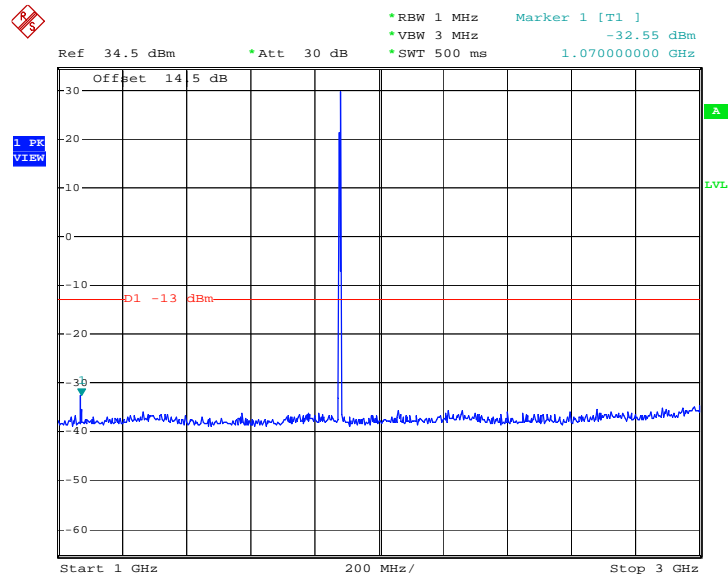

Date: 11.MAR.2009 12:56:04



Conducted Emission Plot between 3G-7G

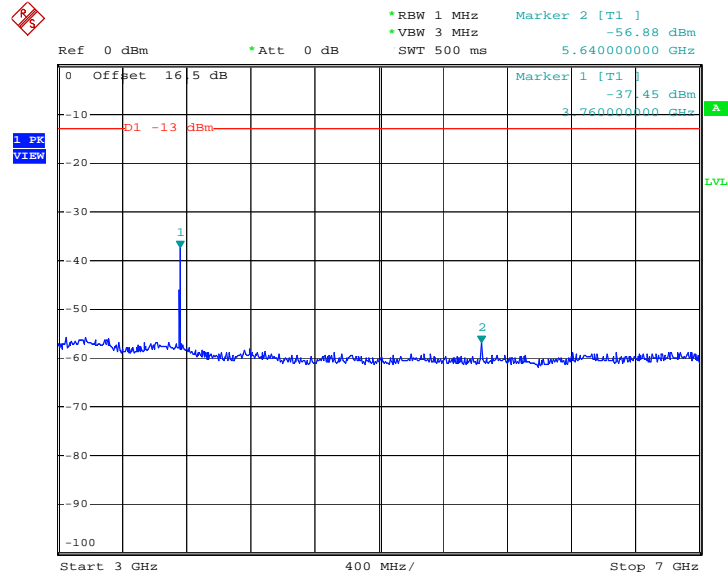

Date: 11.MAR.2009 13:00:29

Conducted Emission Plot between 7G-13.6G

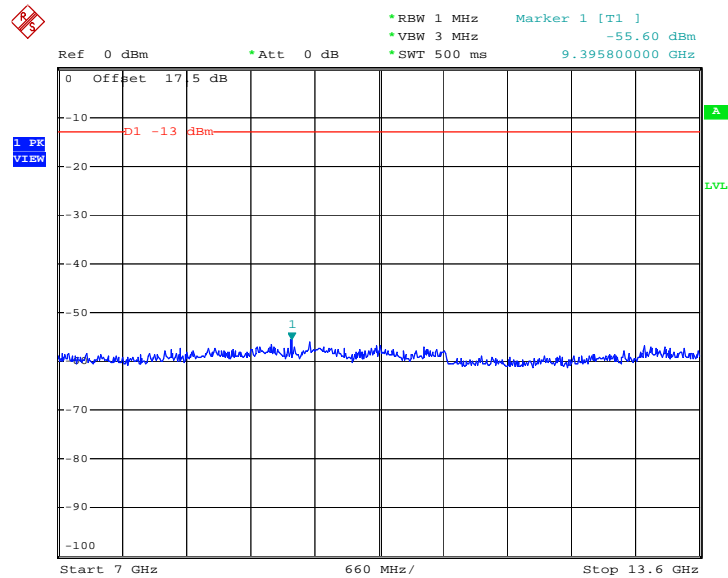

Date: 11.MAR.2009 13:01:47



Conducted Emission Plot between 13.6G-19.1G

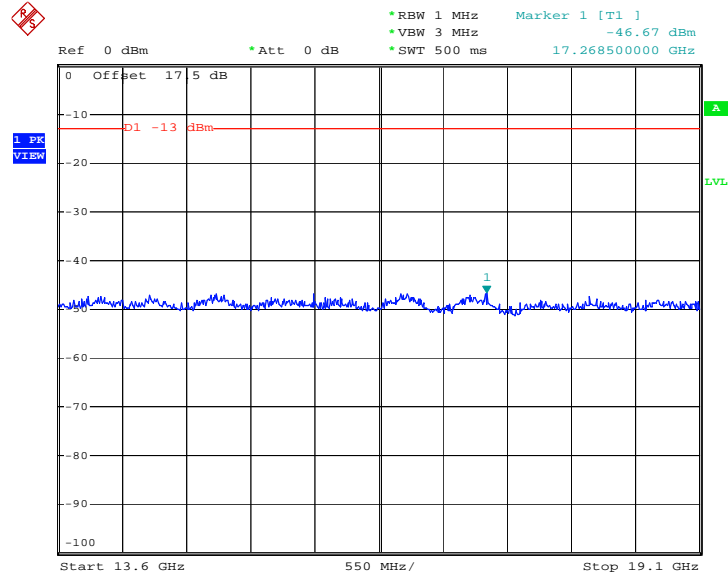

Date: 11.MAR.2009 13:03:11

3.5 Field Strength of Spurious Radiation Measurement

3.5.1 Description of Field Strength of Spurious Radiated Measurement

The radiated spurious emission was measured by substitution method according to ANSI / TIA / EIA-603-C-2004. The power of any emission outside of the authorized operating frequency ranges must be attenuated below the transmitter power (P) by a factor of at least $43 + 10 \log (P)$ dB. The spectrum is scanned from 30 MHz up to a frequency including its 10th harmonic.

3.5.2 Measuring Instruments

See list of measuring instruments of this test report.

3.5.3 Test Procedures

1. The EUT was placed on a rotatable wooden table with 0.8 meter about ground.
2. The EUT was set 3 meters from the receiving antenna, which was mounted on the antenna tower.
3. The table was rotated 360 degrees to determine the position of the highest spurious emission.
4. The height of the receiving antenna is varied between one meter and four meters to search the maximum spurious emission for both horizontal and vertical polarizations.
5. Taking the record of maximum spurious emission.
6. A horn antenna was substituted in place of the EUT and was driven by a signal generator.
7. Tune the output power of signal generator to the same emission level with EUT maximum spurious emission.
8. Taking the record of output power at antenna port.
9. Repeat step 7 to step 8 for another polarization.
10. Emission level (dBm) = output power + substitution Gain.

3.5.4 Test Setup

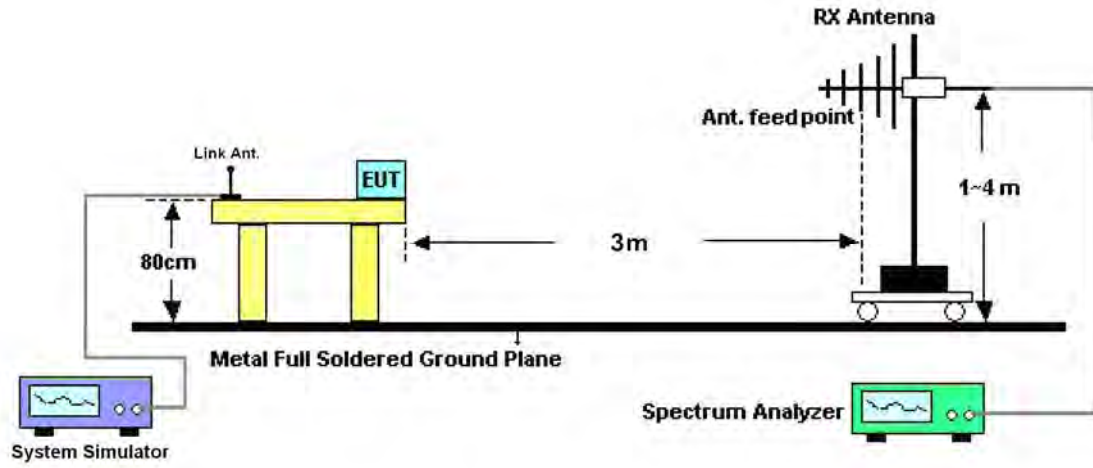



3.5.5 Test Result of Field Strength of Spurious Radiated

Band :	GSM850	Temperature :	19~20°C
Test Mode :	GSM Link	Relative Humidity :	35~36%
Test Engineer :	Peter Qiu	Polarization :	Horizontal
Remark :	Spurious emissions within 30-1000MHz were found more than 20dB below limit line.		

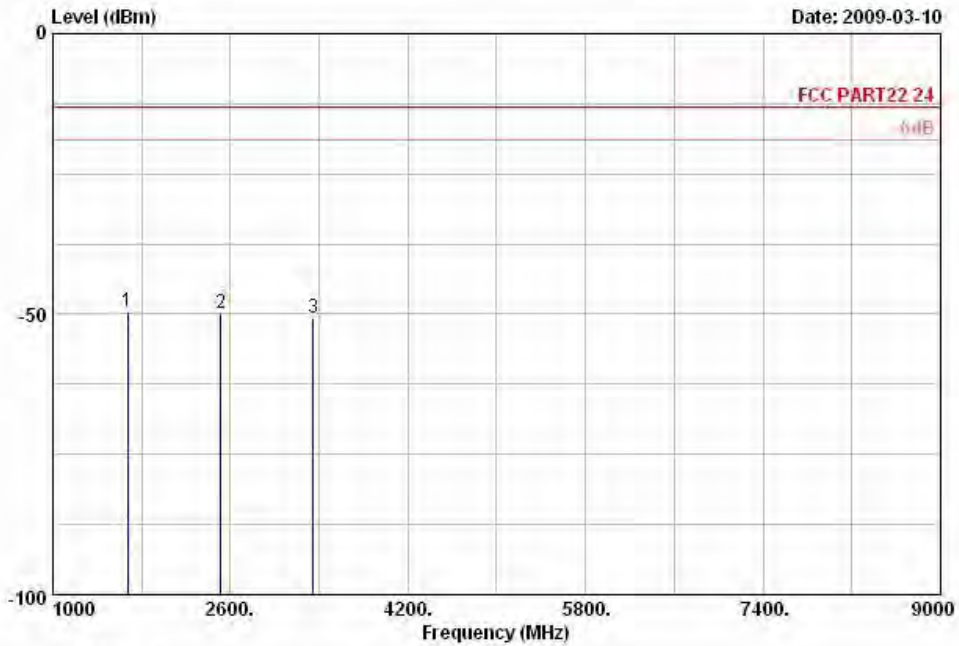

Site : 03CH01-KS
 Condition: FCC PART22 24 HF EIRP FACTOR-09020 HORIZONTAL

Frequency (MHz)	ERP (dBm)	Limit (dBm)	Over Limit (dB)	SPA Reading (dBm)	S.G. Power (dBm)	TX Cable loss (dB)	TX Antenna Gain (dBi)	Polarization (H/V)	Result
1674	-49.46	-13	-36.46	-57.26	-52.67	0.69	6.05	H	Pass
2510	-49.84	-13	-36.84	-58.25	-52.64	0.82	5.77	H	Pass
3346	-50.60	-13	-37.60	-61.54	-55.26	0.99	7.80	H	Pass



Band :	GSM850	Temperature :	19~20°C
Test Mode :	GSM Link	Relative Humidity :	35~36%
Test Engineer :	Peter Qiu	Polarization :	Vertical
Remark :	Spurious emissions within 30-1000MHz were found more than 20dB below limit line.		

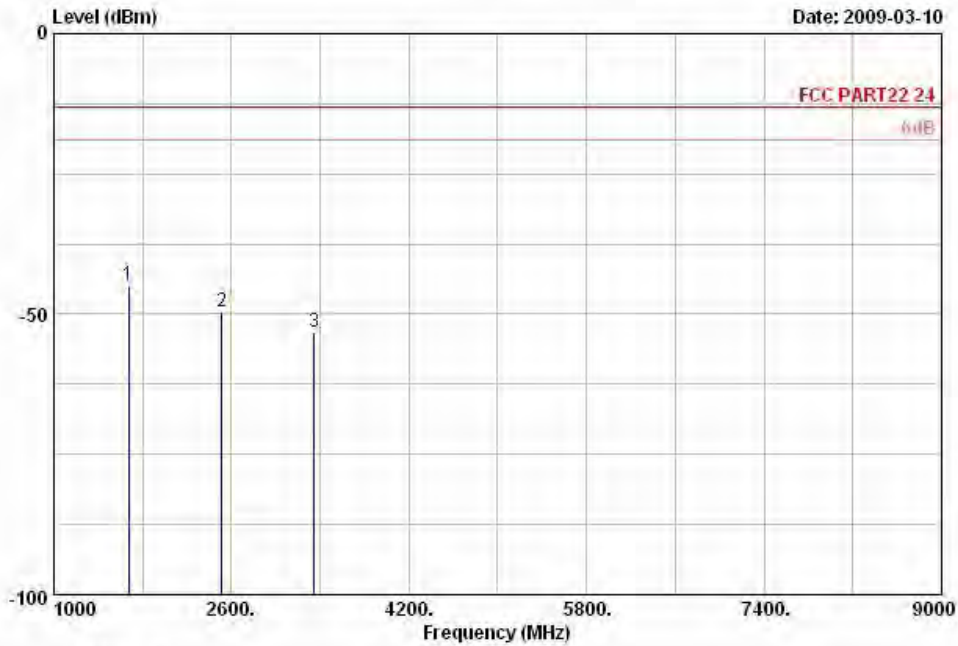

Site : 03CH01-K5
 Condition: FCC PART22 24 HF EIRP FACTOR-09020 VERTICAL

Frequency (MHz)	ERP (dBm)	Limit (dBm)	Over Limit (dB)	SPA Reading (dBm)	S.G. Power (dBm)	TX Cable loss (dB)	TX Antenna Gain (dBi)	Polarization (H/V)	Result
1674	-44.97	-13	-31.97	-47.77	-48.18	0.69	6.05	V	Pass
2510	-49.62	-13	-36.62	-58.03	-52.42	0.82	5.77	V	Pass
3346	-53.25	-13	-40.25	-64.19	-57.91	0.99	7.80	V	Pass



Band :	GSM1900	Temperature :	19~20°C
Test Mode :	GSM Link	Relative Humidity :	35~36%
Test Engineer :	Peter Qiu	Polarization :	Horizontal
Remark :	Spurious emissions within 30-1000MHz were found more than 20dB below limit line.		

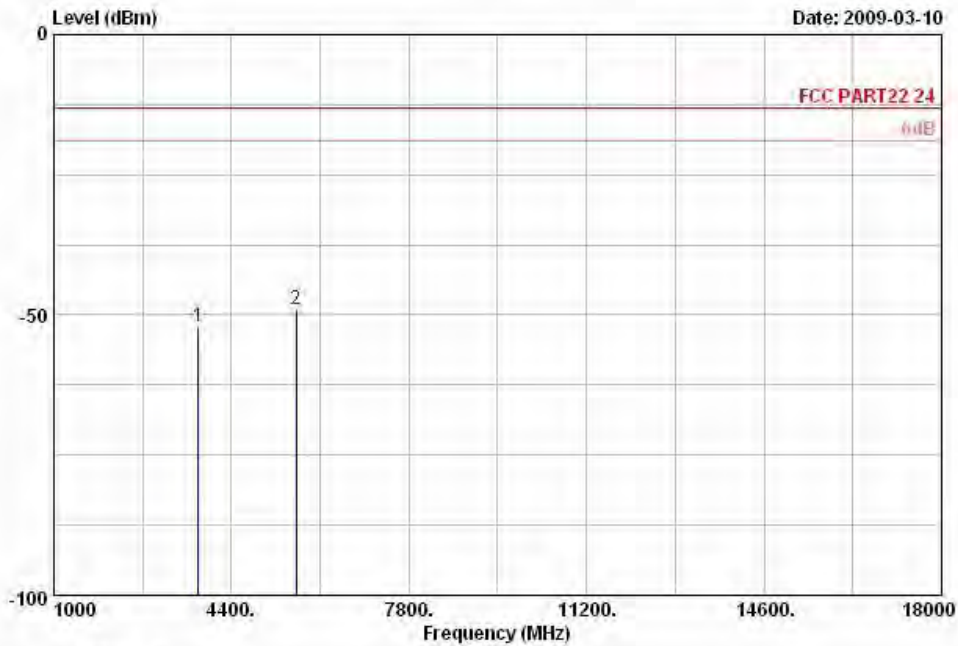

Site : 03CH01-KS
 Condition: FCC PART22 24 HF EIRP FACTOR-09020 HORIZONTAL

Frequency (MHz)	EIRP (dBm)	Limit (dBm)	Over Limit (dB)	SPA Reading (dBm)	S.G. Power (dBm)	TX Cable loss (dB)	TX Antenna Gain (dBi)	Polarization (H/V)	Result
3760	-52.17	-13	-39.17	-65.88	-60.10	0.11	8.04	H	Pass
5639	-48.94	-13	-35.94	-63.35	-57.72	1.22	10.00	H	Pass



Band :	GSM1900	Temperature :	19~20°C
Test Mode :	GSM Link	Relative Humidity :	35~36%
Test Engineer :	Peter Qiu	Polarization :	Vertical
Remark :	Spurious emissions within 30-1000MHz were found more than 20dB below limit line.		

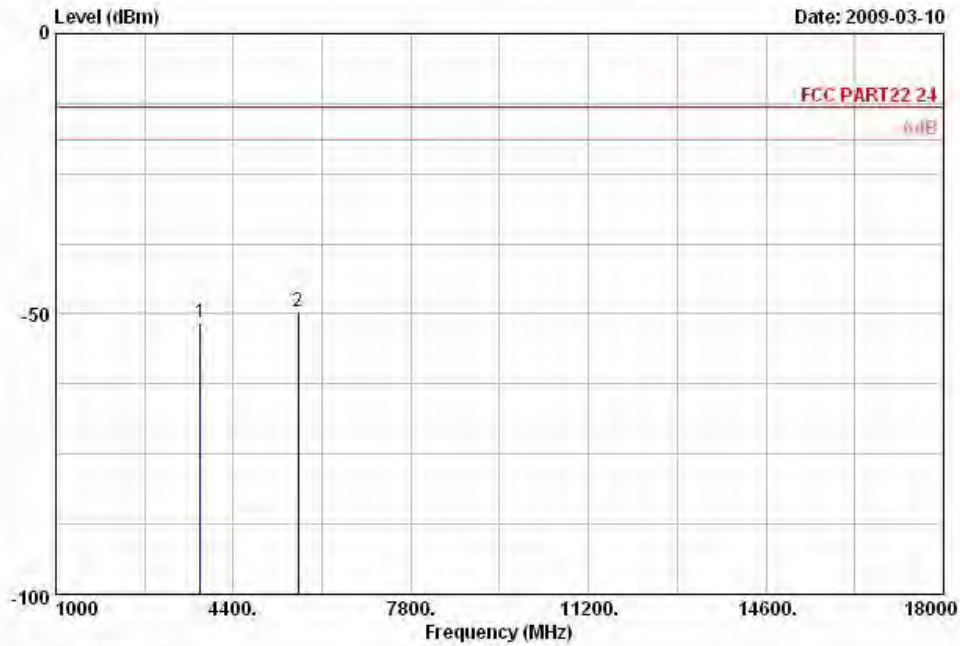

Site : 03CH01-K5
 Condition: FCC PART22 24 HF EIRP FACTOR-09020 VERTICAL

Frequency (MHz)	EIRP (dBm)	Limit (dBm)	Over Limit (dB)	SPA Reading (dBm)	S.G. Power (dBm)	TX Cable loss (dB)	TX Antenna Gain (dBi)	Polarization (H/V)	Result
3760	-51.50	-13	-38.50	-65.21	-59.43	0.11	8.04	V	Pass
5639	-49.61	-13	-36.61	-64.02	-58.39	1.22	10.00	V	Pass



Band :	GSM850	Temperature :	19~20°C
Test Mode :	GSM + BT Link	Relative Humidity :	35~36%
Test Engineer :	Peter Qiu	Polarization :	Horizontal
Remark :	Spurious emissions within 30-1000MHz were found more than 20dB below limit line.		

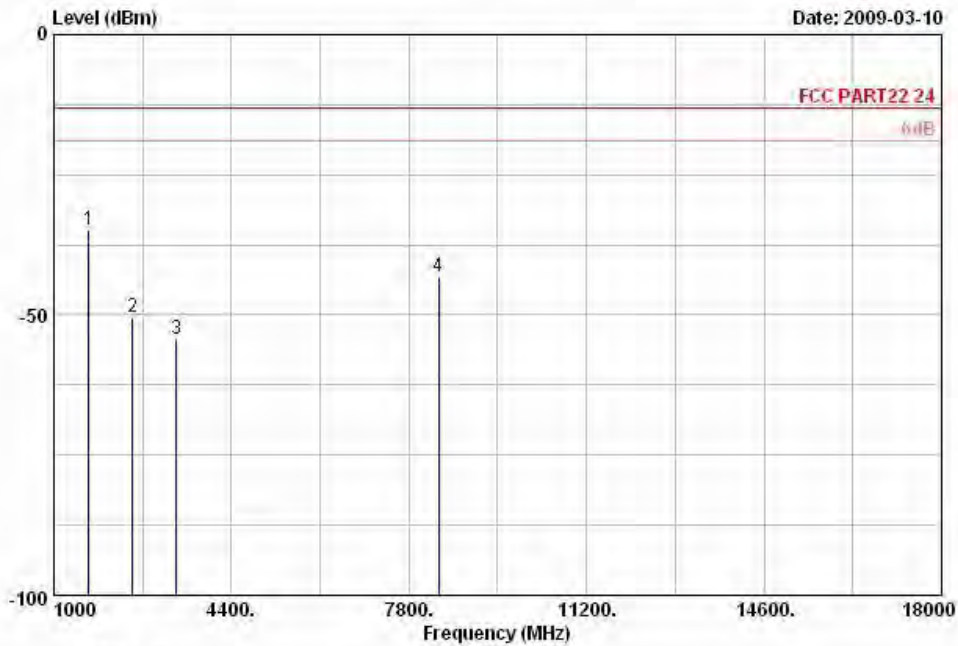

Site : 03CH01-KS
 Condition: FCC PART22 24 HF EIRP FACTOR-09020 HORIZONTAL

Frequency (MHz)	ERP (dBm)	Limit (dBm)	Over Limit (dB)	SPA Reading (dBm)	S.G. Power (dBm)	TX Cable loss (dB)	TX Antenna Gain (dBi)	Polarization (H/V)	Result
1674	-34.86	-13	-21.86	-42.66	-38.07	0.69	6.05	H	Pass
2510	-50.37	-13	-37.37	-58.78	-53.17	0.82	5.77	H	Pass
3344	-54.20	-13	-41.20	-65.14	-58.86	0.99	7.80	H	Pass
8364	-43.27	-13	-30.27	-62.38	-52.27	1.48	12.63	H	Pass



Band :	GSM850	Temperature :	19~20°C
Test Mode :	GSM + BT Link	Relative Humidity :	35~36%
Test Engineer :	Peter Qiu	Polarization :	Vertical
Remark :	Spurious emissions within 30-1000MHz were found more than 20dB below limit line.		

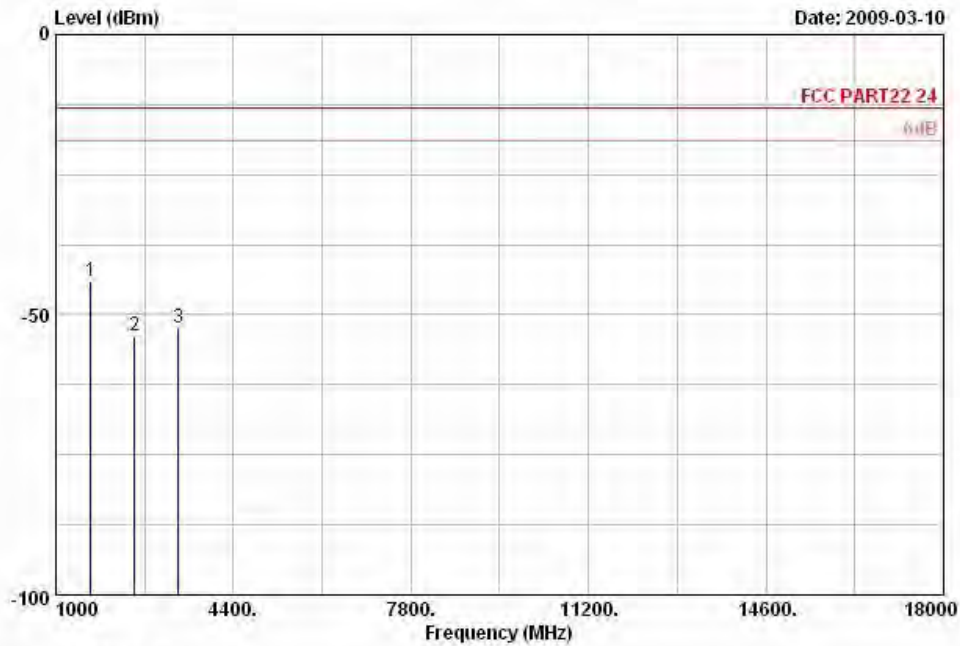

Site : 03CH01-K5
 Condition: FCC PART22 24 HF EIRP FACTOR-09020 VERTICAL

Frequency (MHz)	ERP (dBm)	Limit (dBm)	Over Limit (dB)	SPA Reading (dBm)	S.G. Power (dBm)	TX Cable loss (dB)	TX Antenna Gain (dBi)	Polarization (H/V)	Result
1672	-44.06	-13	-31.06	-51.86	-47.27	0.69	6.05	V	Pass
2510	-53.68	-13	-40.68	-62.09	-56.48	0.82	5.77	V	Pass
3344	-52.36	-13	-39.36	-63.30	-57.02	0.99	7.80	V	Pass

3.6 Frequency Stability Measurement

3.6.1 Description of Frequency Stability Measurement

The frequency stability shall be measured by variation of ambient temperature and variation of primary supply voltage to ensure that the fundamental emission stays within the authorized frequency block. The frequency stability of the transmitter shall be maintained within $\pm 0.00025\%$ ($\pm 2.5\text{ppm}$) of the center frequency.

3.6.2 Measuring Instruments

See list of measuring instruments of this test report.

3.6.3 Test Procedures for Temperature Variation

1. The EUT was set up in the thermal chamber and connected with the base station.
2. With power OFF, the temperature was decreased to -30°C and the EUT was stabilized for three hours. Power was applied and the maximum change in frequency was recorded within one minute.
3. With power OFF, the temperature was raised in 10°C step up to 50°C . The EUT was stabilized at each step for at least half an hour. Power was applied and the maximum frequency change was recorded within one minute.
4. If the EUT can not be turned on at -30°C , the testing lowest temperature will be raised in 10°C step until the EUT can be turned on.

3.6.4 Test Procedures for Voltage Variation

1. The EUT was placed in a temperature chamber at $25\pm 5^{\circ}\text{C}$ and connected with the base station.
2. The power supply voltage to the EUT was varied from BEP to 115% of the nominal value measured at the input to the EUT.
3. The variation in frequency was measured for the worst case.

3.6.5 Test Setup

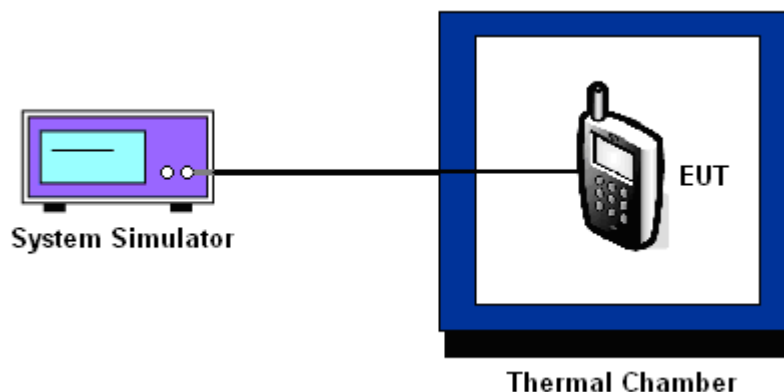



3.6.6 Test Result of Temperature Variation

Band :	GSM 850	Channel :	189
Limit (ppm) :	2.5		

Temperature (°C)	GSM		Result
	Freq. Dev. (Hz)	Deviation (ppm)	
-30	56	0.03	PASS
-20	58	0.07	
-10	52	0.06	
0	49	0.06	
10	45	0.05	
20	30	0.04	
30	22	0.03	
40	22	0.03	
50	22	0.03	

Band :	GSM 1900	Channel :	661
Limit (ppm) :	2.5		

Temperature (°C)	GSM		Result
	Freq. Dev. (Hz)	Deviation (ppm)	
-30	-67	-0.04	PASS
-20	-55	-0.03	
-10	-45	-0.02	
0	50	0.03	
10	46	0.02	
20	45	0.02	
30	-30	-0.02	
40	-25	-0.01	
50	-38	-0.02	

3.6.7 Test Result of Voltage Variation

Band & Channel	Mode	Voltage (Volt)	Freq. Dev. (Hz)	Deviation (ppm)	Limit (ppm)	Result
GSM 850 CH189	GSM	3.7	25.0	0.03	2.5	PASS
		BEP	34.0	0.04		
		4.2	29.0	0.03		
GSM 1900 CH661	GSM	3.7	-35.0	-0.02		
		BEP	33.0	0.02		
		4.2	-42.0	-0.02		

Remark:

1. Normal Voltage = 3.7V.
2. Battery End Point (BEP) = 3.3 V.



4 List of Measuring Equipment

Instrument	Manufacturer	Model No.	Serial No.	Characteristics	Calibration Date	Due Date	Remark
Spectrum Analyzer	R&S	FSP40	100319	9kHz~40GHz	Dec. 08, 2008	Dec. 07, 2009	Conducted (TH01-KS)
Power Meter	Agilent	E4416A	MY45101555	N/A	Jun. 18, 2007	Jun. 17, 2009	Conducted (TH01-KS)
Power Sensor	Agilent	E9327A	MY44421198	N/A	Jun. 12, 2007	Jun. 11, 2009	Conducted (TH01-KS)
Thermal Chamber	Ten Billion	TTC-B3S	TBN-930701	N/A	Dec. 15, 2008	Dec. 14, 2009	Conducted (TH01-KS)
DC Power Supply	TOPWARD	3306D	N/A	N/A	N/A	N/A	Conducted (TH01-KS)
Spectrum Analyzer	R&S	ESCI	100534	9kHz – 2.75GHz	Dec. 08, 2008	Dec. 07, 2009	Radiation (03CH01-KS)
Spectrum Analyzer	R&S	FSP40	100319	9kHz~40GHz	Dec. 08, 2008	Dec. 07, 2009	Radiation (03CH01-KS)
Bilog Antenna	SCHAFFNER	CBL6112D	23182	25MHz~2GHz	Dec. 17, 2008	Dec. 16, 2009	Radiation (03CH01-KS)
Double Ridge Horn Antenna	EMCO	3117	75959	1GHz~18GHz	Dec. 17, 2008	Dec. 16, 2009	Radiation (03CH01-KS)
Amplifier	Wireless	FPA6592G	600006	30MHz~2GHz	Dec. 17, 2008	Dec. 16, 2009	Radiation (03CH01-KS)
Amplifier	Agilent	8449B	3008A02370	1GHz~26.5GHz	Dec. 17, 2008	Dec. 16, 2009	Radiation (03CH01-KS)
System Simulator	R&S	CMU200	837587/066	Full-Band	Jan. 08, 2009	Jan. 07, 2011	Radiation (03CH01-KS)
Signal Generator	R&S	SMR40	100455	10MHz~40GHz	Aug. 29, 2007	Aug. 28, 2009	Radiation (03CH01-KS)

5 Uncertainty of Evaluation

Uncertainty of Radiated Emission Measurement (30 MHz ~ 1000 MHz)

Contribution	Uncertainty of x_i		$u(x_i)$
	dB	Probability Distribution	
Receiver reading	0.41	Normal(k=2)	0.21
Antenna factor calibration	0.83	Normal(k=2)	0.42
Cable loss calibration	0.25	Normal(k=2)	0.13
Pre Amplifier Gain calibration	0.27	Normal(k=2)	0.14
RCV/SPA specification	2.50	Rectangular	0.72
Antenna Factor Interpolation for Frequency	1.00	Rectangular	0.29
Site imperfection	1.43	Rectangular	0.83
Mismatch	+0.39/-0.41	U-shaped	0.28
Combined standard uncertainty Uc(y)	1.27		
Measuring uncertainty for a level of confidence of 95% U=2Uc(y)	2.54		

Uncertainty of Radiated Emission Measurement (1 GHz ~ 40 GHz)

Contribution	Uncertainty of x_i		$u(x_i)$	C_i	$C_i * u(x_i)$
	dB	Probability Distribution			
Receiver reading	±0.10	Normal(k=1)	0.10	1	0.10
Antenna factor calibration	±1.70	Normal(k=2)	0.85	1	0.85
Cable loss calibration	±0.50	Normal(k=2)	0.25	1	0.25
Receiver Correction	±2.00	Rectangular	1.15	1	1.15
Antenna Factor Directional	±1.50	Rectangular	0.87	1	0.87
Site imperfection	±2.80	Triangular	1.14	1	1.14
Mismatch Receiver VSWR $\Gamma_1 = 0.197$ Antenna VSWR $\Gamma_2 = 0.194$ Uncertainty = $20 \log(1 - \Gamma_1 * \Gamma_2)$	+0.34/-0.35	U-shaped	0.244	1	0.244
Combined standard uncertainty Uc(y)	2.36				
Measuring uncertainty for a level of confidence of 95% U=2Uc(y)	4.72				

6 Certification of TAF Accreditation



Certificate No. : 1.1190-081212

財團法人全國認證基金會
Taiwan Accreditation Foundation

Certificate of Accreditation

This is to certify that

Sporton International Inc.
EMC & Wireless Communications Laboratory
No.52, Hwa Ya 1st Rd., Hwa Ya Technology Park, Kwei-Shan Hsiang, Tao Yuan Hsien,
Taiwan, R.O.C.

is accredited in respect of laboratory

Accreditation Criteria	: ISO/IEC 17025:2005
Accreditation Number	: 1190
Originally Accredited	: December 15, 2003
Effective Period	: January 10, 2007 to January 09, 2010
Accredited Scope	: Testing Field, see described in the Appendix
Specific Accreditation Program	: Accreditation Program for Designated Testing Laboratory for Commodities Inspection Accreditation Program for Telecommunication Equipment Testing Laboratory Accreditation Program for BSMI Mutual Recognition Arrangement with Foreign Authorities

Jay-San Chen
President, Taiwan Accreditation Foundation
Date : December 12, 2008

Pl, total 18 pages

The Appendix forms an integral part of this Certificate, which shall be invalid when use without the Appendix



Appendix A. Photographs of EUT

Please refer to Sporton report number EP931114 as below.

1. External Photographs of EUT

Model Name: Doro PhoneEasy 345gsm



Model Name: Doro PhoneEasy 345gsm

Model Name: Doro PhoneEasy 345gsm



Model Name: Doro PhoneEasy 345gsm



Model Name: Doro PhoneEasy 345gsm



Model Name: Doro PhoneEasy 345gsm



2. Photographs of Accessories

Model Name: Doro PhoneEasy 345gsm



Model Name: Doro PhoneEasy 345gsm

Model Name: Doro PhoneEasy 345gsm



Model Name: Doro PhoneEasy 345gsm



Model Name: Doro PhoneEasy 345gsm



Model Name: Doro PhoneEasy 345gsm



Model Name: Doro PhoneEasy 345gsm



Model Name: Doro PhoneEasy 345gsm



Model Name: Doro PhoneEasy 345gsm

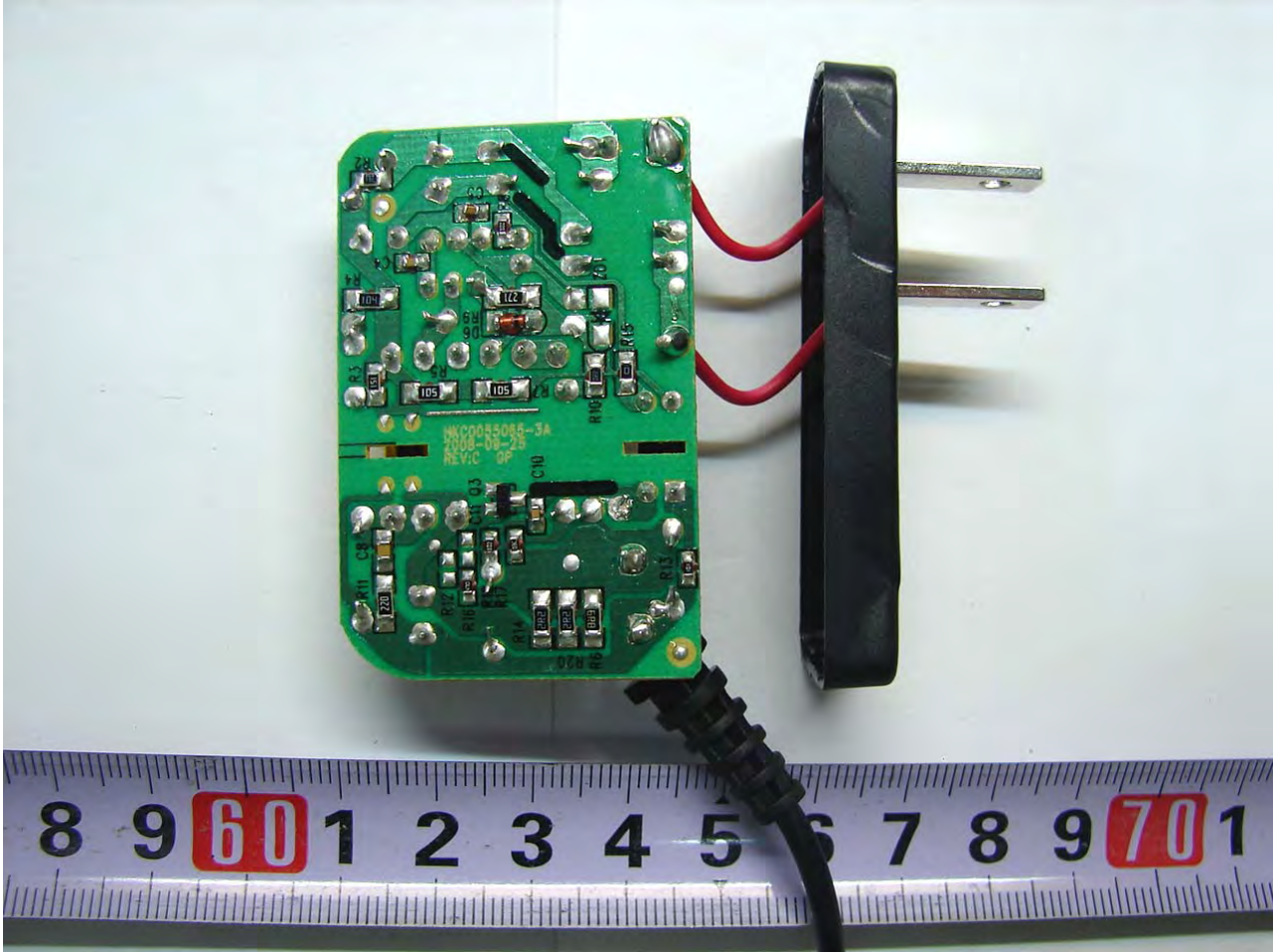

3. Internal Photographs of EUT

Model Name: Doro PhoneEasy 345gsm



Model Name: Doro PhoneEasy 345gsm



Model Name: Doro PhoneEasy 345gsm



Model Name: Doro PhoneEasy 345gsm



Model Name: Doro PhoneEasy 345gsm



Model Name: Doro PhoneEasy 345gsm



Model Name: Doro PhoneEasy 345gsm



Model Name: Doro PhoneEasy 345gsm



Model Name: Doro PhoneEasy 345gsm



Model Name: Doro PhoneEasy 345gsm



Model Name: Doro PhoneEasy 345gsm



Model Name: Doro PhoneEasy 345gsm

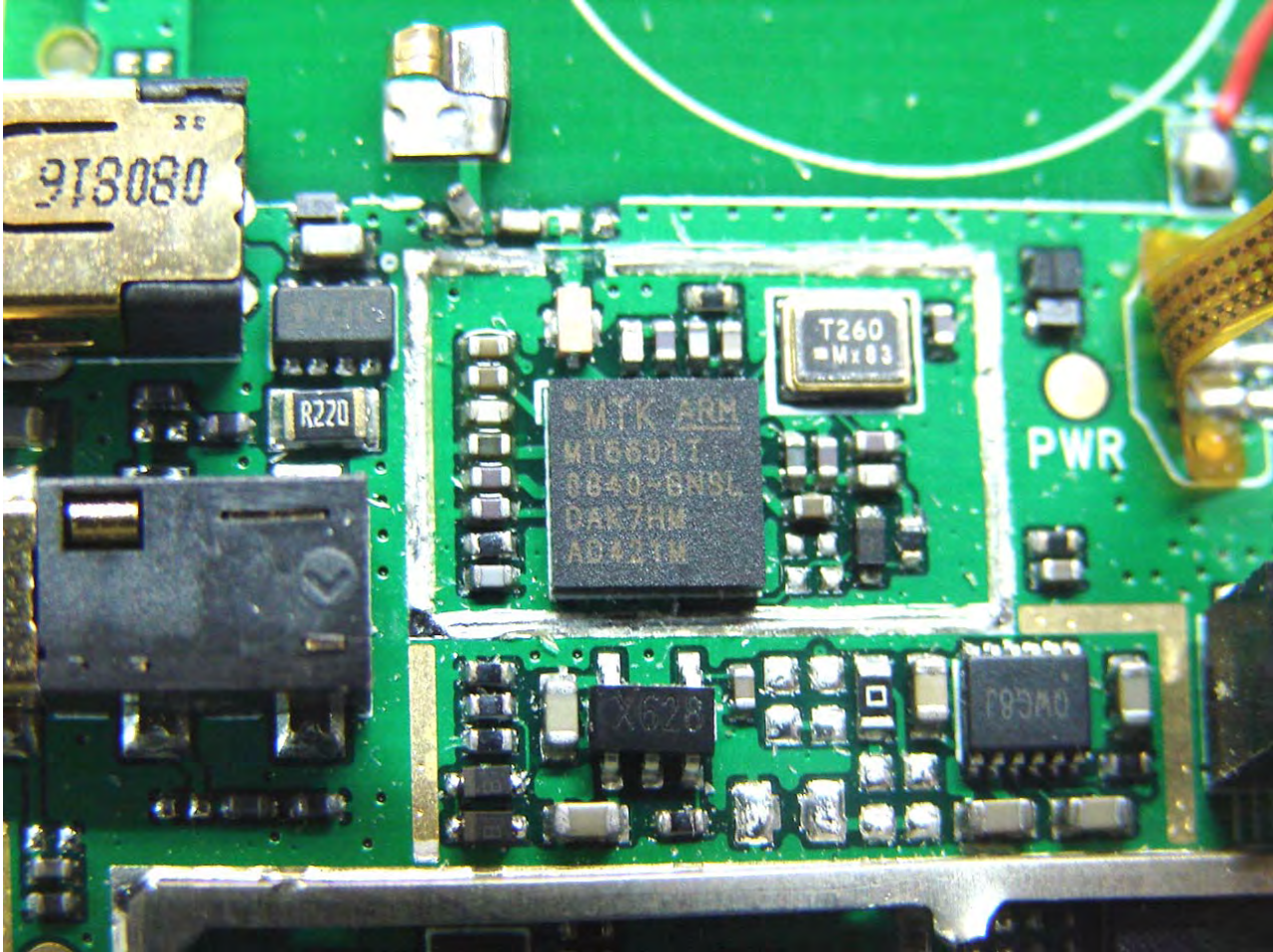

Model Name: Doro PhoneEasy 345gsm



Model Name: Doro PhoneEasy 345gsm

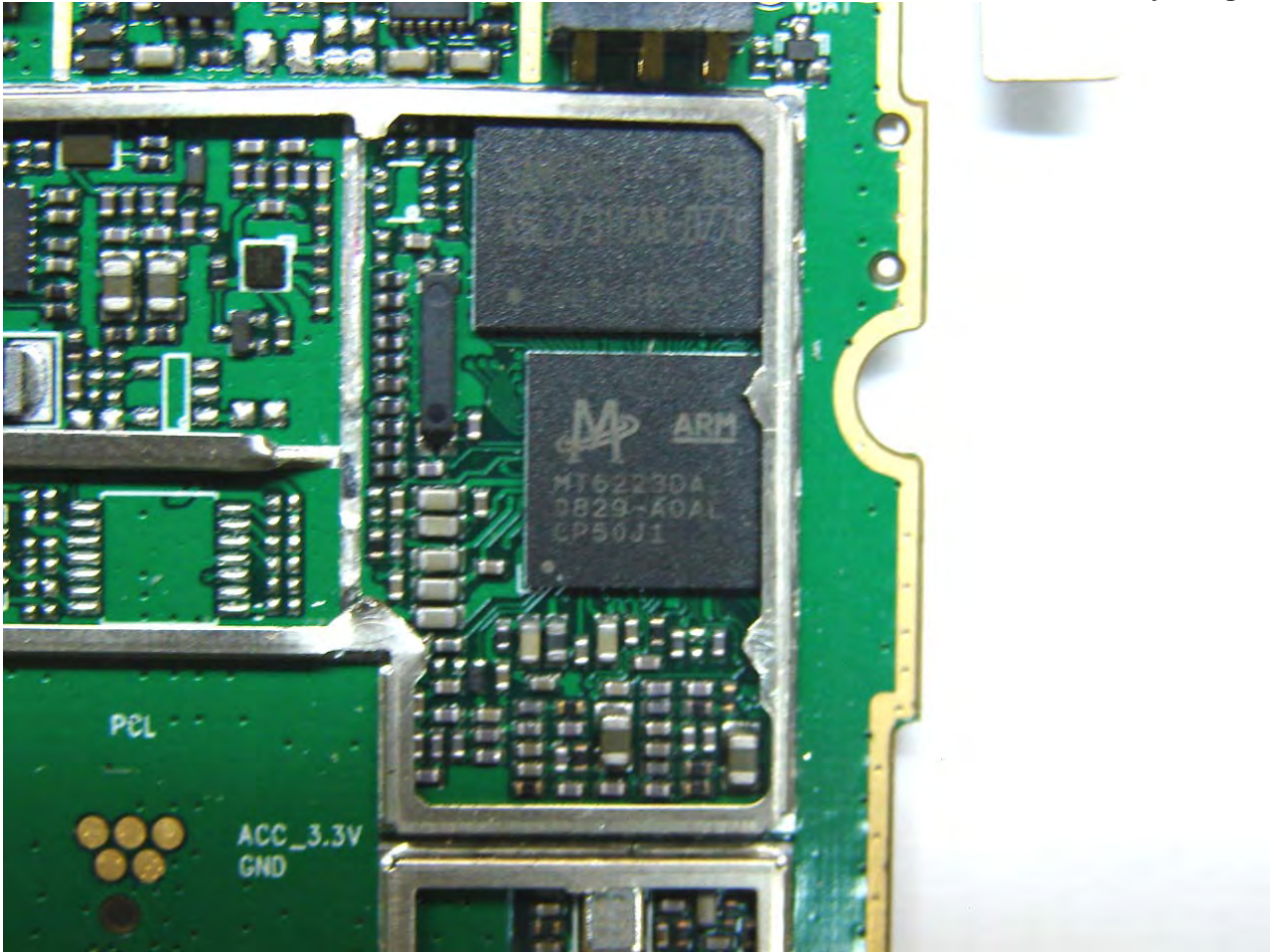

Model Name: Doro PhoneEasy 345gsm

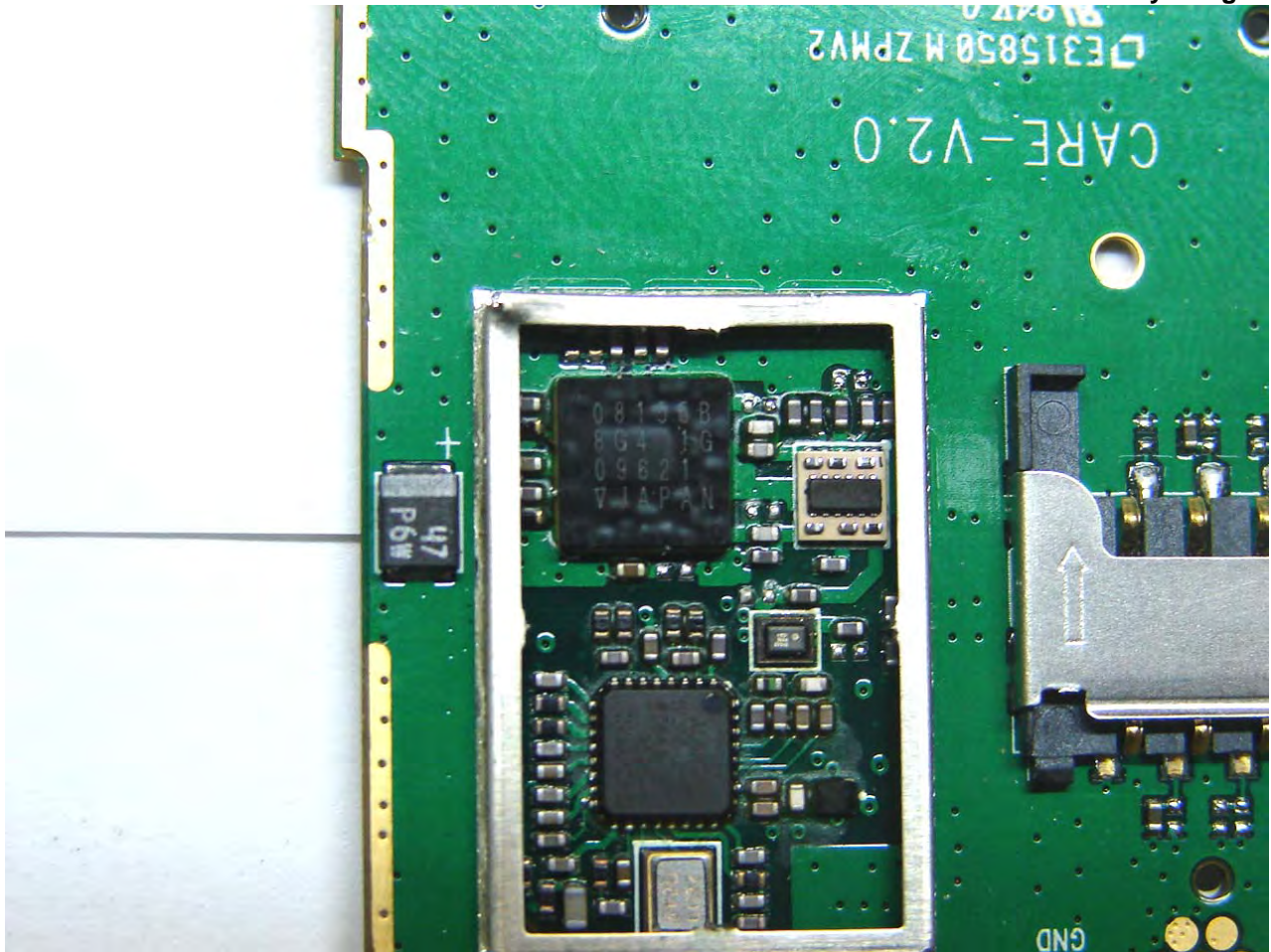

Model Name: Doro PhoneEasy 345gsm

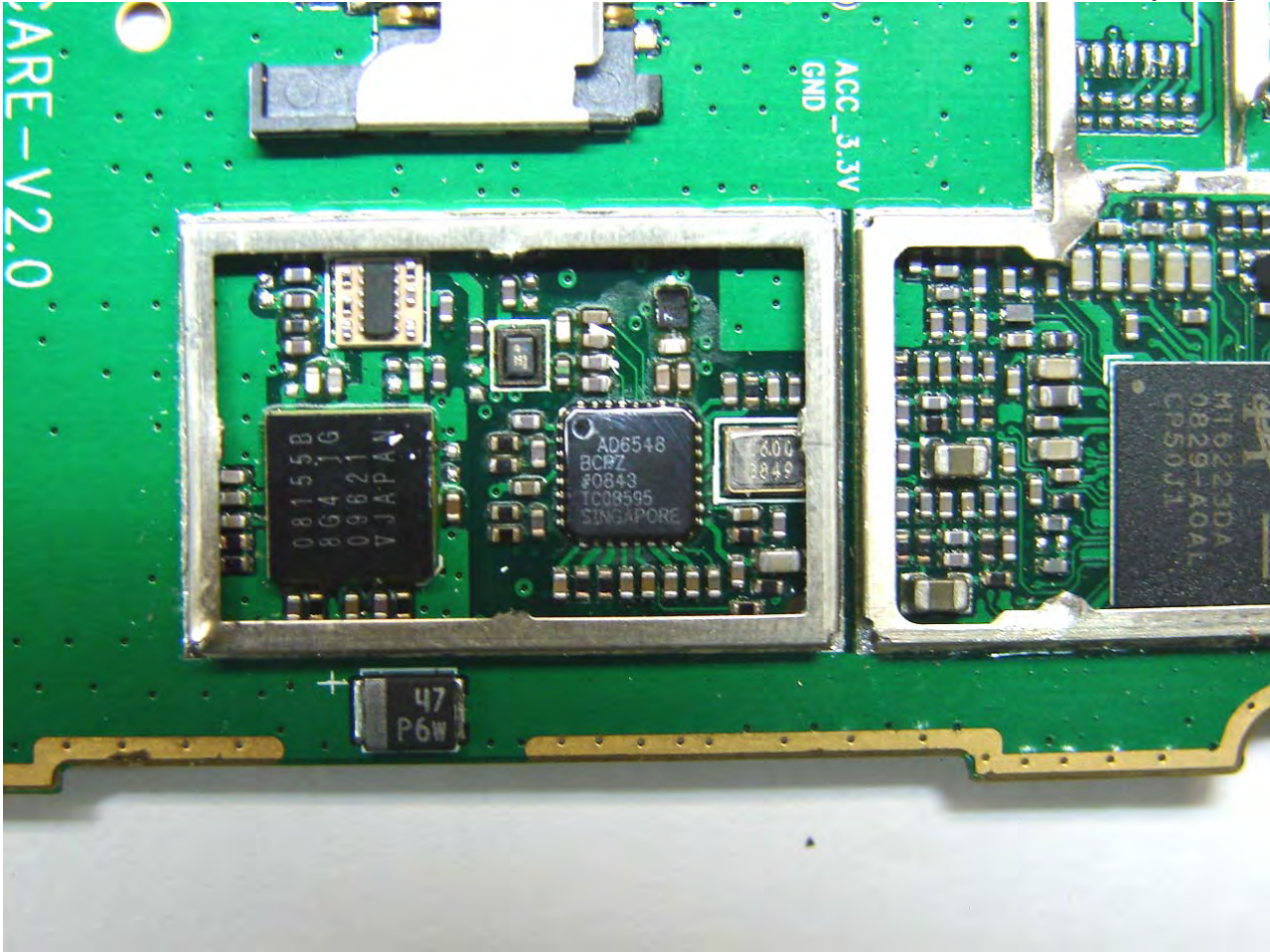

Model Name: Doro PhoneEasy 345gsm

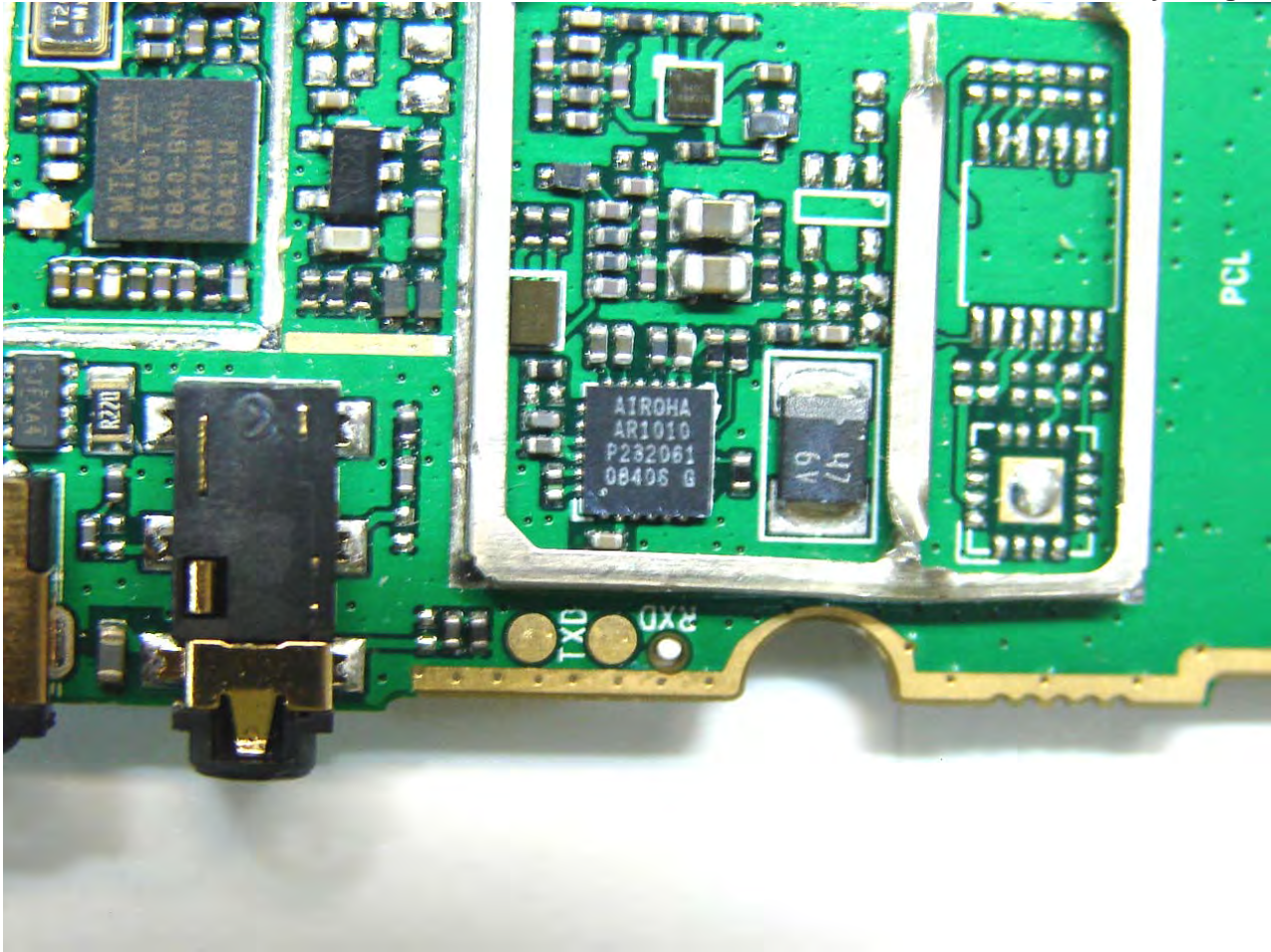

Model Name: Doro PhoneEasy 345gsm



Model Name: Doro PhoneEasy 345gsm



Model Name: Doro PhoneEasy 345gsm

GSM Ant.

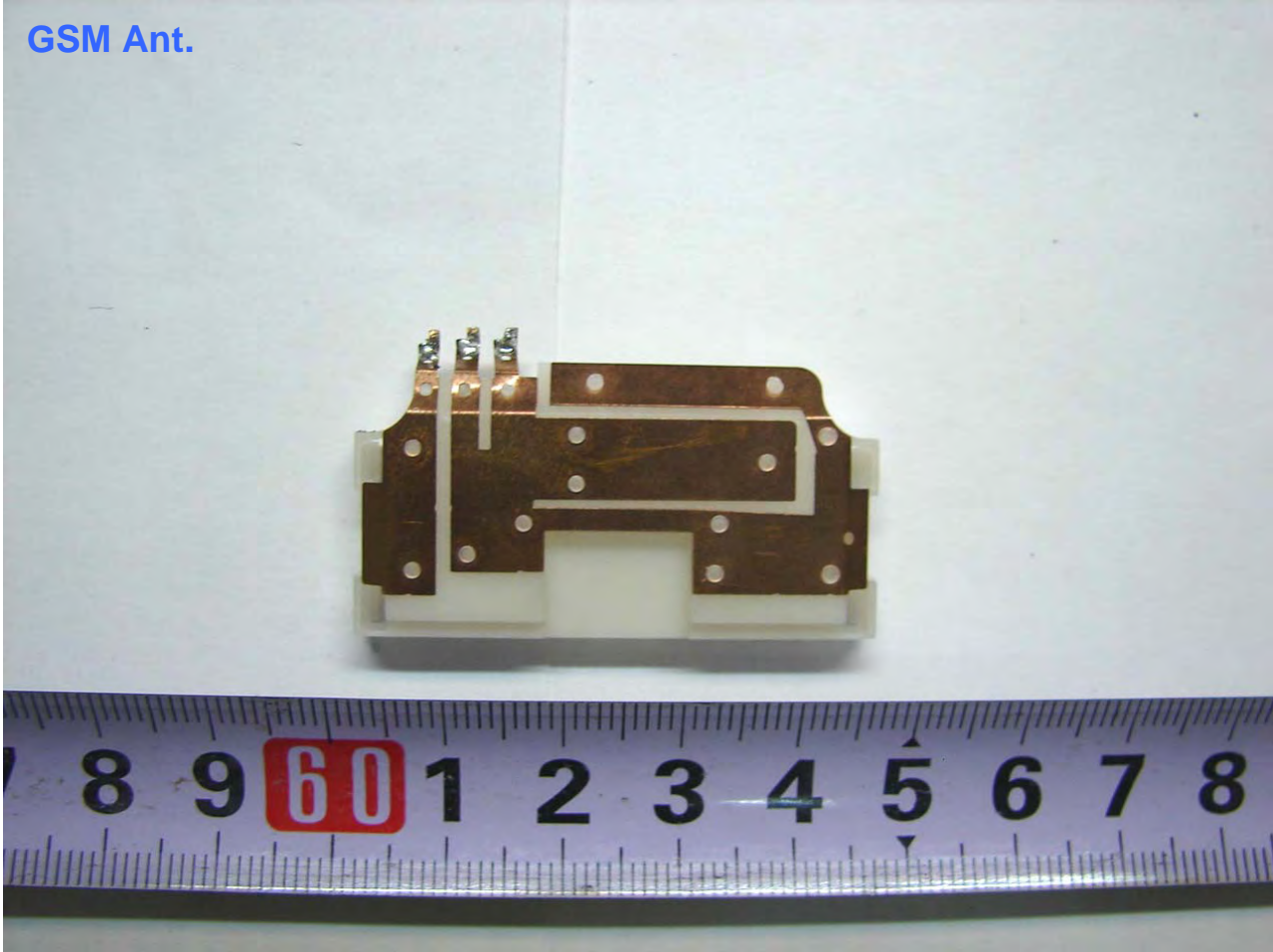

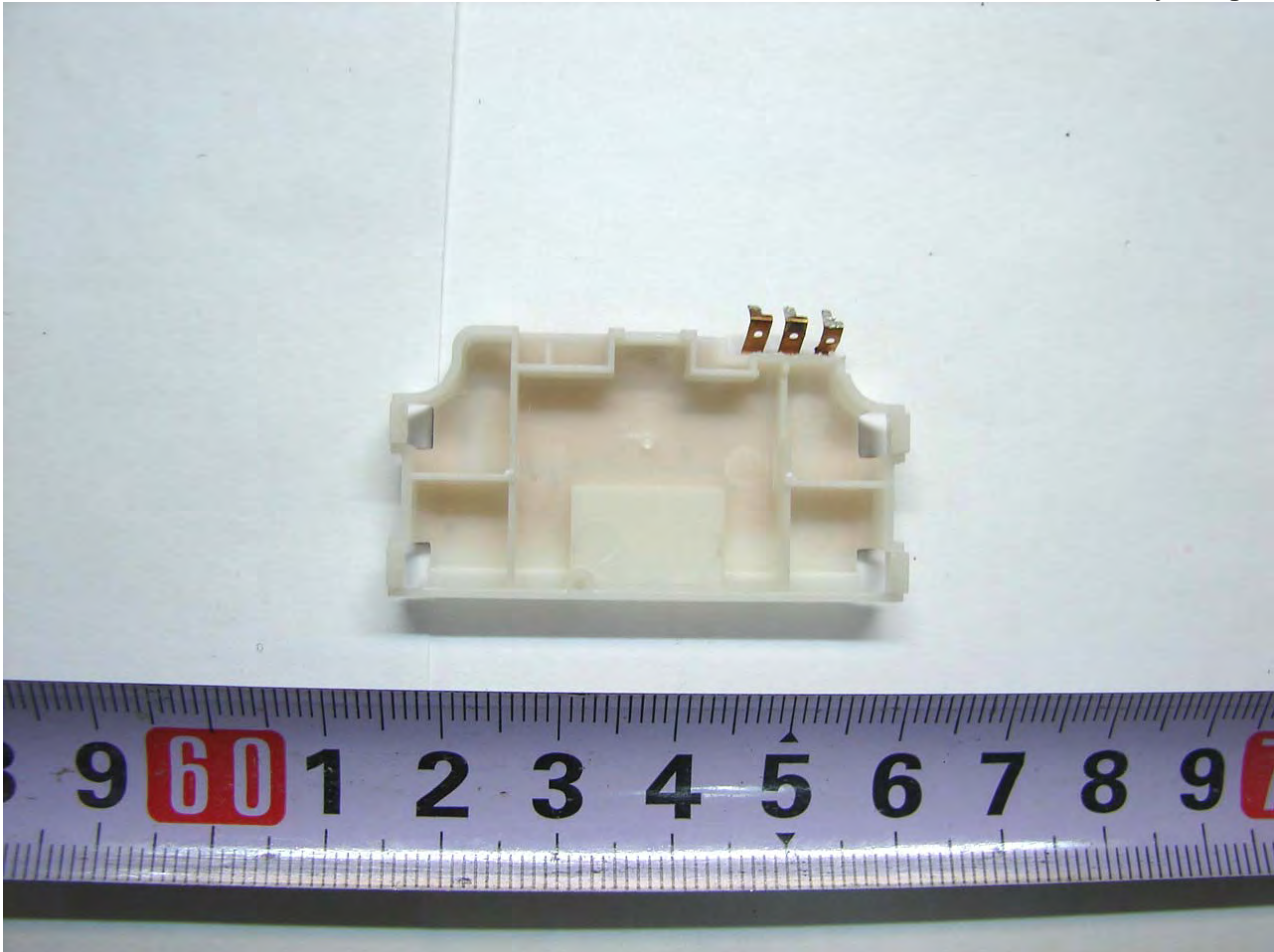
Model Name: Doro PhoneEasy 345gsm

Model Name: Doro PhoneEasy 345gsm

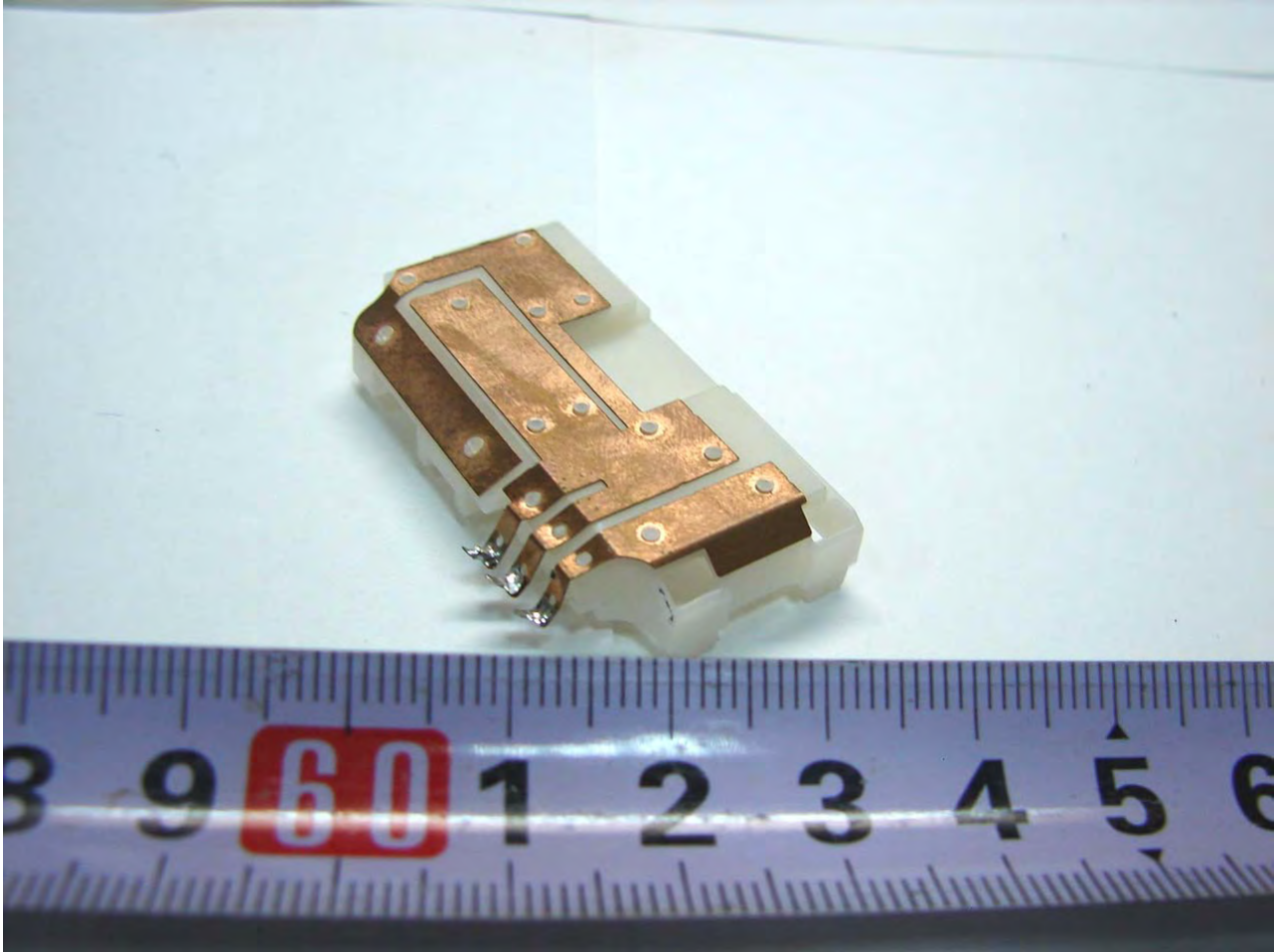

Model Name: Doro PhoneEasy 345gsm

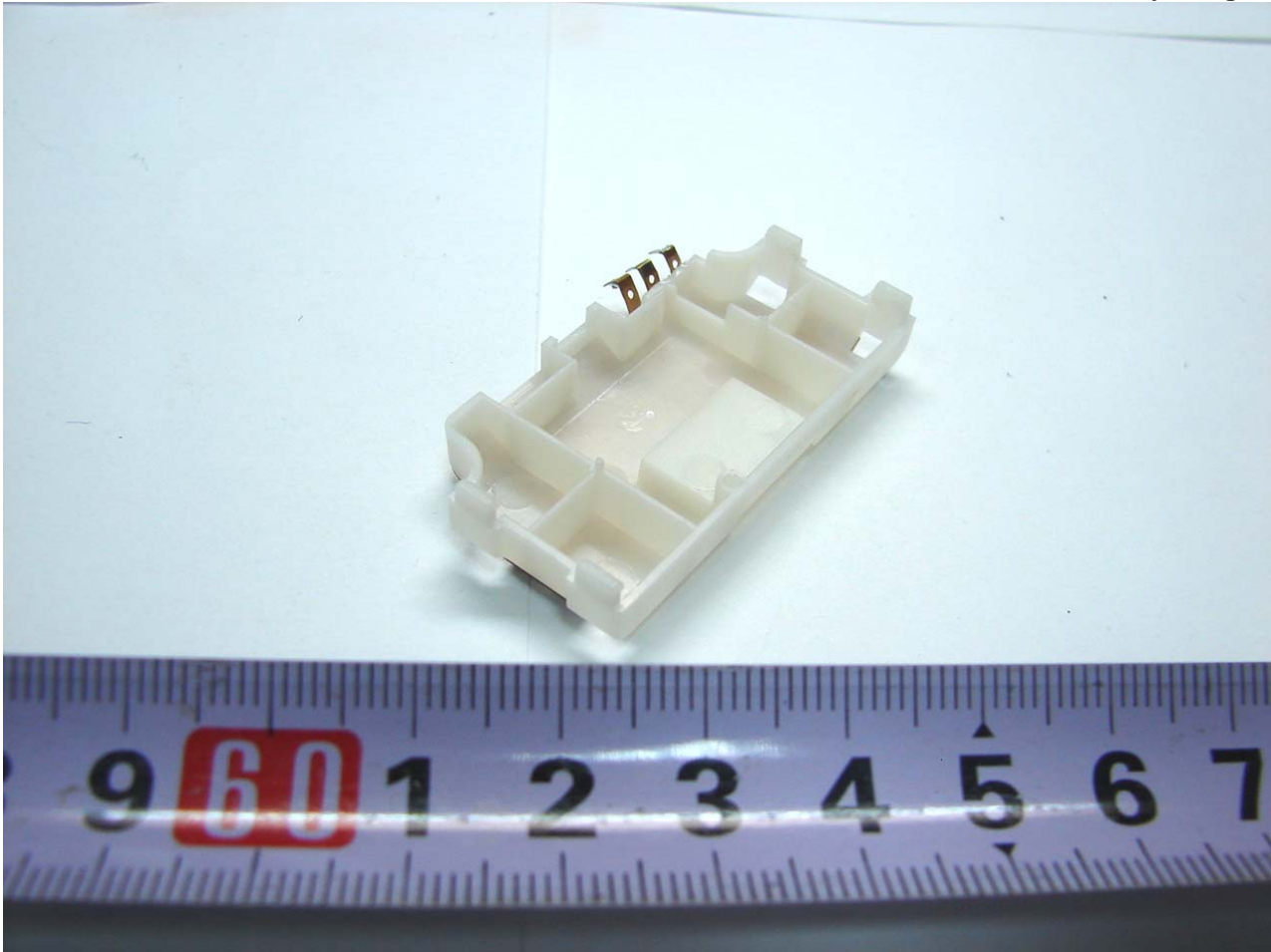

Model Name: Doro PhoneEasy 345gsm

BT Ant.

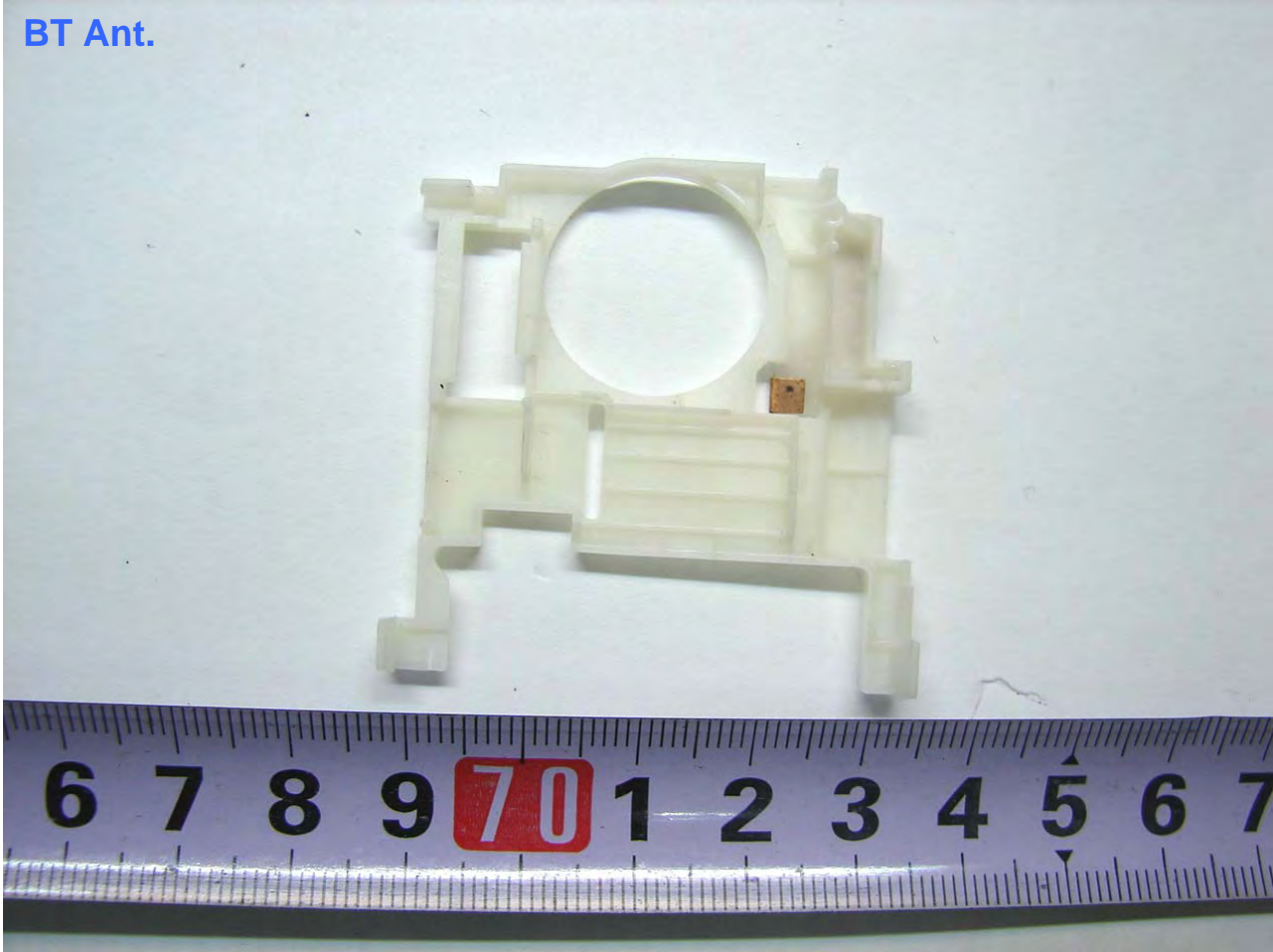

Model Name: Doro PhoneEasy 345gsm

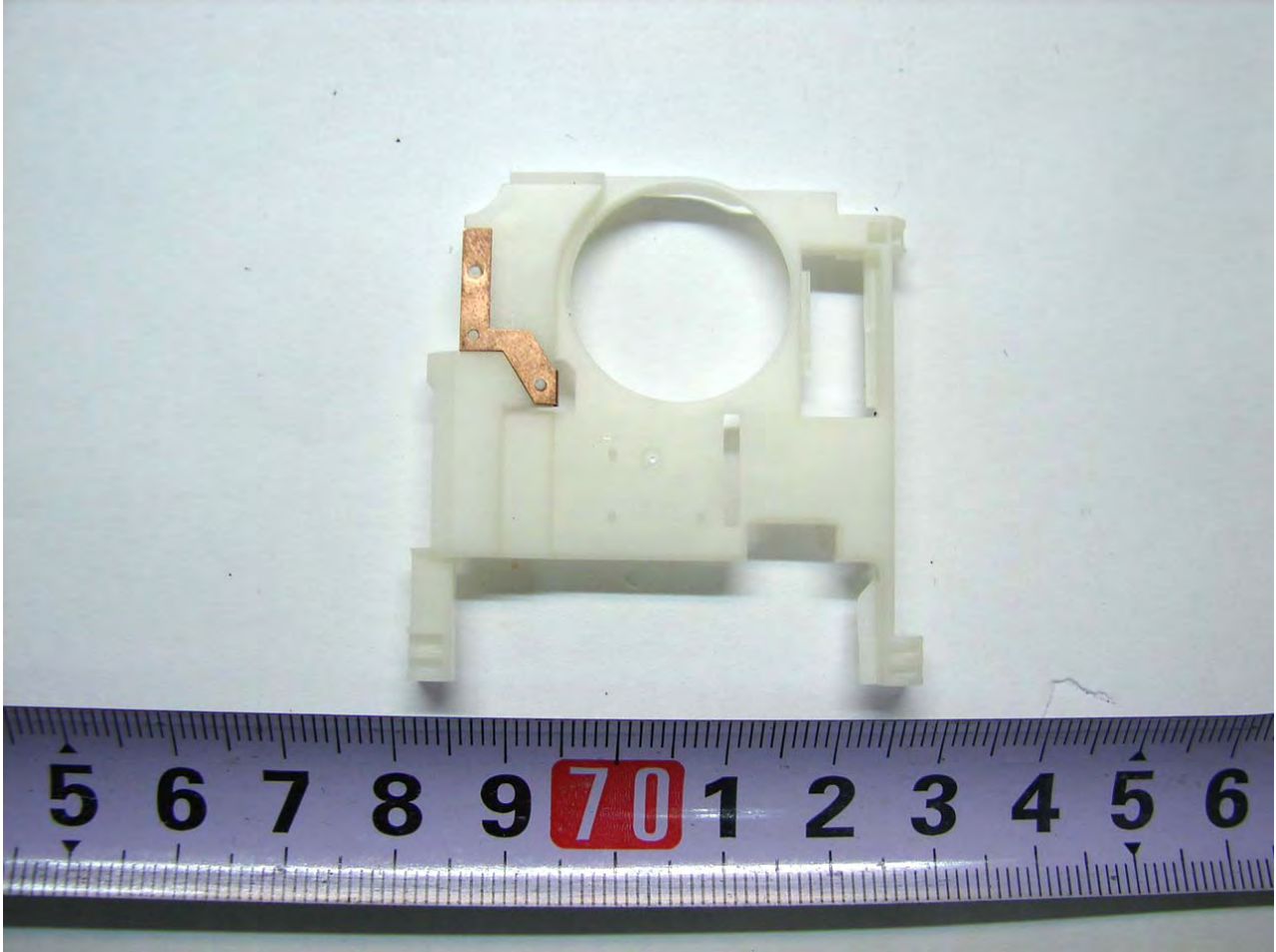

Model Name: Doro PhoneEasy 345gsm



Model Name: Doro PhoneEasy 345gsm

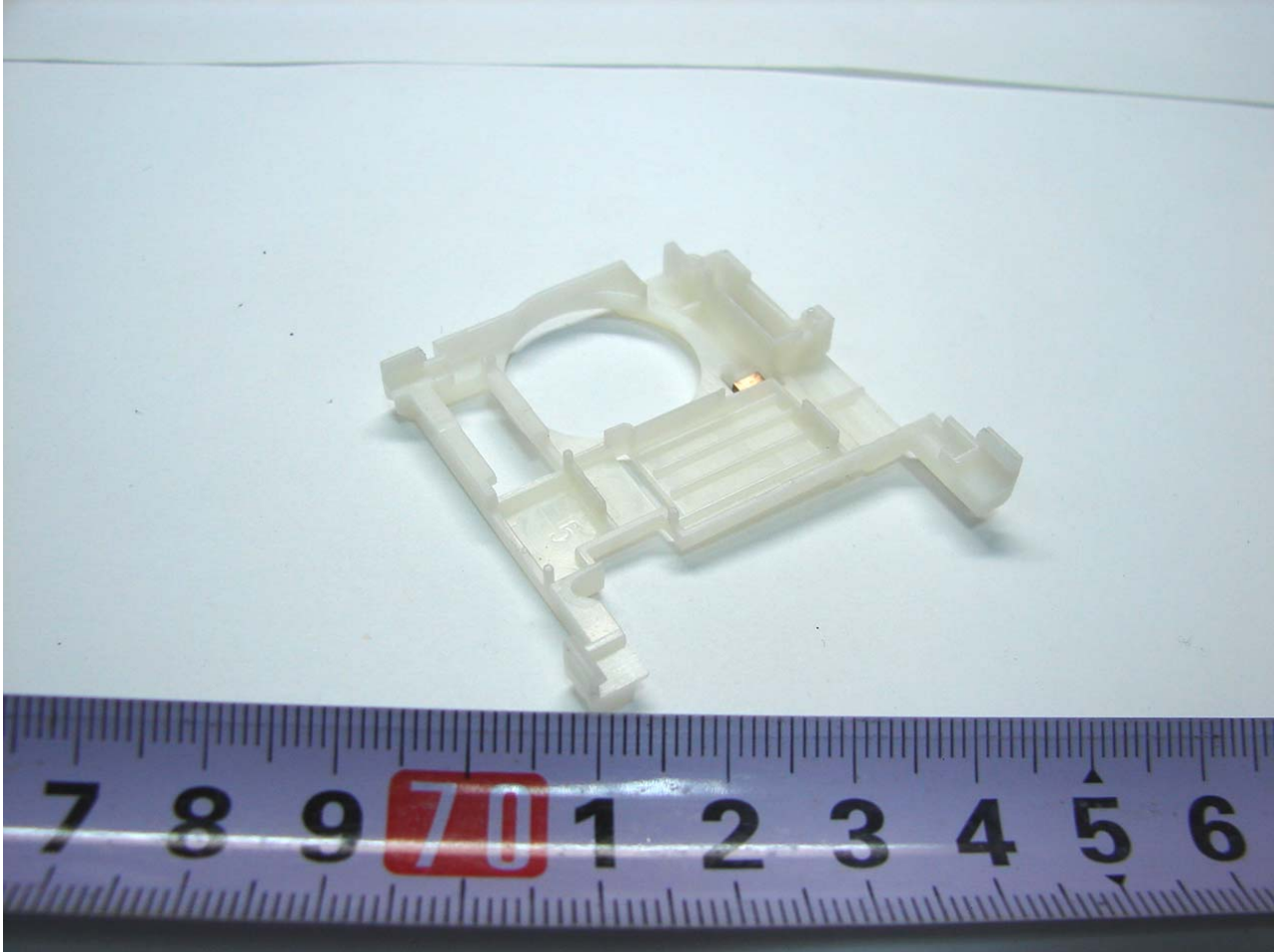

Model Name: Doro PhoneEasy 345gsm



Appendix B. Setup Photographs

<Radiated Emission>

GSM Link Mode

Front View

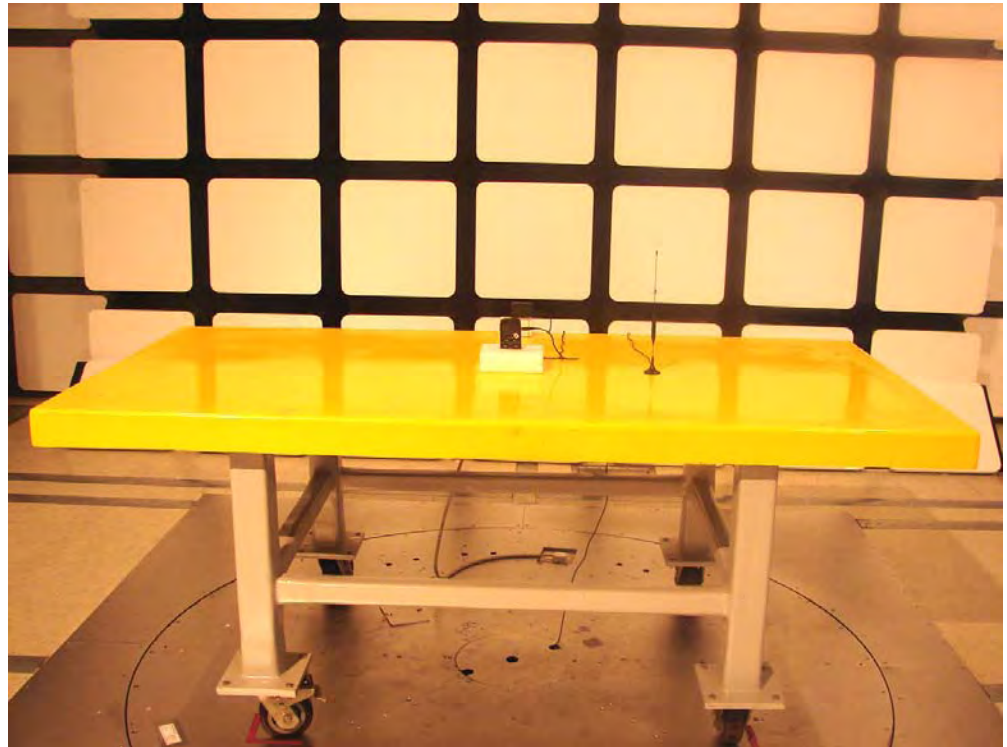

Rear View

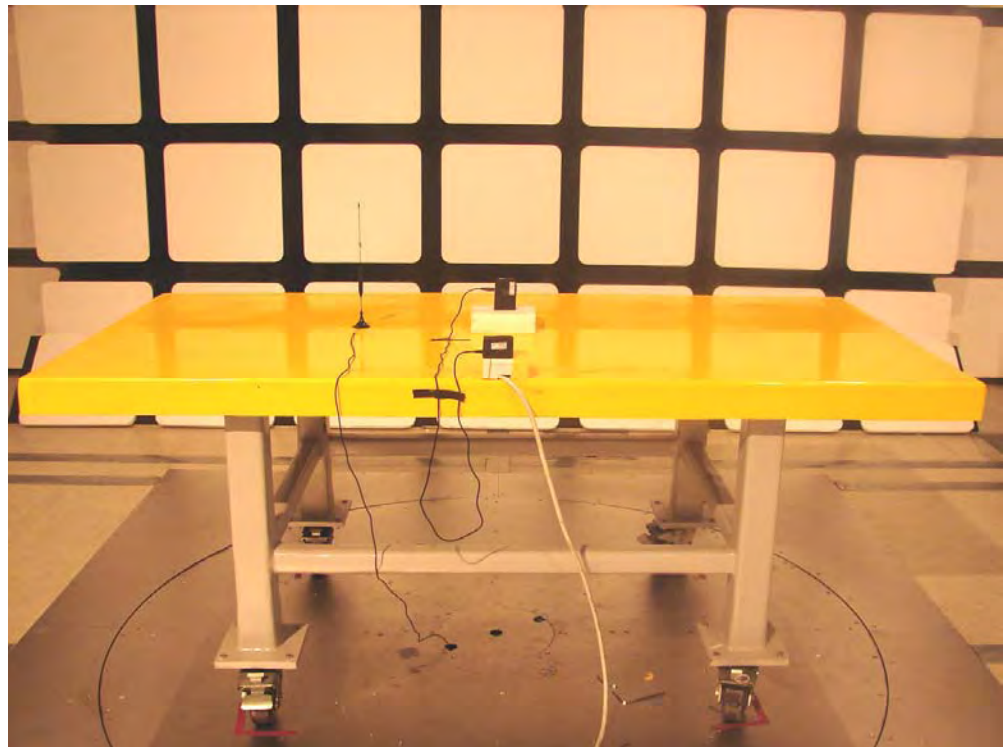

Remote View
(Below 1GHz)

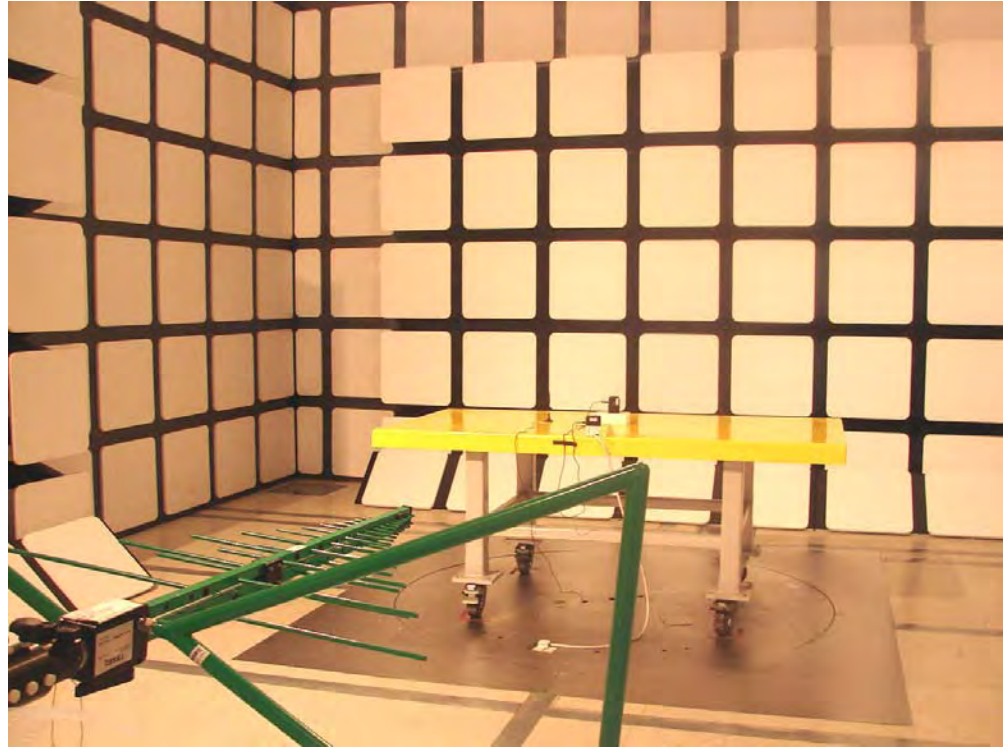

Remote View
(Above 1GHz)

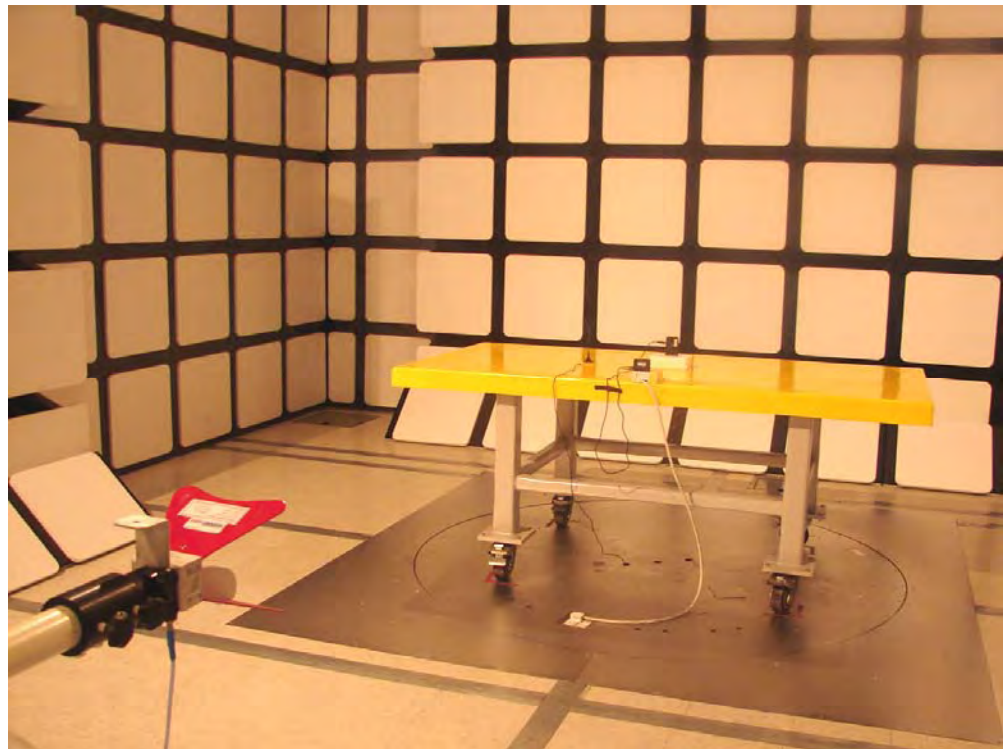

Co-location with BT Mode

Front View

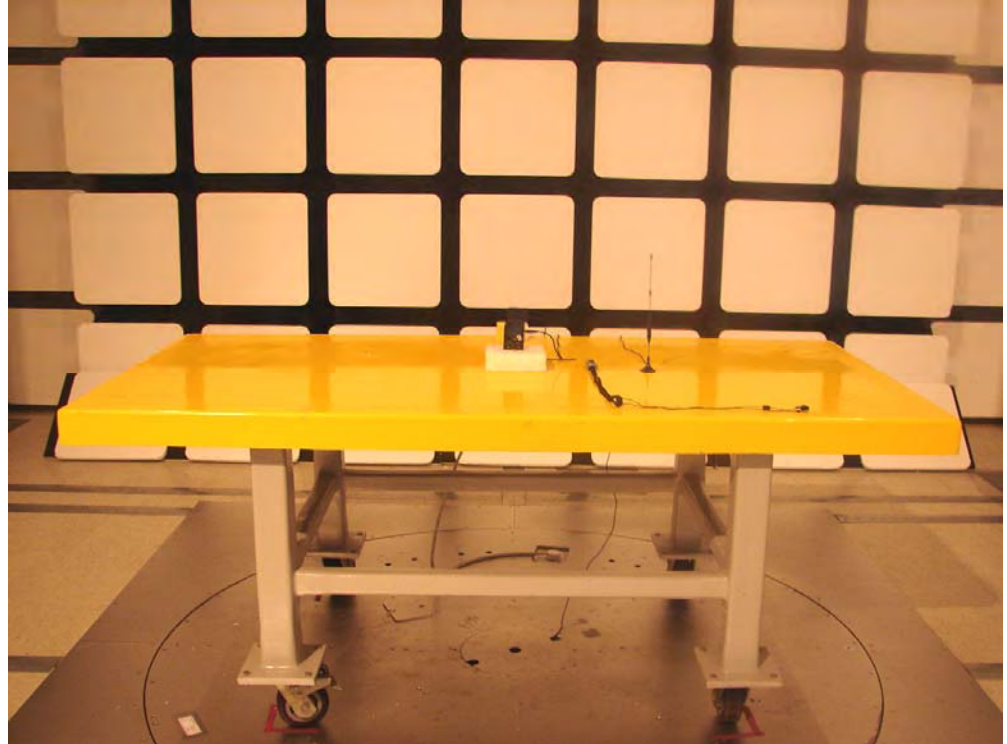

Rear View

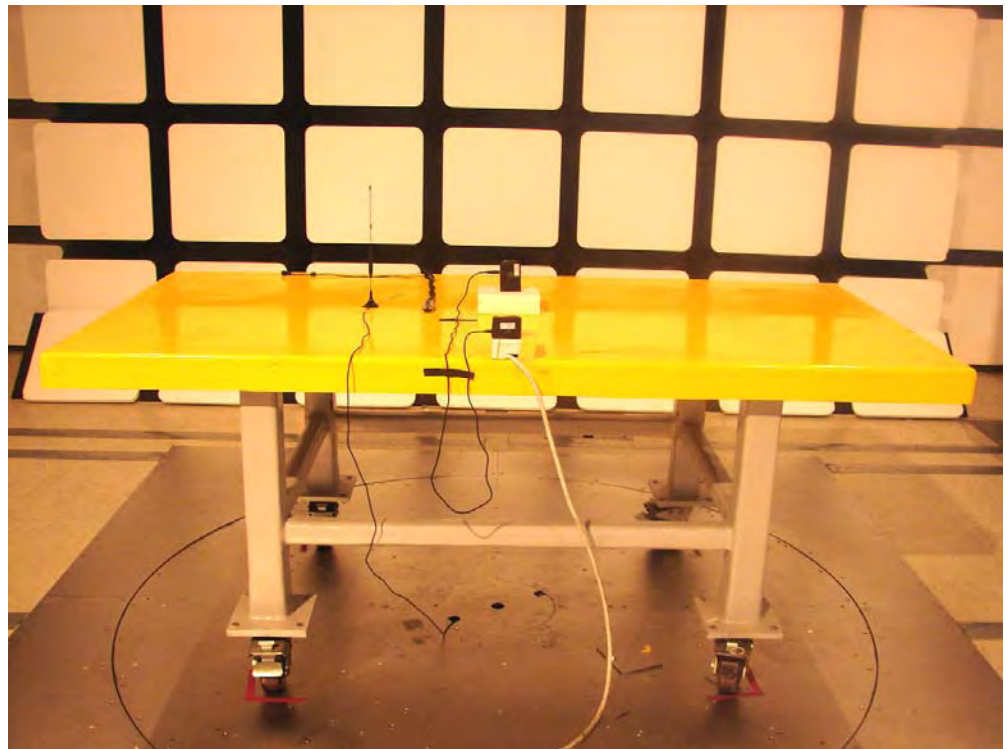

Remote View
(Below 1GHz)

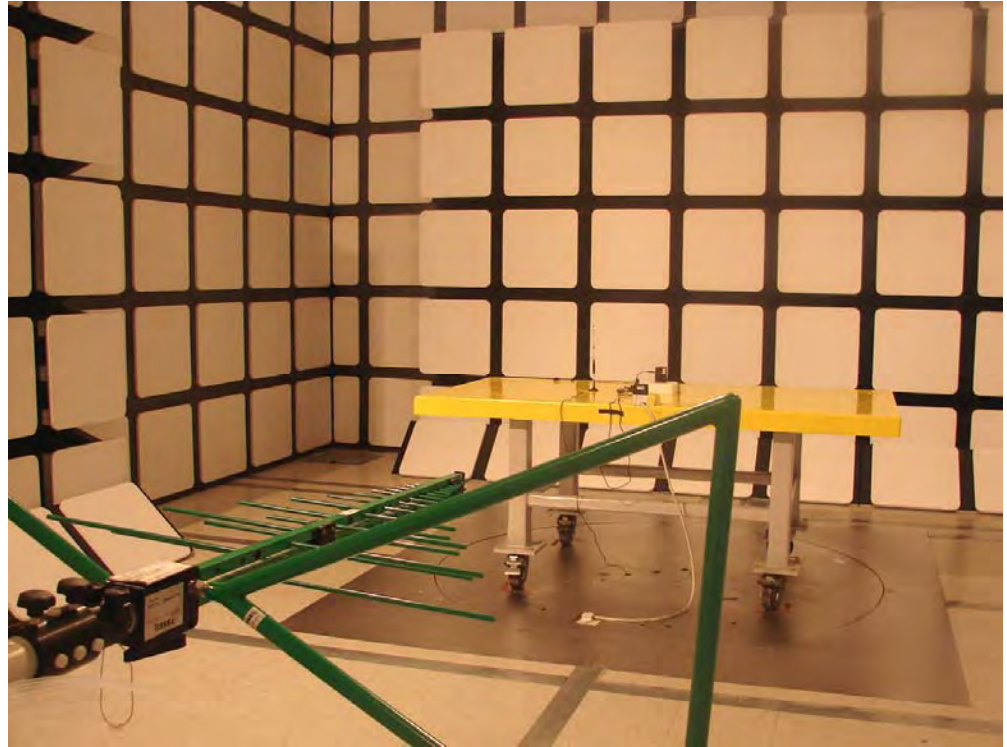

Remote View
(Above 1GHz)

