

FCC Test Report

EQUIPMENT : GSM Digital Mobile Telephone
BRAND NAME : Doro
MODEL NAME : Doro PhoneEasy 345gsm
FCC ID : WS5DORO345G
STANDARD : FCC 47 CFR part 2 (2.1093)
IEEE C95.1-1999
IEEE 1528-2003
OET Bulletin 65 Supplement C (Edition 01-01)
APPLICANT : Doro AB
Magistratsvägen 10, SE-226 43 Lund, Sweden

The product sample received on Mar. 09, 2009 and completely tested on Mar. 13, 2009. We, SPORTON INTERNATIONAL INC., would like to declare that the tested sample has been evaluated in accordance with the procedures and shown the compliance with the applicable technical standards.

The test results in this report apply exclusively to the tested model / sample. Without written approval of SPORTON INTERNATIONAL INC., the test report shall not be reproduced except in full.



Reviewed by: Roy Wu / Manager



SPORTON INTERNATIONAL INC.

No. 52, Hwa Ya 1st Rd., Hwa Ya Technology Park, Kwei-Shan Hsiang, Tao Yuan Hsien, Taiwan, R.O.C.



Table of Contents

1. Statement of Compliance4
2. Administration Data5
2.1 Testing Laboratory5
2.2 Applicant5
2.3 Manufacturer5
2.4 Application Details5
3. General Information6
3.1 Description of Device Under Test (DUT)6
3.2 Product Photos6
3.3 Applied Standards7
3.4 Device Category and SAR Limits7
3.5 Test Conditions7
3.5.1 Ambient Condition7
3.5.2 Test Configuration7
4. Specific Absorption Rate (SAR)8
4.1 Introduction8
4.2 SAR Definition8
5. SAR Measurement Setup9
5.1 DASY4 E-Field Probe System10
5.1.1 E-Field Probe Specification10
5.1.2 E-Field Probe Calibration11
5.2 DATA Acquisition Electronics (DAE)12
5.3 Robot12
5.4 Measurement Server12
5.5 SAM Twin Phantom13
5.6 Device Holder for SAM Twin Phantom14
5.7 Data Storage and Evaluation15
5.7.1 Data Storage15
5.7.2 Data Evaluation15
5.8 Test Equipment List17
6. Tissue Simulating Liquids18
7. Uncertainty Assessment20
8. SAR Measurement Evaluation22
8.1 Purpose of System Performance check22
8.2 System Setup22
8.3 Validation Results24
9. Description for DUT Testing Position25
10. Measurement Procedures27
10.1 Spatial Peak SAR Evaluation27
10.2 Scan Procedures28
10.3 SAR Averaged Methods28
11. SAR Test Results29
11.1 Conducted Power29
11.2 Test Records for Head SAR Test29
11.3 Test Records for Body SAR Test29
12. References30
Appendix A - System Performance Check Data
Appendix B - SAR Measurement Data
Appendix C - Calibration Data
Appendix D - Product Photos
Appendix E - Test Setup Photos



REVISION HISTORY

REPORT NO.	VERSION	DESCRIPTION	ISSUED DATE
FA931114	Rev. 01	Initial issue of report	Mar. 30, 2009
FA931114	Rev. 02	Update DUT Photos	Apr. 10, 2009

1. Statement of Compliance

The Specific Absorption Rate (SAR) maximum results found during testing for the **Doro AB GSM Digital Mobile Telephone Doro PhoneEasy 345gsm** are as follows (with expanded uncertainty 21.9%):

Band	Position	SAR (W/kg)
GSM850	Head	0.618
	Body	0.702
GSM1900	Head	0.193
	Body	0.617

They are in compliance with Specific Absorption Rate (SAR) for general population/uncontrolled exposure limits specified in FCC 47 CFR part 2 (2.1093) and IEEE C95.1-1999, and had been tested in accordance with the measurement methods and procedures specified in IEEE 1528-2003, and OET Bulletin 65 Supplement C (Edition 01-01).



2. Administration Data

2.1 Testing Laboratory

Company Name : Sporton International Inc.
Address : No. 52, Hwa-Ya 1st RD., Hwa Ya Technology Park, Kwei-Shan Hsiang, TaoYuan Hsien, Taiwan, R.O.C.
Test Site : SAR01-HY
Telephone Number : 886-3-327-3456
Fax Number : 886-3-328-4978

2.2 Applicant

Company Name : Doro AB
Address : Magistratsvägen 10, SE-226 43 Lund, Sweden

2.3 Manufacturer

Company Name : CK TELECOM LTD.
Address : Technology Road, High-Tech Development Zone, Heyuan, Guangdong, P.R.C.

2.4 Application Details

Date of reception of application: Mar. 09, 2009
Start of test : Mar. 13, 2009
End of test : Mar. 13, 2009

3. General Information

3.1 Description of Device Under Test (DUT)

Product Feature & Specification	
DUT Type	GSM Digital Mobile Telephone
Trade Name	Doro
Model Name	Doro PhoneEasy 345gsm
FCC ID	WS5DORO345G
Tx Frequency	GSM850 : 824 MHz ~ 849 MHz GSM1900 : 1850 MHz ~ 1910 MHz
Rx Frequency	GSM850 : 869 MHz ~ 894 MHz GSM1900 : 1930 MHz ~ 1990 MHz
Maximum Output Power to Antenna	GSM850 : 31.72 dBm GSM1900 : 29.71 dBm
Antenna Type	Fixed Internal Antenna
HW Version	CARE-V2.0
SW Version	CARE-S06_DORO345_L14EN_201_090223_MCP128+32_B T_FM
Type of Modulation	GMSK
DUT Stage	Identical Prototype

Accessories List:

Accessories Specification		
AC Adapter	Brand Name	Doro
	Model Name	HKC0055365-2A
	Power Rating	I/P:100-240Vac, 50-60Hz, 0.2A; O/P: 5.3Vdc, 650mA
	AC Power Cord Type	1.56 meter non-shielded cable without ferrite core
Battery	Brand Name	Doro
	Model Name	01.10.CAREP0103
	Power Rating	3.7Vdc, 850mAh
	Type	Li-ion

Remark: The above DUT's information was declared by manufacturer. Please refer to the specifications or user's manual for more detailed description.

3.2 Product Photos

Refer to Appendix D.



3.3 Applied Standards

The Specific Absorption Rate (SAR) testing specification, method and procedure for this GSM Digital Mobile Telephone is in accordance with the following standards:

- 47 CFR Part 2 (2.1093)
- IEEE C95.1-1999
- IEEE 1528-2003
- OET Bulletin 65 Supplement C (Edition 01-01)

3.4 Device Category and SAR Limits

This device belongs to portable device category because its radiating structure is allowed to be used within 20 centimeters of the body of the user. Limit for General Population/Uncontrolled exposure should be applied for this device, it is 1.6 W/kg as averaged over any 1 gram of tissue.

3.5 Test Conditions

3.5.1 Ambient Condition

Ambient Temperature	20-24°C
Humidity	<60%

3.5.2 Test Configuration

The device was controlled by using a base station emulator R&S CMU200. Communication between the device and the emulator was established by air link. The distance between the DUT and the antenna of the emulator is larger than 50 cm and the output power radiated from the emulator antenna is at least 30 dB smaller than the output power of DUT. The DUT was set from the emulator to radiate maximum output power during all tests.

4. Specific Absorption Rate (SAR)

4.1 Introduction

SAR is related to the rate at which energy is absorbed per unit mass in an object exposed to a radio field. The SAR distribution in a biological body is complicated and is usually carried out by experimental techniques or numerical modeling. The standard recommends limits for two tiers of groups, occupational/controlled and general population/uncontrolled, based on a person's awareness and ability to exercise control over his or her exposure. In general, occupational/controlled exposure limits are higher than the limits for general population/uncontrolled.

4.2 SAR Definition

The SAR definition is the time derivative (rate) of the incremental energy (dW) absorbed by (dissipated in) an incremental mass (dm) contained in a volume element (dv) of a given density.

ρ). The equation description is as below:

$$\text{SAR} = \frac{d}{dt} \left(\frac{dW}{dm} \right) = \frac{d}{dt} \left(\frac{dW}{\rho dv} \right)$$

SAR is expressed in units of Watts per kilogram (W/kg)

SAR measurement can be either related to the temperature elevation in tissue by

$$\text{SAR} = C \frac{\delta T}{\delta t}$$

, where C is the specific heat capacity, δT is the temperature rise and δt the exposure duration, or related to the electrical field in the tissue by

$$\text{SAR} = \frac{\sigma |E|^2}{\rho}$$

, where σ is the conductivity of the tissue, ρ is the mass density of the tissue and E is the rms electrical field strength.

However for evaluating SAR of low power transmitter, electrical field measurement is typically applied.

5. SAR Measurement Setup

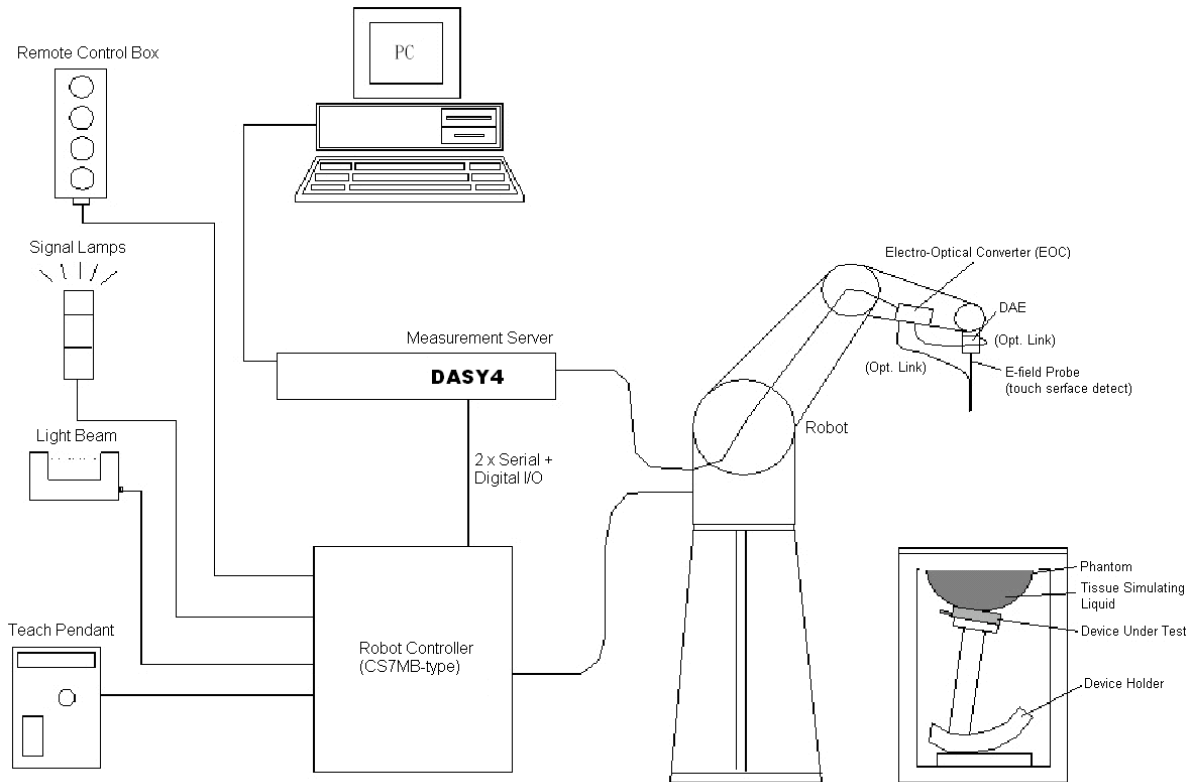

Fig. 5.1 DASY4 System

The DASY4 system for performance compliance tests is illustrated above graphically. This system consists of the following items:

- A standard high precision 6-axis robot with controller, a teach pendant and software
- A data acquisition electronic (DAE) attached to the robot arm extension
- A dosimetric probe equipped with an optical surface detector system
- The electro-optical converter (ECO) performs the conversion between optical and electrical signals
- A measurement server performs the time critical tasks such as signal filtering, control of the robot operation and fast movement interrupts.
- A probe alignment unit which improves the accuracy of the probe positioning
- A computer operating Windows XP
- DASY4 software
- Remote control with teach pendant and additional circuitry for robot safety such as warning lamps, etc.
- The SAM twin phantom
- A device holder
- Tissue simulating liquid
- Dipole for evaluating the proper functioning of the system

Some of the components are described in details in the following sub-sections.

5.1 DASY4 E-Field Probe System

The SAR measurement is conducted with the dosimetric probe (manufactured by SPEAG).The probe is specially designed and calibrated for use in liquid with high permittivity. The dosimetric probe has special calibration in liquid at different frequency. This probe has a built in optical surface detection system to prevent from collision with phantom.

**5.1.1 E-Field Probe Specification
<ET3DV6>**

Construction	Symmetrical design with triangular core Built-in optical fiber for surface detection system Built-in shielding against static charges PEEK enclosure material (resistant to organic solvents)	
Frequency	10 MHz to 3 GHz	
Directivity	± 0.2 dB in brain tissue (rotation around probe axis) ± 0.4 dB in brain tissue (rotation perpendicular to probe axis)	
Dynamic Range	5µW/g to 100mW/g; Linearity: ±0.2dB	
Surface Detection	± 0.2 mm repeatability in air and clear liquids on reflecting surface	
Dimensions	Overall length: 330mm Tip length: 16mm Body diameter: 12mm Tip diameter: 6.8mm Distance from probe tip to dipole centers: 2.7mm	
Application	General dosimetry up to 3GHz Compliance tests for mobile phones and Wireless LAN Fast automatic scanning in arbitrary phantoms	

Fig 5.2 Probe Setup on Robot



5.1.2 E-Field Probe Calibration

Each probe needs to be calibrated according to a dosimetric assessment procedure with accuracy better than ± 10%. The spherical isotropy shall be evaluated and within ± 0.25dB. The sensitivity parameters (NormX, NormY, and NormZ), the diode compression parameter (DCP) and the conversion factor (ConvF) of the probe are tested. The calibration data are as below:

ET3DV6 sn1787 (Cal: Aug. 26, 2008)			
Item	X axis	Y axis	Z axis
Sensitivity (µV)	1.63	1.67	2.18
Diode Compression Point (mV)	90	93	92
Conversion Factor (Head / Body)	Frequency (MHz)	X,Y,Z axis	
	800~1000	6.06 / 5.91	
	1650~1850	5.36 / 4.73	
	1850~2050	5.01 / 4.49	
	2350~2550	4.49 / 3.79	
Boundary Effect (Head / Body)	Frequency (MHz)	Alpha	Depth
	800~1000	0.30 / 0.31	2.80 / 2.98
	1650~1850	0.53 / 0.60	2.11 / 2.20
	1850~2050	0.59 / 0.68	1.96 / 1.95
	2350~2550	0.77 / 0.90	1.57 / 1.51

NOTE: The probe parameters have been calibrated by the SPEAG.

5.2 DATA Acquisition Electronics (DAE)

The data acquisition electronics (DAE) consists of a highly sensitive electrometer-grade preamplifier with auto-zeroing, a channel and gain-switching multiplexer, a fast 16 bit AD-converter and a command decoder and control logic unit. Transmission to the measurement server is accomplished through an optical downlink for data and status information as well as an optical uplink for commands and the clock.

The mechanical probe mounting device includes two different sensor systems for frontal and sideways probe contacts. They are used for mechanical surface detection and probe collision detection.

The input impedance of the DAE is 200M Ohm; the inputs are symmetrical and floating. Common mode rejection is above 80dB.

5.3 Robot

The DASY4 system uses the high precision robots RX90BL type out of the newer series from Stäubli SA (France). For the 6-axis controller DASY4 system, the CS7MB robot controller version from Stäubli is used. The RX robot series have many features that are important for our application:

- High precision (repeatability 0.02 mm)
- High reliability (industrial design)
- Jerk-free straight movements
- Low ELF interference (the closed metallic construction shields against motor control fields)
- 6-axis controller

5.4 Measurement Server

The DASY4 measurement server is based on a PC/104 CPU board with
166 MHz CPU
32 MB chipset and
64 MB RAM.

Communication with
the DAE electronic box
the 16-bit AD-converter system for optical detection and digital I/O interface.

The measurement server performs all the real-time data evaluation for field measurements and surface detection, controls robot movements and handles safety operations.

5.5 SAM Twin Phantom

The SAM twin phantom is a fiberglass shell phantom with 2mm shell thickness (except the ear region where shell thickness increases to 6mm). It has three measurement areas:

- Left head
- Right head
- Flat phantom

The bottom plate contains three pair of bolts for locking the device holder. The device holder positions are adjusted to the standard measurement positions in the three sections. A white cover is provided to tap the phantom during off-periods to prevent water evaporation and changes in the liquid parameters. On the phantom top, three reference markers are provided to identify the phantom position with respect to the robot.

The phantom can be used with the following tissue simulating liquids:

- *Water-sugar based liquid
- *Glycol based liquids

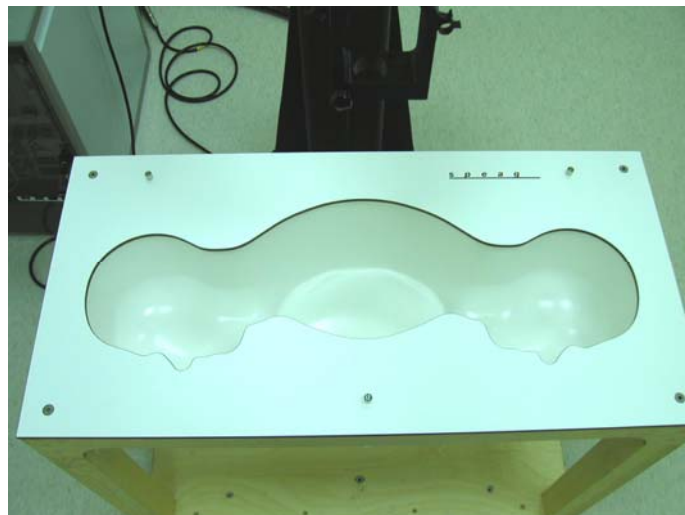

Fig. 5.3 Top View of Twin Phantom



Fig. 5.4 Bottom View of Twin Phantom

5.6 Device Holder for SAM Twin Phantom

The SAR in the Phantom is approximately inversely proportional to the square of the distance between the source and the liquid surface. For a source in 5 mm distance, a positioning uncertainty of $\pm 0.5\text{mm}$ would produce a SAR uncertainty of $\pm 20\%$. An accurate device position is therefore crucial for accurate and repeatable measurement. The position in which the devices must be measured, are defined by the standards.

The DASY4 device holder is designed to cope with different positions given in the standard. It has two scales for the device rotation (with respect to the body axis) and the device inclination (with respect to the line between the ear reference points). The rotation center for both scales is the ear reference point (EPR).

Thus the device needs no repositioning when changing the angles.

The DASY4 device holder has been made out of low-loss POM material having the following dielectric parameters: relative permittivity $\epsilon_r = 3$ and loss tangent $\delta = 0.02$. The amount of dielectric material has been reduced in the closest vicinity of the device, since measurements have suggested that the influence of the clamp on the test results could thus be lowered.



Fig. 5.5 Device Holder

5.7 Data Storage and Evaluation

5.7.1 Data Storage

The DASY4 software stores the assessed data from the data acquisition electronics as raw data (in microvolt readings from the probe sensors), together with all the necessary software parameters for the data evaluation (probe calibration data, liquid parameters and device frequency and modulation data) in measurement files with the extension. The post-processing software evaluates the desired unit and format for output each time the data is visualized or exported. This allows verification of the complete software setup even after the measurement and allows correction of erroneous parameter settings. For example, if a measurement has been performed with an incorrect crest factor parameter in the device setup, the parameter can be corrected afterwards and the data can be reevaluated.

The measured data can be visualized or exported in different units or formats, depending on the selected probe type (e.g., [V/m], [A/m], [mW/g]). Some of these units are not available in certain situations or give meaningless results, e.g., a SAR-output in a non-lose media, will always be zero. Raw data can also be exported to perform the evaluation with other software packages.

5.7.2 Data Evaluation

The DASY4 post-processing software (SEMCAD) automatically executes the following procedures to calculate the field units from the microvolt readings at the probe connector. The parameters used in the evaluation are stored in the configuration modules of the software :

Probe parameters :	- Sensitivity	$Norm_j, a_{\rho}, a_{j1}, a_{j2}$
	- Conversion factor	$ConvF_j$
	- Diode compression point	dcp_j
Device parameters :	- Frequency	f
	- Crest factor	cf
Media parameters :	- Conductivity	σ
	- Density	ρ

These parameters must be set correctly in the software. They can be found in the component documents or they can be imported into the software from the configuration files issued for the DASY4 components. In the direct measuring mode of the multi-meter option, the parameters of the actual system setup are used. In the scan visualization and export modes, the parameters stored in the corresponding document files are used.

The first step of the evaluation is a linearization of the filtered input signal to account for the compression characteristics of the detector diode. The compensation depends on the input signal, the diode type and the DC-transmission factor from the diode to the evaluation electronics. If the exciting field is pulsed, the crest factor of the signal must be known to correctly compensate for peak power.

The formula for each channel can be given as :

$$V_i = U_i + U_i^2 \cdot \frac{cf}{dcp_i}$$

with **V_i** = compensated signal of channel i ($i = x, y, z$)
 U_i = input signal of channel i ($i = x, y, z$)
 cf = crest factor of exciting field (DASY parameter)
 dcp_i = diode compression point (DASY parameter)

From the compensated input signals, the primary field data for each channel can be evaluated :

$$\text{E-field probes : } E_i = \sqrt{\frac{V_i}{Norm_i ConvF}}$$

$$\text{H-field probes : } H_i = \sqrt{V_i \frac{a_{i0} + a_{i1}f + a_{i2}f^2}{f}}$$

with **V_i** = compensated signal of channel i ($i = x, y, z$)
 $Norm_i$ = sensor sensitivity of channel i ($i = x, y, z$)
 $\mu V/(V/m)^2$ for E-field Probes
 $ConvF$ = sensitivity enhancement in solution
 a_{ij} = sensor sensitivity factors for H-field probes
 f = carrier frequency [GHz]
 E_i = electric field strength of channel i in V/m
 H_i = magnetic field strength of channel i in A/m

The RSS value of the field components gives the total field strength (Hermitian magnitude) :

$$E_{tot} = \sqrt{E_x^2 + E_y^2 + E_z^2}$$

The primary field data are used to calculate the derived field units.

$$SAR = E_{tot}^2 \cdot \frac{\sigma}{\rho \cdot 1000}$$

with **SAR** = local specific absorption rate in mW/g
 E_{tot} = total field strength in V/m
 σ = conductivity in [mho/m] or [Siemens/m]
 ρ = equivalent tissue density in g/cm^3

* Note that the density is set to 1, to account for actual head tissue density rather than the density of the tissue simulating liquid.

The power flow density is calculated assuming the excitation field to be a free space field.

$$P_{pwe} = \frac{E_{tot}^2}{3770} \quad \text{or} \quad P_{pwe} = H_{tot}^2 \cdot 37.7$$

with **P_{pwe}** = equivalent power density of a plane wave in mW/cm^2
 E_{tot} = total electric field strength in V/m
 H_{tot} = total magnetic field strength in A/m



5.8 Test Equipment List

Manufacturer	Name of Equipment	Type/Model	Serial Number	Calibration	
				Last Cal.	Due Date
SPEAG	Dosimetric E-Filed Probe	ET3DV6	1787	Aug. 26, 2008	Aug. 25, 2009
SPEAG	Dosimetric E-Filed Probe	ET3DV6	1788	Sep. 23, 2008	Sep. 22, 2009
SPEAG	Dosimetric E-Filed Probe	EX3DV3	3514	Jan. 21, 2009	Jan. 20, 2010
SPEAG	835MHz System Validation Kit	D835V2	499	Mar. 17, 2008	Mar. 16, 2010
SPEAG	900MHz System Validation Kit	D900V2	190	Jul. 16, 2007	Jul. 15, 2009
SPEAG	1800MHz System Validation Kit	D1800V2	2d076	Jul. 10, 2007	Jul. 09, 2009
SPEAG	1900MHz System Validation Kit	D1900V2	5d041	Mar. 28, 2008	Mar. 27, 2010
SPEAG	2000MHz System Validation Kit	D2000V2	1010	Sep. 17, 2008	Sep. 16, 2010
SPEAG	2300MHz System Validation Kit	D2300V2	1006	Sep. 12, 2007	Sep. 11, 2009
SPEAG	2450MHz System Validation Kit	D2450V2	736	Jul. 12, 2007	Jul. 11, 2009
SPEAG	2600MHz System Validation Kit	D2600V2	1008	Sep. 12, 2007	Sep. 11, 2009
SPEAG	3500MHz System Validation Kit	D3500V2	1014	Sep. 19, 2007	Sep. 18, 2009
SPEAG	5GHz System Validation Kit	D5GHzV2	1006	Jan. 24, 2008	Jan. 23, 2010
SPEAG	Data Acquisition Electronics	DAE3	577	Nov. 12, 2008	Nov. 11, 2009
SPEAG	Data Acquisition Electronics	DAE4	778	Sep. 22, 2008	Sep. 21, 2009
SPEAG	Device Holder	N/A	N/A	NCR	NCR
SPEAG	SAM Phantom	QD 000 P40 C	TP-1303	NCR	NCR
SPEAG	SAM Phantom	QD 000 P40 C	TP-1383	NCR	NCR
SPEAG	SAM Phantom	QD 000 P40 C	TP-1446	NCR	NCR
SPEAG	SAM Phantom	QD 000 P40 C	TP-1477	NCR	NCR
SPEAG	ELI4 Phantom	QD 0VA 001 BB	1026	NCR	NCR
SPEAG	ELI4 Phantom	QD 0VA 001 BA	1029	NCR	NCR
Agilent	PNA Series Network Analyzer	E8358A	US40260131	Apr. 02, 2008	Apr. 01, 2009
Agilent	Wireless Communication Test Set	E5515C	MY48360820	Dec. 15, 2008	Dec. 14, 2009
R&S	Universal Radio Communication Tester	CMU200	105934	Nov. 11, 2008	Nov. 10, 2009
Agilent	Dielectric Probe Kit	85070D	US01440205	NCR	NCR
Agilent	Dual Directional Coupler	778D	50422	NCR	NCR
AR	Power Amplifier	5S1G4M2	0328767	NCR	NCR
R&S	Power Meter	NRVD	101394	Oct. 20, 2008	Oct. 19, 2009
R&S	Power Sensor	NRV-Z1	100130	Oct. 20, 2008	Oct. 19, 2009

Table 5.1 Test Equipment List

6. Tissue Simulating Liquids

For the measurement of the field distribution inside the SAM phantom with DASY4, the phantom must be filled with around 25 liters of homogeneous tissue simulating liquid. The liquid height from the ear reference point (ERP) of the phantom to the liquid top surface is (head SAR) or from the flat phantom to the liquid top surface (body SAR) is 15.2cm.

The following ingredients for tissue simulating liquid are used:

- **Water:** deionized water (pure H₂O), resistivity $\geq 16\text{M}\Omega$ - as basis for the liquid
- **Sugar:** refined sugar in crystals, as available in food shops – to reduce relative permittivity
- **Salt:** pure NaCl – to increase conductivity
- **Cellulose:** Hydroxyethyl-cellulose, medium viscosity (75-125 mPa.s, 2% in water, 20°C), CAS#54290-to increase viscosity and to keep sugar in solution.
- **Preservative:** Preventol D-7 Bayer AG, D-51368 Leverkusen, CAS#55965-84-9- to prevent the spread of bacteria and molds.
- **DGMBE:** Deithlenglycol-monobuthyl ether (DGMBE), Fluka Chemie GmbH, CAS#112-34-5 – to reduce relative permittivity.

Table 6.1 gives the recipes for tissue simulating liquid.

Frequency (MHz)	Water (%)	Sugar (%)	Cellulose (%)	Salt (%)	Preventol (%)	DGMBE (%)	Conductivity (σ)	Permittivity (ϵ_r)
For Head								
835	40.3	57.9	0.2	1.4	0.2	0	0.90	41.5
900	40.3	57.9	0.2	1.4	0.2	0	0.97	41.5
1800, 1900, 2000	55.2	0	0	0.3	0	44.5	1.40	40.0
2450	55.0	0	0	0	0	45.0	1.80	39.2
For Body								
835	50.8	48.2	0	0.9	0.1	0	0.97	55.2
900	50.8	48.2	0	0.9	0.1	0	1.05	55.0
1800, 1900, 2000	70.2	0	0	0.4	0	29.4	1.52	53.3
2450	68.6	0	0	0	0	31.4	1.95	52.7

Table 6.1 Recipes of Tissue Simulating Liquid

Table 6.2 gives the targets for tissue simulating liquid.

Frequency (MHz)	Liquid Type	Conductivity (σ)	$\pm 5\%$ Range	Permittivity (ϵ_r)	$\pm 5\%$ Range
835	Head	0.90	0.86 ~ 0.95	41.5	39.4 ~ 43.6
900	Head	0.97	0.92 ~ 1.02	41.5	39.4 ~ 43.6
1800, 1900, 2000	Head	1.40	1.33 ~ 1.47	40.0	38.0 ~ 42.0
2450	Head	1.80	1.71 ~ 1.89	39.2	37.2 ~ 41.2
835	Body	0.97	0.92 ~ 1.02	55.2	52.4 ~ 58.0
900	Body	1.05	1.00 ~ 1.10	55.0	52.3 ~ 57.8
1800, 1900, 2000	Body	1.52	1.44 ~ 1.60	53.3	50.6 ~ 56.0
2450	Body	1.95	1.85 ~ 2.05	52.7	50.1 ~ 55.3

Table 6.2 Targets of Tissue Simulating Liquid

The dielectric parameters of the liquids were verified prior to the SAR evaluation using an Agilent 85070D Dielectric Probe Kit and an Agilent Network Analyzer.

Table 6.3 shows the measuring results for simulating liquid.

Band	Position	Temperature (°C)	Frequency (MHz)	Conductivity (σ)	Permittivity (ϵ_r)	Measurement date
GSM850	Head	21.4	824.2	0.885	41.4	Mar. 13, 2009
			836.4	0.897	41.3	
			848.8	0.909	41.2	
	Body	21.4	824.2	0.963	53.0	Mar. 13, 2009
			836.4	0.977	52.9	
			848.8	0.989	52.7	
GSM1900	Head	21.4	1850.2	1.360	38.5	Mar. 13, 2009
			1880.0	1.390	38.4	
			1909.8	1.420	38.3	
	Body	21.3	1850.2	1.490	52.4	Mar. 13, 2009
			1880.0	1.520	52.3	
			1909.8	1.560	52.2	

Table 6.3 Measuring Results for Simulating Liquid

7. Uncertainty Assessment

The component of uncertainty may generally be categorized according to the methods used to evaluate them. The evaluation of uncertainty by the statistical analysis of a series of observations is termed a Type A evaluation of uncertainty. The evaluation of uncertainty by means other than the statistical analysis of a series of observation is termed a Type B evaluation of uncertainty. Each component of uncertainty, however evaluated, is represented by an estimated standard deviation, termed standard uncertainty, which is determined by the positive square root of the estimated variance.

A Type A evaluation of standard uncertainty may be based on any valid statistical method for treating data. This includes calculating the standard deviation of the mean of a series of independent observations; using the method of least squares to fit a curve to the data in order to estimate the parameter of the curve and their standard deviations; or carrying out an analysis of variance in order to identify and quantify random effects in certain kinds of measurement.

A type B evaluation of standard uncertainty is typically based on scientific judgment using all of the relevant information available. These may include previous measurement data, experience and knowledge of the behavior and properties of relevant materials and instruments, manufacture’s specification, data provided in calibration reports and uncertainties assigned to reference data taken from handbooks. Broadly speaking, the uncertainty is either obtained from an outdoor source or obtained from an assumed distribution, such as the normal distribution, rectangular or triangular distributions indicated in Table 7.1

Uncertainty Distributions	Normal	Rectangular	Triangular	U-shape
Multiplying factor^(a)	1/k ^(b)	1/√3	1/√6	1/√2

(a) standard uncertainty is determined as the product of the multiplying factor and the estimated range of variations in the measured quantity

(b) κ is the coverage factor

Table 7.1 Standard Uncertainty for Assumed Distribution

The combined standard uncertainty of the measurement result represents the estimated standard deviation of the result. It is obtained by combining the individual standard uncertainties of both Type A and Type B evaluation using the usual “root-sum-squares” (RSS) methods of combining standard deviations by taking the positive square root of the estimated variances.

Expanded uncertainty is a measure of uncertainty that defines an interval about the measurement result within which the measured value is confidently believed to lie. It is obtained by multiplying the combined standard uncertainty by a coverage factor. Typically, the coverage factor ranges from 2 to 3. Using a coverage factor allows the true value of a measured quantity to be specified with a defined probability within the specified uncertainty range. For purpose of this document, a coverage factor two is used, which corresponds to confidence interval of about 95 %. The DASY4 uncertainty Budget is showed in Table 7.2.



Error Description	Uncertainty Value \pm %	Probability Distribution	Divisor	Ci (1g)	Standard Unc. (1g)	vi or Veff
Measurement Equipment						
Probe Calibration	± 5.9 %	Normal	1	1	± 5.9 %	∞
Axial Isotropy	± 4.7 %	Rectangular	$\sqrt{3}$	0.7	± 1.9 %	∞
Hemispherical Isotropy	± 9.6 %	Rectangular	$\sqrt{3}$	0.7	± 3.9 %	∞
Boundary Effects	± 1.0 %	Rectangular	$\sqrt{3}$	1	± 0.6 %	∞
Linearity	± 4.7 %	Rectangular	$\sqrt{3}$	1	± 2.7 %	∞
System Detection Limits	± 1.0 %	Rectangular	$\sqrt{3}$	1	± 0.6 %	∞
Readout Electronics	± 0.3 %	Normal	1	1	± 0.3 %	∞
Response Time	± 0.8 %	Rectangular	$\sqrt{3}$	1	± 0.5 %	∞
Integration Time	± 2.6 %	Rectangular	$\sqrt{3}$	1	± 1.5 %	∞
RF Ambient Noise	± 3.0 %	Rectangular	$\sqrt{3}$	1	± 1.7 %	∞
RF Ambient Reflections	± 3.0 %	Rectangular	$\sqrt{3}$	1	± 1.7 %	∞
Probe Positioner	± 0.4 %	Rectangular	$\sqrt{3}$	1	± 0.2 %	∞
Probe Positioning	± 2.9 %	Rectangular	$\sqrt{3}$	1	± 1.7 %	∞
Max. SAR Eval.	± 1.0 %	Rectangular	$\sqrt{3}$	1	± 0.6 %	∞
Test Sample Related						
Device Positioning	± 2.9 %	Normal	1	1	± 2.9	145
Device Holder	± 3.6 %	Normal	1	1	± 3.6	5
Power Drift	± 5.0 %	Rectangular	$\sqrt{3}$	1	± 2.9	∞
Phantom and Setup						
Phantom Uncertainty	± 4.0 %	Rectangular	$\sqrt{3}$	1	± 2.3	∞
Liquid Conductivity (target)	± 5.0 %	Rectangular	$\sqrt{3}$	0.64	± 1.8	∞
Liquid Conductivity (meas.)	± 2.5 %	Normal	1	0.64	± 1.6	∞
Liquid Permittivity (target)	± 5.0 %	Rectangular	$\sqrt{3}$	0.6	± 1.7	∞
Liquid Permittivity (meas.)	± 2.5 %	Normal	1	0.6	± 1.5	∞
Combined Standard Uncertainty					± 10.9	387
Coverage Factor for 95 %		K=2				
Expanded uncertainty (Coverage factor = 2)					± 21.9	

Table 7.2 Uncertainty Budget of DASY4

8. SAR Measurement Evaluation

Each DASY4 system is equipped with one or more system validation kits. These units, together with the predefined measurement procedures within the DASY4 software, enable the user to conduct the system performance check and system validation. System validation kit includes a dipole, tripod holder to fix it underneath the flat phantom and a corresponding distance holder.

8.1 Purpose of System Performance check

The system performance check verifies that the system operates within its specifications. System and operator errors can be detected and corrected. It is recommended that the system performance check be performed prior to any usage of the system in order to guarantee reproducible results. The system performance check uses normal SAR measurements in a simplified setup with a well characterized source. This setup was selected to give a high sensitivity to all parameters that might fail or vary over time. The system check does not intend to replace the calibration of the components, but indicates situations where the system uncertainty is exceeded due to drift or failure.

8.2 System Setup

In the simplified setup for system evaluation, the DUT is replaced by a calibrated dipole and the power source is replaced by a continuous wave which comes from a signal generator at frequency 835 MHz and 1900 MHz. The calibrated dipole must be placed beneath the flat phantom section of the SAM twin phantom with the correct distance holder. The distance holder should touch the phantom surface with a light pressure at the reference marking and be oriented parallel to the long side of the phantom. The equipment setup is shown below:

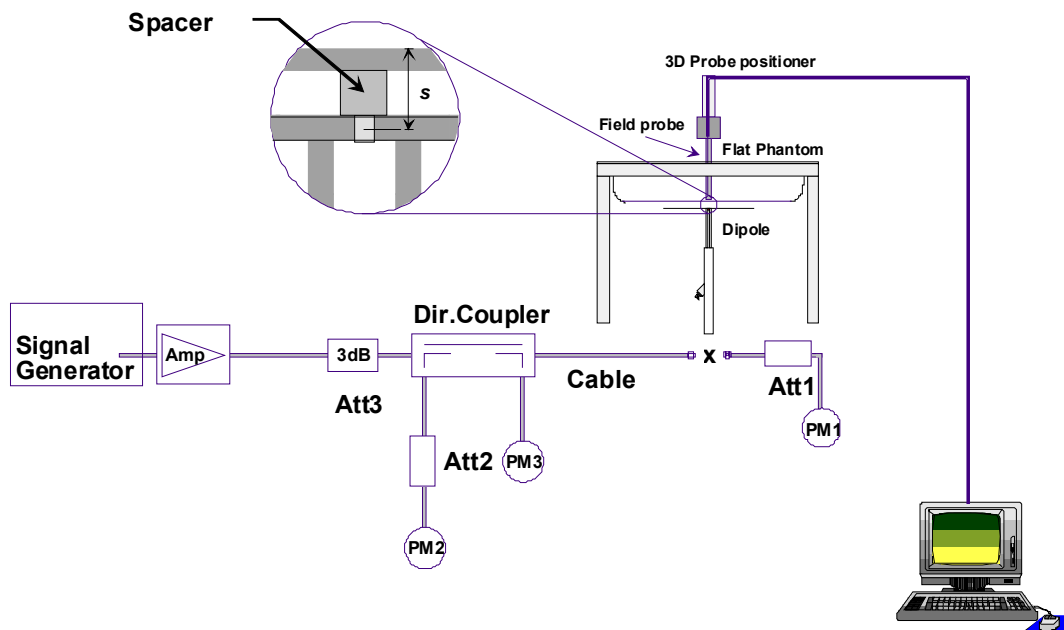

Fig. 8.1 System Setup for System Evaluation

1. Signal Generator
2. Amplifier
3. Directional Coupler
4. Power Meter
5. 835 MHz or 1900 MHz Dipole

The output power on dipole port must be calibrated to 20dBm (100mW) before dipole is connected.

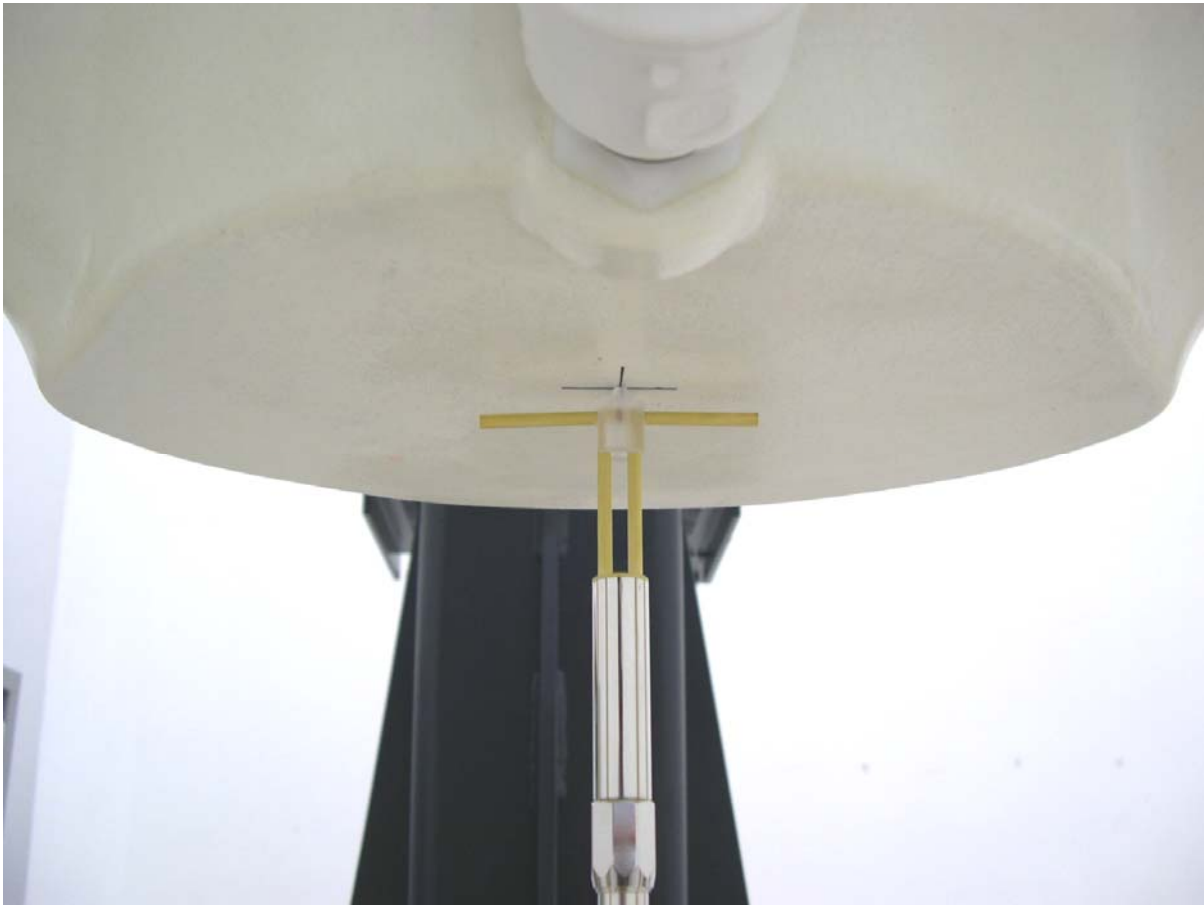

Fig 8.2 Dipole Setup

8.3 Validation Results

Comparing to the original SAR value provided by SPEAG, the validation data should be within its specification of 10 %. Table 8.1 shows the target SAR and measured SAR after normalized to 1W input power. The table below indicates the system performance check can meet the variation criterion.

Frequency	Position	SAR	Target (W/kg)	Measurement data (W/kg)	Variation	Measurement date
835MHz	Head	SAR (1g)	9.16	9.40	2.6 %	Mar. 13, 2009
		SAR (10g)	6.00	6.17	2.8 %	
	Body	SAR (1g)	9.52	9.67	1.6 %	Mar. 13, 2009
		SAR (10g)	6.37	6.35	-0.3 %	
1900MHz	Head	SAR (1g)	39.50	41.00	3.8 %	Mar. 13, 2009
		SAR (10g)	20.60	21.30	3.4 %	
	Body	SAR (1g)	40.10	37.30	-7.0 %	Mar. 13, 2009
		SAR (10g)	21.30	19.50	-8.5 %	

Table 8.1 Target and Measurement SAR after Normalized

9. Description for DUT Testing Position

This DUT was tested in six different positions. They are right cheek, right tilted, left cheek, left tilted, face of the DUT with 1.5 cm gap and bottom of the DUT with 1.5 cm gap as illustrated below: (Please refer to Appendix E for the test setup photos.)

- 1) "Cheek Position"
 - i) To position the device with the vertical center line of the body of the device and the horizontal line crossing the center piece in a plane parallel to the sagittal plane of the phantom. While maintaining the device in this plane, align the vertical center line with the reference plane containing the three ear and mouth reference point (M, RE and LE) and align the center of the ear piece with the line RE-LE.
 - ii) To move the device towards the phantom with the ear piece aligned with the line LE-RE until the phone touched the ear. While maintaining the device in the reference plane and maintaining the phone contact with the ear, move the bottom of the phone until any point on the front side is in contact with the cheek of the phantom or until contact with the ear is lost (see Fig. 9.1).

- 2) "Tilted Position"
 - i) To position the device in the "cheek" position described above
 - ii) While maintaining the device the reference plane described above and pivoting against the ear, moves it outward away from the mouth by an angle of 15 degrees or until contact with the ear is lost (see Fig. 9.2).

- 3) "Body Worn"
 - i) To position the device parallel to the phantom surface with either keypad up or down.
 - ii) To adjust the device parallel to the flat phantom.
 - iii) To adjust the distance between the device surface and the flat phantom to 1.5 cm.

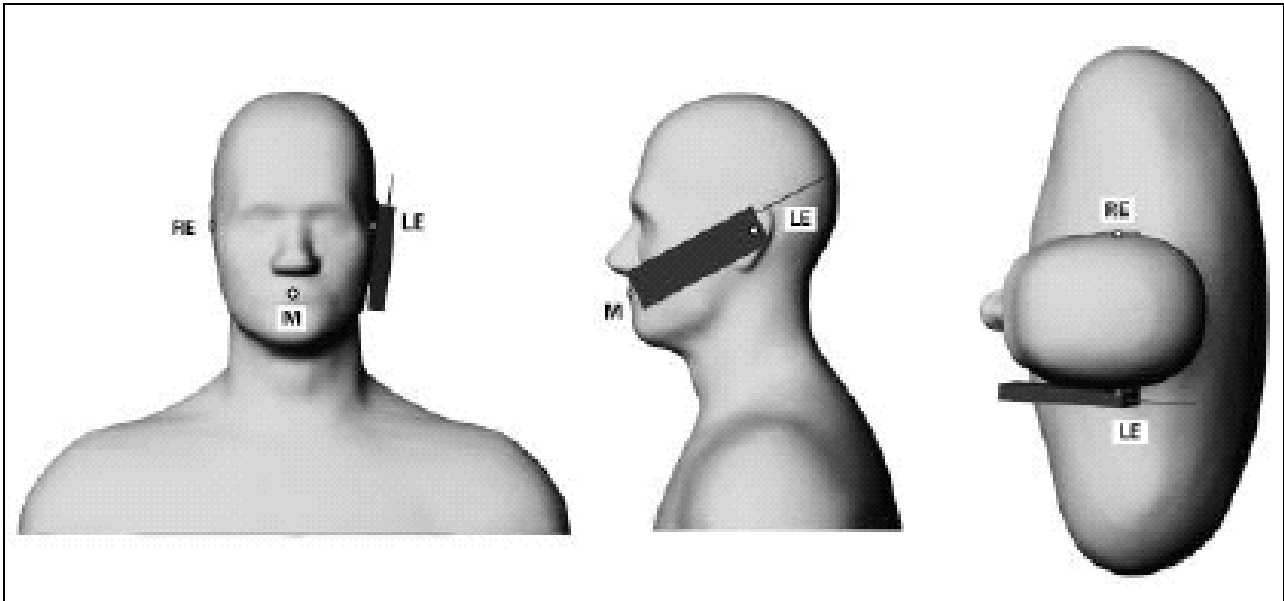

Fig. 9.1 Phone Position 1, "Cheek" or "Touch" Position. The reference points for the right ear (RE), left ear (LE) and mouth (M), which define the plane for phone positioning, are indicated.

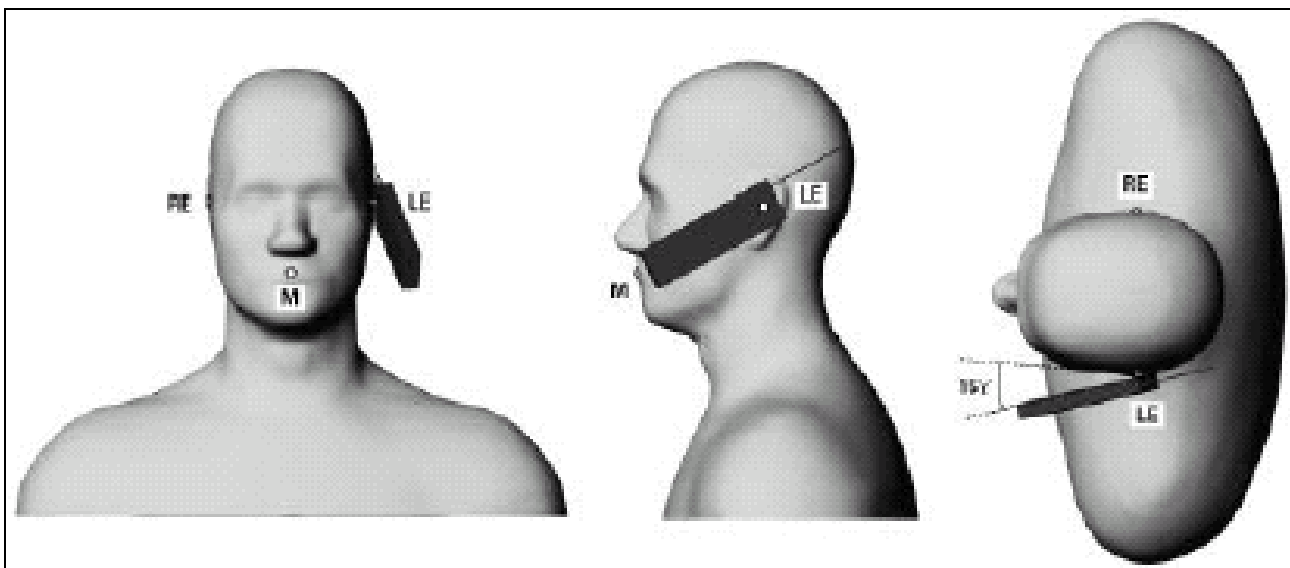

Fig. 9.2 Phone Position 2, "Tilted Position". The reference point for the right ear (RE), left ear (LE) and mouth (M), which define the plane for phone positioning, are indicated.

10. Measurement Procedures

The measurement procedures are as follows:

- Linking DUT with base station emulator CMU200 in middle channel
- Setting CMU200 to allow DUT to radiate maximum output power
- Measuring output power through RF cable and power meter
- Placing the DUT in the positions described in the last section
- Setting scan area, grid size and other setting on the DAS4 software
- Taking data for the middle channel on each testing position
- Finding out the largest SAR result on these testing positions of each band
- Measuring output power and SAR results for the lowest and highest channels in this worst case testing position

According to the OET Bulletin 65 Supplement C standard, the recommended procedure for assessing the peak spatial-average SAR value consists of the following steps:

- Power reference measurement
- Area scan
- Zoom scan
- Power reference measurement

10.1 Spatial Peak SAR Evaluation

The procedure for spatial peak SAR evaluation has been implemented according to the OET Bulletin 65 Supplement C standard. It can be conducted for 1g and 10g, as well as for user-specific masses. The DAS4 software includes all numerical procedures necessary to evaluate the spatial peak SAR value.

The base for the evaluation is a "cube" measurement. The measured volume must include the 1g and 10g cubes with the highest averaged SAR values. For that purpose, the center of the measured volume is aligned to the interpolated peak SAR value of a previously performed area scan.

The entire evaluation of the spatial peak values is performed within the post-processing engine (SEMCAD). The system always gives the maximum values for the 1g and 10g cubes. The algorithm to find the cube with highest averaged SAR is divided into the following stages:

- extraction of the measured data (grid and values) from the Zoom Scan
- calculation of the SAR value at every measurement point based on all stored data (A/D values and measurement parameters)
- generation of a high-resolution mesh within the measured volume
- interpolation of all measured values from the measurement grid to the high-resolution grid
- extrapolation of the entire 3-D field distribution to the phantom surface over the distance from sensor to surface
- calculation of the averaged SAR within masses of 1g and 10g

10.2 Scan Procedures

First Area Scan is used to locate the approximate location(s) of the local peak SAR value(s). The measurement grid within an Area Scan is defined by the grid extent, grid step size and grid offset. Next, in order to determine the EM field distribution in a three-dimensional spatial extension, Zoom Scan is required. The Zoom Scan measures 5x5x7 points with step size 8, 8 and 5 mm. The Zoom Scan is performed around the highest E-field value to determine the averaged SAR-distribution over 1 g.

10.3 SAR Averaged Methods

In DAS4, the interpolation and extrapolation are both based on the modified Quadratic Shepard's method. The interpolation scheme combines a least-square fitted function method and a weighted average method which are the two basic types of computational interpolation and approximation.

Extrapolation routines are used to obtain SAR values between the lowest measurement points and the inner phantom surface. The extrapolation distance is determined by the surface detection distance and the probe sensor offset. The uncertainty increases with the extrapolation distance. To keep the uncertainty within 1% for the 1 g and 10 g cubes, the extrapolation distance should not be larger than 5 mm.



11. SAR Test Results

11.1 Conducted Power

Mode \ Channel	GSM 850			GSM 1900		
	128	189	251	512	661	810
GSM	31.67	31.66	31.72	29.71	29.31	28.94

*Unit: dBm

11.2 Test Records for Head SAR Test

Position	Band	Chan.	Freq. (MHz)	Modulation Type	Measured 1g SAR (W/kg)	Limit (W/kg)	Result
Right Cheek	GSM850	189	836.4	GMSK	0.543	1.6	Pass
Right Tilted	GSM850	189	836.4	GMSK	0.29	1.6	Pass
Left Cheek	GSM850	189	836.4	GMSK	0.52	1.6	Pass
Left Tilted	GSM850	189	836.4	GMSK	0.275	1.6	Pass
Right Cheek	GSM850	128	824.2	GMSK	0.603	1.6	Pass
Right Cheek	GSM850	251	848.8	GMSK	0.618	1.6	Pass
Right Cheek	GSM1900	661	1880.0	GMSK	0.139	1.6	Pass
Right Tilted	GSM1900	661	1880.0	GMSK	0.11	1.6	Pass
Left Cheek	GSM1900	661	1880.0	GMSK	0.181	1.6	Pass
Left Tilted	GSM1900	661	1880.0	GMSK	0.105	1.6	Pass
Left Cheek	GSM1900	512	1850.2	GMSK	0.172	1.6	Pass
Left Cheek	GSM1900	810	1909.8	GMSK	0.193	1.6	Pass

11.3 Test Records for Body SAR Test

Position	Band	Chan.	Freq. (MHz)	Modulation Type	Measured 1g SAR (W/kg)	Limit (W/kg)	Result
Face of the DUT with 1.5 cm gap	GSM850	189	836.4	GMSK	0.245	1.6	Pass
Bottom of the DUT with 1.5 cm gap	GSM850	189	836.4	GMSK	0.51	1.6	Pass
Bottom of the DUT with 1.5 cm gap	GSM850	128	824.2	GMSK	0.568	1.6	Pass
Bottom of the DUT with 1.5 cm gap	GSM850	251	848.8	GMSK	0.702	1.6	Pass
Face of the DUT with 1.5 cm gap	GSM1900	661	1880.0	GMSK	0.103	1.6	Pass
Bottom of the DUT with 1.5 cm gap	GSM1900	661	1880.0	GMSK	0.449	1.6	Pass
Bottom of the DUT with 1.5 cm gap	GSM1900	512	1850.2	GMSK	0.414	1.6	Pass
Bottom of the DUT with 1.5 cm gap	GSM1900	810	1909.8	GMSK	0.617	1.6	Pass

Test Engineer : Gordon Lin



12. References

- [1] FCC 47 CFR Part 2 "Frequency Allocations and Radio Treaty Matters; General Rules and Regulations"
- [2] IEEE Std. 1528-2003, "Recommended Practice for Determining the Peak Spatial-Average Specific Absorption Rate (SAR) in the Human Head from Wireless Communications Devices: Measurement Techniques"
- [3] Supplement C (Edition 01-01) to OET Bulletin 65 (Edition 97-01), "Additional Information for Evaluating Compliance of Mobile and Portable Devices with FCC Limits for Human Exposure to RF Emissions", June 2001
- [4] IEEE Std. C95.1-1999, "IEEE Standard for Safety Levels with Respect to Human Exposure to Radio Frequency Electromagnetic Fields, 3 kHz to 300 GHz", 1999
- [5] Robert J. Renka, "Multivariate Interpolation Of Large Sets Of Scattered Data", University of North Texas ACM Transactions on Mathematical Software, vol. 14, no. 2, June 1988, pp. 139-148
- [6] DASY4 System Handbook

Appendix A - System Performance Check Data

Test Laboratory: Sporton International Inc. SAR/HAC Testing Lab

Date: 2009/3/13

System Check_Head_835MHz_20090313

DUT: Dipole 835 MHz

Communication System: CW; Frequency: 835 MHz; Duty Cycle: 1:1

Medium: HSL_850 Medium parameters used: $f = 835 \text{ MHz}$; $\sigma = 0.901 \text{ mho/m}$; $\epsilon_r = 41.3$; $\rho = 1000 \text{ kg/m}^3$

Ambient Temperature : $22.5 \text{ }^\circ\text{C}$; Liquid Temperature : $21.4 \text{ }^\circ\text{C}$

DASY4 Configuration:

- Probe: ET3DV6 - SN1787; ConvF(6.06, 6.06, 6.06); Calibrated: 2008/8/26
- Sensor-Surface: 4mm (Mechanical Surface Detection)
- Electronics: DAE4 Sn778; Calibrated: 2008/9/22
- Phantom: SAM-Right; Type: QD 000 P40 C; Serial: TP-1383
- Measurement SW: DASY4, V4.7 Build 80; Postprocessing SW: SEMCAD, V1.8 Build 186

Pin=100mW/Area Scan (61x61x1): Measurement grid: $dx=15\text{mm}$, $dy=15\text{mm}$

Maximum value of SAR (interpolated) = 1.01 mW/g

Pin=100mW/Zoom Scan (7x7x7)/Cube 0: Measurement grid: $dx=5\text{mm}$, $dy=5\text{mm}$, $dz=5\text{mm}$

Reference Value = 34.8 V/m ; Power Drift = -0.023 dB

Peak SAR (extrapolated) = 1.36 W/kg

SAR(1 g) = 0.940 mW/g ; SAR(10 g) = 0.617 mW/g

Maximum value of SAR (measured) = 1.01 mW/g

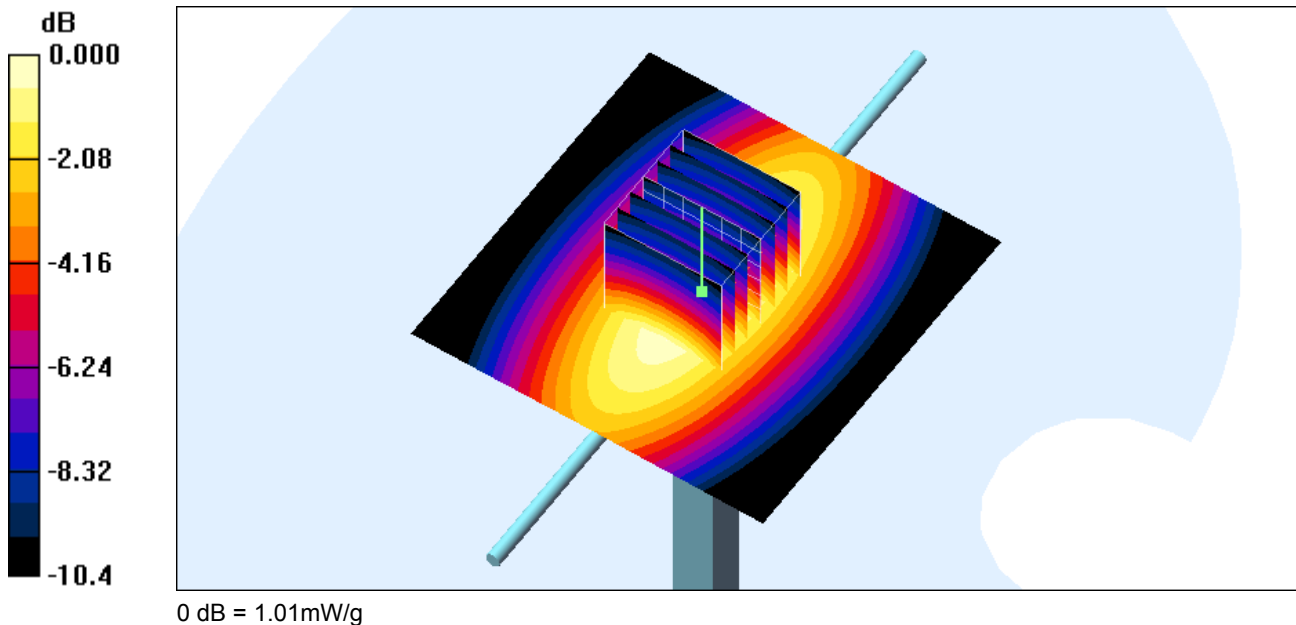



Test Laboratory: Sporton International Inc. SAR/HAC Testing Lab

Date: 2009/3/13

System Check_Head_1900MHz_20090313

DUT: Dipole 1900 MHz

Communication System: CW; Frequency: 1900 MHz; Duty Cycle: 1:1

Medium: HSL_1900 Medium parameters used: $f = 1900$ MHz; $\sigma = 1.41$ mho/m; $\epsilon_r = 38.3$; $\rho = 1000$ kg/m³

Ambient Temperature : 22.4 °C ; Liquid Temperature : 21.4 °C

DASY4 Configuration:

- Probe: ET3DV6 - SN1787; ConvF(5.01, 5.01, 5.01); Calibrated: 2008/8/26
- Sensor-Surface: 4mm (Mechanical Surface Detection)
- Electronics: DAE4 Sn778; Calibrated: 2008/9/22
- Phantom: SAM-Left; Type: QD 000 P40 C; Serial: TP-1477
- Measurement SW: DASY4, V4.7 Build 80; Postprocessing SW: SEMCAD, V1.8 Build 186

Pin=100mW/Area Scan (61x61x1): Measurement grid: dx=15mm, dy=15mm

Maximum value of SAR (interpolated) = 4.92 mW/g

Pin=100mW/Zoom Scan (7x7x7)/Cube 0: Measurement grid: dx=5mm, dy=5mm, dz=5mm

Reference Value = 59.5 V/m; Power Drift = -0.019 dB

Peak SAR (extrapolated) = 7.60 W/kg

SAR(1 g) = 4.1 mW/g; SAR(10 g) = 2.13 mW/g

Maximum value of SAR (measured) = 4.63 mW/g

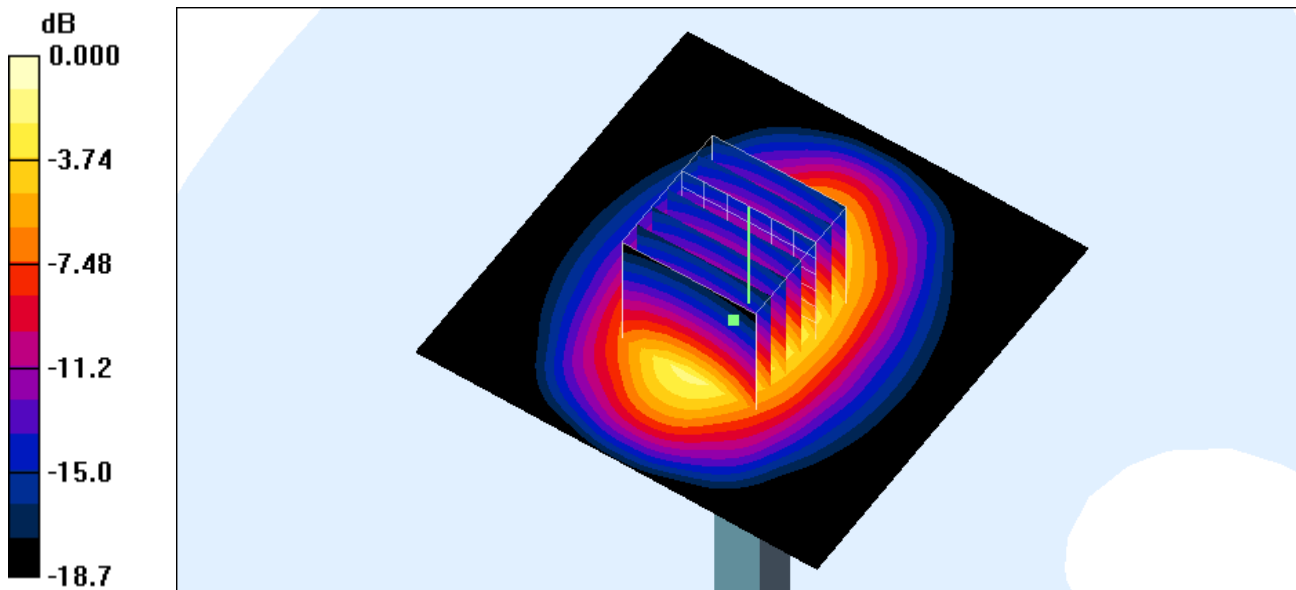

0 dB = 4.63mW/g

Test Laboratory: Sporton International Inc. SAR/HAC Testing Lab

Date: 2009/3/13

System Check_Body_835MHz_20090313

DUT: Dipole 835 MHz

Communication System: CW; Frequency: 835 MHz; Duty Cycle: 1:1
 Medium: MSL_850 Medium parameters used: $f = 835 \text{ MHz}$; $\sigma = 0.975 \text{ mho/m}$; $\epsilon_r = 52.9$; $\rho = 1000 \text{ kg/m}^3$
 Ambient Temperature : 22.4 °C; Liquid Temperature : 21.4 °C

DASY4 Configuration:

- Probe: ET3DV6 - SN1787; ConvF(6.1, 6.1, 6.1); Calibrated: 2007/8/28
- Sensor-Surface: 4mm (Mechanical Surface Detection)
- Electronics: DAE4 Sn778; Calibrated: 2008/9/22
- Phantom: ELI 4.0_Front; Type: QDOVA001BB; Serial: 1026
- Measurement SW: DASY4, V4.7 Build 80; Postprocessing SW: SEMCAD, V1.8 Build 186

Pin=100mW/Area Scan (61x61x1): Measurement grid: dx=15mm, dy=15mm
 Maximum value of SAR (interpolated) = 1.05 mW/g

Pin=100mW/Zoom Scan (7x7x7)/Cube 0: Measurement grid: dx=5mm, dy=5mm, dz=5mm
 Reference Value = 34.1 V/m; Power Drift = -0.039 dB

Peak SAR (extrapolated) = 1.39 W/kg

SAR(1 g) = 0.967 mW/g; SAR(10 g) = 0.635 mW/g

Maximum value of SAR (measured) = 1.05 mW/g

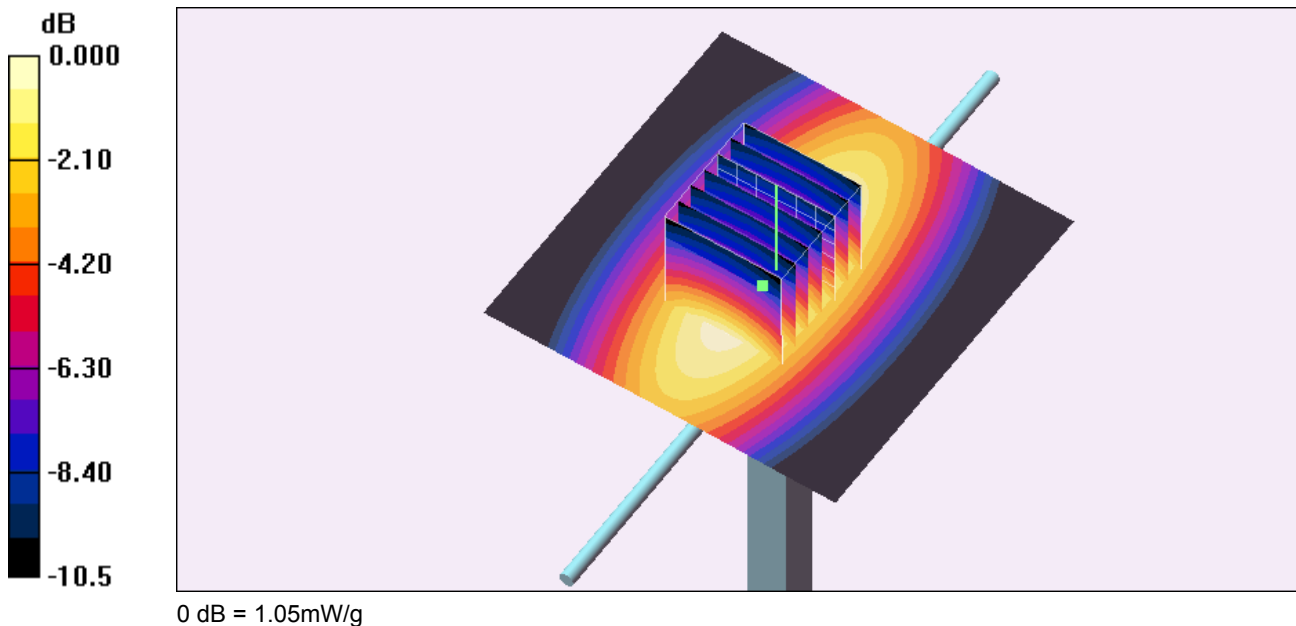

Test Laboratory: Sporton International Inc. SAR/HAC Testing Lab

Date: 2009/3/13

System Check_Body_1900MHz_20090313

DUT: Dipole 1900 MHz

Communication System: CW; Frequency: 1900 MHz; Duty Cycle: 1:1

Medium: MSL_1900 Medium parameters used: $f = 1900$ MHz; $\sigma = 1.55$ mho/m; $\epsilon_r = 52.2$; $\rho = 1000$ kg/m³

Ambient Temperature : 22.4 °C; Liquid Temperature : 21.4 °C

DASY4 Configuration:

- Probe: ET3DV6 - SN1787; ConvF(4.49, 4.49, 4.49); Calibrated: 2008/8/26
- Sensor-Surface: 4mm (Mechanical Surface Detection)
- Electronics: DAE4 Sn778; Calibrated: 2008/9/22
- Phantom: SAM-Right; Type: QD 000 P40 C; Serial: TP-1383
- Measurement SW: DASY4, V4.7 Build 80; Postprocessing SW: SEMCAD, V1.8 Build 186

Pin=100mW/Area Scan (91x91x1): Measurement grid: dx=10mm, dy=10mm

Maximum value of SAR (interpolated) = 4.34 mW/g

Pin=100mW/Zoom Scan (7x7x7)/Cube 0: Measurement grid: dx=5mm, dy=5mm, dz=5mm

Reference Value = 54.7 V/m; Power Drift = 0.013 dB

Peak SAR (extrapolated) = 6.74 W/kg

SAR(1 g) = 3.73 mW/g; SAR(10 g) = 1.95 mW/g

Maximum value of SAR (measured) = 4.23 mW/g

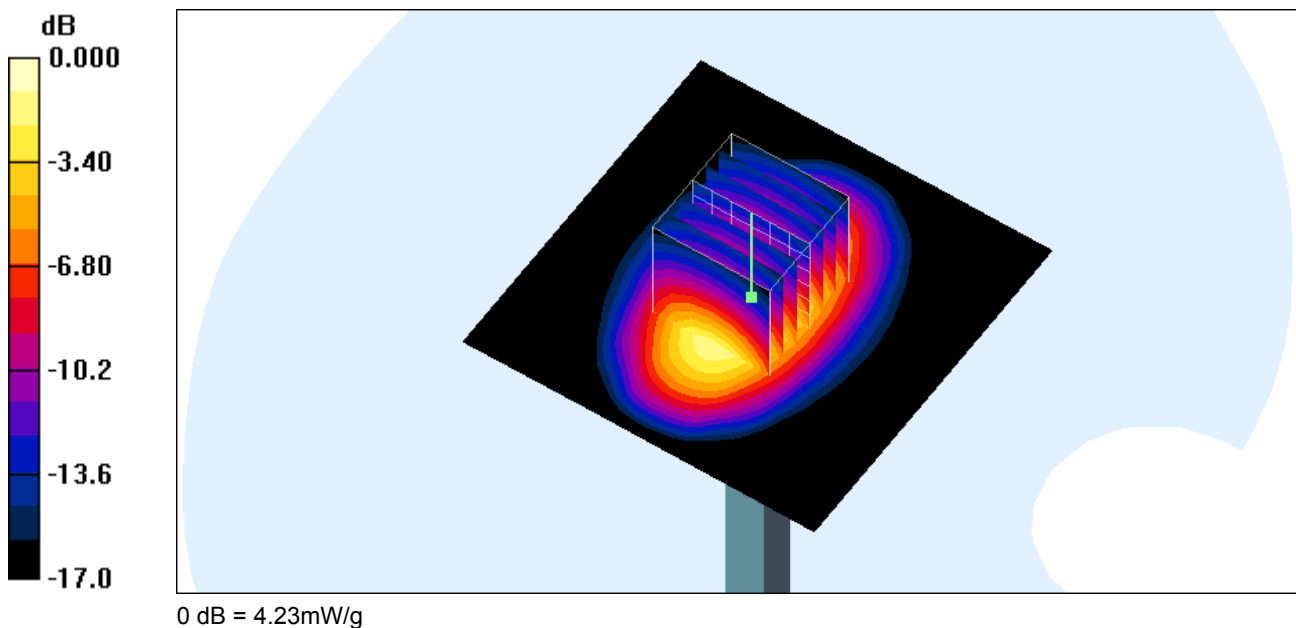

Appendix B - SAR Measurement Data

Test Laboratory: Sporton International Inc. SAR/HAC Testing Lab

Date: 2009/3/13

Right Cheek_GSM850 Ch251

DUT: 931114

Communication System: GSM850; Frequency: 848.8 MHz; Duty Cycle: 1:8.3
Medium: HSL_850 Medium parameters used: $f = 849$ MHz; $\sigma = 0.909$ mho/m; $\epsilon_r = 41.2$; $\rho = 1000$ kg/m³
Ambient Temperature : 22.3 °C; Liquid Temperature : 21.4 °C

DASY4 Configuration:

- Probe: ET3DV6 - SN1787; ConvF(6.06, 6.06, 6.06); Calibrated: 2008/8/26
- Sensor-Surface: 4mm (Mechanical Surface Detection)
- Electronics: DAE4 Sn778; Calibrated: 2008/9/22
- Phantom: SAM-Right; Type: QD 000 P40 C; Serial: TP-1383
- Measurement SW: DASY4, V4.7 Build 80; Postprocessing SW: SEMCAD, V1.8 Build 186

Ch251/Area Scan (51x101x1): Measurement grid: dx=15mm, dy=15mm
Maximum value of SAR (interpolated) = 0.672 mW/g

Ch251/Zoom Scan (5x5x7)/Cube 0: Measurement grid: dx=8mm, dy=8mm, dz=5mm
Reference Value = 14.7 V/m; Power Drift = 0.045 dB
Peak SAR (extrapolated) = 0.760 W/kg
SAR(1 g) = 0.618 mW/g; SAR(10 g) = 0.450 mW/g
Maximum value of SAR (measured) = 0.650 mW/g

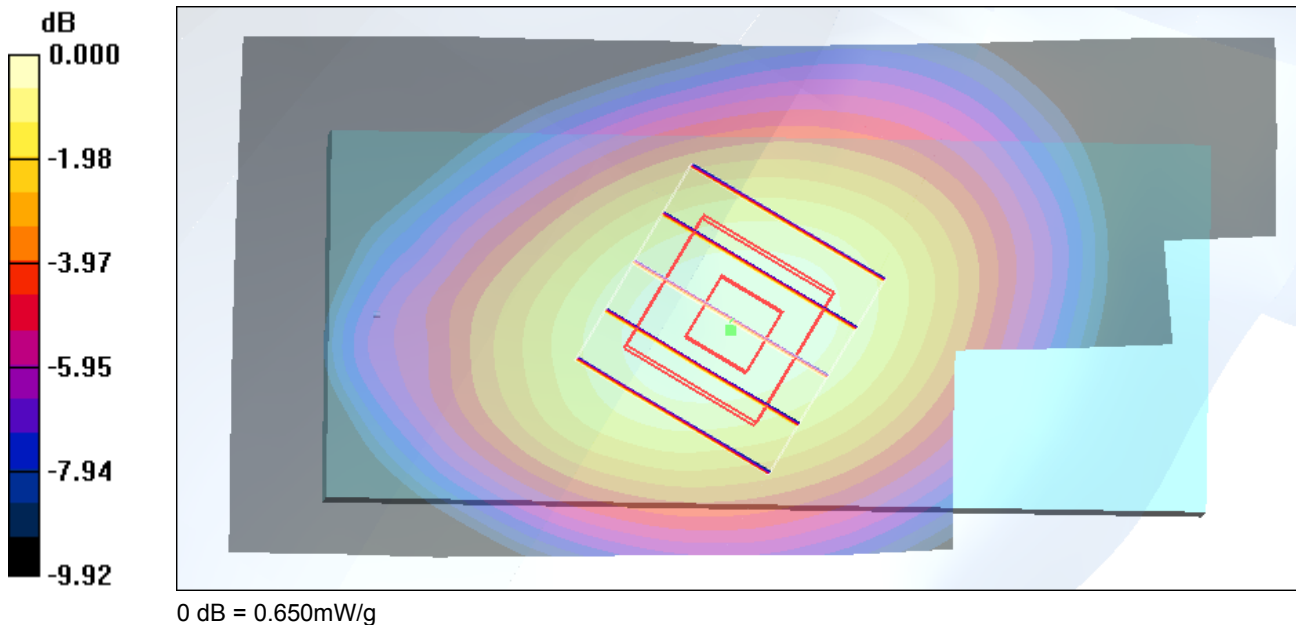

Test Laboratory: Sporton International Inc. SAR/HAC Testing Lab

Date: 2009/3/13

Right Tilted_GSM850 Ch189

DUT: 931114

Communication System: GSM850; Frequency: 836.4 MHz; Duty Cycle: 1:8.3

Medium: HSL_850 Medium parameters used : $f = 836.4$ MHz; $\sigma = 0.897$ mho/m; $\epsilon_r = 41.3$; $\rho = 1000$ kg/m³

Ambient Temperature : 22.5 °C; Liquid Temperature : 21.4 °C

DASY4 Configuration:

- Probe: ET3DV6 - SN1787; ConvF(6.06, 6.06, 6.06); Calibrated: 2008/8/26
- Sensor-Surface: 4mm (Mechanical Surface Detection)
- Electronics: DAE4 Sn778; Calibrated: 2008/9/22
- Phantom: SAM-Right; Type: QD 000 P40 C; Serial: TP-1383
- Measurement SW: DASY4, V4.7 Build 80; Postprocessing SW: SEMCAD, V1.8 Build 186

Ch189/Area Scan (51x101x1): Measurement grid: dx=15mm, dy=15mm

Maximum value of SAR (interpolated) = 0.305 mW/g

Ch189/Zoom Scan (5x5x7)/Cube 0: Measurement grid: dx=8mm, dy=8mm, dz=5mm

Reference Value = 16.1 V/m; Power Drift = -0.026 dB

Peak SAR (extrapolated) = 0.367 W/kg

SAR(1 g) = 0.290 mW/g; SAR(10 g) = 0.212 mW/g

Maximum value of SAR (measured) = 0.310 mW/g

Ch189/Zoom Scan (5x5x7)/Cube 1: Measurement grid: dx=8mm, dy=8mm, dz=5mm

Reference Value = 16.1 V/m; Power Drift = -0.026 dB

Peak SAR (extrapolated) = 0.385 W/kg

SAR(1 g) = 0.208 mW/g; SAR(10 g) = 0.137 mW/g

Maximum value of SAR (measured) = 0.249 mW/g

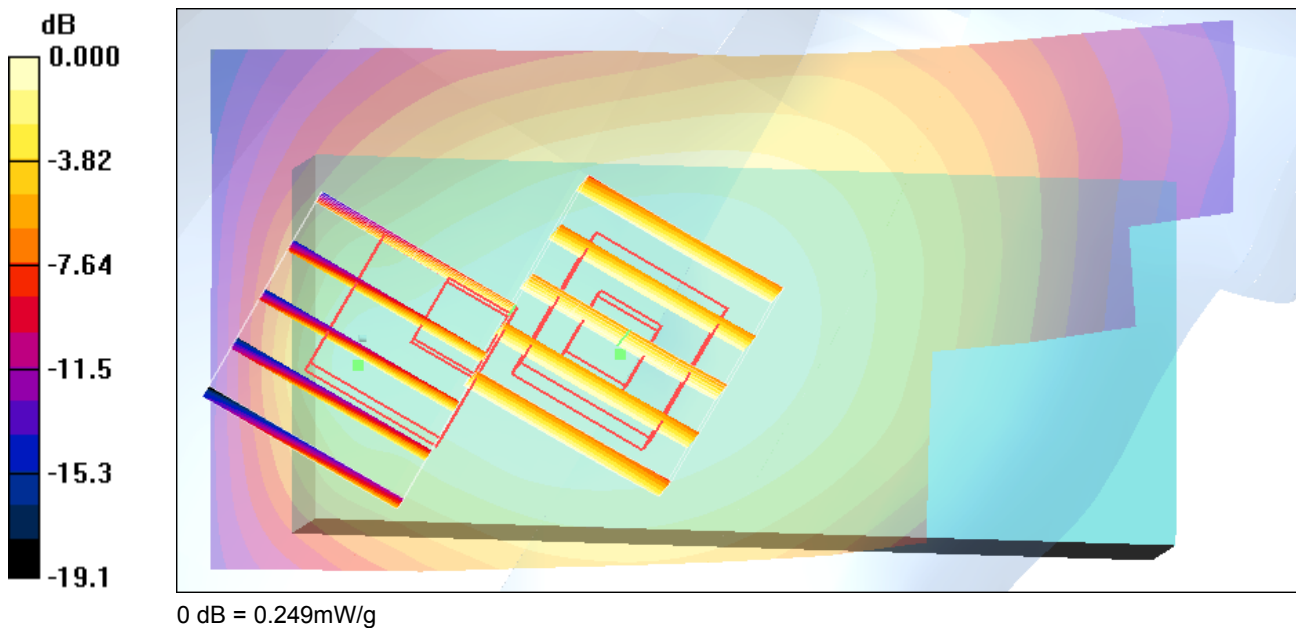



Test Laboratory: Sporton International Inc. SAR/HAC Testing Lab

Date: 2009/3/13

Left Cheek_GSM850 Ch189

DUT: 931114

Communication System: GSM850; Frequency: 836.4 MHz; Duty Cycle: 1:8.3
Medium: HSL_850 Medium parameters used : $f = 836.4 \text{ MHz}$; $\sigma = 0.897 \text{ mho/m}$; $\epsilon_r = 41.3$; $\rho = 1000 \text{ kg/m}^3$
Ambient Temperature : $22.5 \text{ }^\circ\text{C}$; Liquid Temperature : $21.4 \text{ }^\circ\text{C}$

DASY4 Configuration:

- Probe: ET3DV6 - SN1787; ConvF(6.06, 6.06, 6.06); Calibrated: 2008/8/26
- Sensor-Surface: 4mm (Mechanical Surface Detection)
- Electronics: DAE4 Sn778; Calibrated: 2008/9/22
- Phantom: SAM-Right; Type: QD 000 P40 C; Serial: TP-1383
- Measurement SW: DASY4, V4.7 Build 80; Postprocessing SW: SEMCAD, V1.8 Build 186

Ch189/Area Scan (51x101x1): Measurement grid: $dx=15\text{mm}$, $dy=15\text{mm}$
Maximum value of SAR (interpolated) = 0.560 mW/g

Ch189/Zoom Scan (5x5x7)/Cube 0: Measurement grid: $dx=8\text{mm}$, $dy=8\text{mm}$, $dz=5\text{mm}$
Reference Value = 12.7 V/m ; Power Drift = -0.115 dB
Peak SAR (extrapolated) = 0.654 W/kg
SAR(1 g) = 0.520 mW/g ; SAR(10 g) = 0.375 mW/g
Maximum value of SAR (measured) = 0.550 mW/g

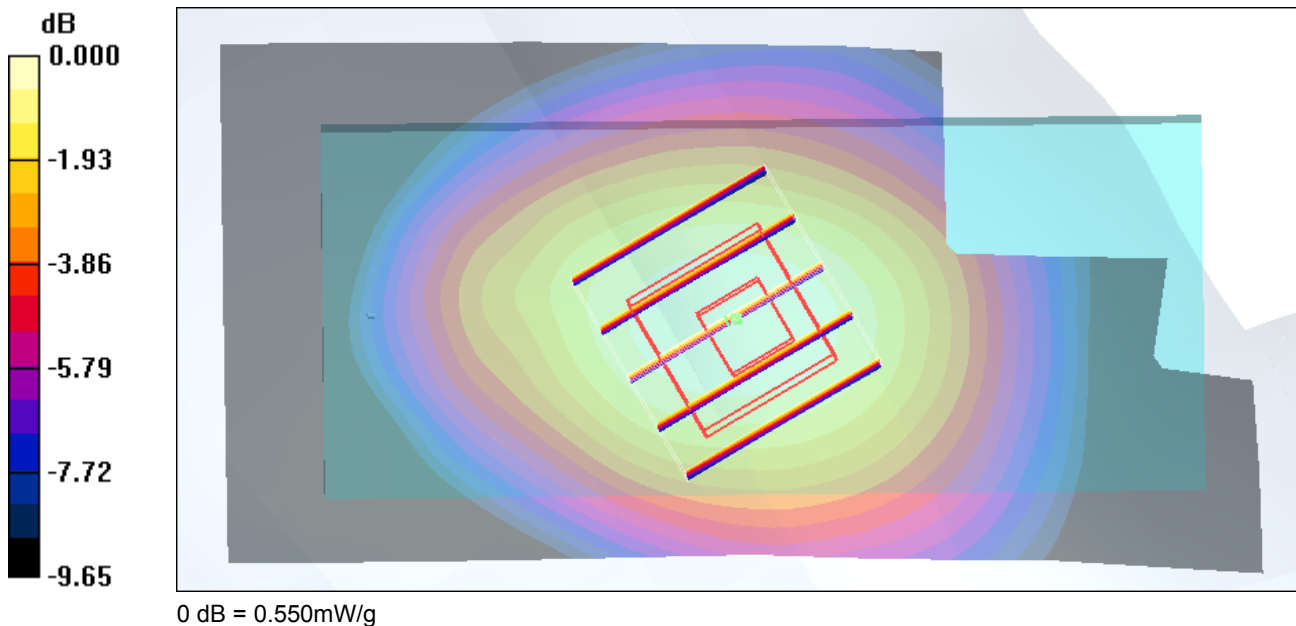



Test Laboratory: Sporton International Inc. SAR/HAC Testing Lab

Date: 2009/3/13

Left Tilted_GSM850 Ch189

DUT: 931114

Communication System: GSM850; Frequency: 836.4 MHz; Duty Cycle: 1:8.3
Medium: HSL_850 Medium parameters used : $f = 836.4$ MHz; $\sigma = 0.897$ mho/m; $\epsilon_r = 41.3$; $\rho = 1000$ kg/m³
Ambient Temperature : 22.5 °C; Liquid Temperature : 21.4 °C

DASY4 Configuration:

- Probe: ET3DV6 - SN1787; ConvF(6.06, 6.06, 6.06); Calibrated: 2008/8/26
- Sensor-Surface: 4mm (Mechanical Surface Detection)
- Electronics: DAE4 Sn778; Calibrated: 2008/9/22
- Phantom: SAM-Right; Type: QD 000 P40 C; Serial: TP-1383
- Measurement SW: DASY4, V4.7 Build 80; Postprocessing SW: SEMCAD, V1.8 Build 186

Ch189/Area Scan (51x101x1): Measurement grid: dx=15mm, dy=15mm
Maximum value of SAR (interpolated) = 0.293 mW/g

Ch189/Zoom Scan (5x5x7)/Cube 0: Measurement grid: dx=8mm, dy=8mm, dz=5mm
Reference Value = 15.2 V/m; Power Drift = -0.122 dB
Peak SAR (extrapolated) = 0.347 W/kg
SAR(1 g) = 0.275 mW/g; SAR(10 g) = 0.202 mW/g
Maximum value of SAR (measured) = 0.292 mW/g

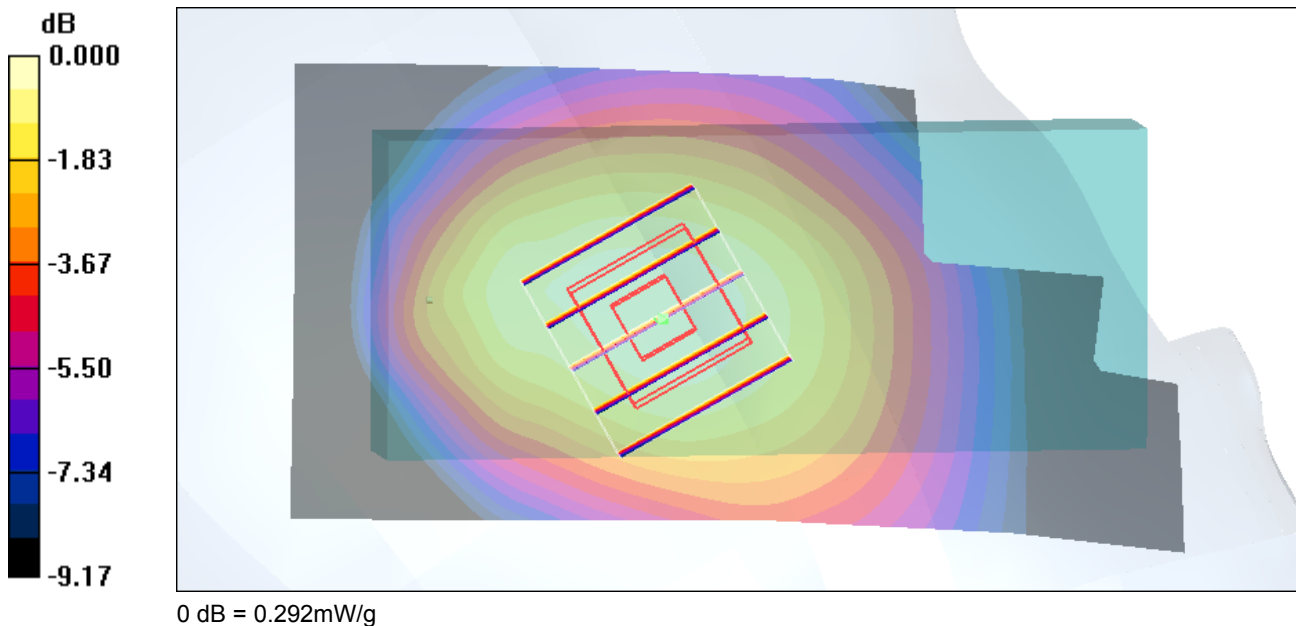



Test Laboratory: Sporton International Inc. SAR/HAC Testing Lab

Date: 2009/3/13

Right Cheek_GSM1900 Ch661

DUT: 931114

Communication System: PCS; Frequency: 1880 MHz;Duty Cycle: 1:8.3
Medium: HSL_1900 Medium parameters used: f = 1880 MHz; $\sigma = 1.39$ mho/m; $\epsilon_r = 38.4$; $\rho = 1000$ kg/m³
Ambient Temperature : 22.3 °C; Liquid Temperature : 21.4 °C

DASY4 Configuration:

- Probe: ET3DV6 - SN1787; ConvF(5.01, 5.01, 5.01); Calibrated: 2008/8/26
- Sensor-Surface: 4mm (Mechanical Surface Detection)
- Electronics: DAE4 Sn778; Calibrated: 2008/9/22
- Phantom: SAM-Left; Type: QD 000 P40 C; Serial: TP-1477
- Measurement SW: DASY4, V4.7 Build 80; Postprocessing SW: SEMCAD, V1.8 Build 186

Ch661/Area Scan (51x101x1): Measurement grid: dx=15mm, dy=15mm
Maximum value of SAR (interpolated) = 0.155 mW/g

Ch661/Zoom Scan (5x5x7)/Cube 0: Measurement grid: dx=8mm, dy=8mm, dz=5mm
Reference Value = 4.22 V/m; Power Drift = -0.110 dB
Peak SAR (extrapolated) = 0.189 W/kg
SAR(1 g) = 0.139 mW/g; SAR(10 g) = 0.089 mW/g
Maximum value of SAR (measured) = 0.149 mW/g

Ch661/Zoom Scan (5x5x7)/Cube 1: Measurement grid: dx=8mm, dy=8mm, dz=5mm
Reference Value = 4.22 V/m; Power Drift = -0.110 dB
Peak SAR (extrapolated) = 0.147 W/kg
SAR(1 g) = 0.097 mW/g; SAR(10 g) = 0.065 mW/g
Maximum value of SAR (measured) = 0.103 mW/g

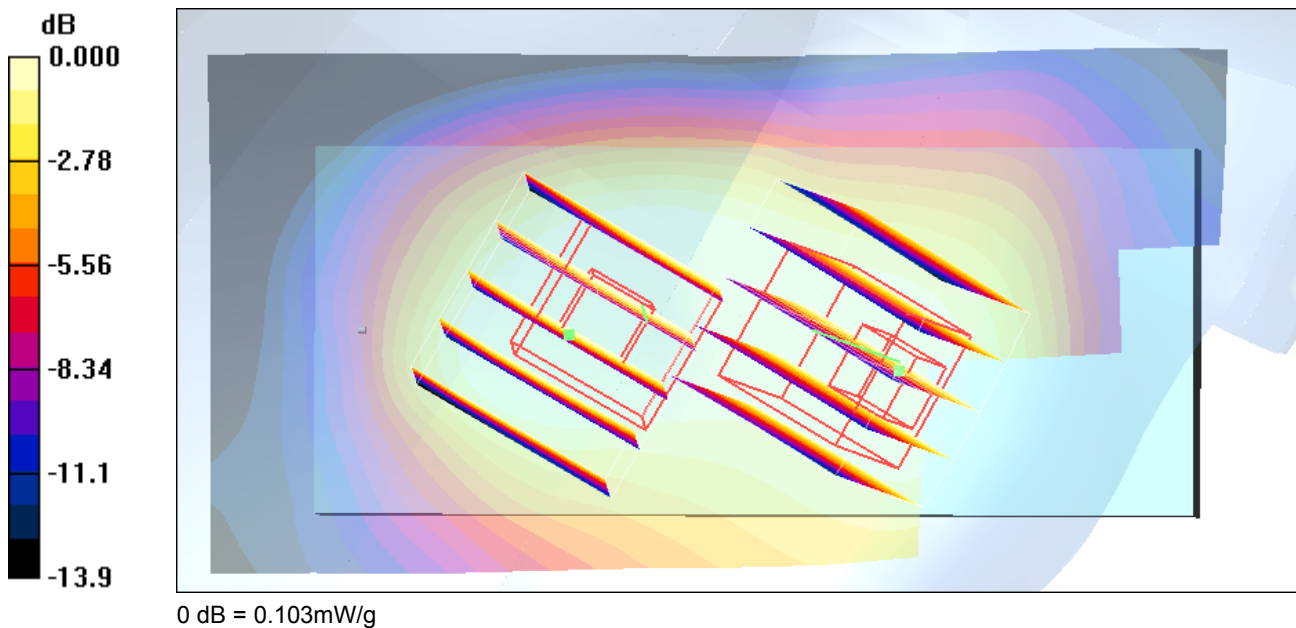



Test Laboratory: Sporton International Inc. SAR/HAC Testing Lab

Date: 2009/3/13

Right Tilted_GSM1900 Ch661

DUT: 931114

Communication System: PCS; Frequency: 1880 MHz; Duty Cycle: 1:8.3

Medium: HSL_1900 Medium parameters used: $f = 1880$ MHz; $\sigma = 1.39$ mho/m; $\epsilon_r = 38.4$; $\rho = 1000$ kg/m³

Ambient Temperature : 22.3 °C; Liquid Temperature : 21.4 °C

DASY4 Configuration:

- Probe: ET3DV6 - SN1787; ConvF(5.01, 5.01, 5.01); Calibrated: 2008/8/26
- Sensor-Surface: 4mm (Mechanical Surface Detection)
- Electronics: DAE4 Sn778; Calibrated: 2008/9/22
- Phantom: SAM-Left; Type: QD 000 P40 C; Serial: TP-1477
- Measurement SW: DASY4, V4.7 Build 80; Postprocessing SW: SEMCAD, V1.8 Build 186

Ch661/Area Scan (51x101x1): Measurement grid: dx=15mm, dy=15mm

Maximum value of SAR (interpolated) = 0.124 mW/g

Ch661/Zoom Scan (5x5x7)/Cube 0: Measurement grid: dx=8mm, dy=8mm, dz=5mm

Reference Value = 6.42 V/m; Power Drift = -0.015 dB

Peak SAR (extrapolated) = 0.169 W/kg

SAR(1 g) = 0.110 mW/g; SAR(10 g) = 0.066 mW/g

Maximum value of SAR (measured) = 0.117 mW/g

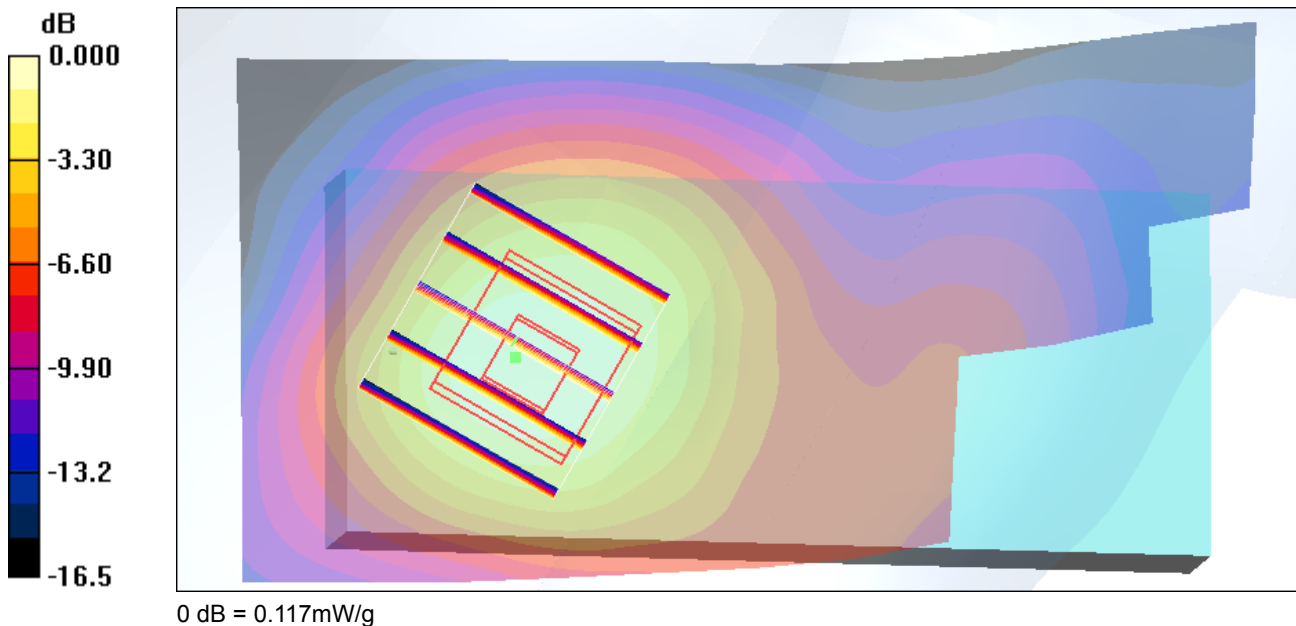



Test Laboratory: Sporton International Inc. SAR/HAC Testing Lab

Date: 2009/3/13

Left Cheek_GSM1900 Ch810

DUT: 931114

Communication System: PCS; Frequency: 1909.8 MHz; Duty Cycle: 1:8.3
Medium: HSL_1900 Medium parameters used: $f = 1910$ MHz; $\sigma = 1.42$ mho/m; $\epsilon_r = 38.3$; $\rho = 1000$ kg/m³
Ambient Temperature : 22.4 °C; Liquid Temperature : 21.4 °C

DASY4 Configuration:

- Probe: ET3DV6 - SN1787; ConvF(5.01, 5.01, 5.01); Calibrated: 2008/8/26
- Sensor-Surface: 4mm (Mechanical Surface Detection)
- Electronics: DAE4 Sn778; Calibrated: 2008/9/22
- Phantom: SAM-Left; Type: QD 000 P40 C; Serial: TP-1477
- Measurement SW: DASY4, V4.7 Build 80; Postprocessing SW: SEMCAD, V1.8 Build 186

Ch810/Area Scan (51x101x1): Measurement grid: dx=15mm, dy=15mm
Maximum value of SAR (interpolated) = 0.229 mW/g

Ch810/Zoom Scan (5x5x7)/Cube 0: Measurement grid: dx=8mm, dy=8mm, dz=5mm
Reference Value = 4.89 V/m; Power Drift = -0.182 dB
Peak SAR (extrapolated) = 0.278 W/kg
SAR(1 g) = 0.193 mW/g; SAR(10 g) = 0.120 mW/g
Maximum value of SAR (measured) = 0.202 mW/g

Ch810/Zoom Scan (5x5x7)/Cube 1: Measurement grid: dx=8mm, dy=8mm, dz=5mm
Reference Value = 4.89 V/m; Power Drift = -0.182 dB
Peak SAR (extrapolated) = 0.291 W/kg
SAR(1 g) = 0.181 mW/g; SAR(10 g) = 0.111 mW/g
Maximum value of SAR (measured) = 0.197 mW/g

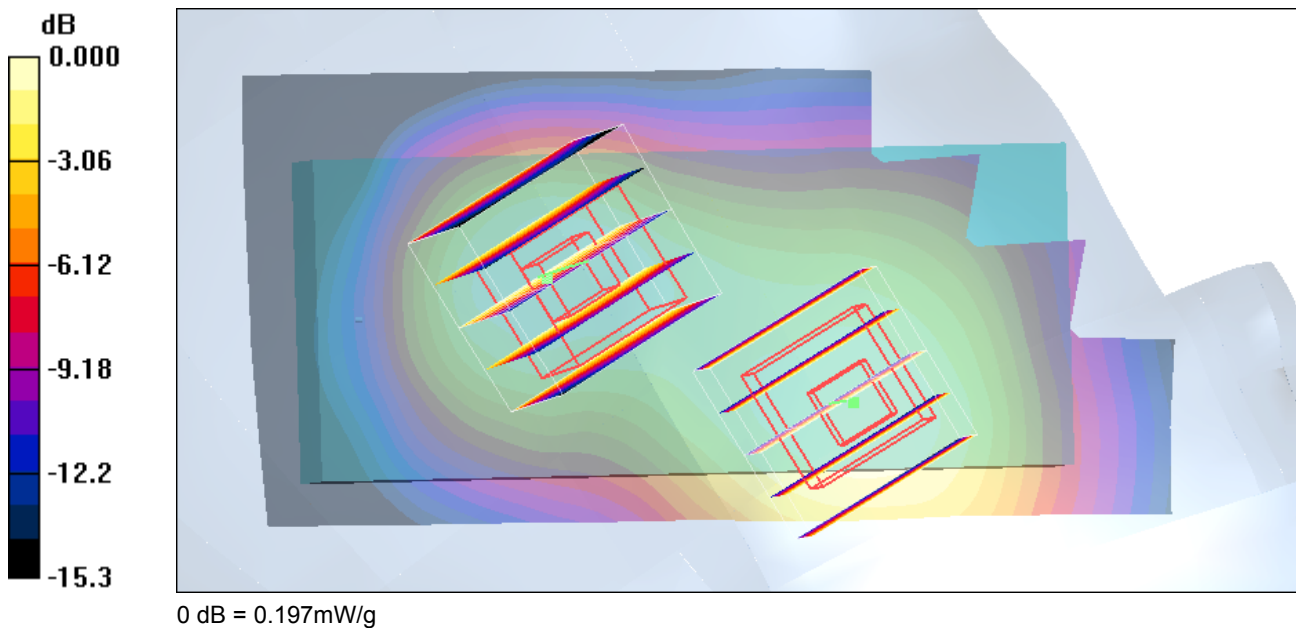



Test Laboratory: Sporton International Inc. SAR/HAC Testing Lab

Date: 2009/3/13

Left Tilted_GSM1900 Ch661

DUT: 931114

Communication System: PCS; Frequency: 1880 MHz; Duty Cycle: 1:8.3
Medium: HSL_1900 Medium parameters used: $f = 1880$ MHz; $\sigma = 1.39$ mho/m; $\epsilon_r = 38.4$; $\rho = 1000$ kg/m³
Ambient Temperature : 22.4 °C; Liquid Temperature : 21.4 °C

DASY4 Configuration:

- Probe: ET3DV6 - SN1787; ConvF(5.01, 5.01, 5.01); Calibrated: 2008/8/26
- Sensor-Surface: 4mm (Mechanical Surface Detection)
- Electronics: DAE4 Sn778; Calibrated: 2008/9/22
- Phantom: SAM-Left; Type: QD 000 P40 C; Serial: TP-1477
- Measurement SW: DASY4, V4.7 Build 80; Postprocessing SW: SEMCAD, V1.8 Build 186

Ch661/Area Scan (51x101x1): Measurement grid: dx=15mm, dy=15mm
Maximum value of SAR (interpolated) = 0.125 mW/g

Ch661/Zoom Scan (5x5x7)/Cube 0: Measurement grid: dx=8mm, dy=8mm, dz=5mm
Reference Value = 6.26 V/m; Power Drift = -0.018 dB
Peak SAR (extrapolated) = 0.159 W/kg
SAR(1 g) = 0.105 mW/g; SAR(10 g) = 0.065 mW/g
Maximum value of SAR (measured) = 0.111 mW/g

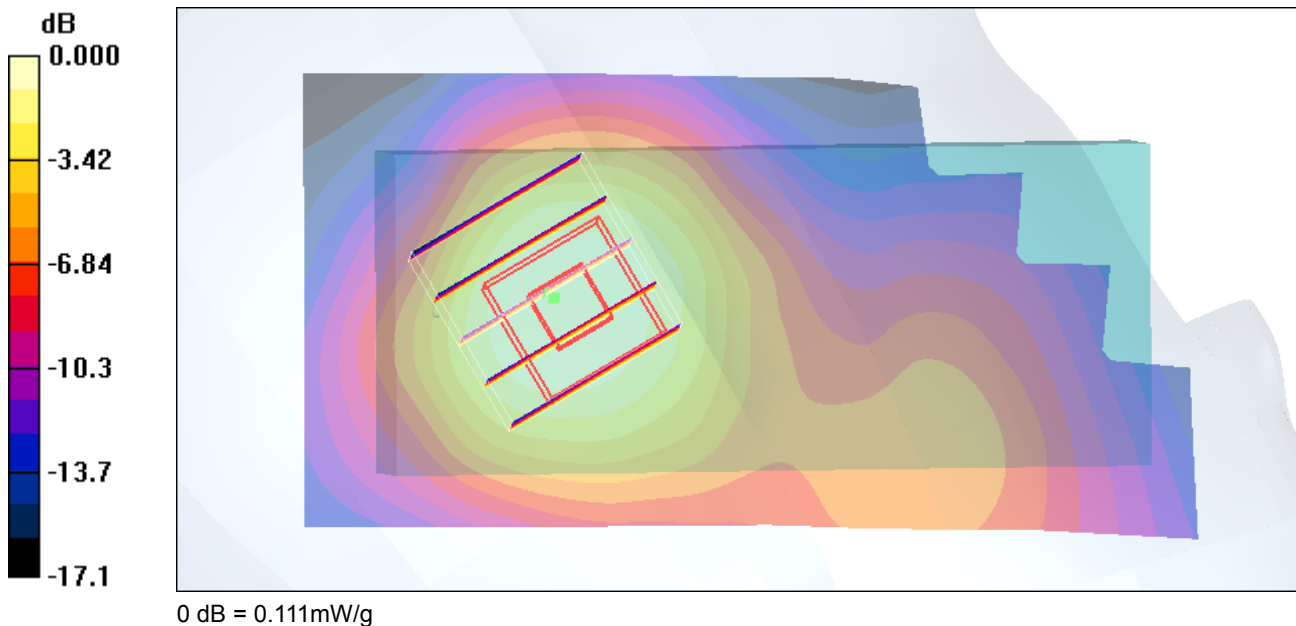



Test Laboratory: Sporton International Inc. SAR/HAC Testing Lab

Date: 2009/3/13

Body_GSM850 Ch189_Face of the DUT with 1.5cm Gap_GSM Mode

DUT: 931114

Communication System: GSM850; Frequency: 836.4 MHz; Duty Cycle: 1:8.3
Medium: MSL_850 Medium parameters used : f = 836.4 MHz; sigma = 0.977 mho/m; epsilon_r = 52.9; rho = 1000 kg/m^3
Ambient Temperature : 22.3 C; Liquid Temperature : 21.5 C

DASY4 Configuration:

- Probe: ET3DV6 - SN1787; ConvF(5.91, 5.91, 5.91); Calibrated: 2008/8/26
- Sensor-Surface: 4mm (Mechanical Surface Detection)
- Electronics: DAE4 Sn778; Calibrated: 2008/9/22
- Phantom: ELI 4.0_Front; Type: QDOVA001BB; Serial: 1026
- Measurement SW: DASY4, V4.7 Build 80; Postprocessing SW: SEMCAD, V1.8 Build 186

Ch189/Area Scan (51x101x1): Measurement grid: dx=15mm, dy=15mm
Maximum value of SAR (interpolated) = 0.266 mW/g

Ch189/Zoom Scan (5x5x7)/Cube 0: Measurement grid: dx=8mm, dy=8mm, dz=5mm
Reference Value = 6.96 V/m; Power Drift = -0.073 dB
Peak SAR (extrapolated) = 0.304 W/kg
SAR(1 g) = 0.245 mW/g; SAR(10 g) = 0.180 mW/g
Maximum value of SAR (measured) = 0.258 mW/g

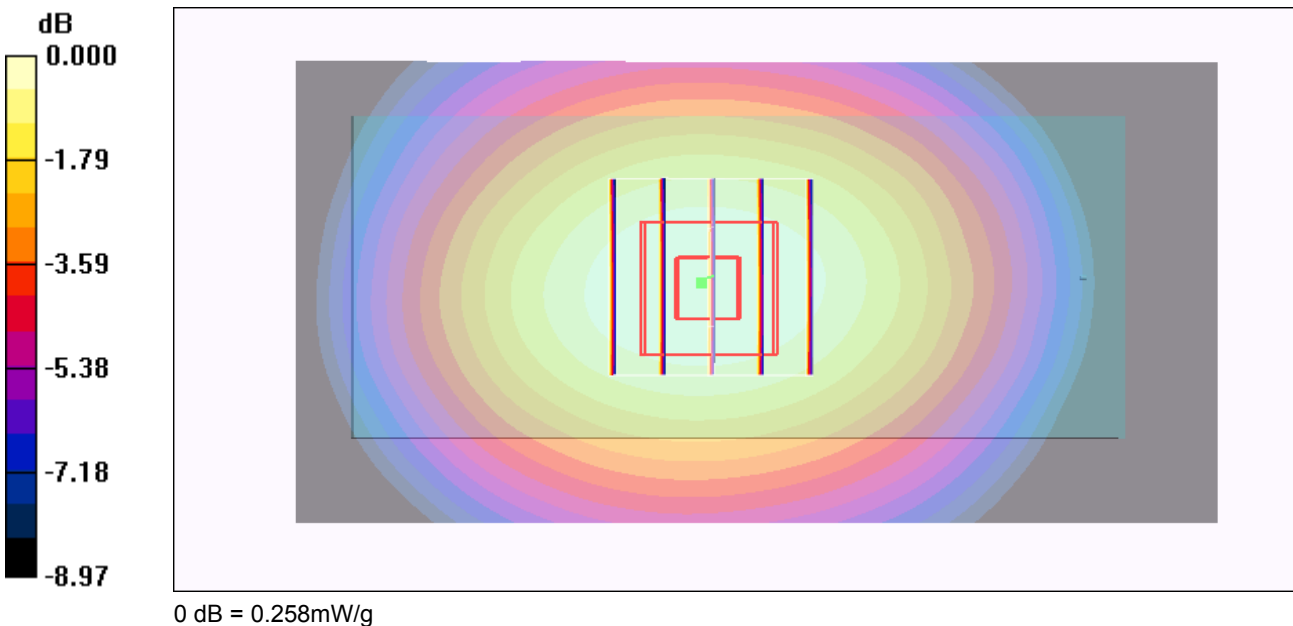



Test Laboratory: Sporton International Inc. SAR/HAC Testing Lab

Date: 2009/3/13

Body_GSM850 Ch251_Bottom of the DUT with 1.5cm Gap_GSM Mode

DUT: 931114

Communication System: GSM850; Frequency: 848.8 MHz; Duty Cycle: 1:8.3
Medium: MSL_850 Medium parameters used: $f = 849$ MHz; $\sigma = 0.989$ mho/m; $\epsilon_r = 52.7$; $\rho = 1000$ kg/m³
Ambient Temperature : 22.4 °C; Liquid Temperature : 21.4 °C

DASY4 Configuration:

- Probe: ET3DV6 - SN1787; ConvF(5.91, 5.91, 5.91); Calibrated: 2008/8/26
- Sensor-Surface: 4mm (Mechanical Surface Detection)
- Electronics: DAE4 Sn778; Calibrated: 2008/9/22
- Phantom: ELI 4.0_Front; Type: QDOVA001BB; Serial: 1026
- Measurement SW: DASY4, V4.7 Build 80; Postprocessing SW: SEMCAD, V1.8 Build 186

Ch251/Area Scan (51x101x1): Measurement grid: dx=15mm, dy=15mm
Maximum value of SAR (interpolated) = 0.740 mW/g

Ch251/Zoom Scan (5x5x7)/Cube 0: Measurement grid: dx=8mm, dy=8mm, dz=5mm
Reference Value = 11.1 V/m; Power Drift = -0.025 dB
Peak SAR (extrapolated) = 0.892 W/kg
SAR(1 g) = 0.702 mW/g; SAR(10 g) = 0.509 mW/g
Maximum value of SAR (measured) = 0.747 mW/g

Ch251/Zoom Scan (5x5x7)/Cube 1: Measurement grid: dx=8mm, dy=8mm, dz=5mm
Reference Value = 11.1 V/m; Power Drift = -0.025 dB
Peak SAR (extrapolated) = 0.838 W/kg
SAR(1 g) = 0.657 mW/g; SAR(10 g) = 0.456 mW/g
Maximum value of SAR (measured) = 0.710 mW/g

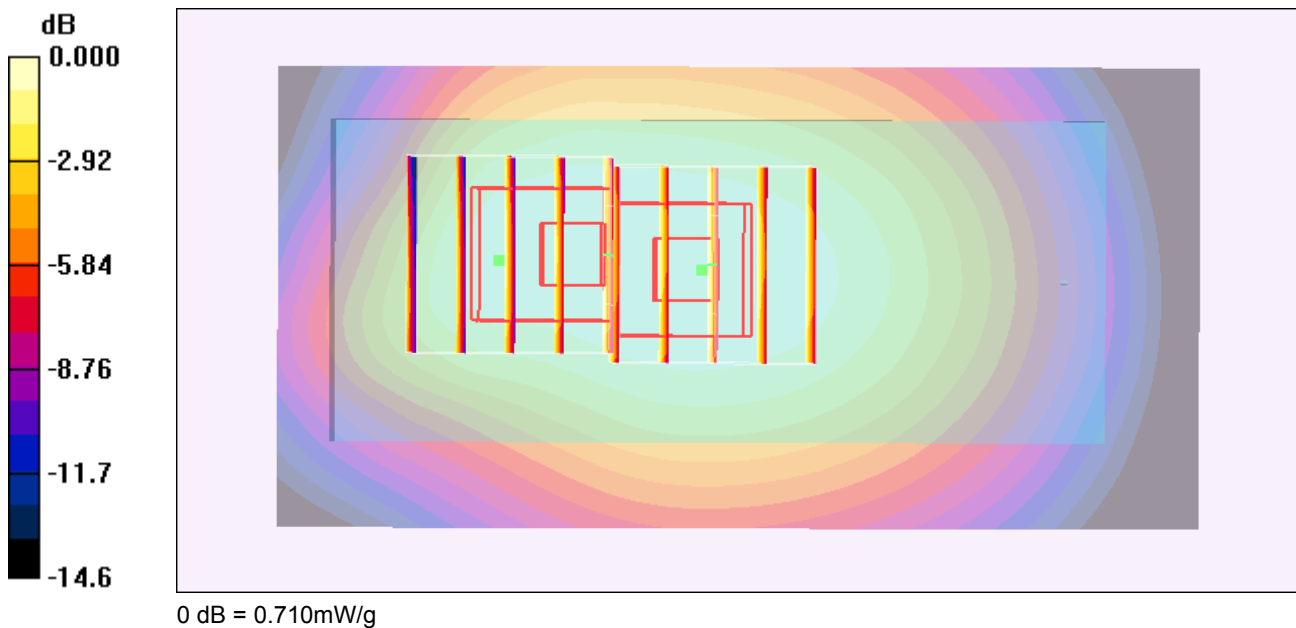

Test Laboratory: Sporton International Inc. SAR/HAC Testing Lab

Date: 2009/3/13

Body_GSM1900 Ch661_Face of the DUT with 1.5cm Gap_GSM Mode

DUT: 931114

Communication System: PCS; Frequency: 1880 MHz; Duty Cycle: 1:8.3

Medium: MSL_1900 Medium parameters used: $f = 1880$ MHz; $\sigma = 1.52$ mho/m; $\epsilon_r = 52.3$; $\rho = 1000$ kg/m³

Ambient Temperature : 22.4 °C; Liquid Temperature : 21.3 °C

DASY4 Configuration:

- Probe: ET3DV6 - SN1787; ConvF(4.49, 4.49, 4.49); Calibrated: 2008/8/26
- Sensor-Surface: 4mm (Mechanical Surface Detection)
- Electronics: DAE4 Sn778; Calibrated: 2008/9/22
- Phantom: SAM-Right; Type: QD 000 P40 C; Serial: TP-1383
- Measurement SW: DASY4, V4.7 Build 80; Postprocessing SW: SEMCAD, V1.8 Build 186

Ch661/Area Scan (51x101x1): Measurement grid: dx=15mm, dy=15mm

Maximum value of SAR (interpolated) = 0.112 mW/g

Ch661/Zoom Scan (5x5x7)/Cube 0: Measurement grid: dx=8mm, dy=8mm, dz=5mm

Reference Value = 4.34 V/m; Power Drift = -0.114 dB

Peak SAR (extrapolated) = 0.171 W/kg

SAR(1 g) = 0.103 mW/g; SAR(10 g) = 0.064 mW/g

Maximum value of SAR (measured) = 0.110 mW/g

Ch661/Zoom Scan (5x5x7)/Cube 1: Measurement grid: dx=8mm, dy=8mm, dz=5mm

Reference Value = 4.34 V/m; Power Drift = -0.114 dB

Peak SAR (extrapolated) = 0.104 W/kg

SAR(1 g) = 0.068 mW/g; SAR(10 g) = 0.044 mW/g

Maximum value of SAR (measured) = 0.073 mW/g

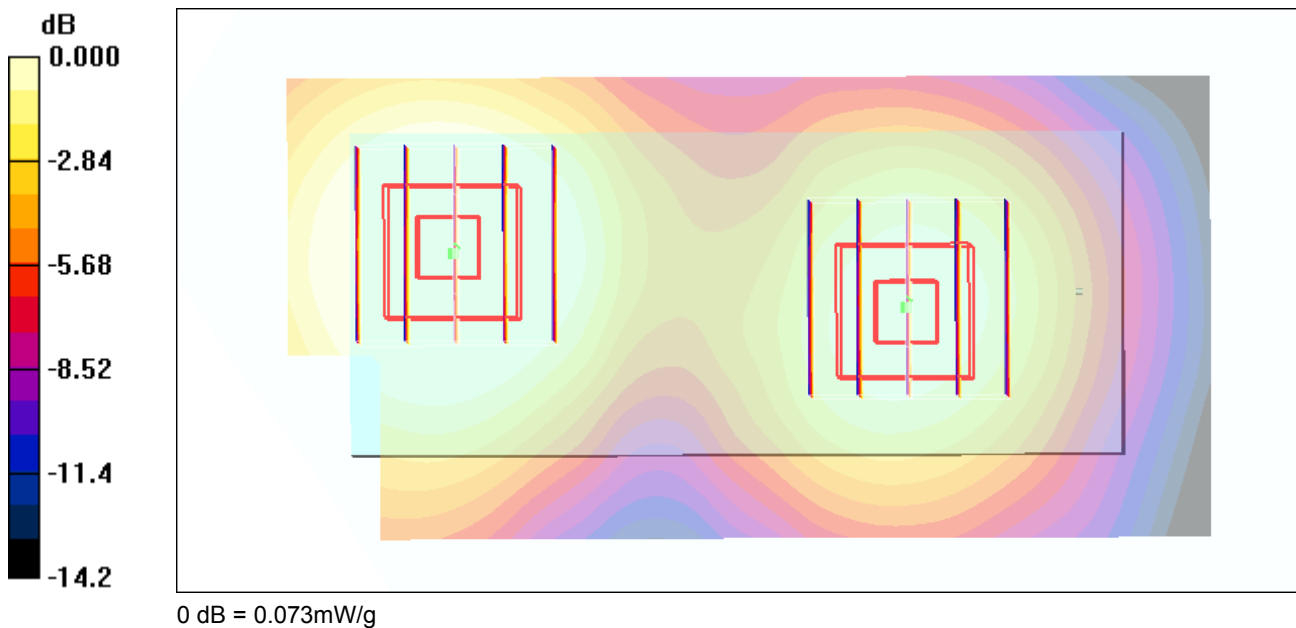



Test Laboratory: Sporton International Inc. SAR/HAC Testing Lab

Date: 2009/3/13

Body_GSM1900 Ch810_Bottom of the DUT with 1.5cm Gap_GSM Mode

DUT: 931114

Communication System: PCS; Frequency: 1909.8 MHz; Duty Cycle: 1:8.3

Medium: MSL_1900 Medium parameters used: $f = 1910$ MHz; $\sigma = 1.56$ mho/m; $\epsilon_r = 52.2$; $\rho = 1000$ kg/m³

Ambient Temperature : 22.4 °C; Liquid Temperature : 21.4 °C

DASY4 Configuration:

- Probe: ET3DV6 - SN1787; ConvF(4.49, 4.49, 4.49); Calibrated: 2008/8/26
- Sensor-Surface: 4mm (Mechanical Surface Detection)
- Electronics: DAE4 Sn778; Calibrated: 2008/9/22
- Phantom: SAM-Right; Type: QD 000 P40 C; Serial: TP-1383
- Measurement SW: DASY4, V4.7 Build 80; Postprocessing SW: SEMCAD, V1.8 Build 186

Ch810/Area Scan (51x101x1): Measurement grid: dx=15mm, dy=15mm

Maximum value of SAR (interpolated) = 0.672 mW/g

Ch810/Zoom Scan (5x5x7)/Cube 0: Measurement grid: dx=8mm, dy=8mm, dz=5mm

Reference Value = 6.61 V/m; Power Drift = 0.005 dB

Peak SAR (extrapolated) = 1.08 W/kg

SAR(1 g) = 0.617 mW/g; SAR(10 g) = 0.353 mW/g

Maximum value of SAR (measured) = 0.660 mW/g

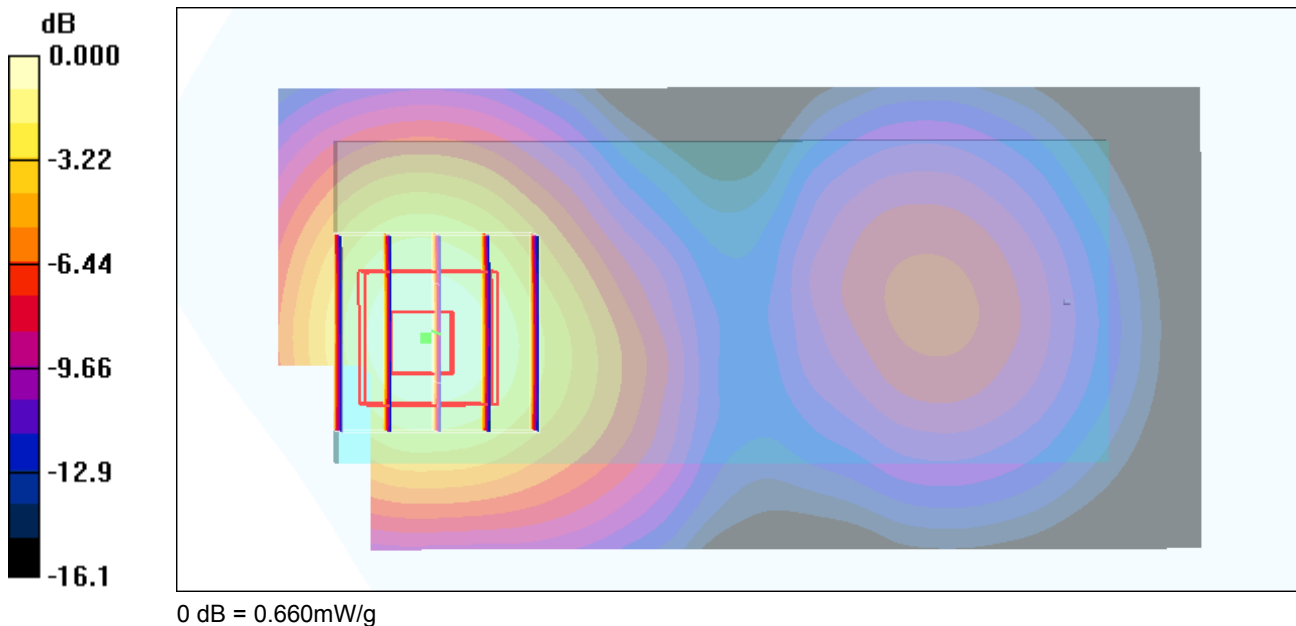



Test Laboratory: Sporton International Inc. SAR/HAC Testing Lab

Date: 2009/3/13

Right Cheek_GSM850 Ch251_2D

DUT: 931114

Communication System: GSM850; Frequency: 848.8 MHz; Duty Cycle: 1:8.3
Medium: HSL_850 Medium parameters used: $f = 849$ MHz; $\sigma = 0.909$ mho/m; $\epsilon_r = 41.2$; $\rho = 1000$ kg/m³
Ambient Temperature : 22.3 °C; Liquid Temperature : 21.4 °C

DASY4 Configuration:

- Probe: ET3DV6 - SN1787; ConvF(6.06, 6.06, 6.06); Calibrated: 2008/8/26
- Sensor-Surface: 4mm (Mechanical Surface Detection)
- Electronics: DAE4 Sn778; Calibrated: 2008/9/22
- Phantom: SAM-Right; Type: QD 000 P40 C; Serial: TP-1383
- Measurement SW: DASY4, V4.7 Build 80; Postprocessing SW: SEMCAD, V1.8 Build 186

Ch251/Area Scan (51x101x1): Measurement grid: dx=15mm, dy=15mm
Maximum value of SAR (interpolated) = 0.672 mW/g

Ch251/Zoom Scan (5x5x7)/Cube 0: Measurement grid: dx=8mm, dy=8mm, dz=5mm
Reference Value = 14.7 V/m; Power Drift = 0.045 dB
Peak SAR (extrapolated) = 0.760 W/kg
SAR(1 g) = 0.618 mW/g; SAR(10 g) = 0.450 mW/g
Maximum value of SAR (measured) = 0.650 mW/g

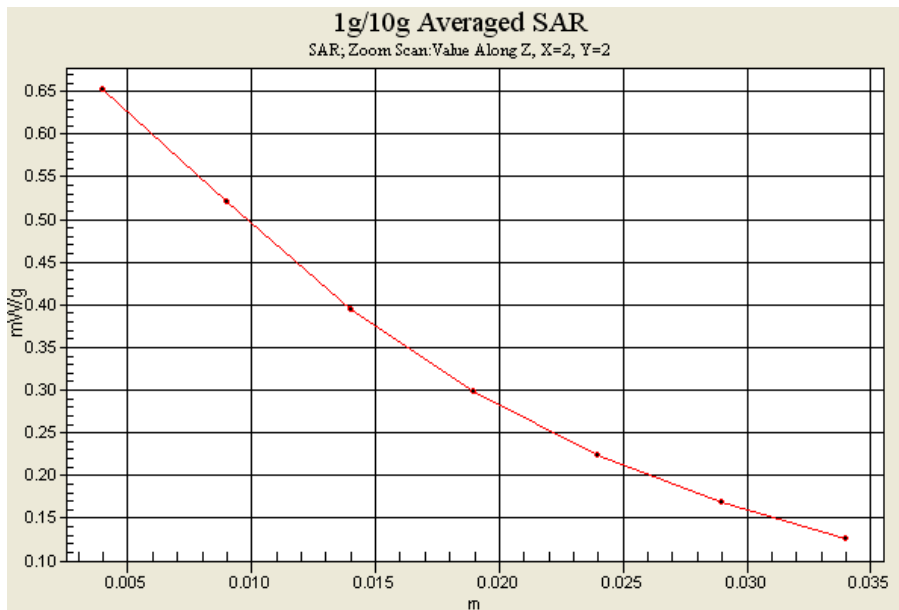



Test Laboratory: Sporton International Inc. SAR/HAC Testing Lab

Date: 2009/3/13

Left Cheek_GSM1900 Ch810_2D

DUT: 931114

Communication System: PCS; Frequency: 1909.8 MHz; Duty Cycle: 1:8.3
Medium: HSL_1900 Medium parameters used: $f = 1910$ MHz; $\sigma = 1.42$ mho/m; $\epsilon_r = 38.3$; $\rho = 1000$ kg/m³
Ambient Temperature : 22.4 °C; Liquid Temperature : 21.4 °C

DASY4 Configuration:

- Probe: ET3DV6 - SN1787; ConvF(5.01, 5.01, 5.01); Calibrated: 2008/8/26
- Sensor-Surface: 4mm (Mechanical Surface Detection)
- Electronics: DAE4 Sn778; Calibrated: 2008/9/22
- Phantom: SAM-Left; Type: QD 000 P40 C; Serial: TP-1477
- Measurement SW: DASY4, V4.7 Build 80; Postprocessing SW: SEMCAD, V1.8 Build 186

Ch810/Area Scan (51x101x1): Measurement grid: dx=15mm, dy=15mm
Maximum value of SAR (interpolated) = 0.229 mW/g

Ch810/Zoom Scan (5x5x7)/Cube 0: Measurement grid: dx=8mm, dy=8mm, dz=5mm
Reference Value = 4.89 V/m; Power Drift = -0.182 dB
Peak SAR (extrapolated) = 0.278 W/kg
SAR(1 g) = 0.193 mW/g; SAR(10 g) = 0.120 mW/g
Maximum value of SAR (measured) = 0.202 mW/g

Ch810/Zoom Scan (5x5x7)/Cube 1: Measurement grid: dx=8mm, dy=8mm, dz=5mm
Reference Value = 4.89 V/m; Power Drift = -0.182 dB
Peak SAR (extrapolated) = 0.291 W/kg
SAR(1 g) = 0.181 mW/g; SAR(10 g) = 0.111 mW/g
Maximum value of SAR (measured) = 0.197 mW/g

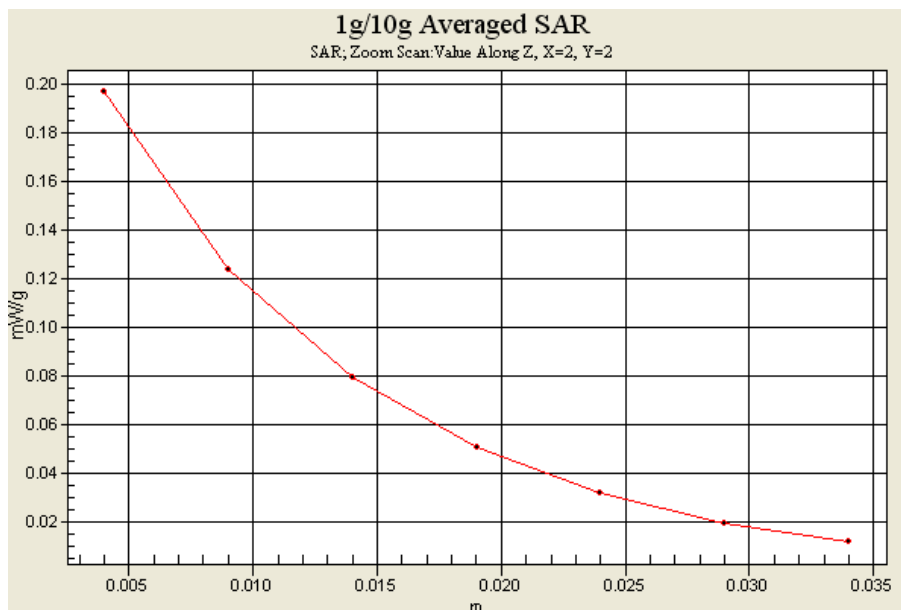



Test Laboratory: Sporton International Inc. SAR/HAC Testing Lab

Date: 2009/3/13

Body_GSM850 Ch251_Bottom of the DUT with 1.5cm Gap_GSM Mode_2D

DUT: 931114

Communication System: GSM850; Frequency: 848.8 MHz; Duty Cycle: 1:8.3
Medium: MSL_850 Medium parameters used: $f = 849$ MHz; $\sigma = 0.989$ mho/m; $\epsilon_r = 52.7$; $\rho = 1000$ kg/m³
Ambient Temperature : 22.4 °C; Liquid Temperature : 21.4 °C

DASY4 Configuration:

- Probe: ET3DV6 - SN1787; ConvF(5.91, 5.91, 5.91); Calibrated: 2008/8/26
- Sensor-Surface: 4mm (Mechanical Surface Detection)
- Electronics: DAE4 Sn778; Calibrated: 2008/9/22
- Phantom: ELI 4.0_Front; Type: QDOVA001BB; Serial: 1026
- Measurement SW: DASY4, V4.7 Build 80; Postprocessing SW: SEMCAD, V1.8 Build 186

Ch251/Area Scan (51x101x1): Measurement grid: dx=15mm, dy=15mm
Maximum value of SAR (interpolated) = 0.740 mW/g

Ch251/Zoom Scan (5x5x7)/Cube 0: Measurement grid: dx=8mm, dy=8mm, dz=5mm
Reference Value = 11.1 V/m; Power Drift = -0.025 dB
Peak SAR (extrapolated) = 0.892 W/kg
SAR(1 g) = 0.702 mW/g; SAR(10 g) = 0.509 mW/g
Maximum value of SAR (measured) = 0.747 mW/g

Ch251/Zoom Scan (5x5x7)/Cube 1: Measurement grid: dx=8mm, dy=8mm, dz=5mm
Reference Value = 11.1 V/m; Power Drift = -0.025 dB
Peak SAR (extrapolated) = 0.838 W/kg
SAR(1 g) = 0.657 mW/g; SAR(10 g) = 0.456 mW/g
Maximum value of SAR (measured) = 0.710 mW/g

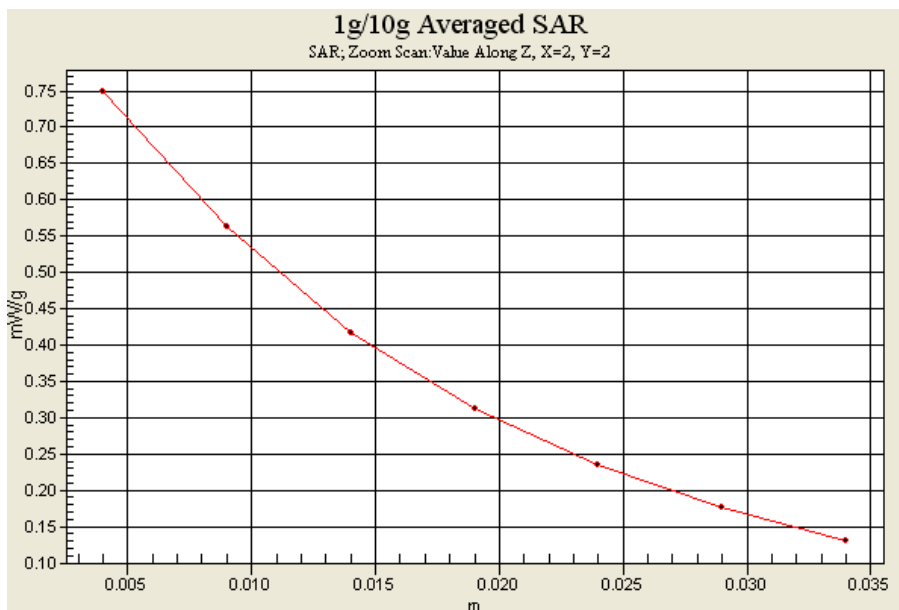



Test Laboratory: Sporton International Inc. SAR/HAC Testing Lab

Date: 2009/3/13

Body_GSM1900 Ch810_Bottom of the DUT with 1.5cm Gap_GSM Mode_2D

DUT: 931114

Communication System: PCS; Frequency: 1909.8 MHz; Duty Cycle: 1:8.3
Medium: MSL_1900 Medium parameters used: $f = 1910$ MHz; $\sigma = 1.56$ mho/m; $\epsilon_r = 52.2$; $\rho = 1000$ kg/m³
Ambient Temperature : 22.4 °C; Liquid Temperature : 21.4 °C

DASY4 Configuration:

- Probe: ET3DV6 - SN1787; ConvF(4.49, 4.49, 4.49); Calibrated: 2008/8/26
- Sensor-Surface: 4mm (Mechanical Surface Detection)
- Electronics: DAE4 Sn778; Calibrated: 2008/9/22
- Phantom: SAM-Right; Type: QD 000 P40 C; Serial: TP-1383
- Measurement SW: DASY4, V4.7 Build 80; Postprocessing SW: SEMCAD, V1.8 Build 186

Ch810/Area Scan (51x101x1): Measurement grid: dx=15mm, dy=15mm
Maximum value of SAR (interpolated) = 0.672 mW/g

Ch810/Zoom Scan (5x5x7)/Cube 0: Measurement grid: dx=8mm, dy=8mm, dz=5mm
Reference Value = 6.61 V/m; Power Drift = 0.005 dB
Peak SAR (extrapolated) = 1.08 W/kg
SAR(1 g) = 0.617 mW/g; SAR(10 g) = 0.353 mW/g
Maximum value of SAR (measured) = 0.660 mW/g

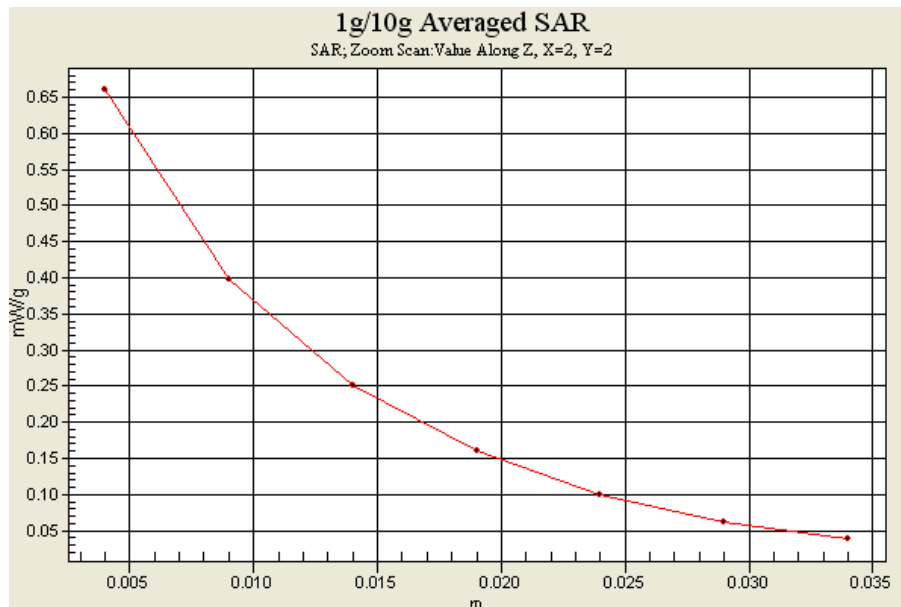



Appendix C – Calibration Data

Please refer to the calibration certificates of DASY as below.



Calibration Certificate of DASY

Calibration Laboratory of
Schmid & Partner
Engineering AG
 Zeughausstrasse 43, 8004 Zurich, Switzerland



S Schweizerischer Kalibrierdienst
C Service suisse d'étalonnage
S Servizio svizzero di taratura
S Swiss Calibration Service

Accredited by the Swiss Accreditation Service (SAS)
 The Swiss Accreditation Service is one of the signatories to the EA
 Multilateral Agreement for the recognition of calibration certificates

Accreditation No.: **SCS 108**

Client **Sporton (Auden)**

Certificate No: **D835V2-499_Mar08**

CALIBRATION CERTIFICATE

Object **D835V2 - SN: 499**

Calibration procedure(s) **QA CAL-05.v7
 Calibration procedure for dipole validation kits**

Calibration date: **March 17, 2008**

Condition of the calibrated item **In Tolerance**

This calibration certificate documents the traceability to national standards, which realize the physical units of measurements (SI).
 The measurements and the uncertainties with confidence probability are given on the following pages and are part of the certificate.

All calibrations have been conducted in the closed laboratory facility: environment temperature (22 ± 3)°C and humidity < 70%.

Calibration Equipment used (M&TE critical for calibration)

Primary Standards	ID #	Cal Date (Calibrated by, Certificate No.)	Scheduled Calibration
Power meter EPM-442A	GB37480704	04-Oct-07 (METAS, No. 217-00736)	Oct-08
Power sensor HP 8481A	US37292783	04-Oct-07 (METAS, No. 217-00736)	Oct-08
Reference 20 dB Attenuator	SN: 5086 (20g)	07-Aug-07 (METAS, No 217-00718)	Aug-08
Reference Probe ES3DV2	SN: 3025	01-Mar-08 (SPEAG, No. ES3-3025_Mar08)	Mar-09
DAE4	SN 909	03-Sep-07 (SPEAG, No. DAE4-909_Sep07)	Sep-08
Secondary Standards	ID #	Check Date (in house)	Scheduled Check
Power sensor HP 8481A	MY41092317	18-Oct-02 (SPEAG, in house check Oct-07)	In house check: Oct-09
RF generator R&S SMT-06	100005	04-Aug-99 (SPEAG, in house check Oct-07)	In house check: Oct-09
Network Analyzer HP 8753E	US37390585 S4206	18-Oct-01 (SPEAG, in house check Oct-07)	In house check: Oct-08

	Name	Function	Signature
Calibrated by:	Claudio Leubler	Laboratory Technician	
Approved by:	Katja Pokovic	Technical Manager	

Issued: March 17, 2008

This calibration certificate shall not be reproduced except in full without written approval of the laboratory.



**Calibration Laboratory of
Schmid & Partner
Engineering AG**
Zeughausstrasse 43, 8004 Zurich, Switzerland



S Schweizerischer Kalibrierdienst
C Service suisse d'étalonnage
S Servizio svizzero di taratura
S Swiss Calibration Service

Accredited by the Swiss Accreditation Service (SAS)
The Swiss Accreditation Service is one of the signatories to the EA
Multilateral Agreement for the recognition of calibration certificates

Accreditation No.: **SCS 108**

Glossary:

TSL tissue simulating liquid
ConvF sensitivity in TSL / NORM x,y,z
N/A not applicable or not measured

Calibration is Performed According to the Following Standards:

- a) IEEE Std 1528-2003, "IEEE Recommended Practice for Determining the Peak Spatial-Averaged Specific Absorption Rate (SAR) in the Human Head from Wireless Communications Devices: Measurement Techniques", December 2003
- b) IEC 62209-1, "Procedure to measure the Specific Absorption Rate (SAR) for hand-held devices used in close proximity to the ear (frequency range of 300 MHz to 3 GHz)", February 2005
- c) Federal Communications Commission Office of Engineering & Technology (FCC OET), "Evaluating Compliance with FCC Guidelines for Human Exposure to Radiofrequency Electromagnetic Fields; Additional Information for Evaluating Compliance of Mobile and Portable Devices with FCC Limits for Human Exposure to Radiofrequency Emissions", Supplement C (Edition 01-01) to Bulletin 65

Additional Documentation:

- d) DASY4 System Handbook

Methods Applied and Interpretation of Parameters:

- *Measurement Conditions:* Further details are available from the Validation Report at the end of the certificate. All figures stated in the certificate are valid at the frequency indicated.
- *Antenna Parameters with TSL:* The dipole is mounted with the spacer to position its feed point exactly below the center marking of the flat phantom section, with the arms oriented parallel to the body axis.
- *Feed Point Impedance and Return Loss:* These parameters are measured with the dipole positioned under the liquid filled phantom. The impedance stated is transformed from the measurement at the SMA connector to the feed point. The Return Loss ensures low reflected power. No uncertainty required.
- *Electrical Delay:* One-way delay between the SMA connector and the antenna feed point. No uncertainty required.
- *SAR measured:* SAR measured at the stated antenna input power.
- *SAR normalized:* SAR as measured, normalized to an input power of 1 W at the antenna connector.
- *SAR for nominal TSL parameters:* The measured TSL parameters are used to calculate the nominal SAR result.



Measurement Conditions

DASY system configuration, as far as not given on page 1.

DASY Version	DASY4	V4.7
Extrapolation	Advanced Extrapolation	
Phantom	Modular Flat Phantom V4.9	
Distance Dipole Center - TSL	15 mm	with Spacer
Zoom Scan Resolution	dx, dy, dz = 5 mm	
Frequency	835 MHz ± 1 MHz	

Head TSL parameters

The following parameters and calculations were applied.

	Temperature	Permittivity	Conductivity
Nominal Head TSL parameters	22.0 °C	41.5	0.90 mho/m
Measured Head TSL parameters	(22.0 ± 0.2) °C	41.5 ± 6 %	0.90 mho/m ± 6 %
Head TSL temperature during test	(22.0 ± 0.2) °C	----	----

SAR result with Head TSL

SAR averaged over 1 cm ³ (1 g) of Head TSL	Condition	
SAR measured	250 mW input power	2.29 mW / g
SAR normalized	normalized to 1W	9.16 mW / g
SAR for nominal Head TSL parameters ¹	normalized to 1W	9.16 mW / g ± 17.0 % (k=2)

SAR averaged over 10 cm ³ (10 g) of Head TSL	condition	
SAR measured	250 mW input power	1.50 mW / g
SAR normalized	normalized to 1W	6.00 mW / g
SAR for nominal Head TSL parameters ¹	normalized to 1W	6.00 mW / g ± 16.5 % (k=2)

¹ Correction to nominal TSL parameters according to d), chapter "SAR Sensitivities"



Body TSL parameters

The following parameters and calculations were applied.

	Temperature	Permittivity	Conductivity
Nominal Body TSL parameters	22.0 °C	55.2	0.97 mho/m
Measured Body TSL parameters	(22.0 ± 0.2) °C	54.0 ± 6 %	1.00 mho/m ± 6 %
Body TSL temperature during test	(22.0 ± 0.2) °C	---	---

SAR result with Body TSL

SAR averaged over 1 cm ³ (1 g) of Body TSL	Condition	
SAR measured	250 mW input power	2.46 mW / g
SAR normalized	normalized to 1W	9.84 mW / g
SAR for nominal Body TSL parameters ²	normalized to 1W	9.52 mW / g ± 17.0 % (k=2)

SAR averaged over 10 cm ³ (10 g) of Body TSL	condition	
SAR measured	250 mW input power	1.63 mW / g
SAR normalized	normalized to 1W	6.52 mW / g
SAR for nominal Body TSL parameters ²	normalized to 1W	6.37 mW / g ± 16.5 % (k=2)

² Correction to nominal TSL parameters according to d), chapter "SAR Sensitivities"



Appendix

Antenna Parameters with Head TSL

Impedance, transformed to feed point	52.9 Ω - 2.3 j Ω
Return Loss	- 28.9 dB

Antenna Parameters with Body TSL

Impedance, transformed to feed point	49.2 Ω - 3.3 j Ω
Return Loss	- 29.3 dB

General Antenna Parameters and Design

Electrical Delay (one direction)	1.392 ns
----------------------------------	----------

After long term use with 100W radiated power, only a slight warming of the dipole near the feedpoint can be measured.

The dipole is made of standard semirigid coaxial cable. The center conductor of the feeding line is directly connected to the second arm of the dipole. The antenna is therefore short-circuited for DC-signals.

No excessive force must be applied to the dipole arms, because they might bend or the soldered connections near the feedpoint may be damaged.

Additional EUT Data

Manufactured by	SPEAG
Manufactured on	July 10, 2003

DASY4 Validation Report for Head TSL

Date/Time: 17.03.2008 11:32:45

Test Laboratory: SPEAG, Zurich, Switzerland

DUT: Dipole 835 MHz; Type: D835V2; Serial: D835V2 - SN:499

Communication System: CW-835; Frequency: 835 MHz; Duty Cycle: 1:1

Medium: HSL 900 MHz;

Medium parameters used: $f = 835 \text{ MHz}$; $\sigma = 0.9 \text{ mho/m}$; $\epsilon_r = 41.5$; $\rho = 1000 \text{ kg/m}^3$

Phantom section: Flat Section

Measurement Standard: DASY4 (High Precision Assessment)

DASY4 Configuration:

- Probe: ES3DV2 - SN3025; ConvF(6.09, 6.09, 6.09); Calibrated: 01.03.2008
- Sensor-Surface: 3.4mm (Mechanical Surface Detection)
- Electronics: DAE4 Sn909; Calibrated: 03.09.2007
- Phantom: Flat Phantom 4.9L; Type: QD000P49AA; ;
- Measurement SW: DASY4, V4.7 Build 55; Postprocessing SW: SEMCAD, V1.8 Build 172

Unnamed procedure/Zoom Scan (7x7x7)/Cube 0:

Measurement grid: $dx=5\text{mm}$, $dy=5\text{mm}$, $dz=5\text{mm}$

Reference Value = 54.9 V/m; Power Drift = -0.005 dB

Peak SAR (extrapolated) = 3.34 W/kg

SAR(1 g) = 2.29 mW/g; SAR(10 g) = 1.5 mW/g

Maximum value of SAR (measured) = 2.58 mW/g

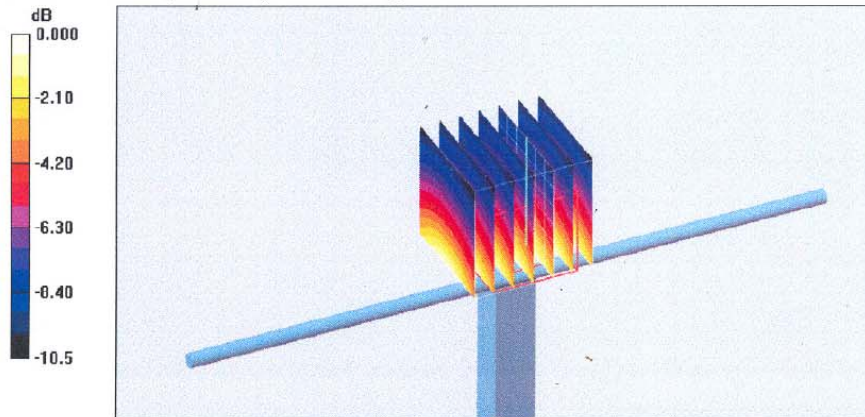

0 dB = 2.58mW/g



Impedance Measurement Plot for Head TSL

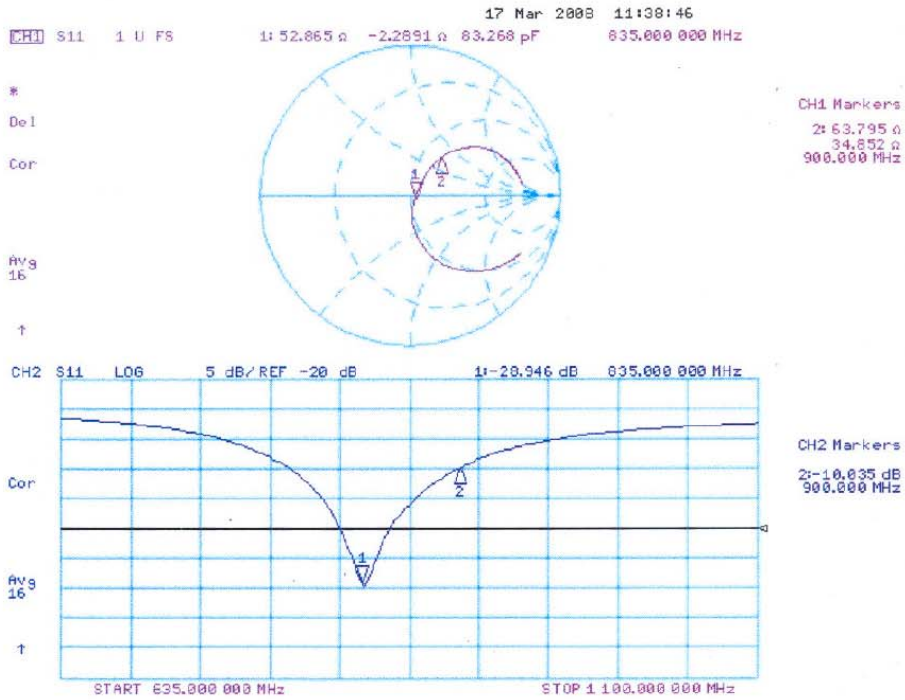

DASY4 Validation Report for Body TSL

Date/Time: 10.03.2008 12:48:36

Test Laboratory: SPEAG, Zurich, Switzerland

DUT: Dipole 835 MHz; Type: D835V2; Serial: D835V2 - SN:499

Communication System: CW; Frequency: 835 MHz; Duty Cycle: 1:1

Medium: MSL900;

Medium parameters used: $f = 835$ MHz; $\sigma = 1$ mho/m; $\epsilon_r = 54$; $\rho = 1000$ kg/m³

Phantom section: Flat Section

Measurement Standard: DASY4 (High Precision Assessment)

DASY4 Configuration:

- Probe: ES3DV2 - SN3025; ConvF(5.85, 5.85, 5.85); Calibrated: 01.03.2008
- Sensor-Surface: 4mm (Mechanical Surface Detection)
- Electronics: DAE4 Sn909; Calibrated: 03.09.2007
- Phantom: Flat Phantom 4.9L; Type: QD000P49AA; ;
- Measurement SW: DASY4, V4.7 Build 55; Postprocessing SW: SEMCAD, V1.8 Build 172

Pin = 250mW, d = 15mm/Zoom Scan (7x7x7)/Cube 0:

Measurement grid: dx=5mm, dy=5mm, dz=5mm

Reference Value = 51.8 V/m; Power Drift = 0.036 dB

Peak SAR (extrapolated) = 3.59 W/kg

SAR(1 g) = 2.46 mW/g; SAR(10 g) = 1.63 mW/g

Maximum value of SAR (measured) = 2.64 mW/g

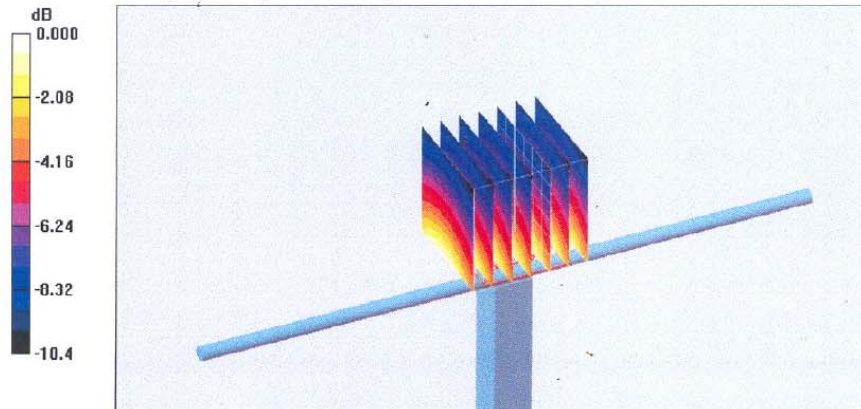

0 dB = 2.64mW/g



Impedance Measurement Plot for Body TSL

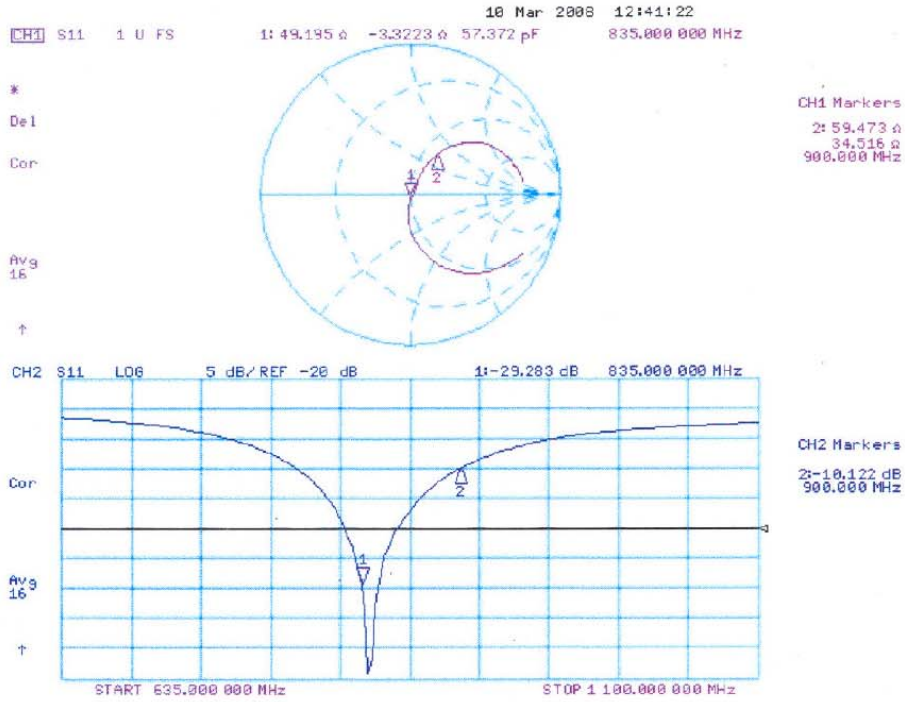



Calibration Laboratory of Schmid & Partner Engineering AG
Zaughausstrasse 43, 8004 Zurich, Switzerland



S Schweizerischer Kalibrierdienst
S Service suisse d'étalonnage
S Servizio svizzero di taratura
S Swiss Calibration Service

Accredited by the Swiss Federal Office of Metrology and Accreditation
The Swiss Accreditation Service is one of the signatories to the EA
Multilateral Agreement for the recognition of calibration certificates

Accreditation No.: SCS 108

Client Sporton (Auden)

Certificate No: D1900V2-5d041_Mar08

CALIBRATION CERTIFICATE

Object D1900V2 - SN: 5d041
Calibration procedure(s) QA CAL-05.v7
Calibration procedure for dipole validation kits
Calibration date: March 18, 2008
Condition of the calibrated item In Tolerance

This calibration certificate documents the traceability to national standards, which realize the physical units of measurements (SI).
The measurements and the uncertainties with confidence probability are given on the following pages and are part of the certificate.

All calibrations have been conducted in the closed laboratory facility; environment temperature (22 ± 3)°C and humidity < 70%.

Calibration Equipment used (M&TE critical for calibration)

Primary Standards	ID #	Cal Date (Calibrated by, Certificate No.)	Scheduled Calibration
Power meter EPM-442A	GB37480704	04-Oct-07 (METAS, No. 217-00736)	Oct-08
Power sensor HP 8461A	US37292783	04-Oct-07 (METAS, No. 217-00736)	Oct-08
Reference 20 dB Attenuator	SN: 5086 (20g)	07-Aug-07 (METAS, No. 217-00718)	Aug-08
Reference 10 dB Attenuator	SN: 5047.2 (10r)	07-Aug-07 (METAS, No. 217-00718)	Aug-08
Reference Probe ES30V2	SN: 3025	01-Mar-08 (SPEAG, No. ES3-3025_Mar08)	Mar-09
DAE4	SN 909	3-Sep-08 (SPEAG, No. DAE4-909_Sep07)	Sep-07
Secondary Standards	ID #	Check Date (in house)	Scheduled Check
Power sensor HP 8481A	MY41092317	18-Oct-02 (SPEAG, in house check Oct-07)	in house check: Oct-08
RF generator R&S SMT-06	100005	4-Aug-99 (SPEAG, in house check Oct-07)	in house check: Oct-08
Network Analyzer HP 8753E	US37390585 S4205	18-Oct-01 (SPEAG, in house check Oct-07)	in house check: Oct-08
Power meter EPM-442A	GB37480704	04-Oct-07 (METAS, No. 217-00736)	Oct-08

Calibrated by: Marcel Fehr, Laboratory Technician
Approved by: Katja Pokovic, Technical Manager

Issued: March 18, 2008

This calibration certificate shall not be reproduced except in full without written approval of the laboratory.



Calibration Laboratory of
Schmid & Partner
Engineering AG
Zeughausstrasse 43, 8004 Zurich, Switzerland



S Schweizerischer Kalibrierdienst
C Service suisse d'étalonnage
S Servizio svizzero di taratura
S Swiss Calibration Service

Accredited by the Swiss Federal Office of Metrology and Accreditation
The Swiss Accreditation Service is one of the signatories to the EA
Multilateral Agreement for the recognition of calibration certificates

Accreditation No.: **SCS 108**

Glossary:

TSL tissue simulating liquid
ConvF sensitivity in TSL / NORM x,y,z
N/A not applicable or not measured

Calibration is Performed According to the Following Standards:

- IEEE Std 1528-2003, "IEEE Recommended Practice for Determining the Peak Spatial-Averaged Specific Absorption Rate (SAR) in the Human Head from Wireless Communications Devices: Measurement Techniques", December 2003
- CENELEC EN 50361, "Basic standard for the measurement of Specific Absorption Rate related to human exposure to electromagnetic fields from mobile phones (300 MHz - 3 GHz), July 2001
- Federal Communications Commission Office of Engineering & Technology (FCC OET), "Evaluating Compliance with FCC Guidelines for Human Exposure to Radiofrequency Electromagnetic Fields; Additional Information for Evaluating Compliance of Mobile and Portable Devices with FCC Limits for Human Exposure to Radiofrequency Emissions", Supplement C (Edition 01-01) to Bulletin 65

Additional Documentation:

- DASY4 System Handbook

Methods Applied and Interpretation of Parameters:

- Measurement Conditions:** Further details are available from the Validation Report at the end of the certificate. All figures stated in the certificate are valid at the frequency indicated.
- Antenna Parameters with TSL:** The dipole is mounted with the spacer to position its feed point exactly below the center marking of the flat phantom section, with the arms oriented parallel to the body axis.
- Feed Point Impedance and Return Loss:** These parameters are measured with the dipole positioned under the liquid filled phantom. The impedance stated is transformed from the measurement at the SMA connector to the feed point. The Return Loss ensures low reflected power. No uncertainty required.
- Electrical Delay:** One-way delay between the SMA connector and the antenna feed point. No uncertainty required.
- SAR measured:** SAR measured at the stated antenna input power.
- SAR normalized:** SAR as measured, normalized to an input power of 1 W at the antenna connector.
- SAR for nominal TSL parameters:** The measured TSL parameters are used to calculate the nominal SAR result.



Measurement Conditions

DASY system configuration, as far as not given on page 1.

DASY Version	DASY4	V4.7
Extrapolation	Advanced Extrapolation	
Phantom	Modular Flat Phantom V5.0	
Distance Dipole Center - TSL	10 mm	with Spacer
Zoom Scan Resolution	dx, dy, dz = 5 mm	
Frequency	1900 MHz ± 1 MHz	

Head TSL parameters

The following parameters and calculations were applied.

	Temperature	Permittivity	Conductivity
Nominal Head TSL parameters	22.0 °C	40.0	1.40 mho/m
Measured Head TSL parameters	(22.0 ± 0.2) °C	40.2 ± 6 %	1.47 mho/m ± 6 %
Head TSL temperature during test	(21.1 ± 0.2) °C	---	---

SAR result with Head TSL

SAR averaged over 1 cm ² (1 g) of Head TSL	condition	
SAR measured	250 mW input power	10.1 mW / g
SAR normalized	normalized to 1W	40.4 mW / g
SAR for nominal Head TSL parameters ¹	normalized to 1W	39.5 mW / g ± 17.0 % (k=2)

SAR averaged over 10 cm ² (10 g) of Head TSL	Condition	
SAR measured	250 mW input power	5.20 mW / g
SAR normalized	normalized to 1W	20.8 mW / g
SAR for nominal Head TSL parameters ¹	normalized to 1W	20.6 mW / g ± 16.5 % (k=2)

¹ Correction to nominal TSL parameters according to d), chapter "SAR Sensitivities"



Body TSL parameters

The following parameters and calculations were applied.

	Temperature	Permittivity	Conductivity
Nominal Body TSL parameters	22.0 °C	53.3	1.52 mho/m
Measured Body TSL parameters	(22.0 ± 0.2) °C	51.6 ± 8 %	1.57 mho/m ± 6 %
Body TSL temperature during test	(21.4 ± 0.2) °C	---	---

SAR result with Body TSL

SAR averaged over 1 cm ³ (1 g) of Body TSL	Condition	
SAR measured	250 mW input power	10.4 mW / g
SAR normalized	normalized to 1W	41.6 mW / g
SAR for nominal Body TSL parameters ²	normalized to 1W	40.1 mW / g ± 17.0 % (k=2)

SAR averaged over 10 cm ³ (10 g) of Body TSL	condition	
SAR measured	250 mW input power	5.44 mW / g
SAR normalized	normalized to 1W	21.8 mW / g
SAR for nominal Body TSL parameters ²	normalized to 1W	21.3 mW / g ± 16.5 % (k=2)

² Correction to nominal TSL parameters according to d), chapter "SAR Sensitivities"



Appendix

Antenna Parameters with Head TSL

Impedance, transformed to feed point	54.0 Ω + 5.1 j Ω
Return Loss	- 24.2 dB

Antenna Parameters with Body TSL

Impedance, transformed to feed point	48.0 Ω + 6.1 j Ω
Return Loss	- 23.6 dB

General Antenna Parameters and Design

Electrical Delay (one direction)	1.199 ns
----------------------------------	----------

After long term use with 100W radiated power, only a slight warming of the dipole near the feedpoint can be measured.

The dipole is made of standard semirigid coaxial cable. The center conductor of the feeding line is directly connected to the second arm of the dipole. The antenna is therefore short-circuited for DC-signals.

No excessive force must be applied to the dipole arms, because they might bend or the soldered connections near the feedpoint may be damaged.

Additional EUT Data

Manufactured by	SPEAG
Manufactured on	July 04, 2003

DASY4 Validation Report for Head TSL

Date/Time: 18.03.2008 12:05:10

Test Laboratory: SPEAG, Zurich, Switzerland

DUT: Dipole 1900 MHz; Type: D1900V2; Serial: D1900V2 - SN:5d041

Communication System: CW; Frequency: 1900 MHz; Duty Cycle: 1:1

Medium: HSL U10 BB;

Medium parameters used: $f = 1900$ MHz; $\sigma = 1.47$ mho/m; $\epsilon_r = 40.2$; $\rho = 1000$ kg/m³

Phantom section: Flat Section

Measurement Standard: DASY4 (High Precision Assessment)

DASY4 Configuration:

- Probe: ES3DV2 - SN3025; ConvF(4.9, 4.9, 4.9); Calibrated: 01.03.2008
- Sensor-Surface: 3.4mm (Mechanical Surface Detection)
- Electronics: DAE4 Sn909; Calibrated: 03.09.2007
- Phantom: Flat Phantom 5.0 (front); Type: QD000P50AA ;
- Measurement SW: DASY4, V4.7 Build 55; Postprocessing SW: SEMCAD, V1.8 Build 172

Pin = 250 mW; d = 10 mm/Zoom Scan (7x7x7)/Cube 0:

Measurement grid: dx=5mm, dy=5mm, dz=5mm

Reference Value = 91.7 V/m; Power Drift = 0.013 dB

Peak SAR (extrapolated) = 19.1 W/kg

SAR(1 g) = 10.1 mW/g; SAR(10 g) = 5.2 mW/g

Maximum value of SAR (measured) = 11.8 mW/g

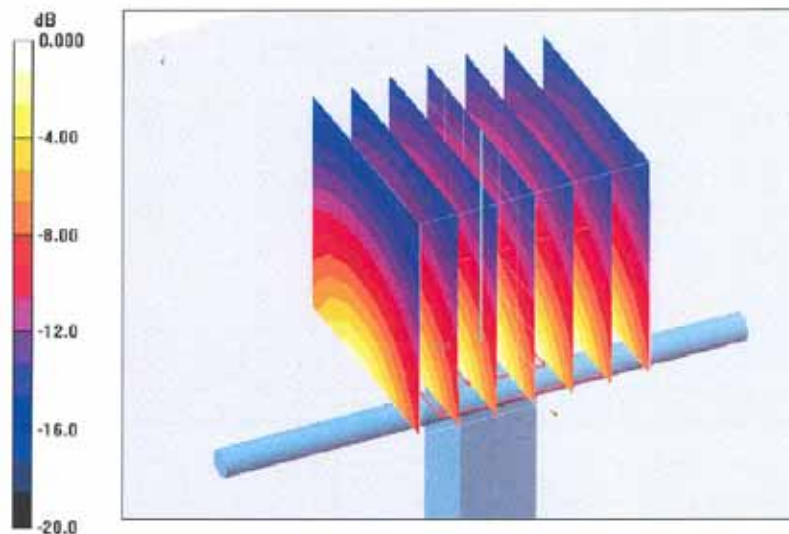

0 dB = 11.8mW/g



Impedance Measurement Plot for Head TSL

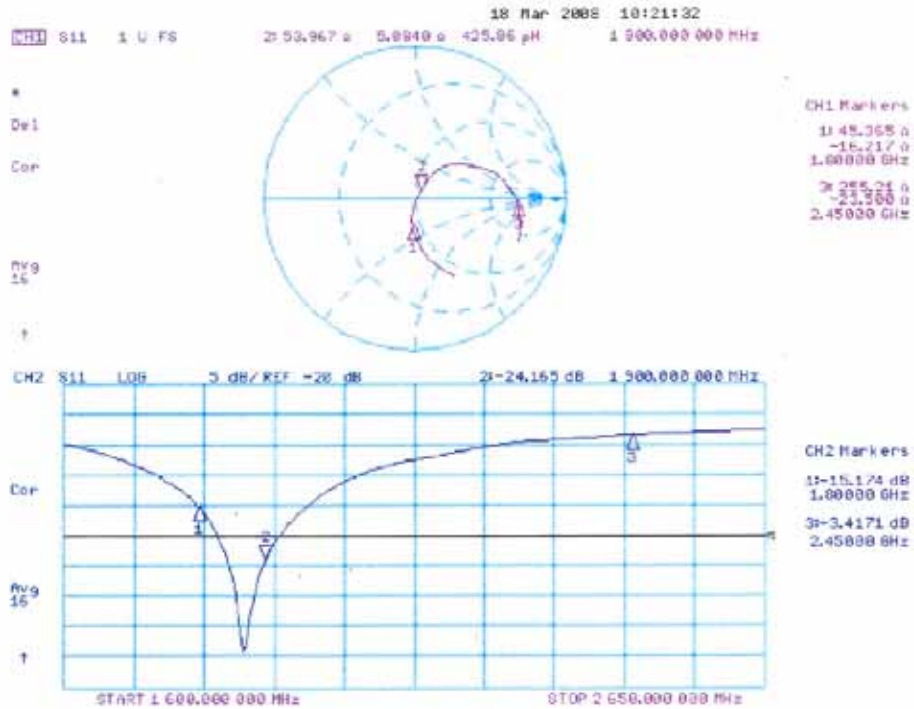

DASY4 Validation Report for Body TSL

Date/Time: 14.03.2008 13:22:24

Test Laboratory: SPEAG, Zurich, Switzerland

DUT: Dipole 1900 MHz; Type: D1900V2; Serial: D1900V2 - SN:5d041

Communication System: CW; Frequency: 1900 MHz; Duty Cycle: 1:1

Medium: MSL U10 BB;

Medium parameters used: $f = 1900$ MHz; $\sigma = 1.57$ mho/m; $\epsilon_r = 51.7$; $\rho = 1000$ kg/m³

Phantom section: Flat Section

Measurement Standard: DASY4 (High Precision Assessment)

DASY4 Configuration:

- Probe: ES3DV2 - SN3025; ConvF(4.5, 4.5, 4.5); Calibrated: 01.03.2008
- Sensor-Surface: 3.4mm (Mechanical Surface Detection)
- Electronics: DAE4 Sn909; Calibrated: 03.09.2007
- Phantom: Flat Phantom 5.0 (front); Type: QD000P50AA; ;
- Measurement SW: DASY4, V4.7 Build 55; Postprocessing SW: SEMCAD, V1.8 Build 172

Pin = 250 mW; d = 10 mm/Zoom Scan (7x7x7)/Cube 0:

Measurement grid: dx=5mm, dy=5mm, dz=5mm

Reference Value = 89.7 V/m; Power Drift = 0.004 dB

Peak SAR (extrapolated) = 18.6 W/kg

SAR(1 g) = 10.4 mW/g; SAR(10 g) = 5.44 mW/g

Maximum value of SAR (measured) = 12.0 mW/g

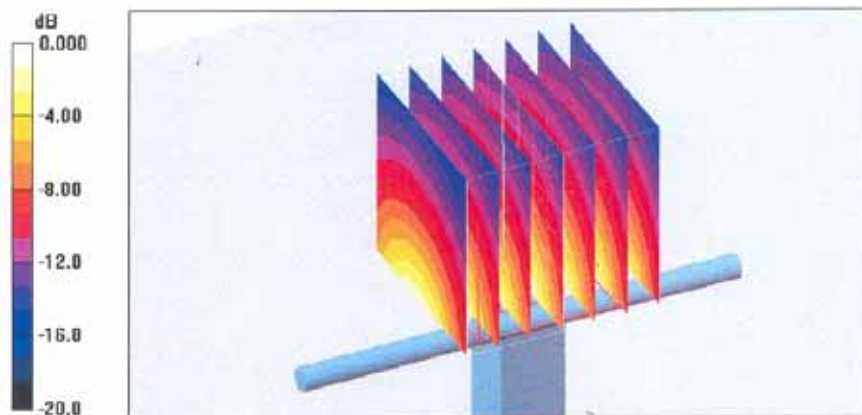

0 dB = 12.0mW/g



Impedance Measurement Plot for Body TSL

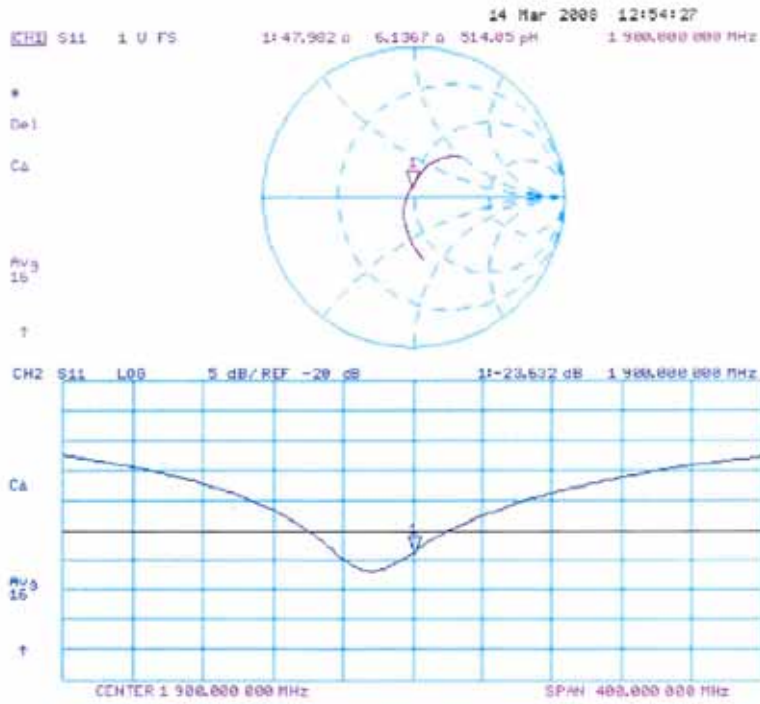



Calibration Certificate of DASY

**Calibration Laboratory of
Schmid & Partner
Engineering AG**
Zeughausstrasse 43, 8004 Zurich, Switzerland



S Schweizerischer Kalibrierdienst
S Service suisse d'étalonnage
C Servizio svizzero di taratura
S Swiss Calibration Service

Accredited by the Swiss Accreditation Service (SAS)
The Swiss Accreditation Service is one of the signatories to the EA
Multilateral Agreement for the recognition of calibration certificates

Accreditation No.: **SCS 108**

Client **Sporton (Auden)**

Certificate No: **DAE4-778_Sep08**

CALIBRATION CERTIFICATE

Object **DAE4 - SD 000 D04 BG - SN: 778**

Calibration procedure(s) **QA CAL-06.v12
Calibration procedure for the data acquisition electronics (DAE)**

Calibration date: **September 22, 2008**

Condition of the calibrated item **In Tolerance**

This calibration certificate documents the traceability to national standards, which realize the physical units of measurements (SI).
The measurements and the uncertainties with confidence probability are given on the following pages and are part of the certificate.

All calibrations have been conducted in the closed laboratory facility: environment temperature (22 ± 3)°C and humidity < 70%.

Calibration Equipment used (M&TE critical for calibration)

Primary Standards	ID #	Cal Date (Certificate No.)	Scheduled Calibration
Fluke Process Calibrator Type 702	SN: 6295803	04-Oct-07 (No: 6467)	Oct-08
Keithley Multimeter Type 2001	SN: 0810278	03-Oct-07 (No: 6465)	Oct-08
Secondary Standards	ID #	Check Date (in house)	Scheduled Check
Calibrator Box V1.1	SE UMS 006 AB 1004	06-Jun-08 (in house check)	In house check: Jun-09

	Name	Function	Signature
Calibrated by:	Andrea Guntli	Technician	
Approved by:	Fin Bornholt	R&D Director	

Issued: September 22, 2008

This calibration certificate shall not be reproduced except in full without written approval of the laboratory.



**Calibration Laboratory of
Schmid & Partner
Engineering AG**
Zeughausstrasse 43, 8004 Zurich, Switzerland



S Schweizerischer Kalibrierdienst
C Service suisse d'étalonnage
S Servizio svizzero di taratura
S Swiss Calibration Service

Accredited by the Swiss Accreditation Service (SAS)
The Swiss Accreditation Service is one of the signatories to the EA
Multilateral Agreement for the recognition of calibration certificates

Accreditation No.: **SCS 108**

Glossary

DAE data acquisition electronics
Connector angle information used in DASY system to align probe sensor X to the robot coordinate system.

Methods Applied and Interpretation of Parameters

- **DC Voltage Measurement:** Calibration Factor assessed for use in DASY system by comparison with a calibrated instrument traceable to national standards. The figure given corresponds to the full scale range of the voltmeter in the respective range.
- **Connector angle:** The angle of the connector is assessed measuring the angle mechanically by a tool inserted. Uncertainty is not required.
- The following parameters as documented in the Appendix contain technical information as a result from the performance test and require no uncertainty.
 - **DC Voltage Measurement Linearity:** Verification of the Linearity at +10% and -10% of the nominal calibration voltage. Influence of offset voltage is included in this measurement.
 - **Common mode sensitivity:** Influence of a positive or negative common mode voltage on the differential measurement.
 - **Channel separation:** Influence of a voltage on the neighbor channels not subject to an input voltage.
 - **AD Converter Values with inputs shorted:** Values on the internal AD converter corresponding to zero input voltage
 - **Input Offset Measurement:** Output voltage and statistical results over a large number of zero voltage measurements.
 - **Input Offset Current:** Typical value for information; Maximum channel input offset current, not considering the input resistance.
 - **Input resistance:** DAE input resistance at the connector, during internal auto-zeroing and during measurement.
 - **Low Battery Alarm Voltage:** Typical value for information. Below this voltage, a battery alarm signal is generated.
 - **Power consumption:** Typical value for information. Supply currents in various operating modes.



DC Voltage Measurement

A/D - Converter Resolution nominal

High Range: 1LSB = 6.1 μ V, full range = -100...+300 mV

Low Range: 1LSB = 61nV, full range = -1.....+3mV

DASY measurement parameters: Auto Zero Time: 3 sec; Measuring time: 3 sec

Calibration Factors	X	Y	Z
High Range	404.686 \pm 0.1% (k=2)	403.490 \pm 0.1% (k=2)	405.045 \pm 0.1% (k=2)
Low Range	3.99455 \pm 0.7% (k=2)	3.96369 \pm 0.7% (k=2)	3.99417 \pm 0.7% (k=2)

Connector Angle

Connector Angle to be used in DASY system	309 $^{\circ}$ \pm 1 $^{\circ}$
---	-----------------------------------



Appendix

1. DC Voltage Linearity

High Range	Input (μV)	Reading (μV)	Error (%)
Channel X + Input	200000	200000.3	0.00
Channel X + Input	20000	20004.24	0.02
Channel X - Input	20000	-20002.46	0.01
Channel Y + Input	200000	200000.4	0.00
Channel Y + Input	20000	20002.60	0.01
Channel Y - Input	20000	-20002.26	0.01
Channel Z + Input	200000	200000.6	0.00
Channel Z + Input	20000	20000.78	0.00
Channel Z - Input	20000	-20005.75	0.03

Low Range	Input (μV)	Reading (μV)	Error (%)
Channel X + Input	2000	2000	0.00
Channel X + Input	200	199.37	-0.31
Channel X - Input	200	-200.28	0.14
Channel Y + Input	2000	2000	0.00
Channel Y + Input	200	199.63	-0.19
Channel Y - Input	200	-200.88	0.44
Channel Z + Input	2000	2000.1	0.00
Channel Z + Input	200	198.60	-0.70
Channel Z - Input	200	-201.07	0.53

2. Common mode sensitivity

DASY measurement parameters: Auto Zero Time: 3 sec; Measuring time: 3 sec

	Common mode Input Voltage (mV)	High Range Average Reading (μV)	Low Range Average Reading (μV)
Channel X	200	-7.46	-6.40
	- 200	10.00	6.86
Channel Y	200	-2.73	-2.45
	- 200	0.84	0.43
Channel Z	200	-10.91	-10.94
	- 200	7.89	8.22

3. Channel separation

DASY measurement parameters: Auto Zero Time: 3 sec; Measuring time: 3 sec

	Input Voltage (mV)	Channel X (μV)	Channel Y (μV)	Channel Z (μV)
Channel X	200	-	3.08	-1.34
Channel Y	200	1.18	-	4.64
Channel Z	200	-1.74	1.44	-



4. AD-Converter Values with inputs shorted

DASY measurement parameters: Auto Zero Time: 3 sec; Measuring time: 3 sec

	High Range (LSB)	Low Range (LSB)
Channel X	16048	16021
Channel Y	16167	15166
Channel Z	16416	15977

5. Input Offset Measurement

DASY measurement parameters: Auto Zero Time: 3 sec; Measuring time: 3 sec

Input 10MΩ

	Average (μV)	min. Offset (μV)	max. Offset (μV)	Std. Deviation (μV)
Channel X	-0.13	-0.88	0.92	0.33
Channel Y	-0.88	-2.47	0.72	0.55
Channel Z	-1.16	-2.17	-0.19	0.42

6. Input Offset Current

Nominal Input circuitry offset current on all channels: <25fA

7. Input Resistance

	Zeroing (MOhm)	Measuring (MOhm)
Channel X	0.2000	201.1
Channel Y	0.2000	201.0
Channel Z	0.2001	201.7

8. Low Battery Alarm Voltage (verified during pre test)

Typical values	Alarm Level (VDC)
Supply (+ Vcc)	+7.9
Supply (- Vcc)	-7.6

9. Power Consumption (verified during pre test)

Typical values	Switched off (mA)	Stand by (mA)	Transmitting (mA)
Supply (+ Vcc)	+0.0	+6	+14
Supply (- Vcc)	-0.01	-8	-9



Calibration Laboratory of Schmid & Partner Engineering AG, Zeughausstrasse 43, 8004 Zurich, Switzerland



S Schweizerischer Kalibrierdienst, C Service suisse d'etalonnage, S Servizio svizzero di taratura, S Swiss Calibration Service

Accredited by the Swiss Accreditation Service (SA5), The Swiss Accreditation Service is one of the signatories to the EA Multilateral Agreement for the recognition of calibration certificates

Accreditation No.: SCS 108

Client Sporton (Auden)

Certificate No: ET3-1787_Aug08

CALIBRATION CERTIFICATE

Object: ET3DV6 - SN:1787, Calibration procedure(s): QA CAL-01.v6 and QA CAL-23.v3, Calibration date: August 26, 2008, Condition of the calibrated item: In Tolerance

This calibration certificate documents the traceability to national standards, which realize the physical units of measurements (SI). The measurements and the uncertainties with confidence probability are given on the following pages and are part of the certificate.

All calibrations have been conducted in the closed laboratory facility; environment temperature (22 ± 3)°C and humidity < 70%.

Calibration Equipment used (M&TE critical for calibration)

Table with 4 columns: Primary Standards, ID #, Cal Date (Certificate No.), Scheduled Calibration. Includes items like Power meter E4419B, Power sensor E4412A, Reference 3 dB Attenuator, etc.

Calibrated by: Katja Pokovic, Technical Manager; Approved by: Niels Kuster, Quality Manager. Includes signatures.

Issued: August 26, 2008

This calibration certificate shall not be reproduced except in full without written approval of the laboratory.



Calibration Laboratory of
Schmid & Partner
Engineering AG
Zeughausstrasse 43, 8004 Zurich, Switzerland



S Schweizerischer Kalibrierdienst
C Service suisse d'étalonnage
S Servizio svizzero di taratura
S Swiss Calibration Service

Accredited by the Swiss Accreditation Service (SAS)
The Swiss Accreditation Service is one of the signatories to the EA
Multilateral Agreement for the recognition of calibration certificates

Accreditation No.: SCS 108

Glossary:

TSL	tissue simulating liquid
NORM _{x,y,z}	sensitivity in free space
ConvF	sensitivity in TSL / NORM _{x,y,z}
DCP	diode compression point
Polarization φ	φ rotation around probe axis
Polarization ϑ	ϑ rotation around an axis that is in the plane normal to probe axis (at measurement center), i.e., $\vartheta = 0$ is normal to probe axis

Calibration is Performed According to the Following Standards:

- a) IEEE Std 1528-2003, "IEEE Recommended Practice for Determining the Peak Spatial-Averaged Specific Absorption Rate (SAR) in the Human Head from Wireless Communications Devices: Measurement Techniques", December 2003
- b) IEC 62209-1, "Procedure to measure the Specific Absorption Rate (SAR) for hand-held devices used in close proximity to the ear (frequency range of 300 MHz to 3 GHz)", February 2005

Methods Applied and Interpretation of Parameters:

- **NORM_{x,y,z}:** Assessed for E-field polarization $\vartheta = 0$ ($f \leq 900$ MHz in TEM-cell; $f > 1800$ MHz: R22 waveguide). NORM_{x,y,z} are only intermediate values, i.e., the uncertainties of NORM_{x,y,z} does not effect the E²-field uncertainty inside TSL (see below ConvF).
- **NORM(f)_{x,y,z} = NORM_{x,y,z} * frequency_response** (see Frequency Response Chart). This linearization is implemented in DASY4 software versions later than 4.2. The uncertainty of the frequency response is included in the stated uncertainty of ConvF.
- **DCP_{x,y,z}:** DCP are numerical linearization parameters assessed based on the data of power sweep (no uncertainty required). DCP does not depend on frequency nor media.
- **ConvF and Boundary Effect Parameters:** Assessed in flat phantom using E-field (or Temperature Transfer Standard for $f \leq 800$ MHz) and inside waveguide using analytical field distributions based on power measurements for $f > 800$ MHz. The same setups are used for assessment of the parameters applied for boundary compensation (alpha, depth) of which typical uncertainty values are given. These parameters are used in DASY4 software to improve probe accuracy close to the boundary. The sensitivity in TSL corresponds to NORM_{x,y,z} * ConvF whereby the uncertainty corresponds to that given for ConvF. A frequency dependent ConvF is used in DASY version 4.4 and higher which allows extending the validity from ± 50 MHz to ± 100 MHz.
- **Spherical isotropy (3D deviation from isotropy):** in a field of low gradients realized using a flat phantom exposed by a patch antenna.
- **Sensor Offset:** The sensor offset corresponds to the offset of virtual measurement center from the probe tip (on probe axis). No tolerance required.



ET3DV6 SN:1787

August 26, 2008

Probe ET3DV6

SN:1787

Manufactured:	May 28, 2003
Last calibrated:	August 28, 2007
Recalibrated:	August 26, 2008

Calibrated for DASY Systems

(Note: non-compatible with DASY2 system!)



ET3DV6 SN:1787

August 26, 2008

DASY - Parameters of Probe: ET3DV6 SN:1787

Sensitivity in Free Space^A

Diode Compression^B

NormX	1.63 ± 10.1%	μV/(V/m) ²	DCP X	90 mV
NormY	1.67 ± 10.1%	μV/(V/m) ²	DCP Y	93 mV
NormZ	2.18 ± 10.1%	μV/(V/m) ²	DCP Z	92 mV

Sensitivity in Tissue Simulating Liquid (Conversion Factors)

Please see Page 8.

Boundary Effect

TSL 900 MHz Typical SAR gradient: 5 % per mm

Sensor Center to Phantom Surface Distance		3.7 mm	4.7 mm
SAR _{ce} [%]	Without Correction Algorithm	11.3	7.5
SAR _{ce} [%]	With Correction Algorithm	0.8	0.5

TSL 1750 MHz Typical SAR gradient: 10 % per mm

Sensor Center to Phantom Surface Distance		3.7 mm	4.7 mm
SAR _{ce} [%]	Without Correction Algorithm	10.1	6.5
SAR _{ce} [%]	With Correction Algorithm	0.8	0.6

Sensor Offset

Probe Tip to Sensor Center 2.7 mm

The reported uncertainty of measurement is stated as the standard uncertainty of measurement multiplied by the coverage factor k=2, which for a normal distribution corresponds to a coverage probability of approximately 95%.

^A The uncertainties of NormX,Y,Z do not affect the E²-field uncertainty inside TSL (see Page 8).

^B Numerical linearization parameter: uncertainty not required.



ET3DV6 SN:1787

August 26, 2008

Frequency Response of E-Field

(TEM-Cell:ifi110 EXX, Waveguide: R22)

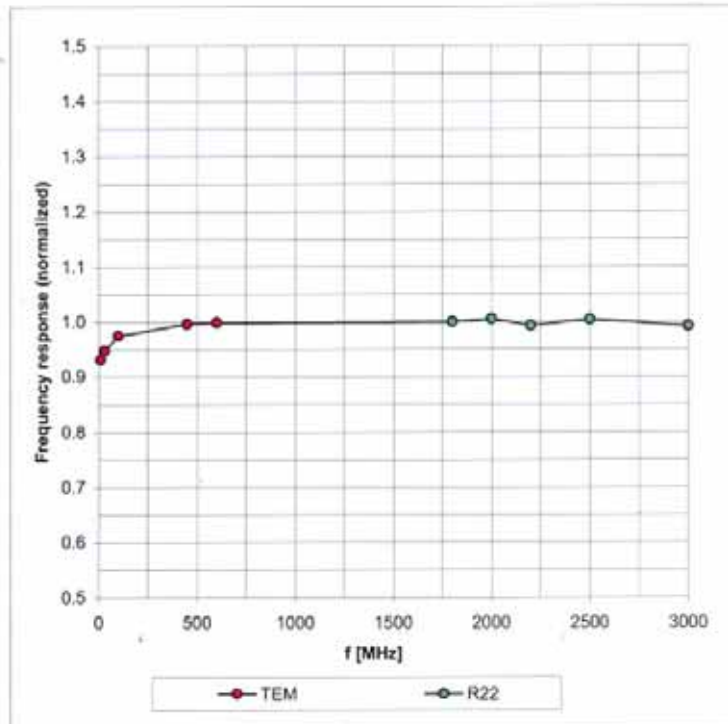

Uncertainty of Frequency Response of E-field: $\pm 6.3\%$ (k=2)



ET3DV6 SN:1787

August 26, 2008

Receiving Pattern (ϕ), $\vartheta = 0^\circ$

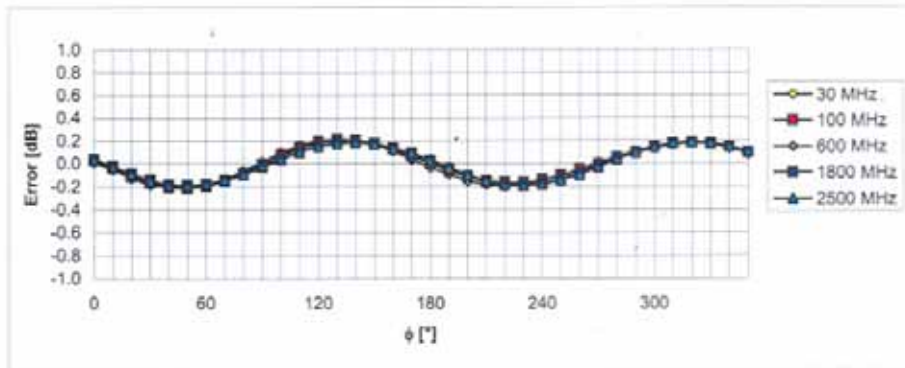
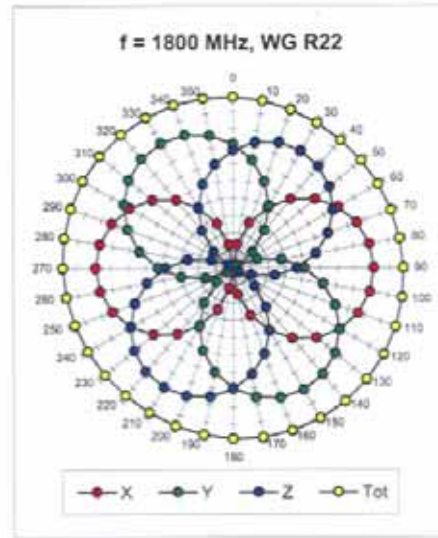
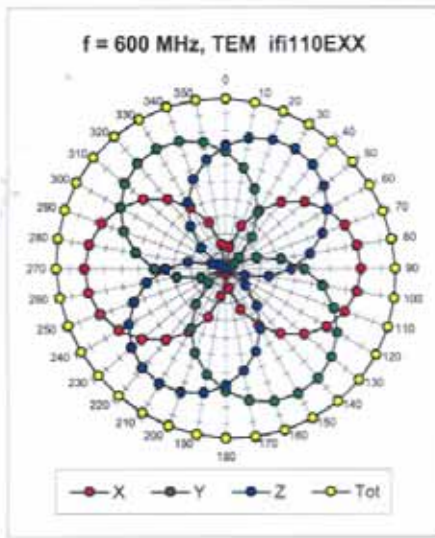

Uncertainty of Axial Isotropy Assessment: $\pm 0.5\%$ ($k=2$)



ET3DV6 SN:1787

August 26, 2008

Dynamic Range $f(\text{SAR}_{\text{head}})$ (Waveguide R22, $f = 1800 \text{ MHz}$)

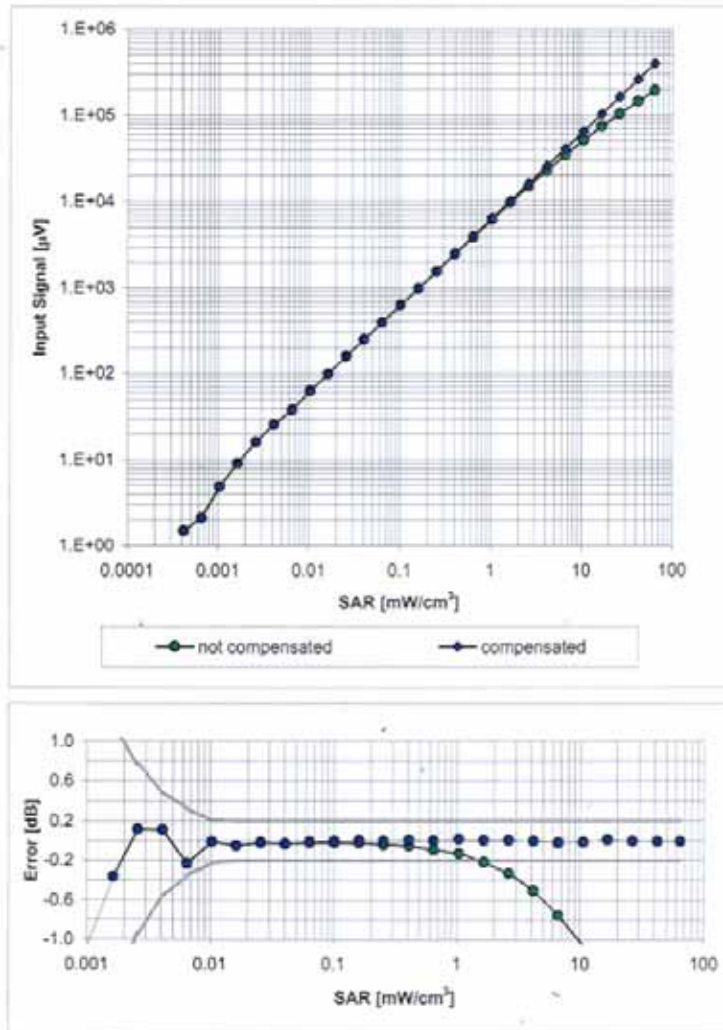

Uncertainty of Linearity Assessment: $\pm 0.6\%$ ($k=2$)

ET3DV6 SN:1787

August 26, 2008

Conversion Factor Assessment

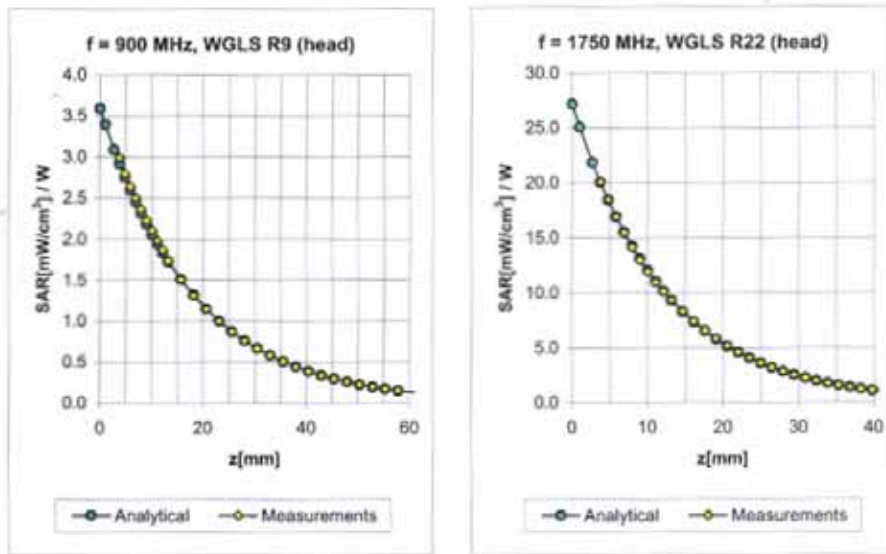

f [MHz]	Validity [MHz] ^c	TSL	Permittivity	Conductivity	Alpha	Depth	ConvF Uncertainty
900	± 50 / ± 100	Head	41.5 ± 5%	0.97 ± 5%	0.30	2.80	6.06 ± 11.0% (k=2)
1750	± 50 / ± 100	Head	40.1 ± 5%	1.37 ± 5%	0.53	2.11	5.36 ± 11.0% (k=2)
1950	± 50 / ± 100	Head	40.0 ± 5%	1.40 ± 5%	0.59	1.96	5.01 ± 11.0% (k=2)
2450	± 50 / ± 100	Head	39.2 ± 5%	1.80 ± 5%	0.77	1.57	4.49 ± 11.0% (k=2)
900	± 50 / ± 100	Body	55.0 ± 5%	1.05 ± 5%	0.31	2.98	5.91 ± 11.0% (k=2)
1750	± 50 / ± 100	Body	53.4 ± 5%	1.49 ± 5%	0.60	2.20	4.73 ± 11.0% (k=2)
1950	± 50 / ± 100	Body	53.3 ± 5%	1.52 ± 5%	0.68	1.95	4.49 ± 11.0% (k=2)
2450	± 50 / ± 100	Body	52.7 ± 5%	1.95 ± 5%	0.90	1.51	3.79 ± 11.0% (k=2)

^c The validity of ± 100 MHz only applies for DASY v4.4 and higher (see Page 2). The uncertainty is the RSS of the ConvF uncertainty at calibration frequency and the uncertainty for the indicated frequency band.



ET3DV6 SN:1787

August 26, 2008

Deviation from Isotropy in HSL

Error (ϕ , θ), $f = 900$ MHz

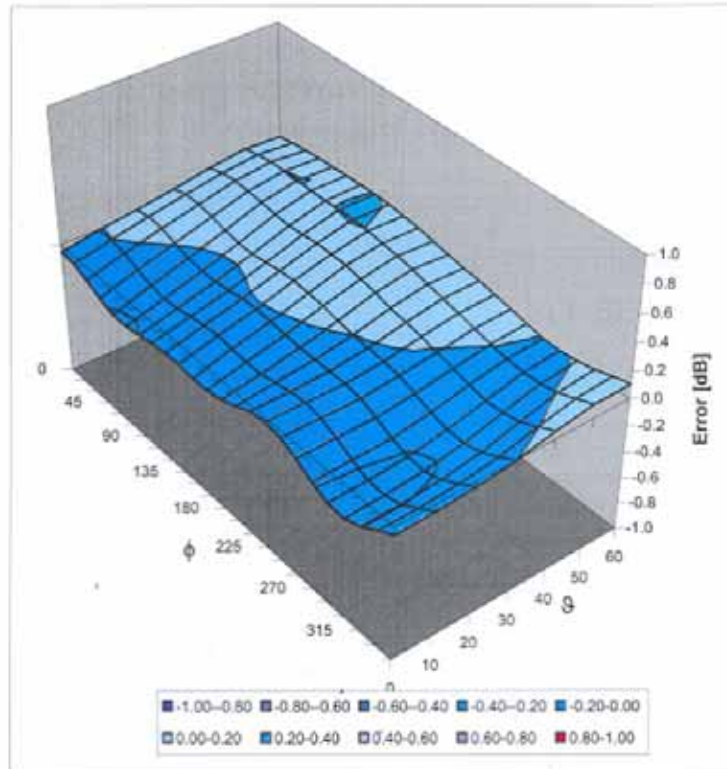

Uncertainty of Spherical Isotropy Assessment: $\pm 2.6\%$ ($k=2$)

Appendix D - Product Photos

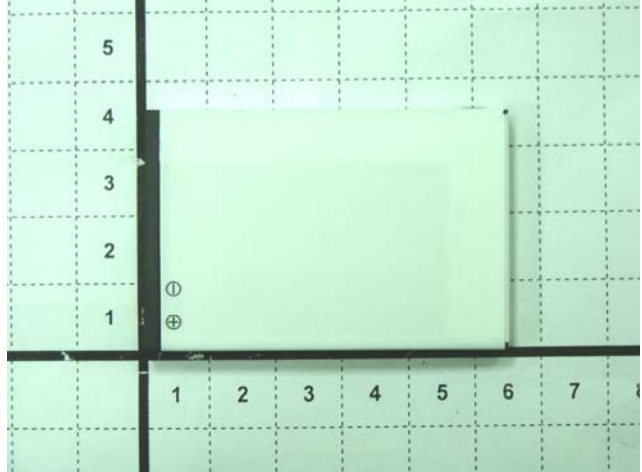

Appendix E - Test Setup Photos

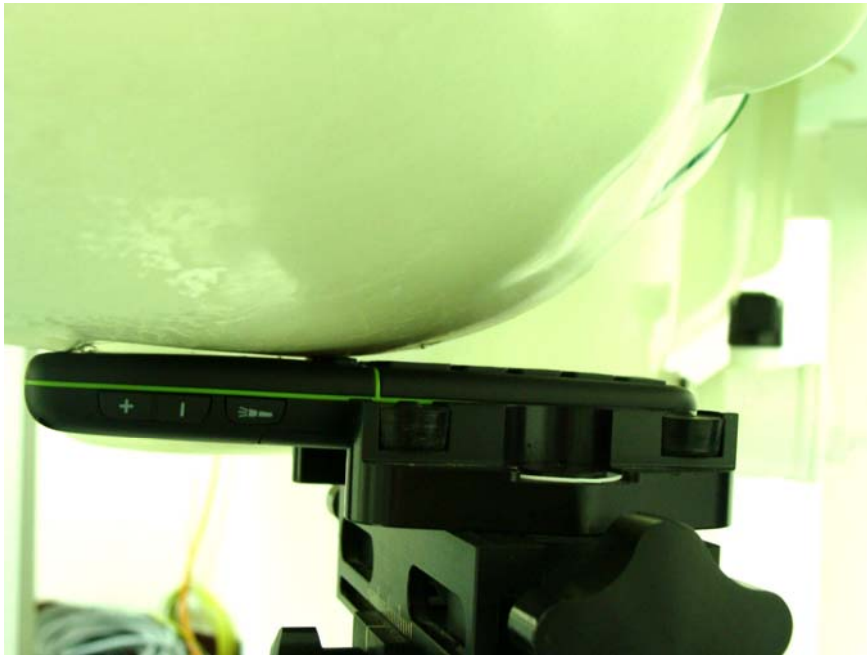

Right Cheek

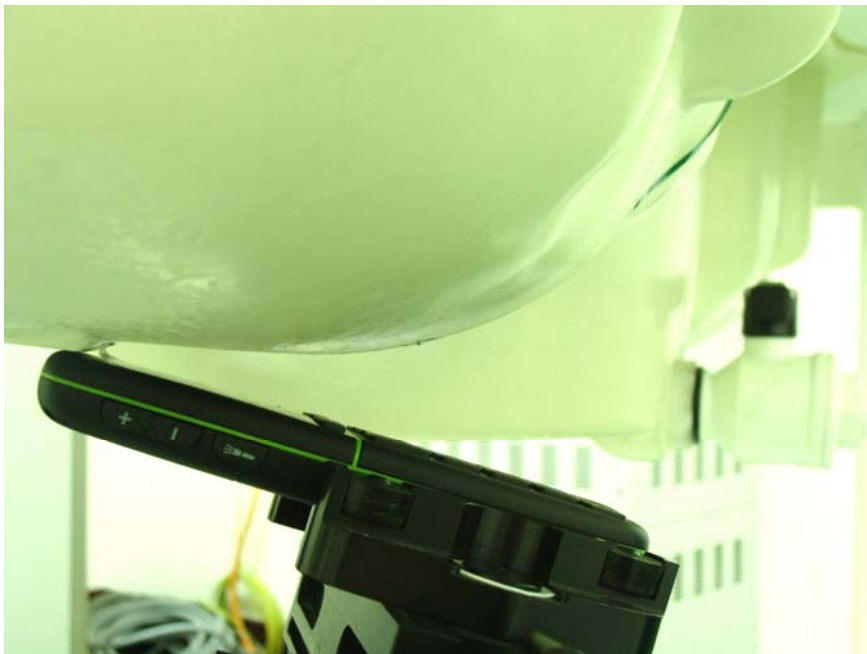

Right Tilted

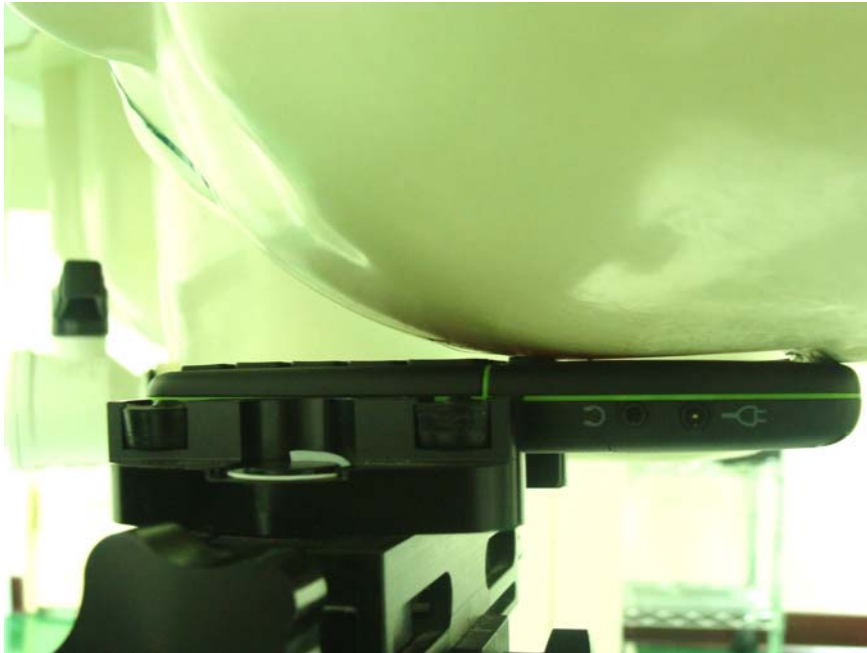

Left Cheek

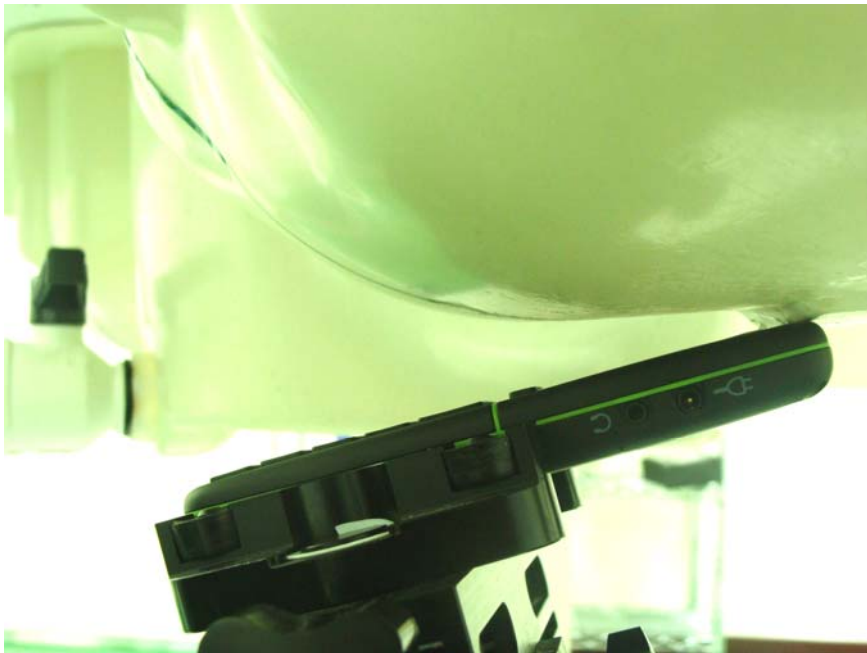

Left Tilted

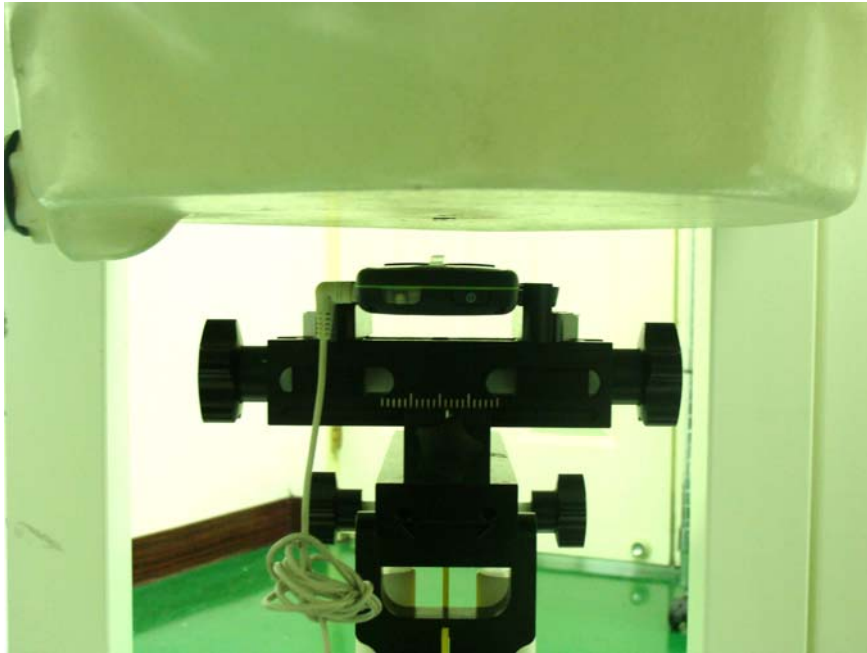

Face with 1.5cm Gap

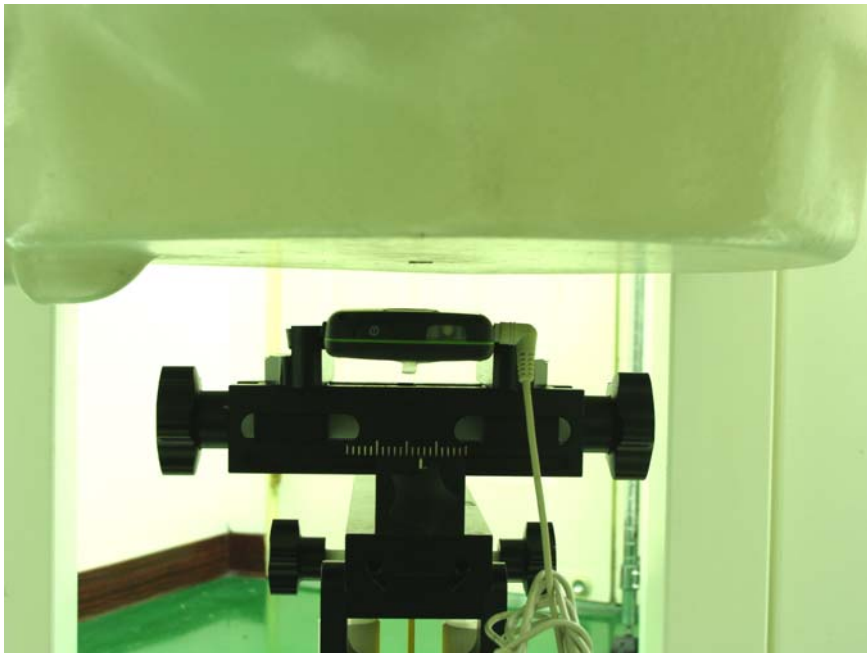

Bottom with 1.5cm Gap