



RF TEST REPORT

Applicant Doro AB
FCC ID WS5DFC0270
Product 4G Clamshell Smart Feature Phone
Brand Doro
Model DFC-0270
Report No. R2103A0299-R1V1
Issue Date July 7, 2021

TA Technology (Shanghai) Co., Ltd. tested the above equipment in accordance with the requirements in **FCC CFR47 Part 2 (2020)/ FCC CFR 47 Part 24E (2020)**. The test results show that the equipment tested is capable of demonstrating compliance with the requirements as documented in this report.

Prepared by: Peng Tao

Approved by: Kai Xu

TA Technology (Shanghai) Co., Ltd.

No.145, Jintang Rd, Tangzhen Industry Park, Pudong Shanghai, China

TEL: +86-021-50791141/2/3

FAX: +86-021-50791141/2/3-8000



TABLE OF CONTENT

1. Test Laboratory	5
1.1. Notes of the test report.....	5
1.2. Test facility.....	5
1.3. Testing Location	5
2. General Description of Equipment under Test.....	6
3. Applied Standards.....	8
4. Test Configuration.....	9
5. Test Case Results.....	10
5.1. RF Power Output.....	10
5.2. Effective Isotropic Radiated Power	12
5.3. Occupied Bandwidth	15
5.4. Band Edge Compliance.....	19
5.5. Peak-to-Average Power Ratio (PAPR)	22
5.6. Frequency Stability	24
5.7. Spurious Emissions at Antenna Terminals	27
5.8. Radiates Spurious Emission	34
6. Main Test Instruments	40
ANNEX A: The EUT Appearance	41
ANNEX B: Test Setup Photos	42
ANNEX C: Product Change Description	43



Version	Revision description	Issue Date
Rev.0	Initial issue of report.	June 15, 2021
Rev.1	Update standard	July 7, 2021

Note: This revised report (Report No. R2103A0299-R1V1) supersedes and replaces the previously issued report (Report No. R2103A0299-R1). Please discard or destroy the previously issued report and dispose of it accordingly.



Summary of measurement results

No.	Test Case	Clause in FCC rules	Verdict
1	RF power output	2.1046	PASS
2	Effective Isotropic Radiated power	24.232(c)	PASS
3	Occupied Bandwidth	2.1049	PASS
4	Band Edge Compliance	2.1051 /24.238(a)	PASS
5	Peak-to-Average Power Ratio	24.232/KDB 971168 D01(5.7)	PASS
6	Frequency Stability	2.1055 / 24.235	PASS
7	Spurious Emissions at Antenna Terminals	2.1051 / 24.238(a)	PASS
8	Radiates Spurious Emission	2.1053 / 24.238(a)	PASS
Date of Testing: June 4, 2019~ June 17, 2019			
Note: All indications of Pass/Fail in this report are opinions expressed by TA Technology (Shanghai) Co., Ltd. based on interpretations and/or observations of test results. Measurement Uncertainties were not taken into account and are published for informational purposes only.			

This report is only used for changes software version and Hardware Version code, no change in product. After laboratory evaluation, the report does not required adding any test and the original report number is R2008A0539-R1.

The detailed product change description please refers to the Product Change Description

DFC-0270 (Report No.: R2008A0539-R1) is a variant model of DFC-0270 (Report No.: R1905A0242-R1). Test values duplicated from Original for variant. There is no test for variant in this report. The detailed product change description please refers to the *Product Change Description_Variant*.



1. Test Laboratory

1.1. Notes of the test report

This report shall not be reproduced in full or partial, without the written approval of **TA technology (shanghai) co., Ltd.** The results documented in this report apply only to the tested sample, under the conditions and modes of operation as described herein. Measurement Uncertainties were not taken into account and are published for informational purposes only. This report is written to support regulatory compliance of the applicable standards stated above.

1.2. Test facility

FCC (Designation number: CN1179, Test Firm Registration Number: 446626)

TA Technology (Shanghai) Co., Ltd. has been listed on the US Federal Communications Commission list of test facilities recognized to perform electromagnetic emissions measurements.

A2LA (Certificate Number: 3857.01)

TA Technology (Shanghai) Co., Ltd. has been listed by American Association for Laboratory Accreditation to perform electromagnetic emission measurement.

1.3. Testing Location

Company: TA Technology (Shanghai) Co., Ltd.
Address: No.145, Jintang Rd, Tangzhen Industry Park, Pudong
City: Shanghai
Post code: 201201
Country: P. R. China
Contact: Xu Kai
Telephone: +86-021-50791141/2/3
Fax: +86-021-50791141/2/3-8000
Website: <http://www.ta-shanghai.com>
E-mail: xukai@ta-shanghai.com

2. General Description of Equipment under Test

Client Information

Applicant	Doro AB
Applicant address	Jörgen Kocksgatan 1B, SE 211 20 MALMÖ, SWEDEN
Manufacturer	Doro AB
Manufacturer address	Jörgen Kocksgatan 1B, SE 211 20 MALMÖ, SWEDEN

General information

EUT Description			
Model	DFC-0270		
IMEI	Original	IMEI 1:356755100011328	
		IMEI 2:356755100011336	
Hardware Version	V01C(HW code: 5011/5061/5071/5081/5091/5101)		
Software Version	DFC0270_VF292_N_S01A_V18_M210325_CE		
Power Supply	Battery/AC adapter		
Antenna Type	Internal Antenna		
Antenna Gain	1dBi		
Test Mode(s)	GSM1900; WCDMA Band II;		
Test Modulation	(GSM)GMSK,8PSK; (WCDMA) BPSK, QPSK,16QAM;		
GPRS Multislot Class	12		
EGPRS Multislot Class	12		
HSDPA UE Category	14		
HSUPA UE Category	7		
DC-HSDPA UE Category	24		
Maximum E.I.R.P	GSM 1900:	30.69dBm	
	WCDMA Band II:	23.93dBm	
Rated Power Supply Voltage	3.8V		
Extreme Voltage	Minimum: 3.6V Maximum: 4.35V		
Extreme Temperature	Lowest: -10°C Highest: +55°C		
Operating Frequency Range(s)	Band	Tx (MHz)	Rx (MHz)
	GSM1900	1850 ~ 1910	1930 ~ 1990
	WCDMA Band II	1850 ~ 1910	1930 ~ 1990
EUT Accessory			
Adapter 1	Manufacturer: TEN PAO INDUSTRIAL CO.,LTD Model: S003ATB0500055 (Halogen free)		
Adapter 2	Manufacturer: Dongguan Aohai Power Technology CO.,LTD Model: A31A-050055U-EU1(Halogen free)		
Adapter 3	Manufacturer: Dongguan Aohai Power Technology CO.,LTD Model: A806A-050100U-UK1(Halogen free)		



Adapter 4	Manufacturer: Dongguan Aohai Power Technology CO.,LTD Model: A2-501000(Halogen free)
Adapter 5	Manufacturer: Shenzhen BaiJunDa ELECTRONIC CO.,Ltd Model: UT-133E-5100
Adapter 6	Manufacturer: Mobewire Mobiles (Ningbo) Co.,Ltd Model: DFC-0240/0270 (Halogen free)
Battery 1	Manufacturer: NINGBO VEKEN BATTERY CO., LTD Model: DBX-1350A
Battery 2	Manufacturer: ZhongshanTianmao Battery Co., Ltd Model: DBX-1350B
Earphone 1	Manufacturer: Shenzhen Juwei Electronics Co.,Ltd Model: JWEP0944-M01R (Halogen free)
Earphone 2	Manufacturer: Shenzhen Juwei Electronics Co.,Ltd Model: JWEP0782-M01 (Halogen free)
USB Cable	Manufacturer: SHENZHEN FKY-QY HARDWARE ELECTRONIC CO.,LTD Model: M039B0800150 (Halogen free)
<p>Note: 1. The EUT is sent from the applicant to TA and the information of the EUT is declared by the applicant.</p> <p>2. There are more than one Adapter, Battery and Earphone, each one should be applied throughout the compliance test respectively, however, only the worst case (Adapter4,Battery1, Earphone1) will be recorded in this report.</p>	

HW code	Chipset	2.8 LCD	Flash	Rear CAM
5011	MT6731	Sanlong IC7789V2	Nanya (NE1484KALAXA7-MD)	GC2385
5061	MT8765B	Sanlong IC7789V2	Nanya (NE1484KALAXA7-MD)	02M2
5071	MT6731	Sanlong IC7789V2	Nanya (NE1484KALAXA7-MD)	02M2
5081	MT8765B	Sanlong IC7789V3	Nanya (NE1484KALAXA7-MD)	02M2
5091	MT6731	Sanlong IC7789V3	Nanya (NE1484KALAXA7-MD)	02M2
5101	MT8765B	Digital IC GC9306	Nanya (NE1484KALAXA7-MD)	02M2

3. Applied Standards

According to the specifications of the manufacturer, it must comply with the requirements of the following standards:

Test standards:

FCC CFR 47 Part 24E (2020)

ANSI C63.26 (2015)

Reference standard:

FCC CFR47 Part 2 (2020)

KDB 971168 D01 Power Meas License Digital Systems v03r01

4. Test Configuration

Radiated measurements are performed by rotating the EUT in three different orthogonal test planes. EUT stand-up position (Z axis), lie-down position (X, Y axis). Receiver antenna polarization (horizontal and vertical), the worst emission was found in position (X axis, vertical polarization) and the worst case was recorded.

All mode and data rates and positions and RB size and modulations were investigated.

Subsequently, only the worst case emissions are reported.

The following testing in GSM/WCDMA is set based on the maximum RF Output Power.

Test modes are chosen to be reported as the worst case configuration below:

Test items	Modes/Modulation	
	GSM 1900	WCDMA Band II
RF power output	GSM GPRS EGPRS	RMC HSDPA/HSUPA DC-HSDPA
Effective Isotropic Radiated power	GSM GPRS(1Tx slot) EGPRS(1Tx slot)	RMC
Occupied Bandwidth	GSM GPRS(1Tx slot) EGPRS(1Tx slot)	RMC
Band Edge Compliance	GSM GPRS(1Tx slot) EGPRS(1Tx slot)	RMC
Peak-to-Average Power Ratio	GSM GPRS(1Tx slot) EGPRS(1Tx slot)	RMC
Frequency Stability	GSM GPRS(1Tx slot) EGPRS(1Tx slot)	RMC
Spurious Emissions at Antenna Terminals	GSM	RMC
Radiates Spurious Emission	GSM	RMC

5. Test Case Results

5.1. RF Power Output

Ambient condition

Temperature	Relative humidity	Pressure
23°C ~25°C	45%~50%	101.5kPa

Methods of Measurement

During the process of the testing, The EUT is controlled by the Base Station Simulator to ensure max power transmission and proper modulation.

Test Setup

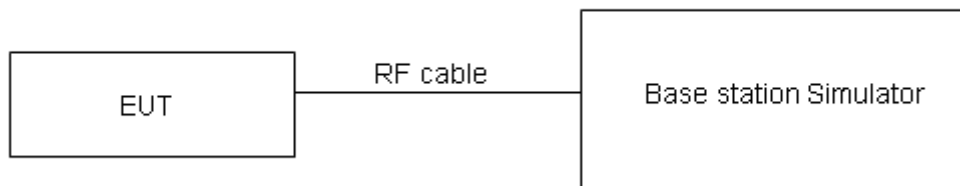

The loss between RF output port of the EUT and the input port of the tester has been taken into consideration.

Limits

No specific RF power output requirements in part 2.1046.

Measurement Uncertainty

The assessed measurement uncertainty to ensure 95% confidence level for the normal distribution is with the coverage factor $k = 2$, $U = 0.4$ dB.

Test Results
Original

GSM 1900		Conducted Power(dBm)		
		Channel 512	Channel 661	Channel 810
		1850.2(MHz)	1880(MHz)	1909.8(MHz)
GSM	Results	28.93	28.76	28.77
GPRS/EGPRS (GMSK)	1TXslot	28.90	28.73	28.76
	2TXslots	28.24	28.07	28.10
	3TXslots	26.61	26.43	26.47
	4TXslots	25.59	25.39	25.46
EGPRS (8PSK)	1TXslot	26.11	26.18	26.28
	2TXslots	24.87	24.93	25.02
	3TXslots	22.51	22.48	22.59
	4TXslots	21.67	21.79	21.61

WCDMA Band II		Conducted Power(dBm)		
		Channel 9262	Channel 9400	Channel 9538
		1852.4(MHz)	1880(MHz)	1907.6(MHz)
RMC		22.31	22.33	22.43
HSDPA	Sub - Test 1	21.77	21.75	21.87
	Sub - Test 2	21.76	21.77	21.84
	Sub - Test 3	21.23	21.27	21.36
	Sub - Test 4	21.24	21.28	21.34
HSUPA	Sub - Test 1	21.73	21.74	21.82
	Sub - Test 2	20.72	20.72	20.81
	Sub - Test 3	21.19	21.20	21.30
	Sub - Test 4	20.65	20.69	20.78
	Sub - Test 5	21.66	21.67	21.76
DC-HSDPA	Sub - Test 1	21.65	21.69	21.77
	Sub - Test 2	21.64	21.68	21.76
	Sub - Test 3	21.22	21.17	21.27
	Sub - Test 4	21.21	21.16	21.26

5.2. Effective Isotropic Radiated Power

Ambient condition

Temperature	Relative humidity	Pressure
23°C ~25°C	45%~50%	101.5kPa

Methods of Measurement

The testing follows FCC KDB 971168 v03r01 Section 5.8 and ANSI C63.26 (2015).

- a) Connect the equipment as illustrated. Mount the equipment with the manufacturer specified antenna in a vertical orientation on a manufacturer specified mounting surface located on a non-conducting rotating platform of a RF anechoic chamber (preferred) or a standard radiation site.
- b) Key the transmitter, then rotate the EUT 360° azimuthally and record spectrum analyzer power level (LVL) measurements at angular increments that are sufficiently small to permit resolution of all peaks. If a standard radiation test site is used, raise and lower the test antenna to obtain a maximum reading at each angular increment. (Note: several batteries may be needed to offset the effect of battery voltage droop, which should not exceed 5% of the manufactured specified battery voltage during transmission).
- c) Replace the transmitter under test with a vertically polarized half-wave dipole (or an antenna whose gain is known relative to an ideal half-wave dipole). The center of the antenna should be at the same location as the center of the antenna under test.
- d) Connect the antenna to a signal generator with a known output power and record the path loss (in dB) as LOSS. If a standard radiation test site is used, raise and lower the test antenna to obtain a maximum reading. $LOSS = \text{Generator Output Power (dBm)} - \text{Analyzer reading (dBm)}$
- e) Determine the effective radiated output power at each angular position from the readings in steps b) and d) using the following equation: $ERP \text{ (dBm)} = \text{LVL (dBm)} + \text{LOSS (dB)}$
- f) The maximum ERP is the maximum value determined in the preceding step.
- g) When calculating ERP, in addition to knowing the antenna radiation and matching characteristics, it is necessary to know the loss values of all elements (e.g. transmission line attenuation, mismatches, filters, combiners) interposed between the point where transmitter output power is measured, and the point where power is applied to the antenna. ERP can then be calculated as follows:
 $EIRP \text{ (dBm)} = \text{Output Power (dBm)} - \text{Losses (dB)} + \text{Antenna Gain (dBi)}$
where: dBd refers to gain relative to an ideal dipole.
 $EIRP \text{ (dBm)} = ERP \text{ (dBm)} + 2.15 \text{ (dB.)}$

The RB allocation refers to section 5.1, using the maximum output power configuration.

Test setup

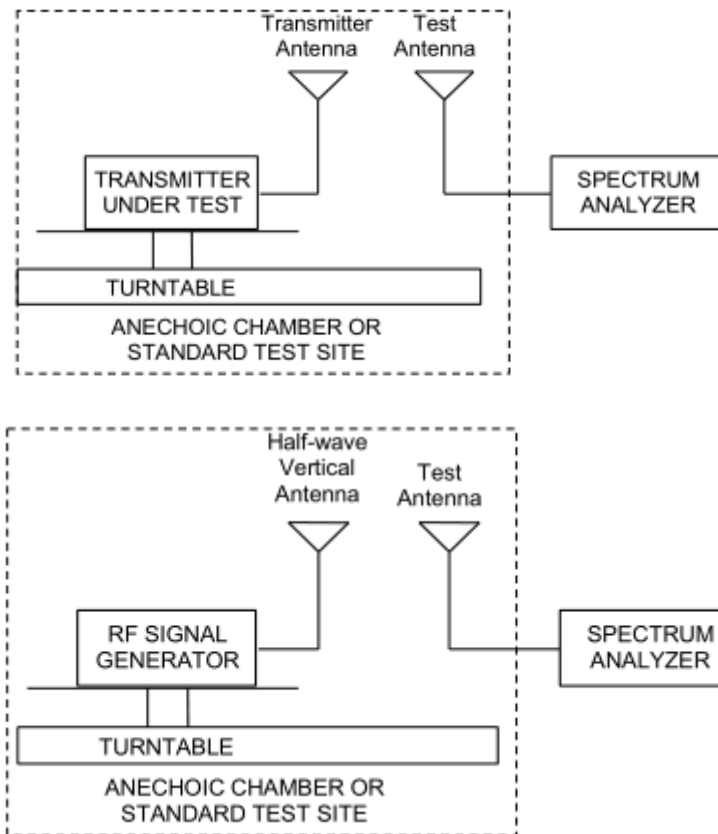

Limits

Rule Part 24.232(c) Mobile and portable stations are limited to 2 watts EIRP.

Rule Part 24.232(e) Peak transmit power must be measured over any interval of continuous transmission using instrumentation calibrated in terms of an rms-equivalent voltage.

Limit	$\leq 2\text{ W}$ (33 dBm)
-------	----------------------------

Measurement Uncertainty

The assessed measurement uncertainty to ensure 95% confidence level for the normal distribution is with the coverage factor $k = 2$, $U = 1.19\text{ dB}$

Test Results:

The measurement is performed for both of horizontal and vertical antenna Polarization, and only the data of worst mode is recorded in this report.

Original

Mode	Channel	Frequency (MHz)	Polarization	EIRP (dBm)	Limit (dBm)	Conclusion
GSM 1900	Low	1850.2	Horizontal	30.30	33	Pass
	Mid	1880	Horizontal	30.36	33	Pass
	High	1909.8	Horizontal	30.69	33	Pass
GPRS 1900	Low	1850.2	Horizontal	29.25	33	Pass
	Mid	1880	Horizontal	29.18	33	Pass
	High	1909.8	Horizontal	29.36	33	Pass
EGPRS 1900	Low	1850.2	Horizontal	27.18	33	Pass
	Mid	1880	Horizontal	27.23	33	Pass
	High	1909.8	Horizontal	27.32	33	Pass
WCDMA Band II	Low	1852.4	Horizontal	23.93	33	Pass
	Mid	1880	Horizontal	23.87	33	Pass
	High	1907.6	Horizontal	23.39	33	Pass

5.3.Occupied Bandwidth

Ambient condition

Temperature	Relative humidity	Pressure
23°C ~25°C	45%~50%	101.5kPa

Method of Measurement

The EUT was connected to Spectrum Analyzer and Base Station Simulator via power Splitter. The occupied bandwidth is measured using spectrum analyzer.

RBW is set to 3kHz, VBW is set to 10kHz for GSM 1900,

RBW is set to 51kHz, VBW is set to 160kHz for WCDMA Band II,

99% power and -26dBc occupied bandwidths are recorded. Spectrum analyzer plots are included on the following pages.

Test Setup

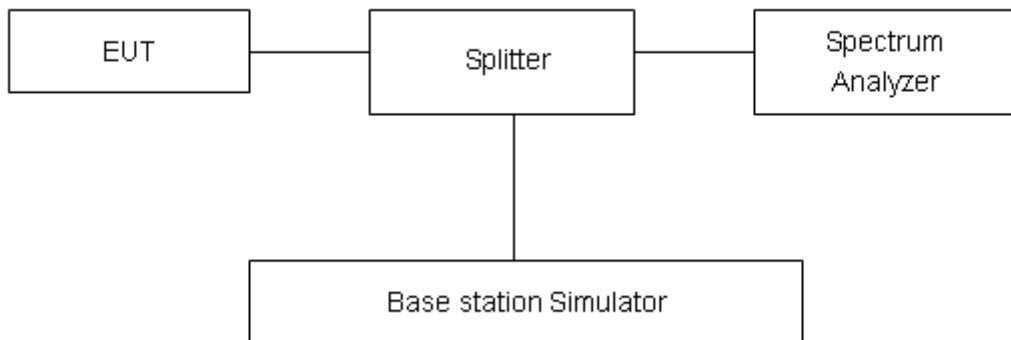

Limits

No specific occupied bandwidth requirements in part 2.1049.

Measurement Uncertainty

The assessed measurement uncertainty to ensure 95% confidence level for the normal distribution is with the coverage factor $k = 2$, $U = 624\text{Hz}$.

Test Result**Original**

Mode	Channel	Frequency (MHz)	99% Power Bandwidth (MHz)	-26dBc Bandwidth(MHz)
GSM 1900 (GSM)	512	1850.2	0.249	0.313
	661	1880.0	0.244	0.314
	810	1909.8	0.249	0.303
GPRS 1900 (GMSK)	512	1850.2	0.247	0.310
	661	1880.0	0.247	0.316
	810	1909.8	0.246	0.315
EGPRS 1900 (8-PSK)	512	1850.2	0.244	0.314
	661	1880.0	0.246	0.318
	810	1909.8	0.248	0.306
WCDMA Band II (RMC)	9262	1852.4	4.1674	4.665
	9400	1880	4.1720	4.700
	9538	1907.6	4.1597	4.675

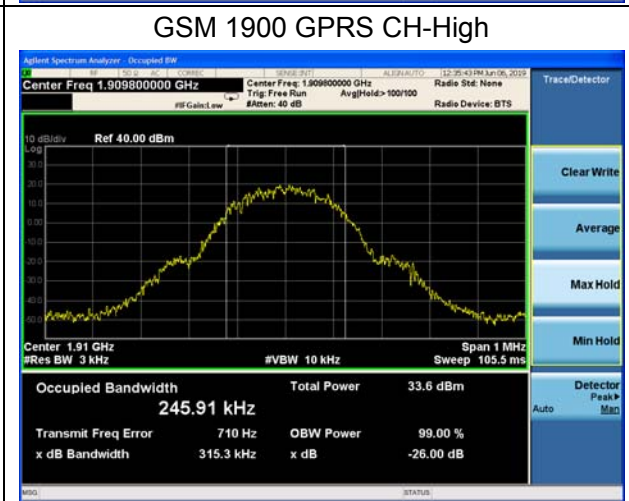
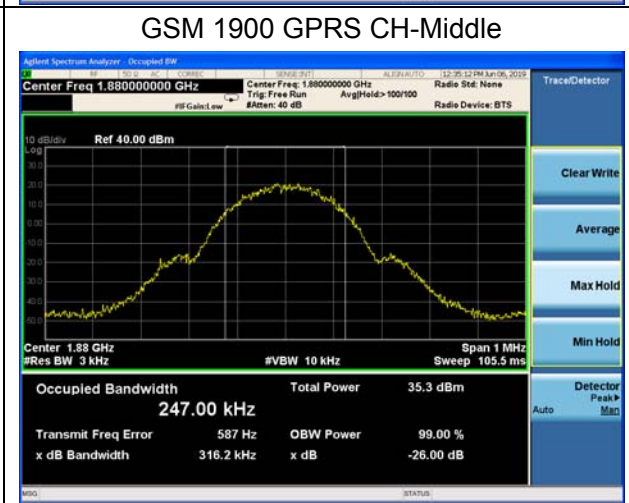
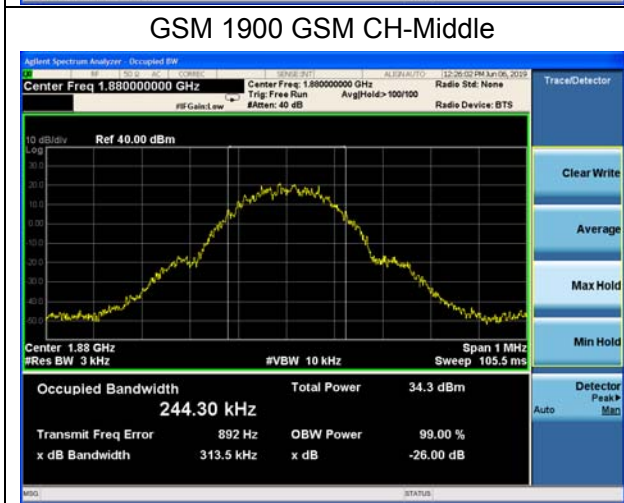
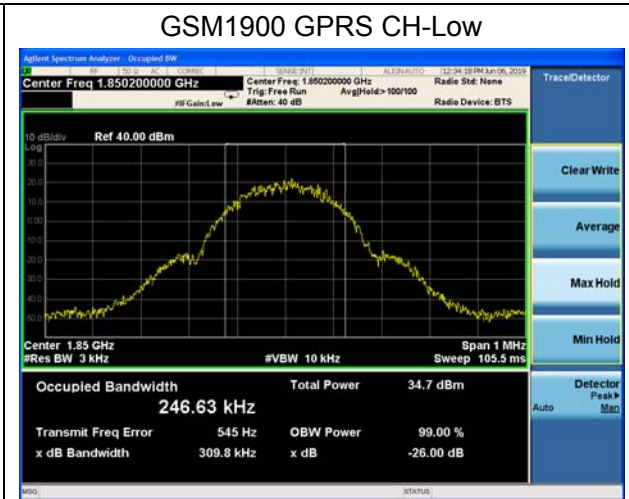
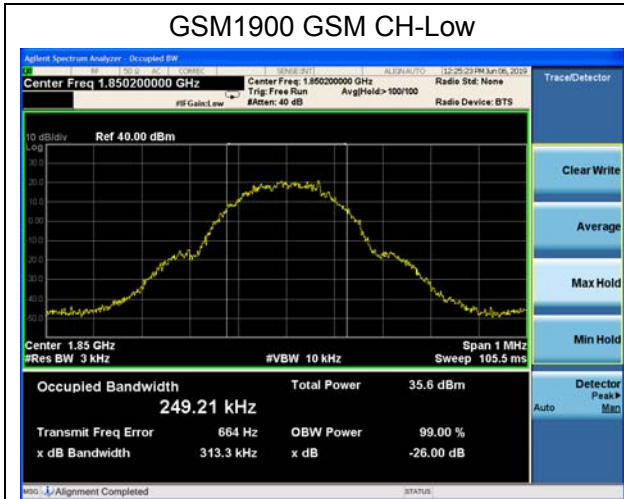

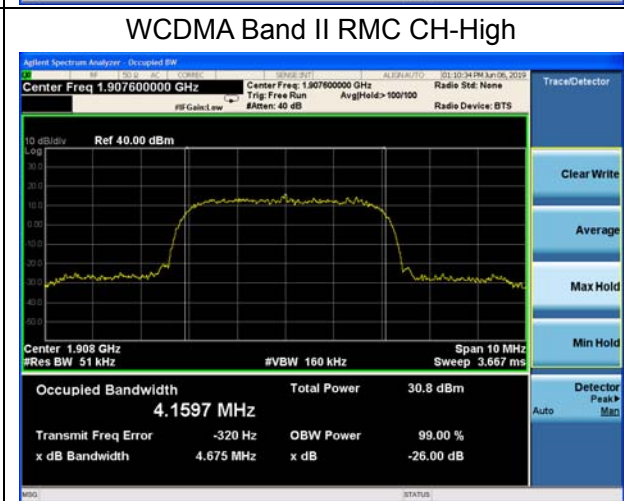
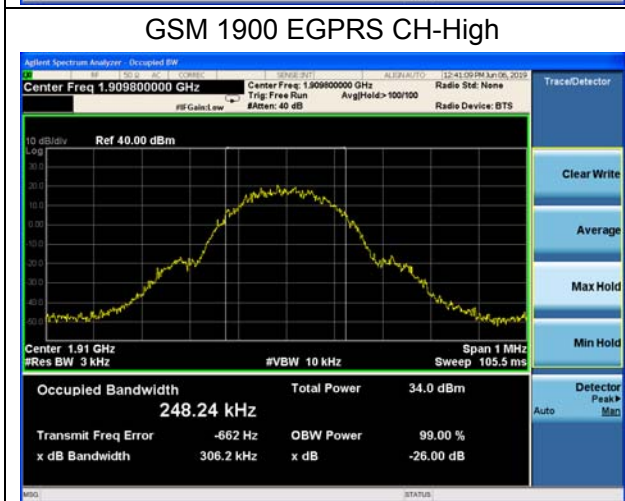
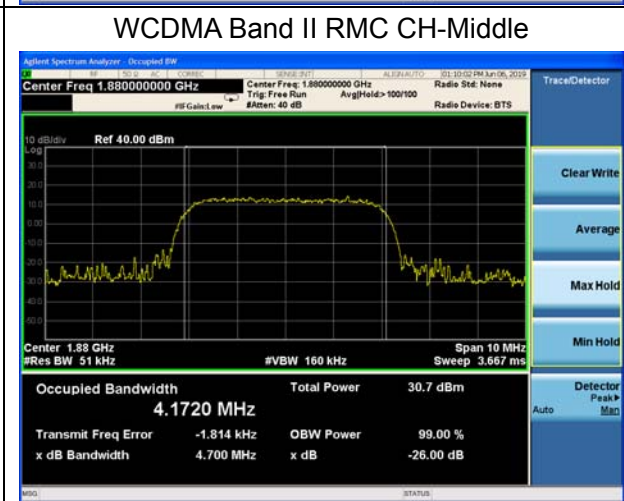
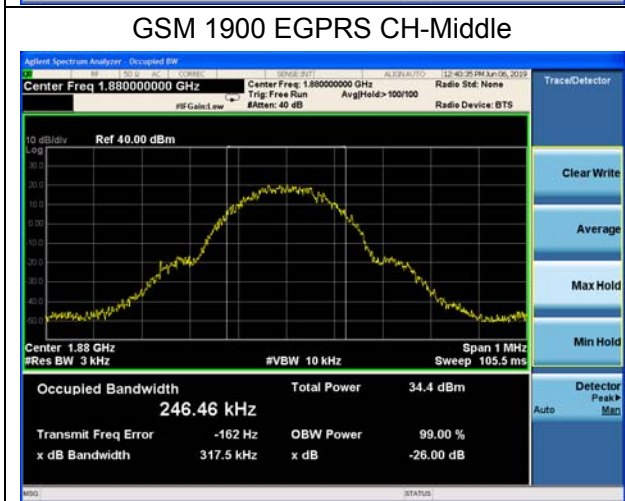
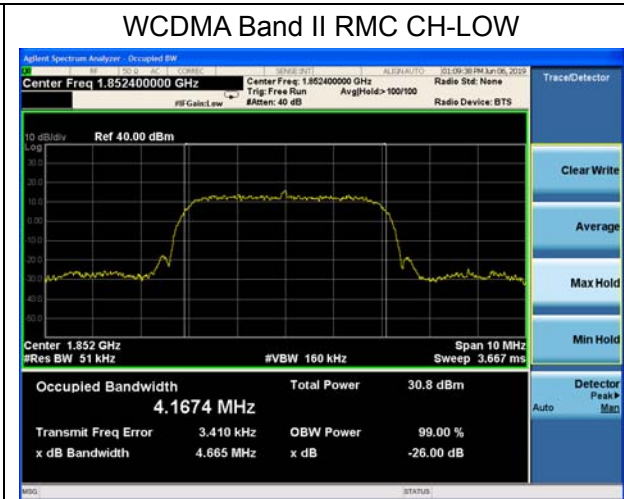
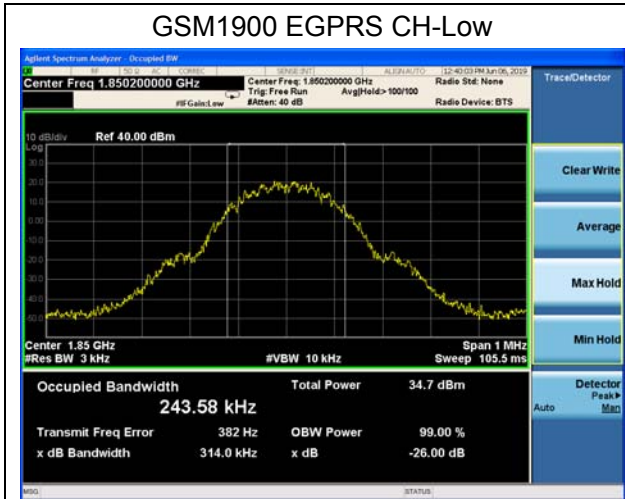

5.4. Band Edge Compliance

Ambient condition

Temperature	Relative humidity	Pressure
23°C ~25°C	45%~50%	101.5kPa

Method of Measurement

The EUT was connected to Spectrum Analyzer and Base Station Simulator via power Splitter. The band edge of the lowest and highest channels were measured. The Average detector is used and RBW is set to 3kHz, VBW is set to 10kHz for GSM 1900, RBW is set to 51kHz, VBW is set to 160kHz for WCDMA Band II, Spectrum analyzer plots are included on the following pages.

Test Setup

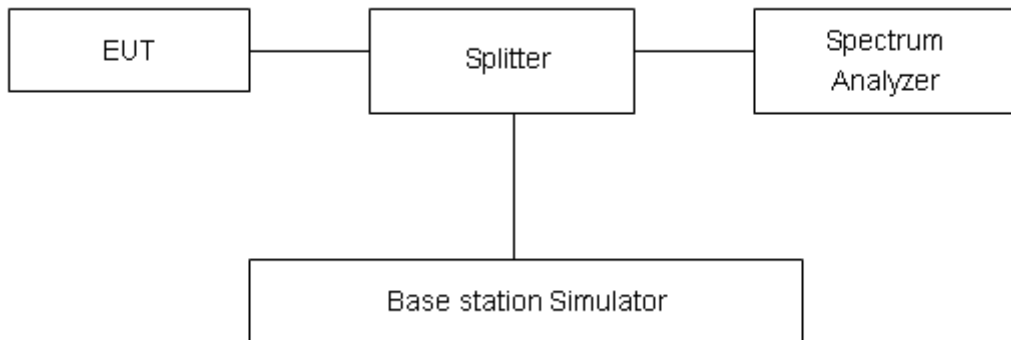

Limits

Rule Part 24.238(a) specifies that “on any frequency outside a licensee's frequency block, the power of any emission shall be attenuated below the transmitter power (P) by at least 43 + 10 log₁₀ (P) dB.”

Limit	-13 dBm
-------	---------

Measurement Uncertainty

The assessed measurement uncertainty to ensure 95% confidence level for the normal distribution is with the coverage factor $k = 1.96$, $U=0.684$ dB.

Test Result:

Original

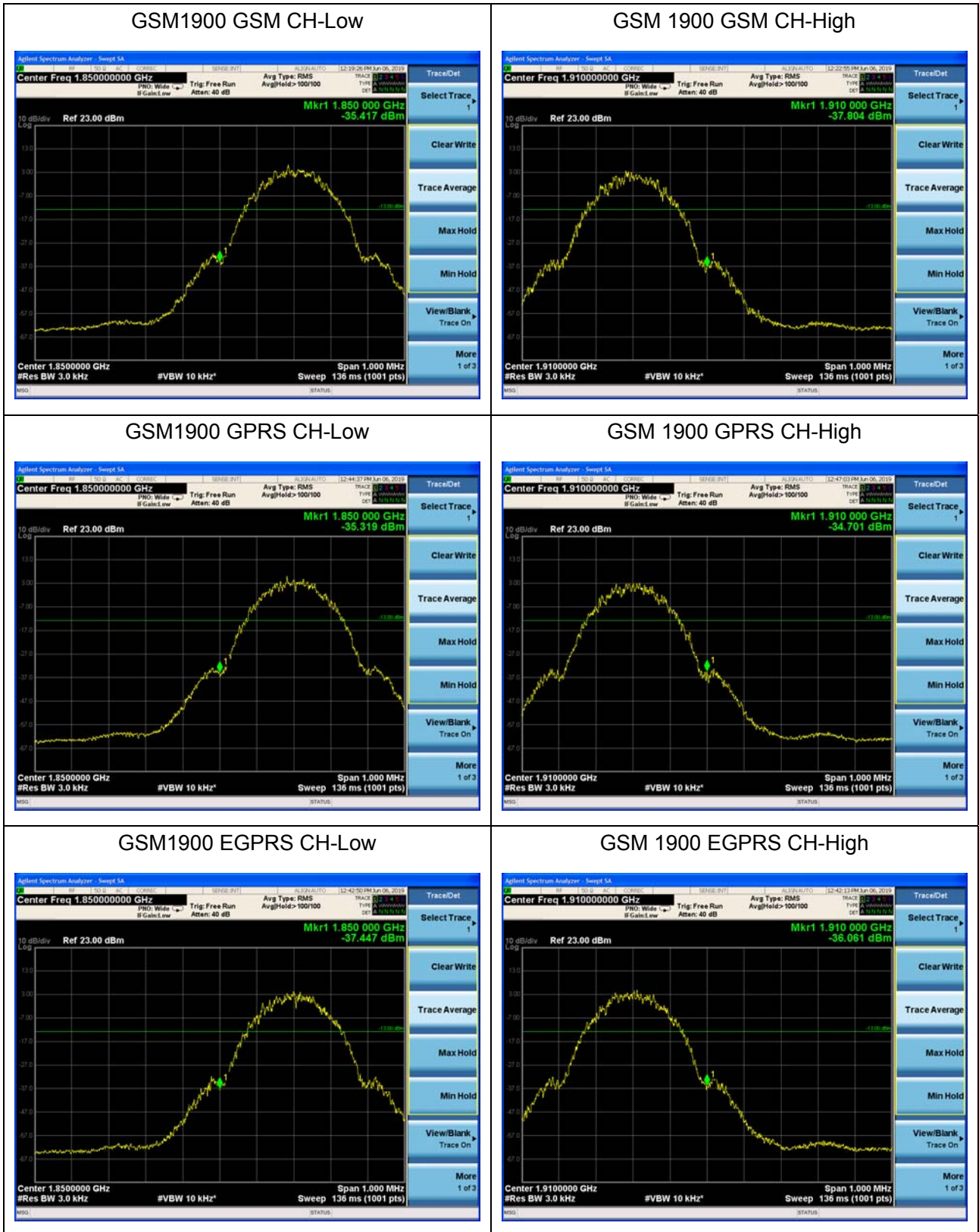



WCDMA Band II RMC CH-Low



WCDMA Band II RMC CH-High

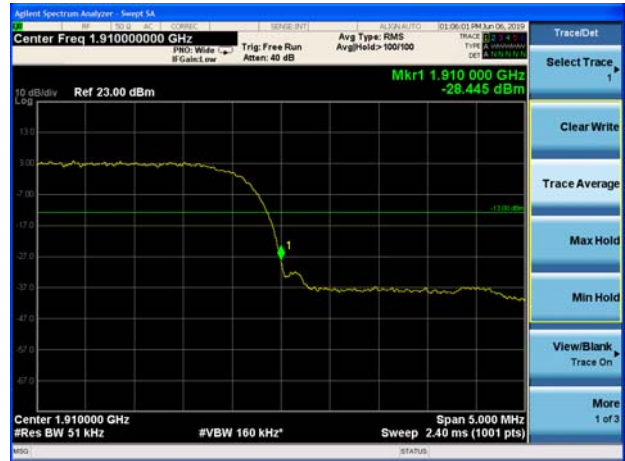

5.5. Peak-to-Average Power Ratio (PAPR)

Ambient condition

Temperature	Relative humidity	Pressure
23°C ~25°C	45%~50%	101.5kPa

Methods of Measurement

Measure the total peak power and record as PPk. And measure the total average power and record as PAvg. Both the peak and average power levels must be expressed in the same logarithmic units (e.g., dBm). Determine the PAPR from:

$$PAPR (dB) = PPk (dBm) - PAvg (dBm).$$

Test Setup

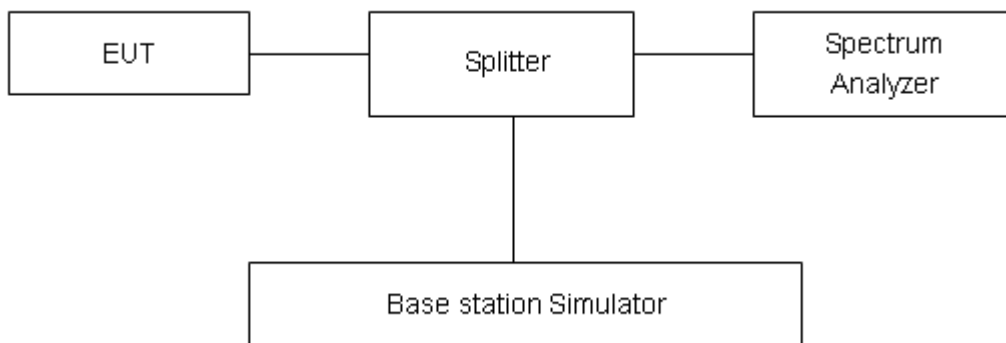

Limits

In measuring transmissions in this band using an average power technique, the peak-to-average ratio (PAR) of the transmission may not exceed 13 dB in 24.232(d).

Measurement Uncertainty

The assessed measurement uncertainty to ensure 95% confidence level for the normal distribution is with the coverage factor $k = 2$, $U = 0.4$ dB.

**Test Results****Original**

Mode	Channel	Frequency (MHz)	Peak(dBm)	Avg(dBm)	PAPR(dB)	Limit(dB)	Conclusion
GSM 1900 (GSM)	512	1850.2	30.96	28.93	2.03	≤13	PASS
	661	1880	30.80	28.76	2.04	≤13	PASS
	810	1909.8	30.83	28.77	2.06	≤13	PASS
GPRS 1900 (GMSK)	512	1850.2	30.91	28.90	2.01	≤13	PASS
	661	1880	30.78	28.73	2.05	≤13	PASS
	810	1909.8	30.78	28.76	2.02	≤13	PASS
EGPRS 1900 (8-PSK)	512	1850.2	29.87	26.11	3.76	≤13	PASS
	661	1880	29.89	26.18	3.71	≤13	PASS
	810	1909.8	30.03	26.28	3.75	≤13	PASS
WCDMA Band II (RMC)	9262	1852.4	24.79	21.78	3.01	≤13	PASS
	9400	1880	24.70	21.81	2.89	≤13	PASS
	9538	1907.6	24.40	21.69	2.71	≤13	PASS

5.6. Frequency Stability

Ambient condition

Temperature	Relative humidity	Pressure
23°C ~25°C	45%~50%	101.5kPa

Method of Measurement

Frequency Stability (Temperature Variation)

The temperature inside the climate chamber is varied from -30°C to +55°C in 10°C step size,

(1) With all power removed, the temperature was decreased to 0°C and permitted to stabilize for three hours.

(2) Measure the carrier frequency with the test equipment in a “call mode”. These measurements should be made within 1 minute of powering up the mobile station, to prevent significant self warming.

(3) Repeat the above measurements at 10°C increments from -30°C to +55°C. Allow at least 1.5 hours at each temperature, un-powered, before making measurements.

Frequency Stability (Voltage Variation)

The frequency stability shall be measured with variation of primary supply voltage as follows:

(1) Vary primary supply voltage from 85 to 115 percent of the nominal value for other than hand carried battery equipment.

(2) For hand carried, battery powered equipment, reduce primary supply voltage to the battery-operating end point which shall be specified by the manufacturer.

This transceiver is specified to operate with an input voltage of between 3.6 V and 4.35 V, with a nominal voltage of 3.8V.

Test setup

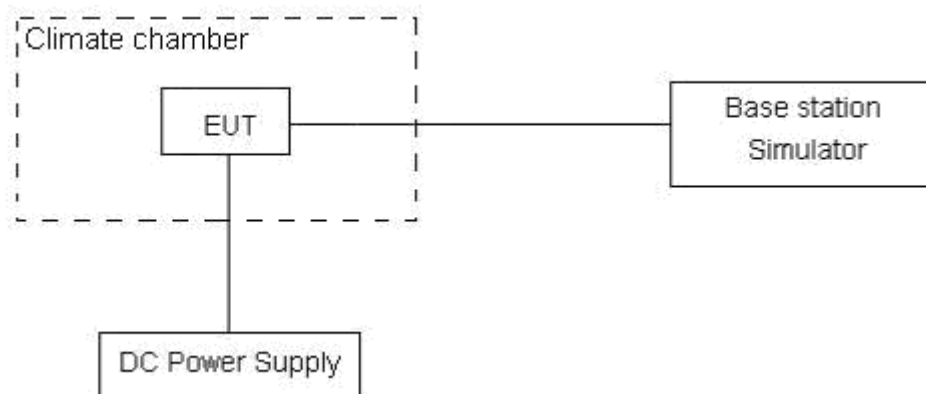

**Limits**

The frequency stability shall be sufficient to ensure that the fundamental emission stays within the authorized frequency block

Measurement Uncertainty

The assessed measurement uncertainty to ensure 99.75% confidence level for the normal distribution is with the coverage factor $k = 3$, $U = 0.01\text{ppm}$.



Test Result

Original

GSM1900						
Condition		Freq.Error (Hz)	Freq.Error (Hz)	Frequency Stability (ppm)	Frequency Stability (ppm)	Verdict
Temperature	Voltage	GMSK	8PSK	GMSK	8PSK	
Normal (25°C)	Normal	6.80	8.46	0.00362	0.00450	PASS
Extreme (55°C)		11.99	14.73	0.00638	0.00784	PASS
Extreme (50°C)		10.76	4.15	0.00573	0.00221	PASS
Extreme (40°C)		5.38	9.81	0.00286	0.00522	PASS
Extreme (30°C)		5.99	1.29	0.00319	0.00068	PASS
Extreme (20°C)		16.36	9.33	0.00870	0.00496	PASS
Extreme (10°C)		8.17	17.99	0.00434	0.00957	PASS
Extreme (0°C)		6.62	16.82	0.00352	0.00895	PASS
Extreme (-10°C)		1.16	9.85	0.00062	0.00524	PASS
Extreme (-20°C)		3.41	1.72	0.00181	0.00092	PASS
Extreme (-30°C)		10.87	9.86	0.00578	0.00524	PASS
25°C	LV	1.22	15.57	0.00065	0.00828	PASS
	HV	13.44	1.67	0.00715	0.00089	PASS

WCDMA Band II						
Condition		Freq.Error (Hz)	Freq.Error (Hz)	Frequency Stability (ppm)	Frequency Stability (ppm)	Verdict
Temperature	Voltage	BPSK	QPSK	BPSK	QPSK	
Normal (25°C)	Normal	14.54	2.82	0.00774	0.00150	PASS
Extreme (55°C)		1.75	1.60	0.00093	0.00085	PASS
Extreme (50°C)		11.25	10.93	0.00598	0.00581	PASS
Extreme (40°C)		14.25	16.41	0.00758	0.00873	PASS
Extreme (30°C)		8.51	1.05	0.00453	0.00056	PASS
Extreme (20°C)		11.65	14.49	0.00620	0.00771	PASS
Extreme (10°C)		4.35	14.33	0.00231	0.00762	PASS
Extreme (0°C)		4.17	3.37	0.00222	0.00179	PASS
Extreme (-10°C)		12.31	15.95	0.00655	0.00848	PASS
Extreme (-20°C)		8.93	15.31	0.00475	0.00815	PASS
Extreme (-30°C)		9.57	8.17	0.00509	0.00435	PASS
25°C	LV	6.65	4.88	0.00354	0.00260	PASS
	HV	6.10	15.68	0.00325	0.00834	PASS

5.7. Spurious Emissions at Antenna Terminals

Ambient condition

Temperature	Relative humidity	Pressure
23°C ~25°C	45%~50%	101.5kPa

Method of Measurement

The EUT was connected to Spectrum Analyzer and Base Station Simulator via power Splitter. The measurement is carried out using a spectrum analyzer. The spectrum analyzer scans from 9kHz to the 10th harmonic of the carrier. The peak detector is used.

RBW is set to 100kHz, VBW is set to 300kHz for 30MHz~1GHz

RBW is set to 1MHz, VBW is set to 3MHz for above 1GHz, Sweep is set to ATUO.

The modulation mode and RB allocation refer to section 5.1, using the maximum output power configuration.

Test setup

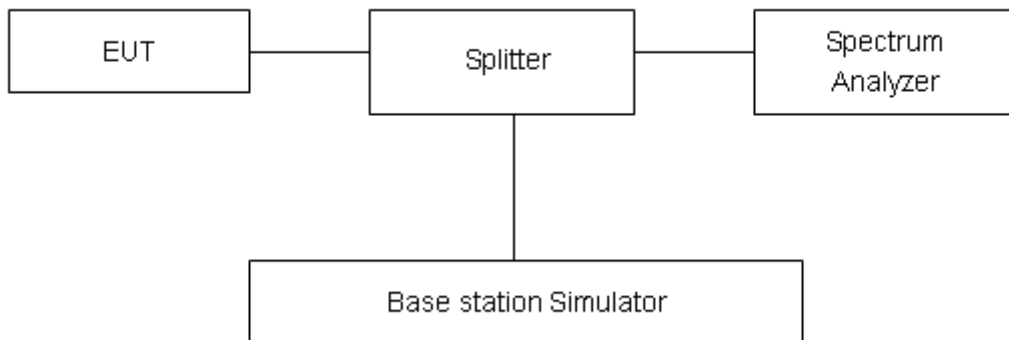

Limits

Rule Part 24.238(a) specifies that “on any frequency outside a licensee's frequency block, the power of any emission shall be attenuated below the transmitter power (P) by at least 43 + 10 log₁₀ (P) dB.”

Limit	-13 dBm
-------	---------

Measurement Uncertainty

The assessed measurement uncertainty to ensure 99.75% confidence level for the normal distribution is with the coverage factor $k = 1.96$.

Frequency	Uncertainty
9kHz-1GHz	0.684 dB
1GHz-20GHz	1.407 dB

Test Result

Sweep the whole frequency band through the range from 9kHz to the 10th harmonic of the carrier, the emissions more than 20 dB below the limit are not reported.

The signal beyond the limit is carrier.

Original

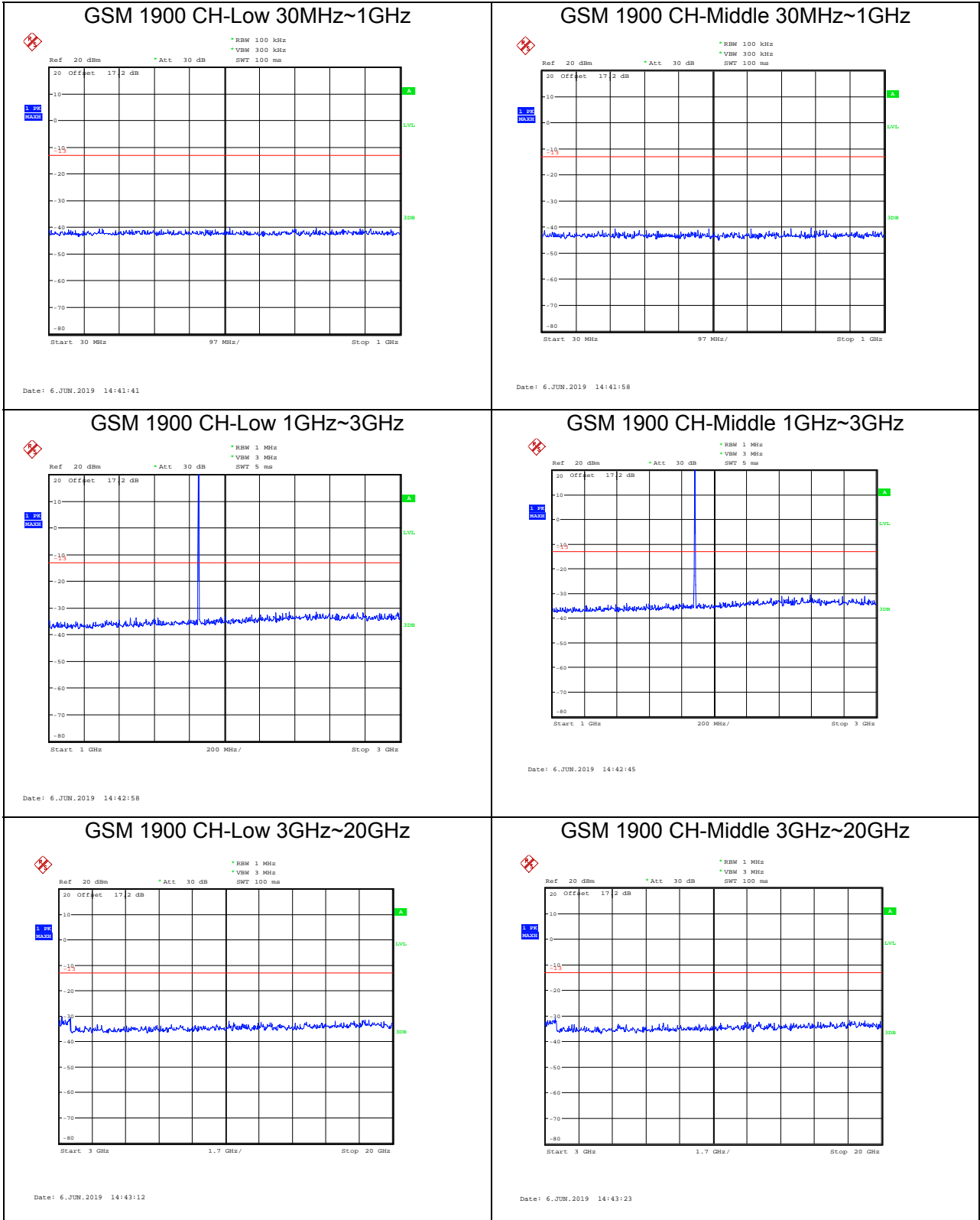



GSM 1900 CH-High 30MHz~1GHz

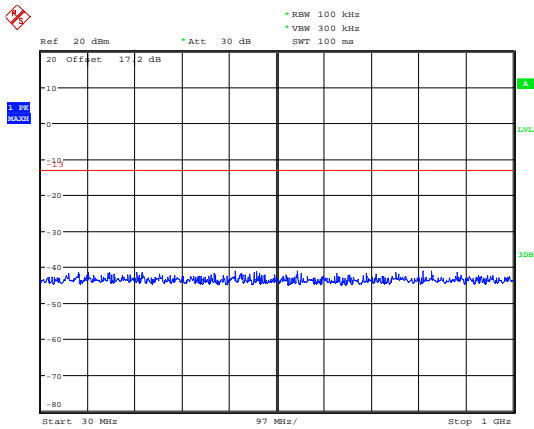

Date: 6 JUN. 2019 14:42:11

GPRS 1900 CH-Low 30MHz~1GHz

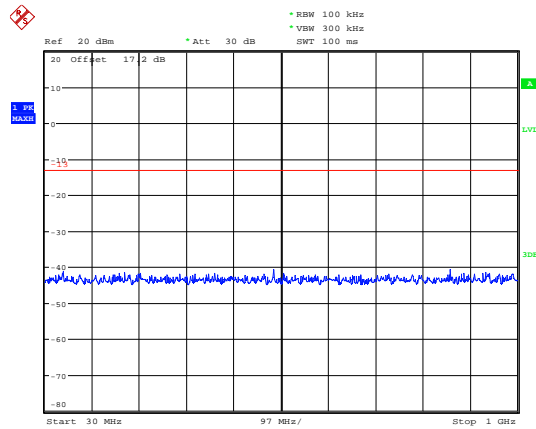

Date: 6 JUN. 2019 14:48:28

GSM 1900 CH-High 1GHz~3GHz

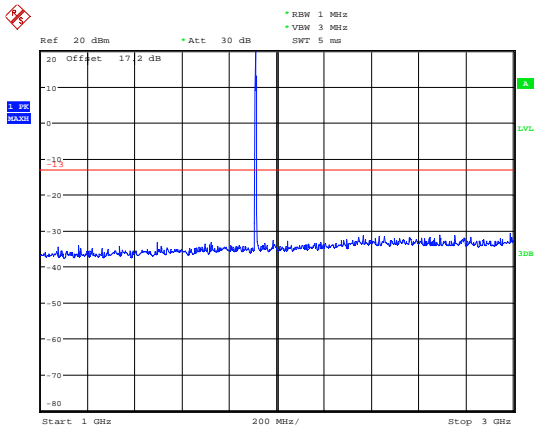

Date: 6 JUN. 2019 14:42:33

GPRS 1900 CH-Low 1GHz~3GHz

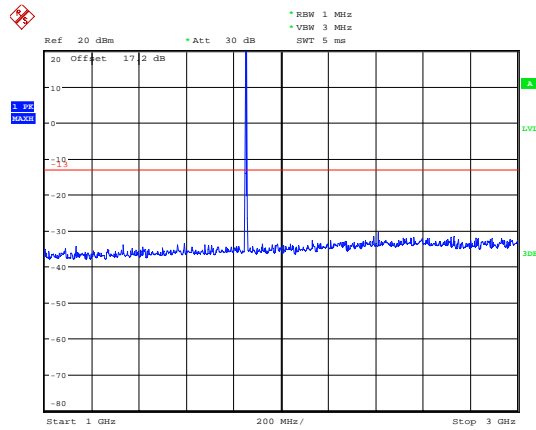

Date: 6 JUN. 2019 14:48:00

GSM 1900 CH-High 3GHz~20GHz

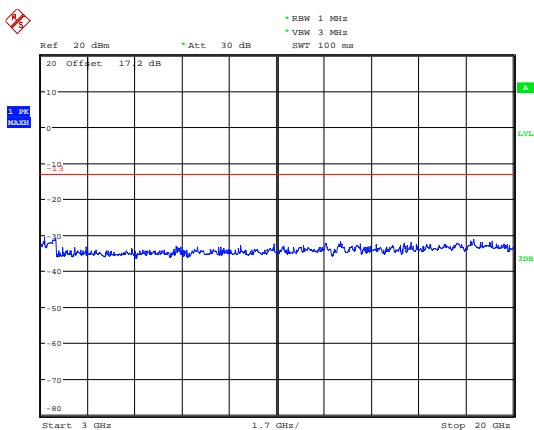

Date: 6 JUN. 2019 14:44:03

GPRS 1900 CH-Low 3GHz~20GHz

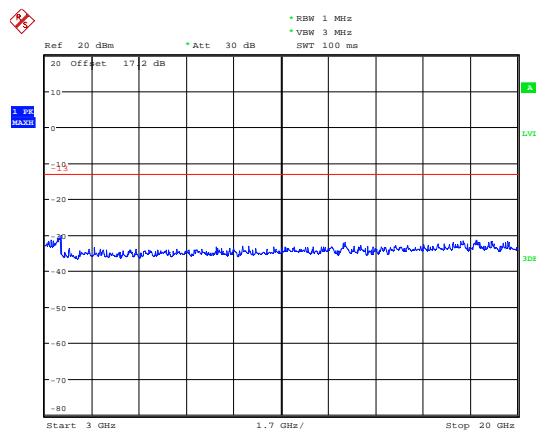

Date: 6 JUN. 2019 14:46:34



GPRS 1900 CH-Middle 30MHz~1GHz

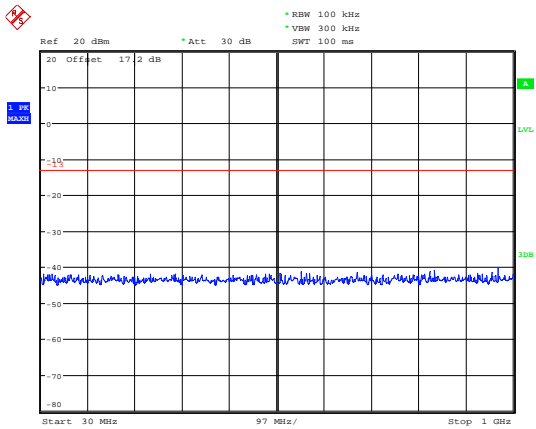

Date: 6 JUN. 2019 14:48:39

GPRS 1900 CH-High 30MHz~1GHz

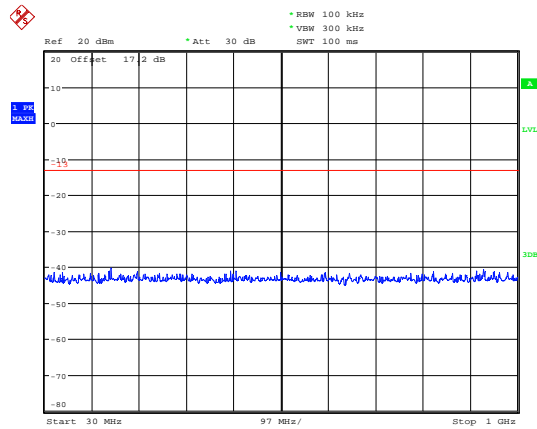

Date: 6 JUN. 2019 14:48:53

GPRS 1900 CH-Middle 1GHz~3GHz

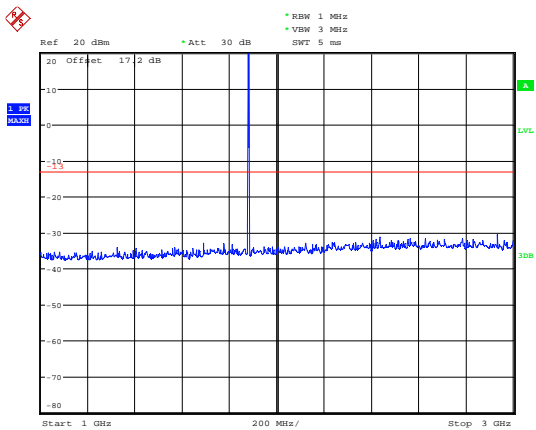

Date: 6 JUN. 2019 14:47:48

GPRS 1900 CH-High 1GHz~3GHz

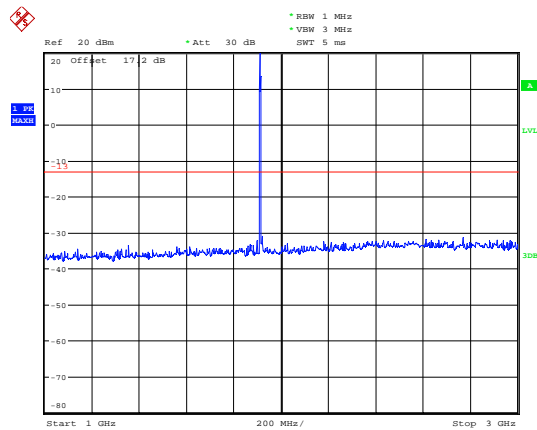

Date: 6 JUN. 2019 14:47:26

GPRS 1900 CH-Middle 3GHz~20GHz

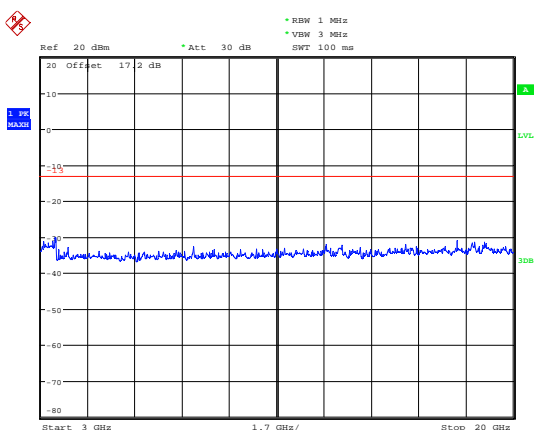

Date: 6 JUN. 2019 14:47:01

GPRS 1900 CH-High 3GHz~20GHz

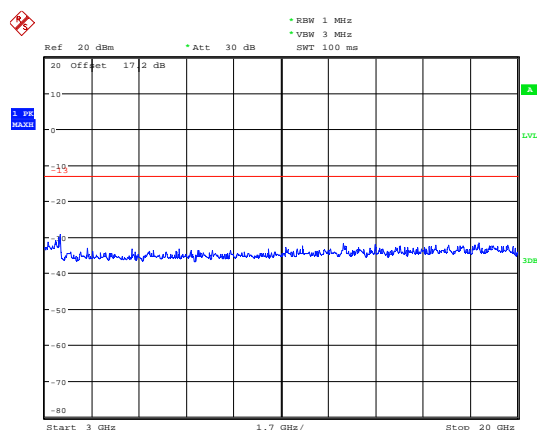

Date: 6 JUN. 2019 14:47:13



EGPRS 1900 CH-Low 30MHz~1GHz

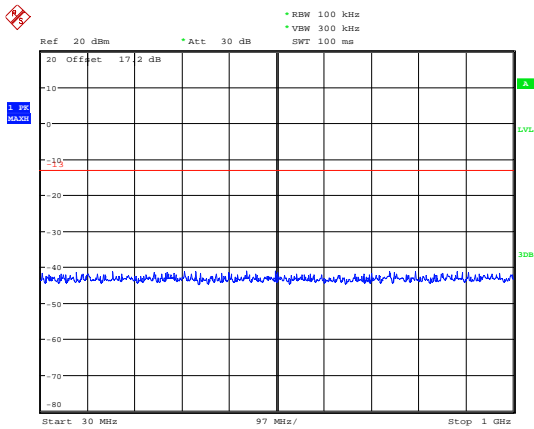

Date: 6 JUN. 2019 14:51:30

EGPRS 1900 CH-Middle 30MHz~1GHz

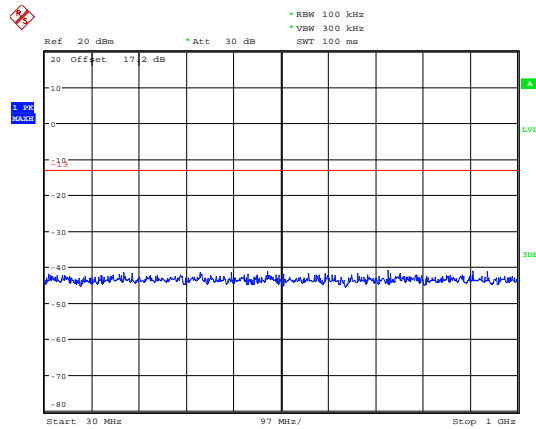

Date: 6 JUN. 2019 14:52:54

EGPRS 1900 CH-Low 1GHz~3GHz

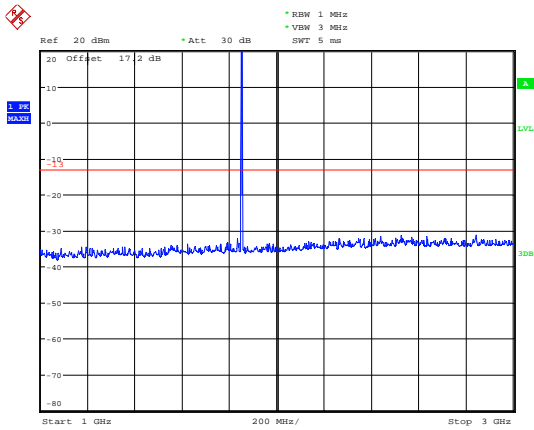

Date: 6 JUN. 2019 14:57:18

EGPRS 1900 CH-Middle 1GHz~3GHz

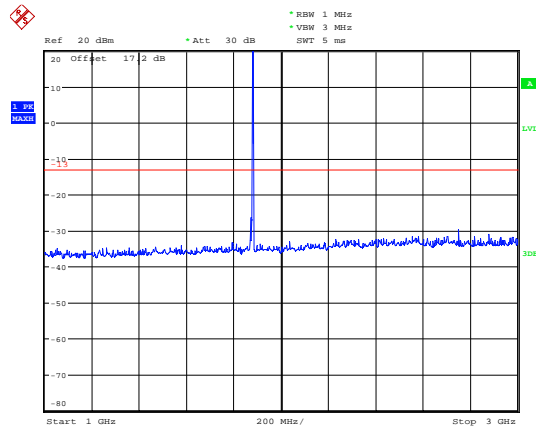

Date: 6 JUN. 2019 14:56:56

EGPRS 1900 CH-Low 3GHz~20GHz

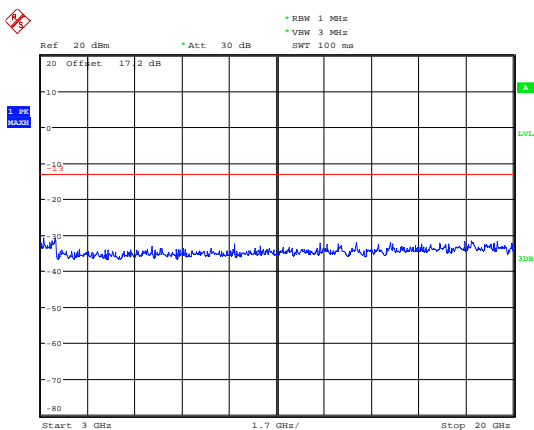

Date: 6 JUN. 2019 15:11:48

EGPRS 1900 CH-Middle 3GHz~20GHz

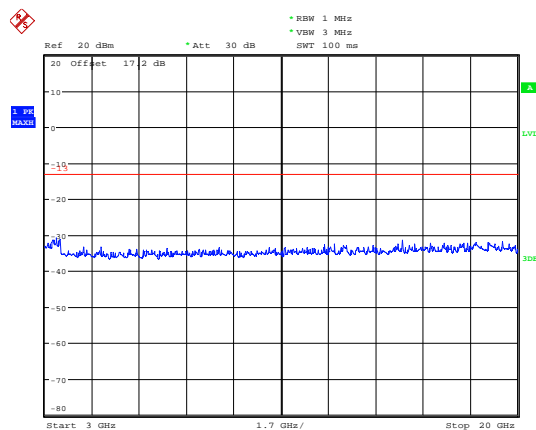

Date: 6 JUN. 2019 15:11:59



EGPRS 1900 CH-High 30MHz~1GHz

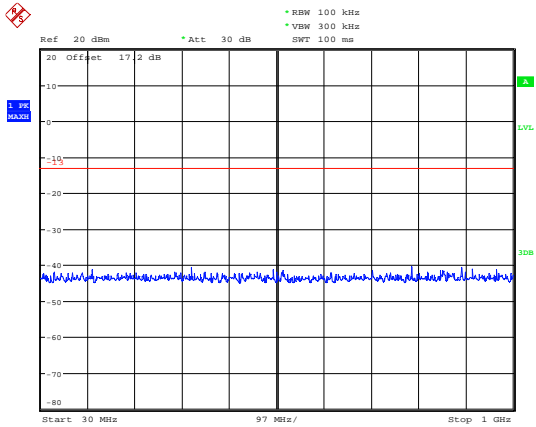

Date: 6 JUN. 2019 14:53:04

WCDMA Band II CH- Low 30MHz~1GHz

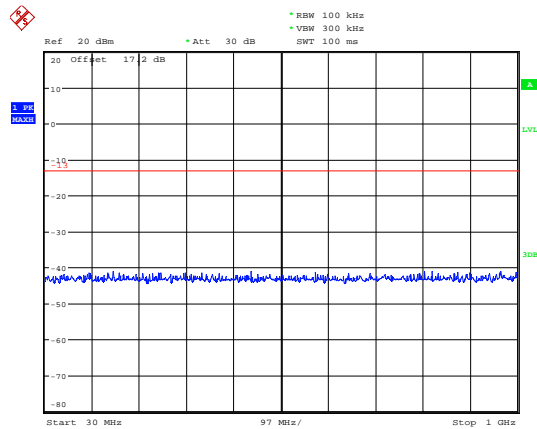

Date: 6 JUN. 2019 12:40:12

EGPRS 1900 CH-High 1GHz~3GHz

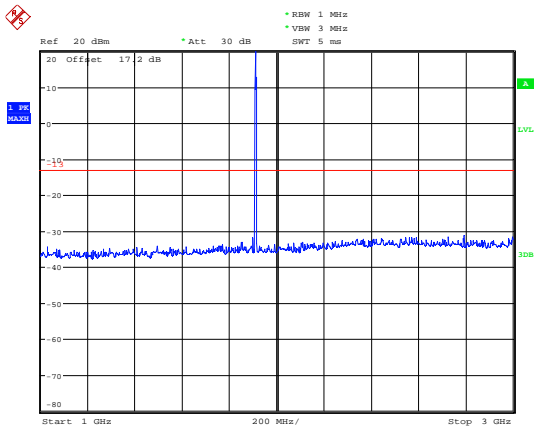

Date: 6 JUN. 2019 14:56:43

WCDMA BAND II CH- Low 1GHz~3GHz

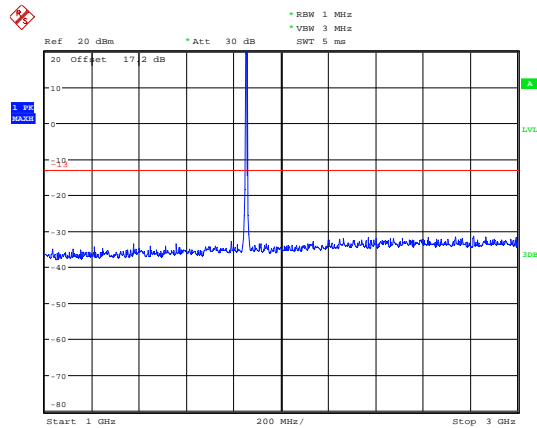

Date: 6 JUN. 2019 12:42:34

EGPRS 1900 CH-High 3GHz~20GHz

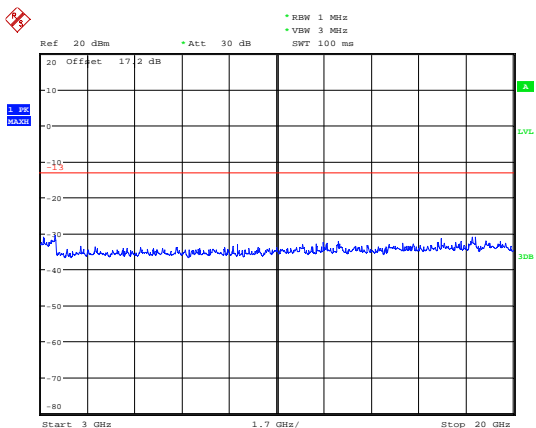

Date: 6 JUN. 2019 15:12:09

WCDMA BAND II CH- Low 3GHz~20GHz

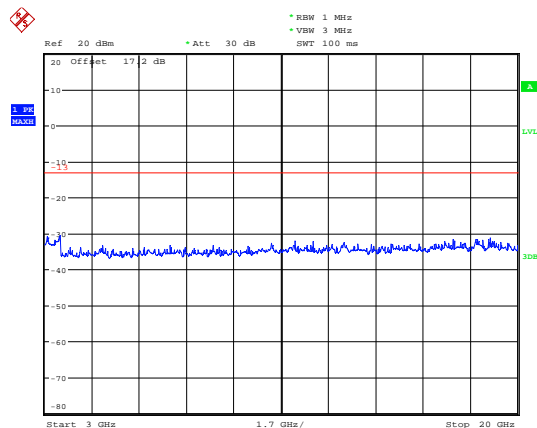

Date: 6 JUN. 2019 12:42:51



WCDMA Band II CH- Middle 30MHz~1GHz

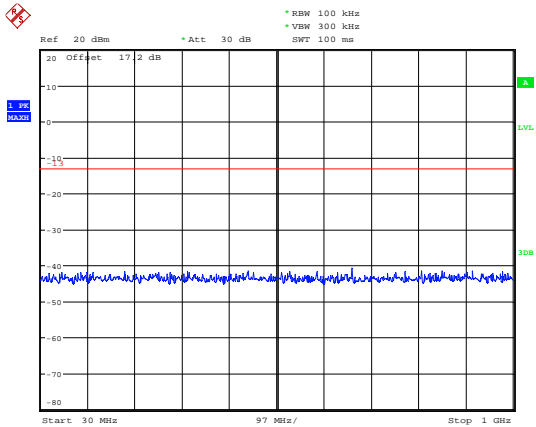

Date: 6 JUN. 2019 12:40:48

WCDMA Band II CH- High 30MHz~1GHz

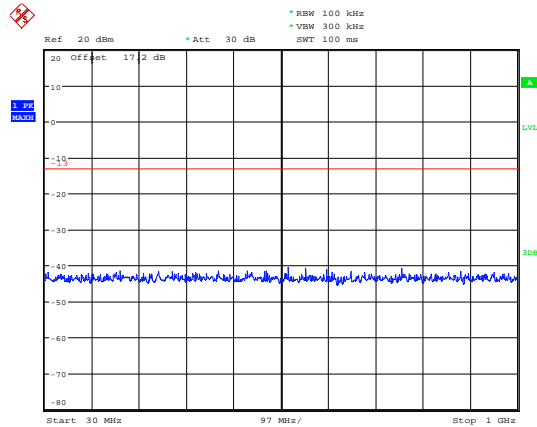

Date: 6 JUN. 2019 12:41:10

WCDMA BAND II CH-Middle 1GHz~3GHz

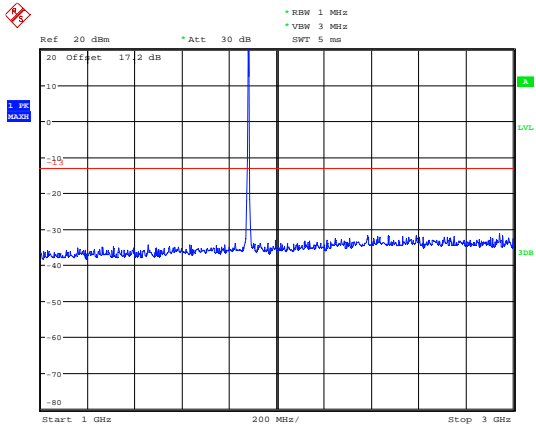

Date: 6 JUN. 2019 12:42:14

WCDMA BAND II CH-High 1GHz~3GHz

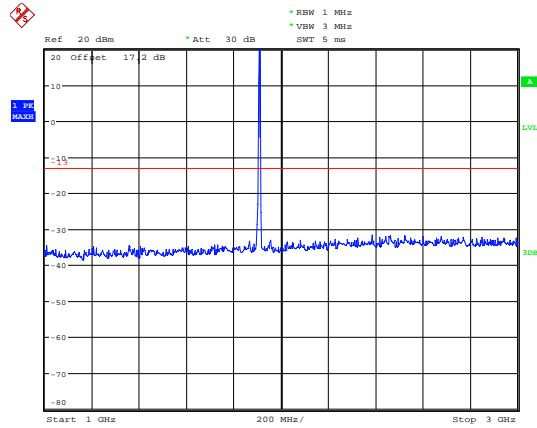

Date: 6 JUN. 2019 12:41:56

WCDMA BAND II CH-Middle 3GHz~20GHz

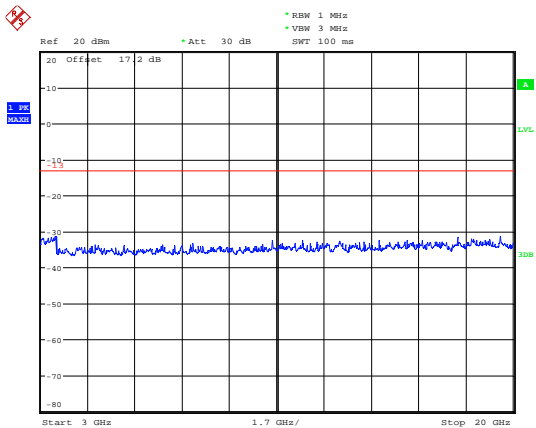

Date: 6 JUN. 2019 12:43:08

WCDMA BAND II CH-High 3GHz~20GHz

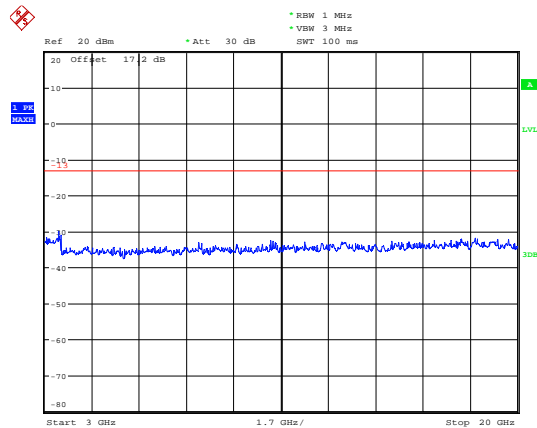

Date: 6 JUN. 2019 12:43:30

5.8. Radiates Spurious Emission

Ambient condition

Temperature	Relative humidity	Pressure
23°C ~25°C	45%~50%	101.5kPa

Method of Measurement

1. The testing follows FCC KDB 971168 v03r01 Section 5.8 and ANSI C63.26 (2015).
2. Below 1GHz: The EUT is placed on a turntable 0.8 meters above the ground in the chamber, 3 meter away from the antenna. The maximal emission value is acquired by adjusting the antenna height, polarisation and turntable azimuth. Normally, the height range of antenna is 1 m to 4 m, the azimuth range of turntable is 0° to 360°, and the receive antenna has two polarizations Vertical (V) and Horizontal (H). Above 1GHz: (Note: the FCC's permission to use 1.5m as an alternative per TCBC Conf call of Dec. 2, 2014.) The EUT is placed on a turntable 1.5 meters above the ground in the chamber, 3 meter away from the antenna. The maximal emission value is acquired by adjusting the antenna height, polarisation and turntable azimuth. Normally, the height range of antenna is 1 m to 4 m, the azimuth range of turntable is 0° to 360°, and the receive antenna has two polarizations Vertical (V) and Horizontal (H).
3. A loop antenna, A log-periodic antenna or horn antenna shall be substituted in place of the EUT. The log-periodic antenna will be driven by a signal generator and the level will be adjusted till the same power value on the spectrum analyzer or receiver. The level of the spurious emissions can be calculated through the level of the signal generator, cable loss, the gain of the substitution antenna and the reading of the spectrum analyzer or receiver.
4. The EUT is then put into continuously transmitting mode at its maximum power level during the test. Set Test Receiver or Spectrum RBW=200Hz,VBW=600Hz for 9kHz150kHz , RBW=10kHz, VBW=30kHz 150kHz-30MHz , RBW=100kHz,VBW=300kHz for 30MHz to 1GHz and RBW=1MHz, VBW=3MHz for above 1GHz, And the maximum value of the receiver should be recorded as (Pr).
5. The EUT shall be replaced by a substitution antenna. In the chamber, an substitution antenna for the frequency band of interest is placed at the reference point of the chamber. An RF Signal source for the frequency band of interest is connected to the substitution antenna with a cable that has been constructed to not interfere with the radiation pattern of the antenna. A power (PMea) is applied to the input of the substitution antenna, and adjust the level of the signal generator output until the value of the receiver reach the previously recorded (Pr). The power of signal source (PMea) is recorded. The test should be performed by rotating the test item and adjusting the receiving antenna polarization.
6. A amplifier should be connected to the Signal Source output port. And the cable should be connect between the Amplifier and the Substitution Antenna. The cable loss (Pcl) ,the Substitution Antenna Gain (Ga) and the Amplifier Gain (PAg) should be recorded after test.
7. The measurement results are obtained as described below:
$$\text{Power(EIRP)} = \text{PMea} - \text{PAg} - \text{Pcl} + \text{Ga}$$

The measurement results are amend as described below:
$$\text{Power(EIRP)} = \text{PMea} - \text{Pcl} + \text{Ga}$$
8. This value is EIRP since the measurement is calibrated using an antenna of known gain (2.15 dBi)

and known input power. ERP can be calculated from EIRP by subtracting the gain of the dipole, $ERP = EIRP - 2.15\text{dBi}$.

The modulation mode and RB allocation refer to section 5.1, using the maximum output power configuration.

Test setup

9KHz ~ 30MHz

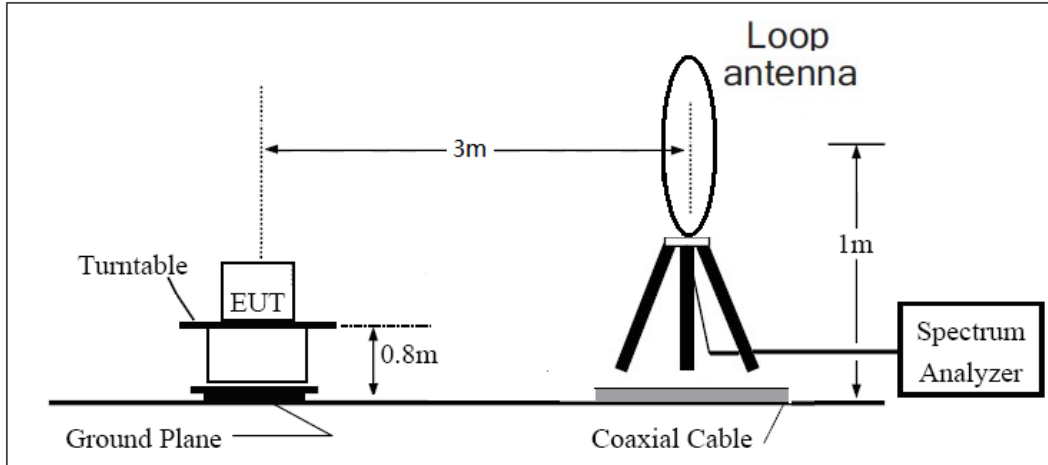

30MHz ~ 1GHz

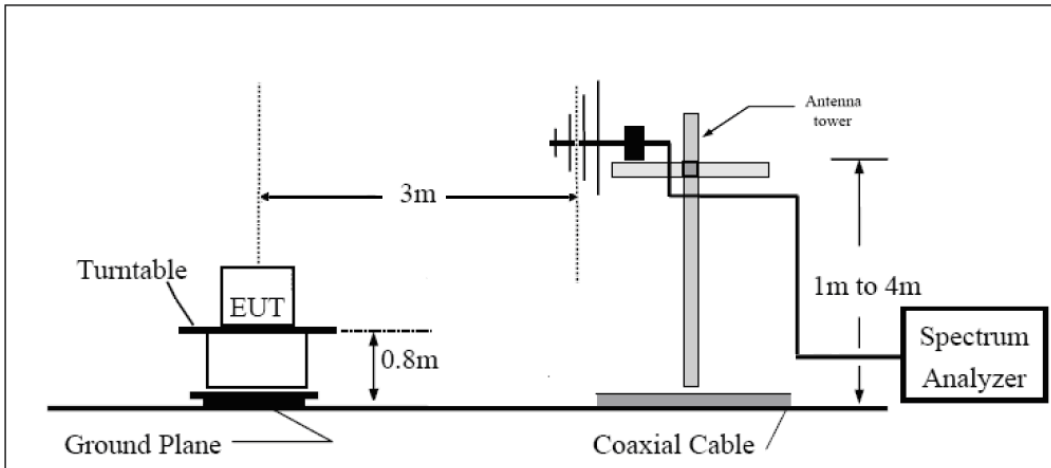

Above 1GHz

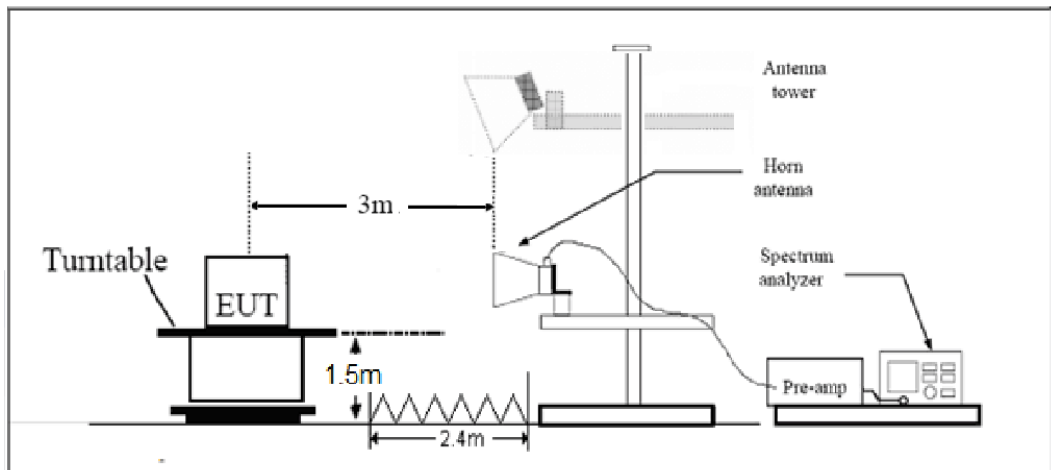



Note: Area side: 2.4mX3.6m

Limits

Rule Part 24.238(a) specifies that “on any frequency outside a licensee's frequency block, the power of any emission shall be attenuated below the transmitter power (P) by at least $43 + 10 \log_{10} (P)$ dB.”

Limit	-13 dBm
-------	---------

Measurement Uncertainty

The assessed measurement uncertainty to ensure 95% confidence level for the normal distribution is with the coverage factor $k = 1.96$, $U = 3.55$ dB.

Test Result

Sweep the whole frequency band through the range from 9kHz to the 10th harmonic of the carrier, the emissions below the noise floor will not be recorded in the report.

Original

GSM 1900 CH-Low

Harmonic	Frequency (MHz)	SG (dBm)	Cable Loss (dB)	Gain (dBi)	Antenna Polarization	EIRP Level (dBm)	Limit (dBm)	Margin (dB)	Azimuth (deg)
2	3700.4	-60.60	5.10	11.05	Horizontal	-54.65	-13.00	41.65	90
3	5550.6	-56.33	5.42	12.65	Horizontal	-49.10	-13.00	36.10	135
4	7400.8	-56.32	6.70	13.85	Horizontal	-49.17	-13.00	36.17	315
5	9251.0	-43.48	7.01	14.75	Horizontal	-35.74	-13.00	22.74	0
6	11101.2	-52.56	7.48	15.95	Horizontal	-44.09	-13.00	31.09	45
7	12951.4	-45.84	7.51	16.55	Horizontal	-36.80	-13.00	23.80	180
8	14801.6	-44.95	8.24	15.35	Horizontal	-37.84	-13.00	24.84	135
9	16651.8	-38.69	8.41	14.95	Horizontal	-32.15	-13.00	19.15	270
10	18502.0	-	-	-	-	-	-	-	-

Note: 1.The other Spurious RF Radiated emissions level is no more than noise floor.
 2.The worst emission was found in the antenna is Horizontal position.

GSM 1900 CH-Middle

Harmonic	Frequency (MHz)	SG (dBm)	Cable Loss (dB)	Gain (dBi)	Antenna Polarization	EIRP Level (dBm)	Limit (dBm)	Margin (dB)	Azimuth (deg)
2	3760.0	-60.97	5.10	11.05	Horizontal	-55.02	-13.00	42.02	135
3	5640.0	-56.47	5.42	12.65	Horizontal	-49.24	-13.00	36.24	315
4	7520.0	-55.49	6.70	13.85	Horizontal	-48.34	-13.00	35.34	0
5	9400.0	-44.62	7.01	14.75	Horizontal	-36.88	-13.00	23.88	45
6	11280.0	-51.43	7.48	15.95	Horizontal	-42.96	-13.00	29.96	0
7	13160.0	-47.47	7.51	16.55	Horizontal	-38.43	-13.00	25.43	45
8	15040.0	-49.15	8.24	15.35	Horizontal	-42.04	-13.00	29.04	180
9	16920.0	-39.90	8.41	14.95	Horizontal	-33.36	-13.00	20.36	135
10	18800.0	-	-	-	-	-	-	-	-

Note: 1.The other Spurious RF Radiated emissions level is no more than noise floor.
 2. The worst emission was found in the antenna is Horizontal position.



GSM 1900 CH-High

Harmonic	Frequency (MHz)	SG (dBm)	Cable Loss (dB)	Gain (dBi)	Antenna Polarization	EIRP Level (dBm)	Limit (dBm)	Margin (dB)	Azimuth (deg)
2	3819.6	-58.88	5.10	11.05	Horizontal	-52.93	-13.00	39.93	0
3	5729.4	-55.45	5.42	12.65	Horizontal	-48.22	-13.00	35.22	45
4	7639.2	-54.74	6.70	13.85	Horizontal	-47.59	-13.00	34.59	0
5	9549.0	-48.89	7.01	14.75	Horizontal	-41.15	-13.00	28.15	45
6	11458.8	-50.72	7.48	15.95	Horizontal	-42.25	-13.00	29.25	180
7	13368.6	-43.69	7.51	16.55	Horizontal	-34.65	-13.00	21.65	0
8	15278.4	-47.27	8.24	15.35	Horizontal	-40.16	-13.00	27.16	45
9	17188.2	-43.32	8.41	14.95	Horizontal	-36.78	-13.00	23.78	180
10	19098.0	-	-	-	-	-	-	-	-

Note: 1. The other Spurious RF Radiated emissions level is no more than noise floor.

2. The worst emission was found in the antenna is Horizontal position.

WCDMA Band II CH-Low

Harmonic	Frequency (MHz)	SG (dBm)	Cable Loss (dB)	Gain (dBi)	Antenna Polarization	EIRP Level (dBm)	Limit (dBm)	Margin (dB)	Azimuth (deg)
2	3704.8	-63.88	5.10	11.05	Horizontal	-57.93	-13.00	44.93	0
3	5557.2	-62.27	5.42	12.65	Horizontal	-55.04	-13.00	42.04	45
4	7409.6	-57.04	6.70	13.85	Horizontal	-49.89	-13.00	36.89	0
5	9262.0	-56.31	7.01	14.75	Horizontal	-48.57	-13.00	35.57	0
6	11114.4	-54.21	7.48	15.95	Horizontal	-45.74	-13.00	32.74	45
7	12966.8	-54.32	7.51	16.55	Horizontal	-45.28	-13.00	32.28	0
8	14819.2	-50.58	8.24	15.35	Horizontal	-43.47	-13.00	30.47	45
9	16671.6	-51.15	8.41	14.95	Horizontal	-44.61	-13.00	31.61	180
10	18524.0	-	-	-	-	-	-	-	-

Note: 1. The other Spurious RF Radiated emissions level is no more than noise floor.

2. The worst emission was found in the antenna is Horizontal position.



WCDMA Band II CH-Middle

Harmonic	Frequency (MHz)	SG (dBm)	Cable Loss (dB)	Gain (dBi)	Antenna Polarization	EIRP Level (dBm)	Limit (dBm)	Margin (dB)	Azimuth (deg)
2	3760.0	-63.93	5.10	11.05	Horizontal	-57.98	-13.00	44.98	45
3	5640.0	-62.34	5.42	12.65	Horizontal	-55.11	-13.00	42.11	180
4	7520.0	-58.05	6.70	13.85	Horizontal	-50.90	-13.00	37.90	135
5	9400.0	-56.55	7.01	14.75	Horizontal	-48.81	-13.00	35.81	0
6	11280.0	-55.17	7.48	15.95	Horizontal	-46.70	-13.00	33.70	45
7	13160.0	-55.31	7.51	16.55	Horizontal	-46.27	-13.00	33.27	180
8	15040.0	-51.72	8.24	15.35	Horizontal	-44.61	-13.00	31.61	135
9	16920.0	-49.93	8.41	14.95	Horizontal	-43.39	-13.00	30.39	270
10	18800.0	-	-	-	-	-	-	-	-

Note: 1. The other Spurious RF Radiated emissions level is no more than noise floor.

2. The worst emission was found in the antenna is Horizontal position.

WCDMA Band II CH-High

Harmonic	Frequency (MHz)	SG (dBm)	Cable Loss (dB)	Gain (dBi)	Antenna Polarization	EIRP Level (dBm)	Limit (dBm)	Margin (dB)	Azimuth (deg)
2	3813.8	-63.83	5.10	11.05	Horizontal	-57.88	-13.00	44.88	45
3	5722.8	-62.36	5.42	12.65	Horizontal	-55.13	-13.00	42.13	0
4	7630.4	-57.97	6.70	13.85	Horizontal	-50.82	-13.00	37.82	0
5	9538.0	-57.29	7.01	14.75	Horizontal	-49.55	-13.00	36.55	45
6	11445.6	-54.39	7.48	15.95	Horizontal	-45.92	-13.00	32.92	0
7	13353.2	-53.71	7.51	16.55	Horizontal	-44.67	-13.00	31.67	45
8	15260.8	-52.25	8.24	15.35	Horizontal	-45.14	-13.00	32.14	180
9	17168.4	-49.81	8.41	14.95	Horizontal	-43.27	-13.00	30.27	135
10	19076.0	-	-	-	-	-	-	-	-

Note: 1. The other Spurious RF Radiated emissions level is no more than noise floor.

2. The worst emission was found in the antenna is Horizontal position.

6. Main Test Instruments

Name	Manufacturer	Type	Serial Number	Calibration Date	Expiration Date
Base Station Simulator	R&S	CMU200	118133	2019-05-19	2020-05-18
Power Splitter	Hua Xiang	SHX-GF2-2-13	10120101	/	/
Spectrum Analyzer	Key sight	N9010A	MY50210259	2019-05-19	2020-05-18
Universal Radio Communication Tester	Key sight	E5515C	MY48367192	2019-05-19	2020-05-18
Signal Analyzer	R&S	FSV30	100815	2018-12-16	2019-12-15
Loop Antenna	SCHWARZBECK	FMZB1519	1519-047	2017-09-26	2019-09-25
Trilog Antenna	SCHWARZBECK	VUBL 9163	9163-201	2017-11-18	2019-11-17
Horn Antenna	R&S	HF907	100126	2018-07-07	2020-07-06
Horn Antenna	ETS-Lindgren	3160-09	00102643	2018-06-20	2020-06-19
Signal generator	R&S	SMB 100A	102594	2019-05-19	2020-05-18
Climatic Chamber	ESPEC	SU-242	93000506	2017-12-17	2020-12-16
Preampfier	R&S	SCU18	102327	2019-05-19	2020-05-18
MOB COMMS DC SUPPLY	Keysight	66319D	MY43004105	2019-05-19	2020-05-18
RF Cable	Agilent	SMA 15cm	0001	2019-03-15	2019-06-14
RF Cable	Agilent	SMA 15cm	0001	2019-06-14	2019-09-13
Software	R&S	EMC32	9.26.0	/	/

*****END OF REPORT *****



ANNEX A: The EUT Appearance

The EUT Appearance are submitted separately.



ANNEX B: Test Setup Photos

The Test Setup Photos are submitted separately.



ANNEX C: Product Change Description

The Product Change Description are submitted separately.