



RF TEST REPORT

Applicant Doro AB
FCC ID WS5DFC0270
Product 4G Clamshell Smart Feature Phone
Brand Doro
Model DFC-0270
Report No. R2008A0539-R2
Issue Date September 25, 2020

TA Technology (Shanghai) Co., Ltd. tested the above equipment in accordance with the requirements in **FCC CFR47 Part 2 (2019)/ FCC CFR47 Part 27C (2019)**. The test results show that the equipment tested is capable of demonstrating compliance with the requirements as documented in this report.

Prepared by: Peng Tao

Approved by: Kai Xu

TA Technology (Shanghai) Co., Ltd.

No.145, Jintang Rd, Tangzhen Industry Park, Pudong Shanghai, China

TEL: +86-021-50791141/2/3

FAX: +86-021-50791141/2/3-8000



TABLE OF CONTENT

1	Test Laboratory.....	4
1.1	Notes of the Test Report.....	4
1.2	Test facility.....	4
1.3	Testing Location.....	4
2	General Description of Equipment under Test.....	5
3	Applied Standards.....	7
4	Test Configuration.....	8
5	Test Case Results.....	9
5.1	RF Power Output.....	9
5.2	Effective Isotropic Radiated Power.....	12
5.3	Occupied Bandwidth.....	16
5.4	Band Edge Compliance.....	22
5.5	Peak-to-Average Power Ratio (PAPR).....	30
5.6	Frequency Stability.....	32
5.7	Spurious Emissions at Antenna Terminals.....	35
5.8	Radiates Spurious Emission.....	42
6	Main Test Instruments.....	47

Summary of Measurement Results

Number	Test Case	Clause in FCC rules	Verdict
1	RF power output	2.1046	Refer to the original
2	Effective Isotropic Radiated power	27.50(h)(2)	Refer to the original
3	Occupied Bandwidth	2.1049	Refer to the original
4	Band Edge Compliance	27.53(m)	Refer to the original
5	Peak-to-Average Power Ratio	27.50(d)/KDB971168 D01(5.7)	Refer to the original
6	Frequency Stability	2.1055 / 27.54	Refer to the original
7	Spurious Emissions at Antenna Terminals	2.1051 /27.53(m)	Refer to the original
8	Radiates Spurious Emission	2.1053 /27.53(m)	PASS

Date of Testing: June 4, 2019~ June 17, 2019 and August 23, 2020 ~September 15, 2020

Note: PASS: The EUT complies with the essential requirements in the standard.

FAIL: The EUT does not comply with the essential requirements in the standard.

All indications of Pass/Fail in this report are opinions expressed by TA Technology (Shanghai) Co., Ltd. based on interpretations and/or observations of test results. Measurement Uncertainties were not taken into account and are published for informational purposes only.

DFC-0270 (Report No.: R2008A0539-R2) is a variant model of DFC-0270 (Report No.: R1905A0242-R2). Test values partial duplicated from Original for variant. There is only test Radiates Spurious Emission for variant in this report. The detailed product change description please refers to the *Product Change Description_Variant*.



1 Test Laboratory

1.1 Notes of the Test Report

This report shall not be reproduced in full or partial, without the written approval of **TA technology (shanghai) co., Ltd.** The results documented in this report apply only to the tested sample, under the conditions and modes of operation as described herein .Measurement Uncertainties were not taken into account and are published for informational purposes only. This report is written to support regulatory compliance of the applicable standards stated above.

1.2 Test facility

FCC (Designation number: CN1179, Test Firm Registration Number: 446626)

TA Technology (Shanghai) Co., Ltd. has been listed on the US Federal Communications Commission list of test facilities recognized to perform electromagnetic emissions measurements.

A2LA (Certificate Number: 3857.01)

TA Technology (Shanghai) Co., Ltd. has been listed by American Association for Laboratory Accreditation to perform electromagnetic emission measurement.

1.3 Testing Location

Company: TA Technology (Shanghai) Co., Ltd.
Address: No.145, Jintang Rd, Tangzhen Industry Park, Pudong Shanghai, China
City: Shanghai
Post code: 201201
Country: P. R. China
Contact: Xu Kai
Telephone: +86-021-50791141/2/3
Fax: +86-021-50791141/2/3-8000
Website: <http://www.ta-shanghai.com>
E-mail: xukai@ta-shanghai.com

2 General Description of Equipment under Test

Client Information

Applicant	Doro AB
Applicant address	Jörgen Kocksgatan 1B, SE 211 20 MALMÖ, SWEDEN
Manufacturer	Doro AB
Manufacturer address	Jörgen Kocksgatan 1B, SE 211 20 MALMÖ, SWEDEN

General information

EUT Description			
Model	DFC-0270		
IMEI	Original	IMEI 1:356755100011328 IMEI 2:356755100011336	
	Variant	IMEI 1:356755101510963 IMEI 2:356755101510971	
Hardware Version	V01C (HW code: 4011/4021/5011/5021/5031/5041)		
Software Version	DFC0270_VF292_N_S01A_V16_M200729_GCF		
Power Supply	Battery/AC adapter		
Antenna Type	Internal Antenna		
Antenna Gain	-1.0dBi		
Test Mode(s)	LTE Band 7;		
Test Modulation	(LTE)QPSK 16QAM;		
LTE Release	R9		
Maximum E.I.R.P./ E.R.P.	LTE Band 7:	22.00dBm	
Rated Power Supply Voltage:	3.8V		
Extreme Voltage	Minimum: 3.6V Maximum: 4.35V		
Extreme Temperature	Lowest: -10°C Highest: +55°C		
Operating Frequency Range(s)	Mode	Tx (MHz)	Rx (MHz)
	LTE Band 7	2500 ~ 2570	2620 ~ 2690
EUT Accessory			
Adapter 1	Manufacturer: TEN PAO INDUSTRIAL CO.,LTD Model: S003ATB0500055 (Halogen free)		
Adapter 2	Manufacturer: Dongguan Aohai Power Technology CO.,LTD Model: A31A-050055U-EU1(Halogen free)		
Adapter 3	Manufacturer: Dongguan Aohai Power Technology CO.,LTD Model: A806A-050100U-UK1(Halogen free)		
Adapter 4	Manufacturer: Dongguan Aohai Power Technology CO.,LTD Model: A2-501000(Halogen free)		
Adapter 5	Manufacturer: Shenzhen BaiJunDa ELECTRONIC CO.,Ltd		



	Model: UT-133E-5100
Adapter 6	Manufacturer: Mobewire Mobiles (Ningbo) Co.,Ltd Model: DFC-0240/0270 (Halogen free)
Battery 1	Manufacturer: NINGBO VEKEN BATTERY CO., LTD Model: DBX-1350A
Battery 2	Manufacturer: ZhongshanTianmao Battery Co., Ltd Model: DBX-1350B
Earphone 1	Manufacturer: Shenzhen Juwei Electronics Co.,Ltd Model: JWEP0944-M01R (Halogen free)
Earphone 2	Manufacturer: Shenzhen Juwei Electronics Co.,Ltd Model: JWEP0782-M01 (Halogen free)
USB Cable	Manufacturer: SHENZHEN FKY-QY HARDWARE ELECTRONIC CO.,LTD Model: M039B0800150 (Halogen free)
<p>Note: 1. The EUT is sent from the applicant to TA and the information of the EUT is declared by the applicant.</p> <p>2. There are more than one Adapter, Battery and Earphone, each one should be applied throughout the compliance test respectively, however, only the worst case (Adapter4,Battery1, Earphone1) will be recorded in this report.</p>	

Difference Configuration Statement						
Configuration	Configuration 1	Configuration 2	Configuration 3	Configuration 4	Configuration 5	Configuration 6
HW code	4011	4021	5011	5021	5031	5041
LCD	Sanlong Model: 28LS124-06 (IVO) 28QS195-03 (CTC)	Holitech Model: QTB2D8096	Sanlong Model: 28LS124-06 (IVO) 28QS195-03 (CTC)	Sanlong Model: 28LS124-06 (IVO) 28QS195-03 (CTC)	Holitech Model: QTB2D8096	Holitech Model: QTB2D8096
Flash	KSI Model: 04EMCP04-NL 3DM627	KSI Model: 04EMCP04-NL 3DM627	Nanya Model: NE1484KALAX A7-MD	KSI Model: 04EMCP04-NL 3DM627	Nanya Model: NE1484KALAX A7-MD	KSI Model: 04EMCP04-NL 3DM627
Other	The same	The same	The same	The same	The same	The same
<p>Note: There are more than one Configures, each one should be applied throughout the compliance test respectively, however, only the worst case will be recorded in this report.</p>						



3 Applied Standards

According to the specifications of the manufacturer, it must comply with the requirements of the following standards:

Test standards:

FCC CFR47 Part 27C (2019)

ANSI C63.26 (2015)

Reference standard:

FCC CFR47 Part 2 (2019)

KDB 971168 D01 Power Meas License Digital Systems v03r01

4 Test Configuration

Radiated measurements are performed by rotating the EUT in three different orthogonal test planes. EUT stand-up position (Z axis), lie-down position (X, Y axis). Receiver antenna polarization (horizontal and vertical), the worst emission was found in position (X axis, vertical polarization) and the worst case was recorded.

All mode and data rates and positions and RB size and modulations were investigated. Subsequently, only the worst case emissions are reported.

The following testing in LTE is set based on the maximum RF Output Power.

Test modes are chosen to be reported as the worst case configuration below for LTE Band 7:

Test items	Modes	Bandwidth (MHz)				Modulation		RB			Test Channel		
		5	10	15	20	QPSK	16QAM	1	50%	100%	L	M	H
RF power output	LTE 7	O	O	O	O	O	O	O	O	O	O	O	O
Effective Isotropic Radiated power	LTE 7	O	O	O	O	O	O	O	O	O	O	O	O
Occupied Bandwidth	LTE 7	O	O	O	O	O	O	-	-	O	O	O	O
Band Edge Compliance	LTE 7	O	O	O	O	O	O	O	-	O	O	-	O
Peak-to-Average Power Ratio	LTE 7	O	O	O	O	O	O	-	-	O	O	O	O
Frequency Stability	LTE 7	O	O	O	O	O	O	O	O	O	O	O	O
Spurious Emissions at Antenna Terminals	LTE 7	O	O	O	O	O	-	O	-	-	O	O	O
Radiates Spurious Emission	LTE 7	O	-	O	O	O	-	O	-	-	O	O	O
Note	1. The mark "O" means that this configuration is chosen for testing. 2. The mark "-" means that this configuration is not testing.												

5 Test Case Results

5.1 RF Power Output

Ambient condition

Temperature	Relative humidity	Pressure
23°C ~25°C	45%~50%	101.5kPa

Methods of Measurement

During the process of the testing, The EUT is controlled by the Base Station Simulator to ensure max power transmission and proper modulation.

Test Setup

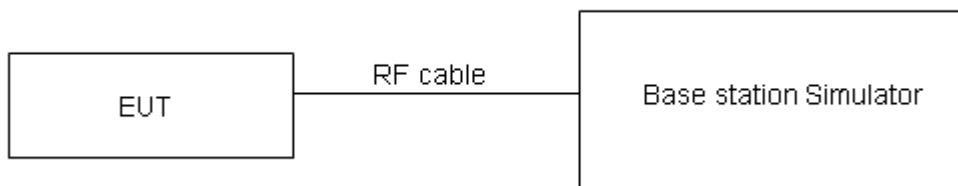

The loss between RF output port of the EUT and the input port of the tester has been taken into consideration.

Limits

No specific RF power output requirements in part 2.1046.

Measurement Uncertainty

The assessed measurement uncertainty to ensure 95% confidence level for the normal distribution is with the coverage factor $k = 2$, $U=0.4$ dB.



Test Results

Original

LTE Band 7				Conducted Power(dBm)		
Bandwidth	Modulation	RB size	RB offset	Channel/Frequency (MHz)		
				20775/2502.5	21100/2535	21425/2567.5
5MHz	QPSK	1	0	21.22	21.47	21.12
		1	13	21.74	21.81	21.53
		1	24	21.35	21.57	21.14
		12	0	20.51	20.99	20.54
		12	6	20.73	21.06	20.61
		12	13	20.81	21.01	20.49
		25	0	20.59	21.04	20.55
	16QAM	1	0	20.75	20.97	20.67
		1	13	20.88	21.15	20.89
		1	24	20.68	20.81	20.58
		12	0	19.46	19.67	19.42
		12	6	19.64	19.54	19.52
		12	13	19.65	19.51	19.48
		25	0	19.54	19.50	19.38
Bandwidth	Modulation	RB size	RB offset	Channel/Frequency (MHz)		
				20800/2505	21100/2535	21400/2565
10MHz	QPSK	1	0	21.24	21.48	21.15
		1	25	21.77	21.86	21.57
		1	49	21.37	21.61	21.17
		25	0	20.54	21.04	20.58
		25	13	20.76	21.11	20.65
		25	25	20.83	21.05	20.54
		50	0	20.67	21.06	20.59
	16QAM	1	0	20.77	21.00	20.69
		1	25	20.91	21.19	20.92
		1	49	20.71	20.83	20.61
		25	0	19.49	19.72	19.46
		25	13	19.66	19.58	19.55
		25	25	19.68	19.56	19.52
		50	0	19.57	19.55	19.42
Bandwidth	Modulation	RB size	RB offset	Channel/Frequency (MHz)		
				20825/2507.5	21100/2535	21375/2562.5
15MHz	QPSK	1	0	21.23	21.44	21.13
		1	38	21.75	21.85	21.54
		1	74	21.34	21.56	21.13
		36	0	20.52	21.00	20.55
		36	18	20.73	21.06	20.61



Bandwidth	Modulation	RB size	RB offset	Channel/Frequency (MHz)		
				20850/2510	21100/2535	21350/2560
	16QAM	36	39	20.80	21.02	20.50
		75	0	20.65	21.02	20.54
		1	0	20.72	20.98	20.67
		1	38	20.89	21.16	20.90
		1	74	20.68	20.79	20.58
		36	0	19.46	19.70	19.43
		36	18	19.63	19.53	19.51
		36	39	19.66	19.52	19.49
		75	0	19.54	19.50	19.38
		20MHz	QPSK	1	0	21.20
1	50			21.74	21.81	21.52
1	99			21.32	21.55	21.10
50	0			20.49	20.95	20.51
50	25			20.71	21.02	20.58
50	50			20.77	20.97	20.46
100	0			20.62	20.97	20.50
16QAM	1		0	20.70	20.94	20.62
	1		50	20.85	21.14	20.86
	1		99	20.66	20.76	20.56
	50		0	19.43	19.66	19.40
	50		25	19.60	19.51	19.48
	50		50	19.63	19.47	19.45
	100		0	19.52	19.46	19.35

5.2 Effective Isotropic Radiated Power

Ambient condition

Temperature	Relative humidity	Pressure
23°C ~25°C	45%~50%	101.5kPa

Methods of Measurement

1. The testing follows FCC KDB 971168 D01 v03r01 Section 5.8 and ANSI C63.26 (2015).

- a) Connect the equipment as illustrated. Mount the equipment with the manufacturer specified antenna in a vertical orientation on a manufacturer specified mounting surface located on a non-conducting rotating platform of a RF anechoic chamber (preferred) or a standard radiation site.
- b) Key the transmitter, then rotate the EUT 360° azimuthally and record spectrum analyzer power level (LVL) measurements at angular increments that are sufficiently small to permit resolution of all peaks. If a standard radiation test site is used, raise and lower the test antenna to obtain a maximum reading at each angular increment. (Note: several batteries may be needed to offset the effect of battery voltage droop, which should not exceed 5% of the manufactured specified battery voltage during transmission).
- c) Replace the transmitter under test with a vertically polarized half-wave dipole (or an antenna whose gain is known relative to an ideal half-wave dipole). The center of the antenna should be at the same location as the center of the antenna under test.
- d) Connect the antenna to a signal generator with a known output power and record the path loss (in dB) as LOSS. If a standard radiation test site is used, raise and lower the test antenna to obtain a maximum reading. $LOSS = \text{Generator Output Power (dBm)} - \text{Analyzer reading (dBm)}$
- e) Determine the effective radiated output power at each angular position from the readings in steps b) and d) using the following equation: $ERP \text{ (dBm)} = \text{LVL (dBm)} + \text{LOSS (dB)}$
- f) The maximum ERP is the maximum value determined in the preceding step.
- g) When calculating ERP, in addition to knowing the antenna radiation and matching characteristics, it is necessary to know the loss values of all elements (e.g. transmission line attenuation, mismatches, filters, combiners) interposed between the point where transmitter output power is measured, and the point where power is applied to the antenna. ERP can then be calculated as follows:
 $EIRP \text{ (dBm)} = \text{Output Power (dBm)} - \text{Losses (dB)} + \text{Antenna Gain (dBi)}$
where: dBd refers to gain relative to an ideal dipole.
 $EIRP \text{ (dBm)} = ERP \text{ (dBm)} + 2.15 \text{ (dB.)}$

The RB allocation refers to section 5.1, using the maximum output power configuration.

Test setup

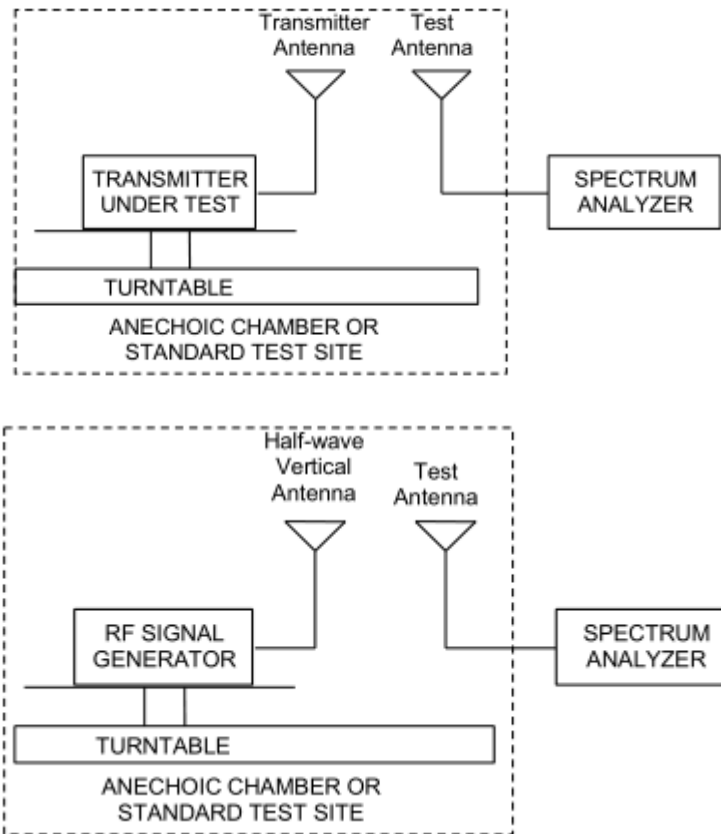

Note: Area side:2.4mX3.6m

The radiated emission was measured in the following position: EUT stand-up position (Z axis), lie-down position (X, Y axis). The worst emission was found in stand-up position (Z axis) and the worst case was recorded.

**Limits**

Rule Part 27.50(h) (2) specifies that “Mobile and other user stations. Mobile stations are limited to 2.0 watts EIRP. All user stations are limited to 2.0 watts transmitter output power.”

Part 27.50(h)(2) Limit	$\leq 2 \text{ W}$ (33 dBm)
------------------------	-----------------------------

Measurement Uncertainty

The assessed measurement uncertainty to ensure 95% confidence level for the normal distribution is with the coverage factor $k = 2$, $U = 1.19 \text{ dB}$

**Test Results**

The measurement is performed for both of horizontal and vertical antenna Polarization, and only the data of worst mode is recorded in this report.

Original

LTE Band 7						
Band width	Channel	Frequency (MHz)	Polarization	EIRP (dBm)	Limit (dBm)	Conclusion
5 MHz (QPSK)	Low	2502.5	Horizontal	21.84	33	Pass
	Mid	2535	Horizontal	21.65	33	Pass
	High	2567.5	Horizontal	21.87	33	Pass
10 MHz (QPSK)	Low	2505	Horizontal	22.00	33	Pass
	Mid	2535	Horizontal	21.56	33	Pass
	High	2565	Horizontal	21.92	33	Pass
15 MHz (QPSK)	Low	2507.5	Horizontal	21.99	33	Pass
	Mid	2535	Horizontal	21.68	33	Pass
	High	2562.5	Horizontal	21.94	33	Pass
20 MHz (QPSK)	Low	2510	Horizontal	21.85	33	Pass
	Mid	2535	Horizontal	21.72	33	Pass
	High	2560	Horizontal	21.65	33	Pass
5 MHz (16QAM)	Low	2502.5	Horizontal	21.19	33	Pass
	Mid	2535	Horizontal	21.08	33	Pass
	High	2567.5	Horizontal	21.23	33	Pass
10 MHz (16QAM)	Low	2505	Horizontal	21.46	33	Pass
	Mid	2535	Horizontal	21.05	33	Pass
	High	2565	Horizontal	21.36	33	Pass
15 MHz (16QAM)	Low	2507.5	Horizontal	21.42	33	Pass
	Mid	2535	Horizontal	21.16	33	Pass
	High	2562.5	Horizontal	21.44	33	Pass
20 MHz (16QAM)	Low	2510	Horizontal	21.38	33	Pass
	Mid	2535	Horizontal	21.21	33	Pass
	High	2560	Horizontal	21.07	33	Pass

5.3 Occupied Bandwidth

Ambient condition

Temperature	Relative humidity	Pressure
23°C ~25°C	45%~50%	101.5kPa

Method of Measurement

The EUT was connected to Spectrum Analyzer and Base Station Simulator via power Splitter. The occupied bandwidth is measured using spectrum analyzer.

RBW is set to 100 kHz, VBW is set to 300 kHz for LTE Band 7(5MHz).

RBW is set to 300 kHz, VBW is set to 1MHz for LTE Band 7(10MHz/15MHz/20MHz).

99% power and -26dBc occupied bandwidths are recorded. Spectrum analyzer plots are included on the following pages.

Test Setup

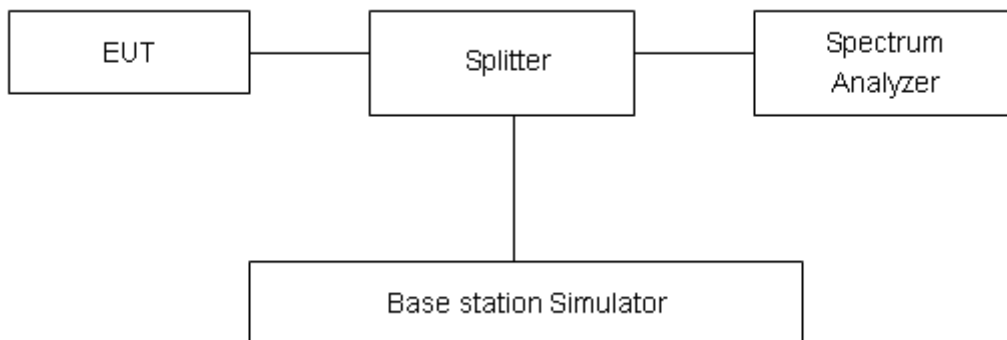

Limits

No specific occupied bandwidth requirements in part 2.1049.

Measurement Uncertainty

The assessed measurement uncertainty to ensure 95% confidence level for the normal distribution is with the coverage factor $k = 2$, $U=624\text{Hz}$.



Test Result

Original

LTE Band 7						
RB	Modulation	Bandwidth (MHz)	Channel	Frequency (MHz)	99% Power Bandwidth(MHz)	-26dBc Bandwidth(MHz)
100%	QPSK	5	20775	2502.5	4.5455	5.188
			21100	2535	4.5239	5.190
			21425	2567.5	4.5230	5.138
		10	20800	2505	9.0961	10.430
			21100	2535	9.0650	10.370
			21400	2565	9.1006	10.350
		15	20825	2507.5	13.5250	15.020
			21100	2535	13.4850	14.960
			21375	2562.5	13.5000	14.990
		20	20850	2510	17.8980	19.410
			21100	2535	17.9300	19.590
			21350	2560	17.9200	19.540
	16QAM	5	20775	2502.5	4.5282	5.200
			21100	2535	4.5424	5.216
			21425	2567.5	4.5582	5.255
		10	20800	2505	9.0884	10.200
			21100	2535	9.0855	10.360
			21400	2565	9.0984	10.280
		15	20825	2507.5	13.5060	14.970
			21100	2535	13.5350	15.030
			21375	2562.5	13.5180	15.030
		20	20850	2510	17.8870	19.440
			21100	2535	17.9470	19.860
			21350	2560	17.9230	19.500



Original

LTE Band 7 QPSK 5MHz CH-Low

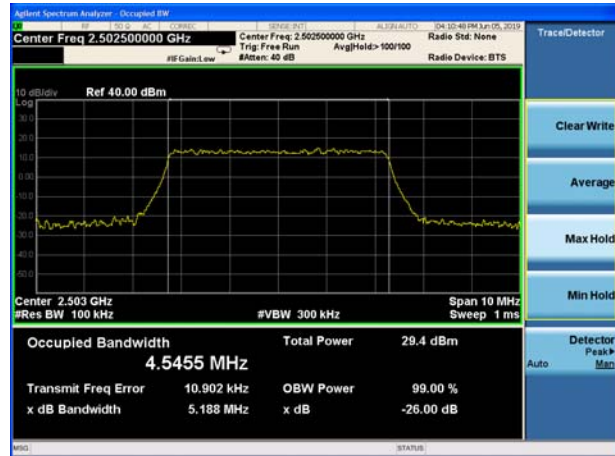

LTE Band 7 QPSK 10MHz CH-Low

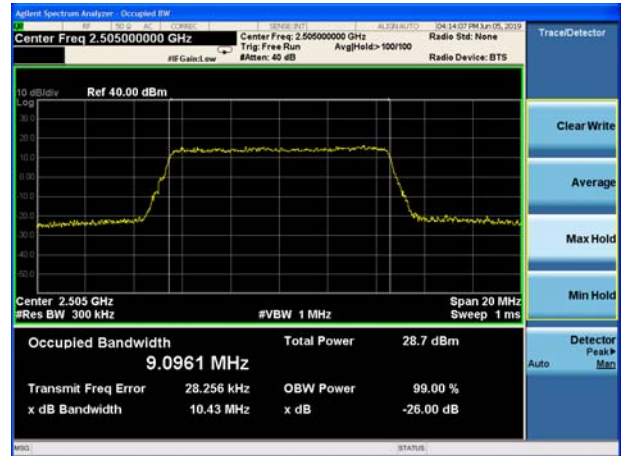

LTE Band 7 QPSK 5MHz CH-Middle

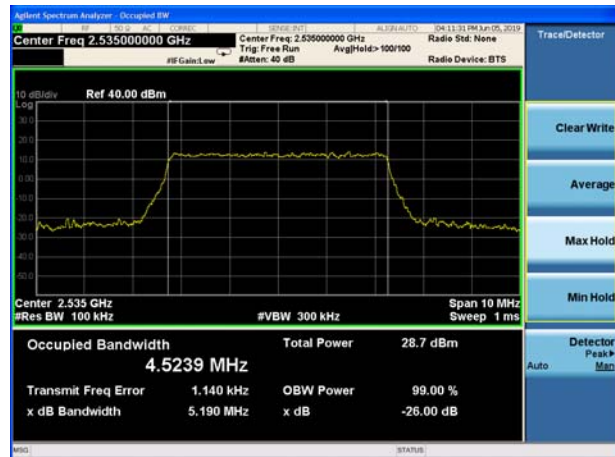

LTE Band 7 QPSK 10MHz CH-Middle



LTE Band 7 QPSK 5MHz CH-High

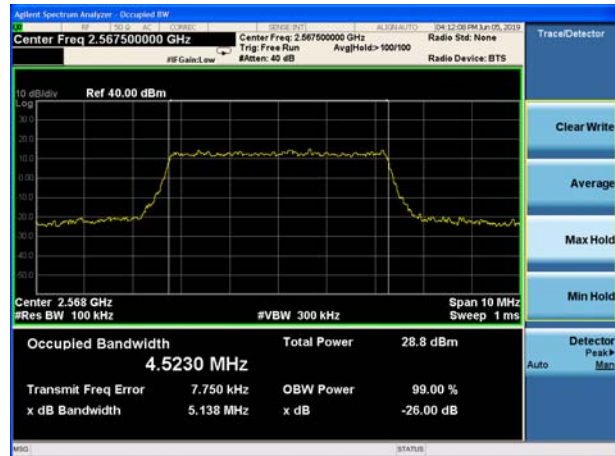

LTE Band 7 QPSK 10MHz CH-High



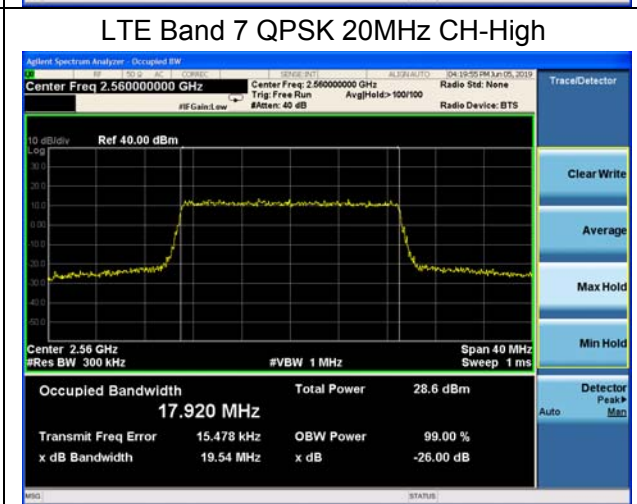
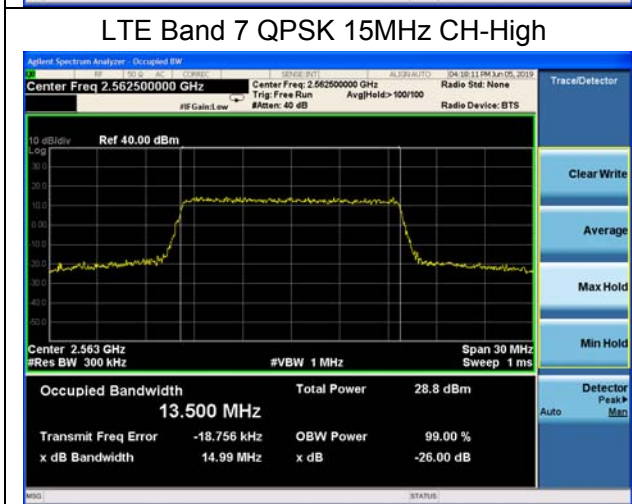
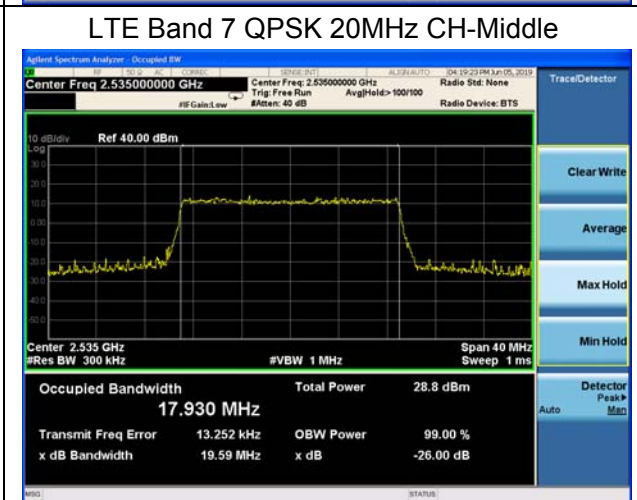
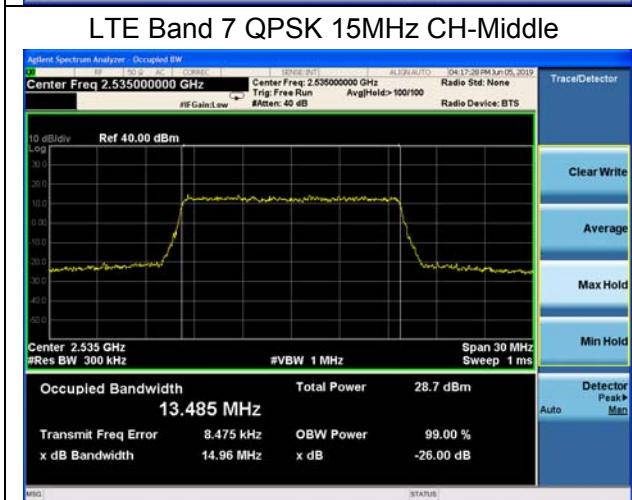
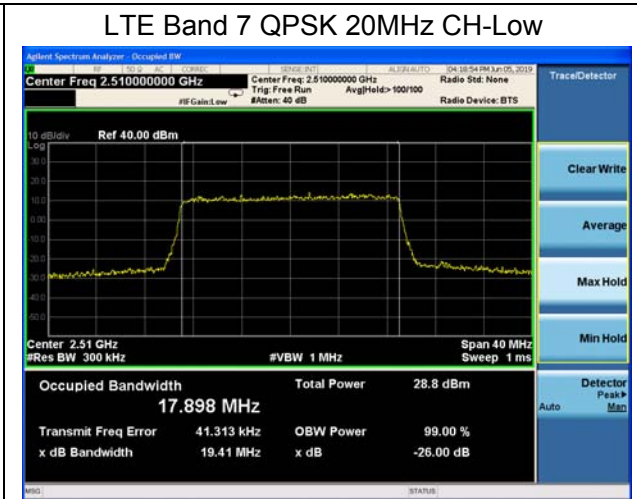
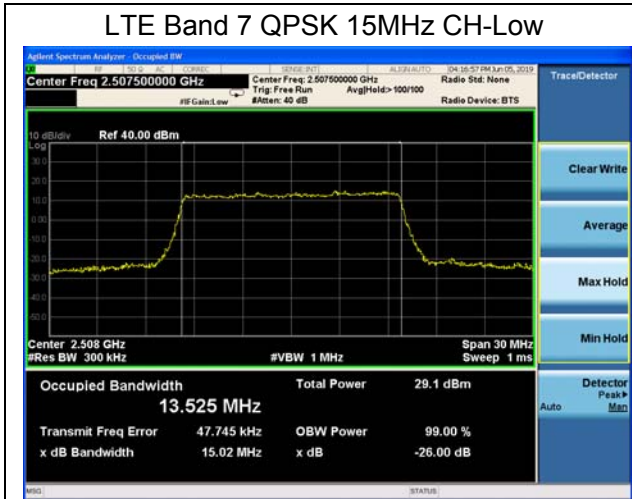

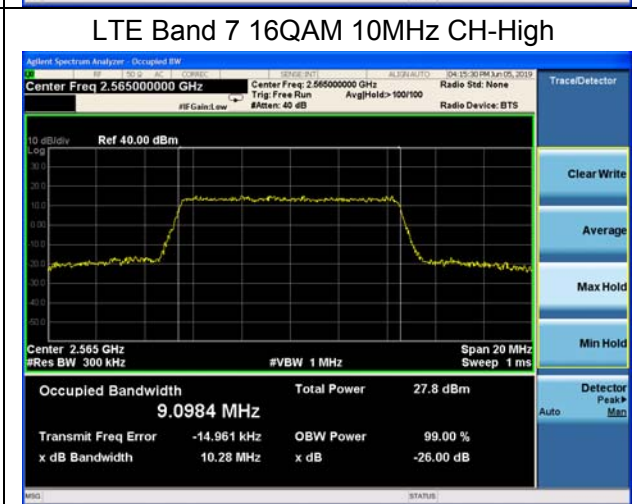
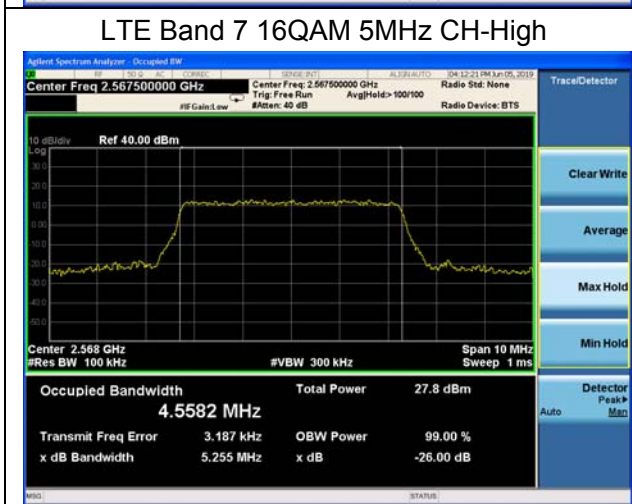
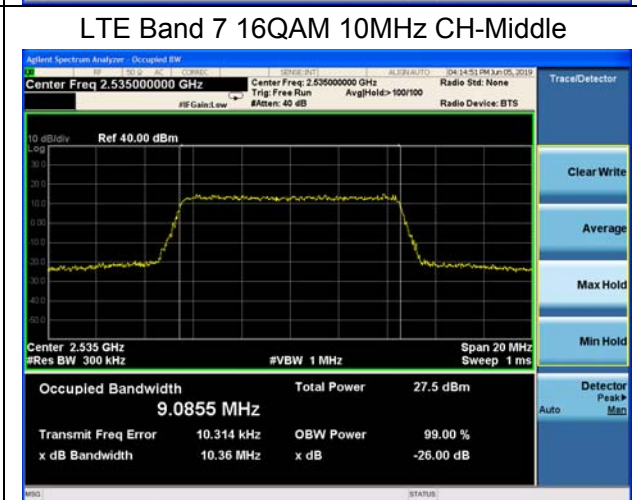
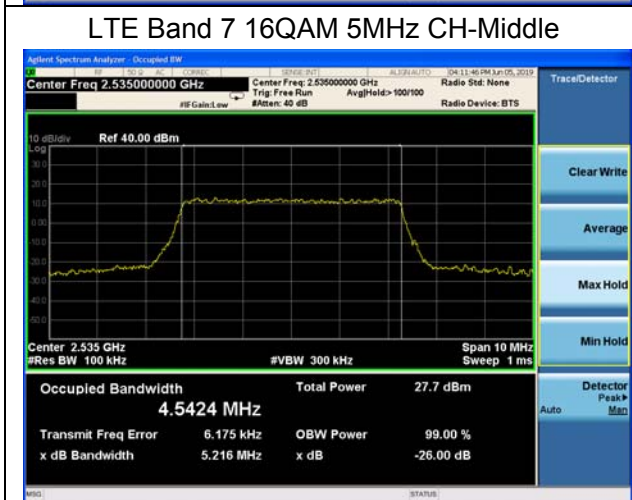
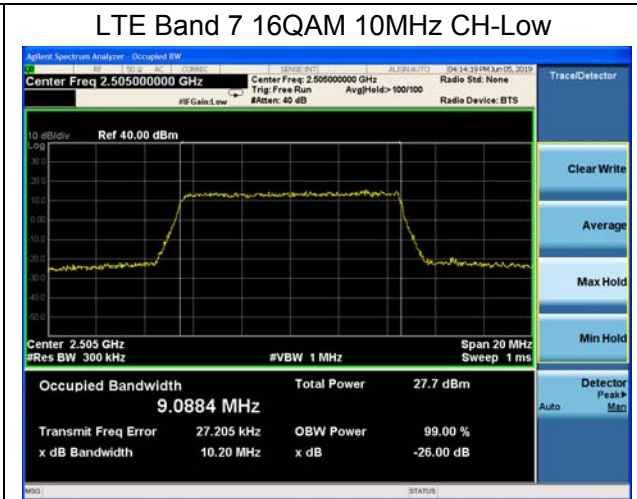
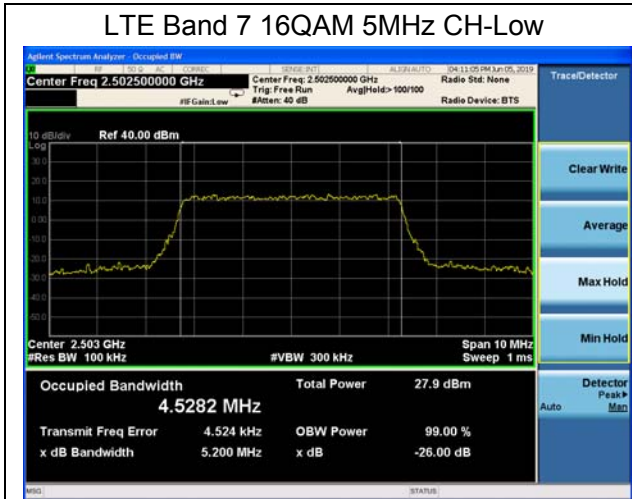

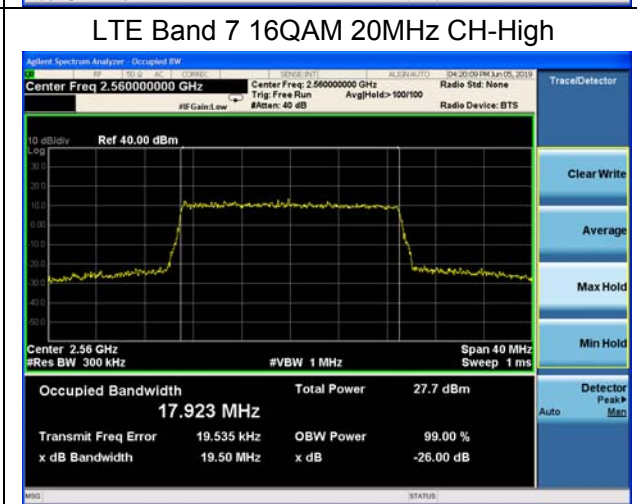
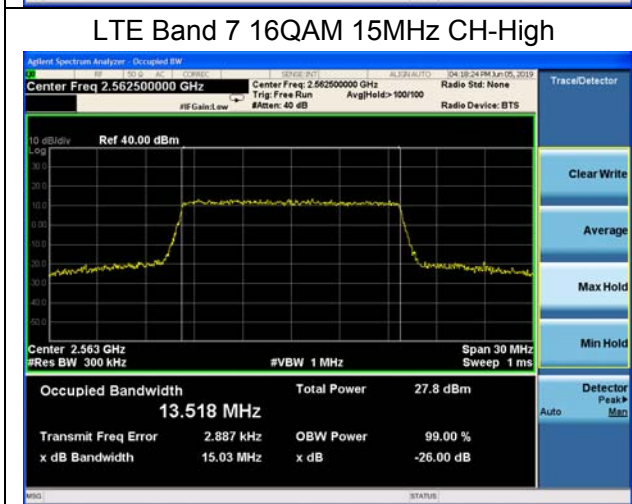
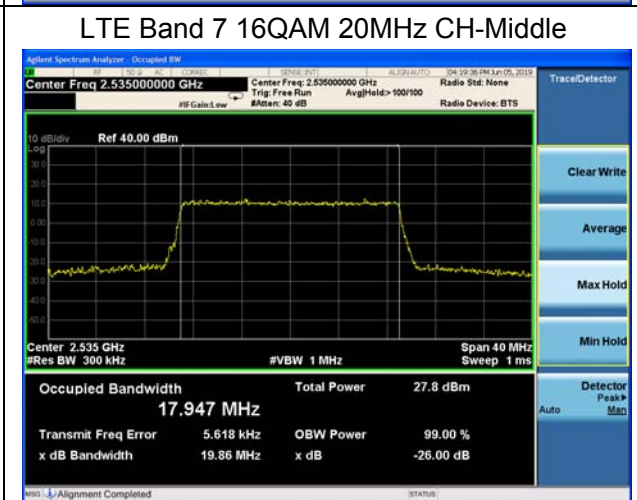
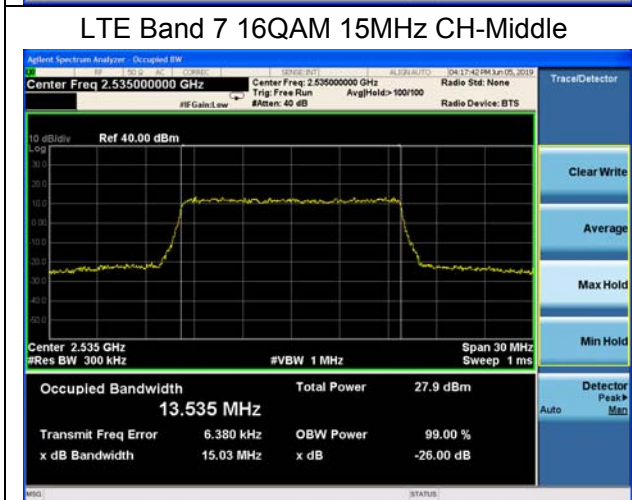
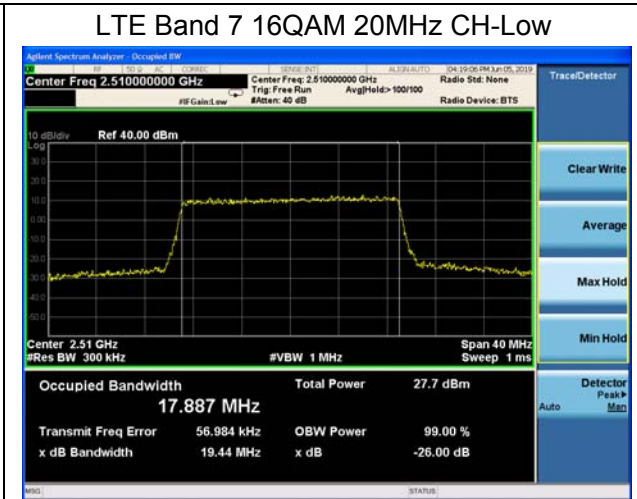
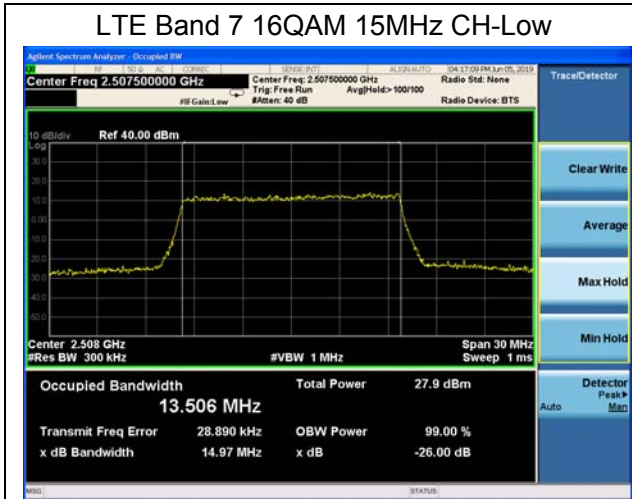

5.4 Band Edge Compliance

Ambient condition

Temperature	Relative humidity	Pressure
23°C ~25°C	45%~50%	101.5kPa

Method of Measurement

The EUT was connected to Spectrum Analyzer and Base Station Simulator via power Splitter. The band edge of the lowest and highest channels were measured.

The testing follows KDB 971168 D01 v03r01 Section 6.0

The EUT was connected to spectrum analyzer and system simulator via a power divider.

The band edges of low and high channels for the highest RF powers were measured.

RBW is set to 50 kHz, VBW is set to 200 kHz for LTE Band 7(5MHz).

RBW is set to 100 kHz, VBW is set to 300kHz for LTE Band 7(10MHz).

RBW is set to 200 kHz, VBW is set to 1MHz for LTE Band 7 (15MHz/ 20MHz).

on spectrum analyzer.

Set spectrum analyzer with RMS detector.

The RF fundamental frequency should be excluded against the limit line in the operating frequency band.

Checked that all the results comply with the emission limit line.

Test Setup

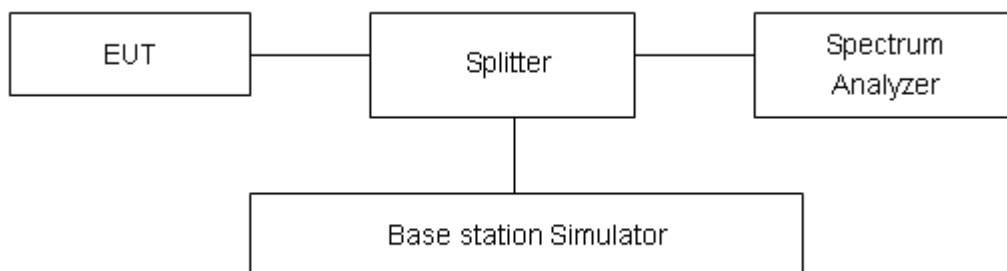

Limits

Rule Part 27.53(m) (4)/ specifies that “for BRS and EBS stations. For mobile digital stations, the attenuation factor shall be not less than $40 + 10 \log (P)$ dB on all frequencies between the channel edge and 5 megahertz from the channel edge, $43 + 10 \log (P)$ dB on all frequencies between 5 megahertz and X megahertz from the channel edge, and $55 + 10 \log (P)$ dB on all frequencies more than X megahertz from the channel edge, where X is the greater of 6 megahertz or the actual emission bandwidth as defined in paragraph (m)(4) of this section. In addition, the attenuation factor shall not be less that $43 + 10 \log (P)$ dB on all frequencies between 2490.5 MHz and 2496 MHz and



55 + 10 log (P) dB at or below 2490.5 MHz. Mobile Satellite Service licensees operating on frequencies below 2495 MHz may also submit a documented interference complaint against BRS licensees operating on channel BRS Channel 1 on the same terms and conditions as adjacent channel BRS or EBS licensees.

Example:

The limit line is derived from 43 + 10log (P) dB below the transmitter power P(Watts)

$$= P(W) - [43 + 10\log(P)] \text{ (dB)}$$

$$= [30 + 10\log (P)] \text{ (dBm)} - [43 + 10\log(P)] \text{ (dB)} = -13\text{dBm}.$$

Measurement Uncertainty

The assessed measurement uncertainty to ensure 95% confidence level for the normal distribution is with the coverage factor $k = 1.96$, $U=0.684\text{dB}$.



Test Result

All the test traces in the plots shows the test results clearly.

Original

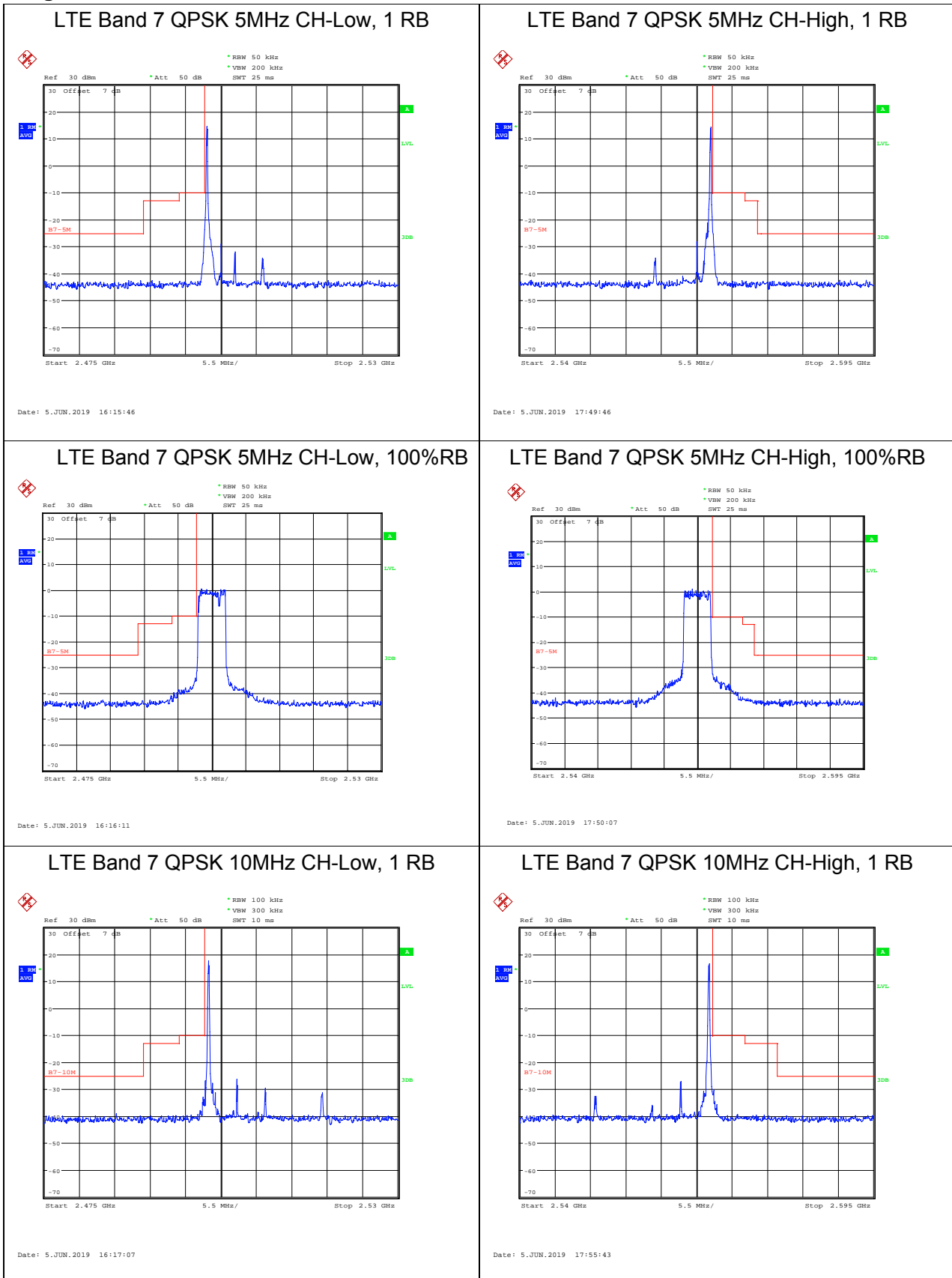



LTE Band 7 QPSK 10MHz CH-Low, 100%RB

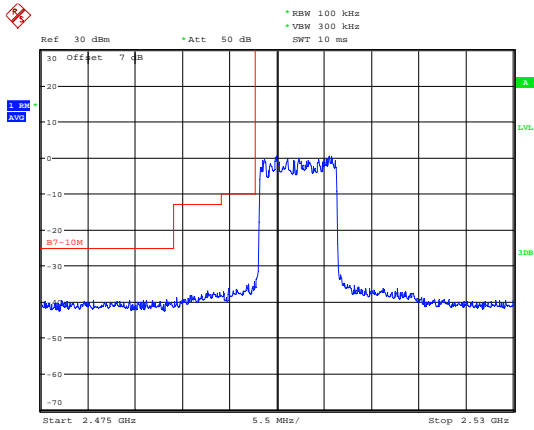

Date: 5 JUN 2019 16:17:32

LTE Band 7 QPSK 10MHz CH-High, 100%RB

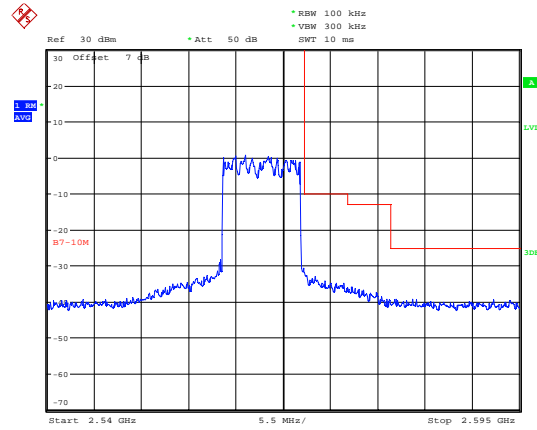

Date: 5 JUN 2019 17:56:04

LTE Band 7 QPSK 15MHz CH-Low, 1 RB

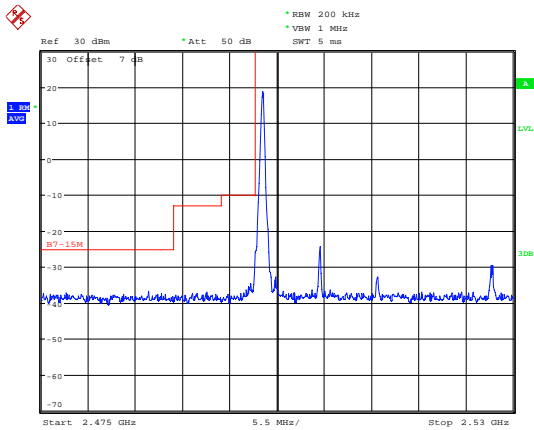

Date: 5 JUN 2019 16:32:36

LTE Band 7 QPSK 15MHz CH-High, 1 RB

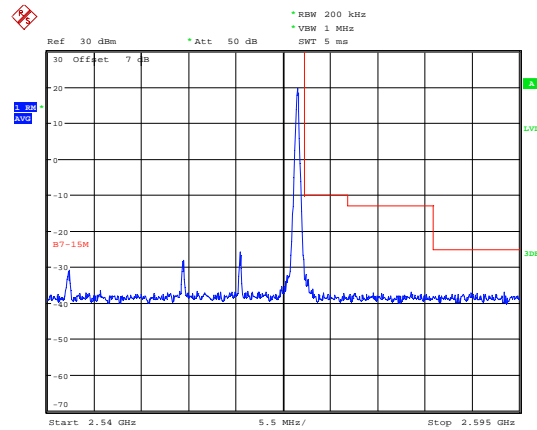

Date: 5 JUN 2019 17:28:48

LTE Band 7 QPSK 15MHz CH-Low, 100%RB

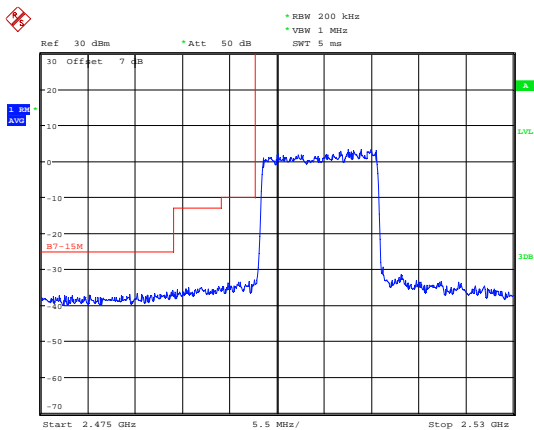

Date: 5 JUN 2019 16:32:56

LTE Band 7 QPSK 15MHz CH-High, 100%RB

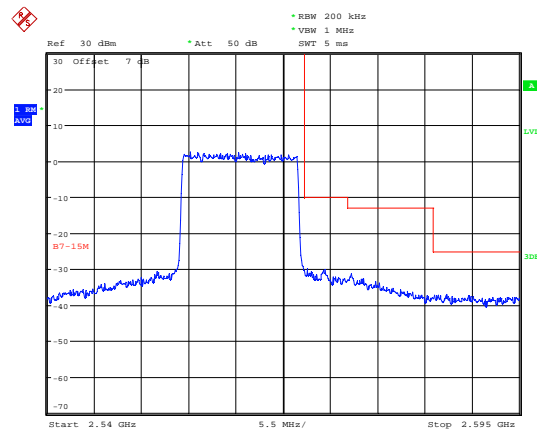

Date: 5 JUN 2019 17:29:13



LTE Band 7 QPSK 20MHz CH-Low, 1 RB

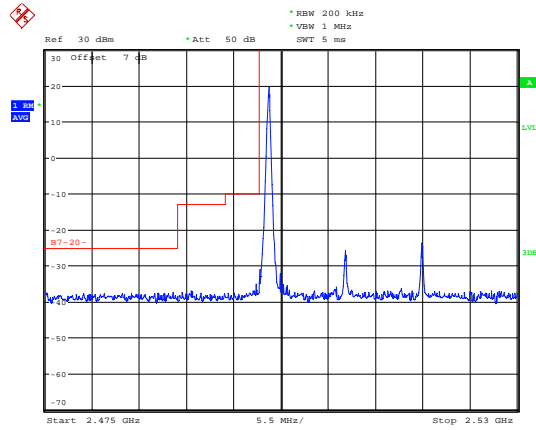

Date: 5 JUN 2019 17:25:17

LTE Band 7 QPSK 20MHz CH-High, 1 RB

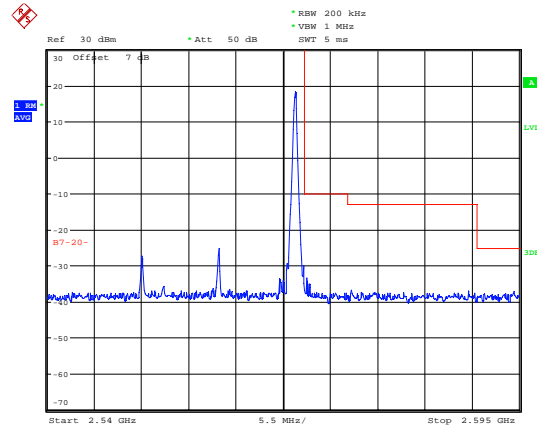

Date: 5 JUN 2019 17:27:43

LTE Band 7 QPSK 20MHz CH-Low, 100%RB

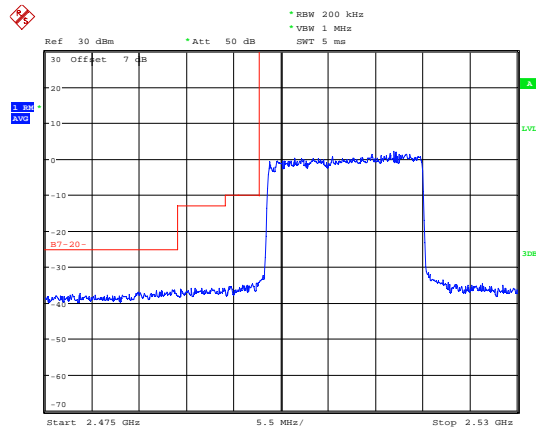

Date: 5 JUN 2019 17:25:37

LTE Band 7 QPSK 20MHz CH-High, 100%RB

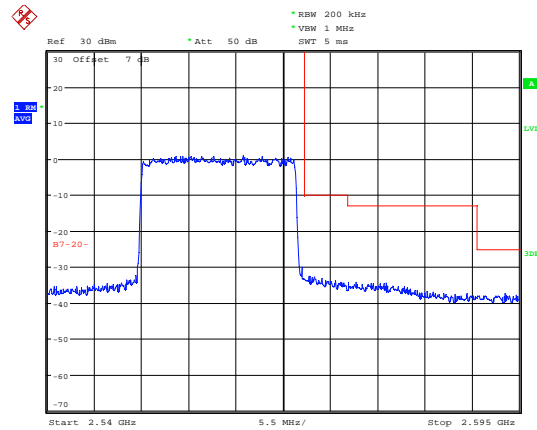

Date: 5 JUN 2019 17:28:05

LTE Band 7 16QAM 5MHz CH-Low, 1 RB

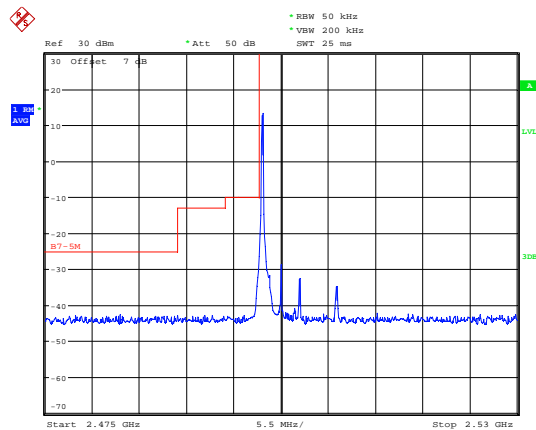

Date: 5 JUN 2019 16:15:59

LTE Band 7 16QAM 5MHz CH-High, 1 RB

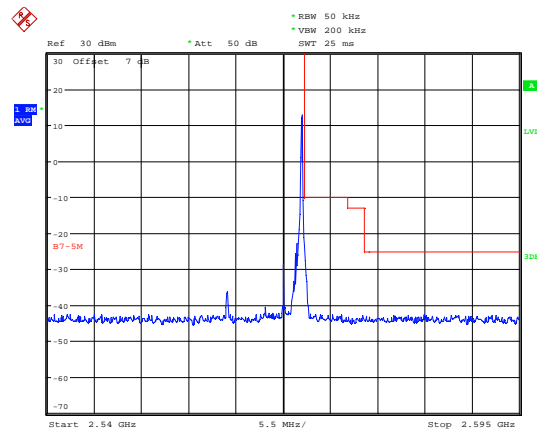

Date: 5 JUN 2019 17:49:54



LTE Band 7 16QAM 5MHz CH-Low, 100%RB

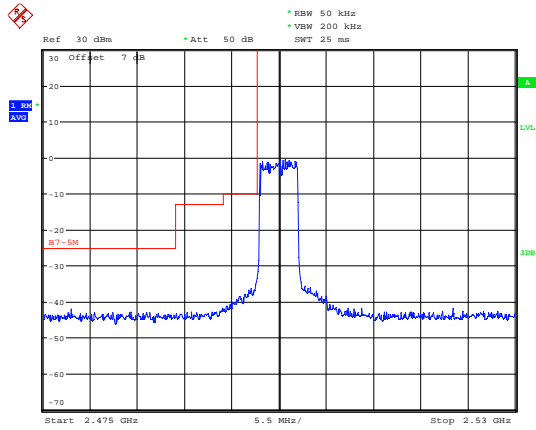

Date: 5 JUN 2019 16:16:23

LTE Band 7 16QAM 5MHz CH-High, 100%RB

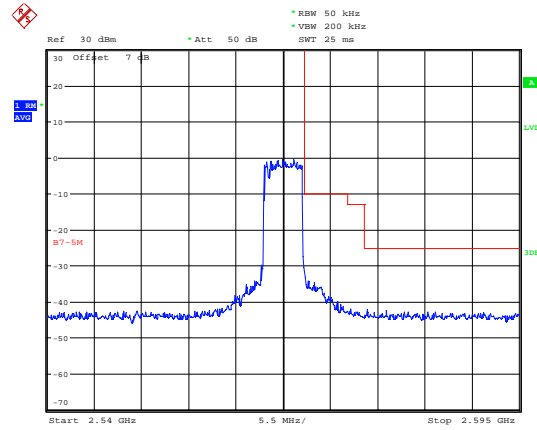

Date: 5 JUN 2019 17:55:05

LTE Band 7 16QAM 10MHz CH-Low, 1 RB

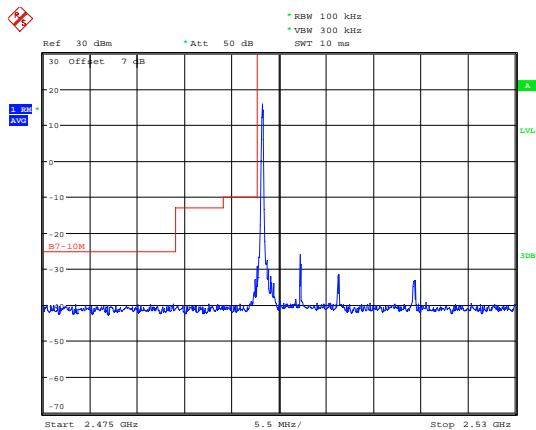

Date: 5 JUN 2019 16:17:18

LTE Band 7 16QAM 10MHz CH-High, 1 RB

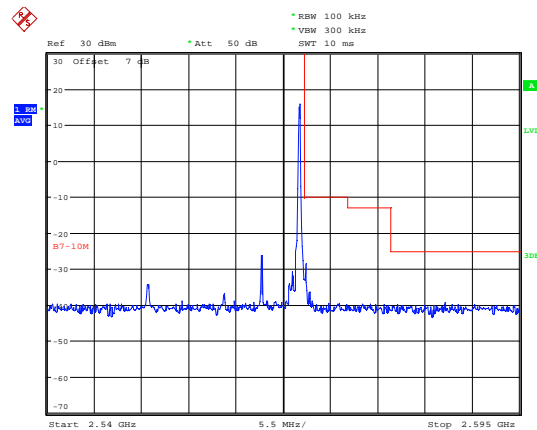

Date: 5 JUN 2019 17:55:52

LTE Band 7 16QAM 10MHz CH-Low, 100%RB

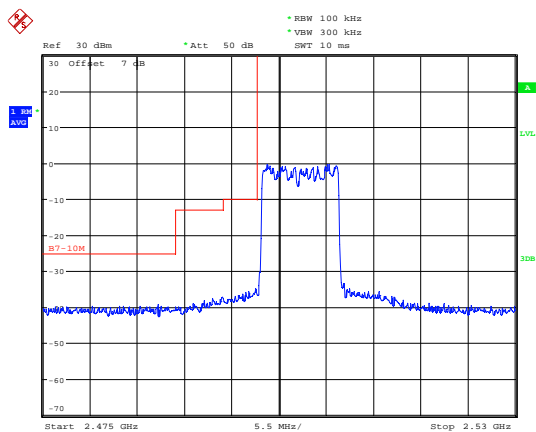

Date: 5 JUN 2019 16:17:42

LTE Band 7 16QAM 10MHz CH-High, 100%RB

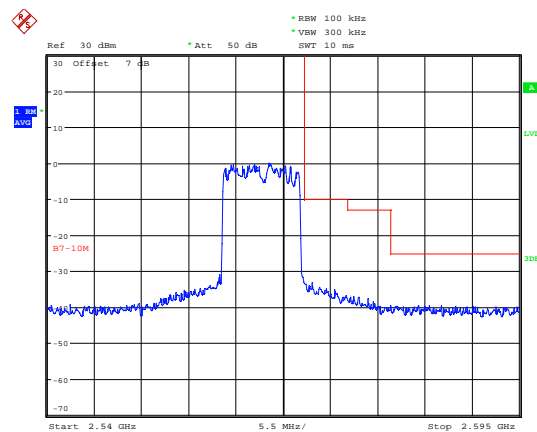

Date: 5 JUN 2019 17:56:14



LTE Band 7 16QAM 15MHz CH-Low, 1 RB

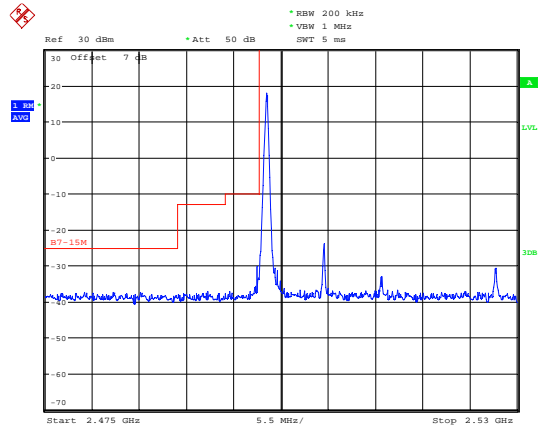

Date: 5 JUN 2019 16:32:45

LTE Band 7 16QAM 15MHz CH-High, 1 RB

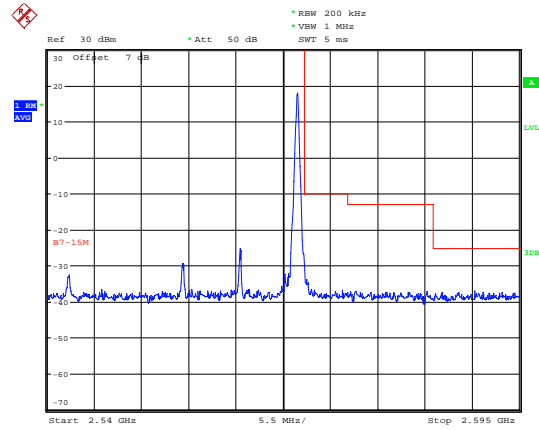

Date: 5 JUN 2019 17:28:59

LTE Band 7 16QAM 15MHz CH-Low, 100%RB

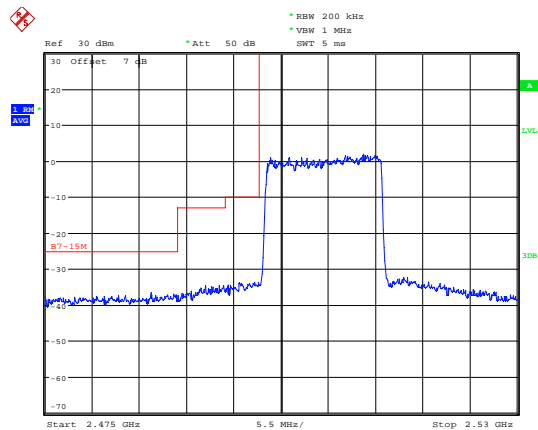

Date: 5 JUN 2019 16:33:05

LTE Band 7 16QAM 15MHz CH-High, 100%RB

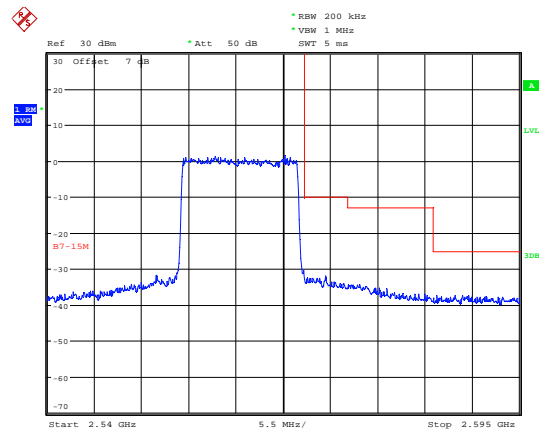

Date: 5 JUN 2019 17:29:24

LTE Band 7 16QAM 20MHz CH-Low, 1 RB

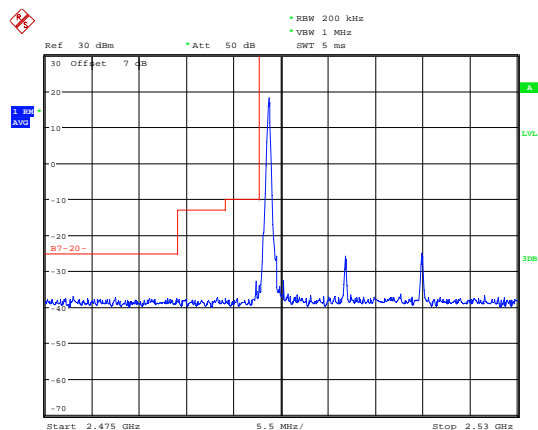

Date: 5 JUN 2019 17:25:26

LTE Band 7 16QAM 20MHz CH-High, 1 RB

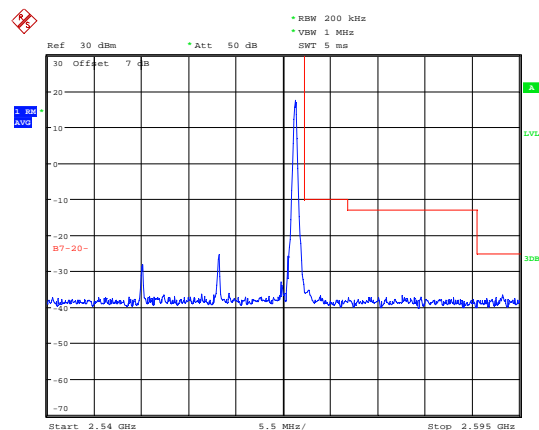

Date: 5 JUN 2019 17:27:54



LTE Band 7 16QAM 20MHz CH-Low, 100%RB

LTE Band 7 16QAM 20MHz CH-High, 100%RB

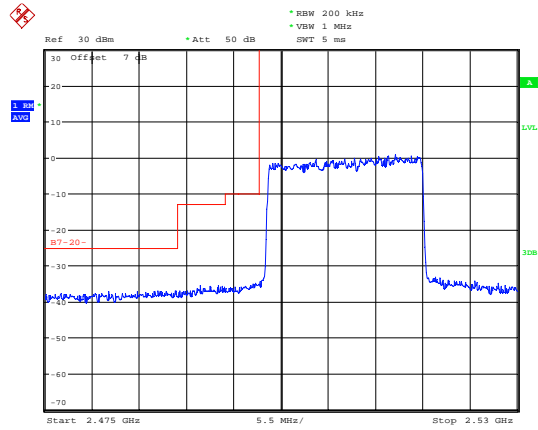

Date: 5 JUN 2019 17:25:45

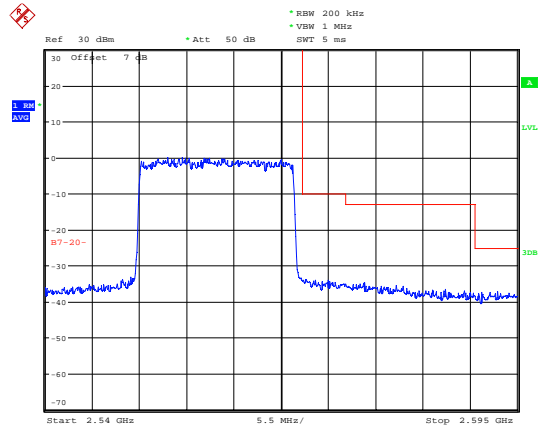

Date: 5 JUN 2019 17:28:16

5.5 Peak-to-Average Power Ratio (PAPR)

Ambient condition

Temperature	Relative humidity	Pressure
23°C ~25°C	45%~50%	101.5kPa

Methods of Measurement

Measure the total peak power and record as PPK. And measure the total average power and record as PAvg. Both the peak and average power levels must be expressed in the same logarithmic units (e.g., dBm). Determine the PAPR from:

$$PAPR (dB) = PPK (dBm) - PAvg (dBm).$$

Test Setup

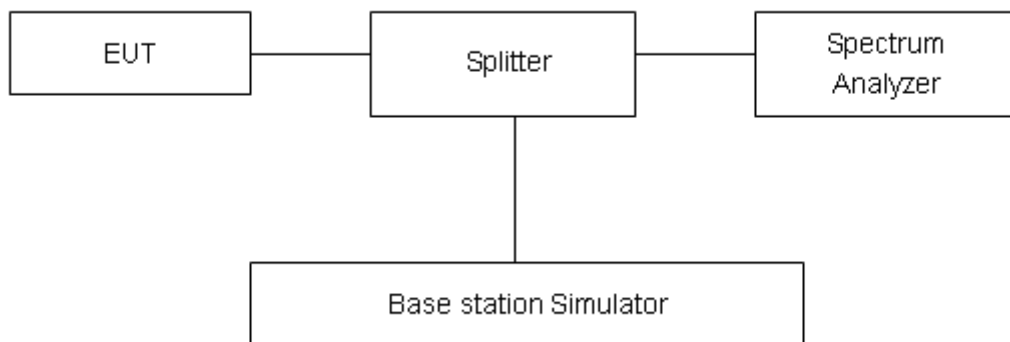

Limits

Rule Part 27.50(d)(5) Equipment employed must be authorized in accordance with the provisions of 24.51. Power measurements for transmissions by stations authorized under this section may be made either in accordance with a Commission-approved average power technique or in compliance with paragraph (d)(6) of this section. In measuring transmissions in this band using an average power technique, the peak-to-average ratio (PAR) of the transmission may not exceed 13 dB.

Measurement Uncertainty

The assessed measurement uncertainty to ensure 95% confidence level for the normal distribution is with the coverage factor $k = 2$, $U = 0.4$ dB.



Test Results

Original

LTE Band 7								
Modulation	Bandwidth (MHz)	Channel	Frequency (MHz)	Peak (dBm)	Avg (dBm)	PAPR (dB)	Limit (dB)	Conclusion
QPSK	5	20775	2502.5	25.49	19.86	5.63	≤13	PASS
		21100	2535	25.40	19.72	5.68	≤13	PASS
		21425	2567.5	25.05	19.92	5.13	≤13	PASS
	10	20800	2505	25.45	19.89	5.56	≤13	PASS
		21100	2535	25.39	19.73	5.66	≤13	PASS
		21400	2565	25.00	19.92	5.08	≤13	PASS
	15	20825	2507.5	25.49	19.83	5.66	≤13	PASS
		21100	2535	25.53	19.70	5.83	≤13	PASS
		21375	2562.5	24.93	19.88	5.05	≤13	PASS
	20	20850	2510	25.16	19.79	5.37	≤13	PASS
		21100	2535	25.29	19.70	5.59	≤13	PASS
		21350	2560	24.87	19.69	5.18	≤13	PASS
16QAM	5	20775	2502.5	25.17	18.85	6.32	≤13	PASS
		21100	2535	25.11	18.71	6.40	≤13	PASS
		21425	2567.5	24.79	18.90	5.89	≤13	PASS
	10	20800	2505	25.18	18.87	6.31	≤13	PASS
		21100	2535	25.17	18.73	6.44	≤13	PASS
		21400	2565	24.76	18.88	5.88	≤13	PASS
	15	20825	2507.5	25.04	18.76	6.28	≤13	PASS
		21100	2535	25.14	18.65	6.49	≤13	PASS
		21375	2562.5	24.60	18.77	5.83	≤13	PASS
	20	20850	2510	24.94	18.77	6.17	≤13	PASS
		21100	2535	25.10	18.71	6.39	≤13	PASS
		21350	2560	24.61	18.66	5.95	≤13	PASS

5.6 Frequency Stability

Ambient condition

Temperature	Relative humidity	Pressure
23°C ~25°C	45%~50%	101.5kPa

Method of Measurement

Frequency Stability (Temperature Variation)

The temperature inside the climate chamber is varied from -30°C to +55°C in 10°C step size.

(1) With all power removed, the temperature was decreased to -10°C and permitted to stabilize for three hours.

(2) Measure the carrier frequency with the test equipment in a “call mode”. These measurements should be made within 1 minute of powering up the mobile station, to prevent significant self warming.

(3) Repeat the above measurements at 10°C increments from -30°C to +55°C. Allow at least 1.5 hours at each temperature, un-powered, before making measurements.

Frequency Stability (Voltage Variation)

The frequency stability shall be measured with variation of primary supply voltage as follows:

(1) Vary primary supply voltage from 85 to 115 percent of the nominal value for other than hand carried battery equipment.

(2) For hand carried, battery powered equipment, reduce primary supply voltage to the battery-operating end point which shall be specified by the manufacturer.

This transceiver is specified to operate with an input voltage of between 3.6 V and 4.35 V, with a nominal voltage of 3.8V.

Test setup

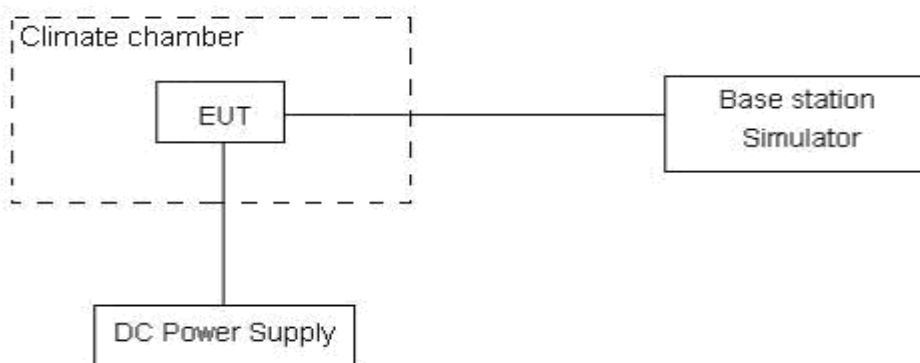

Limits

The frequency stability shall be sufficient to ensure that the fundamental emissions stay within the authorized bands of operation.

Measurement Uncertainty

The assessed measurement uncertainty to ensure 99.75% confidence level for the normal distribution is with the coverage factor $k = 3, U = 0.01\text{ppm}$.



Test Result

Original

LTE Band 7						
Condition		Freq.Error (Hz)	Freq.Error (Hz)	Frequency Stability (ppm)	Frequency Stability (ppm)	Verdict
BANDWIDTH	5MHz	16QAM	QPSK	16QAM	QPSK	
Temperature	Voltage					
Normal (25°C)	Normal	16.85	17.01	0.00896	0.00905	PASS
Extreme (55°C)		1.57	1.37	0.00084	0.00073	PASS
Extreme (50°C)		2.57	16.50	0.00137	0.00878	PASS
Extreme (40°C)		4.40	7.03	0.00234	0.00374	PASS
Extreme (30°C)		4.64	11.17	0.00247	0.00594	PASS
Extreme (20°C)		14.68	16.06	0.00781	0.00854	PASS
Extreme (10°C)		3.59	6.94	0.00191	0.00369	PASS
Extreme (0°C)		1.27	13.21	0.00068	0.00703	PASS
Extreme (-10°C)		6.38	7.00	0.00339	0.00372	PASS
Extreme (-20°C)		12.41	5.82	0.00660	0.00310	PASS
Extreme (-30°C)		13.55	8.70	0.00721	0.00463	PASS
25°C		LV	11.64	16.49	0.00619	0.00877
	HV	14.71	12.00	0.00782	0.00638	PASS
Condition		Freq.Error (Hz)	Freq.Error (Hz)	Frequency Stability (ppm)	Frequency Stability (ppm)	Verdict
BANDWIDTH	10MHz	16QAM	QPSK	16QAM	QPSK	
Temperature	Voltage					
Normal (25°C)	Normal	13.79	14.58	0.00733	0.00775	PASS
Extreme (55°C)		7.44	5.83	0.00396	0.00310	PASS
Extreme (50°C)		7.60	17.55	0.00404	0.00933	PASS
Extreme (40°C)		12.96	5.63	0.00689	0.00300	PASS
Extreme (30°C)		13.04	6.16	0.00694	0.00328	PASS
Extreme (20°C)		5.90	10.39	0.00314	0.00553	PASS
Extreme (10°C)		11.42	6.72	0.00607	0.00357	PASS
Extreme (0°C)		7.87	10.28	0.00419	0.00547	PASS
Extreme (-10°C)		8.63	2.05	0.00459	0.00109	PASS
Extreme (-20°C)		1.55	1.26	0.00083	0.00067	PASS
Extreme (-30°C)		1.03	15.62	0.00055	0.00831	PASS
25°C		LV	10.20	7.32	0.00543	0.00390
	HV	7.27	8.65	0.00387	0.00460	PASS
Condition		Freq.Error (Hz)	Freq.Error (Hz)	Frequency Stability (ppm)	Frequency Stability (ppm)	Verdict
BANDWIDTH	15MHz	16QAM	QPSK	16QAM	QPSK	
Temperature	Voltage					



Normal (25°C)	Normal	4.40	17.64	0.00234	0.00939	PASS
Extreme (55°C)		10.69	8.77	0.00568	0.00467	PASS
Extreme (50°C)		2.40	15.51	0.00128	0.00825	PASS
Extreme (40°C)		8.35	2.12	0.00444	0.00113	PASS
Extreme (30°C)		11.40	5.78	0.00606	0.00307	PASS
Extreme (20°C)		4.09	15.52	0.00217	0.00826	PASS
Extreme (10°C)		5.00	13.99	0.00266	0.00744	PASS
Extreme (0°C)		11.16	16.85	0.00594	0.00896	PASS
Extreme (-10°C)		5.80	8.93	0.00309	0.00475	PASS
Extreme (-20°C)		5.77	5.67	0.00307	0.00302	PASS
Extreme (-30°C)		10.84	17.66	0.00577	0.00940	PASS
25°C	LV	15.65	5.11	0.00832	0.00272	PASS
	HV	2.87	3.22	0.00153	0.00171	PASS
Condition		Freq.Error (Hz)	Freq.Error (Hz)	Frequency Stability (ppm)	Frequency Stability (ppm)	Verdict
BANDWIDTH	20MHz					
Temperature	Voltage	16QAM	QPSK	16QAM	QPSK	
Normal (25°C)	Normal	15.89	17.23	0.00845	0.00916	PASS
Extreme (55°C)		4.94	4.98	0.00263	0.00265	PASS
Extreme (50°C)		17.81	16.06	0.00948	0.00854	PASS
Extreme (40°C)		6.14	10.03	0.00326	0.00534	PASS
Extreme (30°C)		5.44	9.27	0.00290	0.00493	PASS
Extreme (20°C)		4.74	10.87	0.00252	0.00578	PASS
Extreme (10°C)		8.34	2.97	0.00444	0.00158	PASS
Extreme (0°C)		5.03	13.42	0.00267	0.00714	PASS
Extreme (-10°C)		2.66	2.45	0.00142	0.00131	PASS
Extreme (-20°C)		5.33	3.07	0.00284	0.00163	PASS
Extreme (-30°C)		1.39	11.66	0.00074	0.00620	PASS
25°C	LV	4.90	12.13	0.00261	0.00645	PASS
	HV	16.85	2.77	0.00897	0.00147	PASS

5.7 Spurious Emissions at Antenna Terminals

Ambient condition

Temperature	Relative humidity	Pressure
23°C ~25°C	45%~50%	101.5kPa

Method of Measurement

The EUT was connected to Spectrum Analyzer and Base Station Simulator via power Splitter. The measurement is carried out using a spectrum analyzer. The spectrum analyzer scans from 9kHz to the 10th harmonic of the carrier. The peak detector is used.

RBW is set to 100kHz, VBW is set to 300kHz for 30MHz~1GHz

RBW is set to 1MHz, VBW is set to 3MHz for above 1GHz, Sweep is set to ATUO.

Of those disturbances below (limit – 20 dB), the mark is not required for the EUT.

The modulation mode and RB allocation refer to section 5.1, using the maximum output power configuration.

Test setup

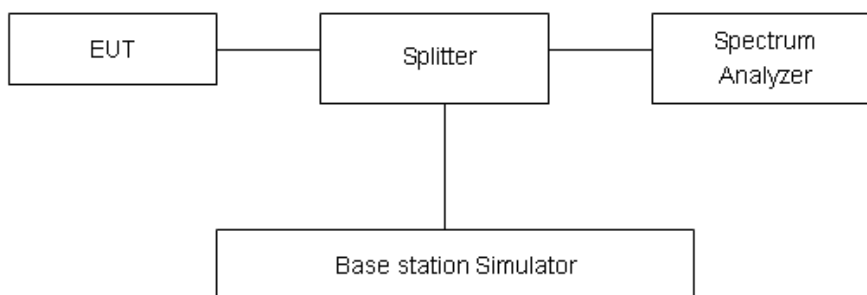

Limits

Rule Part 27.53(m) $55 + 10 \log (P)$ dB on all frequencies more than X megahertz from the channel edge, where X is the greater of 6 megahertz or the actual emission bandwidth as defined in paragraph (m)(4) of this section.

Part 27.53(m) Limit	-25 dBm
---------------------	---------

Measurement Uncertainty

The assessed measurement uncertainty to ensure 99.75% confidence level for the normal distribution is with the coverage factor $k = 1.96$.

Frequency	Uncertainty
9kHz-1GHz	0.684 dB
1GHz-27GHz	1.407 dB



Test Result

Sweep the whole frequency band through the range from 9kHz to the 10th harmonic of the carrier, the emissions more than 20 dB below the limit are not reported.

The signal beyond the limit is carrier.

Original

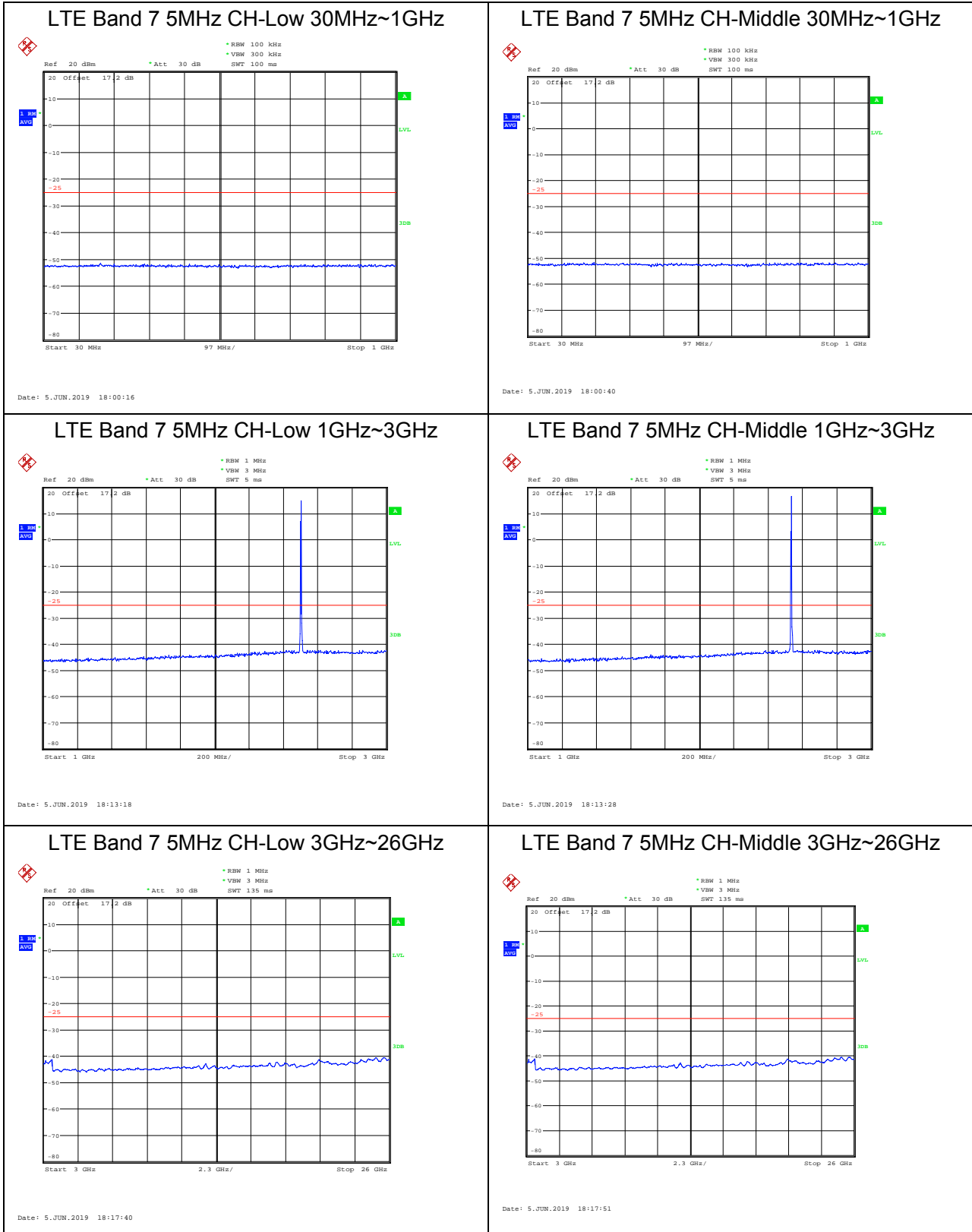



LTE Band 7 5MHz CH-High 30MHz~1GHz

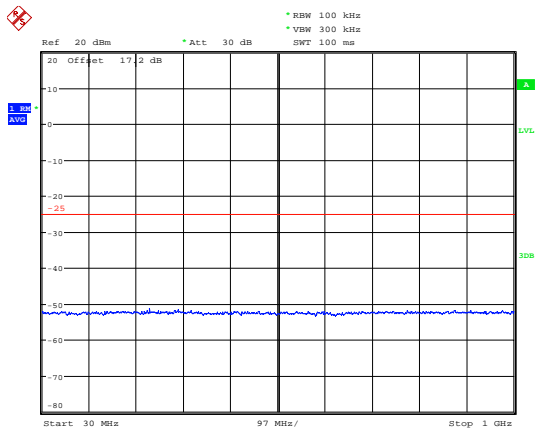

Date: 5.JUN.2019 18:00:56

LTE Band 7 10MHz CH-Low 30MHz~1GHz

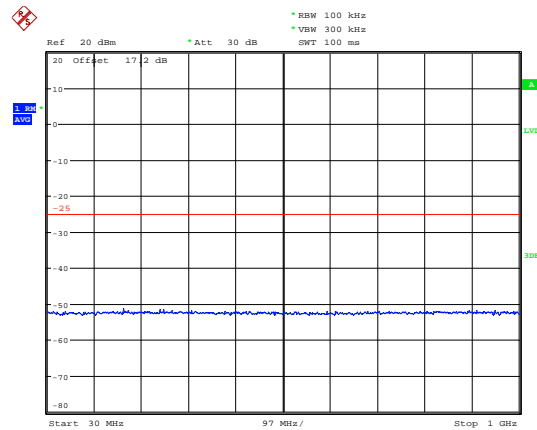

Date: 5.JUN.2019 18:01:15

LTE Band 7 5MHz CH-High 1GHz~3GHz

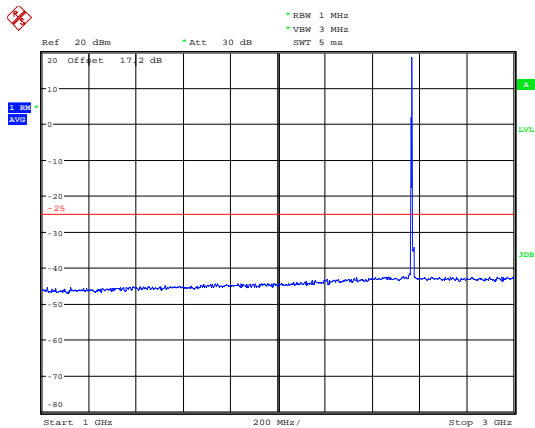

Date: 5.JUN.2019 18:13:41

LTE Band 7 10MHz CH-Low 1GHz~3GHz

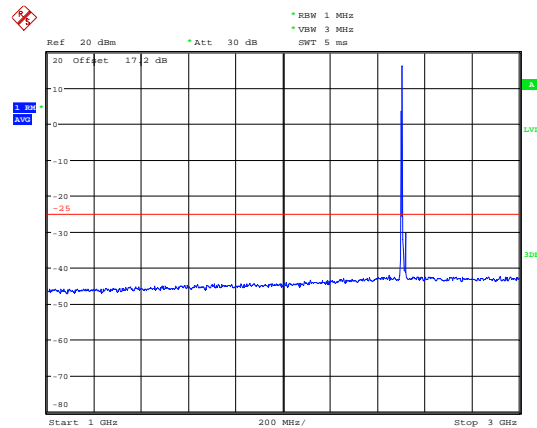

Date: 5.JUN.2019 18:14:00

LTE Band 7 5MHz CH-High 3GHz~26GHz

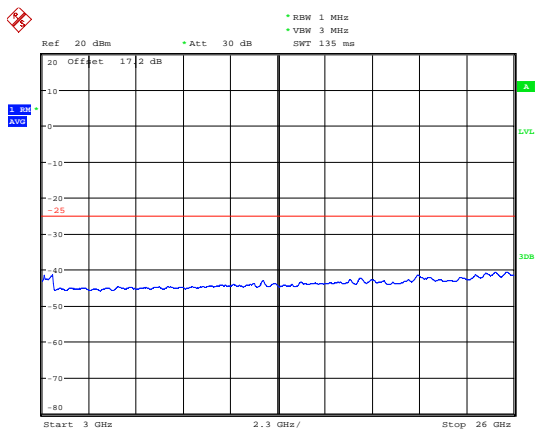

Date: 5.JUN.2019 18:18:07

LTE Band 7 10MHz CH-Low 3GHz~26GHz

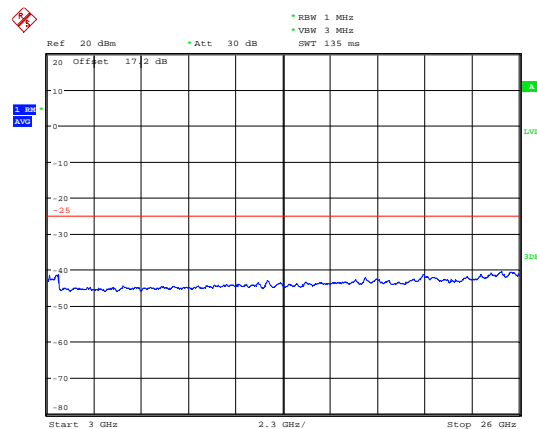

Date: 5.JUN.2019 18:18:26



LTE Band 7 10MHz CH-Middle 30MHz~1GHz

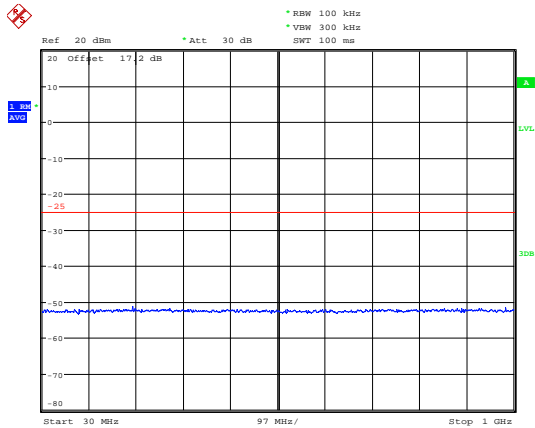

Date: 5.JUN.2019 18:01:27

LTE Band 7 10MHz CH-High 30MHz~1GHz

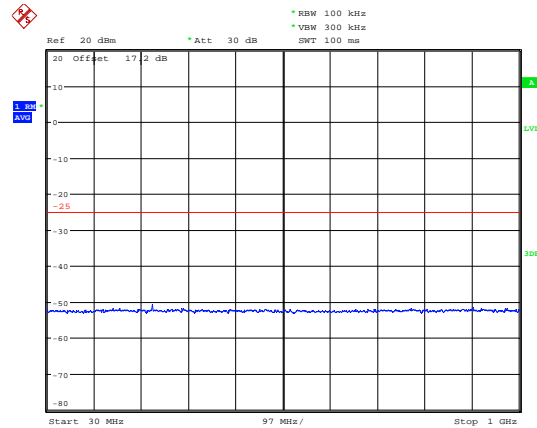

Date: 5.JUN.2019 18:01:41

LTE Band 7 10MHz CH-Middle 1GHz~3GHz

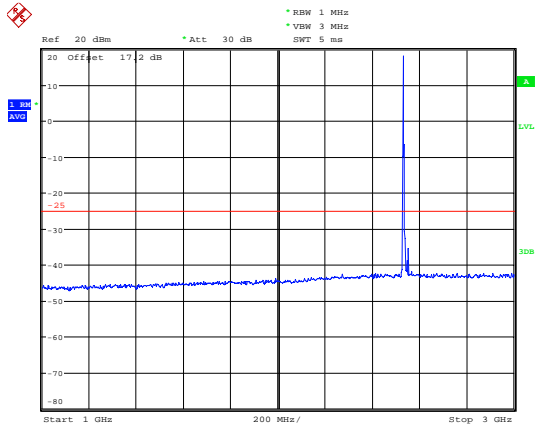

Date: 5.JUN.2019 18:14:11

LTE Band 7 10MHz CH-High 1GHz~3GHz

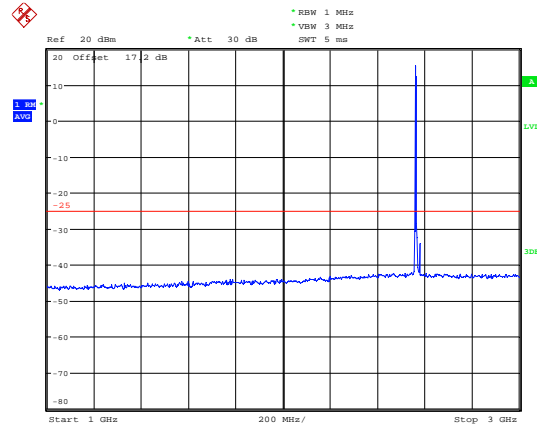

Date: 5.JUN.2019 18:14:26

LTE Band 7 10MHz CH-Middle 3GHz~26GHz

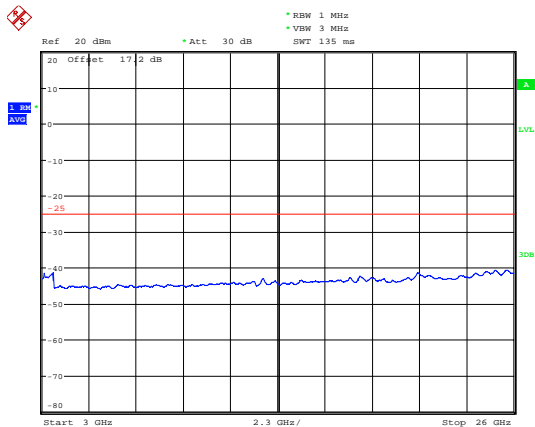

Date: 5.JUN.2019 18:18:38

LTE Band 7 10MHz CH-High 3GHz~26GHz

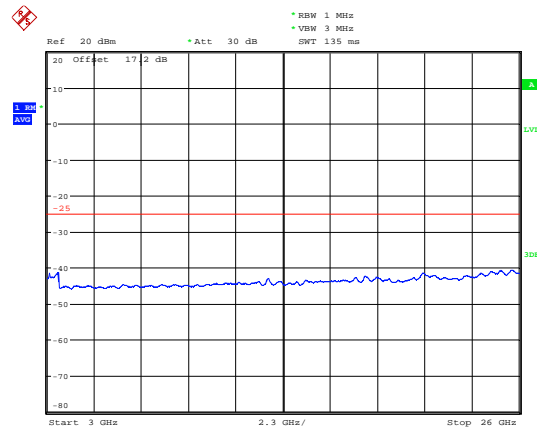

Date: 5.JUN.2019 18:18:50



LTE Band 7 15MHz CH-Low 30MHz~1GHz

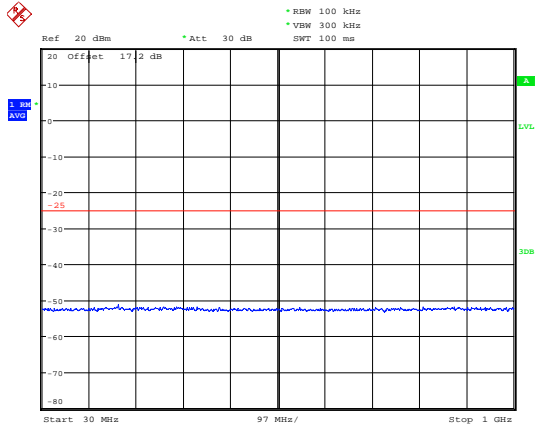

Date: 5.JUN.2019 18:02:04

LTE Band 7 15MHz CH-Middle 30MHz~1GHz

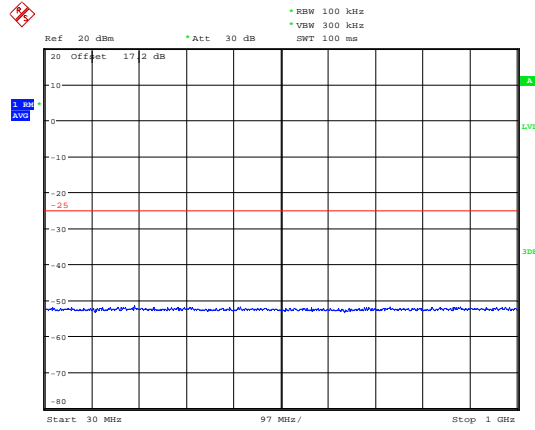

Date: 5.JUN.2019 18:02:16

LTE Band 7 15MHz CH-Low 1GHz~3GHz

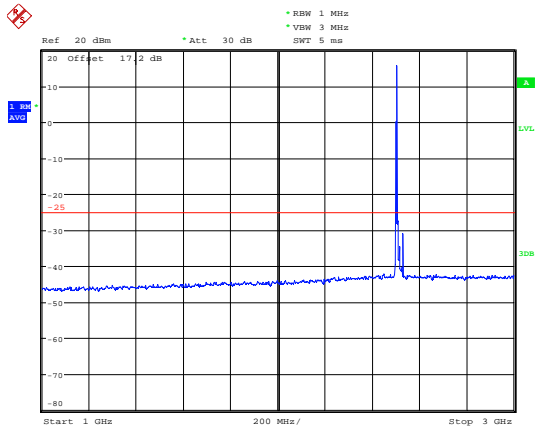

Date: 5.JUN.2019 18:14:57

LTE Band 7 15MHz CH-Middle 1GHz~3GHz

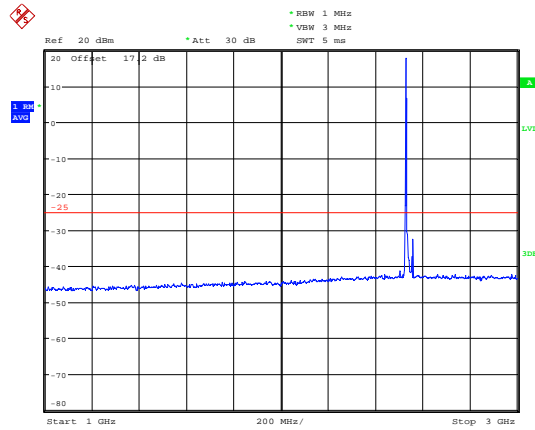

Date: 5.JUN.2019 18:15:08

LTE Band 7 15MHz CH-Low 3GHz~26GHz

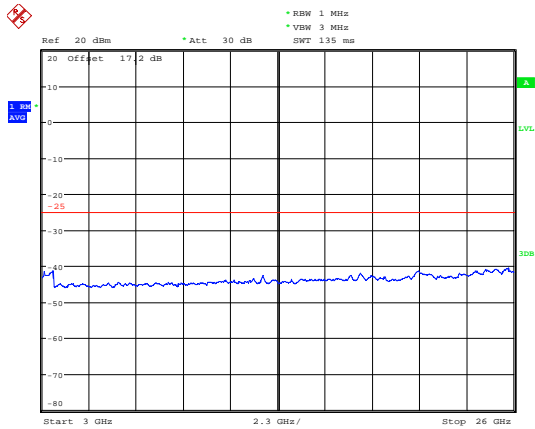

Date: 5.JUN.2019 18:16:19

LTE Band 7 15MHz CH-Middle 3GHz~26GHz

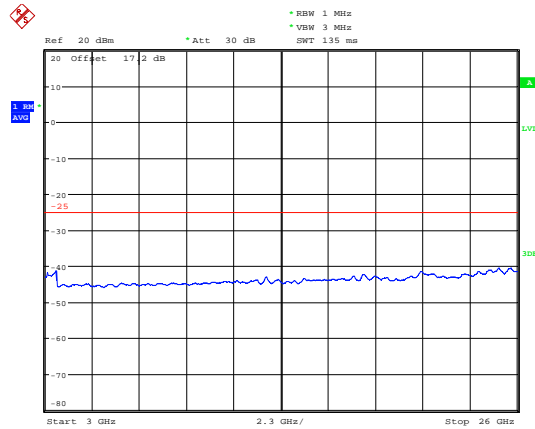

Date: 5.JUN.2019 18:16:00



LTE Band 7 15MHz CH-High 30MHz~1GHz

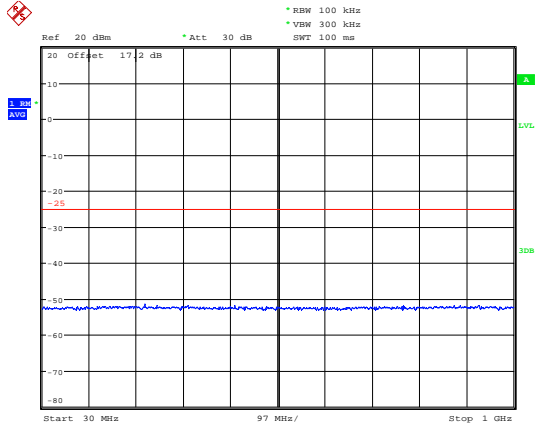

Date: 5.JUN.2019 18:02:29

LTE Band 7 20MHz CH-Low 30MHz~1GHz

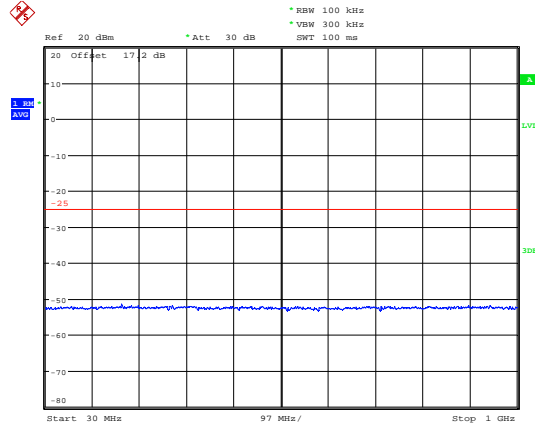

Date: 5.JUN.2019 18:02:54

LTE Band 7 15MHz CH-High 1GHz~3GHz

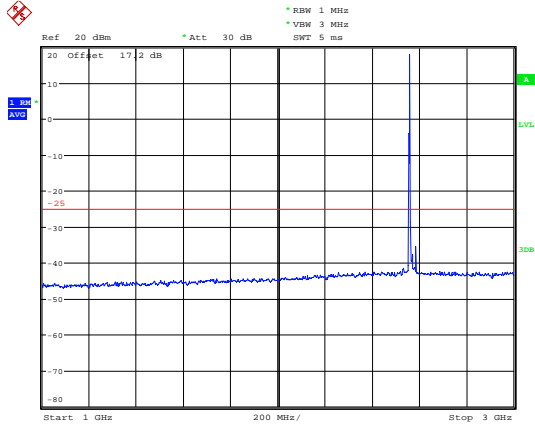

Date: 5.JUN.2019 18:15:24

LTE Band 7 20MHz CH-Low 1GHz~3GHz

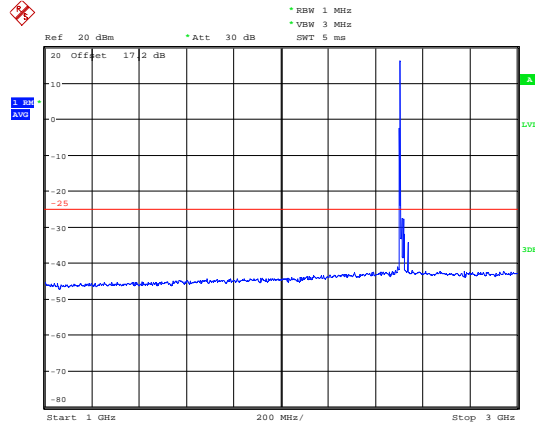

Date: 5.JUN.2019 18:12:49

LTE Band 7 15MHz CH-High 3GHz~26GHz

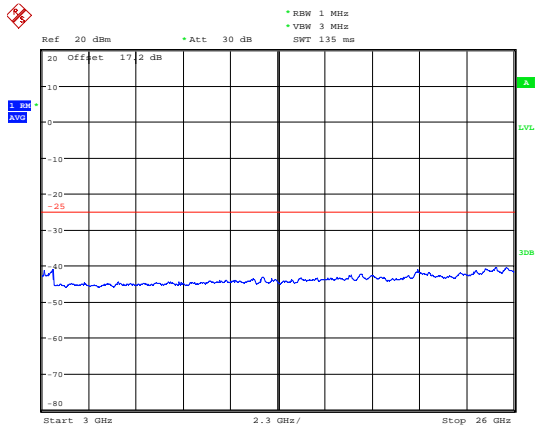

Date: 5.JUN.2019 18:15:44

LTE Band 7 20MHz CH-Low 3GHz~26GHz

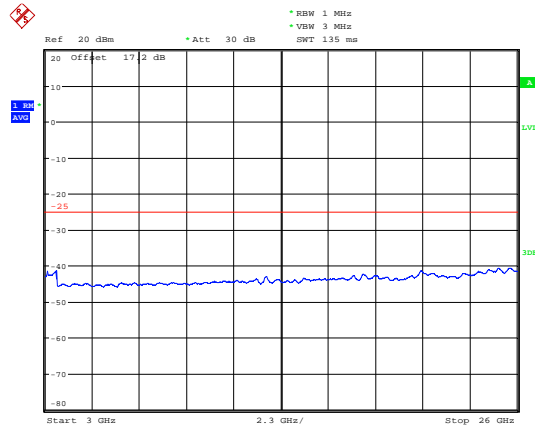

Date: 5.JUN.2019 18:16:45



LTE Band 7 20MHz CH-Middle 30MHz~1GHz

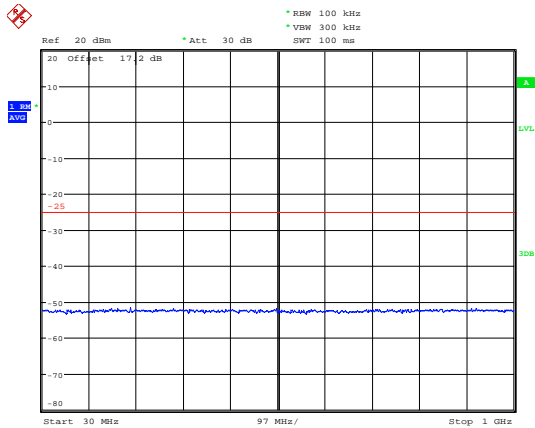

Date: 5.JUN.2019 18:03:06

LTE Band 7 20MHz CH-High 30MHz~1GHz

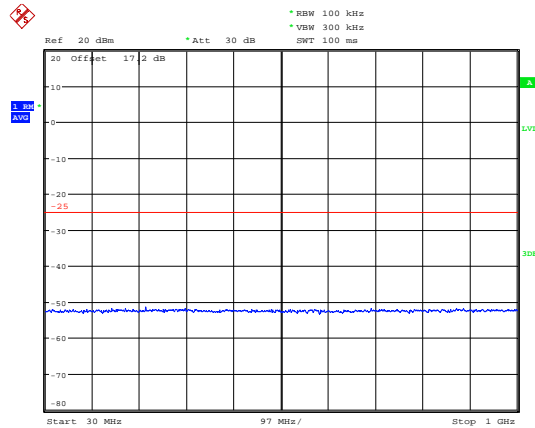

Date: 5.JUN.2019 18:03:17

LTE Band 7 20MHz CH-Middle 1GHz~3GHz

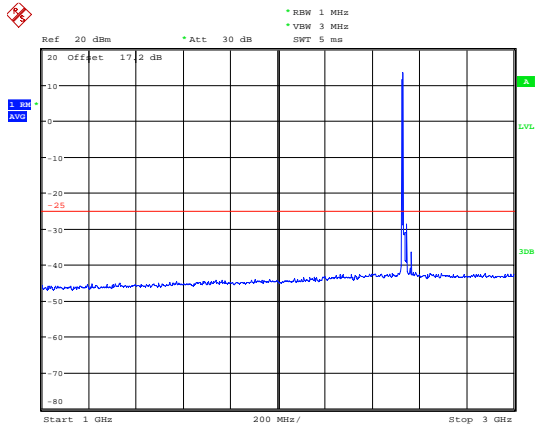

Date: 5.JUN.2019 18:12:34

LTE Band 7 20MHz CH-High 1GHz~3GHz

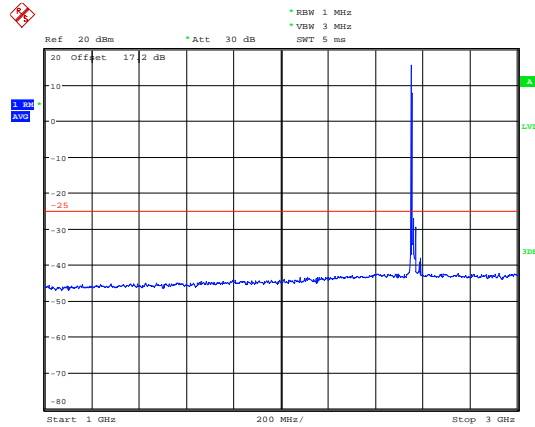

Date: 5.JUN.2019 18:12:21

LTE Band 7 20MHz CH-Middle 3GHz~26GHz

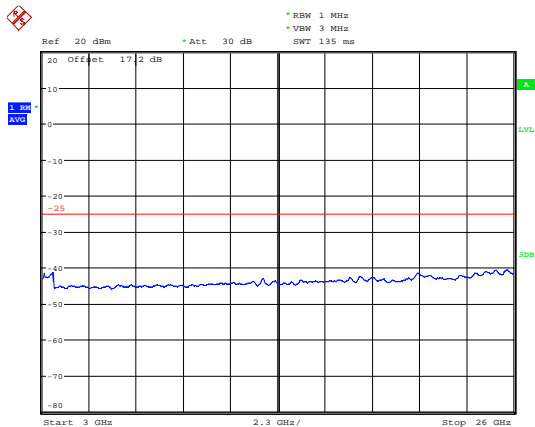

Date: 5.JUN.2019 18:17:02

LTE Band 7 20MHz CH-High 3GHz~26GHz

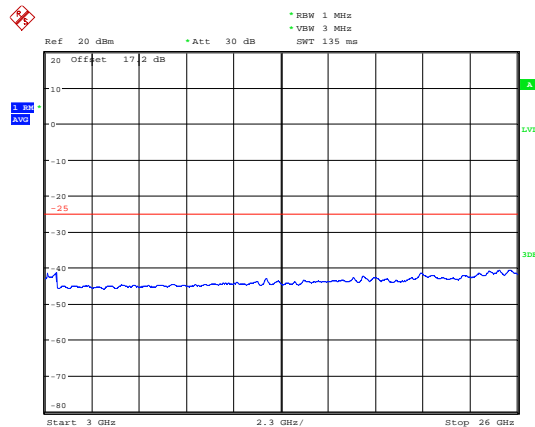

Date: 5.JUN.2019 18:17:17

5.8 Radiates Spurious Emission

Ambient condition

Temperature	Relative humidity	Pressure
23°C ~25°C	45%~50%	101.5kPa

Method of Measurement

1. The testing follows FCC KDB 971168 D01 v03r01 Section 5.8 and ANSI C63.26 (2015).
2. Below 1GHz: The EUT is placed on a turntable 0.8 meters above the ground in the chamber, 3 meter away from the antenna. The maximal emission value is acquired by adjusting the antenna height, polarisation and turntable azimuth. Normally, the height range of antenna is 1 m to 4 m, the azimuth range of turntable is 0° to 360°, and the receive antenna has two polarizations Vertical (V) and Horizontal (H). Above 1GHz: (Note: the FCC's permission to use 1.5m as an alternative per TCBC Conf call of Dec. 2, 2014.) The EUT is placed on a turntable 1.5 meters above the ground in the chamber, 3 meter away from the antenna. The maximal emission value is acquired by adjusting the antenna height, polarisation and turntable azimuth. Normally, the height range of antenna is 1 m to 4 m, the azimuth range of turntable is 0° to 360°, and the receive antenna has two polarizations Vertical (V) and Horizontal (H).
3. A loop antenna, A log-periodic antenna or horn antenna shall be substituted in place of the EUT. The log-periodic antenna will be driven by a signal generator and the level will be adjusted till the same power value on the spectrum analyzer or receiver. The level of the spurious emissions can be calculated through the level of the signal generator, cable loss, the gain of the substitution antenna and the reading of the spectrum analyzer or receiver.
4. The EUT is then put into continuously transmitting mode at its maximum power level during the test. Set Test Receiver or Spectrum RBW=200Hz,VBW=600Hz for 9kHz150kHz , RBW=10kHz, VBW=30kHz 150kHz-30MHz ,RBW=100kHz,VBW=300kHz for 30MHz to 1GHz and RBW=1MHz, VBW=3MHz for above 1GHz And the maximum value of the receiver should be recorded as (Pr).
5. The EUT shall be replaced by a substitution antenna. In the chamber, an substitution antenna for the frequency band of interest is placed at the reference point of the chamber. An RF Signal source for the frequency band of interest is connected to the substitution antenna with a cable that has been constructed to not interfere with the radiation pattern of the antenna. A power (PMea) is applied to the input of the substitution antenna, and adjust the level of the signal generator output until the value of the receiver reach the previously recorded (Pr). The power of signal source (PMea) is recorded. The test should be performed by rotating the test item and adjusting the receiving antenna polarization.
6. A amplifier should be connected to the Signal Source output port. And the cable should be connect between the Amplifier and the Substitution Antenna. The cable loss (Pcl) ,the Substitution Antenna Gain (Ga) and the Amplifier Gain (PAg) should be recorded after test.
7. The measurement results are obtained as described below:
Power(EIRP)=PMea- PAg - Pcl + Ga
The measurement results are amend as described below:
Power(EIRP)=PMea- Pcl + Ga
8. This value is EIRP since the measurement is calibrated using an antenna of known gain (2.15 dBi) and known input power. ERP can be calculated from EIRP by subtracting the gain of the dipole, ERP

= EIRP-2.15dBi.

The modulation mode and RB allocation refer to section 5.1, using the maximum output power configuration.

Test setup

9KHz ~ 30MHz

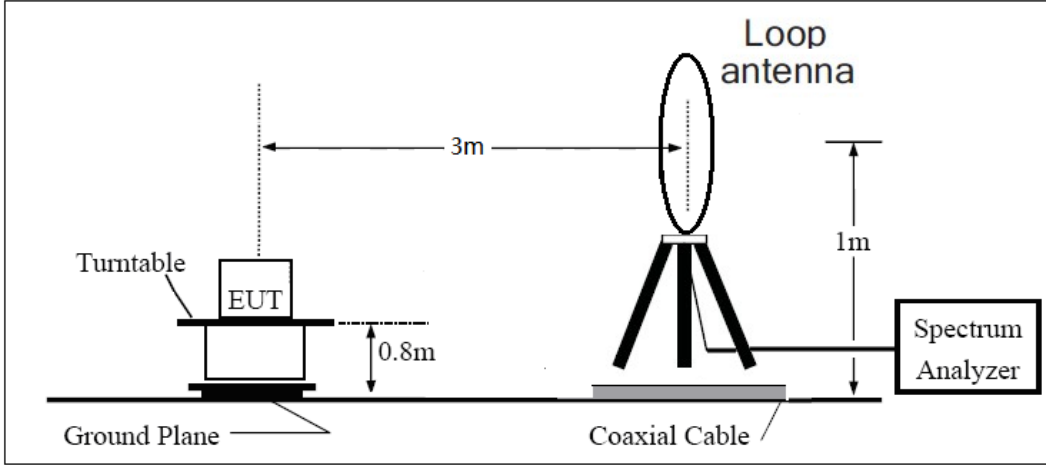

30MHz ~ 1GHz

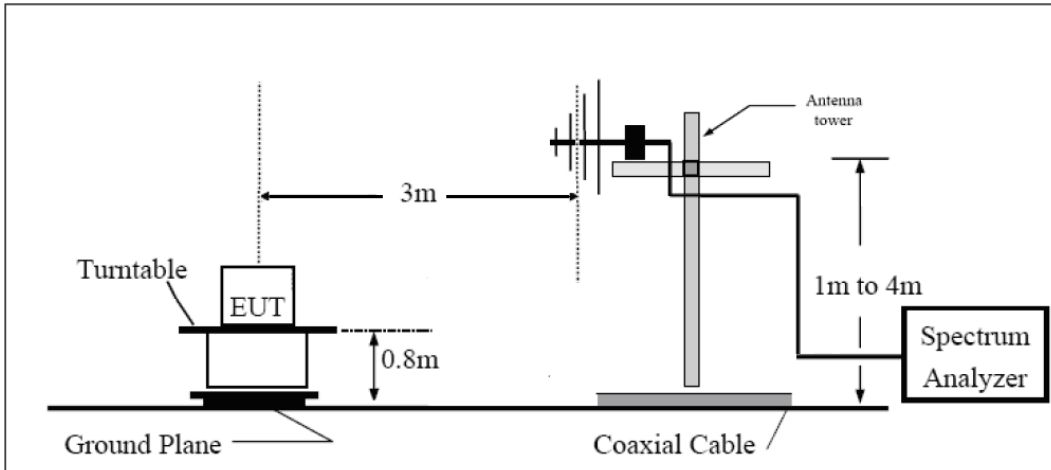

Above 1GHz

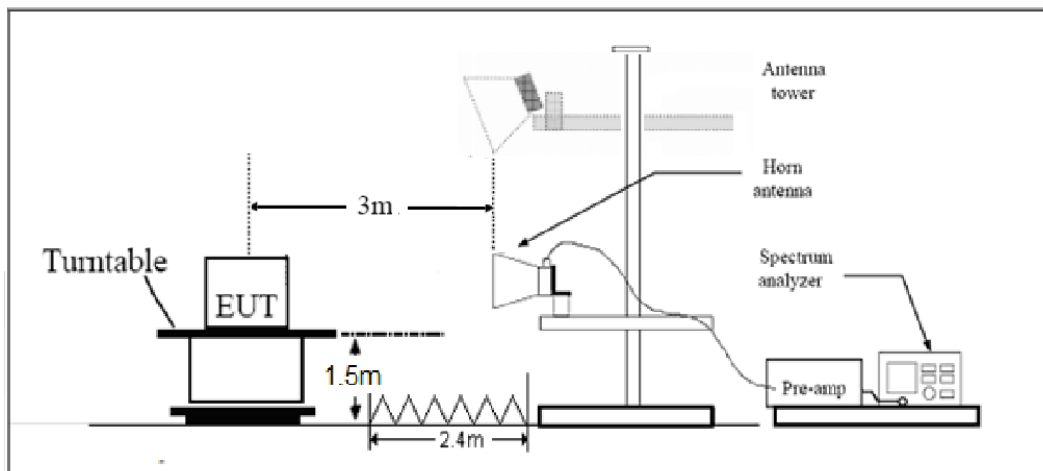

Note: Area side:2.4mX3.6m



Limits

Rule Part 27.53(m) $55 + 10 \log (P)$ dB on all frequencies more than X megahertz from the channel edge, where X is the greater of 6 megahertz or the actual emission bandwidth as defined in paragraph (m)(4) of this section.

Part 27.53(m) Limit	-25 dBm
---------------------	---------

Measurement Uncertainty

The assessed measurement uncertainty to ensure 95% confidence level for the normal distribution is with the coverage factor $k = \pm 1.96$, $U = \pm 3.55$ dB.

**Test Result**

Sweep the whole frequency band through the range from 9kHz to the 10th harmonic of the carrier, the emissions below the noise floor will not be recorded in the report.

Variant

LTE Band 7 QPSK 20MHz CH-Low, RB 1

Harmonic	Frequency (MHz)	SG (dBm)	Cable Loss (dB)	Gain (dBi)	Antenna Polarization	EIRP Level (dBm)	Limit (dBm)	Margin (dB)	Azimuth (deg)
2	5002.1	-59.87	2.00	10.15	Horizontal	-51.72	-25.00	26.72	225
3	7530.0	-57.01	2.50	11.35	Horizontal	-48.16	-25.00	23.16	315
4	10040.0	-51.68	4.20	12.05	Horizontal	-43.83	-25.00	18.83	90
5	12550.0	-53.29	5.20	14.85	Horizontal	-43.64	-25.00	18.64	45
6	15060.0	-39.22	5.50	13.23	Horizontal	-31.49	-25.00	6.49	0
7	17570.0	-43.39	5.70	12.15	Horizontal	-36.94	-25.00	11.94	90
8	20080.0	--	--	--	--	--	--	--	--
9	22590.0	--	--	--	--	--	--	--	--
10	25100.0	--	--	--	--	--	--	--	--

Note: 1.The other Spurious RF Radiated emissions level is no more than noise floor.

2. The worst emission was found in the antenna is Horizontal position.

LTE Band 7 QPSK 20MHz CH-Middle, RB 1

Harmonic	Frequency (MHz)	SG (dBm)	Cable Loss (dB)	Gain (dBi)	Antenna Polarization	EIRP Level (dBm)	Limit (dBm)	Margin (dB)	Azimuth (deg)
2	5052.4	-60.88	2.00	10.15	Horizontal	-52.73	-25.00	27.73	315
3	7605.0	-57.64	2.50	11.35	Horizontal	-48.79	-25.00	23.79	180
4	10140.0	-49.74	4.20	12.05	Horizontal	-41.89	-25.00	16.89	270
5	12675.0	-50.47	5.20	14.85	Horizontal	-40.82	-25.00	15.82	0
6	15210.0	-40.97	5.50	13.23	Horizontal	-33.24	-25.00	8.24	315
7	17745.0	-48.01	5.70	12.15	Horizontal	-41.56	-25.00	16.56	45
8	20280.0	--	--	--	--	--	--	--	--
9	22815.0	--	--	--	--	--	--	--	--
10	25350.0	--	--	--	--	--	--	--	--

Note: 1.The other Spurious RF Radiated emissions level is no more than noise floor.

2. The worst emission was found in the antenna is Horizontal position.



LTE Band 7 QPSK 20MHz CH-High, RB 1

Harmonic	Frequency (MHz)	SG (dBm)	Cable Loss (dB)	Gain (dBi)	Antenna Polarization	EIRP Level (dBm)	Limit (dBm)	Margin (dB)	Azimuth (deg)
2	5102.3	-61.54	2.00	10.15	Horizontal	-53.39	-25.00	28.39	45
3	7680.0	-53.85	2.50	11.35	Horizontal	-45.00	-25.00	20.00	180
4	10240.0	-48.28	4.20	12.05	Horizontal	-40.43	-25.00	15.43	315
5	12800.0	-52.56	5.20	14.85	Horizontal	-42.91	-25.00	17.91	225
6	15360.0	-38.05	5.50	13.23	Horizontal	-30.32	-25.00	5.32	270
7	17920.0	-48.12	5.70	12.15	Horizontal	-41.67	-25.00	16.67	0
8	20480.0	--	--	--	--	--	--	--	--
9	23040.0	--	--	--	--	--	--	--	--
10	25600.0	--	--	--	--	--	--	--	--

Note: 1. The other Spurious RF Radiated emissions level is no more than noise floor.

2. The worst emission was found in the antenna is Horizontal position.



6 Main Test Instruments

Date of Testing: June 4, 2019 ~ June 17, 2019

Name	Manufacturer	Type	Serial Number	Calibration Date	Expiration Date
Base Station Simulator	R&S	CMW500	113824	2019-05-19	2020-05-18
Power Splitter	Hua Xiang	SHX-GF2-2-13	10120101	/	/
Spectrum Analyzer	Key sight	N9010A	MY50210259	2019-05-19	2020-05-18
Signal Analyzer	R&S	FSV30	100815	2018-12-16	2019-12-15
Loop Antenna	SCHWARZBECK	FMZB1519	1519-047	2017-09-26	2019-09-25
Trilog Antenna	SCHWARZBECK	VUBL 9163	9163-201	2017-11-18	2019-11-17
Horn Antenna	R&S	HF907	100126	2018-07-07	2020-07-06
Horn Antenna	ETS-Lindgren	3160-09	00102643	2018-06-20	2020-06-19
Signal generator	R&S	SMB 100A	102594	2019-05-19	2020-05-18
Climatic Chamber	ESPEC	SU-242	93000506	2017-12-17	2020-12-16
Preamplifier	R&S	SCU18	102327	2019-05-19	2020-05-18
MOB COMMS DC SUPPLY	Keysight	66319D	MY43004105	2019-05-19	2020-05-18
RF Cable	Agilent	SMA 15cm	0001	2019-03-15	2019-06-14
RF Cable	Agilent	SMA 15cm	0001	2019-06-14	2019-09-13
Software	R&S	EMC32	9.26.0	/	/



Date of Testing: August 23, 2020 ~September 15, 2020

Name	Manufacturer	Type	Serial Number	Calibration Date	Expiration Date
Base Station Simulator	R&S	CMW500	113824	2020-05-18	2021-05-17
Power Splitter	Hua Xiang	SHX-GF2-2-13	10120101	/	/
Spectrum Analyzer	Key sight	N9010A	MY50210259	2020-05-18	2021-05-17
Signal Analyzer	R&S	FSV30	100815	2019-12-15	2020-12-14
Loop Antenna	SCHWARZBECK	FMZB1519	1519-047	2020-04-02	2023-04-01
Trilog Antenna	SCHWARZBECK	VUBL 9163	9163-201	2017-11-18	2020-11-17
Horn Antenna	R&S	HF907	102723	2018-08-11	2021-08-10
Horn Antenna	ETS-Lindgren	3160-09	00102643	2018-06-20	2021-06-19
Signal generator	R&S	SMB 100A	102594	2020-05-18	2021-05-17
Climatic Chamber	ESPEC	SU-242	93000506	2017-12-17	2020-12-16
Preamplifier	R&S	SCU18	102327	2020-05-18	2021-05-17
MOB COMMS DC SUPPLY	Keysight	66319D	MY43004105	2020-05-18	2021-05-17
RF Cable	Agilent	SMA 15cm	0001	2020-06-12	2020-12-11
Software	R&S	EMC32	9.26.0	/	/

*****END OF REPORT *****