



# RF TEST REPORT

**Applicant** MOBIWIRE MOBILES (NINGBO) CO.,LTD  
**FCC ID** WS5DFB0210  
**Product** Bar phone  
**Brand** Doro  
**Model** DFB-0210  
**Report No.** R1805A0263-R2V1  
**Issue Date** June 22, 2018

TA Technology (Shanghai) Co., Ltd. tested the above equipment in accordance with the requirements in **FCC CFR47 Part 2 (2017)/ FCC CFR 47 Part 24E (2017)**. The test results show that the equipment tested is capable of demonstrating compliance with the requirements as documented in this report.

*Jiang peng Lan*

*Performed by: Jiangpeng Lan*

*Kai Xu*

*Approved by: Kai Xu*

**TA Technology (Shanghai) Co., Ltd.**

*No.145, Jintang Rd, Tangzhen Industry Park, Pudong Shanghai, China*

*TEL: +86-021-50791141/2/3*

*FAX: +86-021-50791141/2/3-8000*



# TABLE OF CONTENT

- 1. Test Laboratory .....4
  - 1.1. Notes of the test report.....4
  - 1.2. Test facility.....4
  - 1.3. Testing Location .....5
- 2. General Description of Equipment under Test.....6
- 3. Applied Standards.....8
- 4. Test Configuration.....9
- 5. Test Case Results.....10
  - 5.1. RF Power Output.....10
  - 5.2. Effective Isotropic Radiated Power .....12
  - 5.3. Occupied Bandwidth .....15
  - 5.4. Band Edge Compliance.....18
  - 5.5. Peak-to-Average Power Ratio (PAPR) .....20
  - 5.6. Frequency Stability.....22
  - 5.7. Spurious Emissions at Antenna Terminals .....25
  - 5.8. Radiates Spurious Emission .....28
- 6. Main Test Instruments .....32
- ANNEX A: EUT Appearance and Test Setup.....33
  - A.1 EUT Appearance .....33
  - A.2 Test Setup.....40



### Summary of measurement results

No.	Test Case	Clause in FCC rules	Verdict
1	RF power output	2.1046	PASS
2	Effective Isotropic Radiated power	24.232(c)	PASS
3	Occupied Bandwidth	2.1049	PASS
4	Band Edge Compliance	2.1051 /24.238(a)	PASS
5	Peak-to-Average Power Ratio	24.232/KDB 971168 D01(5.7)	PASS
6	Frequency Stability	2.1055 / 24.235	PASS
7	Spurious Emissions at Antenna Terminals	2.1051 / 24.238(a)	PASS
8	Radiates Spurious Emission	2.1053 / 24.238(a)	PASS
Date of Testing: March 29, 2018 ~ April 18, 2018			
Note: PASS: The EUT complies with the essential requirements in the standard. FAIL: The EUT does not comply with the essential requirements in the standard.			



## 1. Test Laboratory

### 1.1. Notes of the test report

This report shall not be reproduced in full or partial, without the written approval of **TA technology (shanghai) co., Ltd.** The results documented in this report apply only to the tested sample, under the conditions and modes of operation as described herein. Measurement Uncertainties were not taken into account and are published for informational purposes only. This report is written to support regulatory compliance of the applicable standards stated above.

### 1.2. Test facility

#### **CNAS (accreditation number: L2264)**

TA Technology (Shanghai) Co., Ltd. has obtained the accreditation of China National Accreditation Service for Conformity Assessment (CNAS).

#### **FCC (Designation number: CN1179, Test Firm Registration Number: 446626)**

TA Technology (Shanghai) Co., Ltd. has been listed on the US Federal Communications Commission list of test facilities recognized to perform electromagnetic emissions measurements.

#### **IC (recognition number is 8510A)**

TA Technology (Shanghai) Co., Ltd. has been listed by industry Canada to perform electromagnetic emission measurement.

#### **VCCI (recognition number is C-4595, T-2154, R-4113, G-10766)**

TA Technology (Shanghai) Co., Ltd. has been listed by industry Japan to perform electromagnetic emission measurement.

#### **A2LA (Certificate Number: 3857.01)**

TA Technology (Shanghai) Co., Ltd. has been listed by American Association for Laboratory Accreditation to perform electromagnetic emission measurement.



### 1.3. Testing Location

Company: TA Technology (Shanghai) Co., Ltd.  
Address: No.145, Jintang Rd, Tangzhen Industry Park, Pudong  
City: Shanghai  
Post code: 201201  
Country: P. R. China  
Contact: Xu Kai  
Telephone: +86-021-50791141/2/3  
Fax: +86-021-50791141/2/3-8000  
Website: <http://www.ta-shanghai.com>  
E-mail: [xukai@ta-shanghai.com](mailto:xukai@ta-shanghai.com)

## 2. General Description of Equipment under Test

### Client Information

Applicant	MOBIWIRE MOBILES (NINGBO) CO.,LTD
Applicant address	No.999,Dacheng East Road,Fenghua City,Zhejiang Province, China
Manufacturer	Doro AB
Manufacturer address	Doro AB Magistratsvägen 10, SE-22643 Lund, Sweden

### General information

EUT Description			
Device Type:	Portable device		
Model	DFB-0210		
IMEI	356877090003626		
Hardware Version	V00(HW code:1011/1021)		
Software Version	1370_UL231_N_S01A_V01_M180313_SMP		
Power Supply	Battery/AC adapter		
Antenna Type	Internal Antenna		
Test Mode(s)	GSM1900;		
Test Modulation	GMSK		
GPRS Multislot Class	4		
Maximum E.I.R.P	GSM 1900:	29.34dBm	
Rated Power Supply Voltage	3.7 V		
Extreme Voltage	Minimum: 3.6 V Maximum: 4.2 V		
Extreme Temperature	Lowest: -10°C Highest: +55°C		
Operating Frequency Range(s)	Band	Tx (MHz)	Rx (MHz)
	GSM1900	1850 ~ 1910	1930 ~ 1990
EUT Accessory			
Adapter 1	Manufacturer: DONGGUAN AOHAI POWER TECHNOLOGY CO.,LTD Model: A31-500550		
Adapter 2	Manufacturer: TEN PAO INDUSTRIAL CO.,LTD Model: S003ATB0500055		
Adapter 3	Manufacturer: DONGGUAN AOHAI POWER TECHNOLOGY CO.,LTD Model: A806A-050100U-UK		
Adapter 4	Manufacturer: DONGGUAN AOHAI POWER TECHNOLOGY CO.,LTD Model: A2-501000		
Adapter 5	Manufacturer: DONGGUAN AOHAI POWER		



	TECHNOLOGY CO.,LTD Model: A31A-050055U-EU1
Charging Cradle	Manufacturer: MOBIWIRE MOBILES (NINGBO) CO.,LTD Model: DFB-0210
Battery 1	Manufacturer: Ningbo Veken Battery Co., Ltd Model: DBO-1000A(Halogen Free)
Battery 2	Manufacturer: Ningbo Veken Battery Co., Ltd Model: DBO-1000A(Non Halogen Free)
Earphone 1	Manufacturer: Huizhou Juwei Electronics Co.,Ltd Model: JWEP0944-M01R
Earphone 2	Manufacturer: Shenzhen Juwei Electronics Co.,Ltd Model: JWEP0782-M01
USB Cable	Manufacturer: Fukangyuan Model: M039B0800150
Note: The information of the EUT is declared by the manufacturer.	

Item	Configure 1	Configure 2
Memory	1st source Memory	2nd source Memory
HW code	1011	1021
Supplier	GD	GD
Model name	GD25LQ128CWIG	GD25LQ128CVIG
Note: Customer declaration, two configures is the same, except for Memory. There are more than one Configure, each one should be applied throughout the compliance test respectively, however, only the worst case (Configure 1) will be recorded in this report.		



### **3. Applied Standards**

According to the specifications of the manufacturer, it must comply with the requirements of the following standards:

**FCC CFR47 Part 2 (2017)**

**FCC CFR 47 Part 24E (2017)**

**ANSI/TIA-603-E (2016)**

**KDB 971168 D01 Power Meas License Digital Systems v03**



## 4. Test Configuration

Radiated measurements are performed by rotating the EUT in three different orthogonal test planes. EUT stand-up position (Z axis), lie-down position (X, Y axis). Receiver antenna polarization (horizontal and vertical), the worst emission was found in position (Z axis, horizontal polarization) and the worst case was recorded.

All mode and data rates and positions and RB size and modulations were investigated.

Subsequently, only the worst case emissions are reported.

The following testing in GSM is set based on the maximum RF Output Power.

Test modes are chosen to be reported as the worst case configuration below:

	Test items	Modes/Modulation
		GSM 1900
Conducted Test cases	RF power output	GSM GPRS
	Occupied Bandwidth	GSM GPRS(1Tx slot)
	Band Edge Compliance	GSM GPRS(1Tx slot)
	Peak-to-Average Power Ratio	GSM GPRS(1Tx slot)
	Frequency Stability	GSM GPRS(1Tx slot)
	Spurious Emissions at Antenna Terminals	GSM
Radiated Test cases	Effective Isotropic Radiated power	GSM GPRS(1Tx slot)
	Radiates Spurious Emission	GSM

## 5. Test Case Results

### 5.1.RF Power Output

#### Ambient condition

Temperature	Relative humidity	Pressure
23°C ~25°C	45%~50%	101.5kPa

#### Methods of Measurement

During the process of the testing, The EUT is controlled by the Base Station Simulator to ensure max power transmission and proper modulation.

#### Test Setup

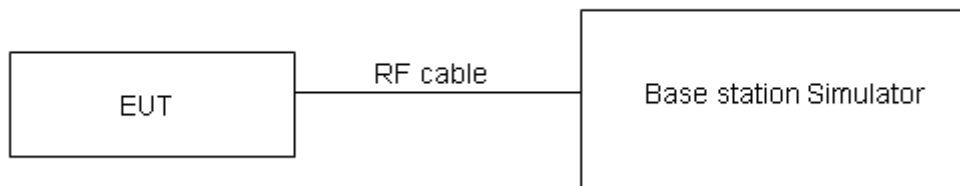

The loss between RF output port of the EUT and the input port of the tester has been taken into consideration.

#### Limits

No specific RF power output requirements in part 2.1046.

#### Measurement Uncertainty

The assessed measurement uncertainty to ensure 95% confidence level for the normal distribution is with the coverage factor  $k = 2$ ,  $U = 0.4$  dB.

**Test Results**

GSM 1900		Conducted Power(dBm)		
		Channel 512	Channel 661	Channel 810
		1850.2(MHz)	1880(MHz)	1909.8(MHz)
GSM	Results	28.23	28.41	28.39
GPRS (GMSK)	1TXslot	28.07	28.35	28.23
	2TXslots	27.34	27.72	27.65
	3TXslots	25.53	25.94	26.02
	4TXslots	24.53	25.01	25.12

## 5.2. Effective Isotropic Radiated Power

### Ambient condition

Temperature	Relative humidity	Pressure
23°C ~25°C	45%~50%	101.5kPa

### Methods of Measurement

The testing follows FCC KDB 971168 v03 Section 5.8 and ANSI/TIA-603-E (2016).

- a) Connect the equipment as illustrated. Mount the equipment with the manufacturer specified antenna in a vertical orientation on a manufacturer specified mounting surface located on a non-conducting rotating platform of a RF anechoic chamber (preferred) or a standard radiation site.
- b) Key the transmitter, then rotate the EUT 360° azimuthally and record spectrum analyzer power level (LVL) measurements at angular increments that are sufficiently small to permit resolution of all peaks. If a standard radiation test site is used, raise and lower the test antenna to obtain a maximum reading at each angular increment. (Note: several batteries may be needed to offset the effect of battery voltage droop, which should not exceed 5% of the manufactured specified battery voltage during transmission).
- c) Replace the transmitter under test with a vertically polarized half-wave dipole (or an antenna whose gain is known relative to an ideal half-wave dipole). The center of the antenna should be at the same location as the center of the antenna under test.
- d) Connect the antenna to a signal generator with a known output power and record the path loss (in dB) as LOSS. If a standard radiation test site is used, raise and lower the test antenna to obtain a maximum reading.  $LOSS = \text{Generator Output Power (dBm)} - \text{Analyzer reading (dBm)}$
- e) Determine the effective radiated output power at each angular position from the readings in steps b) and d) using the following equation:  $ERP \text{ (dBm)} = LVL \text{ (dBm)} + LOSS \text{ (dB)}$
- f) The maximum ERP is the maximum value determined in the preceding step.
- g) When calculating ERP, in addition to knowing the antenna radiation and matching characteristics, it is necessary to know the loss values of all elements (e.g. transmission line attenuation, mismatches, filters, combiners) interposed between the point where transmitter output power is measured, and the point where power is applied to the antenna. ERP can then be calculated as follows:  
 $ERP \text{ (dBm)} = \text{Output Power (dBm)} - \text{Losses (dB)} + \text{Antenna Gain (dBd)}$   
where: dBd refers to gain relative to an ideal dipole.  
 $EIRP \text{ (dBm)} = ERP \text{ (dBm)} + 2.15 \text{ (dB.)}$

**Test setup**

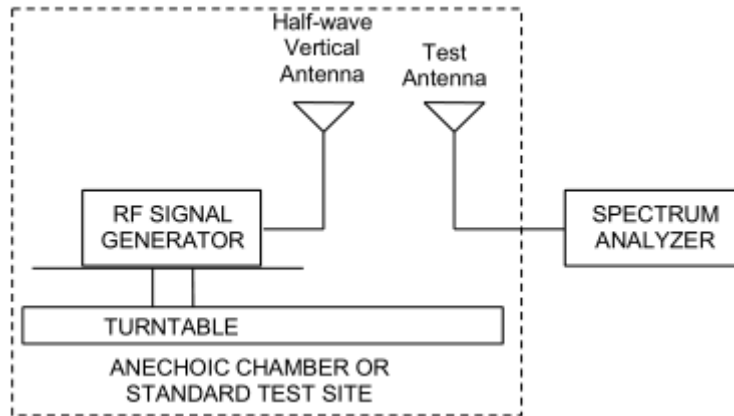
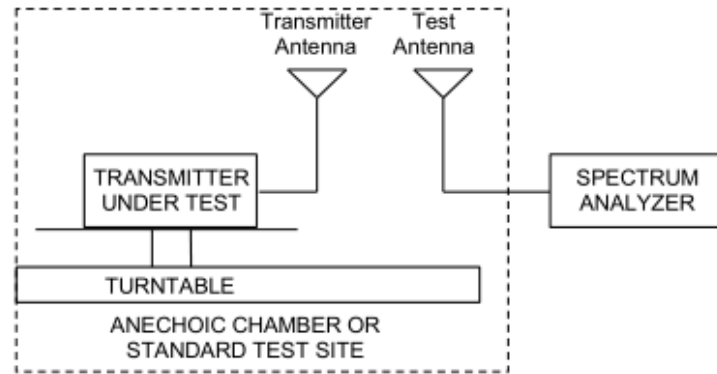

**Limits**

Rule Part 24.232(c) Mobile and portable stations are limited to 2 watts EIRP.

Rule Part 24.232(e) Peak transmit power must be measured over any interval of continuous transmission using instrumentation calibrated in terms of an rms-equivalent voltage.

Limit	$\leq 2\text{ W}$ (33 dBm)
-------	----------------------------

**Measurement Uncertainty**

The assessed measurement uncertainty to ensure 95% confidence level for the normal distribution is with the coverage factor  $k = 2$ ,  $U = 1.19\text{ dB}$

**Test Results:**

The measurement is performed for both of horizontal and vertical antenna Polarization, and only the data of worst mode is recorded in this report.

Mode	Channel	Frequency (MHz)	Polarization	EIRP (dBm)	Limit (dBm)	Conclusion
<b>GSM 1900</b>	Low	1850.2	Horizontal	28.35	33	Pass
	Mid	1880	Horizontal	29.34	33	Pass
	High	1909.8	Horizontal	27.64	33	Pass
<b>GPRS 1900</b>	Low	1850.2	Horizontal	28.51	33	Pass
	Mid	1880	Horizontal	28.95	33	Pass
	High	1909.8	Horizontal	27.43	33	Pass

### 5.3.Occupied Bandwidth

#### Ambient condition

Temperature	Relative humidity	Pressure
23°C ~25°C	45%~50%	101.5kPa

#### Method of Measurement

The EUT was connected to Spectrum Analyzer and Base Station Simulator via power Splitter. The occupied bandwidth is measured using spectrum analyzer.

RBW is set to 3kHz, VBW is set to 10kHz for GSM 1900,

99% power and -26dBc occupied bandwidths are recorded. Spectrum analyzer plots are included on the following pages.

#### Test Setup

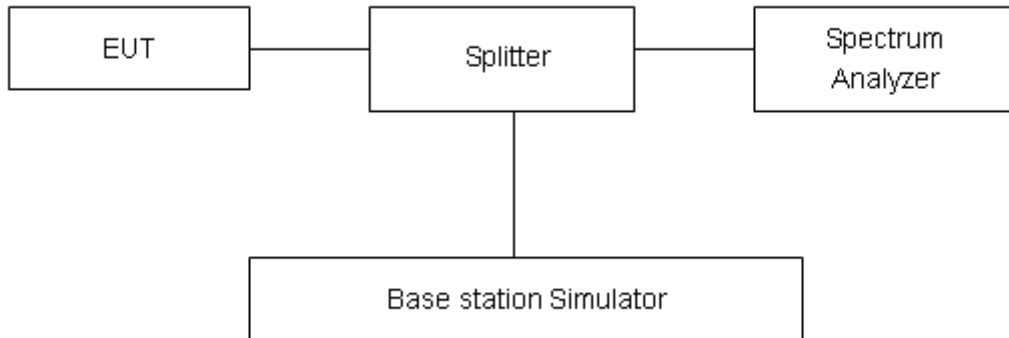

#### Limits

No specific occupied bandwidth requirements in part 2.1049.

#### Measurement Uncertainty

The assessed measurement uncertainty to ensure 95% confidence level for the normal distribution is with the coverage factor  $k = 2$ ,  $U = 624\text{Hz}$ .

**Test Result**

Mode	Channel	Frequency (MHz)	99% Power Bandwidth (MHz)	-26dBc Bandwidth(MHz)
<b>GSM 1900 (GSM)</b>	512	1850.2	0.24182	0.3081
	661	1880.0	0.24454	0.3141
	810	1909.8	0.24339	0.3063
<b>GPRS 1900 (GMSK)</b>	512	1850.2	0.24475	0.3159
	661	1880.0	0.24688	0.3137
	810	1909.8	0.24444	0.3174



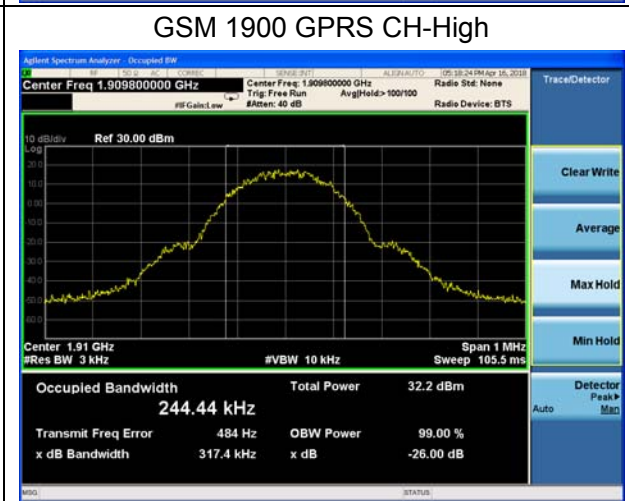
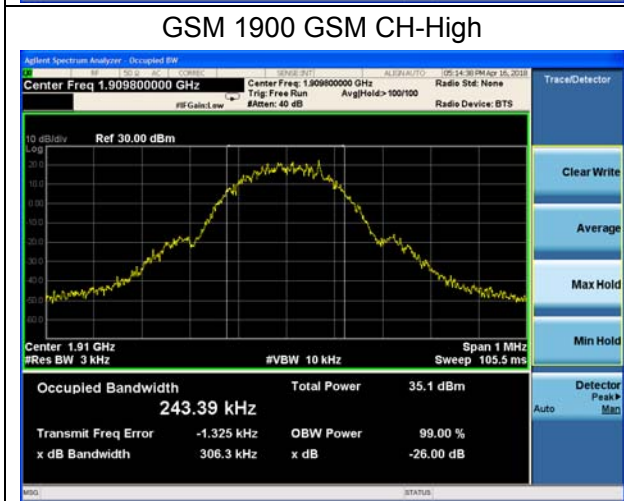
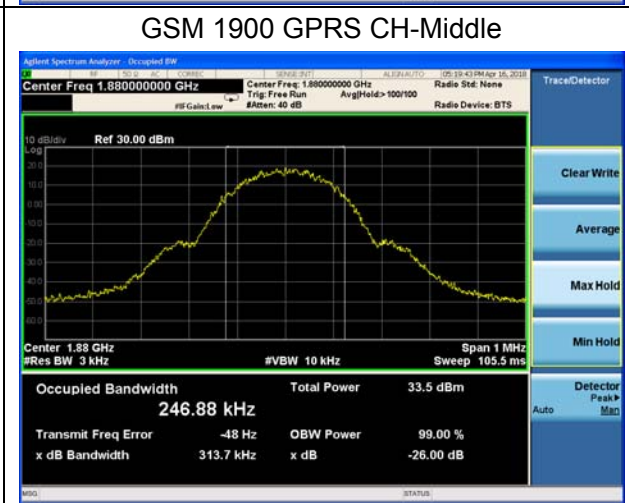
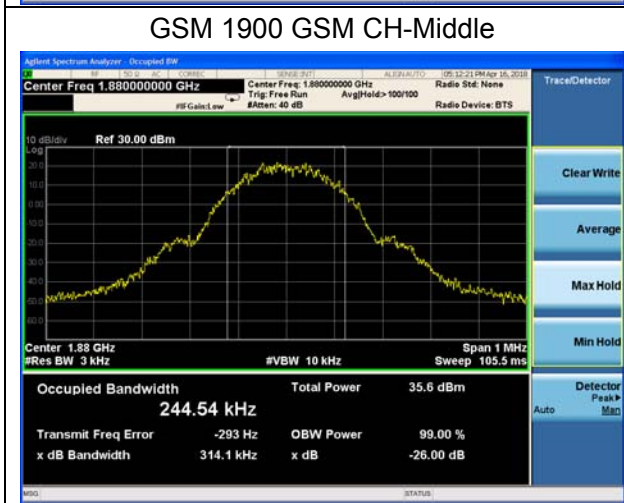
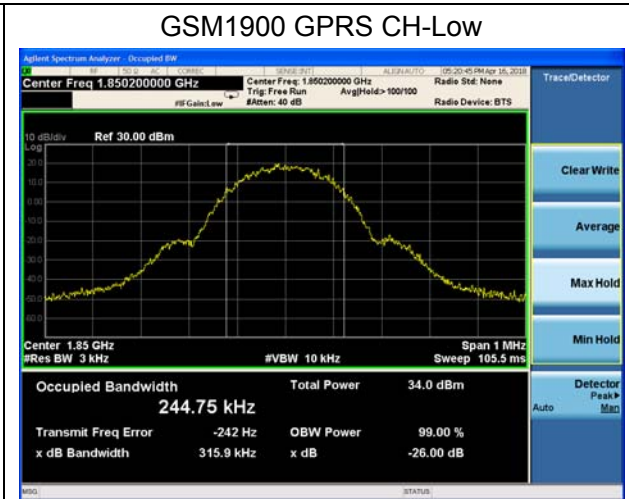
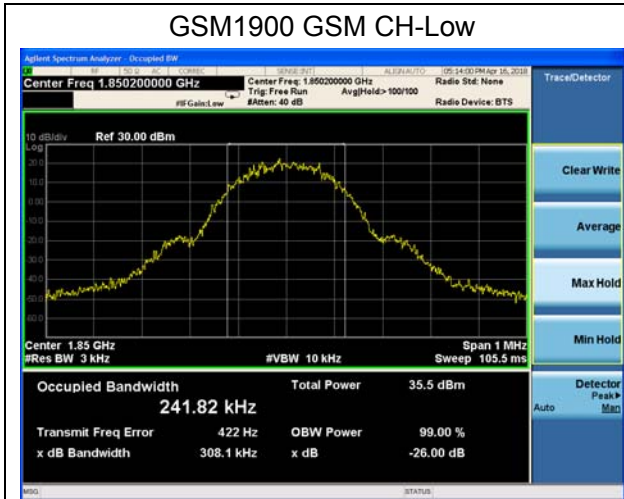

### 5.4. Band Edge Compliance

#### Ambient condition

Temperature	Relative humidity	Pressure
23°C ~25°C	45%~50%	101.5kPa

#### Method of Measurement

The EUT was connected to Spectrum Analyzer and Base Station Simulator via power Splitter. The band edge of the lowest and highest channels were measured. The Average detector is used and RBW is set to 3kHz, VBW is set to 10kHz for GSM 1900, Spectrum analyzer plots are included on the following pages.

#### Test Setup

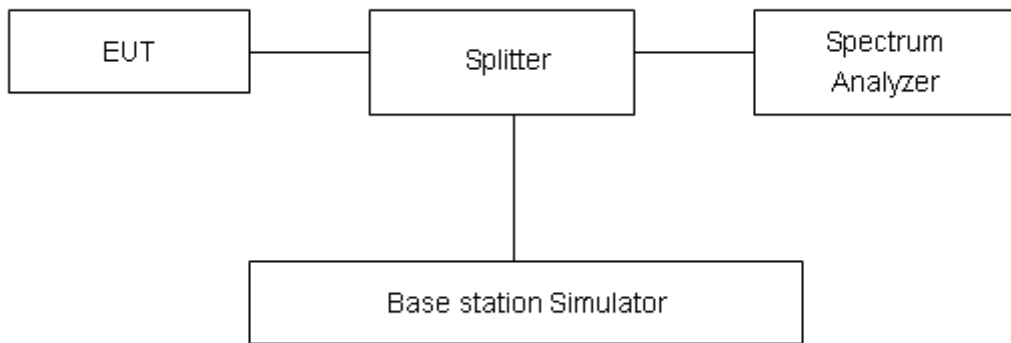

#### Limits

Rule Part 24.238(a) specifies that “on any frequency outside a licensee’s frequency block, the power of any emission shall be attenuated below the transmitter power (P) by at least  $43 + 10 \log_{10} (P)$  dB.”

Limit	-13 dBm
-------	---------

#### Measurement Uncertainty

The assessed measurement uncertainty to ensure 95% confidence level for the normal distribution is with the coverage factor  $k = 1.96$ ,  $U=0.684$ dB.



Test Result:

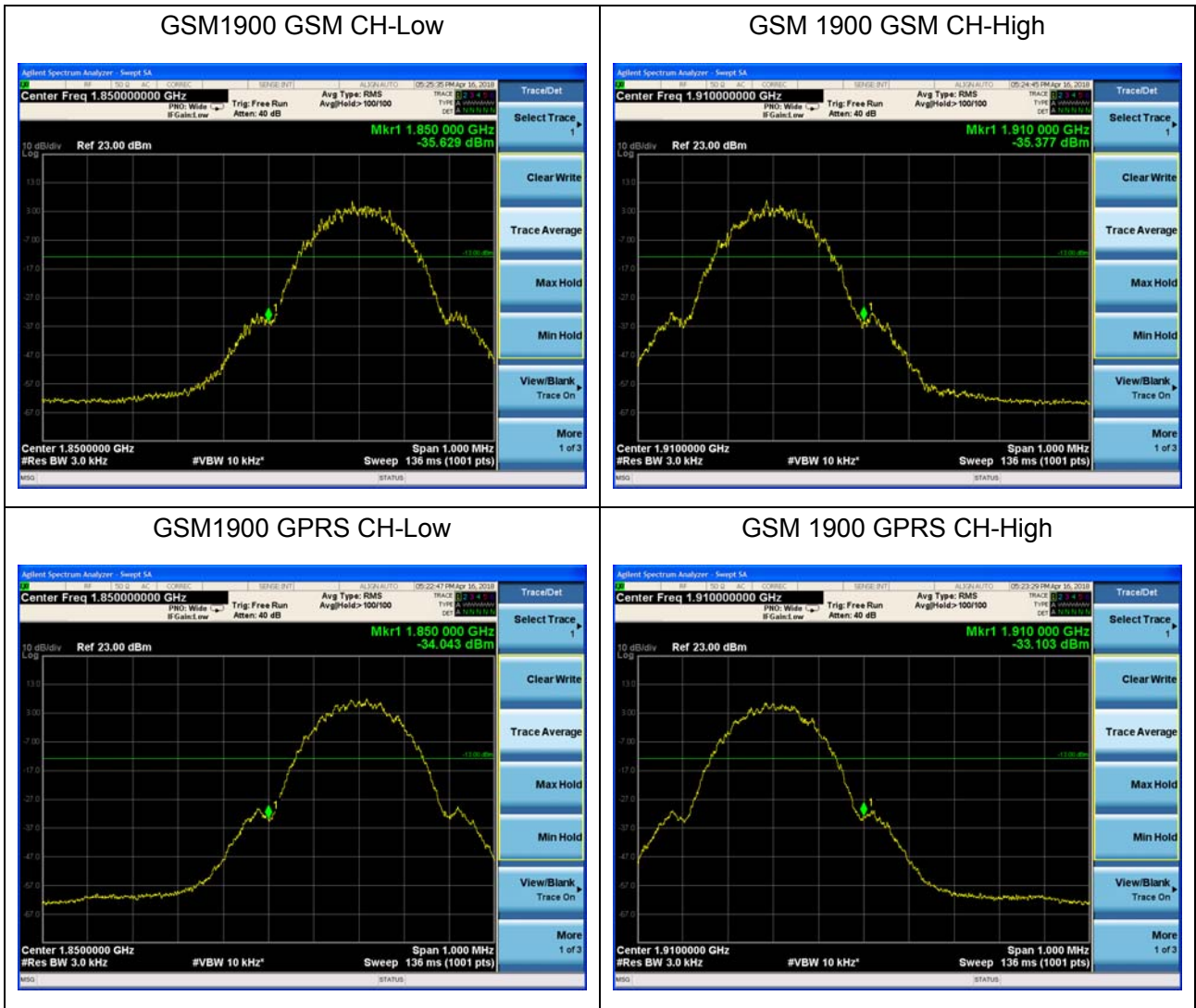

### 5.5. Peak-to-Average Power Ratio (PAPR)

#### Ambient condition

Temperature	Relative humidity	Pressure
23°C ~25°C	45%~50%	101.5kPa

#### Methods of Measurement

Measure the total peak power and record as PPk. And measure the total average power and record as PAvg. Both the peak and average power levels must be expressed in the same logarithmic units (e.g., dBm). Determine the PAPR from:

$$PAPR (dB) = PPk (dBm) - PAvg (dBm).$$

#### Test Setup

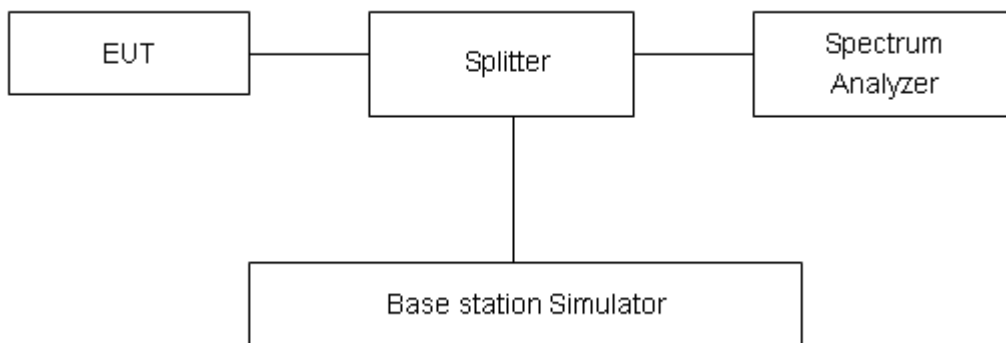

#### Limits

In measuring transmissions in this band using an average power technique, the peak-to-average ratio (PAR) of the transmission may not exceed 13 dB in 24.232(d).

#### Measurement Uncertainty

The assessed measurement uncertainty to ensure 95% confidence level for the normal distribution is with the coverage factor  $k = 2$ ,  $U = 0.4$  dB.

**Test Results**

Mode	Channel	Frequency (MHz)	Peak(dBm)	Avg(dBm)	PAPR(dB)	Limit(dB)	Conclusion
GSM 1900 (GSM)	512	1850.2	29.26	28.23	1.03	≤13	PASS
	661	1880	29.50	28.41	1.09	≤13	PASS
	810	1909.8	29.44	28.39	1.05	≤13	PASS
GPRS 1900 (GMSK)	512	1850.2	25.75	24.53	1.22	≤13	PASS
	661	1880	26.30	25.01	1.29	≤13	PASS
	810	1909.8	26.43	25.12	1.31	≤13	PASS

## 5.6. Frequency Stability

### Ambient condition

Temperature	Relative humidity	Pressure
23°C ~25°C	45%~50%	101.5kPa

### Method of Measurement

#### Frequency Stability (Temperature Variation)

The temperature inside the climate chamber is varied from -30°C to +55°C in 10°C step size,

(1) With all power removed, the temperature was decreased to 0°C and permitted to stabilize for three hours.

(2) Measure the carrier frequency with the test equipment in a “call mode”. These measurements should be made within 1 minute of powering up the mobile station, to prevent significant self warming.

(3) Repeat the above measurements at 10°C increments from -30°C to +55°C. Allow at least 1.5 hours at each temperature, un-powered, before making measurements.

#### Frequency Stability (Voltage Variation)

The frequency stability shall be measured with variation of primary supply voltage as follows:

(1) Vary primary supply voltage from 85 to 115 percent of the nominal value for other than hand carried battery equipment.

(2) For hand carried, battery powered equipment, reduce primary supply voltage to the battery-operating end point which shall be specified by the manufacturer.

This transceiver is specified to operate with an input voltage of between 3.6 V and 4.2 V, with a nominal voltage of 3.8V.

### Test setup

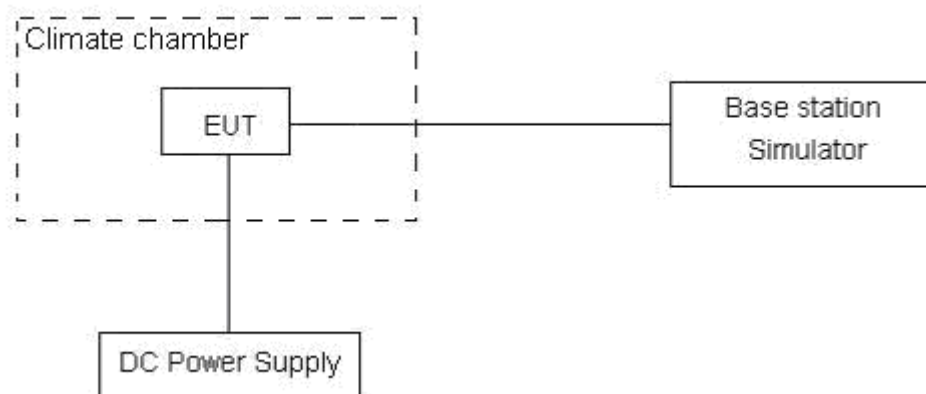



### **Limits**

No specific frequency stability requirements in part 24.235

### **Measurement Uncertainty**

The assessed measurement uncertainty to ensure 99.75% confidence level for the normal distribution is with the coverage factor  $k = 3$ ,  $U = 0.01\text{ppm}$ .

**Test Result**

GSM 1900					
Condition		1850	1910	Delta (Hz)	Frequency Stability (ppm)
Temperature	Voltage	F low@-13dBm(MHz)	F high@-13dBm(MHz)		
Normal (25°C)	Normal	1850.0672	1909.951	-10.97	-0.00584
Extreme (55°C)		1850.0672	1909.951	-22.60	-0.01202
Extreme (50°C)		1850.0672	1909.951	-7.88	-0.00419
Extreme (40°C)		1850.0672	1909.951	-13.23	-0.00704
Extreme (30°C)		1850.0672	1909.951	-0.13	-0.00007
Extreme (20°C)		1850.0672	1909.951	-2.97	-0.00158
Extreme (10C)		1850.0672	1909.951	-20.57	-0.01094
Extreme (0°C)		1850.0672	1909.951	-25.27	-0.01344
Extreme (-10°C)		1850.0672	1909.951	-26.28	-0.01398
Extreme (-20°C)		1850.0672	1909.951	-2.88	-0.00153
Extreme (-30°C)		1850.0672	1909.951	-8.43	-0.00448
25°C		LV	1850.0672	1909.951	-9.96
	HV	1850.0672	1909.951	-1.01	-0.00054
GPRS 1900					
Condition		1850	1910	Delta (Hz)	Frequency Stability (ppm)
Temperature	Voltage	F low@-13dBm(MHz)	F high@-13dBm(MHz)		
Normal (25°C)	Normal	1850.0612	1909.9444	-4.80	-0.00255
Extreme (55°C)		1850.0612	1909.9444	-13.05	-0.00694
Extreme (50°C)		1850.0612	1909.9444	-12.36	-0.00657
Extreme (40°C)		1850.0612	1909.9444	-19.87	-0.01057
Extreme (30°C)		1850.0612	1909.9444	-6.33	-0.00337
Extreme (20°C)		1850.0612	1909.9444	-1.15	-0.00061
Extreme (10C)		1850.0612	1909.9444	-10.64	-0.00566
Extreme (0°C)		1850.0612	1909.9444	-20.29	-0.01079
Extreme (-10°C)		1850.0612	1909.9444	-29.46	-0.01567
Extreme (-20°C)		1850.0612	1909.9444	-27.13	-0.01443
Extreme (-30°C)		1850.0612	1909.9444	-24.89	-0.01324
25°C		LV	1850.0612	1909.9444	-14.64
	HV	1850.0612	1909.9444	-5.76	-0.00306



### 5.7. Spurious Emissions at Antenna Terminals

#### Ambient condition

Temperature	Relative humidity	Pressure
23°C ~25°C	45%~50%	101.5kPa

#### Method of Measurement

The EUT was connected to Spectrum Analyzer and Base Station Simulator via power Splitter. The measurement is carried out using a spectrum analyzer. The spectrum analyzer scans from 9kHz to the 10th harmonic of the carrier. The peak detector is used.set RBW 1MHz and VBW is 3MHz, Sweep is set to ATUO.

#### Test setup

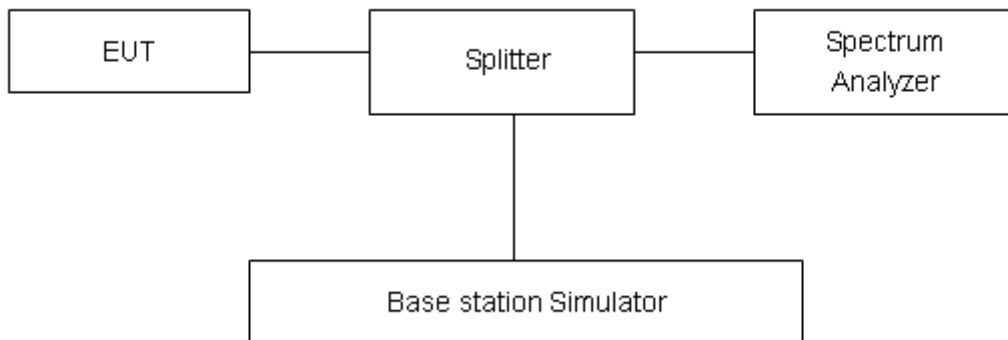

#### Limits

Rule Part 24.238(a) specifies that “on any frequency outside a licensee’s frequency block, the power of any emission shall be attenuated below the transmitter power (P) by at least 43 + 10 log<sub>10</sub> (P) dB.”

Limit	-13 dBm
-------	---------

#### Measurement Uncertainty

The assessed measurement uncertainty to ensure 99.75% confidence level for the normal distribution is with the coverage factor  $k = 1.96$ .

Frequency	Uncertainty
9kHz-1GHz	0.684 dB
1GHz-20GHz	1.407 dB



### Test Result

Sweep from 9 kHz to 30MHz, and the emissions more than 20 dB below the permissible value are not reported.

If disturbances were found more than 20dB below limit line, the mark is not required for the EUT. The signal beyond the limit is carrier.

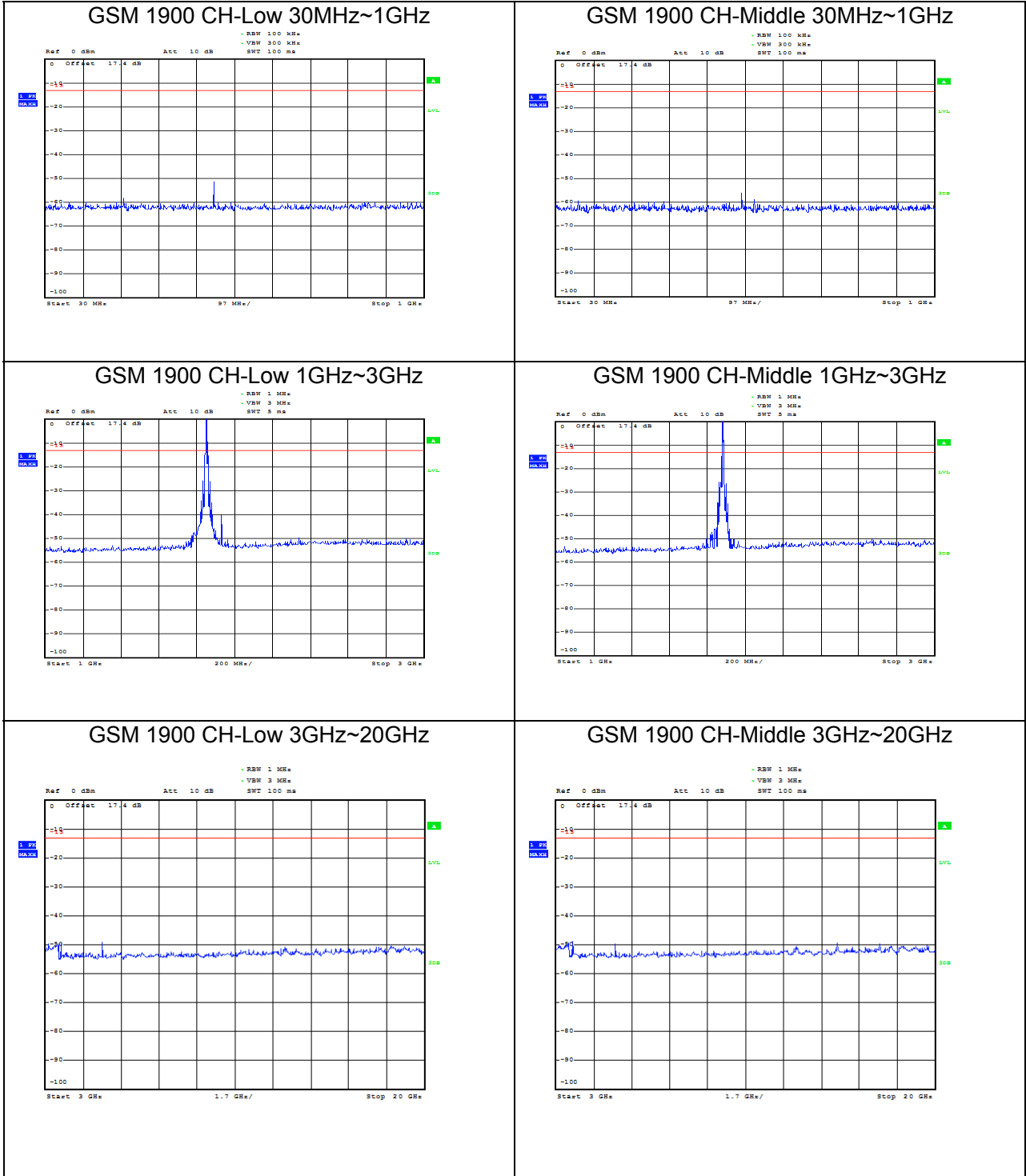



### GSM 1900 CH-High 30MHz~1GHz

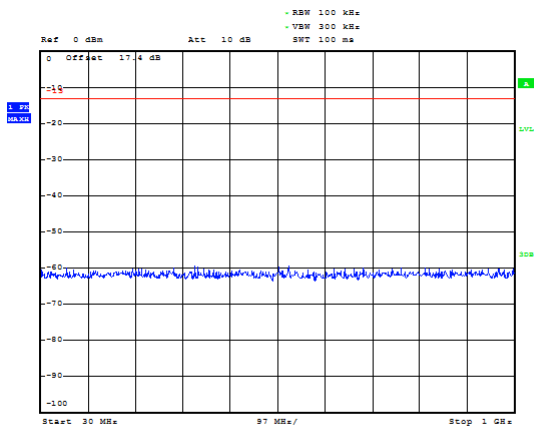

### GSM 1900 CH-High 1GHz~3GHz

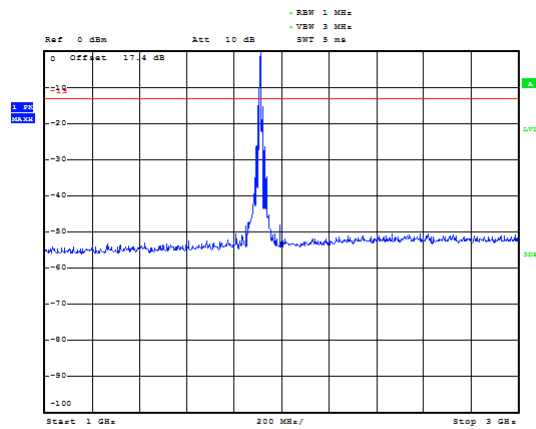

### GSM 1900 CH-High 3GHz~20GHz

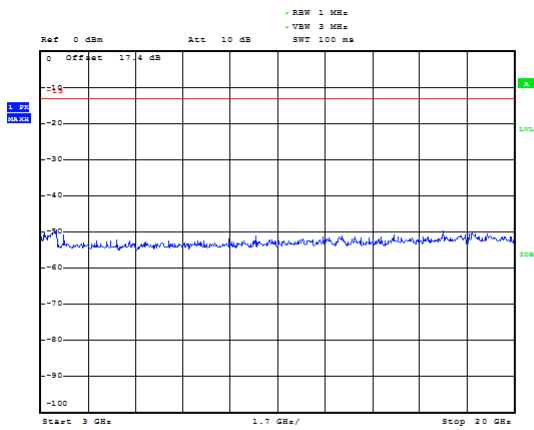

## 5.8. Radiates Spurious Emission

### Ambient condition

Temperature	Relative humidity	Pressure
23°C ~25°C	45%~50%	101.5kPa

### Method of Measurement

1. The testing follows FCC KDB 971168 v03 Section 5.8 and ANSI/TIA-603-E (2016).
2. The EUT is placed on a turntable 0.8 meters above the ground in the chamber, 3 meter away from the antenna. The maximal emission value is acquired by adjusting the antenna height, polarisation and turntable azimuth. Normally, the height range of antenna is 1 m to 4 m, the azimuth range of turntable is 0° to 360°, and the receive antenna has two polarizations Vertical (V) and Horizontal (H).
3. A log-periodic antenna or double-ridged waveguide horn antenna shall be substituted in place of the EUT. The log-periodic antenna will be driven by a signal generator and the level will be adjusted till the same power value on the spectrum analyzer or receiver. The level of the spurious emissions can be calculated through the level of the signal generator, cable loss, the gain of the substitution antenna and the reading of the spectrum analyzer or receiver.
4. The EUT is then put into continuously transmitting mode at its maximum power level during the test. Set Test Receiver or Spectrum RBW=1MHz, VBW=3MHz, And the maximum value of the receiver should be recorded as (Pr).
5. The EUT shall be replaced by a substitution antenna. In the chamber, an substitution antenna for the frequency band of interest is placed at the reference point of the chamber. An RF Signal source for the frequency band of interest is connected to the substitution antenna with a cable that has been constructed to not interfere with the radiation pattern of the antenna. A power (PMea) is applied to the input of the substitution antenna, and adjust the level of the signal generator output until the value of the receiver reach the previously recorded (Pr). The power of signal source (PMea) is recorded. The test should be performed by rotating the test item and adjusting the receiving antenna polarization.
6. A amplifier should be connected to the Signal Source output port. And the cable should be connect between the Amplifier and the Substitution Antenna. The cable loss (Pcl), the Substitution Antenna Gain (Ga) and the Amplifier Gain (PAg) should be recorded after test.
7. The measurement results are obtained as described below:  
$$\text{Power(EIRP)} = \text{PMea} - \text{PAg} - \text{Pcl} + \text{Ga}$$
  
The measurement results are amend as described below:  
$$\text{Power(EIRP)} = \text{PMea} - \text{Pcl} + \text{Ga}$$
8. This value is EIRP since the measurement is calibrated using an antenna of known gain (2.15 dBi) and known input power. ERP can be calculated from EIRP by subtracting the gain of the dipole,  $\text{ERP} = \text{EIRP} - 2.15\text{dBi}$ .

**Test setup**

**30MHz~~~ 1GHz**

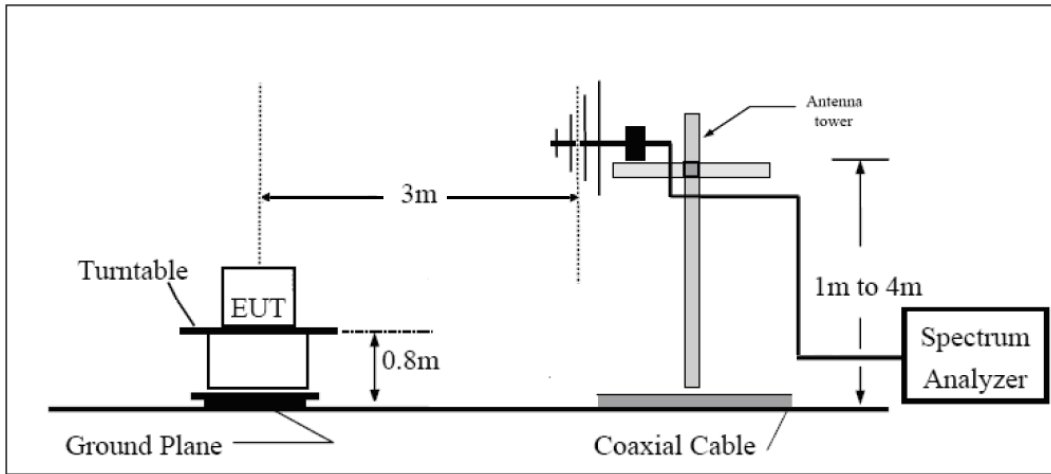

**Above 1GHz**

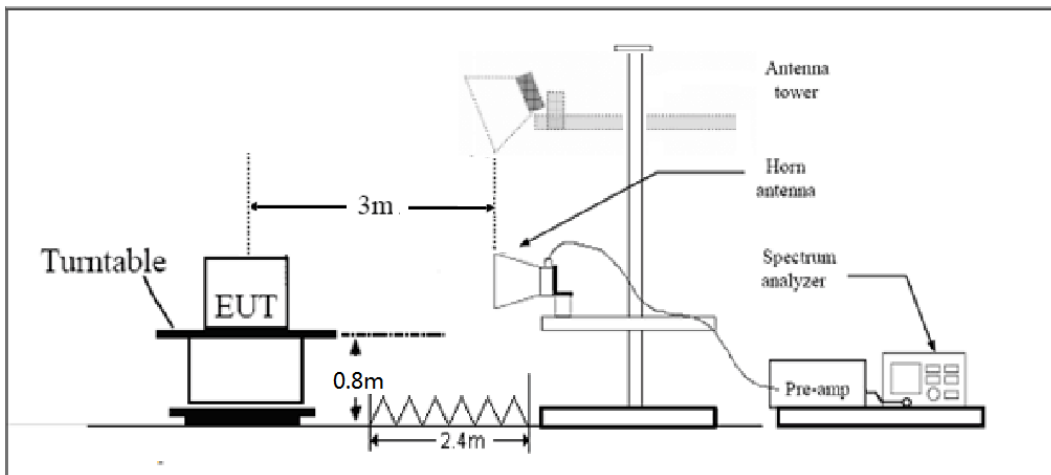

Note: Area side: 2.4mX3.6m

The radiated emission was measured in the following position: EUT stand-up position (Z axis), lie-down position (X, Y axis). The worst emission was found in lie-down position (Z axis) and the worst case was recorded.

**Limits**

Rule Part 24.238(a) specifies that “on any frequency outside a licensee's frequency block, the power of any emission shall be attenuated below the transmitter power (P) by at least 43 + 10 log10 (P) dB.”

Limit	-13 dBm
-------	---------

**Measurement Uncertainty**

The assessed measurement uncertainty to ensure 95% confidence level for the normal distribution is with the coverage factor  $k = 1.96$ ,  $U = 3.55$  dB.

**Test Result**

Sweep above 18 GHz don't have value significantly higher than the bottom noise.

## GSM 1900 CH-Low

Harmonic	Frequency (MHz)	SG (dBm)	Cable Loss (dB)	Gain (dBi)	Antenna Polarization	EIRP Level (dBm)	Limit (dBm)	Margin (dB)	Azimuth (deg)
2	3700.4	-57.65	5.1	11.05	Horizontal	-51.70	-13.00	38.70	90
3	5550.6	-56.93	5.42	12.65	Horizontal	-49.70	-13.00	36.70	45
4	7400.8	-52.45	6.7	13.85	Horizontal	-45.30	-13.00	32.30	135
5	9251.0	-52.64	7.01	14.75	Horizontal	-44.90	-13.00	31.90	270
6	11101.2	-50.87	7.48	15.95	Horizontal	-42.40	-13.00	29.40	91
7	12951.4	-50.54	7.51	16.55	Horizontal	-41.50	-13.00	28.50	45
8	14801.6	-45.51	8.24	15.35	Horizontal	-38.40	-13.00	25.40	0
9	16651.8	-45.54	8.41	14.95	Horizontal	-39.00	-13.00	26.00	90
10	18502.0	/	/	/	/	/	/	/	/

Note: 1. The other Spurious RF Radiated emissions level is no more than noise floor.  
2. The worst emission was found in the antenna is Horizontal position.

## GSM 1900 CH-Middle

Harmonic	Frequency (MHz)	SG (dBm)	Cable Loss (dB)	Gain (dBi)	Antenna Polarization	EIRP Level (dBm)	Limit (dBm)	Margin (dB)	Azimuth (deg)
2	3760.0	-55.57	5.1	11.05	Horizontal	-49.62	-13.00	36.62	270
3	5640.0	-57.27	5.42	12.65	Horizontal	-50.04	-13.00	37.04	0
4	7520.0	-53.60	6.7	13.85	Horizontal	-46.45	-13.00	33.45	45
5	9400.0	-51.54	7.01	14.75	Horizontal	-43.80	-13.00	30.80	90
6	11280.0	-48.17	7.48	15.95	Horizontal	-39.70	-13.00	26.70	270
7	13160.0	-50.44	7.51	16.55	Horizontal	-41.40	-13.00	28.40	225
8	15040.0	-47.61	8.24	15.35	Horizontal	-40.50	-13.00	27.50	45
9	16920.0	-45.74	8.41	14.95	Horizontal	-39.20	-13.00	26.20	0
10	18800.0	/	/	/	/	/	/	/	/

Note: 1. The other Spurious RF Radiated emissions level is no more than noise floor.  
2. The worst emission was found in the antenna is Horizontal position.



## GSM 1900 CH-High

Harmonic	Frequency (MHz)	SG (dBm)	Cable Loss (dB)	Gain (dBi)	Antenna Polarization	EIRP Level (dBm)	Limit (dBm)	Margin (dB)	Azimuth (deg)
2	3819.6	-53.24	5.1	11.05	Horizontal	-47.29	-13.00	34.29	135
3	5729.4	-55.63	5.42	12.65	Horizontal	-48.40	-13.00	35.40	90
4	7639.2	-54.35	6.7	13.85	Horizontal	-47.20	-13.00	34.20	45
5	9549.0	-52.84	7.01	14.75	Horizontal	-45.10	-13.00	32.10	90
6	11458.8	-50.57	7.48	15.95	Horizontal	-42.10	-13.00	29.10	225
7	13368.6	-50.54	7.51	16.55	Horizontal	-41.50	-13.00	28.50	270
8	15278.4	-47.51	8.24	15.35	Horizontal	-40.40	-13.00	27.40	135
9	17188.2	-44.34	8.41	14.95	Horizontal	-37.80	-13.00	24.80	180
10	19098.0	/	/	/	/	/	/	/	/

Note: 1. The other Spurious RF Radiated emissions level is no more than noise floor.

2. The worst emission was found in the antenna is Horizontal position.



## 6. Main Test Instruments

Name	Manufacturer	Type	Serial Number	Calibration Date	Expiration Date
Base Station Simulator	R&S	CMU200	118133	2017-05-14	2018-05-13
Base Station Simulator	R&S	CMU200	118133	2018-05-13	2019-05-12
Power Splitter	Hua Xiang	SHX-GF2-2-13	10120101	NA	NA
Spectrum Analyzer	Agilent	N9010A	MY47191109	2017-05-20	2018-05-19
Spectrum Analyzer	Agilent	N9010A	MY47191109	2018-05-20	2019-05-19
Universal Radio Communication Tester	Agilent	E5515C	MY48367192	2017-05-20	2018-05-19
Universal Radio Communication Tester	Agilent	E5515C	MY48367192	2018-05-20	2019-05-19
Signal Analyzer	R&S	FSV30	100815	2017-12-17	2018-12-16
EMI Test Receiver	R&S	ESCI	100948	2017-05-20	2018-05-19
EMI Test Receiver	R&S	ESCI	100948	2018-05-20	2019-05-19
Signal generator	R&S	SMB 100A	102594	2017-05-14	2018-05-13
Signal generator	R&S	SMB 100A	102594	2018-05-13	2019-05-12
Trilog Antenna	SCHWARZBECK	VUBL 9163	9163-201	2017-11-18	2020-11-17
Horn Antenna	R&S	HF907	100126	2014-12-06	2019-12-05
Climatic Chamber	Re Ce	PT-30B	20101891	2015-07-18	2018-07-17
Horn Antenna	ETS-Lindgren	3160-09	00102644	2015-01-30	2020-01-29
RF Cable	Agilent	SMA 15cm	0001	2018-02-03	2018-08-02
Preamplifier	R&S	SCU18	102327	2017-06-18	2018-06-17
Software	R&S	EMC32	V 8.52.0	/	/
MOB COMMS DC SUPPLY	Keysight	66319D	MY43004105	2017-05-14	2018-05-13

\*\*\*\*\*END OF REPORT \*\*\*\*\*



# ANNEX A: EUT Appearance and Test Setup

## A.1 EUT Appearance



a: EUT



Adapter 1



Adapter 2



Adapter 3



Adapter 4



Adapter 5  
b: Adapter





c: Charging Cradle



Earphone 1



Earphone 2  
d: Earphone



e: USB Cable



Battery 1



Battery 2

f: Battery

Picture 1 EUT and Accessory

## A.2 Test Setup



**Picture 2: Radiated Spurious Emissions Test setup**