

FCC Test Report

Report No.: RF180329C04

FCC ID: WS2-WS2119A0

Test Model: WS2119-A0

Series Model: WS2119-F0

Received Date: Mar. 29, 2018

Test Date: Apr. 19, 2018 ~ Jun. 19, 2018

Issued Date: Jun. 21, 2018

Applicant: JORJIN TECHNOLOGIES INC.

Address: 17F, No.239, Sec. 1, Datong Rd., Xizhi Dist., New Taipei City 221, Taiwan.

Issued By: Bureau Veritas Consumer Products Services (H.K.) Ltd., Taoyuan Branch

Lab Address: No. 47-2, 14th Ling, Chia Pau Vil., Lin Kou Dist., New Taipei City, Taiwan
(R.O.C)

Test Location: No.19, Hwa Ya 2nd Rd., Wen Hwa Vil., Kwei Shan Dist., Taoyuan City
33383, Taiwan, R.O.C.

**FCC Registration /
Designation Number:** 788550 / TW0003



This report is for your exclusive use. Any copying or replication of this report to or for any other person or entity, or use of our name or trademark, is permitted only with our prior written permission. This report sets forth our findings solely with respect to the test samples identified herein. The results set forth in this report are not indicative or representative of the quality or characteristics of the lot from which a test sample was taken or any similar or identical product unless specifically and expressly noted. Our report includes all of the tests requested by you and the results thereof based upon the information that you provided to us. You have 60 days from date of issuance of this report to notify us of any material error or omission caused by our negligence, provided, however, that such notice shall be in writing and shall specifically address the issue you wish to raise. A failure to raise such issue within the prescribed time shall constitute your unqualified acceptance of the completeness of this report, the tests conducted and the correctness of the report contents. Unless specific mention, the uncertainty of measurement has been explicitly taken into account to declare the compliance or non-compliance to the specification. The report must not be used by the client to claim product certification, approval, or endorsement by TAF or any government agencies.

Table of Contents

Release Control Record	4
1 Certificate of Conformity	5
2 Summary of Test Results	6
2.1 Measurement Uncertainty	6
2.2 Modification Record	6
3 General Information	7
3.1 General Description of EUT	7
3.2 Description of Test Modes	8
3.2.1 Test Mode Applicability and Tested Channel Detail	9
3.3 Duty Cycle of Test Signal	10
3.4 Description of Support Units	11
3.4.1 Configuration of System under Test	11
3.5 General Description of Applied Standards	11
4 Test Types and Results	12
4.1 Radiated Emission and Bandedge Measurement	12
4.1.1 Limits of Radiated Emission and Bandedge Measurement	12
4.1.2 Test Instruments	13
4.1.3 Test Procedures	14
4.1.4 Deviation from Test Standard	14
4.1.5 Test Set Up	15
4.1.6 EUT Operating Conditions	16
4.1.7 Test Results	17
4.2 Conducted Emission Measurement	29
4.2.1 Limits of Conducted Emission Measurement	29
4.2.2 Test Instruments	29
4.2.3 Test Procedures	29
4.2.4 Deviation from Test Standard	30
4.2.5 Test Setup	30
4.2.6 EUT Operating Conditions	30
4.2.7 Test Results	31
4.3 6 dB Bandwidth Measurement	33
4.3.1 Limits of 6 dB Bandwidth Measurement	33
4.3.2 Test Setup	33
4.3.3 Test Instruments	33
4.3.4 Test Procedure	33
4.3.5 Deviation from Test Standard	33
4.3.6 EUT Operating Conditions	33
4.3.7 Test Results	34
4.4 Occupied Bandwidth Measurement	35
4.4.1 Test Setup	35
4.4.2 Test Instruments	35
4.4.3 Test Procedure	35
4.4.4 Deviation from Test Standard	35
4.4.5 EUT Operating Conditions	35
4.4.6 Test Results	36
4.5 Conducted Output Power Measurement	37
4.5.1 Limits of Conducted Output Power Measurement	37
4.5.2 Test Setup	37
4.5.3 Test Instruments	37
4.5.4 Test Procedures	37
4.5.5 Deviation from Test Standard	37
4.5.6 EUT Operating Conditions	37
4.5.7 Test Results	37

4.6	Power Spectral Density Measurement	38
4.6.1	Limits of Power Spectral Density Measurement.....	38
4.6.2	Test Setup.....	38
4.6.3	Test Instruments	38
4.6.4	Test Procedure	38
4.6.5	Deviation from Test Standard	38
4.6.6	EUT Operating Condition	38
4.6.7	Test Results	39
4.7	Conducted Out of Band Emission Measurement	40
4.7.1	Limits of Conducted Out of Band Emission Measurement.....	40
4.7.2	Test Setup.....	40
4.7.3	Test Instruments	40
4.7.4	Test Procedure	40
4.7.5	Deviation from Test Standard	40
4.7.6	EUT Operating Condition	40
4.7.7	Test Results	41
5	Pictures of Test Arrangements.....	43
	Appendix – Information on the Testing Laboratories	44

Release Control Record

Issue No.	Description	Date Issued
RF180329C04	Original Release	Jun. 21, 2018

1 Certificate of Conformity

Product: BLE and Sigfox wireless module
Brand: Jorjin
Test Model: WS2119-A0
Series Model: WS2119-F0
Sample Status: Engineering Sample
Applicant: JORJIN TECHNOLOGIES INC.
Test Date: Apr. 19, 2018 ~ Jun. 19, 2018
Standards: 47 CFR FCC Part 15, Subpart C (Section 15.247)
ANSI C63.10:2013

The above equipment has been tested by **Bureau Veritas Consumer Products Services (H.K.) Ltd., Taoyuan Branch**, and found compliance with the requirement of the above standards. The test record, data evaluation & Equipment Under Test (EUT) configurations represented herein are true and accurate accounts of the measurements of the sample's RF characteristics under the conditions specified in this report.

Prepared by : Evonne Liu, **Date:** Jun. 21, 2018
Evonne Liu / Specialist

Approved by : Dylan Chiou, **Date:** Jun. 21, 2018
Dylan Chiou / Project Engineer

2 Summary of Test Results

47 CFR FCC Part 15, Subpart C (Section 15.247)			
FCC Clause	Test Item	Result	Remarks
15.207	AC Power Conducted Emission	Pass	Meet the requirement of limit. Minimum passing margin is -12.35 dB at 0.16125 MHz.
15.205 & 209	Radiated Emissions	Pass	Meet the requirement of limit. Minimum passing margin is -1.18 dB at 2483.52 MHz.
15.247(d)	Band Edge Measurement	Pass	Meet the requirement of limit.
15.247(d)	Antenna Port Emission	Pass	Meet the requirement of limit.
15.247(a)(2)	6 dB Bandwidth	Pass	Meet the requirement of limit.
---	Occupied Bandwidth Measurement	Pass	Reference only
15.247(b)	Conducted Power	Pass	Meet the requirement of limit.
15.247(e)	Power Spectral Density	Pass	Meet the requirement of limit.
15.203	Antenna Requirement	Pass	No antenna connector is used.

2.1 Measurement Uncertainty

Where relevant, the following measurement uncertainty levels have been estimated for tests performed on the EUT:

The listed uncertainties are the worst case uncertainty for the entire range of measurement. Please note that the uncertainty values are provided for informational purposes only and are not used in determining the PASS/FAIL results.

Measurement	Frequency	Expanded Uncertainty (k=2) (±)
Conducted Emissions at mains ports	150 kHz ~ 30 MHz	2.44 dB
Radiated Emissions up to 1 GHz	30 MHz ~ 200 MHz	2.93 dB
	200 MHz ~ 1000 MHz	2.95 dB
Radiated Emissions above 1 GHz	1 GHz ~ 18 GHz	2.26 dB
	18 GHz ~ 40 GHz	1.94 dB

2.2 Modification Record

There were no modifications required for compliance.

3 General Information

3.1 General Description of EUT

Product	BLE and Sigfox wireless module
Brand	Jorjin
Test Model	WS2119-A0
Series Model	WS2119-F0
Status of EUT	Engineering Sample
Power Supply Rating	DC 3.3 V (host equipment)
Modulation Type	GFSK
Transfer Rate	1 Mbps
Operating Frequency	2402 ~ 2480 MHz
Number of Channel	40
Output Power	7.345 mW
Antenna Type	Refer to Note as below
Antenna Connector	N/A
Accessory Device	Refer to Note as below
Data Cable Supplied	Refer to Note as below

Note:

1. All models are listed as below.

Brand	Model	Difference
Jorjin	WS2119-A0	All models are electrically identical, different model names and IC is for marketing purpose.
	WS2119-F0	

2. The antenna information is listed as below.

No	Ant. Type	Brand	Model No.	Connector Type	Antenna Gain (dBi)	
					BT LE	Sigfox
1	PCB	Unictron	H2B1BC2A1B0200	i-pex(MHF)	3.58	
2	PCB	Unictron	H2B1BE1A1B0200	i-pex(MHF)	4.13	
3	Dipole	WIESON	GPOT155-002	reverse SMA	2.61	
4	Dipole	SANAV	EEN-107	reverse SMA		3.53
5	PCB	Unictron	H2B1SD1A2C0100	i-pex(MHF)		1.9
6	PCB	Unictron	H2B1SG2A2C0100	i-pex(MHF)		1.8

3. This device has 4 configurations as below.

Mode A: Model: WS2119-A0 was chosen antenna no. 2 to test.

Mode B: Model: WS2119-A0 was chosen antenna no. 3 to test.

Mode C: Model: WS2119-F0 was chosen antenna no. 2 to test.

Mode D: Model: WS2119-F0 was chosen antenna no. 3 to test.

4. The above EUT information is declared by manufacturer and for more detailed features description, please refers to the manufacturer's specifications or User's Manual.

3.2 Description of Test Modes

40 channels are provided to this EUT:

Channel	Freq. (MHz)	Channel	Freq. (MHz)	Channel	Freq. (MHz)	Channel	Freq. (MHz)
0	2402	10	2422	20	2442	30	2462
1	2404	11	2424	21	2444	31	2464
2	2406	12	2426	22	2446	32	2466
3	2408	13	2428	23	2448	33	2468
4	2410	14	2430	24	2450	34	2470
5	2412	15	2432	25	2452	35	2472
6	2414	16	2434	26	2454	36	2474
7	2416	17	2436	27	2456	37	2476
8	2418	18	2438	28	2458	38	2478
9	2420	19	2440	29	2460	39	2480

3.2.1 Test Mode Applicability and Tested Channel Detail

EUT Configure Mode	Applicable To				Description
	RE \geq 1G	RE<1G	PLC	APCM	
A	√	√	√	√	-
B	√	√	-	-	-
C	√	√	-	-	-
D	√	√	-	-	-

Where **RE \geq 1G**: Radiated Emission above 1 GHz **RE<1G**: Radiated Emission below 1 GHz
PLC: Power Line Conducted Emission **APCM**: Antenna Port Conducted Measurement

Note: The EUT had been pre-tested on the positioned of each 3 axis. The worst case was found when positioned on **Y-plane** for Mode A, C and **Z-plane** for Mode B, D.

Note: "-" means no effect.

Radiated Emission Test (Above 1 GHz):

- Pre-Scan has been conducted to determine the worst-case mode from all possible combinations between available modulations, data rates and antenna ports (if EUT with antenna diversity architecture).
- Following channel(s) was (were) selected for the final test as listed below.

EUT Configure Mode	Available Channel	Tested Channel	Modulation Type	Data Rate (Mbps)
A, B	0 to 39	0, 19, 39	GFSK	1
C	0 to 39	0	GFSK	1
D	0 to 39	39	GFSK	1

Radiated Emission Test (Below 1 GHz):

- Pre-Scan has been conducted to determine the worst-case mode from all possible combinations between available modulations, data rates and antenna ports (if EUT with antenna diversity architecture).
- Following channel(s) was (were) selected for the final test as listed below.

EUT Configure Mode	Available Channel	Tested Channel	Modulation Type	Data Rate (Mbps)
A, C	0 to 39	0	GFSK	1
B, D	0 to 39	39	GFSK	1

Power Line Conducted Emission Test:

- Pre-Scan has been conducted to determine the worst-case mode from all possible combinations between available modulations, data rates and antenna ports (if EUT with antenna diversity architecture).
- Following channel(s) was (were) selected for the final test as listed below.

EUT Configure Mode	Available Channel	Tested Channel	Modulation Type	Data Rate (Mbps)
A	0 to 39	0	GFSK	1

Antenna Port Conducted Measurement:

- This item includes all test value of each mode, but only includes spectrum plot of worst value of each mode.
- Pre-Scan has been conducted to determine the worst-case mode from all possible combinations between available modulations, data rates and antenna ports (if EUT with antenna diversity architecture).
- Following channel(s) was (were) selected for the final test as listed below.

EUT Configure Mode	Available Channel	Tested Channel	Modulation Type	Data Rate (Mbps)
A	0 to 39	0, 19, 39	GFSK	1

Test Condition:

Applicable To	Environmental Conditions	Input Power	Tested by
RE≥1G	25 deg. C, 65 % RH	120 Vac, 60 Hz	Getaz Yang, Jisyong Wang
RE<1G	25 deg. C, 65 % RH	120 Vac, 60 Hz	Jisyong Wang
PLC	25 deg. C, 65 % RH	120 Vac, 60 Hz	Getaz Yang
APCM	25 deg. C, 65 % RH	120 Vac, 60 Hz	Gavin Wu

3.3 Duty Cycle of Test Signal

Duty cycle of test signal is < 98 %, duty factor shall be considered.

Duty cycle = 0.38/0.625 = 0.608, Duty factor = 10 * log(1/0.608) = 2.16

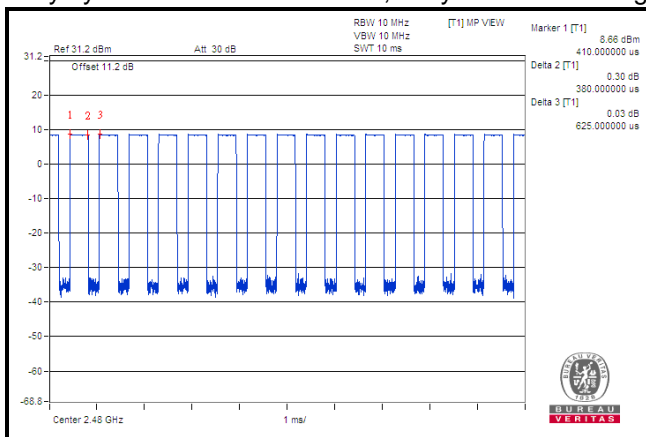

3.4 Description of Support Units

The EUT has been tested as an independent unit together with other necessary accessories or support units. The following support units or accessories were used to form a representative test configuration during the tests.

No.	Product	Brand	Model No.	Serial No.	FCC ID
1.	Notebook	N/A	N/A	N/A	N/A

No.	Signal Cable Description Of The Above Support Units
1.	N/A

Note:

1. All power cords of the above support units are non-shielded (1.8m).

3.4.1 Configuration of System under Test

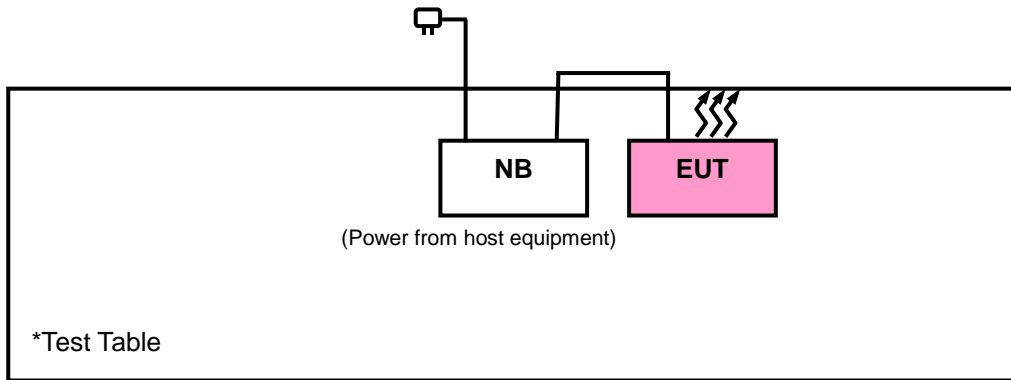

3.5 General Description of Applied Standards

The EUT is a RF Product. According to the specifications of the manufacturer, it must comply with the requirements of the following standards:

FCC Part 15, Subpart C (15.247)

KDB 558074 D01 DTS Meas Guidance v04

ANSI C63.10-2013

All test items have been performed and recorded as per the above standards.

4 Test Types and Results

4.1 Radiated Emission and Bandedge Measurement

4.1.1 Limits of Radiated Emission and Bandedge Measurement

Radiated emissions which fall in the restricted bands must comply with the radiated emission limits specified as below table. Other emissions shall be at least 20 dB below the highest level of the desired power:

Frequencies (MHz)	Field Strength (microvolts/meter)	Measurement Distance (meters)
0.009 ~ 0.490	2400/F (kHz)	300
0.490 ~ 1.705	24000/F (kHz)	30
1.705 ~ 30.0	30	30
30 ~ 88	100	3
88 ~ 216	150	3
216 ~ 960	200	3
Above 960	500	3

Note:

1. The lower limit shall apply at the transition frequencies.
2. Emission level (dBuV/m) = 20 log Emission level (uV/m).
3. For frequencies above 1000 MHz, the field strength limits are based on average detector, however, the peak field strength of any emission shall not exceed the maximum permitted average limits, specified above by more than 20 dB under any condition of modulation.

4.1.2 Test Instruments

Description & Manufacturer	Model No.	Serial No.	Date of Calibration	Due Date of Calibration
Test Receiver ROHDE & SCHWARZ	ESCI	100424	Oct. 17, 2017	Oct. 16, 2018
Spectrum Analyzer Agilent	N9010A	MY52220207	Dec. 07, 2017	Dec. 06, 2018
Spectrum Analyzer ROHDE & SCHWARZ	FSP40	100041	Dec. 12, 2017	Dec. 11, 2018
BILOG Antenna SCHWARZBECK	VULB9168	9168-171	Dec. 11, 2017	Dec. 10, 2018
HORN Antenna SCHWARZBECK	9120D	209	Dec. 13, 2017	Dec. 12, 2018
HORN Antenna SCHWARZBECK	BBHA 9170	BBHA9170241	Dec. 01, 2017	Nov. 30, 2018
Fixed Attenuator Mini-Circuits	BW-N10W5+	NA	Jul. 07, 2017	Jul. 06, 2018
Loop Antenna	EM-6879	269	Aug. 11, 2017	Aug. 10, 2018
Preamplifier EMCI	EMC001340	980201	Nov. 01, 2017	Oct. 31, 2018
Bluetooth Tester	CBT	100946	Jul. 29, 2016	Jul. 28, 2018
Preamplifier EMCI	EMC 012645	980115	Oct. 20, 2017	Oct. 19, 2018
Preamplifier EMCI	EMC 184045	980116	Oct. 20, 2017	Oct. 19, 2018
Preamplifier EMCI	EMC 330H	980112	Oct. 20, 2017	Oct. 19, 2018
Power Meter Anritsu	ML2495A	1012010	Aug. 15, 2017	Aug. 14, 2018
Power Sensor Anritsu	MA2411B	1315050	Aug. 15, 2017	Aug. 14, 2018
RF Coaxial Cable	8D-FB	Cable-RF3-04	Oct. 19, 2017	Oct. 18, 2018
RF signal cable HUBER+SUHNER	SUCOFLEX 104	230129/4	Oct. 19, 2017	Oct. 18, 2018
RF signal cable HUBER+SUHNER	SUCOFLEX 104	250723/4	Oct. 19, 2017	Oct. 18, 2018
Software BV ADT	E3 6.120103	NA	NA	NA
Antenna Tower MF	MFA-440H	NA	NA	NA
Turn Table MF	MFT-201SS	NA	NA	NA
Antenna Tower & Turn Table Controller MF	MF-7802	NA	NA	NA

- Note: 1. The calibration interval of the above test instruments is 12 months and the calibrations are traceable to NML/ROC and NIST/USA.
2. The test was performed in HwaYa Chamber 10.
3. The horn antenna and preamplifier (model: EMC 184045) are used only for the measurement of emission frequency above 1GHz if tested.
4. The IC Site Registration No. is IC7450F-10.

4.1.3 Test Procedures

For Radiated Emission below 30 MHz

- a. The EUT was placed on the top of a rotating table 0.8 meters above the ground at a 3 meter chamber room. The table was rotated 360 degrees to determine the position of the highest radiation.
- b. The EUT was set 3 meters away from the interference-receiving antenna, which was mounted on the top of a variable-height antenna tower.
- c. Parallel, perpendicular, and ground-parallel orientations of the antenna are set to make the measurement.
- d. For each suspected emission, the EUT was arranged to its worst case and the rotatable table was turned from 0 degrees to 360 degrees to find the maximum reading.
- e. The test-receiver system was set to Quasi-Peak Detect Function and Specified Bandwidth with Maximum Hold Mode.

Note:

1. The resolution bandwidth and video bandwidth of test receiver/spectrum analyzer is 9 kHz at frequency below 30 MHz.

For Radiated Emission above 30 MHz

- a. The EUT was placed on the top of a rotating table 0.8 meters (for 30 MHz ~ 1 GHz) / 1.5 meters (for above 1 GHz) above the ground at 3 meter chamber room for test. The table was rotated 360 degrees to determine the position of the highest radiation.
- b. The EUT was set 3 meters away from the interference-receiving antenna, which was mounted on the top of a variable-height antenna tower.
- c. The height of antenna is varied from one meter to four meters above the ground to determine the maximum value of the field strength. Both horizontal and vertical polarizations of the antenna are set to make the measurement.
- d. For each suspected emission, the EUT was arranged to its worst case and then the antenna was tuned to heights from 1 meter to 4 meters and the rotatable table was turned from 0 degrees to 360 degrees to find the maximum reading.
- e. The test-receiver system was set to quasi-peak detect function and specified bandwidth with maximum hold mode when the test frequency is below 1 GHz.
- f. The test-receiver system was set to peak and average detected function and specified bandwidth with maximum hold mode when the test frequency is above 1 GHz. If the peak reading value also meets average limit, measurement with the average detector is unnecessary.

Note:

1. The resolution bandwidth and video bandwidth of test receiver/spectrum analyzer is 120 kHz for Quasi-peak detection (QP) at frequency below 1 GHz.
2. The resolution bandwidth of test receiver/spectrum analyzer is 1 MHz and the video bandwidth is 3 MHz for Peak detection (PK) at frequency above 1 GHz.
3. The resolution bandwidth of test receiver/spectrum analyzer is 1 MHz and the video bandwidth is $\geq 1/T$ (Duty cycle < 98 %) or 10 Hz (Duty cycle ≥ 98 %) for Average detection (AV) at frequency above 1 GHz. (RBW = 1 MHz, VBW = 3 kHz)
4. All modes of operation were investigated and the worst-case emissions are reported.

4.1.4 Deviation from Test Standard

No deviation.

4.1.5 Test Set Up

<Radiated Emission below 30 MHz>

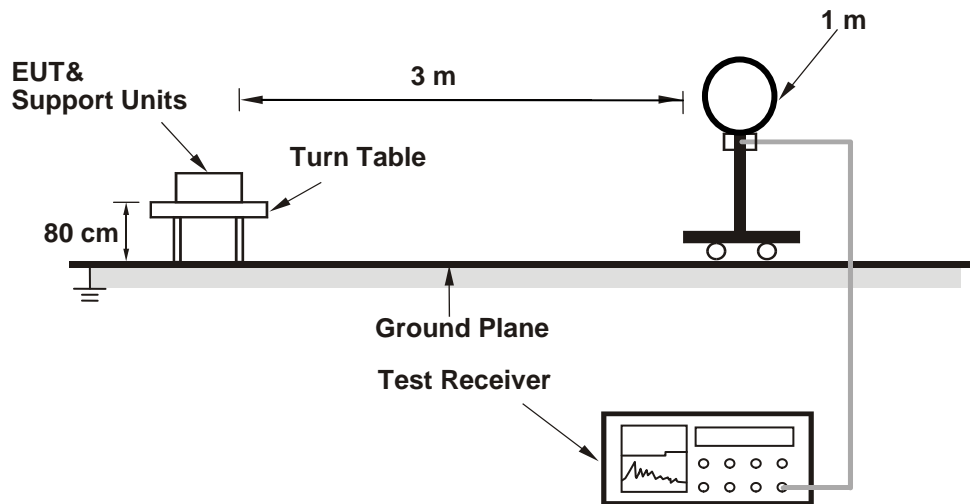

<Radiated Emission 30 MHz to 1 GHz>

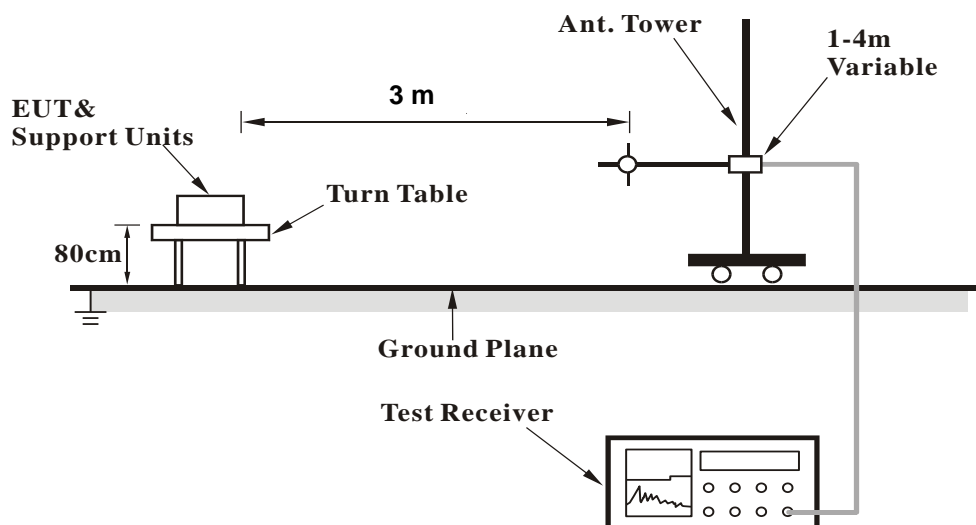

<Radiated Emission above 1 GHz>

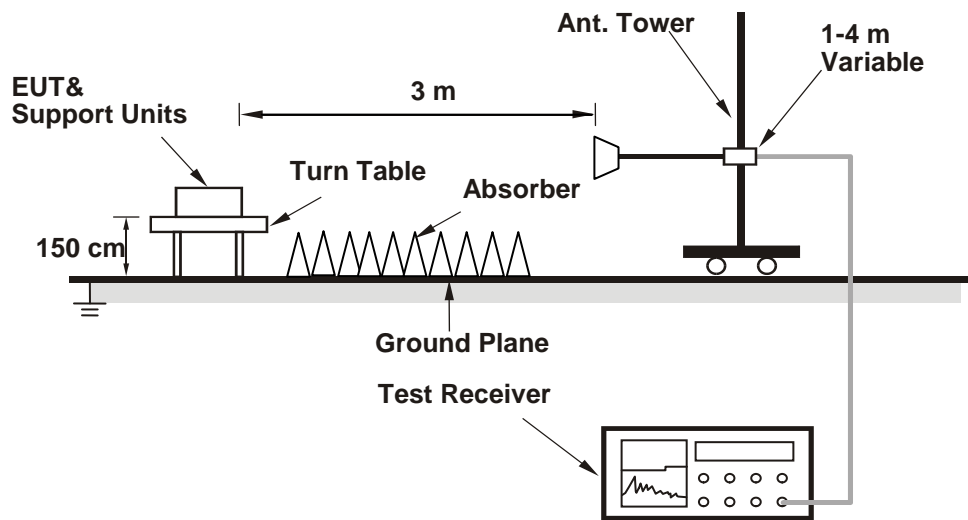

For the actual test configuration, please refer to the attached file (Test Setup Photo).

4.1.6 EUT Operating Conditions

- a. Placed the EUT on the testing table.
- b. Set the EUT under transmission condition continuously at specific channel frequency.

4.1.7 Test Results

Above 1 GHz Data:
Mode A

EUT Test Condition		Measurement Detail	
Channel	Channel 0	Frequency Range	1 GHz ~ 25 GHz
Input Power	120 Vac, 60 Hz	Detector Function	Peak (PK) Average (AV)
Environmental Conditions	25 deg. C, 65 % RH	Tested By	Getaz Yang

Antennal Polarity & Test Distance: Horizontal at 3 m										
Frequency (MHz)	Emission Level (dBuV/m)	Read Level (dBuV)	Limit (dBuV/m)	Margin (dB)	Antenna Factor (dB/m)	Cable Loss (dB)	Preamp Factor (dB)	Antenna Height (cm)	Table Angle (Degree)	Remark
2389.94	36.67	42.66	54	-17.33	27.16	4.35	37.5	210	217	Average
2389.94	53.42	59.42	74	-20.58	27.16	4.36	37.52	210	217	Peak
2402	96.82	102.81			27.16	4.37	37.52	210	217	Average
2402	97.59	103.58			27.16	4.37	37.52	210	217	Peak
4804	50.62	65.59	54	-3.38	31.14	6.79	52.9	139	64	Average
4804	53.19	68.16	74	-20.81	31.14	6.79	52.9	139	64	Peak

Antennal Polarity & Test Distance: Vertical at 3 m										
Frequency (MHz)	Emission Level (dBuV/m)	Read Level (dBuV)	Limit (dBuV/m)	Margin (dB)	Antenna Factor (dB/m)	Cable Loss (dB)	Preamp Factor (dB)	Antenna Height (cm)	Table Angle (Degree)	Remark
2389.52	43.39	49.38	54	-10.61	27.16	4.35	37.5	158	245	Average
2389.52	62.89	68.87	74	-11.11	27.16	4.36	37.5	158	245	Peak
2402	106.63	112.62			27.16	4.37	37.52	158	245	Average
2402	107.4	113.39			27.16	4.37	37.52	158	245	Peak
4804	46.77	61.74	54	-7.23	31.14	6.79	52.9	140	86	Average
4804	51.02	65.99	74	-22.98	31.14	6.79	52.9	140	86	Peak

Remarks:

- Emission Level = Read Level + Antenna Factor + Cable Loss - Preamp Factor
Margin value = Emission level – Limit value
- 2402 MHz: Fundamental frequency.

EUT Test Condition		Measurement Detail	
Channel	Channel 19	Frequency Range	1 GHz ~ 25 GHz
Input Power	120 Vac, 60 Hz	Detector Function	Peak (PK) Average (AV)
Environmental Conditions	25 deg. C, 65 % RH	Tested By	Getaz Yang

Antennal Polarity & Test Distance: Horizontal at 3 m										
Frequency (MHz)	Emission Level (dBuV/m)	Read Level (dBuV)	Limit (dBuV/m)	Margin (dB)	Antenna Factor (dB/m)	Cable Loss (dB)	Preamp Factor (dB)	Antenna Height (cm)	Table Angle (Degree)	Remark
2381.26	35.98	42.06	54	-18.02	27.08	4.34	37.5	208	222	Average
2381.26	49.74	55.81	74	-24.26	27.08	4.35	37.5	208	222	Peak
2440	97.92	103.6			27.38	4.4	37.46	208	222	Average
2440	98.66	104.34			27.38	4.4	37.46	208	222	Peak
2496.52	36.03	41.23	54	-17.97	27.61	4.44	37.25	208	222	Average
2496.52	48.74	53.94	74	-25.26	27.61	4.44	37.25	208	222	Peak
4880	48.91	63.66	54	-5.09	31.25	6.86	52.86	110	65	Average
4880	52.66	67.41	74	-21.34	31.25	6.86	52.86	110	65	Peak

Antennal Polarity & Test Distance: Vertical at 3 m										
Frequency (MHz)	Emission Level (dBuV/m)	Read Level (dBuV)	Limit (dBuV/m)	Margin (dB)	Antenna Factor (dB/m)	Cable Loss (dB)	Preamp Factor (dB)	Antenna Height (cm)	Table Angle (Degree)	Remark
2389.52	38.53	44.61	54	-15.47	27.08	4.34	37.5	154	244	Average
2389.52	55.38	61.36	74	-18.62	27.16	4.36	37.5	154	244	Peak
2440	107.47	113.15			27.38	4.4	37.46	154	244	Average
2440	108.22	113.9			27.38	4.4	37.46	154	244	Peak
2488.04	37.44	42.72	54	-16.56	27.61	4.43	37.32	154	244	Average
2488.04	53.45	58.81	74	-20.55	27.53	4.43	37.32	154	244	Peak
4880	45.32	60.07	54	-8.68	31.25	6.86	52.86	115	86	Average
4880	48.94	63.69	74	-25.06	31.25	6.86	52.86	115	86	Peak

Remarks:

- Emission Level = Read Level + Antenna Factor + Cable Loss - Preamp Factor
Margin value = Emission level – Limit value
- 2440 MHz: Fundamental frequency.

EUT Test Condition		Measurement Detail	
Channel	Channel 39	Frequency Range	1 GHz ~ 25 GHz
Input Power	120 Vac, 60 Hz	Detector Function	Peak (PK) Average (AV)
Environmental Conditions	25 deg. C, 65 % RH	Tested By	Getaz Yang

Antennal Polarity & Test Distance: Horizontal at 3 m										
Frequency (MHz)	Emission Level (dBuV/m)	Read Level (dBuV)	Limit (dBuV/m)	Margin (dB)	Antenna Factor (dB/m)	Cable Loss (dB)	Preamp Factor (dB)	Antenna Height (cm)	Table Angle (Degree)	Remark
2480	93.46	98.82			27.53	4.43	37.32	149	222	Average
2480	94.16	99.52			27.53	4.43	37.32	149	222	Peak
2483.52	37.59	42.95	54	-16.41	27.53	4.43	37.32	149	222	Average
2483.52	61.62	66.98	74	-12.38	27.53	4.43	37.32	149	222	Peak
4960	47.7	62.32	54	-6.3	31.4	6.9	52.92	102	74	Average
4960	51.91	66.53	74	-22.09	31.4	6.9	52.92	102	74	Peak

Antennal Polarity & Test Distance: Vertical at 3 m										
Frequency (MHz)	Emission Level (dBuV/m)	Read Level (dBuV)	Limit (dBuV/m)	Margin (dB)	Antenna Factor (dB/m)	Cable Loss (dB)	Preamp Factor (dB)	Antenna Height (cm)	Table Angle (Degree)	Remark
2480	102.3	107.66			27.53	4.43	37.32	154	246	Average
2480	103.04	108.4			27.53	4.43	37.32	154	246	Peak
2483.52	47.99	53.35	54	-6.01	27.53	4.43	37.32	154	246	Average
2483.52	72.82	78.18	74	-1.18	27.53	4.43	37.32	154	246	Peak
4960	45.03	59.65	54	-8.97	31.4	6.9	52.92	116	88	Average
4960	47.36	61.98	74	-26.64	31.4	6.9	52.92	116	88	Peak

Remarks:

- Emission Level = Read Level + Antenna Factor + Cable Loss - Preamp Factor
Margin value = Emission level – Limit value
- 2480 MHz: Fundamental frequency.

Mode B

EUT Test Condition		Measurement Detail	
Channel	Channel 0	Frequency Range	1 GHz ~ 25 GHz
Input Power	120 Vac, 60 Hz	Detector Function	Peak (PK) Average (AV)
Environmental Conditions	25 deg. C, 65 % RH	Tested By	Getaz Yang

Antennal Polarity & Test Distance: Horizontal at 3 m										
Frequency (MHz)	Emission Level (dBuV/m)	Read Level (dBuV)	Limit (dBuV/m)	Margin (dB)	Antenna Factor (dB/m)	Cable Loss (dB)	Preamp Factor (dB)	Antenna Height (cm)	Table Angle (Degree)	Remark
2390	35	41	54	-19	27.16	4.36	37.52	152	111	Average
2390	52.14	58.14	74	-21.86	27.16	4.36	37.52	152	111	Peak
2402	95.11	101.1			27.16	4.37	37.52	152	111	Average
2402	96.22	102.21			27.16	4.37	37.52	152	111	Peak
4804	45.65	60.62	54	-8.35	31.14	6.79	52.9	152	132	Average
4804	50.21	65.18	74	-23.79	31.14	6.79	52.9	152	132	Peak
Antennal Polarity & Test Distance: Vertical at 3 m										
Frequency (MHz)	Emission Level (dBuV/m)	Read Level (dBuV)	Limit (dBuV/m)	Margin (dB)	Antenna Factor (dB/m)	Cable Loss (dB)	Preamp Factor (dB)	Antenna Height (cm)	Table Angle (Degree)	Remark
2389	35.91	41.89	54	-18.09	27.16	4.36	37.5	165	212	Average
2389	62.12	68.1	74	-11.88	27.16	4.36	37.5	165	212	Peak
2402	105.26	111.25			27.16	4.37	37.52	165	212	Average
2402	106.41	112.4			27.16	4.37	37.52	165	212	Peak
4804	48.63	63.6	54	-5.37	31.14	6.79	52.9	111	21	Average
4804	52.65	67.62	74	-21.35	31.14	6.79	52.9	111	21	Peak

Remarks:

- Emission Level = Read Level + Antenna Factor + Cable Loss - Preamp Factor
Margin value = Emission level – Limit value
- 2402 MHz: Fundamental frequency.

EUT Test Condition		Measurement Detail	
Channel	Channel 19	Frequency Range	1 GHz ~ 25 GHz
Input Power	120 Vac, 60 Hz	Detector Function	Peak (PK) Average (AV)
Environmental Conditions	25 deg. C, 65 % RH	Tested By	Getaz Yang

Antennal Polarity & Test Distance: Horizontal at 3 m										
Frequency (MHz)	Emission Level (dBuV/m)	Read Level (dBuV)	Limit (dBuV/m)	Margin (dB)	Antenna Factor (dB/m)	Cable Loss (dB)	Preamp Factor (dB)	Antenna Height (cm)	Table Angle (Degree)	Remark
2390	35.1	41.18	54	-18.9	27.08	4.34	37.5	111	152	Average
2390	49.1	55.17	74	-24.9	27.08	4.35	37.5	111	152	Peak
2440	97.01	102.69			27.38	4.4	37.46	111	152	Average
2440	97.52	103.2			27.38	4.4	37.46	111	152	Peak
2483.52	35.85	41.05	54	-18.15	27.61	4.44	37.25	111	152	Average
2483.52	48.01	53.21	74	-25.99	27.61	4.44	37.25	111	152	Peak
4880	45.12	59.87	54	-8.88	31.25	6.86	52.86	201	111	Average
4880	48.63	63.38	74	-25.37	31.25	6.86	52.86	201	111	Peak

Antennal Polarity & Test Distance: Vertical at 3 m										
Frequency (MHz)	Emission Level (dBuV/m)	Read Level (dBuV)	Limit (dBuV/m)	Margin (dB)	Antenna Factor (dB/m)	Cable Loss (dB)	Preamp Factor (dB)	Antenna Height (cm)	Table Angle (Degree)	Remark
2389.9	38.01	44.09	54	-15.99	27.08	4.34	37.5	102	111	Average
2389.9	54.85	60.83	74	-19.15	27.16	4.36	37.5	102	111	Peak
2440	106.21	111.89			27.38	4.4	37.46	102	111	Average
2440	107.36	113.04			27.38	4.4	37.46	102	111	Peak
2489	36.52	41.8	54	-17.48	27.61	4.43	37.32	102	111	Average
2489	52.63	57.99	74	-21.37	27.53	4.43	37.32	102	111	Peak
4880	47.56	62.31	54	-6.44	31.25	6.86	52.86	132	251	Average
4880	51.02	65.77	74	-22.98	31.25	6.86	52.86	132	251	Peak

Remarks:

- Emission Level = Read Level + Antenna Factor + Cable Loss - Preamp Factor
Margin value = Emission level – Limit value
- 2440 MHz: Fundamental frequency.

EUT Test Condition		Measurement Detail	
Channel	Channel 39	Frequency Range	1 GHz ~ 25 GHz
Input Power	120 Vac, 60 Hz	Detector Function	Peak (PK) Average (AV)
Environmental Conditions	25 deg. C, 65 % RH	Tested By	Getaz Yang

Antennal Polarity & Test Distance: Horizontal at 3 m										
Frequency (MHz)	Emission Level (dBuV/m)	Read Level (dBuV)	Limit (dBuV/m)	Margin (dB)	Antenna Factor (dB/m)	Cable Loss (dB)	Preamp Factor (dB)	Antenna Height (cm)	Table Angle (Degree)	Remark
2480	92.52	97.88			27.53	4.43	37.32	165	121	Average
2480	93.78	99.14			27.53	4.43	37.32	165	121	Peak
2483.5	37.12	42.48	54	-16.88	27.53	4.43	37.32	165	121	Average
2483.5	60.62	65.98	74	-13.38	27.53	4.43	37.32	165	121	Peak
4960	42.04	56.7	54	-11.96	31.31	6.88	52.85	152	111	Average
4960	46.85	61.51	74	-27.15	31.31	6.88	52.85	152	111	Peak
Antennal Polarity & Test Distance: Vertical at 3 m										
Frequency (MHz)	Emission Level (dBuV/m)	Read Level (dBuV)	Limit (dBuV/m)	Margin (dB)	Antenna Factor (dB/m)	Cable Loss (dB)	Preamp Factor (dB)	Antenna Height (cm)	Table Angle (Degree)	Remark
2480	101.52	106.88			27.53	4.43	37.32	132	172	Average
2480	102.11	107.47			27.53	4.43	37.32	132	172	Peak
2483.5	47.52	52.88	54	-6.48	27.53	4.43	37.32	132	172	Average
2483.5	71.82	77.18	74	-2.18	27.53	4.43	37.32	132	172	Peak
4960	48.36	62.98	54	-5.64	31.4	6.9	52.92	102	111	Average
4960	50.65	65.27	74	-23.35	31.4	6.9	52.92	102	111	Peak

Remarks:

- Emission Level = Read Level + Antenna Factor + Cable Loss - Preamp Factor
Margin value = Emission level – Limit value
- 2480 MHz: Fundamental frequency.

Mode C

EUT Test Condition		Measurement Detail	
Channel	Channel 0	Frequency Range	1 GHz ~ 25 GHz
Input Power	120 Vac, 60 Hz	Detector Function	Peak (PK) Average (AV)
Environmental Conditions	25 deg. C, 65 % RH	Tested By	Jisyong Wang

Antennal Polarity & Test Distance: Horizontal at 3 m										
Frequency (MHz)	Emission Level (dBuV/m)	Read Level (dBuV)	Limit (dBuV/m)	Margin (dB)	Antenna Factor (dB/m)	Cable Loss (dB)	Preamp Factor (dB)	Antenna Height (cm)	Table Angle (Degree)	Remark
2389.94	36.01	42	54	-17.99	27.16	4.35	37.5	251	141	Average
2389.94	52.74	58.74	74	-21.26	27.16	4.36	37.52	251	141	Peak
2402	96.01	102			27.16	4.37	37.52	251	141	Average
2402	97.03	103.02			27.16	4.37	37.52	251	141	Peak
4804	50.01	64.98	54	-3.99	31.14	6.79	52.9	295	212	Average
4804	52.47	67.44	74	-21.53	31.14	6.79	52.9	295	212	Peak

Antennal Polarity & Test Distance: Vertical at 3 m										
Frequency (MHz)	Emission Level (dBuV/m)	Read Level (dBuV)	Limit (dBuV/m)	Margin (dB)	Antenna Factor (dB/m)	Cable Loss (dB)	Preamp Factor (dB)	Antenna Height (cm)	Table Angle (Degree)	Remark
2389.52	43.02	49.01	54	-10.98	27.16	4.35	37.5	145	111	Average
2389.52	62.01	67.99	74	-11.99	27.16	4.36	37.5	145	111	Peak
2402	105.47	111.46			27.16	4.37	37.52	145	111	Average
2402	106.58	112.57			27.16	4.37	37.52	145	111	Peak
4804	46.03	61	54	-7.97	31.14	6.79	52.9	222	236	Average
4804	50.75	65.72	74	-23.25	31.14	6.79	52.9	222	236	Peak

Remarks:

- Emission Level = Read Level + Antenna Factor + Cable Loss - Preamp Factor
Margin value = Emission level – Limit value
- 2402 MHz: Fundamental frequency.

Mode D

EUT Test Condition		Measurement Detail	
Channel	Channel 39	Frequency Range	1 GHz ~ 25 GHz
Input Power	120 Vac, 60 Hz	Detector Function	Peak (PK) Average (AV)
Environmental Conditions	25 deg. C, 65 % RH	Tested By	Jisyong Wang

Antennal Polarity & Test Distance: Horizontal at 3 m

Frequency (MHz)	Emission Level (dBuV/m)	Read Level (dBuV)	Limit (dBuV/m)	Margin (dB)	Antenna Factor (dB/m)	Cable Loss (dB)	Preamp Factor (dB)	Antenna Height (cm)	Table Angle (Degree)	Remark
2480	91.25	96.61			27.53	4.43	37.32	111	152	Average
2480	92.65	98.01			27.53	4.43	37.32	111	152	Peak
2483.5	36.51	41.87	54	-17.49	27.53	4.43	37.32	111	152	Average
2483.5	60.02	65.38	74	-13.98	27.53	4.43	37.32	111	152	Peak
4960	41.74	56.4	54	-12.26	31.31	6.88	52.85	162	112	Average
4960	46.03	60.69	74	-27.97	31.31	6.88	52.85	162	112	Peak

Antennal Polarity & Test Distance: Vertical at 3 m

Frequency (MHz)	Emission Level (dBuV/m)	Read Level (dBuV)	Limit (dBuV/m)	Margin (dB)	Antenna Factor (dB/m)	Cable Loss (dB)	Preamp Factor (dB)	Antenna Height (cm)	Table Angle (Degree)	Remark
2480	100.41	105.77			27.53	4.43	37.32	152	132	Average
2480	101.25	106.61			27.53	4.43	37.32	152	132	Peak
2483.5	47.03	52.39	54	-6.97	27.53	4.43	37.32	152	132	Average
2483.5	71.05	76.41	74	-2.95	27.53	4.43	37.32	152	132	Peak
4960	47.49	62.11	54	-6.51	31.4	6.9	52.92	174	121	Average
4960	50.03	64.65	74	-23.97	31.4	6.9	52.92	174	121	Peak

Remarks:

- Emission Level = Read Level + Antenna Factor + Cable Loss - Preamp Factor
Margin value = Emission level – Limit value
- 2480 MHz: Fundamental frequency.

9 kHz ~ 30 MHz Data:

The amplitude of spurious emissions attenuated more than 20 dB below the permissible value is not required to be report.

30 MHz ~ 1 GHz Worst-Case Data:

Mode A

EUT Test Condition		Measurement Detail	
Channel	Channel 0	Frequency Range	30 MHz ~ 1 GHz
Input Power	120 Vac, 60 Hz	Detector Function	Peak (PK) Quasi-peak (QP)
Environmental Conditions	25 deg. C, 65 % RH	Tested By	Jisyong Wang

Antennal Polarity & Test Distance: Horizontal at 3 m										
Frequency (MHz)	Emission Level (dBuV/m)	Read Level (dBuV)	Limit (dBuV/m)	Margin (dB)	Antenna Factor (dB/m)	Cable Loss (dB)	Preamp Factor (dB)	Antenna Height (cm)	Table Angle (Degree)	Remark
91.11	23.86	46.72	43.5	-19.64	8.38	0.72	31.96	152	222	Peak
166.77	26.16	44.83	43.5	-17.34	12.05	1.05	31.77	165	142	Peak
299.66	28.92	46.17	46	-17.08	12.94	1.65	31.84	111	132	Peak
375.32	26.21	41.41	46	-19.79	14.75	1.99	31.94	185	147	Peak
798.24	29.99	35.54	46	-16.01	22.2	3.67	31.42	165	236	Peak
960.23	30.04	33.85	54	-23.96	23.85	4.27	31.93	111	198	Peak

Antennal Polarity & Test Distance: Vertical at 3 m										
Frequency (MHz)	Emission Level (dBuV/m)	Read Level (dBuV)	Limit (dBuV/m)	Margin (dB)	Antenna Factor (dB/m)	Cable Loss (dB)	Preamp Factor (dB)	Antenna Height (cm)	Table Angle (Degree)	Remark
44.55	25.89	42.92	40	-14.11	13.6	0.51	31.14	102	222	Peak
65.89	26.46	46.24	40	-13.54	11.24	0.62	31.64	165	236	Peak
87.23	23.55	46.42	40	-16.45	8.25	0.7	31.82	111	147	Peak
196.84	24.9	45.86	43.5	-18.6	9.57	1.21	31.74	102	256	Peak
384.05	21.89	36.9	46	-24.11	14.96	2.02	31.99	111	198	Peak
921.43	29.14	33.37	46	-16.86	23.63	4.14	32	185	256	Peak

Remarks:

- Emission Level = Read Level + Antenna Factor + Cable Loss - Preamp Factor
Margin value = Emission level – Limit value

Mode B

EUT Test Condition		Measurement Detail	
Channel	Channel 39	Frequency Range	30 MHz ~ 1 GHz
Input Power	120 Vac, 60 Hz	Detector Function	Peak (PK) Quasi-peak (QP)
Environmental Conditions	25 deg. C, 65 % RH	Tested By	Jisyong Wang

Antennal Polarity & Test Distance: Horizontal at 3 m										
Frequency (MHz)	Emission Level (dBuV/m)	Read Level (dBuV)	Limit (dBuV/m)	Margin (dB)	Antenna Factor (dB/m)	Cable Loss (dB)	Preamp Factor (dB)	Antenna Height (cm)	Table Angle (Degree)	Remark
64.92	38.54	58.17	40	-1.46	11.35	0.61	31.59	165	231	Peak
191.99	32.72	53.32	43.5	-10.78	9.91	1.18	31.69	111	152	Peak
382.11	35.56	50.61	46	-10.44	14.91	2.01	31.97	102	265	Peak
497.54	29.74	41.63	46	-16.26	17.27	2.5	31.66	111	145	Peak
800.18	32.48	38.01	46	-13.52	22.23	3.67	31.43	152	236	Peak
978.66	30.32	33.75	54	-23.68	23.95	4.37	31.75	111	185	Peak
Antennal Polarity & Test Distance: Vertical at 3 m										
Frequency (MHz)	Emission Level (dBuV/m)	Read Level (dBuV)	Limit (dBuV/m)	Margin (dB)	Antenna Factor (dB/m)	Cable Loss (dB)	Preamp Factor (dB)	Antenna Height (cm)	Table Angle (Degree)	Remark
35.82	34.44	52.08	40	-5.56	12.94	0.47	31.05	111	152	Peak
68.8	38.63	58.88	40	-1.37	10.89	0.63	31.77	102	236	Peak
381.14	29.1	44.16	46	-16.9	14.89	2.01	31.96	251	145	Peak
530.52	29.89	40.93	46	-16.11	18.02	2.63	31.69	111	132	Peak
824.43	29.57	34.92	46	-16.43	22.54	3.76	31.65	165	251	Peak
966.05	34.18	37.89	54	-19.82	23.88	4.3	31.89	111	152	Peak

Remarks:

- Emission Level = Read Level + Antenna Factor + Cable Loss - Preamp Factor
Margin value = Emission level – Limit value

Mode C

EUT Test Condition		Measurement Detail	
Channel	Channel 0	Frequency Range	30 MHz ~ 1 GHz
Input Power	120 Vac, 60 Hz	Detector Function	Peak (PK) Quasi-peak (QP)
Environmental Conditions	25 deg. C, 65 % RH	Tested By	Jisyong Wang

Antennal Polarity & Test Distance: Horizontal at 3 m										
Frequency (MHz)	Emission Level (dBuV/m)	Read Level (dBuV)	Limit (dBuV/m)	Margin (dB)	Antenna Factor (dB/m)	Cable Loss (dB)	Preamp Factor (dB)	Antenna Height (cm)	Table Angle (Degree)	Remark
64.79	38.33	57.96	40	-1.67	11.35	0.61	31.59	125	78	Peak
191.99	32.72	53.32	43.5	-10.78	9.91	1.18	31.69	187	155	Peak
382.11	35.56	50.61	46	-10.44	14.91	2.01	31.97	198	235	Peak
497.54	29.74	41.63	46	-16.26	17.27	2.5	31.66	204	186	Peak
800.18	32.48	38.01	46	-13.52	22.23	3.67	31.43	119	173	Peak
894.27	35.99	40.55	46	-10.01	23.44	4	32	307	222	Peak

Antennal Polarity & Test Distance: Vertical at 3 m										
Frequency (MHz)	Emission Level (dBuV/m)	Read Level (dBuV)	Limit (dBuV/m)	Margin (dB)	Antenna Factor (dB/m)	Cable Loss (dB)	Preamp Factor (dB)	Antenna Height (cm)	Table Angle (Degree)	Remark
35.82	34.44	52.08	40	-5.56	12.94	0.47	31.05	128	157	Peak
68.42	38.83	59.08	40	-1.17	10.89	0.63	31.77	149	307	Peak
302.48	32.46	49.6	46	-13.54	13.08	1.68	31.9	157	209	Peak
530.52	29.89	40.93	46	-16.11	18.02	2.63	31.69	198	68	Peak
815.7	30.68	36.06	46	-15.32	22.43	3.73	31.54	285	186	Peak
945.68	36.23	40.11	46	-9.77	23.77	4.21	31.86	239	116	Peak

Remarks:

- Emission Level = Read Level + Antenna Factor + Cable Loss - Preamp Factor
Margin value = Emission level – Limit value

Mode D

EUT Test Condition		Measurement Detail	
Channel	Channel 39	Frequency Range	30 MHz ~ 1 GHz
Input Power	120 Vac, 60 Hz	Detector Function	Peak (PK) Quasi-peak (QP)
Environmental Conditions	25 deg. C, 65 % RH	Tested By	Jisyong Wang

Antennal Polarity & Test Distance: Horizontal at 3 m										
Frequency (MHz)	Emission Level (dBuV/m)	Read Level (dBuV)	Limit (dBuV/m)	Margin (dB)	Antenna Factor (dB/m)	Cable Loss (dB)	Preamp Factor (dB)	Antenna Height (cm)	Table Angle (Degree)	Remark
64.92	38.54	58.17	40	-1.46	11.35	0.61	31.59	152	111	Peak
304.51	35	52.16	46	-11	13.06	1.67	31.89	102	231	Peak
437.4	31.48	45.18	46	-14.52	16.08	2.22	32	174	185	Peak
645.95	26.6	35.4	46	-19.4	20.16	3.09	32.05	165	251	Peak
798.24	32.1	37.65	46	-13.9	22.2	3.67	31.42	195	285	Peak
959.26	30.2	34.01	46	-15.8	23.84	4.27	31.92	132	251	Peak

Antennal Polarity & Test Distance: Vertical at 3 m										
Frequency (MHz)	Emission Level (dBuV/m)	Read Level (dBuV)	Limit (dBuV/m)	Margin (dB)	Antenna Factor (dB/m)	Cable Loss (dB)	Preamp Factor (dB)	Antenna Height (cm)	Table Angle (Degree)	Remark
68.8	38.63	58.88	40	-1.37	10.89	0.63	31.77	285	174	Peak
152.22	24.11	42.07	43.5	-19.39	12.71	0.99	31.66	196	284	Peak
228.85	21.12	41.02	46	-24.88	10.58	1.37	31.85	132	256	Peak
398.6	27.78	42.5	46	-18.22	15.31	2.09	32.12	102	195	Peak
530.52	29.89	40.93	46	-16.11	18.02	2.63	31.69	274	285	Peak
790.48	30.08	35.76	46	-15.92	22.09	3.63	31.4	165	235	Peak

Remarks:

- Emission Level = Read Level + Antenna Factor + Cable Loss - Preamp Factor
Margin value = Emission level – Limit value

4.2 Conducted Emission Measurement

4.2.1 Limits of Conducted Emission Measurement

Frequency (MHz)	Conducted Limit (dBuV)	
	Quasi-Peak	Average
0.15 - 0.5	66 - 56	56 - 46
0.50 - 5.0	56	46
5.0 - 30.0	60	50

- Note: 1. The lower limit shall apply at the transition frequencies.
 2. The limit decreases in line with the logarithm of the frequency in the range of 0.15 to 0.50 MHz.

4.2.2 Test Instruments

Description & Manufacturer	Model No.	Serial No.	Date of Calibration	Due Date of Calibration
Test Receiver ROHDE & SCHWARZ	ESR3	102412	Feb. 08, 2018	Feb. 07, 2019
RF signal cable (with 10dB PAD) Woken	5D-FB	Cable-cond2-01	Sep. 08, 2017	Sep. 07, 2018
LISN/AMN ROHDE & SCHWARZ (EUT)	ESH2-Z5	100100	Feb. 05, 2018	Feb. 04, 2019
LISN/AMN ROHDE & SCHWARZ (Peripheral)	ESH3-Z5	100312	Aug. 02, 2017	Aug. 01, 2018
Software ADT	BV ADT_Cond_ V7.3.7.4	NA	NA	NA

- Note: 1. The calibration interval of the above test instruments is 12 months and the calibrations are traceable to NML/ROC and NIST/USA.
 2. The test was performed in HwaYa Shielded Room 2.
 3. The VCCI Site Registration No. is C-2047.

4.2.3 Test Procedures

- The EUT was placed 0.4 meters from the conducting wall of the shielded room with EUT being connected to the power mains through a line impedance stabilization network (LISN). Other support units were connected to the power mains through another LISN. The two LISNs provide 50 ohm/50 uH of coupling impedance for the measuring instrument.
- Both lines of the power mains connected to the EUT were checked for maximum conducted interference.
- The frequency range from 150 kHz to 30 MHz was searched. Emission levels under (Limit – 20 dB) was not recorded.

Note: The resolution bandwidth and video bandwidth of test receiver is 9 kHz for quasi-peak detection (QP) and average detection (AV) at frequency 0.15 MHz - 30 MHz.

4.2.4 Deviation from Test Standard

No deviation.

4.2.5 Test Setup

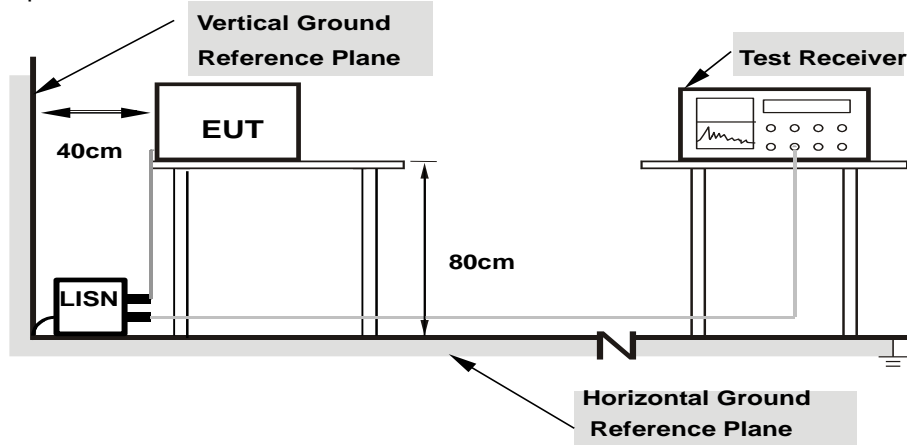

- Note: 1.Support units were connected to second LISN.
2.Both of LISNs (AMN) are 80 cm from EUT and at least 80 from other units and other metal planes**

4.2.6 EUT Operating Conditions

- Placed the EUT on the testing table.
- Set the EUT under transmission condition continuously at specific channel frequency.

4.2.7 Test Results

CONDUCTED WORST-CASE DATA

Frequency Range	150kHz ~ 30MHz	Detector Function & Resolution Bandwidth	Quasi-Peak (QP) / Average (AV), 9kHz
Input Power	120Vac, 60Hz	Environmental Conditions	25°C, 65%RH
Tested by	Getaz Yang	Test Date	2018/5/4

Phase Of Power : Line (L)										
No	Frequency (MHz)	Correction Factor (dB)	Reading Value (dBuV)		Emission Level (dBuV)		Limit (dBuV)		Margin (dB)	
			Q.P.	AV.	Q.P.	AV.	Q.P.	AV.	Q.P.	AV.
1	0.17025	10.25	41.31	19.49	51.56	29.74	64.95	54.95	-13.39	-25.21
2	0.23550	10.26	34.35	15.07	44.61	25.33	62.25	52.25	-17.64	-26.92
3	0.41744	10.27	23.69	11.31	33.96	21.58	57.50	47.50	-23.54	-25.92
4	1.45275	10.35	22.42	11.57	32.77	21.92	56.00	46.00	-23.23	-24.08
5	4.11675	10.45	19.01	6.99	29.46	17.44	56.00	46.00	-26.54	-28.56
6	14.34075	10.68	20.00	8.14	30.68	18.82	60.00	50.00	-29.32	-31.18

Remarks:

1. Q.P. and AV. are abbreviations of quasi-peak and average individually.
2. The emission levels of other frequencies were very low against the limit.
3. Margin value = Emission level – Limit value
4. Correction factor = Insertion loss + Cable loss
5. Emission Level = Correction Factor + Reading Value

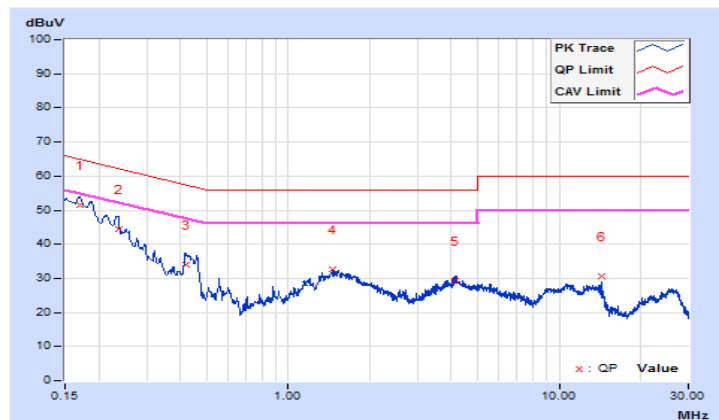

Frequency Range	150kHz ~ 30MHz	Detector Function & Resolution Bandwidth	Quasi-Peak (QP) / Average (AV), 9kHz
Input Power	120Vac, 60Hz	Environmental Conditions	25°C, 65%RH
Tested by	Getaz Yang	Test Date	2018/5/4

Phase Of Power : Neutral (N)										
No	Frequency (MHz)	Correction Factor (dB)	Reading Value (dBuV)		Emission Level (dBuV)		Limit (dBuV)		Margin (dB)	
			Q.P.	AV.	Q.P.	AV.	Q.P.	AV.	Q.P.	AV.
1	0.16125	10.26	42.79	23.99	53.05	34.25	65.40	55.40	-12.35	-21.15
2	0.20249	10.26	37.47	14.83	47.73	25.09	63.51	53.51	-15.78	-28.42
3	0.41854	10.28	21.59	6.24	31.87	16.52	57.48	47.48	-25.61	-30.96
4	1.50000	10.36	20.48	8.96	30.84	19.32	56.00	46.00	-25.16	-26.68
5	4.18425	10.48	16.39	4.69	26.87	15.17	56.00	46.00	-29.13	-30.83
6	14.12925	10.78	19.79	6.23	30.57	17.01	60.00	50.00	-29.43	-32.99

Remarks:

1. Q.P. and AV. are abbreviations of quasi-peak and average individually.
2. The emission levels of other frequencies were very low against the limit.
3. Margin value = Emission level – Limit value
4. Correction factor = Insertion loss + Cable loss
5. Emission Level = Correction Factor + Reading Value

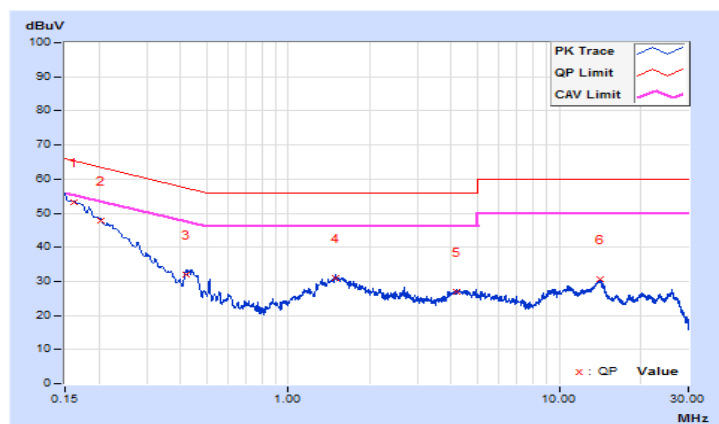

4.3 6 dB Bandwidth Measurement

4.3.1 Limits of 6 dB Bandwidth Measurement

The minimum of 6 dB Bandwidth Measurement is 0.5 MHz.

4.3.2 Test Setup

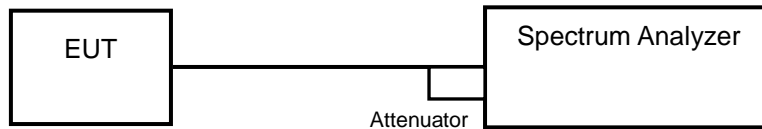

4.3.3 Test Instruments

Refer to section 4.1.2 to get information of above instrument.

4.3.4 Test Procedure

- a. Set resolution bandwidth (RBW) = 100 kHz
- b. Set the video bandwidth (VBW) $\geq 3 \times$ RBW, Detector = Peak.
- c. Trace mode = max hold.
- d. Sweep = auto couple.
- e. Measure the maximum width of the emission that is constrained by the frequencies associated with the two amplitude points (upper and lower) that are attenuated by 6 dB relative to the maximum level measured in the fundamental emission

4.3.5 Deviation from Test Standard

No deviation.

4.3.6 EUT Operating Conditions

The software provided by client to enable the EUT under transmission condition continuously at lowest, middle and highest channel frequencies individually.

4.3.7 Test Results

Channel	Frequency (MHz)	6 dB Bandwidth (MHz)	Minimum Limit (MHz)	Pass / Fail
0	2402	0.71	0.5	Pass
19	2440	0.71	0.5	Pass
39	2480	0.71	0.5	Pass

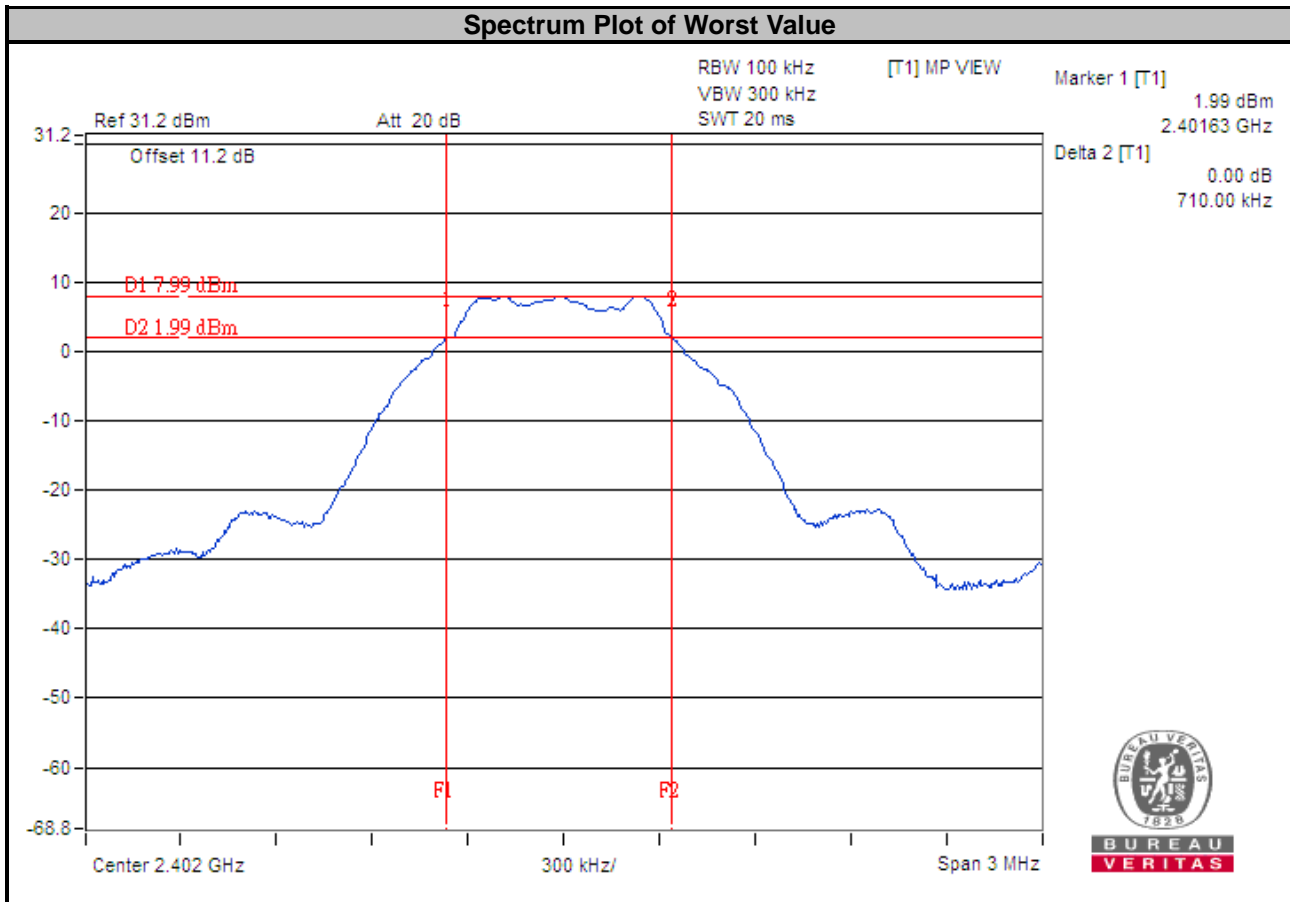

4.4 Occupied Bandwidth Measurement

4.4.1 Test Setup

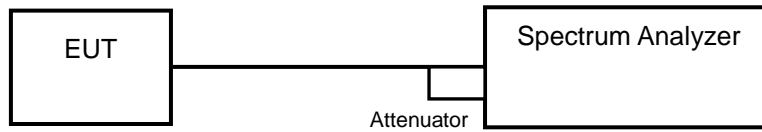

4.4.2 Test Instruments

Refer to section 4.1.2 to get information of above instrument.

4.4.3 Test Procedure

The transmitter output was connected to the spectrum analyzer through an attenuator. The bandwidth of the fundamental frequency was measured by spectrum analyzer with resolution bandwidth in the range of 1 % to 5 % of the anticipated emission bandwidth, and a video bandwidth at least 3x the resolution bandwidth and set the detector to PEAK. The width of a frequency band such that, below the lower and above the upper frequency limits, the mean powers emitted are each equal to a specified percentage 0.5 % of the total mean power of a given emission.

4.4.4 Deviation from Test Standard

No deviation.

4.4.5 EUT Operating Conditions

The software provided by client to enable the EUT under transmission condition continuously at lowest, middle and highest channel frequencies individually.

4.4.6 Test Results

Channel	Frequency (MHz)	Occupied Bandwidth (MHz)	Pass / Fail
0	2402	1.03	Pass
19	2440	1.03	Pass
39	2480	1.03	Pass

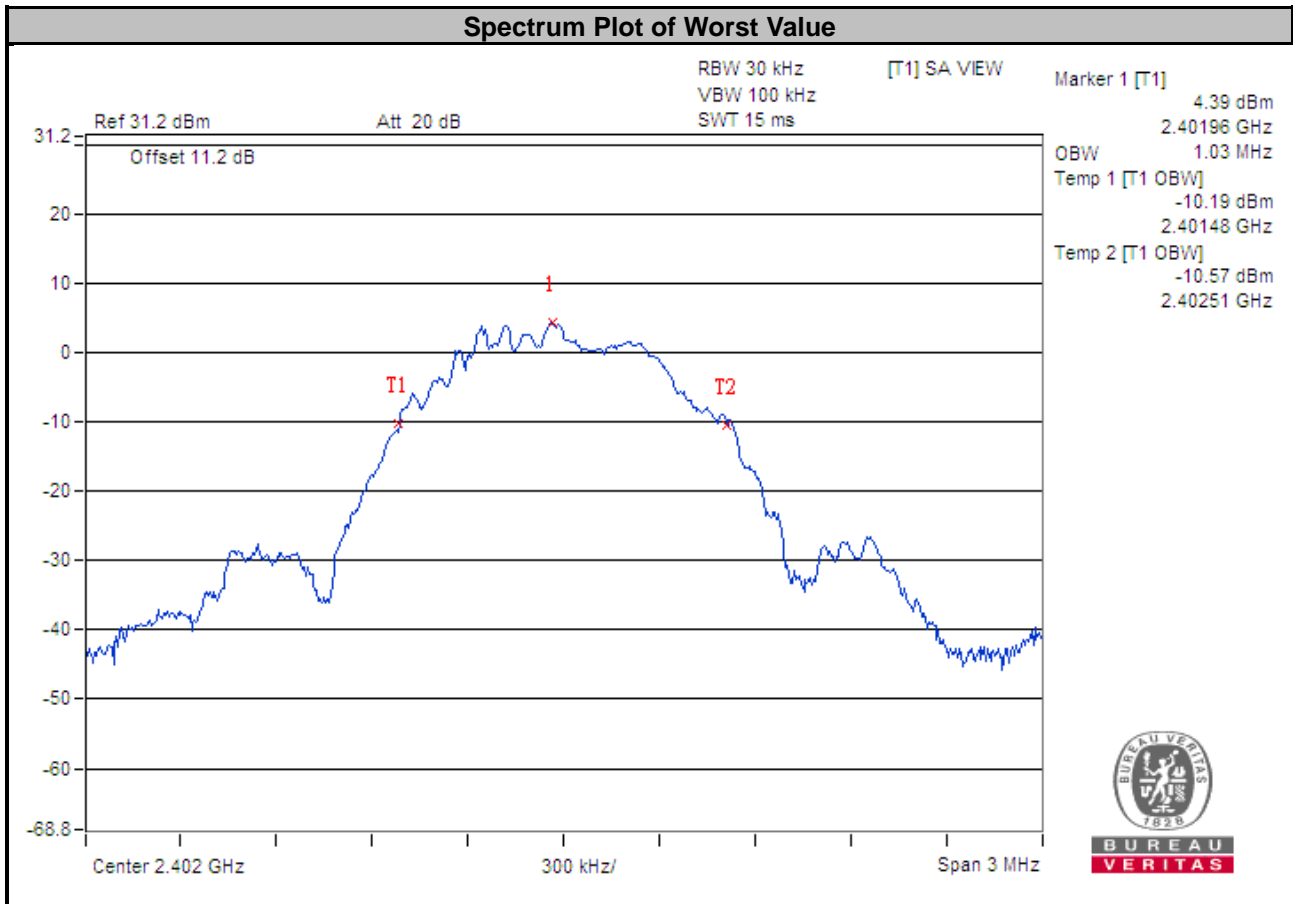

4.5 Conducted Output Power Measurement

4.5.1 Limits of Conducted Output Power Measurement

For systems using digital modulation in the 2400–2483.5 MHz bands: 1 Watt (30 dBm)

4.5.2 Test Setup

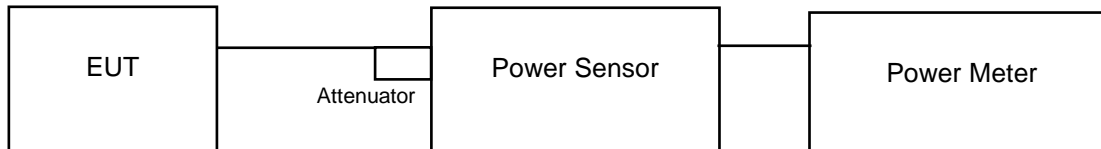

4.5.3 Test Instruments

Refer to section 4.1.2 to get information of above instrument.

4.5.4 Test Procedures

A peak power sensor was used on the output port of the EUT. A power meter was used to read the response of the peak power sensor. Record the power level.

4.5.5 Deviation from Test Standard

No deviation.

4.5.6 EUT Operating Conditions

The software provided by client to enable the EUT under transmission condition continuously at lowest, middle and highest channel frequencies individually.

4.5.7 Test Results

Channel	Frequency (MHz)	Peak Power (mW)	Peak Power (dBm)	Limit (dBm)	Pass / Fail
0	2402	7.345	8.66	30	Pass
19	2440	7.278	8.62	30	Pass
39	2480	2.992	4.76	30	Pass

4.6 Power Spectral Density Measurement

4.6.1 Limits of Power Spectral Density Measurement

The Maximum of Power Spectral Density Measurement is 8 dBm.

4.6.2 Test Setup

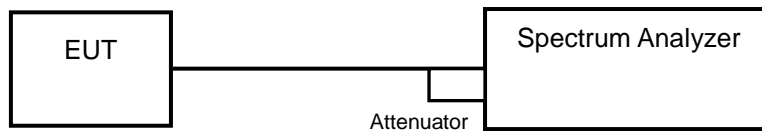

4.6.3 Test Instruments

Refer to section 4.1.2 to get information of above instrument.

4.6.4 Test Procedure

- a. Set analyzer center frequency to DTS channel center frequency.
- b. Set the span to 1.5 times the DTS bandwidth.
- c. Set the RBW to: $3 \text{ kHz} \leq \text{RBW} \leq 100 \text{ kHz}$.
- d. Set the VBW $\geq 3 \times \text{RBW}$.
- e. Detector = peak.
- f. Sweep time = auto couple.
- g. Trace mode = max hold.
- h. Allow trace to fully stabilize.
- i. Use the peak marker function to determine the maximum amplitude level within the RBW.

4.6.5 Deviation from Test Standard

No deviation.

4.6.6 EUT Operating Condition

The software provided by client to enable the EUT under transmission condition continuously at lowest, middle and highest channel frequencies individually.

4.6.7 Test Results

Channel	Frequency (MHz)	PSD (dBm/3 kHz)	Limit (dBm/3 kHz)	Pass / Fail
0	2402	-6.25	8	Pass
19	2440	-6.63	8	Pass
39	2480	-10.77	8	Pass

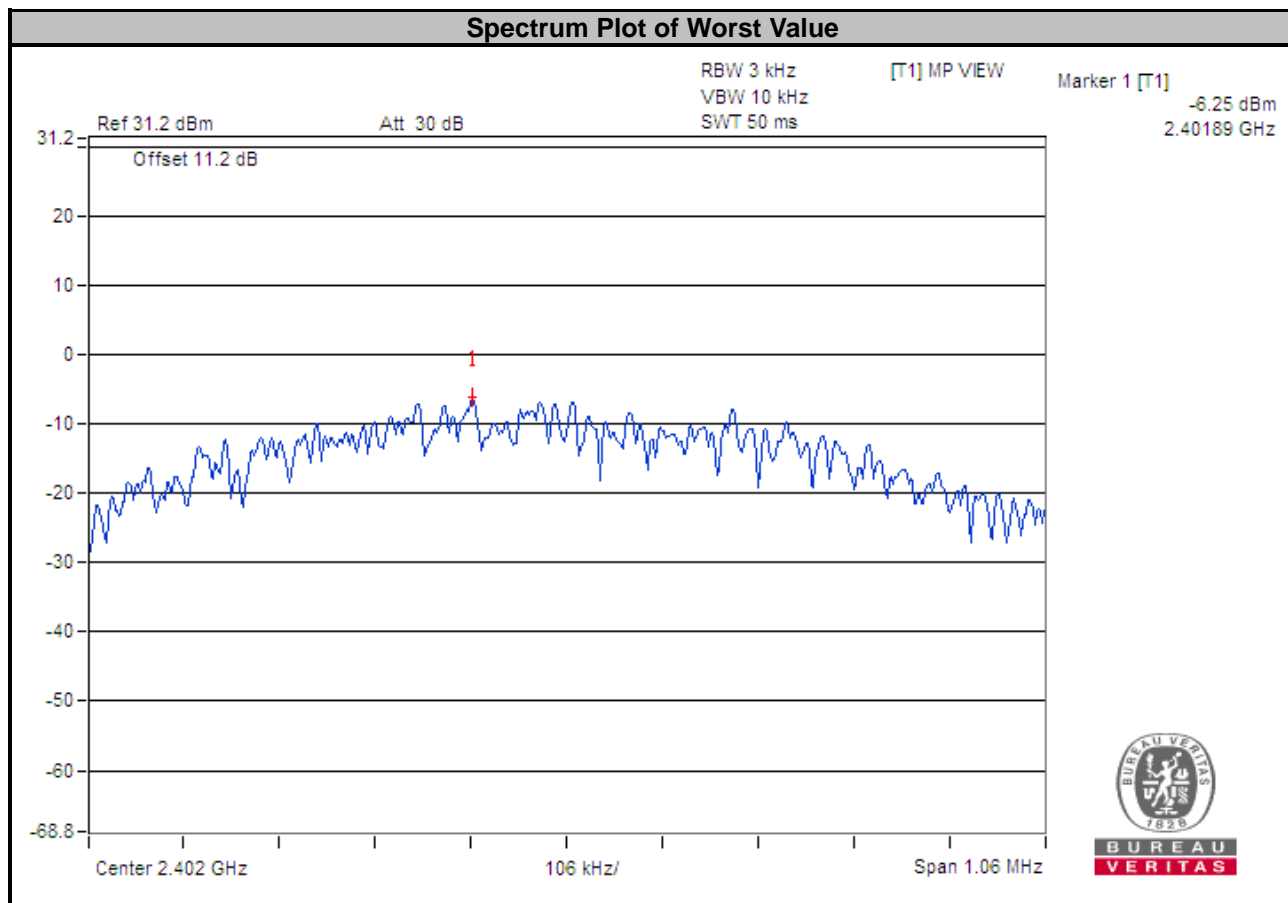

4.7 Conducted Out of Band Emission Measurement

4.7.1 Limits of Conducted Out of Band Emission Measurement

Below -20 dB of the highest emission level of operating band (in 100 kHz Resolution Bandwidth).

4.7.2 Test Setup

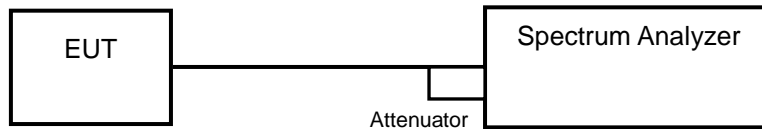

4.7.3 Test Instruments

Refer to section 4.1.2 to get information of above instrument.

4.7.4 Test Procedure

MEASUREMENT PROCEDURE REF

1. Set the RBW = 100 kHz.
2. Set the VBW \geq 300 kHz.
3. Detector = peak.
4. Sweep time = auto couple.
5. Trace mode = max hold.
6. Allow trace to fully stabilize.
7. Use the peak marker function to determine the maximum power level in any 100 kHz band segment within the fundamental EBW.

MEASUREMENT PROCEDURE OOB

1. Set RBW = 100 kHz.
2. Set VBW \geq 300 kHz.
3. Detector = peak.
4. Sweep = auto couple.
5. Trace Mode = max hold.
6. Allow trace to fully stabilize.
7. Use the peak marker function to determine the maximum amplitude level.

4.7.5 Deviation from Test Standard

No deviation.

4.7.6 EUT Operating Condition

The software provided by client to enable the EUT under transmission condition continuously at lowest, middle and highest channel frequencies individually.

4.7.7 Test Results

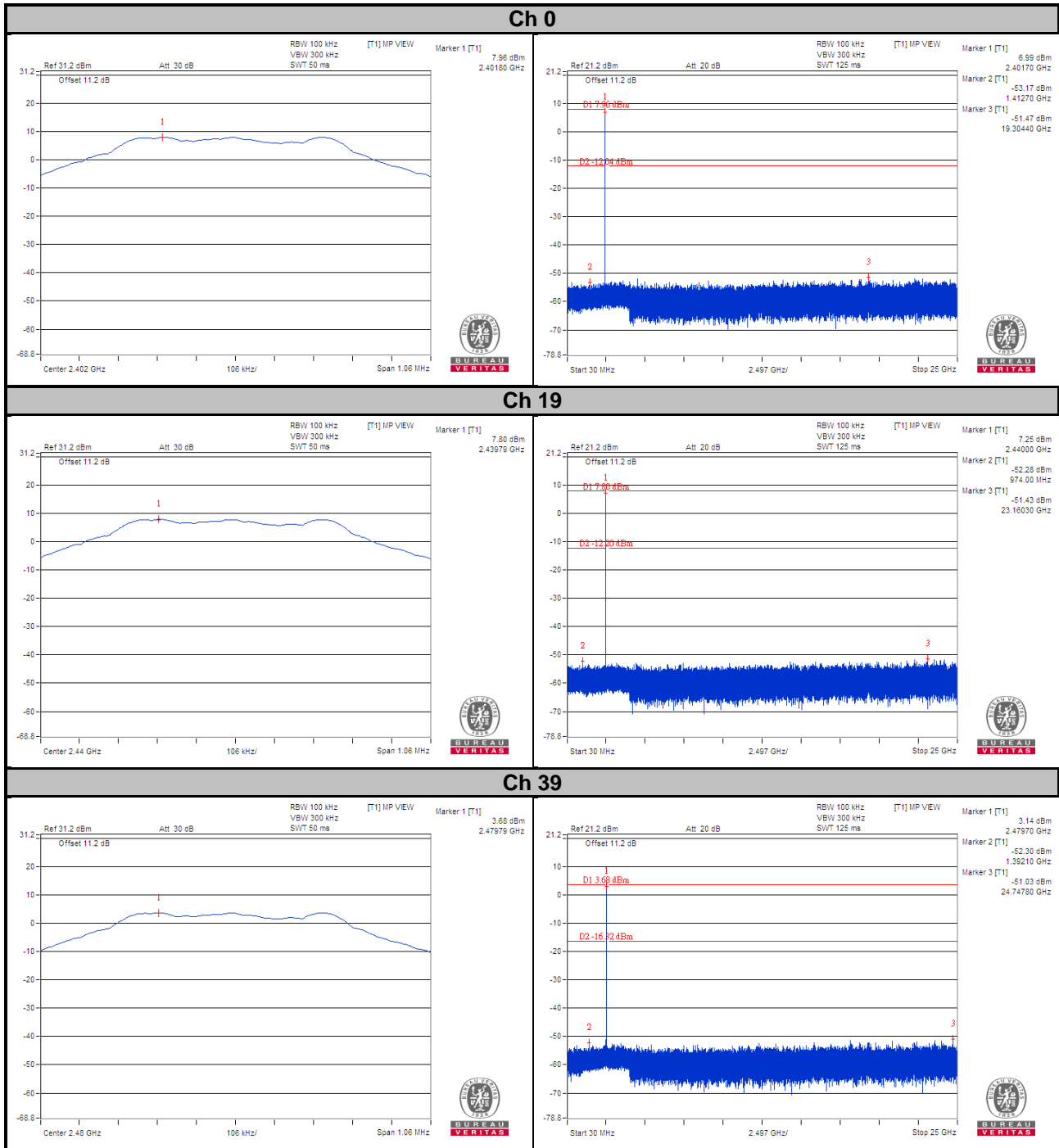

Ch 0 Band Edge

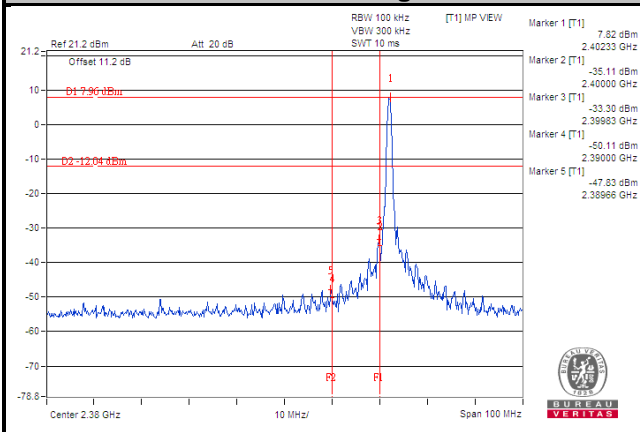

Ch 39 Band Edge

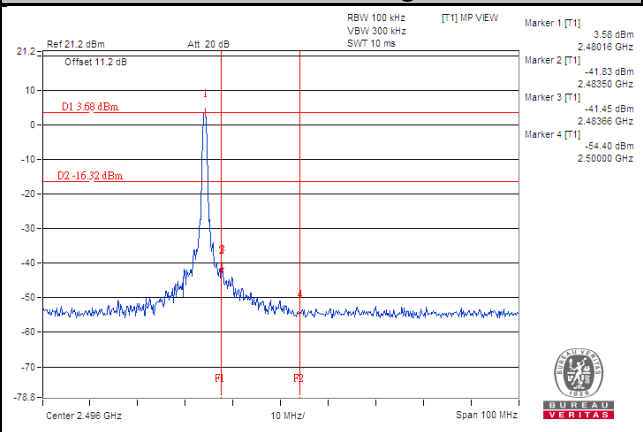

5 Pictures of Test Arrangements

Please refer to the attached file (Test Setup Photo).

Appendix – Information on the Testing Laboratories

We, Bureau Veritas Consumer Products Services (H.K.) Ltd., Taoyuan Branch, were founded in 1988 to provide our best service in EMC, Radio, Telecom and Safety consultation. Our laboratories are FCC recognized accredited test firms and accredited according to ISO/IEC 17025.

If you have any comments, please feel free to contact us at the following:

Linko EMC/RF Lab

Tel: 886-2-26052180

Fax: 886-2-26051924

Hsin Chu EMC/RF/Telecom Lab

Tel: 886-3-6668565

Fax: 886-3-6668323

Hwa Ya EMC/RF/Safety

Tel: 886-3-3183232

Fax: 886-3-3270892

Email: service.adt@tw.bureauveritas.com

Web Site: www.bureauveritas-adt.com

The address and road map of all our labs can be found in our web site also.

--- END ---