

## FCC 47 CFR PART 15 SUBPART C

### TEST REPORT

For

Wireless module

**Model:**  
**WG7833-B0, WG7833BEM2A, WG7833BEM2B**

**Trade Name: Jorjin**

*Issued to*

**Jorjin Technologies INC**  
**17F,No.239, Sec. 1, Datong Rd., Xizhi Dist., New Taipei City 22161**

*Issued by*

**Compliance Certification Services Inc.**  
**No.11, Wugong 6th Rd., Wugu Dist.,**  
**New Taipei City 24891, Taiwan. (R.O.C.)**  
**<http://www.ccsrf.com>**  
**[service@ccsrf.com](mailto:service@ccsrf.com)**  
**Issued Date: May 29, 2015**



**Note:** This report shall not be reproduced except in full, without the written approval of Compliance Certification Services Inc. This document may be altered or revised by Compliance Certification Services Inc. personnel only, and shall be noted in the revision section of the document.

**Revision History**

Rev.	Issue Date	Revisions	Effect Page	Revised By
00	May 29, 2015	Initial Issue	ALL	Becca Chen

## TABLE OF CONTENTS

<b>1. TEST RESULT CERTIFICATION.....</b>	<b>4</b>
<b>2. EUT DESCRIPTION .....</b>	<b>5</b>
<b>3. TEST METHODOLOGY .....</b>	<b>6</b>
3.1 EUT CONFIGURATION .....	6
3.2 EUT EXERCISE.....	6
3.3 GENERAL TEST PROCEDURES .....	6
3.4 FCC PART 15.205 RESTRICTED BANDS OF OPERATIONS .....	7
3.5 DESCRIPTION OF TEST MODES .....	8
<b>4. INSTRUMENT CALIBRATION.....</b>	<b>9</b>
4.1 MEASURING INSTRUMENT CALIBRATION .....	9
4.2 MEASUREMENT EQUIPMENT USED.....	9
4.3 MEASUREMENT UNCERTAINTY .....	10
<b>5. FACILITIES AND ACCREDITATIONS .....</b>	<b>11</b>
5.1 FACILITIES .....	11
5.2 EQUIPMENT .....	11
5.3 TABLE OF ACCREDITATIONS AND LISTINGS.....	12
<b>6. SETUP OF EQUIPMENT UNDER TEST .....</b>	<b>13</b>
6.1 SETUP CONFIGURATION OF EUT.....	13
6.2 SUPPORT EQUIPMENT.....	13
<b>7. FCC PART 15.247 REQUIREMENTS.....</b>	<b>14</b>
7.1 6DB BANDWIDTH .....	14
7.2 PEAK POWER .....	18
7.3 AVERAGE POWER .....	19
7.4 BAND EDGES MEASUREMENT .....	20
7.5 PEAK POWER SPECTRAL DENSITY .....	32
7.6 SPURIOUS EMISSIONS .....	36
7.7 POWERLINE CONDUCTED EMISSIONS.....	51
<b>APPENDIX I - PHOTOGRAPHS OF TEST SETUP .....</b>	<b>52</b>
<b>APPENDIX II - PHOTOGRAPHS OF EUT</b>	

# 1. TEST RESULT CERTIFICATION

**Applicant:** Jorjin Technologies INC  
 17F,No.239, Sec. 1, Datong Rd., Xizhi Dist., New Taipei City  
 22161

**Equipment Under Test:** Wireless module

**Trade Name:** Jorjin

**Model:** WG7833-B0, WG7833BEM2A, WG7833BEM2B

**Date of Test:** April 29 ~ May 27, 2015

APPLICABLE STANDARDS	
STANDARD	TEST RESULT
FCC 47 CFR Part 15 Subpart C	No non-compliance noted
Deviation from Applicable Standard	
N/A	

**We hereby certify that:**

The above equipment was tested by Compliance Certification Services Inc. The test data, data evaluation, test procedures, and equipment configurations shown in this report were made in accordance with the procedures given in **ANSI C63.10: 2009** and the energy emitted by the sample EUT tested as described in this report is in compliance with the requirements of FCC Rules Part 15.207, 15.209, 15.247.

The test results of this report relate only to the tested sample EUT identified in this report.

*Approved by:*

*Reviewed by:*



\_\_\_\_\_  
 Miller Lee  
 Manager  
 Compliance Certification Services Inc.

\_\_\_\_\_  
 Angel Cheng  
 Section Manager  
 Compliance Certification Services Inc.

## 2. EUT DESCRIPTION

<b>Product</b>	Wireless module		
<b>Trade Name</b>	Jorjin		
<b>Model Number</b>	WG7833-B0, WG7833BEM2A, WG7833BEM2B		
<b>Model Discrepancy</b>	<b>Model</b>	<b>External PCB</b>	<b>Antenna connector</b>
	WG7833-B0	X	X
	WG7833BEM2A	O	O
	WG7833BEM2B	O	X
<b>Received Date</b>	April 17, 2015		
<b>Power Rating</b>	Powered from host device via USB Cable		
<b>Frequency Range</b>	2402MHz ~ 2480MHz		
<b>Transmit Power</b>	8.33 dBm		
<b>Modulation Technique</b>	GFSK (1Mbps)		
<b>Number of Channels</b>	40 Channels		
<b>Antenna Specification</b>	1. PCB Antenna / Unictron H2B1BE1A1B0200: 4.13 dBi 2. Dipole Antenna / WIESON GPOT155-002: 1.60 dBi		

**Remark:**

1. The sample selected for test was production product and was provided by manufacturer.
2. This submittal(s) (test report) is intended for **FCC ID: WS2-WG7833B0** filing to comply with Section 15.207, 15.209 and 15.247 of the FCC Part 15, Subpart C Rules.

### **3. TEST METHODOLOGY**

The tests documented in this report were performed in accordance with ANSI C63.10: 2009 and FCC CFR 47 Part 15.207, 15.209, 15.247 and DA00-705.

#### **3.1 EUT CONFIGURATION**

The EUT configuration for testing is installed on RF field strength measurement to meet the Commissions requirement and operating in a manner that intends to maximize its emission characteristics in a continuous normal application.

#### **3.2 EUT EXERCISE**

The EUT was operated in the engineering mode to fix the TX frequency that was for the purpose of the measurements.

According to its specifications, the EUT must comply with the requirements of the Section 15.207, 15.209 and 15.247 under the FCC Rules Part 15 Subpart C.

#### **3.3 GENERAL TEST PROCEDURES**

##### **Conducted Emissions**

The EUT is placed on the turntable, which is 0.8 m above ground plane. According to the requirements in Section 13.1.4.1 of ANSI C63.10 Conducted emissions from the EUT measured in the frequency range between 0.15 MHz and 30MHz using CISPR Quasi-peak and average detector modes.

##### **Radiated Emissions**

The EUT is placed on a turn table, which is 1.5 m above ground plane. The turntable shall rotate 360 degrees to determine the position of maximum emission level. EUT is set 3m away from the receiving antenna, which varied from 1m to 4m to find out the highest emission. And also, each emission was to be maximized by changing the polarization of receiving antenna both horizontal and vertical. In order to find out the maximum emissions, exploratory radiated emission measurements were made according to the requirements in Section 13.1.4.1 of ANSI C63.10: 2009.

### 3.4 FCC PART 15.205 RESTRICTED BANDS OF OPERATIONS

(a) Except as shown in paragraph (d) of this section, only spurious emissions are permitted in any of the frequency bands listed below:

MHz	MHz	MHz	GHz
0.090 - 0.110	16.42 - 16.423	399.9 - 410	4.5 - 5.15
<sup>1</sup> 0.495 - 0.505	16.69475 - 16.69525	608 - 614	5.35 - 5.46
2.1735 - 2.1905	16.80425 - 16.80475	960 - 1240	7.25 - 7.75
4.125 - 4.128	25.5 - 25.67	1300 - 1427	8.025 - 8.5
4.17725 - 4.17775	37.5 - 38.25	1435 - 1626.5	9.0 - 9.2
4.20725 - 4.20775	73 - 74.6	1645.5 - 1646.5	9.3 - 9.5
6.215 - 6.218	74.8 - 75.2	1660 - 1710	10.6 - 12.7
6.26775 - 6.26825	108 - 121.94	1718.8 - 1722.2	13.25 - 13.4
6.31175 - 6.31225	123 - 138	2200 - 2300	14.47 - 14.5
8.291 - 8.294	149.9 - 150.05	2310 - 2390	15.35 - 16.2
8.362 - 8.366	156.52475 -	2483.5 - 2500	17.7 - 21.4
8.37625 - 8.38675	156.52525	2655 - 2900	22.01 - 23.12
8.41425 - 8.41475	156.7 - 156.9	3260 - 3267	23.6 - 24.0
12.29 - 12.293	162.0125 - 167.17	3332 - 3339	31.2 - 31.8
12.51975 - 12.52025	167.72 - 173.2	3345.8 - 3358	36.43 - 36.5
12.57675 - 12.57725	240 - 285	3600 - 4400	( <sup>2</sup> )
13.36 - 13.41	322 - 335.4		

<sup>1</sup> Until February 1, 1999, this restricted band shall be 0.490-0.510 MHz.

<sup>2</sup> Above 38.6

(b) Except as provided in paragraphs (d) and (e), the field strength of emissions appearing within these frequency bands shall not exceed the limits shown in Section 15.209. At frequencies equal to or less than 1000 MHz, compliance with the limits in Section 15.209 shall be demonstrated using measurement instrumentation employing a CISPR quasi-peak detector. Above 1000 MHz, compliance with the emission limits in Section 15.209 shall be demonstrated based on the average value of the measured emissions. The provisions in Section 15.35 apply to these measurements.

### **3.5 DESCRIPTION OF TEST MODES**

The EUT (model: WG7833-B0) had been tested under operating condition.

Test program used to control the EUT for staying in continuous transmitting mode was programmed.

After verification, all tests were carried out with the worst case test modes as shown below except radiated spurious emission below 1GHz and power line conducted emissions below 30MHz, which worst case was in normal link mode only.

#### **BT 4.0**

<b>Tested Channel</b>	<b>Frequency (MHz)</b>
Low	2402
Mid	2440
High	2480



## 4. INSTRUMENT CALIBRATION

### 4.1 MEASURING INSTRUMENT CALIBRATION

The measuring equipment, which was utilized in performing the tests documented herein, has been calibrated in accordance with the manufacturer's recommendations for utilizing calibration equipment, which is traceable to recognized national standards.

### 4.2 MEASUREMENT EQUIPMENT USED

#### Equipment Used for Emissions Measurement

*Remark: Each piece of equipment is scheduled for calibration once a year.*

Conducted Emissions Test Site				
Name of Equipment	Manufacturer	Model	Serial Number	Calibration Due
Spectrum Analyzer	Agilent	E4446A	US42510252	11/23/2015
Thermostatic/Hrgrosatic Chamber	TAICHY	MHG-150LF	930619	10/07/2015
AC Power Source	EXTECH	6205	1140845	N.C.R
DC Power Supply	ABM	8301HD	D011531	N.C.R
Power Meter	Anritsu	ML2495A	1012009	06/03/2015
Power Sensor	Anritsu	MA2411A	0917072	06/03/2015
Spectrum Analyzer	ROHDE&SCHWARZ	FSV40	101073	07/09/2015
Test S/W	EZ-EMC (CCS-3A1RE)			

Wugu 966 Chamber A				
Name of Equipment	Manufacturer	Model	Serial Number	Calibration Due
Spectrum Analyzer	Agilent	E4446A	US42510268	09/18/2015
EMI Test Receiver	R&S	ESCI	100064	05/30/2015
Bilog Antenna	Sunol Sciences	JB3	A030105	08/19/2015
Horn Antenna	EMCO	3117	00055165	01/26/2016
Horn Antenna	EMCO	3116	26370	12/25/2015
Turn Table	CCS	CC-T-1F	N/A	N.C.R
Antenna Tower	CCS	CC-A-1F	N/A	N.C.R
Controller	CCS	CC-C-1F	N/A	N.C.R
Pre-Amplifier	MITEQ	1652-3000	1490939	08/09/2016
Pre-Amplifier	EMC	EMC 01265	4035	08/09/2016
Pre-Amplifier	MITEQ	AMF-6F-260400-4 0-8P	985646	12/25/2015
Coaxial Cable	Huber+Suhner	102	29212/2	12/25/2015
Coaxial Cable	Huber+Suhner	102	29406/2	12/25/2015
Test S/W	EZ-EMC (CCS-3A1RE)			

Conducted Emission room				
Name of Equipment	Manufacturer	Model	Serial Number	Calibration Due
N/A				

**NOTE:** 1. The calibration interval of the above test instruments is 12 months and the calibrations are traceable to NML/ROC and NIST/USA.  
 2. N.C.R = No Calibration Request.

### 4.3 MEASUREMENT UNCERTAINTY

PARAMETER	UNCERTAINTY
Powerline Conducted Emission	N/A
3M Semi Anechoic Chamber / <200M	+/- 4.0138
3M Semi Anechoic Chamber / 200M~1000M	+/- 3.9483
3M Semi Anechoic Chamber / 1G~8G	+/- 2.5975
3M Semi Anechoic Chamber / 8G~18G	+/- 2.6112
3M Semi Anechoic Chamber / 18G~26G	+/- 2.7389
3M Semi Anechoic Chamber / 26G~40G	+/- 2.9683

**Remark:** This uncertainty represents an expanded uncertainty expressed at approximately the 95% confidence level using a coverage factor of  $k=2$ .

## 5. FACILITIES AND ACCREDITATIONS

### 5.1 FACILITIES

All measurement facilities used to collect the measurement data are located at

No.199, Chungshen Road, Hsintien City, Taipei Hsien, Taiwan, R.O.C.

Tel: 886-2-2217-0894 / Fax: 886-2-2217-1029

No.11, Wugong 6th Rd., Wugu Dist., New Taipei City 24891, Taiwan. (R.O.C.)

Tel: 886-2-2299-9720 / Fax: 886-2-2298-4045

No.81-1, Lane 210, Bade 2nd Rd., Lujhu Township, Taoyuan County 33841, TAIWAN, R.O.C.

Tel: 886-3-324-0332 / Fax: 886-3-324-5235

The sites are constructed in conformance with the requirements of ANSI C63.7, ANSI C63.10 and CISPR Publication 22.

### 5.2 EQUIPMENT



Radiated emissions are measured with one or more of the following types of linearly polarized antennas: tuned dipole, biconical, log periodic, bi-log, and/or ridged waveguide, horn. Spectrum analyzers with pre-selectors and quasi-peak detectors are used to perform radiated measurements.

Conducted emissions are measured with Line Impedance Stabilization Networks and EMI Test Receivers.

Calibrated wideband preamplifiers, coaxial cables, and coaxial attenuators are also used for making measurements.

All receiving equipment conforms to CISPR Publication 16-1, "Radio Interference Measuring Apparatus and Measurement Methods."

**5.3 TABLE OF ACCREDITATIONS AND LISTINGS**

Country	Agency	Scope of Accreditation	Logo
USA	FCC	3M Semi Anechoic Chamber (FCC MRA: TW1039) to perform FCC Part 15 measurements	 FCC MRA: TW1039
Taiwan	TAF	LP0002, RTTE01, FCC Method-47 CFR Part 15 Subpart C, D, E, RSS-210, RSS-310 IDA TS SRD, AS/NZS 4268, AS/NZS 4771, TS 12.1 & 12.2, ETSI EN 300 440-1, ETSI EN 300 440-2, ETSI EN 300 328, ETSI EN 300 220-1, ETSI EN 300 220-2, ETSI EN 301 893, ETSI EN 301 489-1/3/7/17 FCC OET Bulletin 65 + Supplement C, EN 50360, EN 50361, EN 50371, RSS 102, EN 50383, EN 50385, EN 50392, IEC 62209, CNS 14958-1, CNS 14959 FCC Method -47 CFR Part 15 Subpart B IEC / EN 61000-3-2, IEC / EN 61000-3-3, IEC / EN 61000-4-2/3/4/5/6/8/11	
Canada	Industry Canada	3M Semi Anechoic Chamber (IC 2324G-1 / IC 2324G-2) to perform	 IC 2324G-1 IC 2324G-2

*\* No part of this report may be used to claim or imply product endorsement by A2LA or any agency of the US Government.*

## 6. SETUP OF EQUIPMENT UNDER TEST

### 6.1 SETUP CONFIGURATION OF EUT

See test photographs attached in Appendix II for the actual connections between EUT and support equipment.

### 6.2 SUPPORT EQUIPMENT

No	Device Type	Brand	Model	Series No.	FCC ID	Data Cable	Power Cord
1	Notebook PC	TOSHIBA	Satellite M840	N/A	PPD-AR5B225	N/A	AC I/P: Unshielded, 1.8m DC O/P: Unshielded, 1.8m with a core

**Remark:**

1. All the equipment/cables were placed in the worst-case configuration to maximize the emission during the test.
2. Grounding was established in accordance with the manufacturer's requirements and conditions for the intended use.

## 7. FCC PART 15.247 REQUIREMENTS

### 7.1 6DB BANDWIDTH

#### LIMIT

According to §15.247(a)(2), systems using digital modulation techniques may operate in the 902 - 928 MHz, 2400 - 2483.5 MHz, and 5725 - 5850 MHz bands. The minimum 6 dB bandwidth shall be at least 500 kHz.

#### Test Configuration

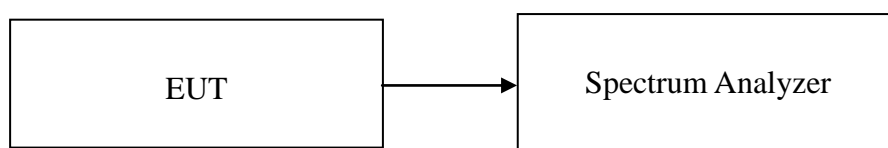

#### TEST PROCEDURE

The transmitter output is connected to the spectrum analyzer. Set the RBW=100kHz the emission bandwidth, VBW  $\geq 3 \times$  RBW, Detector = Peak, Trace mode = max hold, Sweep = auto couple. Measure the maximum width of the emission that is constrained by the frequencies associated with the two amplitude points (upper and lower) that are attenuated by 6dB relative to the maximum level measured in the fundamental emission.

#### TEST RESULTS

*No non-compliance noted*

#### Test Data

Channel	Frequency (MHz)	6dB Bandwidth (kHz)	Limit (kHz)	Test Result
Low	2402	0.46	>500	PASS
Mid	2440	0.46		PASS
High	2480	0.46		PASS

**Test Plot**

**6dB Bandwidth (CH Low)**

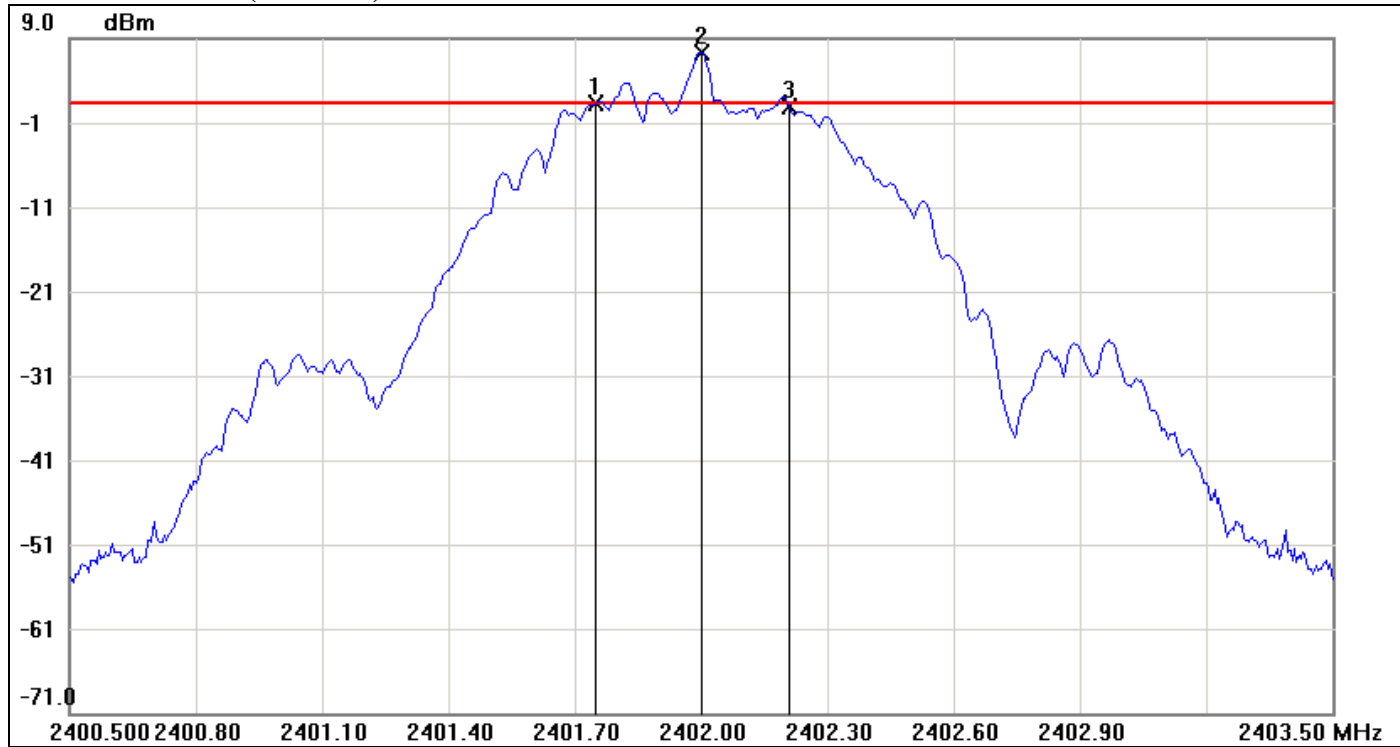

No.	Frequency(MHz)	Result(dBm)	Limit(dBm)	Margin(dBm)
1	2401.7500	1.28	1.42	-0.14
2	2402.0000	7.42	1.42	6.00
3	2402.2100	1.00	1.42	-0.42

No.		$\Delta$ Frequency(MHz)	$\Delta$ Level(dB)
1	mk3-mk1	0.46	-0.28

**6dB Bandwidth (CH Mid)**

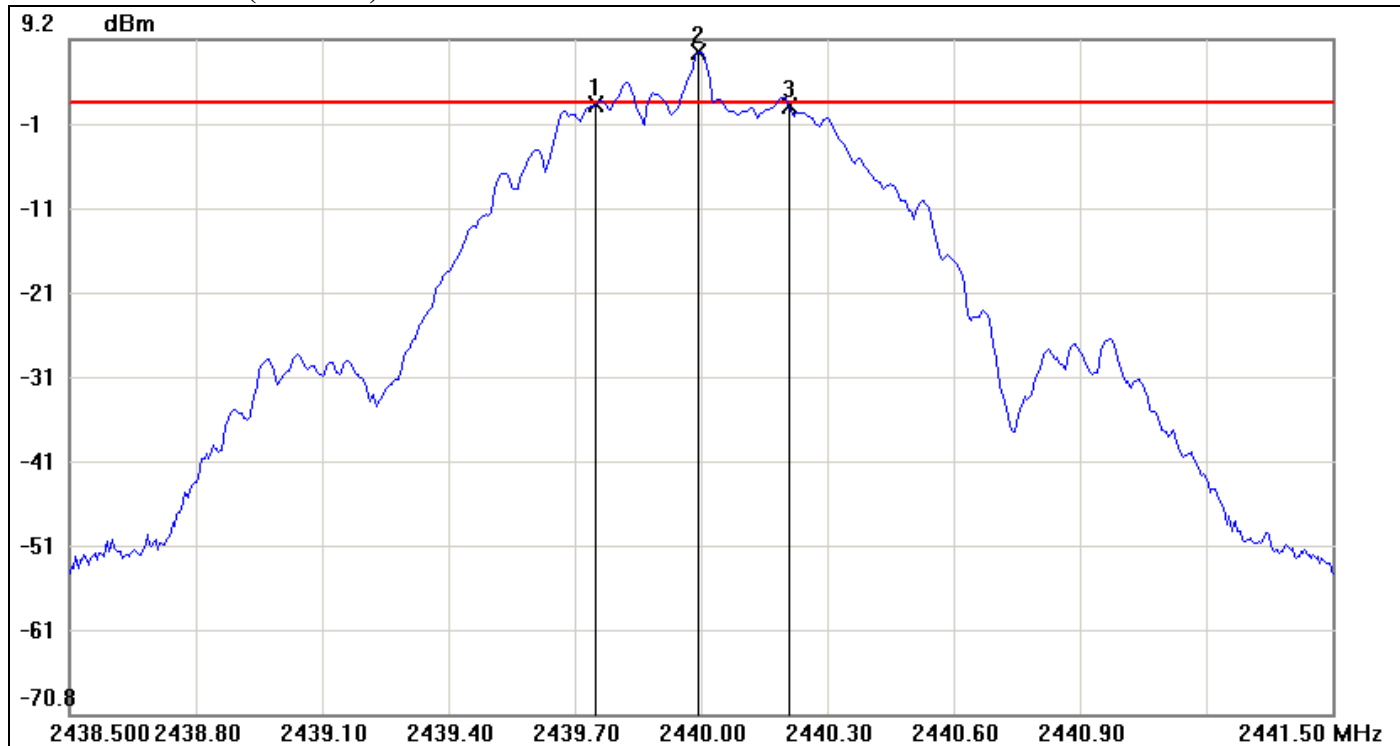

No.	Frequency(MHz)	Result(dBm)	Limit(dBm)	Margin(dBm)
1	2439.7500	1.52	1.59	-0.07
2	2439.9950	7.59	1.59	6.00
3	2440.2100	1.32	1.59	-0.27

No.		$\Delta$ Frequency(MHz)	$\Delta$ Level(dB)
1	mk3-mk1	0.46	-0.2



**6dB Bandwidth (CH High)**

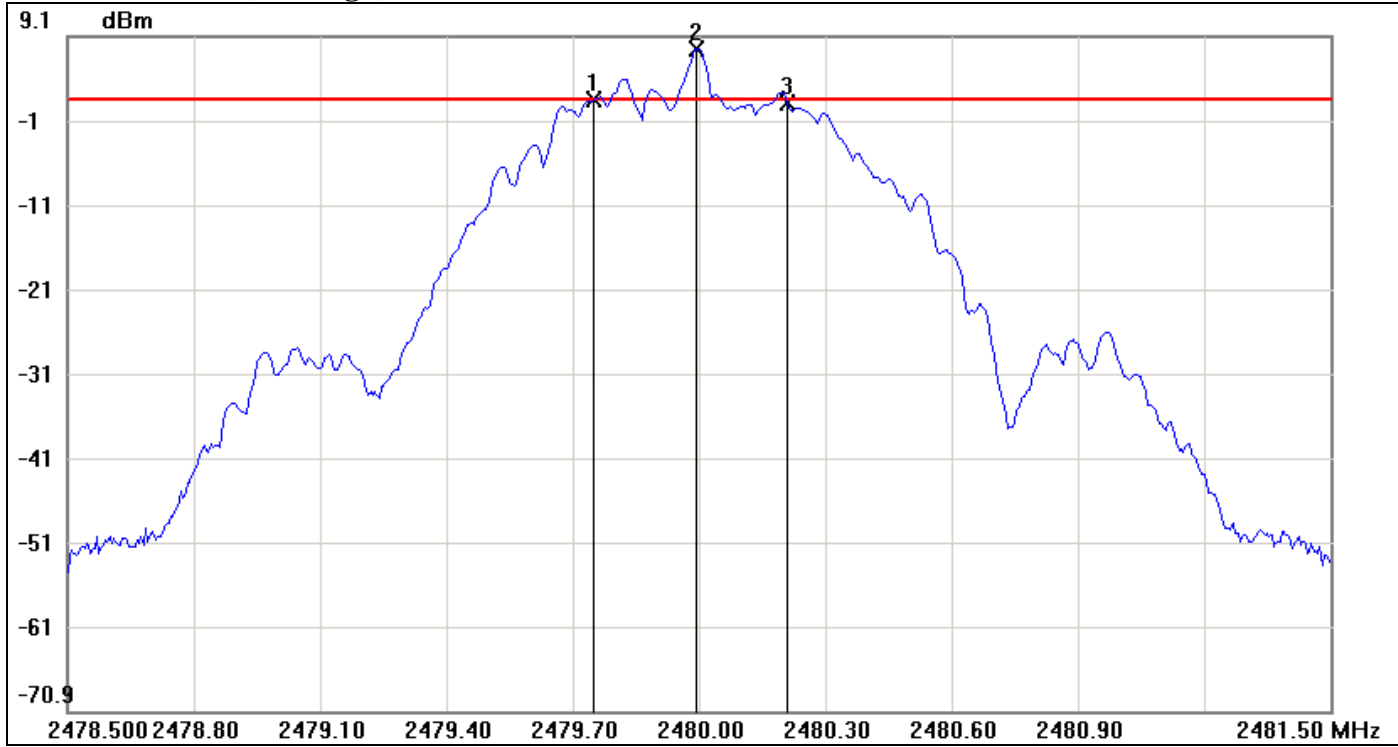

No.	Frequency(MHz)	Result(dBm)	Limit(dBm)	Margin(dBm)
1	2479.7500	1.63	1.69	-0.06
2	2479.9950	7.69	1.69	6.00
3	2480.2100	1.32	1.69	-0.37

No.		$\Delta$ Frequency(MHz)	$\Delta$ Level(dB)
1	mk3-mk1	0.46	-0.31

## 7.2 PEAK POWER

### LIMIT

The maximum peak output power of the intentional radiator shall not exceed the following:

1. According to §15.247(b)(3), for systems using digital modulation in the bands of 902-928 MHz, 2400-2483.5 MHz, and 5725-5850 MHz: 1 Watt.
2. According to §15.247(b)(4), the conducted output power limit specified in paragraph (b) of this section is based on the use of antennas with directional gains that do not exceed 6 dBi. Except as shown in paragraph (c) of this section, if transmitting antennas of directional gain greater than 6 dBi are used, the conducted output power from the intentional radiator shall be reduced below the stated values in paragraphs (b)(1), (b)(2), and (b)(3) of this section, as appropriate, by the amount in dB that the directional gain of the antenna exceeds 6 dBi.

### Test Configuration

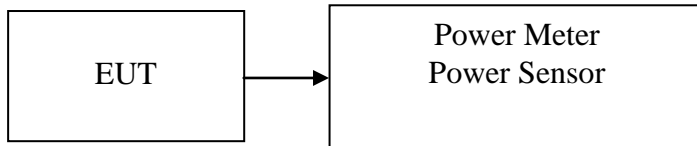

### TEST PROCEDURE

The transmitter output is connected to the Power Meter. The Power Meter is set to the peak power detection.

### TEST RESULTS

*No non-compliance noted*

#### Test Data

Channel	Frequency (MHz)	Output Power (dBm)	Output Power (W)	Limit (W)	Test Result
Low	2402	7.87	0.0061	1	PASS
Mid	2440	8.09	0.0064		PASS
High	2480	8.33	0.0068		PASS

### 7.3 AVERAGE POWER

#### LIMIT

None; for reporting purposes only.

#### Test Configuration

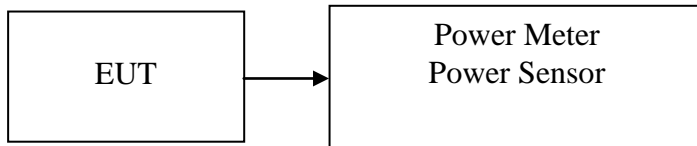

#### TEST PROCEDURE

The transmitter output is connected to the Power Meter. The Power Meter is set to the average power detection.

#### TEST RESULTS

*No non-compliance noted.*

#### Test Data

Channel	Frequency (MHz)	Output Power (dBm)	Output Power (W)
Low	2402	7.75	0.0060
Mid	2440	7.90	0.0062
High	2480	8.25	0.0067

## 7.4 BAND EDGES MEASUREMENT

### LIMIT

According to §15.247(d), in any 100 kHz bandwidth outside the frequency bands in which the spread spectrum intentional radiator is operating, the radio frequency power that is produced by the intentional radiator shall be at least 20 dB below that in the 100 kHz bandwidth within the band that contains the highest level of the desired power, based on either an RF conducted or a radiated measurement, provided the transmitter demonstrates compliance with the peak conducted power limits. In addition, radiated emissions which fall in the restricted bands, as defined in §15.205(a), must also comply with the radiated emission limits specified in 15.209(a) (see Section 15.205(c)).

### Test Configuration

#### For Radiated

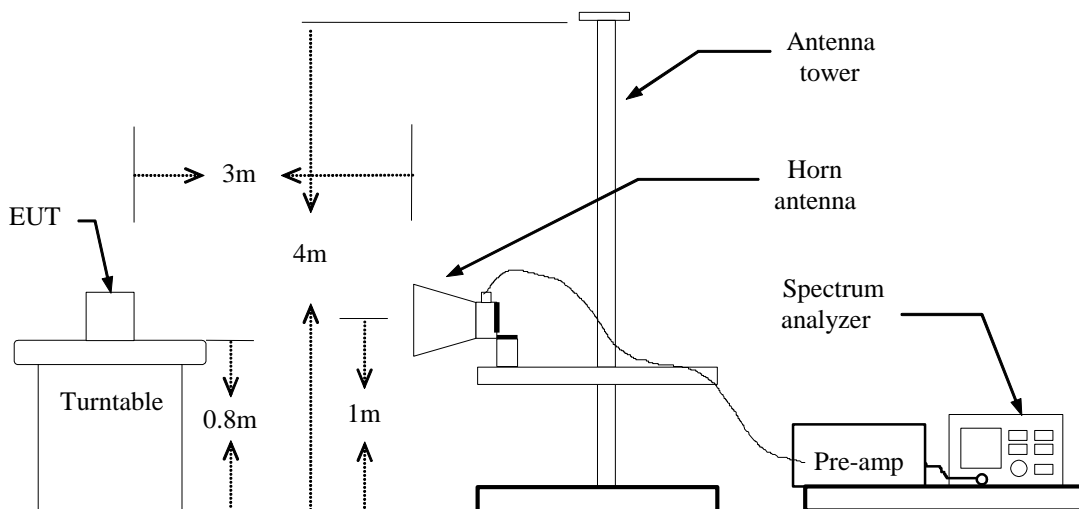

#### For Conducted

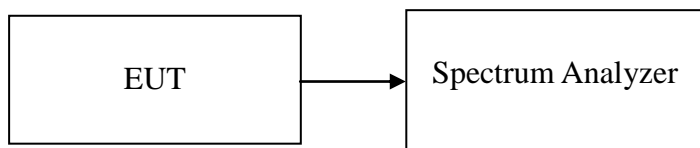

## **TEST PROCEDURE**

### **For Radiated**

1. The EUT is placed on a turntable, which is 1.5m above the ground plane.
2. The turntable shall be rotated for 360 degrees to determine the position of maximum emission level.
3. EUT is set 3m away from the receiving antenna, which is varied from 1m to 4m to find out the highest emission.
4. Set the spectrum analyzer in the following setting in order to capture the lower and upper band-edges of the emission:
  - (a) PEAK: RBW=1MHz / VBW=3MHz / Sweep=AUTO
  - (b) AVERAGE: RBW=1MHz / VBW= 300Hz / Sweep=AUTO
  - (c) if duty cycle  $\geq 98\%$ , VBW=10Hz.  
if duty cycle < 98% VBW=1/T.  
**BT4.0** < 98%, VBW= 2.7 KHz
5. Repeat the procedures until all the PEAK and AVERAGE versus POLARIZATION are measured.

### **For Conducted**

Conducted RF measurements of the transmitter output were made to confirm that the EUT antenna port conducted emissions meet the specified limit and to identify any spurious signals that require further investigation or measurements on the radiated emissions site.

The transmitter output is connected to the spectrum analyzer. The resolution bandwidth is set to 100 kHz. The video bandwidth is set to 100 kHz.

## **TEST RESULTS**

Refer to attach spectrum analyzer data chart.

**For PCB Antenna**

**Band Edges (CH Low)**

**Polarity: Vertical**

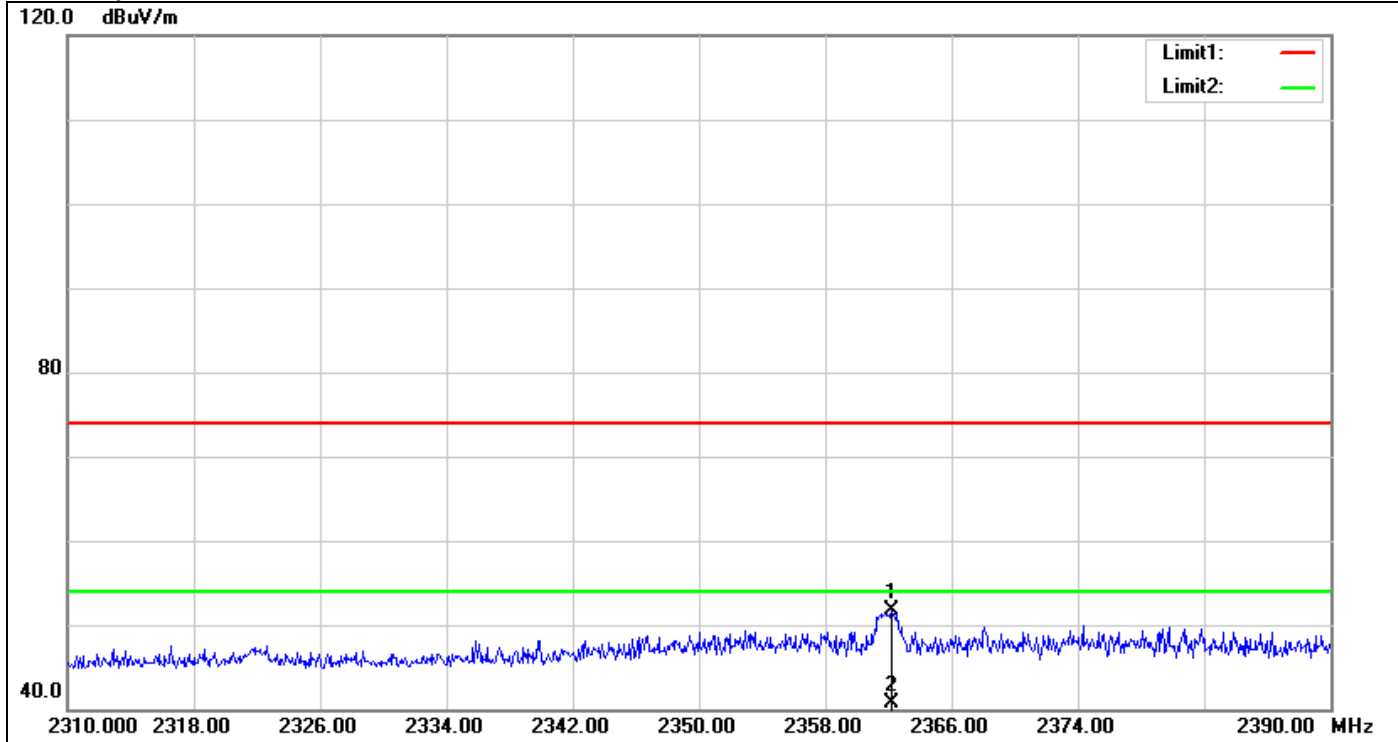

No.	Frequency (MHz)	Reading (dBuV)	Correct Factor(dB/m)	Result (dBuV/m)	Limit (dBuV/m)	Margin (dB)	Height (cm)	Degree (°)	Remark
1	2362.240	55.83	-4.05	51.78	74.00	-22.22	100	215	peak
2	2362.240	44.74	-4.05	40.69	54.00	-13.31	100	215	AVG

**Polarity: Horizontal**

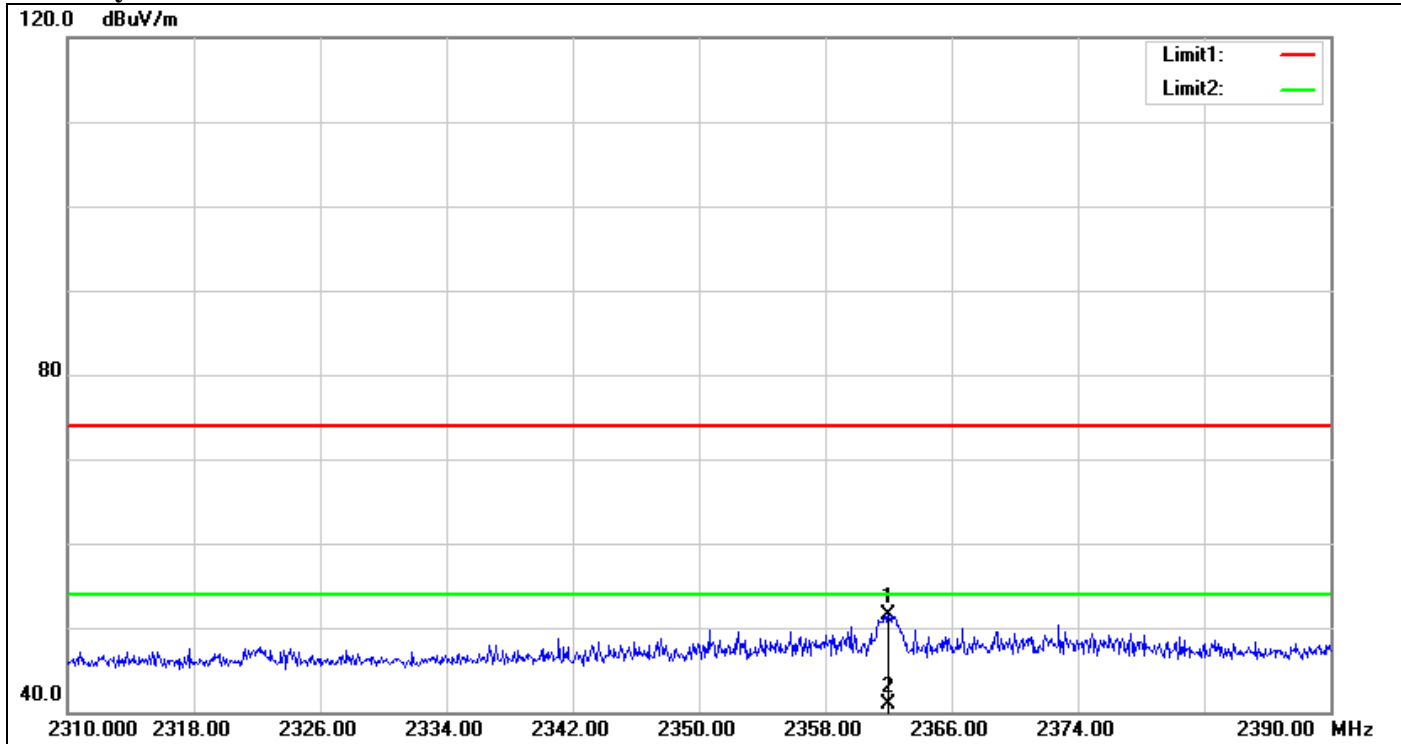

No.	Frequency (MHz)	Reading (dBuV)	Correct Factor(dB/m)	Result (dBuV/m)	Limit (dBuV/m)	Margin (dB)	Height (cm)	Degree (°)	Remark
1	2362.000	55.53	-4.06	51.47	74.00	-22.53	100	358	peak
2	2362.000	45.00	-4.06	40.94	54.00	-13.06	100	358	AVG

**Band Edges (CH High)**

**Polarity: Vertical**

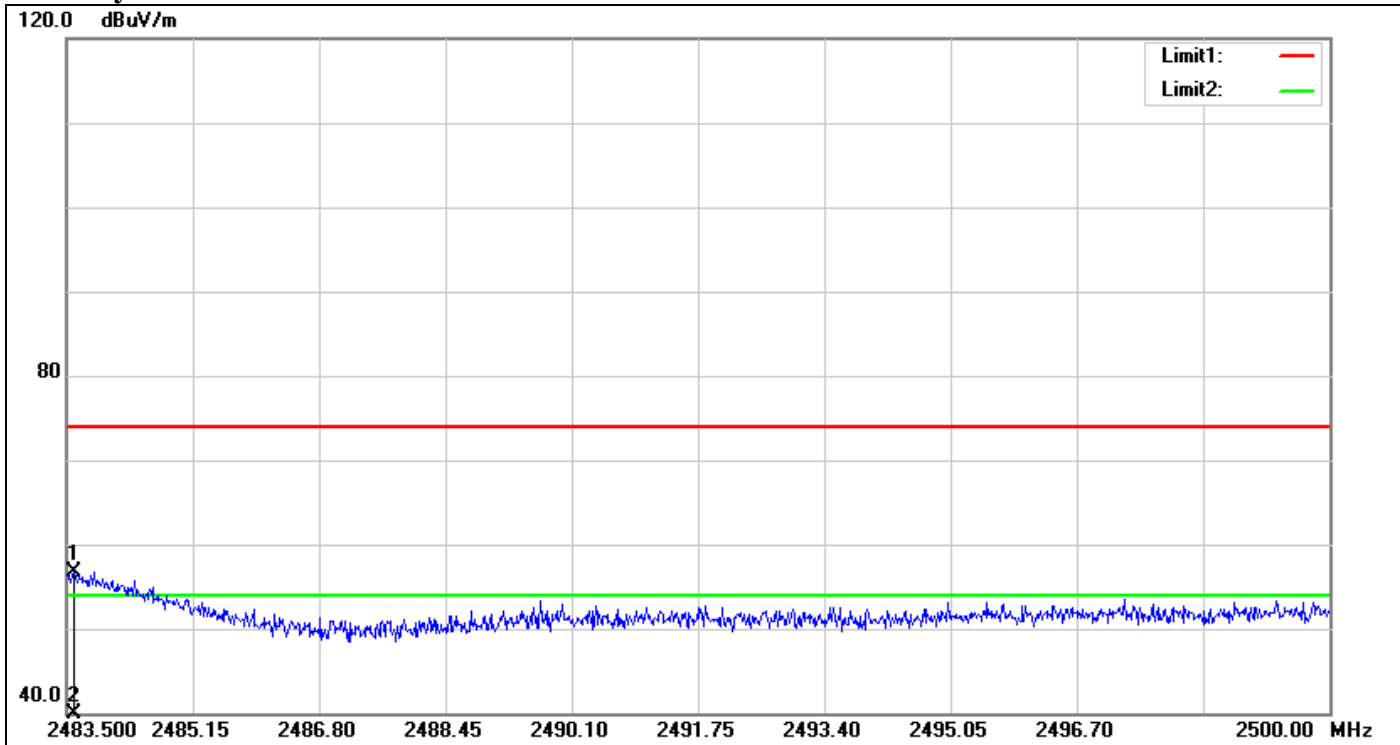

No.	Frequency (MHz)	Reading (dBuV)	Correct Factor(dB/m)	Result (dBuV/m)	Limit (dBuV/m)	Margin (dB)	Height (cm)	Degree (°)	Remark
1	2483.599	59.97	-3.27	56.70	74.00	-17.30	100	303	peak
2	2483.599	39.15	-3.27	35.88	54.00	-18.12	100	303	AVG



**Polarity: Horizontal**

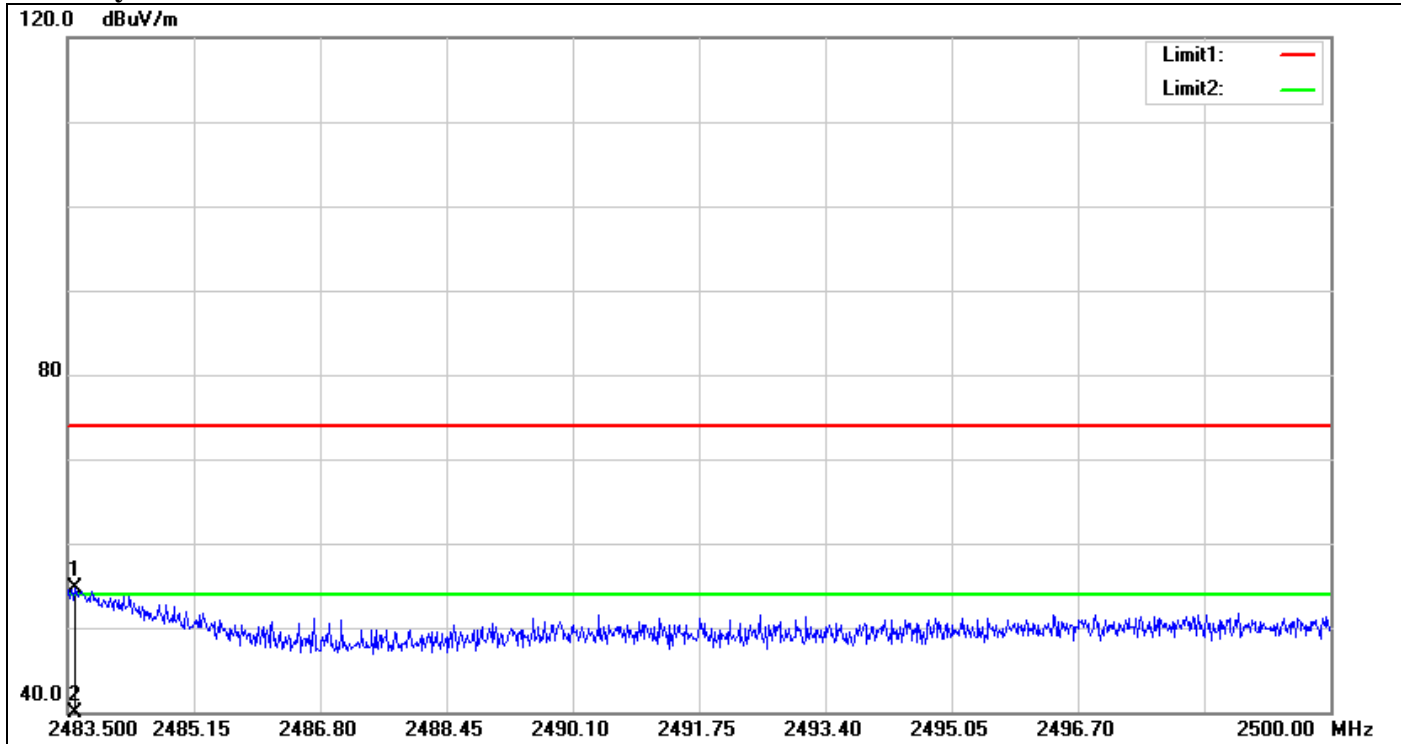

No.	Frequency (MHz)	Reading (dBuV)	Correct Factor(dB/m)	Result (dBuV/m)	Limit (dBuV/m)	Margin (dB)	Height (cm)	Degree (°)	Remark
1	2483.599	57.92	-3.27	54.65	74.00	-19.35	100	207	peak
2	2483.599	38.21	-3.27	34.94	54.00	-19.06	100	207	AVG

**For Dipole Antenna**

**Band Edges (CH Low)**

**Polarity: Vertical**

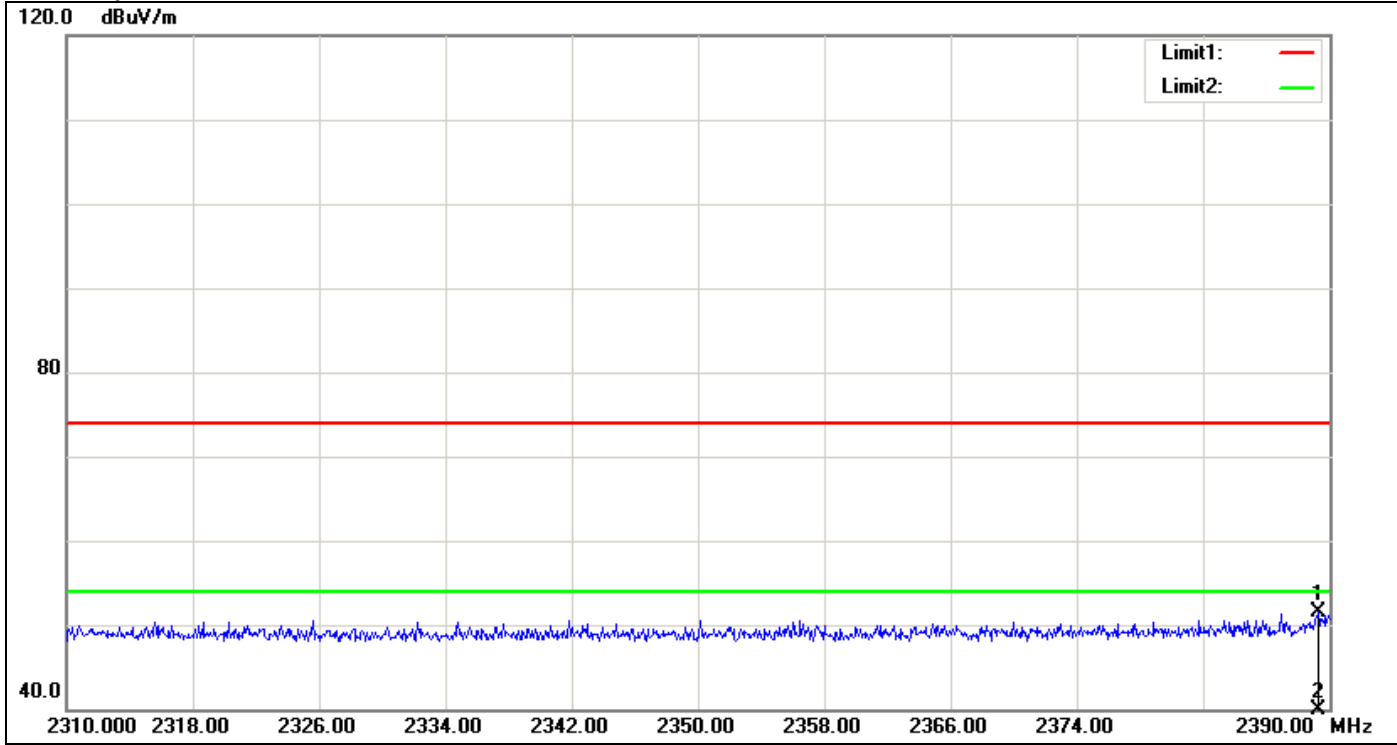

No.	Frequency (MHz)	Reading (dBuV)	Correct Factor(dB/m)	Result (dBuV/m)	Limit (dBuV/m)	Margin (dB)	Height (cm)	Degree ( ° )	Remark
1	2389.280	52.59	-1.06	51.53	74.00	-22.47	100	239	peak
2	2389.280	40.57	-1.06	39.51	54.00	-14.49	100	239	AVG

**Polarity: Horizontal**

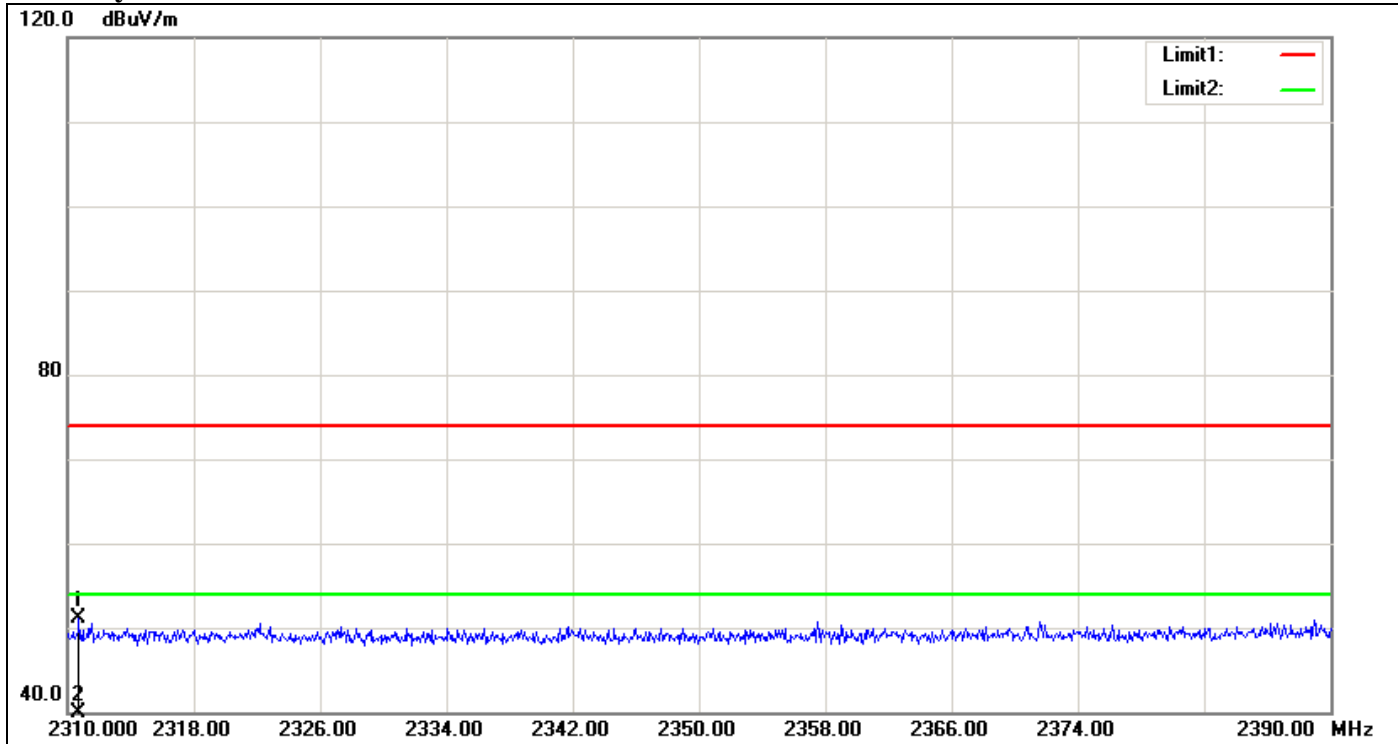

No.	Frequency (MHz)	Reading (dBuV)	Correct Factor(dB/m)	Result (dBuV/m)	Limit (dBuV/m)	Margin (dB)	Height (cm)	Degree (°)	Remark
1	2310.720	52.66	-1.60	51.06	74.00	-22.94	100	6	peak
2	2310.720	40.81	-1.60	39.21	54.00	-14.79	100	6	AVG

**Band Edges (CH High)**

**Polarity: Vertical**

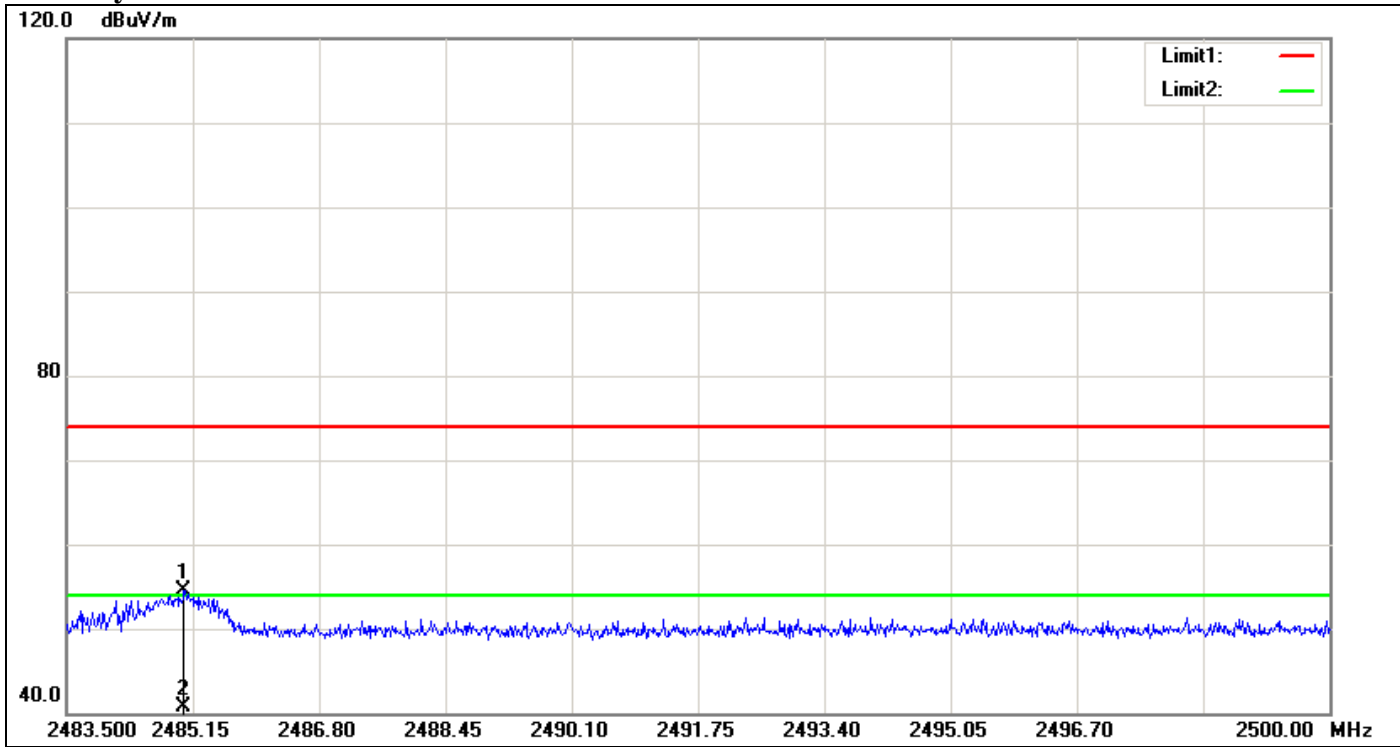

No.	Frequency (MHz)	Reading (dBuV)	Correct Factor(dB/m)	Result (dBuV/m)	Limit (dBuV/m)	Margin (dB)	Height (cm)	Degree (°)	Remark
1	2485.035	54.90	-0.45	54.45	74.00	-19.55	100	310	peak
2	2485.035	41.22	-0.45	40.77	54.00	-13.23	100	310	AVG

**Polarity: Horizontal**

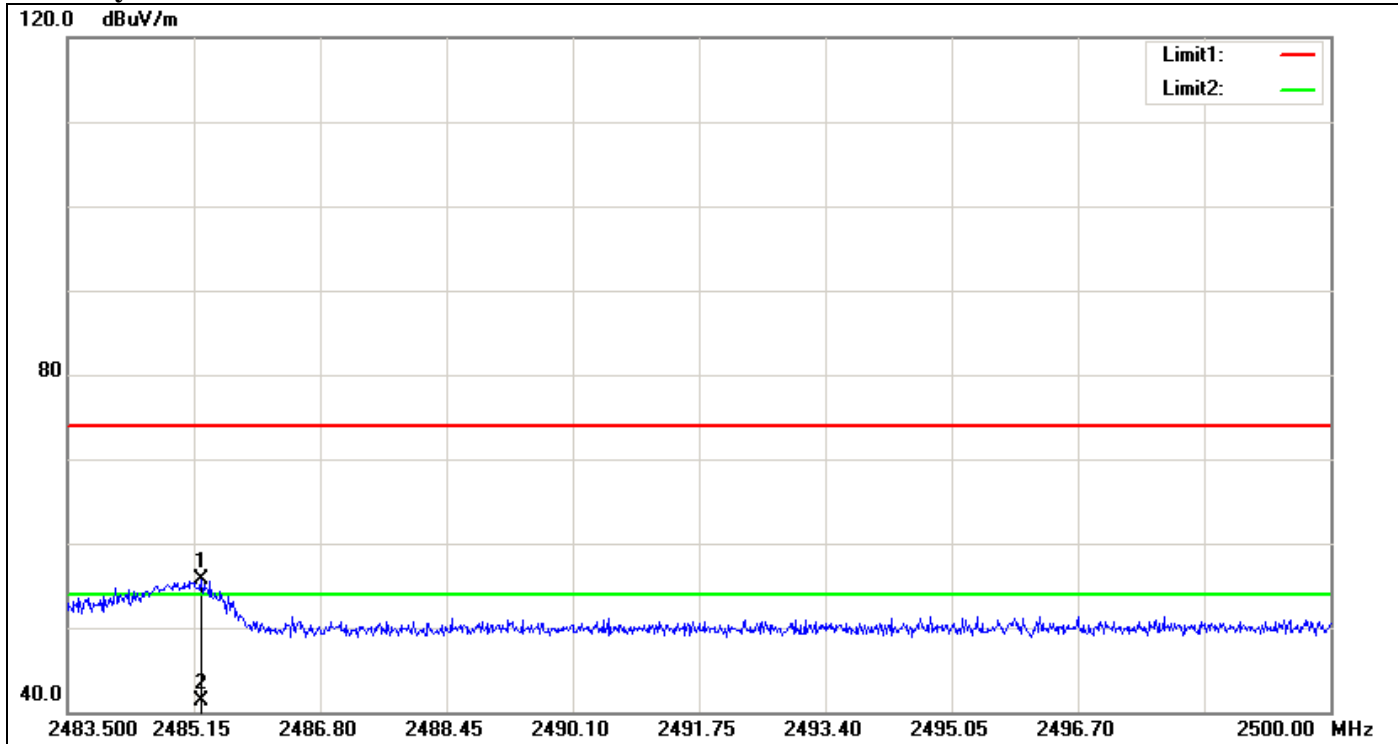

No.	Frequency (MHz)	Reading (dBuV)	Correct Factor(dB/m)	Result (dBuV/m)	Limit (dBuV/m)	Margin (dB)	Height (cm)	Degree (°)	Remark
1	2485.249	56.11	-0.45	55.66	74.00	-18.34	100	190	peak
2	2485.249	41.85	-0.45	41.40	54.00	-12.60	100	190	AVG

**Conducted Band Edges (CH Low)**

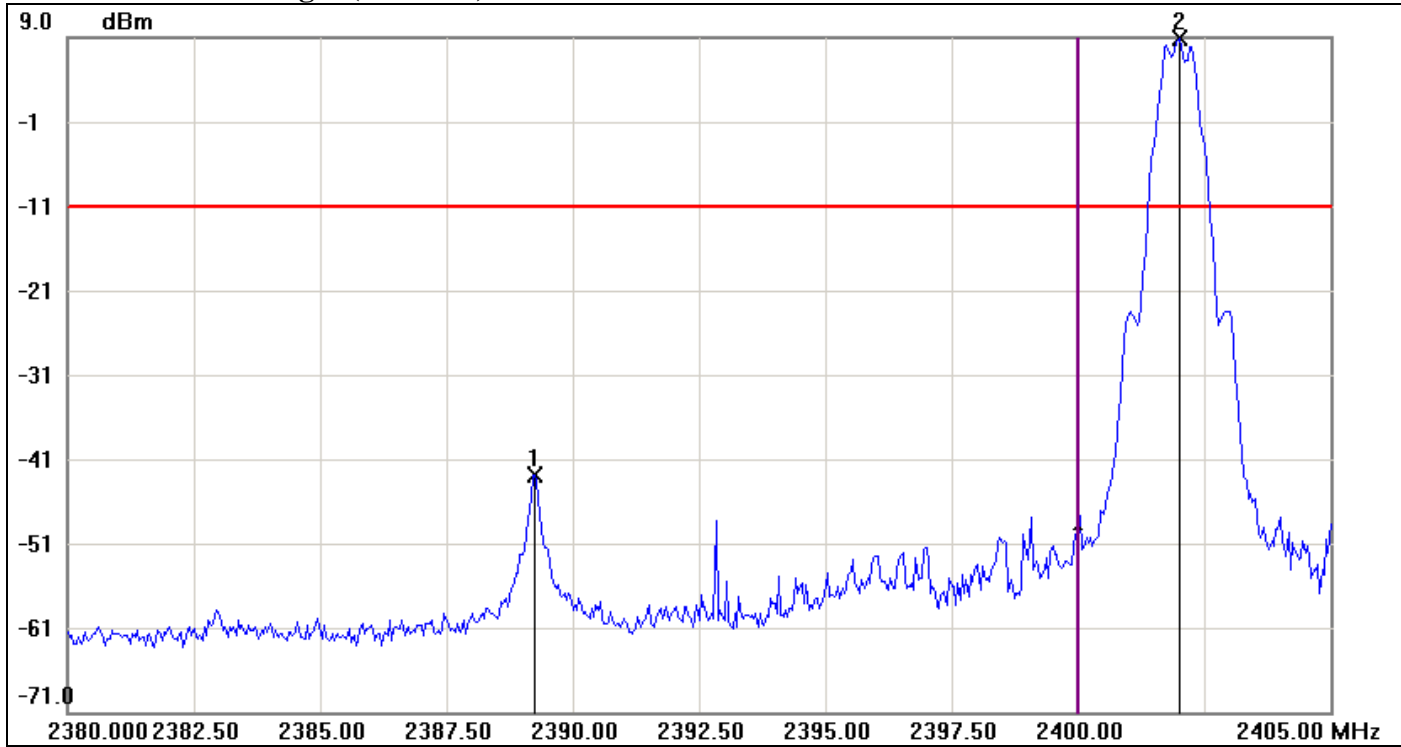

No.	Frequency(MHz)	Result(dBm)	Limit(dBm)	Margin(dBm)
1	2389.2500	-42.92	-11.23	-31.69
2	2402.0000	8.77	-11.23	20.00

**Conducted Band Edges (CH High)**

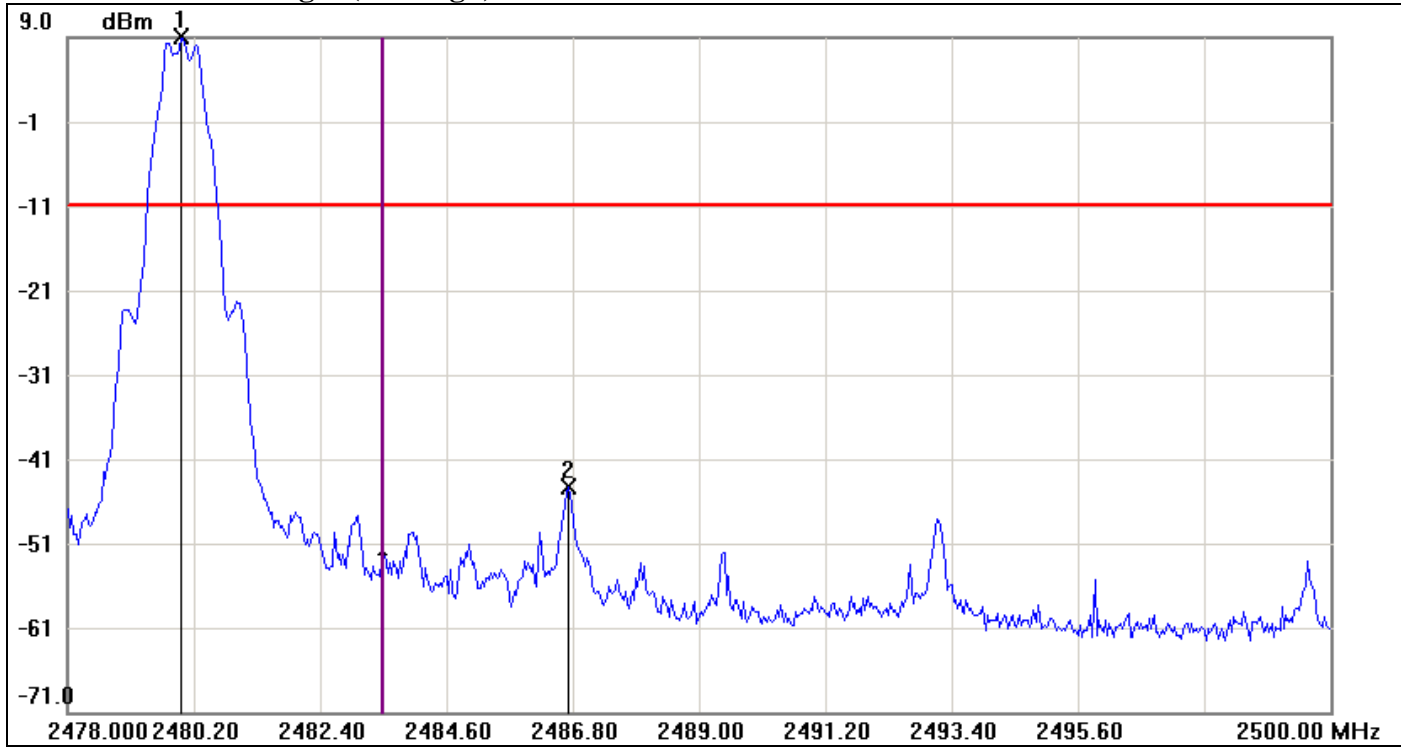

No.	Frequency(MHz)	Result(dBm)	Limit(dBm)	Margin(dBm)
1	2479.9800	9.06	-10.94	20.00
2	2486.7267	-44.34	-10.94	-33.40

## 7.5 PEAK POWER SPECTRAL DENSITY

### LIMIT

1. According to §15.247(e), for digitally modulated systems, the power spectral density conducted from the intentional radiator to the antenna shall not be greater than 8 dBm in any 3 kHz band during any time interval of continuous transmission.
2. According to §15.247(f), the digital modulation operation of the hybrid system, with the frequency hopping turned off, shall comply with the power density requirements of paragraph (d) of this section.

### Test Configuration

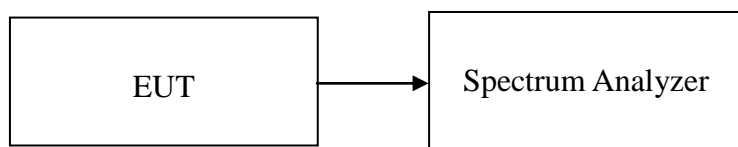

### TEST PROCEDURE

The transmitter output is connected to a spectrum analyzer. Set the RBW = 100 kHz, VBW ≥ 300 kHz, span to 1.5 times the DTS bandwidth, Detector = peak, Trace mode = max hold, Sweep = auto couple. Use the peak marker function to determine the maximum amplitude level within the RBW. If measured value exceeds limit, reduce RBW (no less than 3 kHz).

### TEST RESULTS

*No non-compliance noted*

#### Test Data

Channel	Frequency (MHz)	PPSD (dBm)	Limit (dBm)	Result
Low	2402	7.60	8.00	PASS
Mid	2440	7.75		PASS
High	2480	7.72		PASS



**Test Plot**

**PPSD (CH Low)**

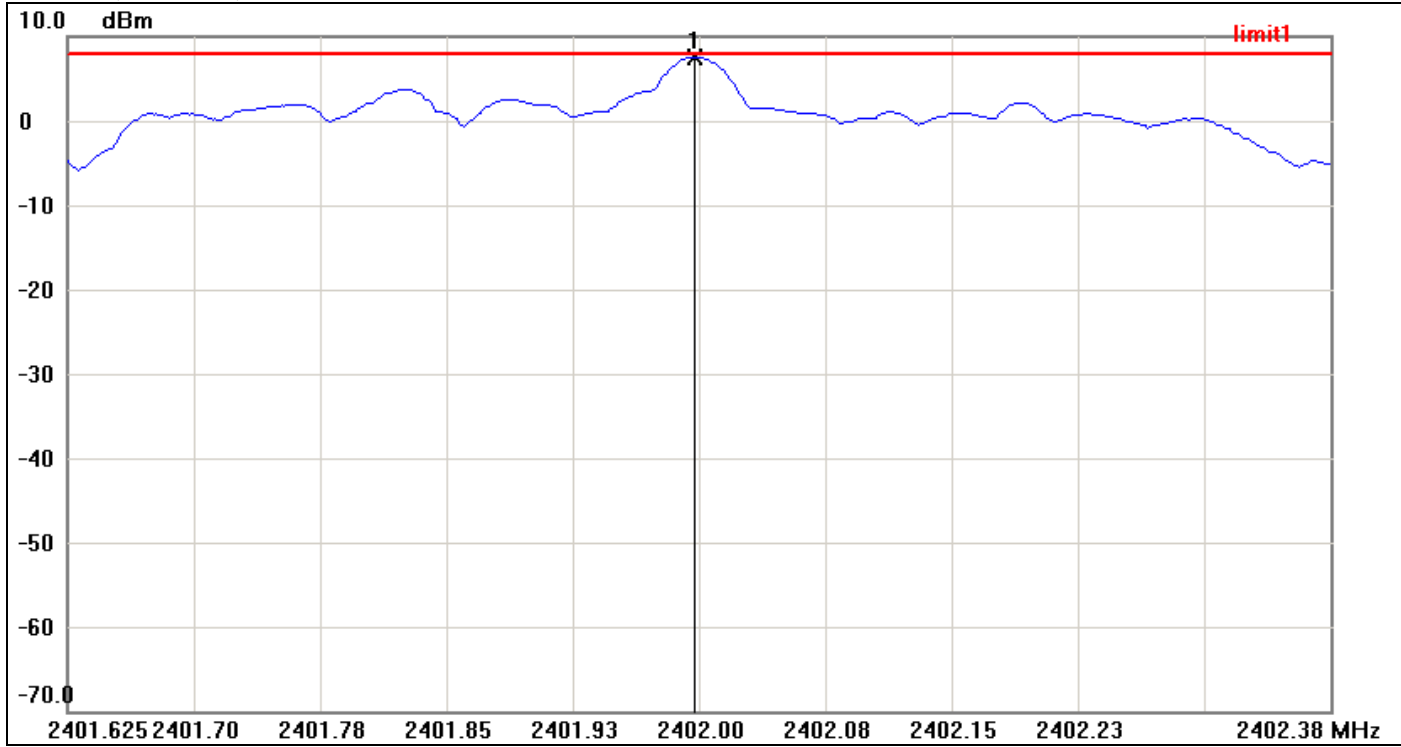

No.	Frequency(MHz)	Result(dBm)	Limit(dBm)	Margin(dBm)
1	2401.9975	7.60	8.00	-0.40

**PPSD (CH Mid)**

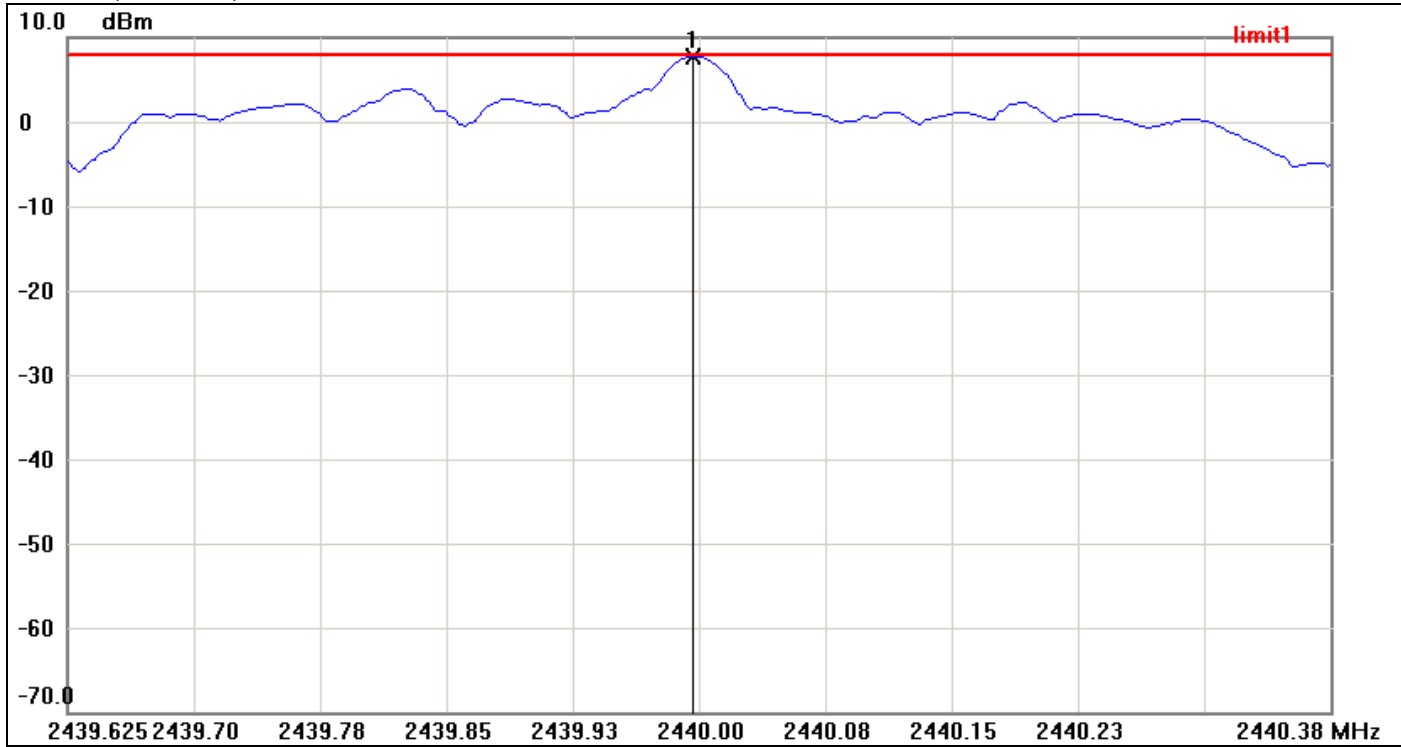

No.	Frequency(MHz)	Result(dBm)	Limit(dBm)	Margin(dBm)
1	2439.9963	7.75	8.00	-0.25

**PPSD (CH High)**

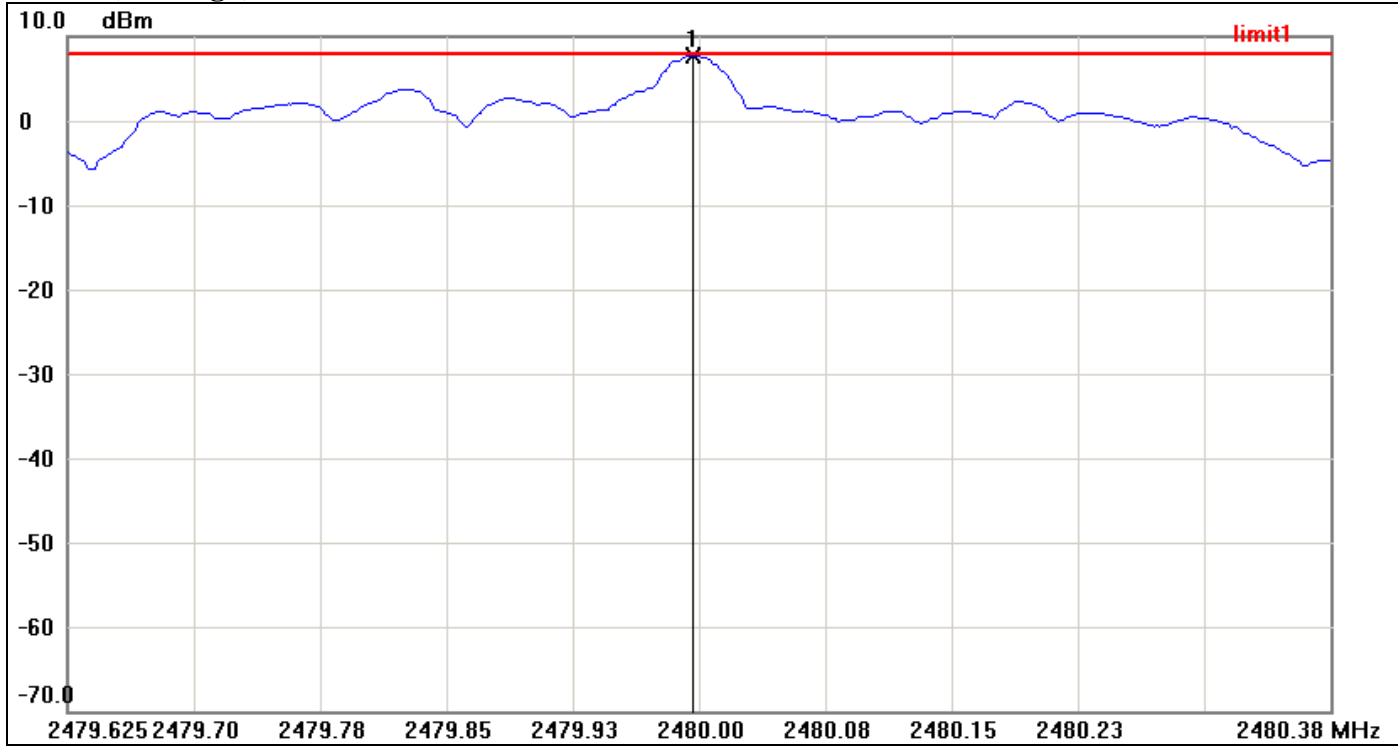

No.	Frequency(MHz)	Result(dBm)	Limit(dBm)	Margin(dBm)
1	2479.9963	7.72	8.00	-0.28

## **7.6 SPURIOUS EMISSIONS**

### **7.6.1 Conducted Measurement**

#### **LIMIT**

According to §15.247(d), in any 100 kHz bandwidth outside the frequency bands in which the spread spectrum intentional radiator is operating, the radio frequency power that is produced by the intentional radiator shall be at least 20 dB below that in the 100 kHz bandwidth within the band that contains the highest level of the desired power, based on either an RF conducted or a radiated measurement, provided the transmitter demonstrates compliance with the peak conducted power limits. In addition, radiated emissions which fall in the restricted bands, as defined in §15.205(a), must also comply with the radiated emission limits specified in 15.209(a) (see Section 15.205(c)).

#### **Test Configuration**

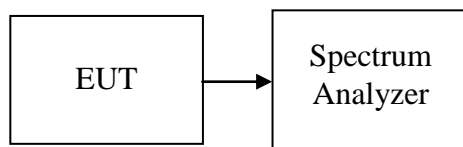

#### **TEST PROCEDURE**

The transmitter output is connected to a spectrum analyzer. Set the RBW=100 kHz and VBW= 300 kHz. Investigate the frequency from 30 MHz to 26 GHz with L, M and H channels separately.

#### **TEST RESULTS**

*No non-compliance noted.*

**Test Plot**

**CH Low**

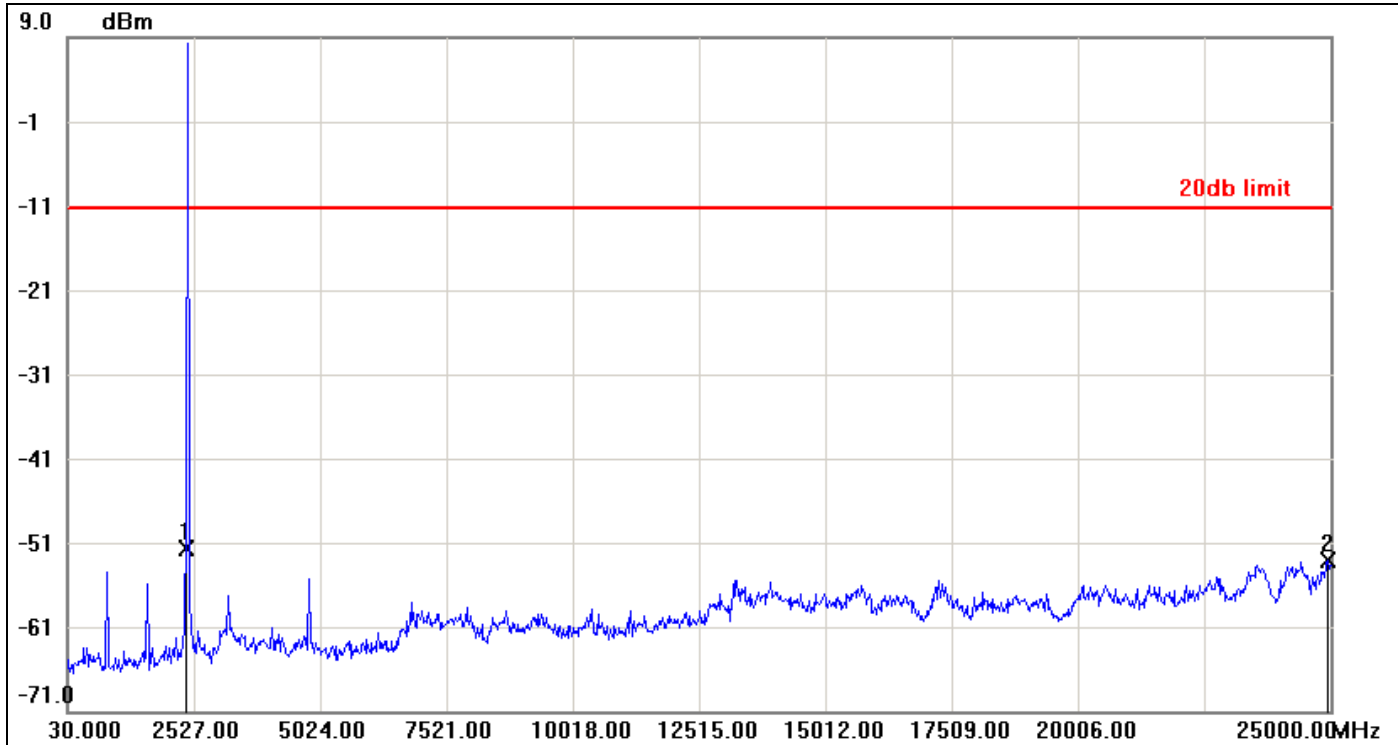

No.	Frequency(MHz)	Result(dBm)	Limit(dBm)	Margin(dBm)
1	2377.1800	-51.76	-11.23	-40.53
2	24950.0600	-53.01	-11.23	-41.78

**CH Mid**

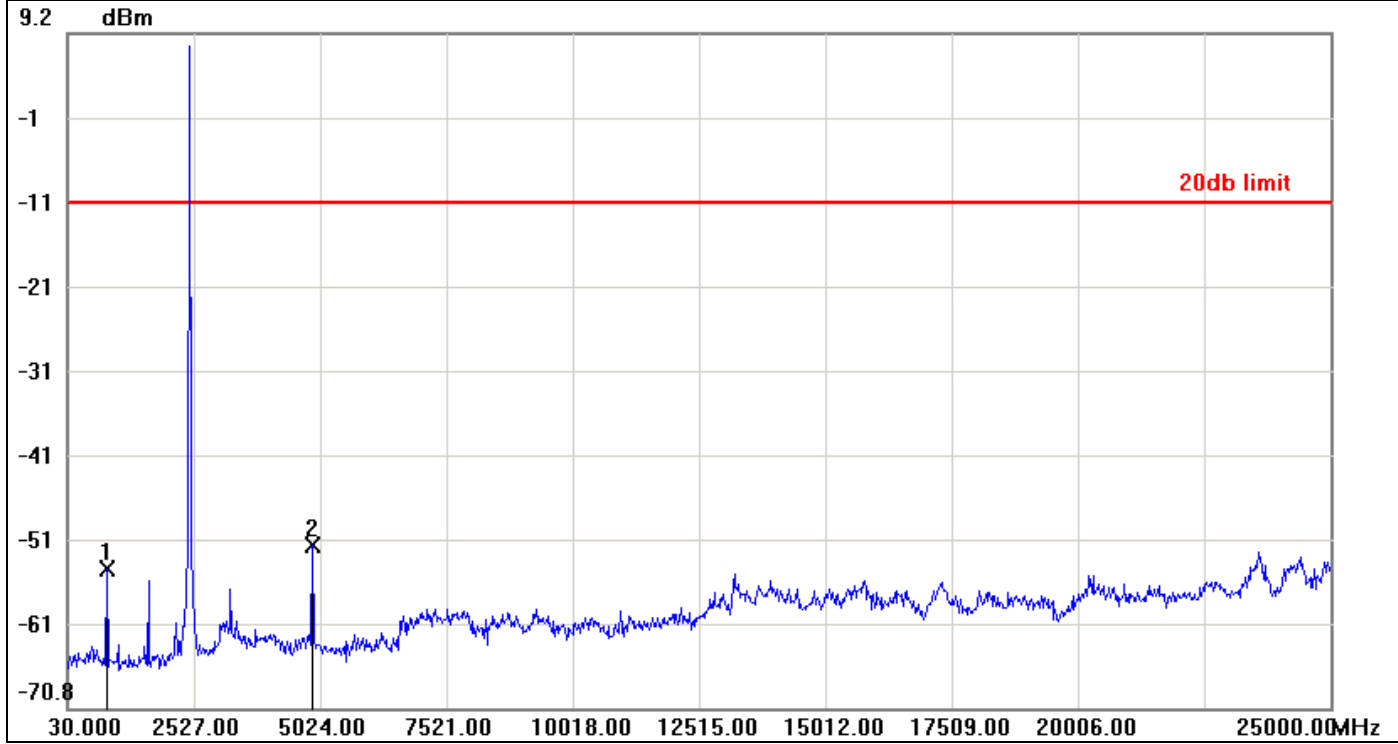

No.	Frequency(MHz)	Result(dBm)	Limit(dBm)	Margin(dBm)
1	804.0700	-54.34	-11.01	-43.33
2	4874.1800	-51.48	-11.01	-40.47

**CH High**

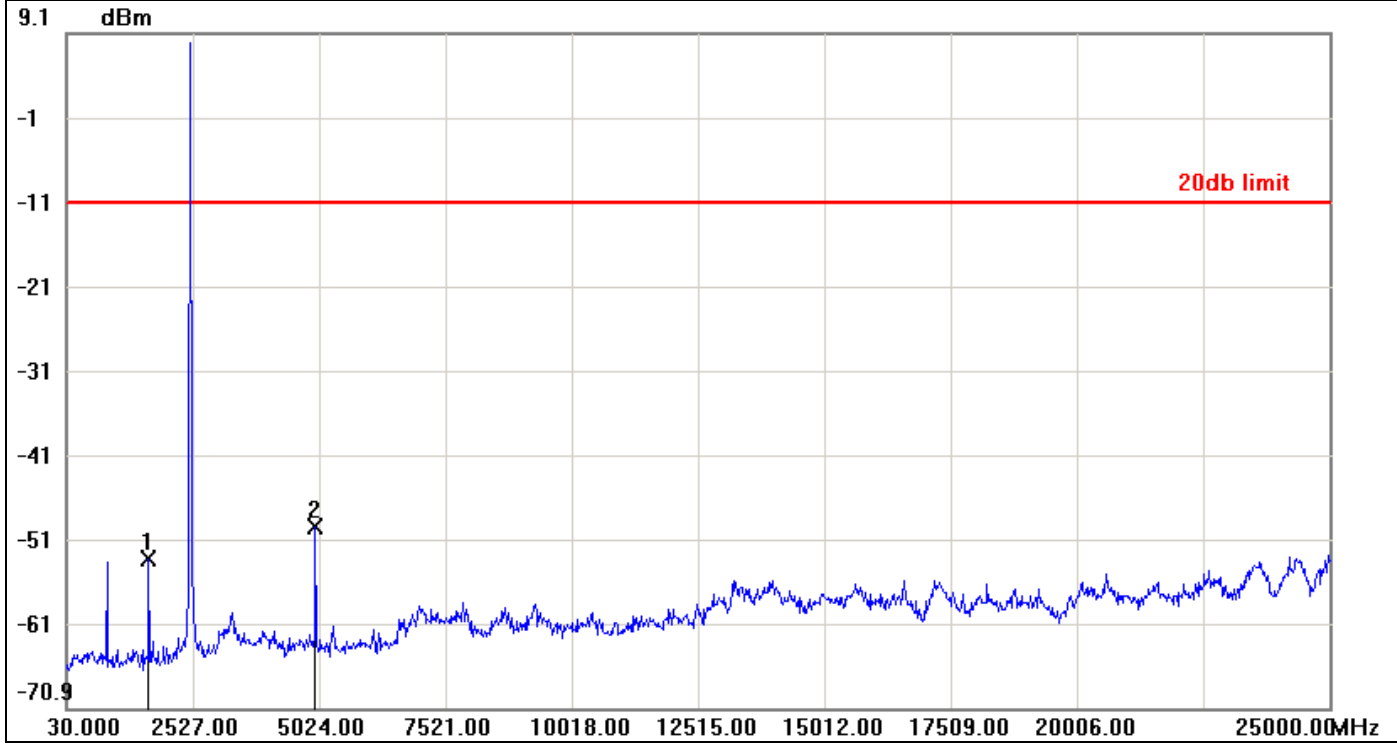

No.	Frequency(MHz)	Result(dBm)	Limit(dBm)	Margin(dBm)
1	1653.0500	-53.20	-10.91	-42.29
2	4949.0900	-49.45	-10.91	-38.54

## 7.6.2 Radiated Emissions

### LIMIT

1. According to §15.209(a), except as provided elsewhere in this Subpart, the emissions from an intentional radiator shall not exceed the field strength levels specified in the following table:

Frequency (MHz)	Field Strength (µV/m)	Measurement Distance (m)
0.009 - 0.490	2400/F(kHz)	300
0.490 - 1.705	24000/F(kHz)	30
1.705 – 30.0	30	30
30-88	100	3
88-216	150	3
216-960	200	3
Above 960	500	3

**Remark:** Except as provided in paragraph (g), fundamental emissions from intentional radiators operating under this Section shall not be located in the frequency bands 54-72 MHz, 76-88 MHz, 174-216 MHz or 470-806 MHz. However, operation within these frequency bands is permitted under other sections of this Part, e.g., Sections 15.231 and 15.241.

2. In the emission table above, the tighter limit applies at the band edges.

Frequency (MHz)	Field Strength (µV/m at 3-meter)	Field Strength (dBµV/m at 3-meter)
0.009 - 0.490	2400/F(kHz) +80	20LOG((2400/F(kHz))+80)
0.490 - 1.705	24000/F(kHz) +40	20LOG((24000/F(kHz))+40)
1.705 – 30.0	30	69.54
30-88	100	40
88-216	150	43.5
216-960	200	46
Above 960	500	54



**Test Configuration**

**9kHz ~ 30MHz**

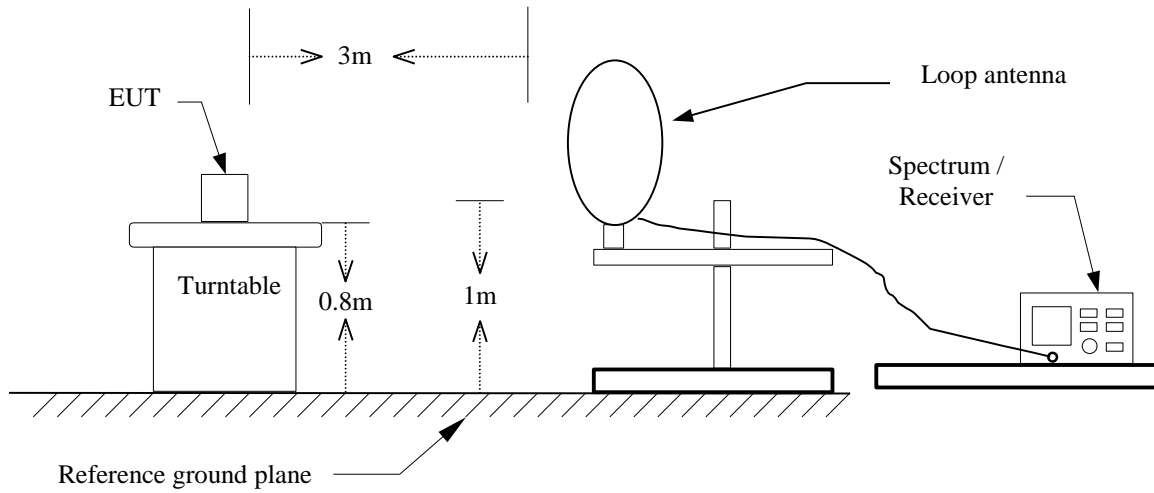

**30MHz ~ 1GHz**

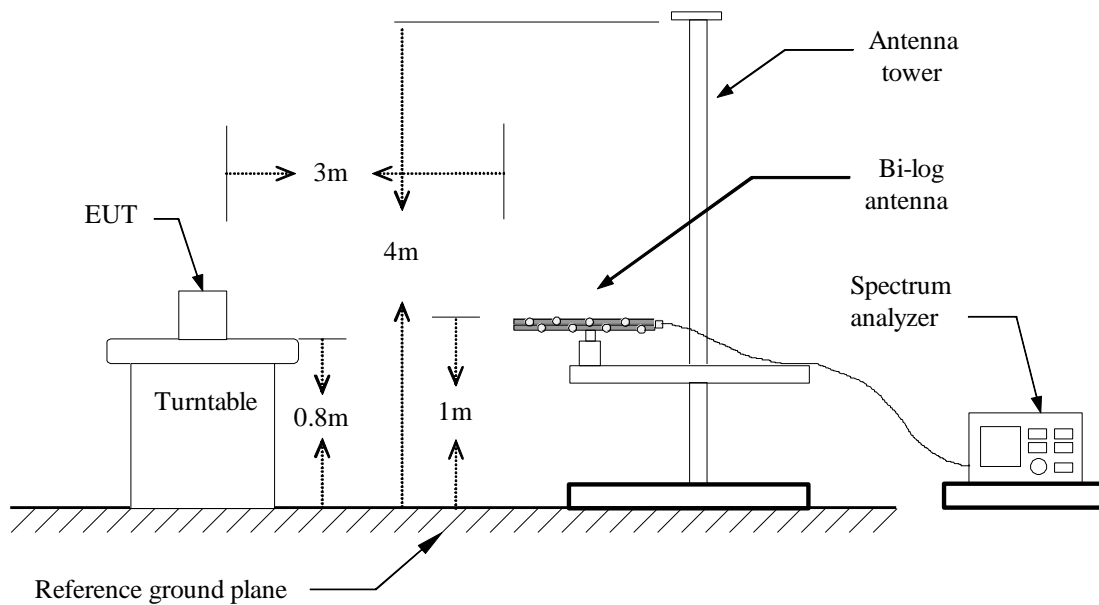

**Above 1 GHz**

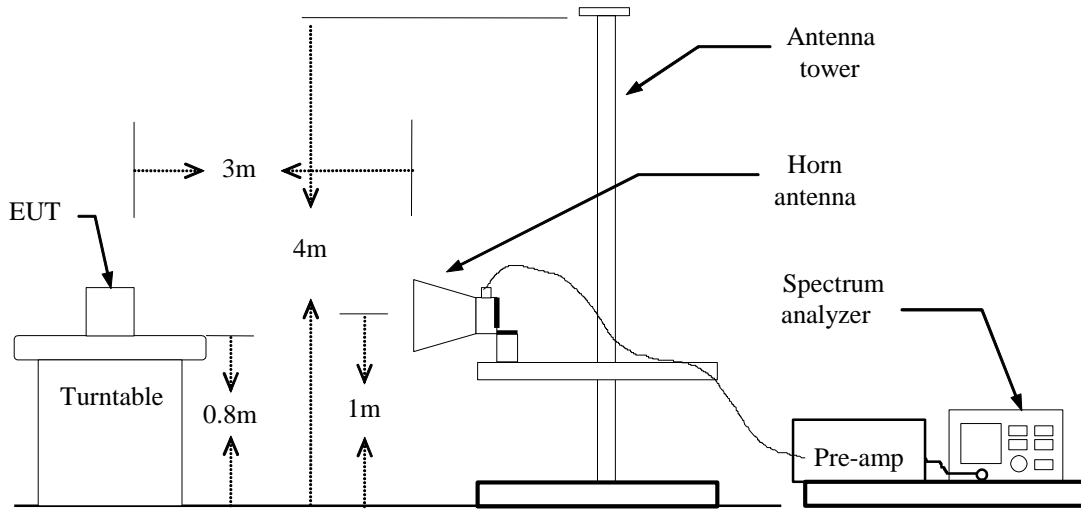

## **TEST PROCEDURE**

1. The EUT is placed on a turntable, which is 1.5m above ground plane.
2. The turntable shall be rotated for 360 degrees to determine the position of maximum emission level.
3. EUT is set 3m away from the receiving antenna, which is varied from 1m to 4m to find out the highest emissions.
4. Maximum procedure was performed on the six highest emissions to ensure EUT compliance.
5. And also, each emission was to be maximized by changing the polarization of receiving antenna both horizontal and vertical.
6. Set the spectrum analyzer in the following setting as:  
Below 1GHz:  
RBW=100kHz / VBW=300kHz / Sweep=AUTO  
Above 1GHz:  
(a) PEAK: RBW=VBW=1MHz / Sweep=AUTO  
(b) AVERAGE: RBW=1MHz / VBW=300Hz / Sweep=AUTO  
(c) if duty cycle  $\geq$  98%, VBW=10Hz.  
if duty cycle < 98% VBW=1/T.  
**BT4.0 < 98%, VBW= 2.7KHz**
7. Repeat above procedures until the measurements for all frequencies are complete.

**Below 1 GHz**

**Operation Mode:** Normal Link

**Test Date:** April 29, 2015

**Temperature:** 27°C

**Tested by:** Andy Shi

**Humidity:** 53 % RH

**Polarity:** Ver. / Hor.

Frequency (MHz)	Reading (dBuV)	Correction Factor (dB/m)	Result (dBuV/m)	Limit (dBuV/m)	Margin (dB)	Remark	Ant.Pol. (H/V)
57.1600	54.62	-23.64	30.98	40.00	-9.02	Peak	V
84.3200	54.50	-23.20	31.30	40.00	-8.70	Peak	V
123.1200	46.91	-17.42	29.49	43.50	-14.01	Peak	V
246.3100	40.11	-18.48	21.63	46.00	-24.37	Peak	V
448.0700	40.07	-12.71	27.36	46.00	-18.64	Peak	V
625.5800	35.09	-9.90	25.19	46.00	-20.81	Peak	V
57.1600	53.91	-23.64	30.27	40.00	-9.73	Peak	H
95.9600	53.34	-21.90	31.44	43.50	-12.06	Peak	H
150.2800	50.12	-17.99	32.13	43.50	-11.37	Peak	H
342.3400	47.91	-15.38	32.53	46.00	-13.47	Peak	H
448.0700	39.25	-12.71	26.54	46.00	-19.46	Peak	H
757.5000	39.27	-7.80	31.47	46.00	-14.53	Peak	H

**Remark:**

1. *No emission found between lowest internal used/generated frequency to 30MHz (9kHz~30MHz)*
2. *Radiated emissions measured in frequency range from 30 MHz to 1000MHz were made with an instrument using peak/quasi-peak detector mode.*
3. *Quasi-peak test would be performed if the peak result were greater than the quasi-peak limit or as required by the applicant.*
4. *Measurements above show only up to 6 maximum emissions noted, or would be lesser, with " N/A " remark, if no specific emissions from the EUT are recorded (ie: margin>20dB from the applicable limit) and considered that's already beyond the background noise floor.*
5. *Margin (dB) = Remark result (dBuV/m) – Quasi-peak limit (dBuV/m).*

**Above 1 GHz**

**For PCB Antenna**

**Operation Mode:** GFSK / TX / CH Low

**Test Date:** May 8, 2015

**Temperature:** 27°C

**Tested by:** Owen Wu

**Humidity:** 53 % RH

**Polarity:** Ver. / Hor.

Frequency (MHz)	Reading (dBuV)	Correction (dB/m)	Result (dBuV/m)	Limit (dBuV/m)	Margin (dB)	Remark	Ant.Pol. (H/V)
1956.000	53.63	-5.11	48.52	74.00	-25.48	peak	V
N/A							
1952.000	51.48	-5.13	46.35	74.00	-27.65	peak	H
N/A							

**Remark:**

1. *Measuring frequencies from 1 GHz to the 10th harmonic of highest fundamental frequency.*
2. *Radiated emissions measured in frequency above 1000MHz were made with an instrument using peak/average detector mode.*
3. *Average test would be performed if the peak result were greater than the average limit or as required by the applicant.*
4. *Data of measurement within this frequency range shown “ --- ” in the table above means the reading of emissions are attenuated more than 20dB below the permissible limits or the field strength is too small to be measured.*
5. *Measurements above show only up to 6 maximum emissions noted, or would be lesser, with “ N/A ” remark, if no specific emissions from the EUT are recorded (ie: margin>20dB from the applicable limit) and considered that's already beyond the background noise floor.*
6. *Margin (dB) = Remark result (dBuV/m) – Average limit (dBuV/m).*

**Operation Mode:** GFSK / TX / CH Mid

**Test Date:** April 20, 2015

**Temperature:** 27°C

**Tested by:** David Shu

**Humidity:** 53 % RH

**Polarity:** Ver. / Hor.

Frequency (MHz)	Reading (dBuV)	Correction (dB/m)	Result (dBuV/m)	Limit (dBuV/m)	Margin (dB)	Remark	Ant.Pol. (H/V)
1798.000	54.85	-5.95	48.90	74.00	-25.10	peak	V
N/A							
1196.000	55.86	-8.87	46.99	74.00	-27.01	peak	H
N/A							

**Remark:**

1. *Measuring frequencies from 1 GHz to the 10th harmonic of highest fundamental frequency.*
2. *Radiated emissions measured in frequency above 1000MHz were made with an instrument using peak/average detector mode.*
3. *Average test would be performed if the peak result were greater than the average limit or as required by the applicant.*
4. *Data of measurement within this frequency range shown “ --- ” in the table above means the reading of emissions are attenuated more than 20dB below the permissible limits or the field strength is too small to be measured.*
5. *Measurements above show only up to 6 maximum emissions noted, or would be lesser, with “ N/A ” remark, if no specific emissions from the EUT are recorded (ie: margin>20dB from the applicable limit) and considered that's already beyond the background noise floor.*
6. *Margin (dB) = Remark result (dBuV/m) – Average limit (dBuV/m).*

**Operation Mode:** GFSK / TX / CH High                      **Test Date:** May 8, 2015  
**Temperature:** 27°C    **Tested by:** Owen Wu  
**Humidity:** 53 % RH    **Polarity:** Ver. / Hor.

Frequency (MHz)	Reading (dBuV)	Correction (dB/m)	Result (dBuV/m)	Limit (dBuV/m)	Margin (dB)	Remark	Ant.Pol. (H/V)
1948.000	53.82	-5.16	48.66	74.00	-25.34	peak	V
6000.000	42.24	7.38	49.62	74.00	-24.38	peak	V
N/A							
1948.000	52.93	-5.16	47.77	74.00	-26.23	peak	H
N/A							

**Remark:**

1. *Measuring frequencies from 1 GHz to the 10th harmonic of highest fundamental frequency.*
2. *Radiated emissions measured in frequency above 1000MHz were made with an instrument using peak/average detector mode.*
3. *Average test would be performed if the peak result were greater than the average limit or as required by the applicant.*
4. *Data of measurement within this frequency range shown “ --- ” in the table above means the reading of emissions are attenuated more than 20dB below the permissible limits or the field strength is too small to be measured.*
5. *Measurements above show only up to 6 maximum emissions noted, or would be lesser, with “ N/A ” remark, if no specific emissions from the EUT are recorded (ie: margin>20dB from the applicable limit) and considered that's already beyond the background noise floor.*
6. *Margin (dB) = Remark result (dBuV/m) – Average limit (dBuV/m).*

**For Dipole Antenna**

**Operation Mode:** GFSK / TX / CH Low

**Test Date:** May 27, 2015

**Temperature:** 27°C

**Tested by:** Dennis Li

**Humidity:** 53 % RH

**Polarity:** Ver. / Hor.

Frequency (MHz)	Reading (dBuV)	Correction (dB/m)	Result (dBuV/m)	Limit (dBuV/m)	Margin (dB)	Remark	Ant.Pol. (H/V)
1366.000	51.02	-6.21	44.81	74.00	-29.19	peak	V
4810.000	40.36	8.07	48.43	74.00	-25.57	peak	V
5445.000	39.61	9.99	49.60	74.00	-24.40	peak	V
N/A							
1522.000	50.73	-5.38	45.35	74.00	-28.65	peak	H
4395.000	40.07	6.79	46.86	74.00	-27.14	peak	H
5355.000	39.89	9.80	49.69	74.00	-24.31	peak	H
N/A							

**Remark:**

1. Measuring frequencies from 1 GHz to the 10th harmonic of highest fundamental frequency.
2. Radiated emissions measured in frequency above 1000MHz were made with an instrument using peak/average detector mode.
3. Average test would be performed if the peak result were greater than the average limit or as required by the applicant.
4. Data of measurement within this frequency range shown “ --- ” in the table above means the reading of emissions are attenuated more than 20dB below the permissible limits or the field strength is too small to be measured.
5. Measurements above show only up to 6 maximum emissions noted, or would be lesser, with “ N/A ” remark, if no specific emissions from the EUT are recorded (ie: margin>20dB from the applicable limit) and considered that's already beyond the background noise floor.
6. Margin (dB) = Remark result (dBuV/m) – Average limit (dBuV/m).



**Operation Mode:** GFSK / TX / CH Mid

**Test Date:** May 27, 2015

**Temperature:** 27°C

**Tested by:** Dennis Li

**Humidity:** 53 % RH

**Polarity:** Ver. / Hor.

Frequency (MHz)	Reading (dBuV)	Correction (dB/m)	Result (dBuV/m)	Limit (dBuV/m)	Margin (dB)	Remark	Ant.Pol. (H/V)
1640.000	49.98	-4.66	45.32	74.00	-28.68	peak	V
4565.000	40.13	7.42	47.55	74.00	-26.45	peak	V
5500.000	39.37	9.73	49.10	74.00	-24.90	peak	V
N/A							
1622.000	51.25	-4.77	46.48	74.00	-27.52	peak	H
4645.000	40.31	7.64	47.95	74.00	-26.05	peak	H
6065.000	39.58	12.63	52.21	74.00	-21.79	peak	H
N/A							

**Remark:**

1. *Measuring frequencies from 1 GHz to the 10th harmonic of highest fundamental frequency.*
2. *Radiated emissions measured in frequency above 1000MHz were made with an instrument using peak/average detector mode.*
3. *Average test would be performed if the peak result were greater than the average limit or as required by the applicant.*
4. *Data of measurement within this frequency range shown “ --- ” in the table above means the reading of emissions are attenuated more than 20dB below the permissible limits or the field strength is too small to be measured.*
5. *Measurements above show only up to 6 maximum emissions noted, or would be lesser, with “ N/A ” remark, if no specific emissions from the EUT are recorded (ie: margin>20dB from the applicable limit) and considered that's already beyond the background noise floor.*
6. *Margin (dB) = Remark result (dBuV/m) – Average limit (dBuV/m).*

**Operation Mode:** GFSK / TX / CH High  
**Temperature:** 27°C  
**Humidity:** 53 % RH

**Test Date:** May 27, 2015  
**Tested by:** Dennis Li  
**Polarity:** Ver. / Hor.

Frequency (MHz)	Reading (dBuV)	Correction (dB/m)	Result (dBuV/m)	Limit (dBuV/m)	Margin (dB)	Remark	Ant.Pol. (H/V)
1388.000	52.90	-6.10	46.80	74.00	-27.20	peak	V
4120.000	40.57	5.60	46.17	74.00	-27.83	peak	V
5365.000	39.60	9.89	49.49	74.00	-24.51	peak	V
N/A							
1654.000	50.12	-4.57	45.55	74.00	-28.45	peak	H
3710.000	41.83	3.87	45.70	74.00	-28.30	peak	H
4575.000	40.81	7.45	48.26	74.00	-25.74	peak	H
N/A							

**Remark:**

1. *Measuring frequencies from 1 GHz to the 10th harmonic of highest fundamental frequency.*
2. *Radiated emissions measured in frequency above 1000MHz were made with an instrument using peak/average detector mode.*
3. *Average test would be performed if the peak result were greater than the average limit or as required by the applicant.*
4. *Data of measurement within this frequency range shown “ --- ” in the table above means the reading of emissions are attenuated more than 20dB below the permissible limits or the field strength is too small to be measured.*
5. *Measurements above show only up to 6 maximum emissions noted, or would be lesser, with “ N/A ” remark, if no specific emissions from the EUT are recorded (ie: margin>20dB from the applicable limit) and considered that's already beyond the background noise floor.*
6. *Margin (dB) = Remark result (dBuV/m) – Average limit (dBuV/m).*

## 7.7 POWERLINE CONDUCTED EMISSIONS

### LIMIT

According to §15.207(a), except as shown in paragraphs (b) and (c) of this section, for an intentional radiator that is designed to be connected to the public utility (AC) power line, the radio frequency voltage that is conducted back onto the AC power line on any frequency or frequencies within the band 150 kHz to 30 MHz shall not exceed the limits in the following table, as measured using a 50  $\mu$ H/50 ohms line impedance stabilization network (LISN). Compliance with the provisions of this paragraph shall be based on the measurement of the radio frequency voltage between each power line and ground at the power terminal. The lower limit applies at the boundary between the frequency ranges.

Frequency Range (MHz)	Limits (dB $\mu$ V)	
	Quasi-peak	Average
0.15 to 0.50	66 to 56*	56 to 46*
0.50 to 5	56	46
5 to 30	60	50

### Test Configuration

See test photographs attached in Appendix II for the actual connections between EUT and support equipment.

### TEST PROCEDURE

1. The EUT was placed on a table, which is 0.8m above ground plane.
2. Maximum procedure was performed on the six highest emissions to ensure EUT compliance.
3. Repeat above procedures until all frequency measured were complete.

### TEST RESULTS

The initial step in collecting conducted data is a spectrum analyzer peak scan of the measurement range. Significant peaks are then marked as shown on the following data page, and these signals are then quasi-peaked.

### Test Data

*Not applicable, because EUT does not connect to AC Main Source direct.*