



## Installation Instructions



A14551

**NOTE:** Read the entire instruction manual before starting the installation.



# TABLE OF CONTENTS

	PAGE
<b>SAFETY CONSIDERATIONS</b> .....	<b>1</b>
<b>INTRODUCTION</b> .....	<b>2</b>
<b>INSTALLATION CONSIDERATIONS</b> .....	<b>2</b>
<b>INSTALLATION</b> .....	<b>3</b>
Step 1. Power Off System .....	9
Step 2. Remove Existing Thermostat .....	10
Step 3. Attach Backplate to Wall .....	11
Step 4. Connect the Wiring .....	14
Step 5. Power On System .....	16
<b>FEATURES</b> .....	<b>17</b>
<b>TROUBLESHOOTING</b> .....	<b>17</b>
<b>WIRING DIAGRAMS</b> .....	<b>18</b>

## SAFETY CONSIDERATIONS

Read and follow manufacturer instructions carefully. Follow all local electrical codes during installation. All wiring must conform to local and national electrical codes. Improper wiring or installation may damage thermostat. Recognize safety information. This is the safety--alert symbol. When you see this symbol on the equipment and in the instruction manual, be alert to the potential for personal injury. Understand the signal words **DANGER**, **WARNING**, and **CAUTION**. These words are used with the safety--alert symbol. **DANGER** identifies the most serious hazards which will result in severe personal injury or death. **WARNING** signifies a hazard which could result in personal injury or death. **CAUTION** is used to identify unsafe practices which may result in minor personal injury or product and property damage. **NOTE** is used to highlight suggestions which will result in enhanced installation, reliability, or operation.

## INTRODUCTION

The Bryant® Housewise™ thermostat is a wall-mounted, low-voltage thermostat which maintains room temperature by controlling the operation of a heating and/or air conditioning system, both heat pump and air conditioner models. Your Housewise thermostat has a color touch screen and interface similar to that used in smart phones. A variety of features are provided including remote access through web and mobile apps, separate heating and cooling setpoints, auto changeover, keypad lockout, backlighting, and built-in installer test. Programming features allow each day to be independently programmed in half an hour increments with four preset periods (Home, Away, Sleep, Wake) and up to six additional custom profile periods. For operational details, consult the online Owner's Manual for the specifics at [www.Bryant.com](http://www.Bryant.com).

## INSTALLATION CONSIDERATIONS

### Power

This thermostat is powered by 24VAC through the C terminal and thus most applications require a minimum of 5 thermostat wires. Provision is made for separate heating and cooling transformers via separable Rc and Rh terminals which are internally jumpered unless both Rc and Rh are utilized. Internal jumper is controlled by a relay after the thermostat senses whether Rc and/or Rh wires are connected to the terminal block.

# INSTALLATION

## Installation Notes:

- The maximum wire size to be used in the installation is 22AWG (0.50mm<sup>2</sup>) with 0.8mm insulation
- No part of the control should be installed directly outdoors or in a cabinet outdoors
- The control assembly base should be mounted before wires are attached

## Thermostat location:

- Approximately 5 ft. (1.5m) from floor.
- Close to or in a frequently used room, preferably on an inside partitioning wall.
- On a section of wall without pipes or duct work.

## Thermostat should NOT be mounted:

- Close to a window, on an outside wall, or next to a door leading to the outside.
- Exposed to direct light or heat from the sun, a lamp, fireplace, or near other temperature-radiating objects which could cause a false reading.

- Close to or in direct airflow from supply registers and return-air registers.
- In areas with poor air circulation, such as behind a door or in an alcove.

### **Compatible Systems**

Your Bryant Housewise thermostat works with most centralized residential heating and cooling systems.

Heating: up to 2 stages

Cooling: up to 2 stages

Heat pumps: 1 or 2 stages + 1 or 2 stages auxiliary heat (Intelligent heat staging capable)

Gas, oil, electric

Hybrid Heat® Dual Fuel systems

Geothermal systems

Accessories: Humidifier, dehumidifier, or ventilator

## Terminal Descriptions

G	Fan
Rc	Cool transformer
Rh	Heat transformer
O/B	Heat pump reversing valve
Y/Y1	Used for first stage of conventional A/C or first stage of heat pump compressor
Y2	Used for second stage of conventional A/C or second stage of heat pump compressor
W	W1, W2: Used for 1 - 2 stages of conventional heat or 1 - 2 stages of electric auxiliary heat (3 stages - Intelligent heat staging configuration)
C	24VAC common
ACC	Accessory (+/-): Used for dehumidifiers, humidifiers, ventilators, HRVs or ERVs

This thermostat is designed for 24VAC with a 2A maximum current. Do not connect it to line (high) voltage or millivolt systems.



**Items Included In Box**

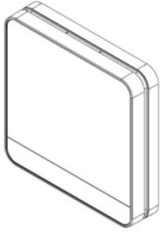

**Fig. 1 - Bryant Housewise® Thermostat**

A14494

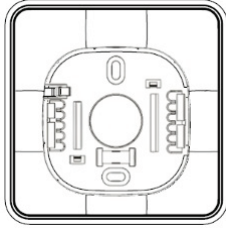
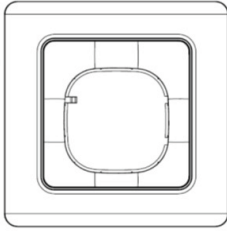

**Fig. 2 - Small Backplate**

A14495

**NOTE:** The Mounting Plate (center) is removable for both backplates.

**Items Included In Box (Cont.)**



**Fig. 3 - Large Backplate**

A14496

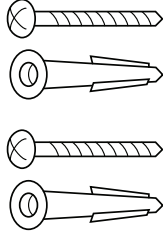

**Fig. 4 - Screws and Anchors**

A14497

## Items Included In Box (Cont.)

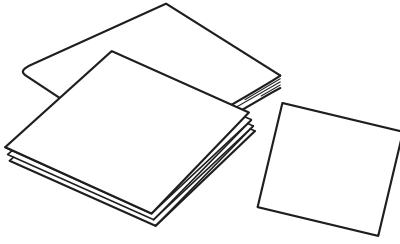

A14498

**Fig. 5 - Installation Instruction, Quick Start Guide, and Wire Labels**

## Items You Will Need

- A. Phillips screwdriver
- B. Drill for drilling holes for the mounting anchors with a 3/16" drill bit.

## Before You Start

Review the all the instructions before you start to ensure that there are no surprises during installation.

## Step 1. Power Off the HVAC System



### **WARNING**

#### **ELECTRICAL OPERATION HAZARD**

Failure to follow this warning could result in injury or death.

Before installing thermostat, turn off all power to equipment.  
There may be more than one power disconnect.

Power off the HVAC system either by a switch at the indoor furnace or fan coil or at the circuit breaker box.

Verify that the equipment is off by attempting to adjust the temperature with the existing thermostat. The thermostat may show the temperature change but your cooling or heating should not come on.

## Step 2. Remove Existing Thermostat

Remove the cover from your old thermostat. Most snap off easily but some may be attached by screws.

**Note:** If the old thermostat has 110/120V wires connected to the thermostat, it is a high voltage system and is not compatible with this thermostat.

Look at the wires coming out of the wall. Using the old thermostat base as a guide, use provided labels to label each wire coming out of the wall (See Fig. 6).

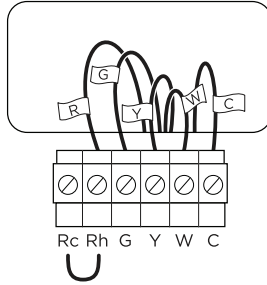

**Fig. 6 - Label Thermostat Wire**

A14499

Discard any jumper wires between Rh, Rc, or R. This thermostat does not need them. They are jumpered internally.

When done, remove the old thermostat base by unscrewing it from the wall. Be careful not to let any wires fall back into the wall.

Discard or recycle old thermostat.



## CAUTION

### ENVIRONMENTAL HAZARD

Failure to follow this caution may result in environmental damage.

Mercury is a hazardous waste. Federal regulations require that mercury be disposed of properly.

### Step 3. Attach Backplate to Wall

Position the backplate, ensuring that it is straight by checking the bubble on the built-in level. Mark the mounting holes on the wall with a pencil.

**Installing the optional large backplate**

If the small backplate doesn't cover the marks left by the previous thermostat, attach the larger backplate instead.

Remove the center piece from the small backplate by gently pushing the snap and pulling toward you.

Insert the center piece into the large backplate, using the tabs on the right as a guide. It will snap into place when correctly inserted.

**Secure the backplate**

Drill mounting holes on the pencil marks with a 3/16" drill bit.

Insert the plastic drywall anchors into the wall.

Use the screws provided to secure the backplate to the wall. (See Fig. 7)

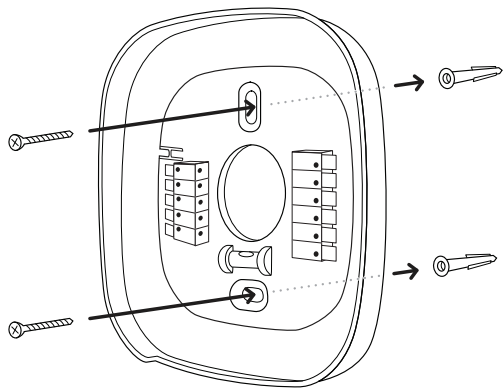

**Fig. 7 - Secure Backplate to Wall**

A14500



#### **Step 4. Connect the Wiring**

The wires from the wall should plug easily into the terminal blocks. Adjust length and routing of each wire to reach proper terminal and connector block on mounting base with 1/4-in. (6 mm) of extra wire. Strip only 1/4 in. of insulation from each wire to prevent adjacent wires from shorting together when connected. Only one wire can fit into each terminal block location. Do not try to force two wires into a terminal block location, it might damage the terminal block or not fully engage the wires.

When installed correctly, the release lever of the terminal block will lower to indicate engagement. To release a wire, press down on the lever. (See Fig. 8)

Match and connect equipment wires to proper terminals of the connector blocks. If there are separate 24VAC transformers, one in the indoor unit and one in the outdoor unit, connect the common to the respective C terminals. Connect the R from the indoor unit to the Rh terminal. Connect the R from the outdoor unit to the Rc terminal. Then the W signal is taken from the Rh power and the Y/Y1, Y2, G and O/B signals are taken from the Rc power.

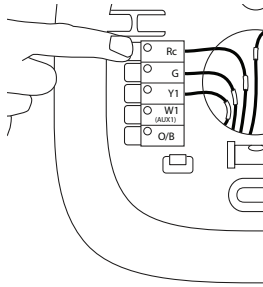

A14501

**Fig. 8 - Terminal Block Release Lever**



## **WARNING**

### **ELECTRICAL OPERATION HAZARD**

Failure to follow this warning could result in injury or death.  
Before installing thermostat, turn off all power to equipment.  
There may be more than one power disconnect.

If you need help with the wiring, refer to the wiring diagrams at the back of this guide.

System wiring diagrams covered are:

- Conventional heating and cooling systems
- Heat pumps (air or geothermal)
- Boilers or radiant heat systems
- Accessory devices: dehumidifiers, humidifiers, or ventilators

### **Attach thermostat**

Push any excess wires back into the wall, and connect the thermostat to the backplate.

### **Step 5. Power On the HVAC System**

Power back on the HVAC equipment. The thermostat will automatically power on. It is recommended to have the homeowner's Wi-Fi password handy in order to complete setup.

Follow the on-screen instructions. The thermostat software will guide you through the setup, which includes:

- Equipment configuration (HVAC and accessories)
- Setting preferences
- Connecting to Wi-Fi
- Registering the thermostat to the online web portal

**NOTE:** The settings can be changed at any time from the menus.

**Congratulations, you're done!**

## TROUBLESHOOTING

If your thermostat does not power on, please check the following:

1. Check that all wires are properly inserted into the terminal blocks at the thermostat. Tug lightly on the wires to ensure they are not loose.
2. Ensure you turned the power back on to the equipment either the switch at the indoor equipment or the electrical panel (where you originally turned off the equipment).
3. If your device still doesn't power on check the AC voltage between Rc and C or Rh and C and ensure it is 24V AC.

## FEATURES

The Bryant Housewise thermostat has a touch screen and interface similar to that used in smart phones.

### Accessing your web portal

Register the Bryant Housewise thermostat at [www.Bryant.com/myhome](http://www.Bryant.com/myhome) to control it from your smartphone, tablet or desktop, and to access free online energy management tools.

### Downloading the app

Control the thermostat from your smart phone. The thermostat supports both iOS and Android devices. Find the app at [www.Bryant.com/myhome](http://www.Bryant.com/myhome).

## WIRING DIAGRAMS

The following pages provide wiring diagrams for common HVAC equipment configurations.

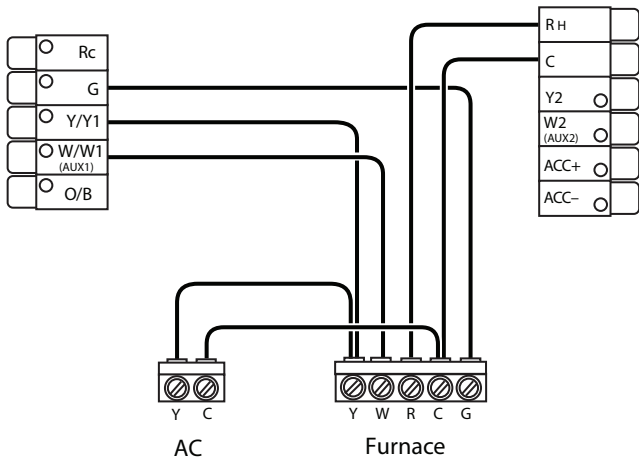

Single Stage Cooling and Heating System

A14502

Fig. 9 - Air Conditioner- Single Stage (Heat / Cool)

# WIRING DIAGRAMS (Cont.)

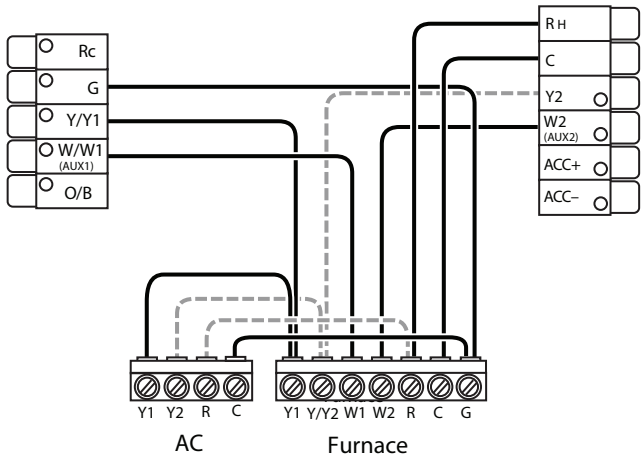

Two Stage Cooling and/or Heating System

A14502B

**Fig. 10 - Air Conditioner- Two Stages each (Heat / Cool)**

## WIRING DIAGRAMS (Cont.)

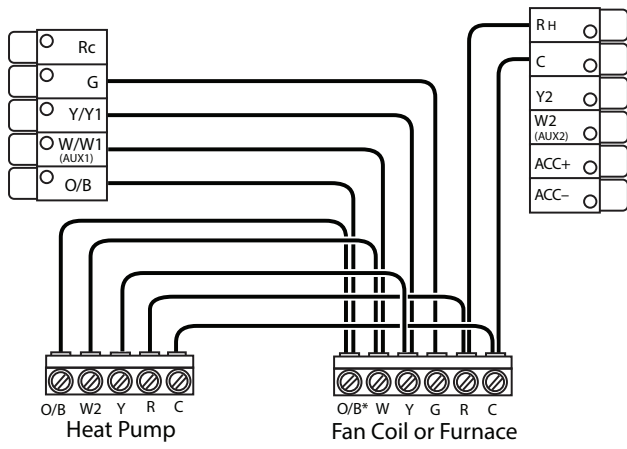

Single Stage Heat Pump and Auxiliary Heat

\* Connect to O/B terminal on furnace or fan coil, if available

A14503

**Fig. 11 - Heat Pump (Air or Geothermal) With Auxiliary Heat-  
Single Stage**

## WIRING DIAGRAMS (Cont.)

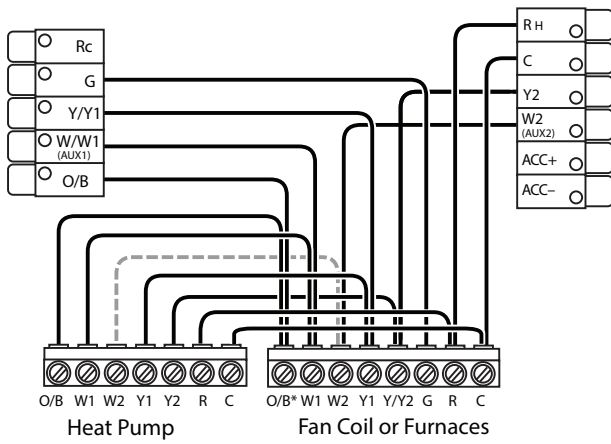

Stage 2 Heat Pump and Auxiliary Heat

\* Connect to O/B terminal on furnace or fan coil, if available

A14503B

**Fig. 12 - Heat Pump (Air or Geothermal) With Auxiliary Heat-  
Two Stages**



## WIRING DIAGRAMS (Cont.)

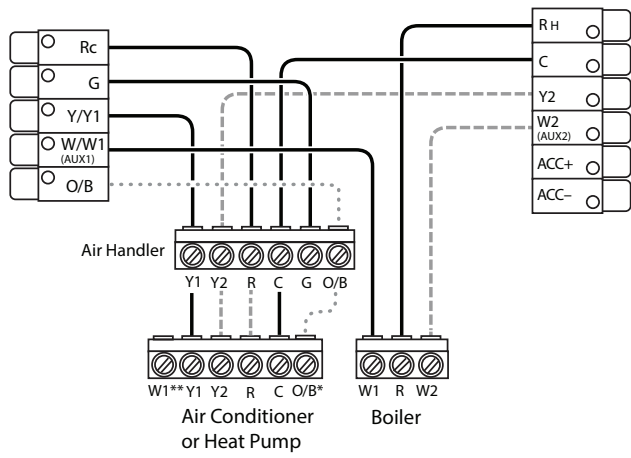

Stage 2 Heat and Cool (If Applicable)

\*Reversing Valve for Heat Pumps Only

\*\*Do not connect W1 at HP (set enabled w/ defrost)

A14504

**Fig. 13 - Boiler or Radiant System With Fan Coil  
and Conventional Cooling or Heat Pump**

## WIRING DIAGRAMS (Cont.)

### Accessory Devices

The thermostat can control an accessory HVAC device like a humidifier, dehumidifier, or ventilation device from its dry contact ACC terminals (The ACC terminals do not provide 24V AC output).

If the accessory is internally powered, connect the 24V to ACC+. Also connect the common for the accessory to common on the control board.

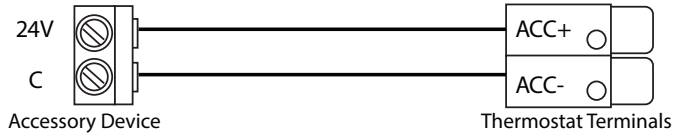

*Only needed if your accessory device is self-powered.*

Note: You will need to configure the accessory device when you first power on your thermostat.

A14505

**Fig. 14 - Accessory Device Connection**

## **Approvals**

This product was designed and built in accordance to RoHS directive 2002/95/EC and contains no hazardous substances as defined by this directive.

### **FCC Compliance Commission (FCC)**

#### **Compliance Statement:**

This equipment has been tested and found to comply with the limits for a Class B digital device, pursuant to part 15 of the FCC Rules. These limits are designed to provide reasonable protection against harmful interference in a residential installation. This equipment generates, uses and can radiate radio frequency energy and, if not installed and used in accordance with the instructions, may cause harmful interference to radio communications. However, there is no guarantee that interference will not occur in a particular installation. If this equipment does cause harmful interference to radio or television reception, which can be determined by turning the equipment off and on, the user is encouraged to try to correct the interference by one or more of the following measures:

- Reorient or relocate the receiving antenna.
- Increase the separation between the equipment and receiver.

- Connect the equipment into an outlet on a circuit different from that to which the receiver is connected.
- Consult the dealer or an experienced radio/TV technician for help. This device complies with part 15 of FCC rules. Operation is subject to the following two conditions:
  1. This device may not cause harmful interference.
  2. This device must accept any interference received, including interference that may cause undesired operation.

Change or modifications that are not expressly approved by the manufacturer could void the user's authority to operate the equipment.

#### RF Exposure Information

This equipment complies with FCC radiation exposure limits set forth for an uncontrolled environment. In order to avoid the possibility of exceeding the FCC radio frequency exposure limits, human proximity to the antenna shall not be less than 20cm during normal operation.

#### **Industry Canada (IC)**

##### **Compliance Notice:**

This device complies with Industry Canada license-exempt RSS standard(s). Operation is subject to the following two conditions:

1. this device may not cause interference, and

2. this device must accept any interference, including interference that may cause undesired operation of the device.

Le présent appareil est conforme aux CNR d'Industrie Canada applicable aux appareils radio exempts de licence. L'exploitation est autorisée aux deux conditions suivantes:

1. l'appareil ne doit pas produire de brouillage, et
2. l'utilisateur de l'appareil doit accepter tout brouillage radioélectrique subi, même si le brouillage est susceptible d'en compromettre le fonctionnement.

This Class B digital apparatus complies with Canadian ICES-003.

Cet appareil numérique de la classe B est conforme à la norme NMB-003 du Canada.

## **Industry Canada (IC)**

### **Radiation Exposure Statement:**

This equipment complies with IC RSS-102 radiation exposure limits set forth for an uncontrolled environment. This equipment should be installed and operated with minimum distance 20cm between the radiator & your body.





www.Bryant.com/myhome • 1-800-428-4326

©2014 Bryant Heating & Cooling Systems 7310 W. Morris St. Indianapolis, IN 46231  
Edition Date: 10/14

**Catalog No: IIT6-WEM-02**

**Manufacturer reserves the right to change, at any time, specifications  
and designs without notice and without obligations.**

Replaces: IIT6-WEM-01