

www.DaikinENVi.com

Daikin North America LLC.
5151 San Felipe Dr, Suite 500
Houston, TX 77056 USA

DACA-TS1-1



Daikin ENVi Thermostat Installation Manual

SAFETY CONSIDERATIONS

Read these SAFETY CONSIDERATIONS for Installation carefully before installing the Daikin ENVi thermostat kit. After completing the installation, make sure that the unit operates properly.

- Instruct the customer on how to operate and maintain the thermostat. Inform customers that they should store this Installation Manual with the Operation Manual for future reference.
- Always use a licensed installer or contractor to install this product. Improper installation can result in electric shock or fire.
- All electrical work must be carried out in accordance with local, state and national regulations.
- Safely dispose all packing materials in accordance with federal/state/local laws or ordinances.
- Only qualified personnel must carry out the installation work. Installation must be done in accordance with this installation manual. Improper installation may result in electric shock or fire.
- Use only specified accessories and parts for installation work. Failure to use specified parts may result in electric shock, fire or the unit failing.
- Make sure that all wiring is secured, that specified wires are used, and that no external forces act on the terminal connections or wires. Improper connections or installation may result in fire.
- Before touching electrical parts, turn off the unit.
- Do not touch the thermostat with wet fingers. Touching the thermostat with wet fingers can cause electric shock.
- Do not allow children to play with the unit to prevent injury.
- Do not install the thermostat in the following locations:
 - Where a mineral oil mist or oil spray or vapor is produced, for example, in a kitchen.
 - Where corrosive gas such as sulfurous acid gas is produced.
 - Near machinery emitting electromagnetic waves. Electromagnetic waves may disturb the operation of the control system and cause the unit to malfunction.
- Disposal of the unit must be done in accordance with the relevant local, state and national regulations.

CONTENTS

GETTING STARTED	1
Welcome	1
Contractor Thermostat Registration	1
Package Contents	2
Before You Begin	3
Daikin System Compatibility	4
Specifications	5
Wiring Requirements	6
INSTALLING THE THERMOSTAT KIT	6
Step 1. Power Off the Daikin Indoor Unit	6
Step 2. Position and Wire the DPCA	7
Step 3. Install the Daikin ENVi Thermostat	9
Step 4. Connect the Thermostat Wiring	11
Step 5. Mount the DPCA	12
Step 6. Power On Daikin Indoor Unit	12
NAVIGATING THE MENUS	13
Using the Navigation Buttons	13
CONFIGURING THE DAIKIN ENVi THERMOSTAT	15
Preferences	15
Installation Settings	16
Reset Equipment or User Settings	21
Rebooting the Daikin ENVi thermostat	22
Sensors	22
CONFIGURING REMINDERS AND ALERTS	23
List of Alerts	25
ONE-YEAR LIMITED WARRANTY	26
Approvals	27
FCC Compliance Statement	28
IC Statement	29

GETTING STARTED

Welcome

The Daikin ENVi thermostat kit has been designed to ensure the installation process is simple and efficient. This step-by-step Installation Manual will walk you through all aspects of the installation.

To ensure an on-going service relationship with your customers, please register all of your Daikin ENVi thermostats in your Contractor Portal.

Contractor Thermostat Registration

Use the serial number sticker (included in package) for Contractor Portal registration.

Package Contents

The Daikin ENVi thermostat kit includes the following items.



ENVi Thermostat

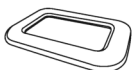

Trim Plate



DPCA with Power Cable



Wiring Harness



Double-Sided Adhesive



Screws (4) and
Drywall Anchors (4)



Installation and User
Manuals



Serial Number
Sticker



Wire Ties (2)

Daikin ENVi Thermostat Kit Contents

Before You Begin

This product is intended to be installed by trained service professionals.

This manual explains the procedures for installing the Daikin ENVi thermostat. Please read it carefully before beginning the installation.

For information on how to operate the Daikin ENVi thermostat, please see the Daikin ENVi User Manual.

The Daikin ENVi thermostat is designed to be mounted on the homeowner's wall in a convenient location.

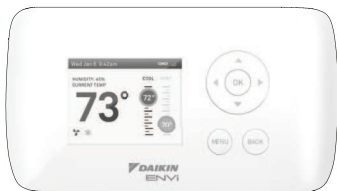

Caution: Disconnect electric power to the Daikin Indoor Unit before installing this product. Failure to do so could result in electric shock and/or equipment damage.

All wiring must conform to your local electrical code.

Mercury Notice: This product does not contain mercury. If you are replacing a product that does contain mercury, contact your local waste-management authority for disposal instructions. Do not discard the old product in the regular trash.

Daikin System Compatibility

The Daikin ENVi thermostat is designed to operate only with the Daikin Heat Pump and Cooling Indoor Units where the BRC944 wired remote controller is applicable.

The Daikin ENVi thermostat supports the following systems:

- Single-Split system
- Multi-Split system (2 to 8 ports)
- SkyAir FTXS Indoor Units

Applicable indoor unit models:

FTK, FTKN, FTKS, FTXG, FTX, FTXS, FTXN (09/12 K(E)VJU requires KRP980B1 interface adapter), CTXS, FDXS, CDXS and FVXS. Models numbers ending in NMVJU will require an interface adapter (KRP067A41 or KRP980B2). Please consult the Daikin indoor unit installation manual for the appropriate adapter use.

The Daikin ENVi thermostat can also support a single-stage auxiliary heater.



Any auxiliary heater that requires air flow from the Indoor Unit should be equipped with an air flow switch for safety. The indoor unit fan could stop during the defrost cycle and other situations.

Specifications

Thermostat Specifications

Temperature

Heat Set Point Range	45 to 80 °F (7 to 26.5 °C)
Cool Set Point Range	65 to 95 °F (18.5 to 35 °C)
Display Range	40 to 100 °F (5 to 37 °C)
Sensitivity	+/- 1 °F (0.5 °C)
Operating Range	32 to 130 °F (0 to 55 °C)

Humidity

Display Range	20 to 90% R.H.
Sensitivity	+/- 5% R.H.
Operating Range	5 to 95% R.H. (non-condensing)

Auxiliary Heater Relay

Electric Rating	30VAC, Max Current 3A
-----------------	-----------------------

Dimensions

Width x Height x Depth	5.5 x 3.25 x 1 inches (139.5 x 82.5 x 25 mm)
------------------------	---

Power

24 VAC (3VA maximum) (provided from the DPCA)

DPCA Specifications

Temperature

Operating Range	20 to 140 °F (-7 to 60 °C)
-----------------	----------------------------

Humidity

Operating Range	5 to 95% R.H. (non-condensing)
-----------------	-----------------------------------

Dimensions

Width x Height x Depth	4.7 x 2.0 x 1.3 inches (120 x 50 x 32.5 mm)
------------------------	--

Power

208/230 VAC (provided from Indoor Unit)

Wiring Requirements

The Daikin ENVi thermostat uses 4-wire low-voltage cable to connect to the Daikin Power and Communication Adapter (DPCA) which in turn connects to the Indoor Unit.

The maximum wire length between the Daikin ENVi thermostat and the DPCA is as follows:

- **18 AWG:** 1250 ft/380 m
- **20 AWG:** 800 ft/240 m
- **22 AWG:** 500 ft/150 m

INSTALLING THE THERMOSTAT KIT

There are 5 steps to install the Daikin ENVi thermostat kit:

Step 1. Power Off the Daikin Indoor Unit

Step 2. Position and Wire the DPCA

Step 3. Install the Daikin ENVi thermostat

Step 4. Connect the Thermostat Wiring

Step 5. Mount the DPCA

Step 6. Power On Daikin Indoor Unit

Step 1. Power Off the Daikin Indoor Unit

Before installing the Daikin ENVi thermostat kit, disconnect the power to the Indoor Unit.



WARNING: *The Indoor Unit uses a high-voltage 208/230V power source. Always DISCONNECT power to the Indoor Unit before connecting any power wires. Failure to do can result in death, fire, or electrical shock*

Step 2. Position and Wire the DPCA

The Daikin Power and Communication Adapter (DPCA) provides an interface between the thermostat and Indoor Unit.

To install the DPCA:

1. Position the DPCA in a suitable location, away from water and near the Indoor Unit (for example, a backside cavity of a wall-mounted unit). The DPCA is not plenum rated and should be mounted in a non-plenum space.
2. Connect the DPCA power cable to the Indoor Unit power supply terminals. Ensure that the electrical connections are securely tightened.
3. Remove the DPCA cover by grasping both sides and pulling along the length of the DPCA.
4. Use the Wiring Harness to connect the P2 terminal on the DPCA to the S21 terminal on the Indoor Unit's main PCB. Refer to the Daikin system installation manual for information about accessing the S21 terminal.

Power Cable

Power cable to terminal block on Indoor Unit

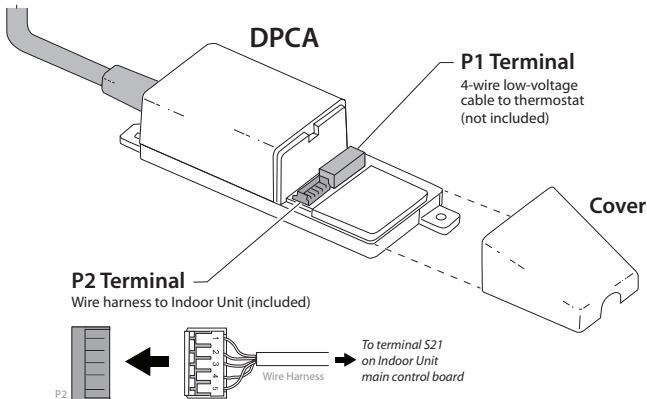
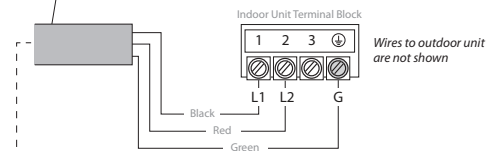

DPCA Wiring Connectors

Step 3. Install the Daikin ENVi Thermostat

The ideal location for the thermostat is approximately 5 ft (1.5 m) above floor level in the main living area.

Do not install the thermostat:

- Close to sources of heat such as incandescent lights
- Near supply heating/cooling sources
- In direct sunlight
- On exterior, non-insulated or poorly insulated walls
- In the kitchen or other areas of potentially high heat and/or humidity
- In an area that could restrict air flow

To install the thermostat:

1. If necessary, remove the previous thermostat.
1. Gently separate the backplate from the Daikin ENVi thermostat.
2. Place the thermostat backplate on the wall. Make sure that any existing wires can be inserted through the opening for the wiring.

If the backplate does not adequately cover the area where the previous thermostat was installed, attach the trim plate to the back of the backplate to increase its coverage.
3. Using the backplate as a template, mark the location of the mounting holes on the wall as shown.

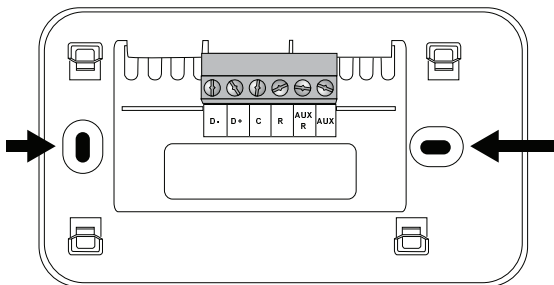

The solid color indicates mounting holes

4. Move the backplate out of the way and make holes where indicated in the previous step. The mounting holes can accommodate a #6 pan-head screw. It is recommended to use the included fasteners to ensure proper fitting of the front housing.
5. Use the included drywall plugs (or other suitable anchors) to ensure the thermostat can be mounted securely to the wall.
6. Fasten the backplate and optional trim plate to the wall using the screws provided (or other suitable screws).

Step 4. Connect the Thermostat Wiring

Use the field-supplied 4-wire low-voltage cable to connect the thermostat to the DPCA.

To connect the thermostat to the DPCA:

1. Connect the wires as shown:

P1 Terminal on DPCA

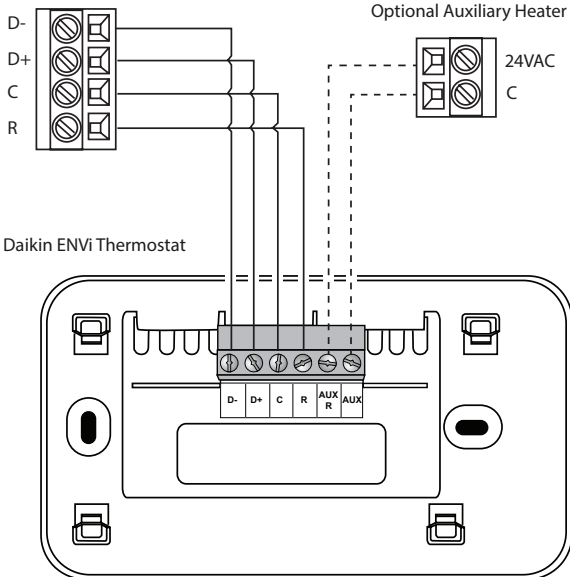

2. Attach the Daikin ENVi thermostat to the backplate. Ensure that the pins on the thermostat align with the terminal block on the backplate.

Step 5. Mount the DPCA

After you make the necessary wiring connections, mount the DPCA by using the adhesive sticker or mounting screws as needed.

Step 6. Power On Daikin Indoor Unit

After you've completed the wiring, you can apply power to the Daikin Indoor Unit. The Daikin ENVi thermostat receives power from the equipment and will automatically power on.

After you power on the Indoor Unit:

1. Verify the green LED on the DPCA has turned on. Upon verification, re-attach the DPCA cover.
2. Use the wire ties to secure the wires as needed.

NAVIGATING THE MENUS

The Daikin ENVi thermostat has an easy-to-read color screen that displays all the information you need to configure the thermostat. Use the navigation buttons on the right to quickly change the temperature, access features, and configure settings.

Using the Navigation Buttons



The navigation buttons let you select options and control the Daikin ENVi thermostat.

- **▲ (up)** On the Home screen, press ▲ to increase the temperature set point by 1°F (0.5°C). For menus, press ▲ to move up.
- **▼ (down)** On the Home screen, press ▼ to decrease the temperature set point by 1°F (0.5°C). For menus, press ▼ to move down.
- **◀ (left)** On the Home screen, if Auto mode is enabled, press ◀ to switch between heat and cool set points. For menus, press ◀ to go back to the previous screen.
- **▶ (right)** On the Home screen, if Auto mode is enabled, press ▶ to switch between heat and cool set points. For menus, press ▶ to choose the currently highlighted option.
- **OK** On a menu screen, press OK to choose the currently highlighted option. If a configuration option is selected, pressing OK will keep its new value and return back to the previous screen.

- **MENU** Pressing **MENU** displays a list of all available options. If a menu is currently displayed, pressing **MENU** will cancel any unsaved changes and return to the Home screen.
- **BACK** On a menu screen, press **BACK** to go back to the previous screen.



On-Screen Keyboard

If you need to type in any information, an on-screen keyboard will appear. To enter a letter or number, move to the character by pressing the arrow keys and then press **OK** to select it.

Select **Caps** to enter capital letters; select **&@#** to enter commonly used symbols. If you make a mistake, press **X** to delete the text .

To keep your changes, select **Save**. To cancel your changes, press **BACK**.

CONFIGURING THE DAIKIN ENVi THERMOSTAT

The first step after installing the Daikin ENVi thermostat is to configure the thermostat settings for the Indoor Unit.

Preferences

This section describes the user preferences that should be configured during installation. For a complete description of all user preferences, see the Daikin ENVi User Manual.

Intelligent Eye

Some models of the Indoor Unit include an intelligent eye, an infrared sensor that detects room occupancy. It adjust the set point by 3.6°F (2°C) if no movement is detected in order to save energy (+3.6°F/+2°C if cooling, -3.6°F/-2°C if heating).

To use intelligent eye, you must enable this option in the Daikin ENVi thermostat and then enable it with the Daikin wireless remote controller. If enabled, the thermostat's Smart Recovery and Temp Alert functions are not available.

By default, intelligent eye is disabled on the thermostat.

Do NOT enable the intelligent eye with the Daikin wireless remote controller when it is disabled on the thermostat as this may cause suboptimal operation and result in invalid recovery and alert messages. Also, if an auxiliary heater is configured, enabling intelligent eye may energize the auxiliary heater more often than would normally be required.

To configure the intelligent eye:

From the Home screen, press **MENU**.

Select **Settings** ► **Preferences**.

Select **Intelligent Eye**.

Enable (**Yes**) or disable (**No**) the intelligent eye sensor.

Installation Settings

The Installation Settings let you configure the equipment connected to the Daikin ENVI thermostat.

Allow Auto Heat/Cool

Enabling this option allows the user to select auto change-over as a system mode.

Only visible if the Indoor Unit supports heat or an auxiliary heat source is configured.

Heat/Cool Min Delta

Sets the minimum difference between the heat mode set temperature and the cool mode set temperature when the system mode is in auto-changeover. The delta is adjustable from 2 to 10 °F (1.1 to 5.5 °C). The default value is 5 °F (2.8 °C).

Only visible if the Indoor Unit supports heat or an auxiliary heat source is configured.

System Settings

The System Settings let you configure general heat pump settings.

- **Min Cycle Off Time** Sets the minimum equipment off time between cycles: 240 to 900 seconds (default is 240 seconds).
- **Min Cycle On Time** Sets the minimum equipment run time in cool mode: 1 to 20 min (default is 3 min).
- **Min Outdoor Temp** Disables the compressor when the outside air temperature reaches the configured minimum setting. This performs two functions. It prevents the compressor from running when the outdoor temperature is too low, thus resulting in

To configure the system settings:

From the Home screen, press MENU.

Select **Settings** ► **Installation Settings**.

Configure the devices connected to the thermostat.

damage to the compressor. You can also set this value to determine when you want the auxiliary heat (if installed) to engage to help meet the set temperature. The temperature range is adjustable from -10 to 65 °F (-23.3 to 18.3 °C) or disabled by default.

This feature uses the Internet to obtain the current outdoor temperature. If no Internet is available, the Outdoor Unit's temperature sensor is used instead.

- **Cool Differential Temp** The minimum difference between the current temperature and set temperature before the system calls for cool. A smaller difference means shorter cycle times, whereas a larger difference results in longer cycle times. The temperature range is adjustable from 0.5 to 3 °F (0.3 to 1.7 °C) in 0.5°F (0.3°C) increments.
- **Cool Dissipation Time** The amount of time the fan will run after the cool has been turned off. Running the fan for a period of time allows for any cooled air left in the ducts to circulate throughout the home. The time is adjustable from 0 to 900 seconds (default is 0 seconds).
- **AC Overcool Max** When using the AC to dehumidify, the setting configures how many degrees below the current set point the thermostat will run in order to reach the dehumidify set point. Options are Disabled (default) and 0.5 to 3 °F (0.3 to 1.8°C) in 0.5 F (0.3°C) increments.
- **Heat Differential Temp** The minimum difference between the current temperature and set temperature before the system calls for heat. A smaller difference means shorter cycle times, whereas a larger difference results

in longer cycle times. The temperature range is adjustable from 0.5 to 3 °F (0.3 to 1.7 °C) in 0.5°F (0.3°C) increments. The default offset is 0.5°F (0.3°C).

If the Indoor Unit is AC only and an auxiliary heater is configured, this option appears under the Aux Heat Settings menu.

- **Heat Dissipation Time** The amount of time the fan will run after the heat set point has been reached and the call for heat has been turned off. Running the fan for a period of time allows for heated air to circulate throughout the home. The time is adjustable from 0 to 900 seconds (default is 0 seconds).

If the Indoor Unit is AC only and an auxiliary heater is configured, this option appears under the Aux Heat Settings menu.

- **Indoor Unit Temp Offset** Depending on its type, the Indoor Unit uses a temperature offset for the heating set point, taking into consideration the higher sensing temperature. The Daikin ENVi thermostat applies the offset to the set point which is sent to the Indoor Unit. The offset should be 3.5°F (2.0°C) for wall-mounted and ducted indoor units, and 0°F (0°C) for floor-standing indoor units (available in the future). The offset range is adjustable from 0°F (0°C) to 5.5 °F (3.0°C) in 0.5°F (0.3°C) increments to allow for future indoor unit expansions. The default offset is 3.5°F (2.0°C).
- **Heat Pump to Aux Temp Delta** The minimum difference between the current temperature and the set temperature that will activate Aux Heat (regardless if the maximum run time of the heat pump was

reached). Options are Auto (default) and 1 to 10 °F (0.6 to 5.6 °C).

Only visible if Indoor Unit supports heat and an auxiliary heat source is also configured.

- **Heat Pump to Aux Runtime** The maximum amount of time the heat pump will run before engaging Aux Heat. Options are Auto (default), Disabled, and 10 to 180 minutes.

Only visible if Indoor Unit supports heat and an auxiliary heat source is also configured.

Aux Heat Settings

The Aux Heat Settings configure an auxiliary heat source.

If you want to test the auxiliary heater during installation, set Aux Heat Installed to Yes and set Allow HP with Aux Heat to No. Then, adjust the heat set point to enable the auxiliary heater.

- **Aux Heat Installed** When set to Yes, configures the thermostat to control an auxiliary heat source.
- **Aux Heat Requires Fan** When set to Yes, configures the thermostat to control the fan when auxiliary heat is used.
- **Allow HP with Aux Heat** When set to Yes, it will turn on auxiliary heat in addition to the heat pump. For information about how auxiliary heat will be engaged with the heat pump, see the settings **Heat Pump to Aux Temp Delta** and **Heat Pump to Aux Runtime**.
- **Aux Min On Time** Sets the minimum equipment run time for auxiliary heat: 1 to 20 min (default is 5 min).
- **Max Outdoor Temp** Configures the maximum outdoor temperature threshold.

Above this level, the auxiliary heat will not be activated. The temperature is adjustable from 0 to 80 °F (-17.8 to 26.5 °C) in increments of 0.5°F (0.3°C). The default value is 70°F (21°C).

Fan Configuration

The Fan Configuration settings map the Indoor Unit's internal fan speeds to the fan speed options displayed to the user on the thermostat.

- **Heating Mode Speeds** Configures fan speed when the user selects High, Medium or Low while the system is in heat mode. The possible speeds for each value are High, Medium High, Medium, Medium Low, and Low.
- **Cooling Mode Speeds** Configures fan speed when the user selects High, Medium or Low while the system is in cool mode. The possible speeds for each value are High, Medium High, Medium, Medium Low, and Low.
- **Fan Only Mode Speeds** Configures fan speed when the user selects High, Medium or Low while the system is not actively cooling or heating the room. The possible speeds for each value are High, Medium High, Medium, Medium Low, and Low.
- **Aux Fan Min Speed** Configures minimum fan speed used when Aux Heat requires a fan. The possible speed is High, Medium High, Medium, Medium Low, or Low.

Force System Off

Force System Off is used to clear a latched system error status in the indoor unit by turning off the equipment for five seconds after system servicing. Operation will automatically resume with the previous settings once complete.

Tstat Temp Correction

Lets you program an offset between the real temperature at the thermostat and the displayed temperature. If you find that the temperature where the thermostat is located does not represent the room temperature, change the offset to compensate for the difference. The correct temperature is adjustable from +/- 10°F (+/-5 .6°C) in 0.5°F (0.3°C) increments.

Installer Code

To prevent accidental modifications to the installation settings, you can enable the following installer code: 3262. The code is fixed and cannot be changed.

Reset Equipment or User Settings

To reset the Daikin ENVi thermostat:

From the Home screen, press **MENU**.

Select **Settings** ► **Reset**.

Select the desired reset method.

You can restore equipment or user settings on the Daikin ENVi thermostat back to their factory defaults.

- **Reset Registration** Resets the connection between the Daikin ENVi thermostat and the user's personalized Web Portal.
- **Preferences and Schedule** Resets all preferences, reminders, alerts and programming back to the default state.
- **HVAC Equipment Settings** Resets the configuration of the Indoor Unit and/or auxiliary heat equipment.
- **All Settings** Resets the Daikin ENVi thermostat back to its default factory settings.

- **Reset Contractor Info** Resets any information about the Contractor who installed the Daikin ENVi thermostat.

Rebooting the Daikin ENVi thermostat

You can reboot the Daikin ENVi thermostat by pressing the physical hardware reset button, located through an opening in the bottom left corner of the Daikin ENVi thermostat. Rebooting will not alter programming or configuration options.

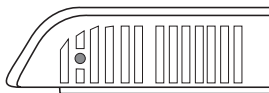

Reset button

Sensors

By default, the Daikin ENVi thermostat's Internal Sensor is used for an accurate indication of the room temperature (recommended setting).

The Indoor Unit is also equipped with a room temperature sensor which you can use instead. You can also enable both sensors to provide an average sensing temperature. However, the Indoor Unit sensor and averaging methods are not recommended because the Indoor Unit sensor, especially wall-mounted models, can be affected by certain operations such as starting up and defrosting in a short time which may cause improper control of the indoor unit by the ENVi Thermostat.

To select the temperature sensor:

From the Home screen, press **MENU**.

Select **Sensors** ►
Configure.

Enable or disable each sensor by selecting **Internal Sensor** or **Indoor Unit** and then selecting **Yes** or **No**.

CONFIGURING REMINDERS AND ALERTS

To configure Reminders and Alerts

From the Home screen, press **MENU**.

Select **Reminders and Alerts**.

Configure the Reminder and Alert settings as required.

The Daikin ENVi thermostat can generate periodic maintenance reminders that help the homeowner know when to perform periodic maintenance.

The thermostat can also generate alerts if the system detects an error or if the temperature in the home goes over or under a pre-programmed level (which protects the home from damage due to freezing and/or excessive heat).

Alerts are displayed on the screen. They include a description, error code (in the case of a system error), and optional technician contact information.

If the homeowner registers the thermostat, the alert will be emailed to them and be displayed in the web portal.

System Service

The system service (maintenance) reminder generates an alert telling the homeowner that regularly scheduled maintenance is required.

This reminder, along with technician contact information, can be displayed on the screen. If homeowners register their thermostats, the reminders will be emailed to them and be displayed in the web portal.

You can set the Last Service date, turn the Reminder On or Off, and to set the Frequency of the maintenance interval in months.

Low Temp Limit

Sets the temperature at which the thermostat will generate a Low Temperature Limit alert. The range can be:

- Disabled – No alert will be generated.
- Enabled – Set temperature range of 35 to 68 °F (1.5 to 20 °C).

High Temp Limit

Sets the temperature at which the thermostat will generate a High Temperature Limit alert. The range can be:

- Disabled – No alert will be generated.
- Enabled – Set temperature range of 60 to 104 °F (15.5 to 40 °C).

Display Alerts on Thermostat

Select No if you do not want any of the alerts to be displayed on the Daikin ENVi thermostat screen. Alerts will continue to be displayed on the web portal and sent via email.

Enable Heating/Cooling Alerts

Select No to disable alerts for heat/cool error conditions. If disabled, alerts indicating that the system failed to heat or cool will not be appear in the screen, web portal, or emails.

List of Alerts

Below is a complete list of alerts. Depending on your configuration, some of these may not apply.

Low Temp Limit	Temperature in the home is too low.
High Temp Limit	Temperature in the home is too high.
Heat Not Responding	The system has failed to heat the home.
Cool Not Responding	The system has failed to cool the home.
System Service	HVAC system due for regular maintenance.
Auxiliary Heat Run Time	Auxiliary heat source is running too often.
Auxiliary Outdoor Temperature	Your auxiliary heat has been called to run when the outdoor temperature exceeds the programmed set point.
System error, service required	<p>A system error occurred.</p> <p>If the Indoor Unit's status LED is blinking after the error has been corrected, select Settings ► Installation Settings ► Force System Off to reset the latched error status and turn off the blinking LED.</p>
Lost communication	<p>Communication with the Indoor Unit has been lost. Check the wiring connections between the DPCA, ENVi thermostat and Indoor Unit. The green LED on DPCA should be on and solid.</p> <p>Upon initial power up of the system communication, this alert may be generated. Wait up 10 minutes for system to initialized before troubleshooting. The alert will be removed automatically once communication has been established.</p>

ONE-YEAR LIMITED WARRANTY

Daikin North American LLC, (“Daikin”) warrants that for a period of one (1) year from the date of purchase by the end-user (“Customer”), the Daikin ENVi thermostat (the “Product”) shall be free of defects in materials and workmanship under normal use and service. During the limited warranty period, Daikin shall, at its option, repair or replace any defective Products, at no charge. Any replacement and/or repaired device are warranted for the remainder of the original limited warranty or ninety (90) days, whichever is longer.

NO LABOR WARRANTY

This limited warranty will apply with respect to parts only and not labor. Accordingly, subject to the conditions and limitations set forth herein, the limited warranty entitles the Customer to receive, at the option of Daikin only, a repaired or replacement part.

If the Product is defective, please call the third party contractor (“Installing Contractor”). After consulting with the Installing Contractor, Daikin will make the determination whether a replacement Product can be sent to you or whether the Product should be returned to the following address: Daikin North American LC., 5151 San Felipe Dr, Suite 500, Houston, TX 77056. In the event of a failure of a Product, Customer may:

- contact the Installing Contractor from whom the Product was purchased to obtain an equivalent replacement product, provided the Installing Contractor determines that the returned Product is defective and Customer is otherwise eligible to receive a replacement product

This limited warranty does not cover removal, freight or reinstallation costs and shall not apply if the damages were found to be caused by something other than defects in materials or workmanship. The limited warranty will be void and of no effect, and Daikin will have no liability to Customer or anyone, including without limitation, if the Product:

- was operated/stored in abnormal use or maintenance conditions not prescribed in the User Manual;
- is repaired, modified or altered by any source other than Daikin, its agents or a licensed Heating Ventilating and Air Conditioning (HVAC) contractor and Daikin expressly authorizes such repair;
- the Product was subjected to misuse, abuse, negligence, electrical fault, improper handling or improper or inadequate maintenance accident or acts of nature;
- the Product is not operated or maintained and serviced in compliance with the printed instructions and recommendations of Daikin;
- the serial number of the Product has been altered, defaced, or removed;
- the Product is mishandled by Customer or any third party;
- lightning, fluctuations in electrical power or acts of God have occurred;
- problems arise from normal wear and tear;
- the Product has not been purchased from an authorized Daikin distributor or sales representative (an “Authorized Seller”) or from a party or contractor who has purchased the Product from an Authorized Seller;
- was not installed by a licensed Heating Ventilating and Air Conditioning (HVAC) contractor or was installed improperly.

The limited warranty is for repair or replacement of parts or Product only. Except to that limited extent, Daikin will not under any circumstances be liable for any loss, cost, damage, or expense of any kind arising out of a breach of this limited warranty or otherwise. Without intending to limit the foregoing sentence, it is specifically provided as follows: DAIKIN SHALL NOT BE LIABLE FOR ANY INDIRECT, INCIDENTAL, CONSEQUENTIAL, EXEMPLARY, SPECIAL, OR PUNITIVE DAMAGES, OR FOR ANY LOSS OF REVENUE, PROFIT OR USE, ARISING OUT OF A BREACH OF THIS LIMITED WARRANTY (INCLUDING BUT NOT LIMITED TO DAMAGE RESULTING FROM MOLD OR OTHER CONTAMINATES) OR IN CONNECTION WITH THE SALE, MAINTENANCE, USE, OPERATION, SERVICING OR REPAIR OF ANY DAIKIN PRODUCT. IN NO EVENT WILL DAIKIN BE LIABLE FOR ANY AMOUNT GREATER THAN THE PURCHASE PRICE OF A DEFECTIVE PRODUCT.

THIS LIMITED WARRANTY IS THE SOLE AND EXCLUSIVE WARRANTY FOR DAIKIN PRODUCT, AND IS IN LIEU OF ALL OTHER WARRANTIES EXPRESS OR IMPLIED, IN LAW OR IN FACT. DAIKIN SPECIFICALLY DISCLAIMS ALL OTHER WARRANTIES EXPRESS OR IMPLIED, INCLUDING BUT NOT LIMITED TO ALL IMPLIED WARRANTIES OF MERCHANTABILITY AND OF FITNESS FOR A PARTICULAR USE OR PURPOSE OR OF NON-INFRINGEMENT, OR ANY IMPLIED WARRANTY ARISING OUT OF A COURSE OF DEALING OR OF PERFORMANCE OR USAGE OF TRADE. NO PERSON OR ENTITY IS AUTHORIZED TO BIND DAIKIN TO ANY OTHER WARRANTY, OBLIGATION OR LIABILITY FOR ANY DAIKIN PRODUCT. ACCEPTANCE, INSTALLATION, OPERATION OR USE OF THE DAIKIN PRODUCT FOR WHICH THIS WARRANTY IS ISSUED WILL CONSTITUTE ACCEPTANCE OF THE TERMS HEREOF.

SOME JURISDICTIONS MAY NOT ALLOW THE EXCLUSION OR LIMITATION OF INDIRECT, INCIDENTAL OR CONSEQUENTIAL DAMAGES, OR OF ANY EXPRESS OR IMPLIED WARRANTIES, SO TO SUCH EXTENT THE ABOVE EXCLUSIONS MAY NOT APPLY TO CERTAIN CUSTOMERS. THIS LIMITED WARRANTY PROVIDED BY DAIKIN GIVES CUSTOMERS SPECIFIC LEGAL RIGHTS, AND CUSTOMERS MAY ALSO HAVE OTHER RIGHTS WHICH VARY FROM JURISDICTION TO JURISDICTION. The disclaimers of liability included in this limited warranty shall remain in effect and shall continue to be enforceable in the event that any remedy herein shall fail of its essential purpose

No one is authorized by Daikin to modify this limited warranty in any respect or to create for Daikin any other obligation or liability in connection with the Product unless done so in a written agreement bearing the handwritten signature of the President of Daikin. Customer agrees that any purported change by Daikin shall be null and void unless the President of Daikin shall have expressly so agreed to such change.

This limited warranty gives you specific rights, and you may also have other rights which vary from jurisdiction to jurisdiction. If you have any questions regarding this limited warranty, please write Daikin North America LLC., 5151 San Felipe Dr, Suite 500, Houston TX 77056.

Approvals

This product was designed and built in accordance to RoHS directive 2002/95/EC and contains no hazardous substances as defined by this directive.

FCC Compliance Statement

Compliance notice:

This equipment has been tested and found to comply with the limits for a Class B digital device, pursuant to part 15 of the FCC Rules. These limits are designed to provide reasonable protection against harmful interference in a residential installation. This equipment generates, uses and can radiate radio frequency energy and, if not installed and used in accordance with the instructions, may cause harmful interference to radio communications. However, there is no guarantee that interference will not occur in a particular installation. If this equipment does cause harmful interference to radio or television reception, which can be determined by turning the equipment off and on, the user is encouraged to try to correct the interference by one or more of the following measures:

- Reorient or relocate the receiving antenna.
- Increase the separation between the equipment and receiver.
- Connect the equipment into an outlet on a circuit different from that to which the receiver is connected.
- Consult the dealer or an experienced radio/TV technician for help.

This device complies with part 15 of FCC rules. Operation is subject to the following two conditions:

1. This device may not cause harmful interference.
2. This device must accept any interference received, including interference that may cause undesired operation.

Change or modifications that are not expressly approved by the manufacturer could void the user's authority to operate the equipment.

RF Exposure Information

This equipment complies with FCC radiation exposure limits set forth for an uncontrolled environment. In order to avoid the possibility of exceeding the FCC radio frequency exposure limits, human proximity to the antenna shall not be less than 8 inches during normal operation.

Industry Canada (IC)

Compliance Notice:

This device complies with Industry Canada license-exempt RSS standard(s).

Operation is subject to the following two conditions:

1. This device may not cause interference, and
2. This device must accept any interference, including interference that may cause undesired operation of the device.

This Class B digital apparatus complies with Canadian ICES-003.

RF Exposure Statement:

This equipment complies with IC RSS-102 radiation exposure limits set forth for an uncontrolled environment. This transmitter must be installed to provide a separation distance of at least 20 cm from all persons and must not be collocated or operating in conjunction with any other antenna or transmitter.

FCC ID: WR9EBSTATSI01 IC: 7981A-EBSTATSI01

Warning: Changes or modifications not expressly approved by Daikin North America LLC. could void the user's authority to operate the equipment.

