



Canada

RF Test Report

As per

RSS-247 Issue 2:2017 & FCC Part 15 Subpart 15.247

Unlicensed Intentional Radiators
FHSS System

on the

ECB601/ECB501

Issued by:

TÜV SÜD Canada Inc.
11 Gordon Collins Dr,
Gormley, ON, L0H 1G0
Canada
Ph: (905) 883-7255

Testing produced for

ecobee

Prepared by:

Min Xie,
Sr. Project Engineer

See Appendix A for full client &
EUT details.

Reviewed by:

Amir Emami,
Project Engineer

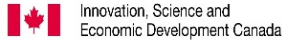

Registration #
6844A-3



Testing Laboratory
Certificate #2955.02



R-14023, G-20072
C-14498, T-20060



Registration #
CA6844



Client	Ecobee Inc.	
Product	ECB601/ECB501	
Standard(s)	RSS 247 Issue 2:2017 FCC Part 15 Subpart 15.247	

Table of Contents

Table of Contents	2
Report Scope	3
Summary	4
Test Results Summary	5
Notes, Justifications, or Deviations	6
Sample Calculation(s).....	7
Applicable Standards, Specifications and Methods.....	8
Document Revision Status	9
Definitions and Acronyms	10
Testing Facility	11
Calibrations and Accreditations.....	11
Testing Environmental Conditions and Dates	12
Detailed Test Results Section	13
Emission Bandwidth	14
Carrier Frequency Separation	19
Time of Occupancy.....	21
Maximum Conducted Output Power	25
Power Spectral Density.....	28
Antenna Spurious Conducted Emissions (20dBc).....	31
Transmitter Spurious Radiated Emissions	39
Power Line Conducted Emissions	50
Appendix A – EUT Summary.....	55
Appendix B – EUT and Test Setup Photos.....	58

Client	Ecobee Inc.	
Product	ECB601/ECB501	
Standard(s)	RSS 247 Issue 2:2017 FCC Part 15 Subpart 15.247	

Report Scope

This report addresses the EMC verification testing and test results of **Ecobee Inc's** Model: **ECB601/ECB501 (Sub-Gig Hybrid Transmitter)** and is herein referred to as EUT (Equipment Under Test). The EUT was tested for compliance against the following standards:

RSS-247 Issue 2:2017

FCC Part 15 Subpart C 15.247

Test procedures, results, justifications, and engineering considerations, if any, follow later in this report.

This report does not imply product endorsement by any government, accreditation agency, or TÜV SÜD Canada Inc.

Opinions or interpretations expressed in this report, if any, are outside the scope of TÜV SÜD Canada Inc. accreditations. Any opinions expressed do not necessarily reflect the opinions of TÜV SÜD Canada Inc., unless otherwise stated.

Client	Ecobee Inc.	
Product	ECB601/ECB501	
Standard(s)	RSS 247 Issue 2:2017 FCC Part 15 Subpart 15.247	

Summary

The results contained in this report relate only to the item(s) tested.

EUT:	ECB601/ECB501
FCC Certification #, FCC ID:	WR955470766937
ISED Certification #, IC:	7981A-55470766937
EUT passed all tests performed	Yes
Tests conducted by	Min Xie
Report reviewed by	Amir Emami

For testing dates, see "Testing Environmental Conditions and Dates".

Client	Ecobee Inc.	
Product	ECB601/ECB501	
Standard(s)	RSS 247 Issue 2:2017 FCC Part 15 Subpart 15.247	

Test Results Summary

Standard/Method	Description	Class/Limit	Result
FCC 15.203	Antenna Requirement	Unique	Pass See Justification
FCC 15.205 RSS-GEN (Table 6)	Restricted Bands for Intentional Operation	QuasiPeak Average	Pass
FCC 15.207 RSS-GEN (Table 3)	Power Line Conducted Emissions	QuasiPeak Average	Pass
FCC 15.209 RSS-GEN (Table 4)	Spurious Radiated Emissions	QuasiPeak Average	Pass
FCC 15.247(a)(1) RSS 247 5.1	Carrier Frequency Separation	> 25 kHz or 20 dB BW	Pass
FCC 15.247(a)(1)(i) RSS 247 5.1	Number of Hopping Frequencies	N/A	N/A, See Justification
FCC 15.247(b)(2) RSS-247 5.4(d)	Max Output Power (Hybrid)	< 1 Watt	Pass
FCC 15.247(b)(4) RSS-247 5.4(d)	Antenna Gain	< 6 dBi	Pass See Justifications
FCC 15.247(d) RSS-247 5.5	Antenna Conducted Spurious (Hybrid)	< 30 dBc	Pass
FCC 15.247(f) RSS-247 5.3(a)	Time of Occupancy (Hybrid)	< 0.4sec	Pass
FCC 15.247(f) RSS-247 5.3(b)	Power Spectral Density (Hybrid)	< 8 dBm (3 kHz BW)	Pass
Overall Result			Pass

If the product as tested or otherwise complies with the specification, the EUT is deemed to comply with the requirement and is deemed a 'PASS' grade. If not 'FAIL' grade will be issued. Note that 'PASS' / 'FAIL' grade is independent of any measurement uncertainties. A 'PASS' / 'FAIL' grade within measurement uncertainty is marked with a '*'.

Client	Ecobee Inc.	
Product	ECB601/ECB501	
Standard(s)	RSS 247 Issue 2:2017 FCC Part 15 Subpart 15.247	

Notes, Justifications, or Deviations

The following notes, justifications for tests not performed or deviations from the above listed specifications apply:

For the Antenna requirement specified in FCC 15.203 (RSS-247 section 5.4(d)), the unit uses a -1.8 dBi gain PCB trace antenna which is less than the 6 dBi gain limit.

For the Restricted Bands of operation, the EUT is designed to only operate between 920.00 – 927.35MHz which lies entirely within 902 – 928 MHz.

The EUT does not coordination transmission with any other FHSS to avoid simultaneous occupation of hopping frequencies.

The transmitter is a Hybrid transmitter. Thus, the following are not applicable:

1. A minimum 6 dB bandwidth of 500 kHz
2. Minimum number of hopping channels

The EUT contains a 902 – 928 MHz FHSS/Hybrid transmitter, a 2400 – 2483.5 MHz FHSS transmitter, three 2400 – 2483.5 DTS MHz transmitter, and UNII-1 and UNII-3 transmitters. Antenna co-location testing is applicable and documented in a test report.

For maximum permissible exposure, this device is designed to operate greater than 20 cm from any personnel during normal operation. No testing is required, however worst-case calculated exposure compliance was shown in the RF Exposure exhibits.

Client	Ecobee Inc.	
Product	ECB601/ECB501	
Standard(s)	RSS 247 Issue 2:2017 FCC Part 15 Subpart 15.247	

Sample Calculation(s)

Radiated Emission Test

E-Field Level = Received Signal + Antenna Factor + Cable Loss – Pre-Amp Gain

E-Field Level = 50dB μ V + 10dB/m + 2dB – 20dB

E-Field Level = 42dB μ V/m

Margin = Limit – E-Field Level

Margin = 50dB μ V/m – 42dB μ V/m

Margin = 8.0 dB (pass)

Power Line Conducted Emission Test

E-Field Level = Received Signal + Attenuation Factor + Cable Loss + LISN Factor

E-Field Level = 50dB μ V + 10dB + 2.5dB + 0.5dB

E-Field Level = 63dB μ V

Margin = Limit – E-Field Level

Margin = 73dB μ V – 63dB μ V

Margin = 10.0 dB (pass)

Client	Ecobee Inc.	
Product	ECB601/ECB501	
Standard(s)	RSS 247 Issue 2:2017 FCC Part 15 Subpart 15.247	

Applicable Standards, Specifications and Methods

- ANSI C63.4:2014 Methods of Measurement of Radio-Noise Emissions from Low-Voltage Electrical and Electronic Equipment in the Range of 9 kHz to 40 GHz
- ANSI C63.10:2013 American National Standard For Testing Unlicensed Wireless Devices
- SCFR 47 FCC 15 Subpart C Code of Federal Regulations – Radio Frequency Devices, Intentional Radiators
- FCC KDB 558074: 2019 FCC KDB 558074 Digital Transmission Systems, measurements and procedures
- FCC KDB 447498: 2015 RF exposure procedures and equipment authorization policies for mobile and portable devices
- ICES-003 Issue 7: 2020 Digital Apparatus - Spectrum Management and Telecommunications Policy Interference-Causing Equipment Standard
- RSS-GEN Issue 5: 2018+A1:2019+A2:2021 General Requirements and Information for the Certification of Radio Apparatus
- RSS-247 Issue 2: 2017 Digital Transmission Systems (DTSs), Frequency Hopping Systems (FHSs) and Licence-Exempt Local Area Network (LE-LAN) Devices
- ISO 17025:2017 General Requirements for the Competence of Testing and Calibration Laboratories

Client	Ecobee Inc.	
Product	ECB601/ECB501	
Standard(s)	RSS 247 Issue 2:2017 FCC Part 15 Subpart 15.247	

Document Revision Status

Revision	Date	Description	Initials
000	2022-04-24	Initial Release	MX
001	2022-05-03	Updated Appendix A and added antenna gain.	MX

Client	Ecobee Inc.	
Product	ECB601/ECB501	
Standard(s)	RSS 247 Issue 2:2017 FCC Part 15 Subpart 15.247	

Definitions and Acronyms

The following definitions and acronyms are applicable in this report.
See also ANSI C63.14.

DTS – Digital Transmission System
LISN – Line Impedance Stabilization Network
NCR – No Calibration Required
NSA – Normalized Site Attenuation
N/A – Not Applicable
RF – Radio Frequency

AE – Auxiliary Equipment. A digital accessory that feeds data into or receives data from another device (host) that in turn, controls its operation.

Antenna Port – Port, other than a broadcast receiver tuner port, for connection of an antenna used for intentional transmission and/or reception of radiated RF energy.

BW – Bandwidth. Unless otherwise stated, this refers to the 6 dB bandwidth.

EMC – Electro-Magnetic Compatibility. The ability of an equipment or system to function satisfactorily in its electromagnetic environment without introducing intolerable electromagnetic disturbances to anything in that environment.

EMI – Electro-Magnetic Immunity. The ability to maintain a specified performance when the equipment is subjected to disturbance (unwanted) signals of specified levels.

EUT – Equipment Under Test. A device or system being evaluated for compliance that is representative of a product to be marketed.

ITE – Information Technology Equipment. Has a primary function of entry, storage, display, retrieval, transmission, processing, switching, or control of data and/or telecommunication messages and which may be equipped with one or more ports typically for information transfer.

Client	Ecobee Inc.	
Product	ECB601/ECB501	
Standard(s)	RSS 247 Issue 2:2017 FCC Part 15 Subpart 15.247	

Testing Facility

Testing for EMC on the EUT was carried out at TÜV SÜD Canada testing lab near Toronto, Ontario. The testing lab has calibrated 3m semi-anechoic chambers which allow measurements on a EUT that has a maximum width or length of up to 2m and a height of up to 3m. The testing lab also has a calibrated 10m Open Area Test Site (OATS). The chambers are equipped with a turntable that is capable of testing devices up to 5000lb in weight and are equipped with a mast that controls the polarization and height of the antenna. Control of the mast occurs in the control room adjoining the shielded chamber. This facility is capable of testing products that are rated for single phase or 3-phase AC input and DC capability is also available. Radiated emission measurements are performed using a BiLog antenna and a Horn antenna where applicable. Conducted emissions, unless otherwise stated, are performed using a LISN and using the vertical ground plane if applicable.

Calibrations and Accreditations

The 3m semi-anechoic chamber is registered with Federal Communications Commission (FCC, CA6844), Innovation, Science and Economic Development Canada (ISED, 6844A-3) and Voluntary Control Council for Interference (VCCI, R-14023, G-20072, C-14498, and T-20060). This chamber was calibrated for Normalized Site Attenuation (NSA) using test procedures outlined in ANSI C63.4 "Methods of Measurement of Radio-Noise Emissions from Low-Voltage Electrical and Electronic Equipment in the Range of 9 kHz to 40 GHz". The chamber is lined with ferrite tiles and absorption cones to minimize any undesired reflections. The NSA data is kept on file at TÜV SÜD Canada. For radiated susceptibility testing, a 16 point field calibration has been performed on the chamber. The field uniformity data is kept on file at TÜV SÜD Canada. TÜV SÜD Canada Inc. is accredited to ISO 17025 by A2LA with Testing Certificate #2955.02. The laboratory's current scope of accreditation listing can be found as listed on the A2LA website. All measuring equipment is calibrated on an annual or biennial basis as listed for each respective test.

Client	Ecobee Inc.	
Product	ECB601/ECB501	
Standard(s)	RSS 247 Issue 2:2017 FCC Part 15 Subpart 15.247	

Testing Environmental Conditions and Dates

Following environmental conditions were recorded in the facility during time of testing

Date	Test	Initials	Temperature (°C)	Humidity (%)	Pressure (kPa)
2021-09-23	Radiated Emissions	MX	24.0	44.8	101.8
2021-10-05	Antenna Conducted Emissions	23.2	22.3	100.5	101.6
2021-10-01	Power Line Conducted Emissions	MX	23.2	39.8	102.2

Client	Ecobee Inc.	
Product	ECB601/ECB501	
Standard(s)	RSS 247 Issue 2:2017 FCC Part 15 Subpart 15.247	

Detailed Test Results Section

Client	Ecobee Inc.	
Product	ECB601/ECB501	
Standard(s)	RSS 247 Issue 2:2017 FCC Part 15 Subpart 15.247	

Emission Bandwidth

Purpose

The purpose of this test is to ensure that the upper and lower frequency limits of the transmitter 99% emission power bandwidth remain within the operating frequency limits at all times.

Limits and Method

The method is given in ANSI C63.10 Section 6.9.3 and RSS-GEN 6.7.

The 99% and 20dB bandwidth shall always remain within the operating frequency band. This should be measured with a RBW in the range of 1% to 5% of the occupied bandwidth and a VBW of approximately three times RBW.

Results

The EUT passed. The 99% bandwidth was measured using the 99% bandwidth function of the spectrum analyzer.

Frequency (MHz)	20dB Bandwidth (MHz)	99% Bandwidth (MHz)	Result
920.00	89.5	88.4	Pass
927.35	89.6	88.2	Pass

Client	Ecobee Inc.	
Product	ECB601/ECB501	
Standard(s)	RSS 247 Issue 2:2017 FCC Part 15 Subpart 15.247	

Graphs

The graphs shown below show the 20 dB Bandwidth and the OBW of the device during antenna conducted measurement operation of the EUT. This is measured by a max hold on the spectrum analyzer.

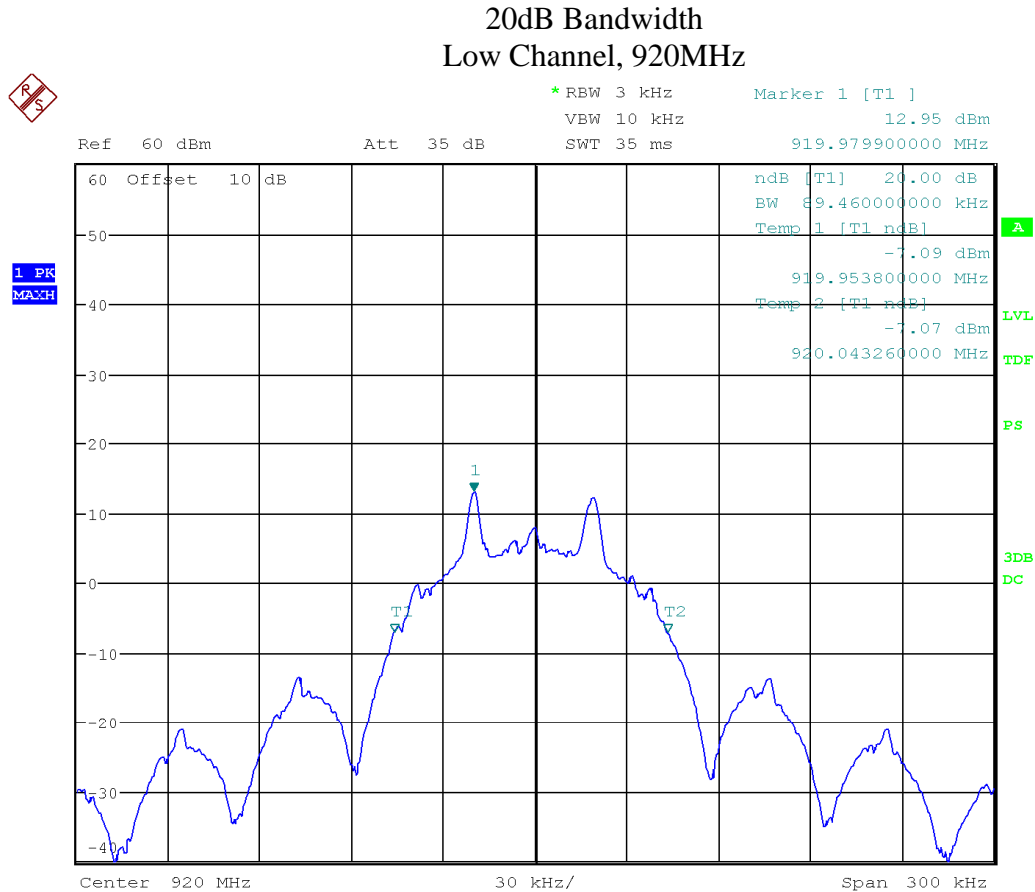

Date: 5.OCT.2021 16:54:00

Client	Ecobee Inc.	 Canada
Product	ECB601/ECB501	
Standard(s)	RSS 247 Issue 2:2017 FCC Part 15 Subpart 15.247	

**20dB Bandwidth
High Channel, 927.35MHz**



MARKER 1	* RBW 3 kHz	Marker 1 [T1]
919.9799 MHz	VBW 10 kHz	12.96 dBm
Ref 60 dBm	Att 35 dB	919.979900000 MHz
	SWT 35 ms	

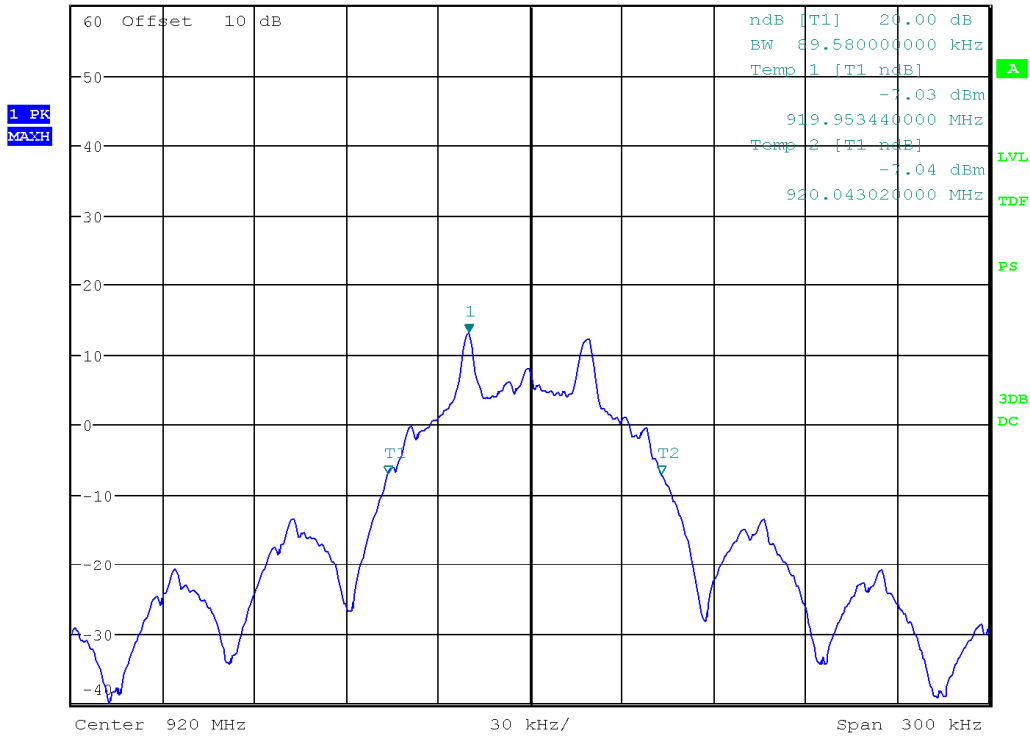

Date: 5.OCT.2021 17:26:06

Client	Ecobee Inc.	 Canada
Product	ECB601/ECB501	
Standard(s)	RSS 247 Issue 2:2017 FCC Part 15 Subpart 15.247	

99% Bandwidth Low Channel

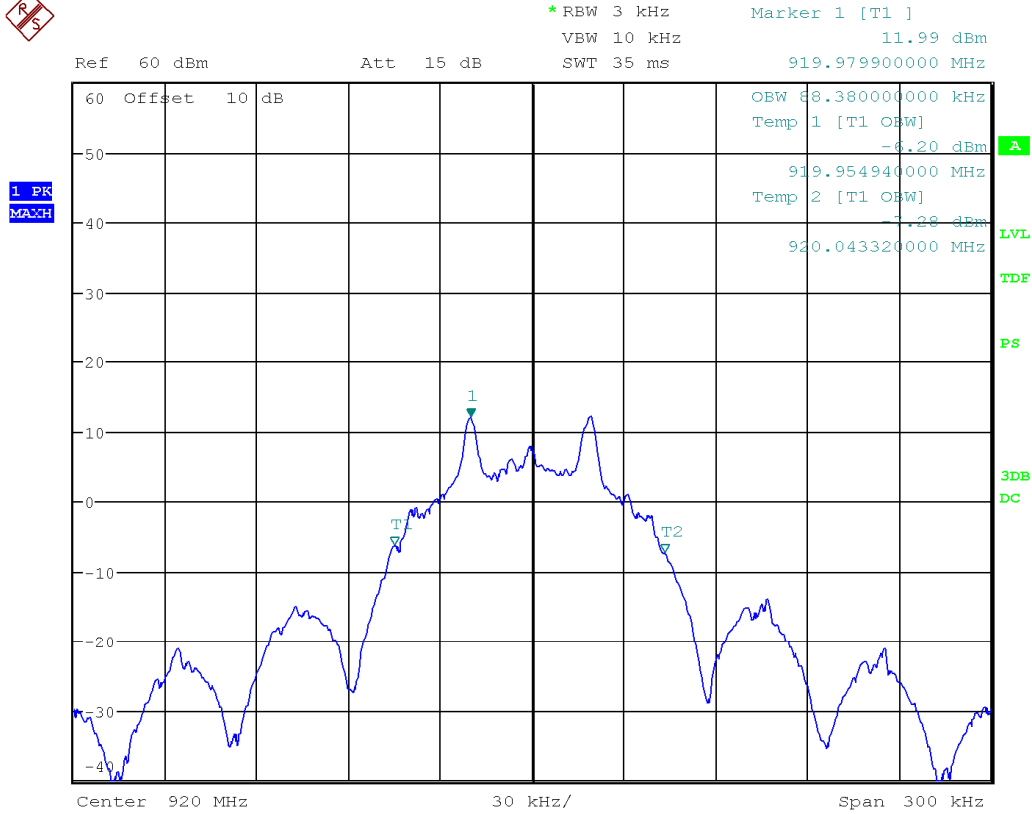

Date: 5.OCT.2021 16:55:03

Client	Ecobee Inc.	
Product	ECB601/ECB501	
Standard(s)	RSS 247 Issue 2:2017 FCC Part 15 Subpart 15.247	

99% Bandwidth High Channel

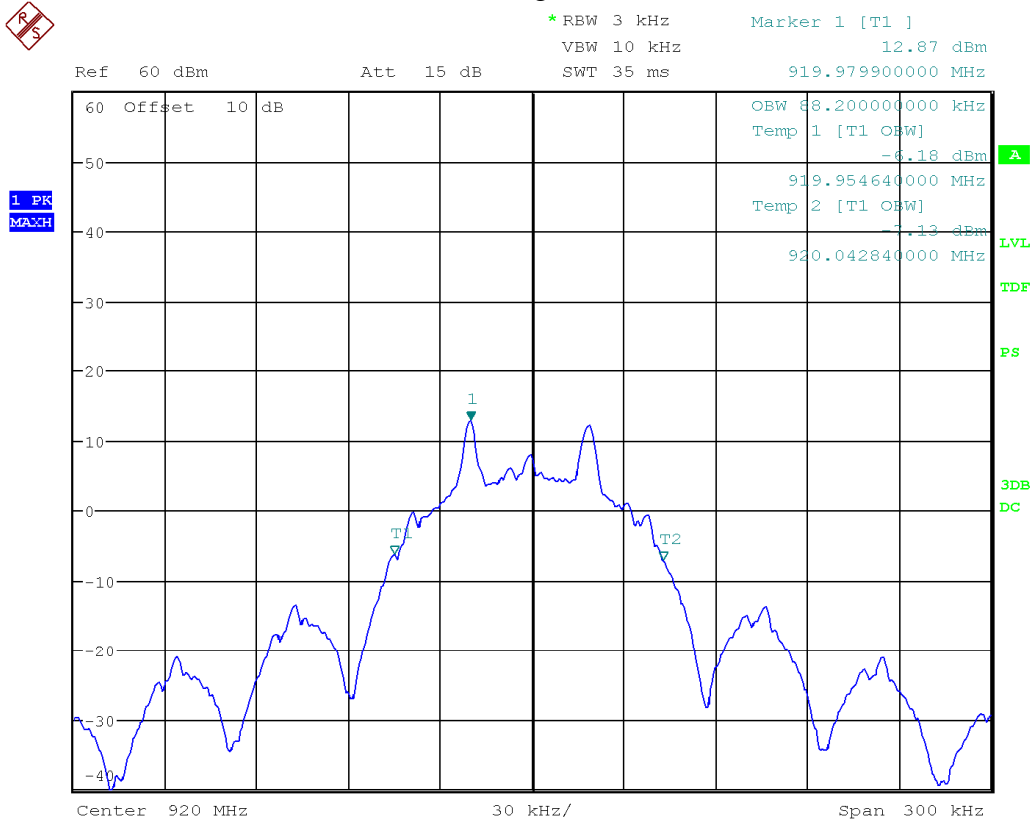

Date: 5.OCT.2021 17:24:26

Note: See 'Appendix B – EUT & Test Setup Photos' for photos showing the test set-up.

Test Equipment List

Equipment	Model No.	Manufacturer	Last Calibration Date	Next Calibration Date	Asset #
Spectrum Analyzer	ESU 40	Rohde & Schwarz	Jan. 15, 2020	Jan. 15, 2022	GEMC 233
Attenuator 10 dB	8493B	Agilent	Oct 4, 2021	Oct 4, 2022	GEMC133
Attenuator 10 dB	3M-10	Weinschel	Oct 4, 2021	Oct 4, 2022	GEMC 279

Client	Ecobee Inc.	
Product	ECB601/ECB501	
Standard(s)	RSS 247 Issue 2:2017 FCC Part 15 Subpart 15.247	

Carrier Frequency Separation

Purpose

The purpose of this test is to ensure that the RF energy of frequency hopping systems is sufficiently spread over a spectrum and that the radio energy is not overly dense. This limit helps allow for other spread spectrum devices to co-exist in the same frequency spectrum. This also helps prevent corruption of data by ensuring adequate channel separation to distinguish the reception of the intended information.

Limits and method

The limits are as defined in 47 CFR FCC Part 15 Section 15.247(a)(1) and RSS 247 Section 5.1. The test method is a defined in ANSI C63.10 Sections 7.8.2 and 7.8.7.

902 to 928 MHz	$P_{\max\text{-pk}} \leq 1 \text{ W}$ $\Delta f \geq \text{MAX} \{25 \text{ kHz}, BW_{20\text{dB}}\}$ $BW_{20\text{dB}} \leq 250 \text{ kHz}$	$P_{\max\text{-pk}} \leq 0.25 \text{ W}$ $\Delta f \geq \text{MAX} \{25 \text{ kHz}, BW_{20\text{dB}}\}$ $250 \text{ kHz} \leq BW_{20\text{dB}} \leq 500 \text{ kHz}$
2400 to 2483.5 MHz	$P_{\max\text{-pk}} \leq 1 \text{ W}$ $\Delta f \geq \text{MAX} \{25 \text{ kHz}, BW_{20\text{dB}}\}$ Max. $BW_{20\text{dB}}$ not specified	$P_{\max\text{-pk}} \leq 0.125 \text{ W}$ $\Delta f \geq [\text{MAX} \{25 \text{ kHz}, \frac{2}{3}BW_{20\text{dB}}\}]$ OR $\text{MAX} \{25 \text{ kHz}, BW_{20\text{dB}}\}$ Max. $BW_{20\text{dB}}$ not specified
5275 to 5850 MHz	$P_{\max\text{-pk}} \leq 1 \text{ W}$ $\Delta f \geq \text{MAX} \{25 \text{ kHz}, BW_{20\text{dB}}\}$ $BW_{20\text{dB}} \leq 1 \text{ MHz}$	

Note 1: The greater of the 20 dB BW or 25 kHz. The 20 dB BW of the system was measured to be 89.6 kHz, so a limit of 89.6 kHz applies.

Results

The EUT passed the requirements of channel carrier spacing exceeding the measured 20 dB BW of the EUT. The 20 dB bandwidth measured was 89.6 kHz and the device had a channel spacing of 7.37 MHz.

Client	Ecobee Inc.	
Product	ECB601/ECB501	
Standard(s)	RSS 247 Issue 2:2017 FCC Part 15 Subpart 15.247	

Graphs

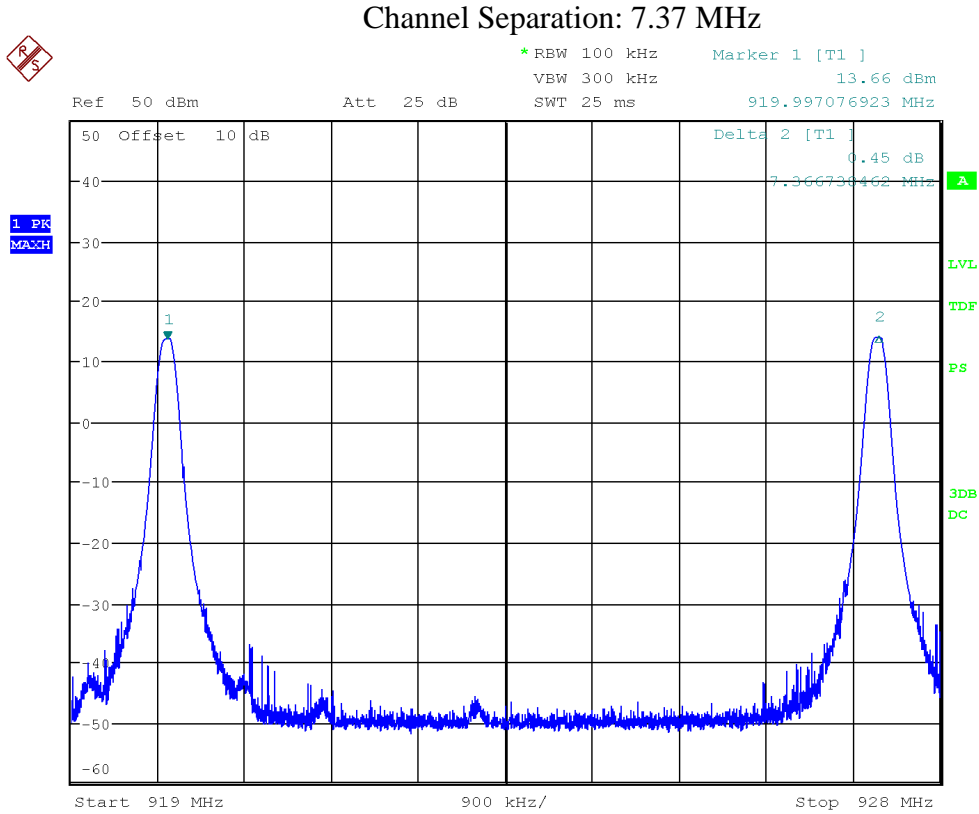

Date: 5.OCT.2021 17:58:40

Note: See 'Appendix B – EUT & Test Setup Photographs' for photos showing the test set-up.

Test Equipment List

Equipment	Model No.	Manufacturer	Last Calibration Date	Next Calibration Date	Asset #
Spectrum Analyzer	ESU 40	Rohde & Schwarz	Jan. 15, 2020	Jan. 15, 2022	GEMC 233
Attenuator 10 dB	8493B	Agilent	Oct 4, 2021	Oct 4, 2022	GEMC133
Attenuator 10 dB	3M-10	Weinschel	Oct 4, 2021	Oct 4, 2022	GEMC 279

Client	Ecobee Inc.	
Product	ECB601/ECB501	
Standard(s)	RSS 247 Issue 2:2017 FCC Part 15 Subpart 15.247	

Time of Occupancy

Purpose

The purpose of this test is to ensure that the RF energy of frequency hopping systems is hopping at a minimum defined rate. This helps ensure sufficient time off to enable other frequency hopping devices to co-operate within this allocated band.

Limits

The limits are as defined in 47 CFR FCC Part 15 Section 15.247 (f) and RSS 247 Section 5.3(a). The test method is a defined in ANSI C63.10 Section 7.8.4.

Hybrid System

902 to 928 MHz, 2400 to 2483.5 MHz, 5275 to 5850 MHz	$t_{ch} \leq 0.4 \text{ s for } T = 0.4 N_{ch} \text{ s}$
--	---

Results

The EUT passed the requirements. Worst case results are shown.

Hybrid:

Number of Channels	2
Dwell Time	15.22 ms
Number of hops within 0.8s (0.4s x 2 Channels Used)	8

$$\begin{aligned}
 \text{Time of Occupancy} &= (\text{Dwell Time}) \times (\# \text{ of hops within } 0.8 \text{ s}) \\
 &= 14.94 \text{ ms} \times 8 \\
 &= 121.76 \text{ ms or } 0.12 \text{ s}
 \end{aligned}$$

The EUT has an average occupancy of 0.12 s within a 0.8 s period. This is under the 0.4 s limit.

Client	Ecobee Inc.	
Product	ECB601/ECB501	
Standard(s)	RSS 247 Issue 2:2017 FCC Part 15 Subpart 15.247	

Graphs

Hybrid – Dwell Time

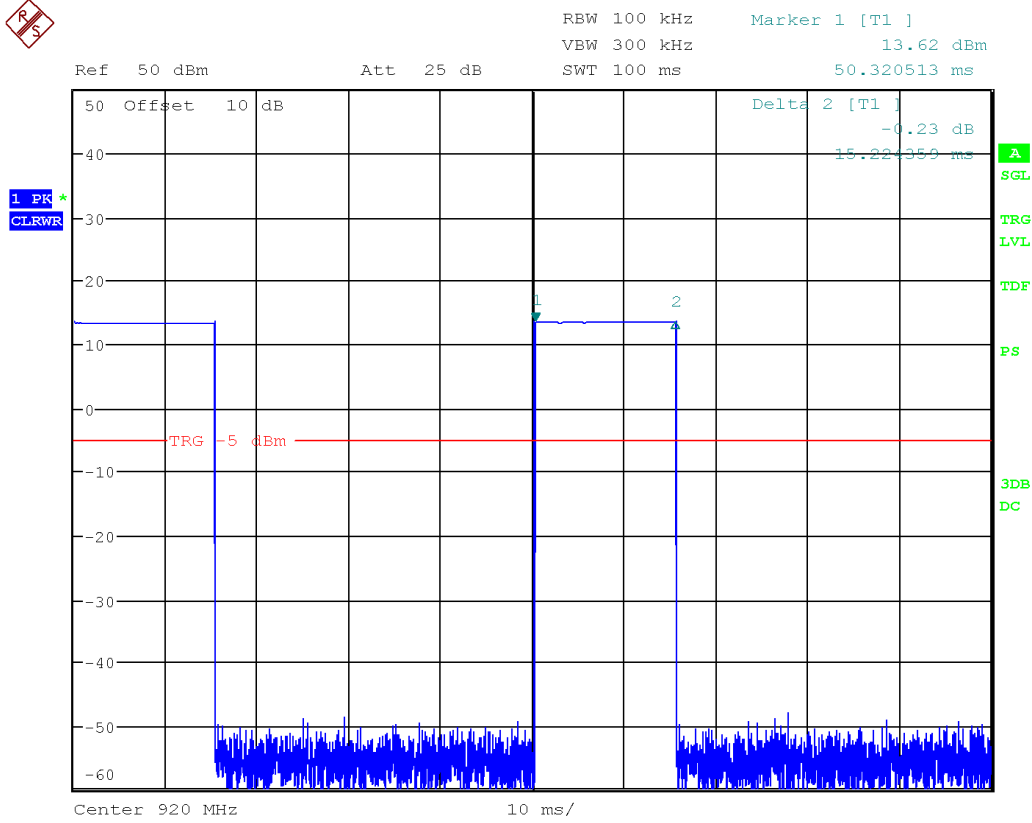

Date: 5.OCT.2021 18:03:07

Client	Ecobee Inc.	
Product	ECB601/ECB501	
Standard(s)	RSS 247 Issue 2:2017 FCC Part 15 Subpart 15.247	

Hybrid – Number of Hops within 800ms Period

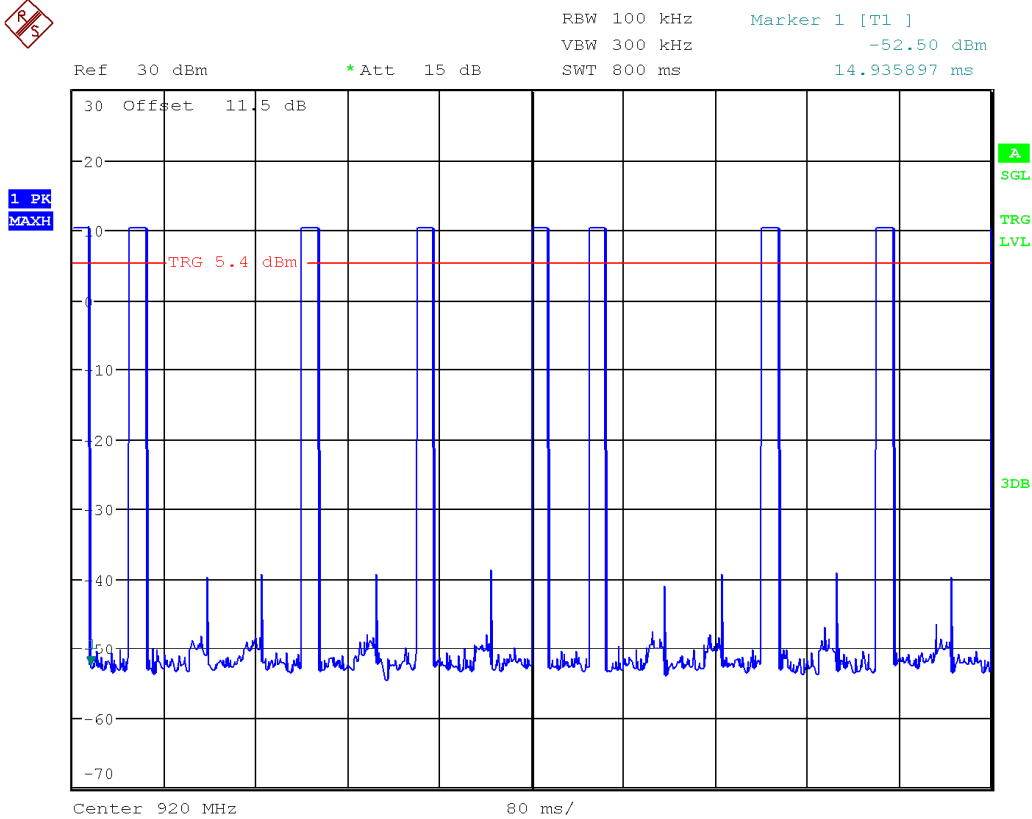

Date: 5.JAN.2022 13:53:29

Number of hops in 0.8 s is 8.

Note: See ‘Appendix B – EUT & Test Setup Photographs’ for photos showing the test set-up.

Client	Ecobee Inc.	
Product	ECB601/ECB501	
Standard(s)	RSS 247 Issue 2:2017 FCC Part 15 Subpart 15.247	

Test Equipment List

Equipment	Model No.	Manufacturer	Last Calibration Date	Next Calibration Date	Asset #
Spectrum Analyzer	ESU 40	Rohde & Schwarz	Jan. 15, 2020	Jan. 15, 2022	GEMC 233
Attenuator 10 dB	8493B	Agilent	Oct 4, 2021	Oct 4, 2022	GEMC133
Attenuator 10 dB	3M-10	Weinschel	Oct 4, 2021	Oct 4, 2022	GEMC 279

Client	Ecobee Inc.	
Product	ECB601/ECB501	
Standard(s)	RSS 247 Issue 2:2017 FCC Part 15 Subpart 15.247	

Maximum Conducted Output Power

Purpose

The purpose of this test is to ensure that the maximum power conducted to the radiating element does not exceed the limits specified.

Limits

The limits are defined in FCC Part 15.247(b) and RSS-247 5.4(d). For systems using digital modulation in the 902-928 MHz, 2400-2483.5 MHz, and 5725-5850 MHz bands, the peak limit is 1 watt (30 dBm).

The method is given in FCC KDB 558074 and ANSI C63.10 section 11.9.2.2.2 (AVGSA-1).

Results

The EUT passed. The FHSS average power measured was 12.64 dBm (18.37 mW).

The EUT was set to transmit at pre-set power. Low and high bands were measured. The following table shows the average power spectral density. External attenuators and cable loss were accounted for as transducer factor (TDF) and as reference offset in the spectrum analyzer.

Channel	Frequency (MHz)	Avg Power (dBm)	Avg Power (mW)
Low	920.00	12.58	18.11
High	927.35	12.64	18.37

Client	Ecobee Inc.	
Product	ECB601/ECB501	
Standard(s)	RSS 247 Issue 2:2017 FCC Part 15 Subpart 15.247	

Graphs

The graphs shown below show the average power output of the device during the conducted measurement operation of the EUT. The integrated band power measurement method was used.

The external attenuator and cable loss are accounted for as Transducer Factor (TDF) and an additional 10 dB attenuator was accounted for as reference offset in the spectrum analyzer.

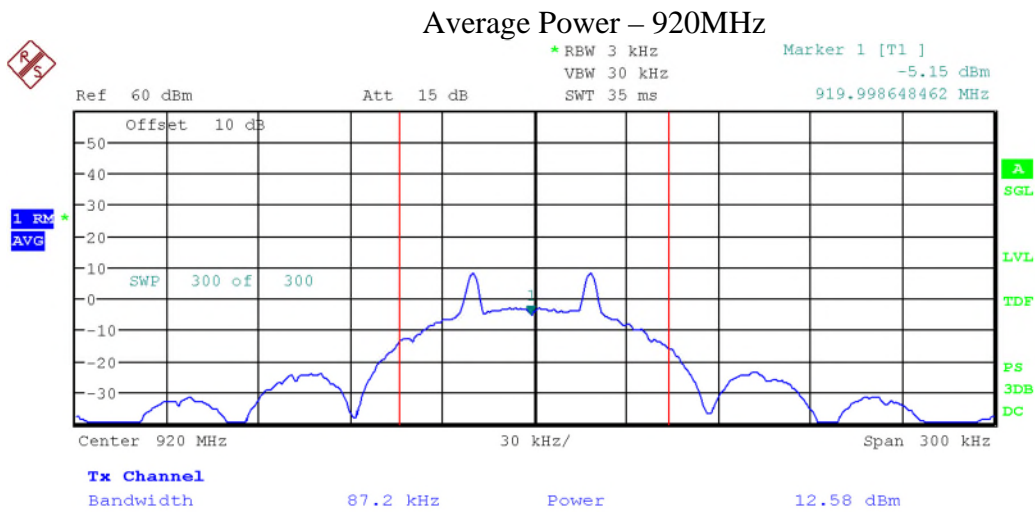

Date: 5.OCT.2021 17:19:30

Client	Ecobee Inc.	
Product	ECB601/ECB501	
Standard(s)	RSS 247 Issue 2:2017 FCC Part 15 Subpart 15.247	

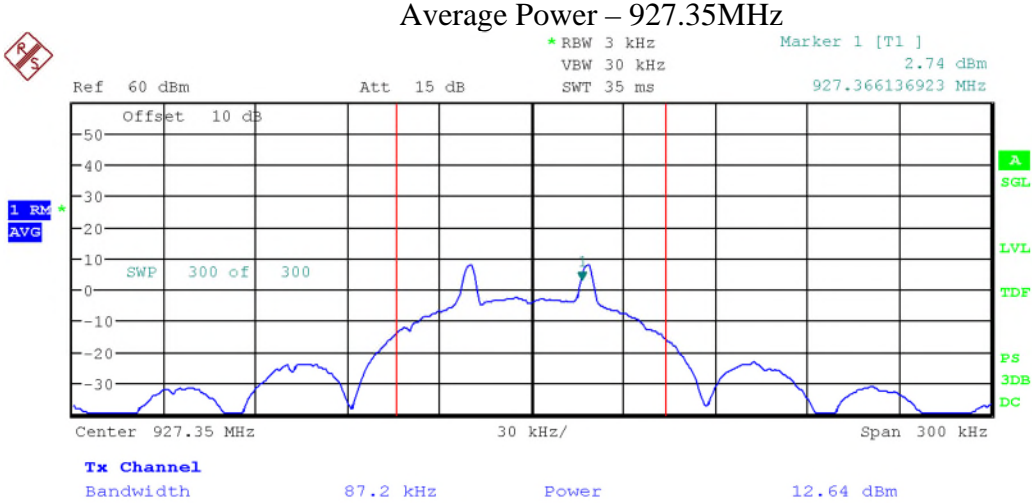

Date: 5.OCT.2021 17:15:23

Test Equipment List

Equipment	Model No.	Manufacturer	Last Calibration Date	Next Calibration Date	Asset #
Spectrum Analyzer	ESU 40	Rohde & Schwarz	Jan. 15, 2020	Jan. 15, 2022	GEMC 233
Attenuator 10 dB	8493B	Agilent	Oct 4, 2021	Oct 4, 2022	GEMC133
Attenuator 10 dB	3M-10	Weinschel	Oct 4, 2021	Oct 4, 2022	GEMC 279

Client	Ecobee Inc.	
Product	ECB601/ECB501	
Standard(s)	RSS 247 Issue 2:2017 FCC Part 15 Subpart 15.247	

Power Spectral Density

Purpose

The purpose of this test is to ensure that the maximum power spectral density to the radiating element does not exceed the limits specified. This ensures that the modulation is significantly wide enough, or low enough in power that it will allow for co-operation of other wireless devices operating within this frequency allocation.

Limits and Method

The limits are defined in 15.247(e) and RSS-247 5.2(b).

For digitally modulated systems, the power spectral density conducted from the intentional radiator to the antenna shall not be greater than 8 dBm in any 3 kHz band during any time interval of continuous transmission.

The method is given in FCC KDB 558074 and ANSI C63.10 Section 11.10.3 (AVGPSD-1).

Results

The EUT passed. The same method used to measure power was used to measure P

The EUT was set to transmit at pre-set power. Low and high bands were measured. The following table shows the average power spectral density. External attenuators and cable loss were accounted for as transducer factor (TDF) and as reference offset in the spectrum analyzer.

Channel	Frequency (MHz)	PSD (dBm)	Limit (dBm/3kHz)	Pass/Fail
Low	920.00	7.67	8	Pass
High	927.35	7.74	8	Pass

Client	Ecobee Inc.	
Product	ECB601/ECB501	
Standard(s)	RSS 247 Issue 2:2017 FCC Part 15 Subpart 15.247	

Graphs

The graphs shown below show the average power spectral density of the device during the conducted measurement operation of the EUT. Low, middle, and high channels were investigated. The external attenuator and cable loss are accounted for as Transducer Factor (TDF) and an additional 10 dB attenuator was accounted for as reference offset in the spectrum analyzer.

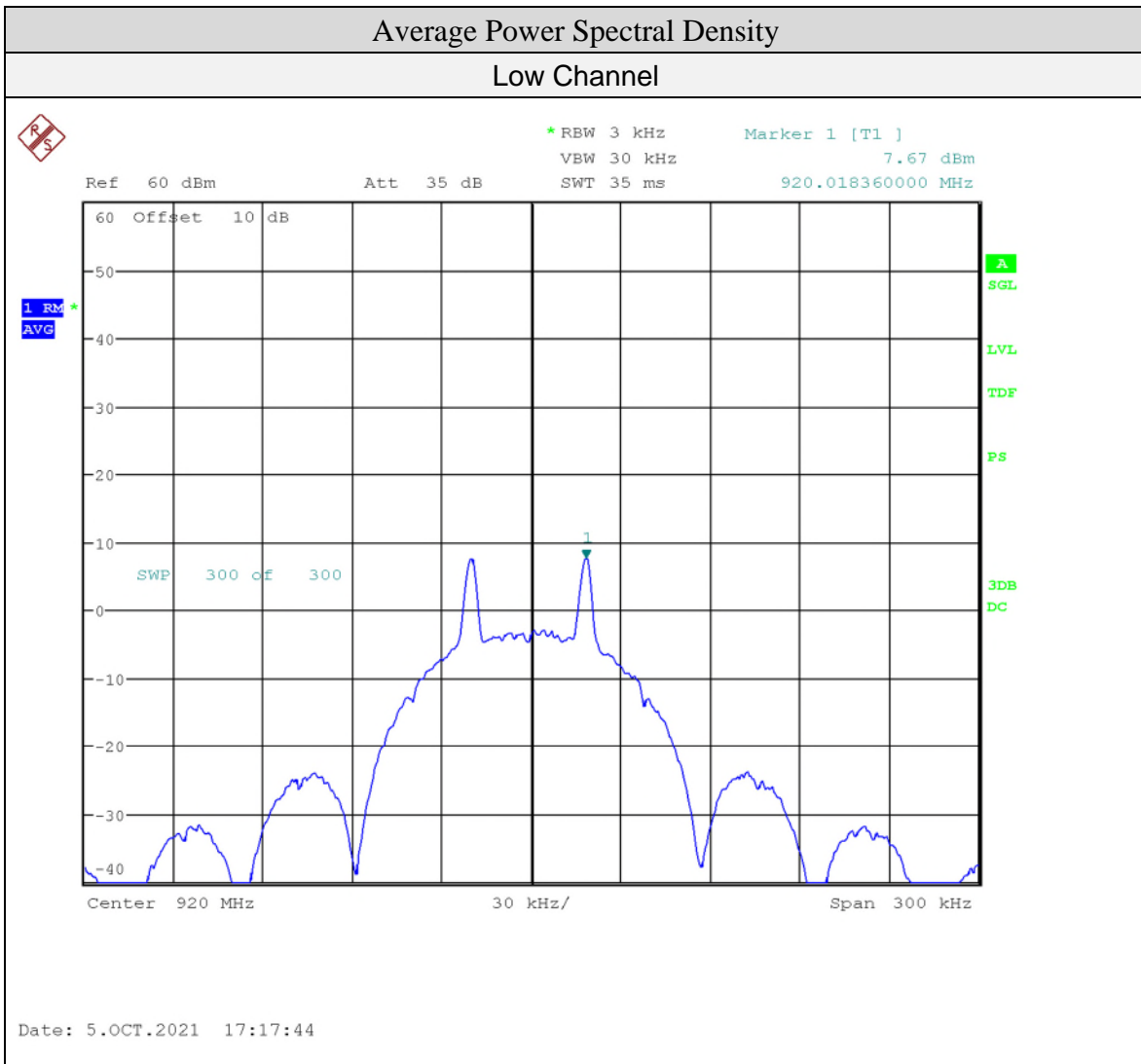

Client	Ecobee Inc.	 Canada
Product	ECB601/ECB501	
Standard(s)	RSS 247 Issue 2:2017 FCC Part 15 Subpart 15.247	

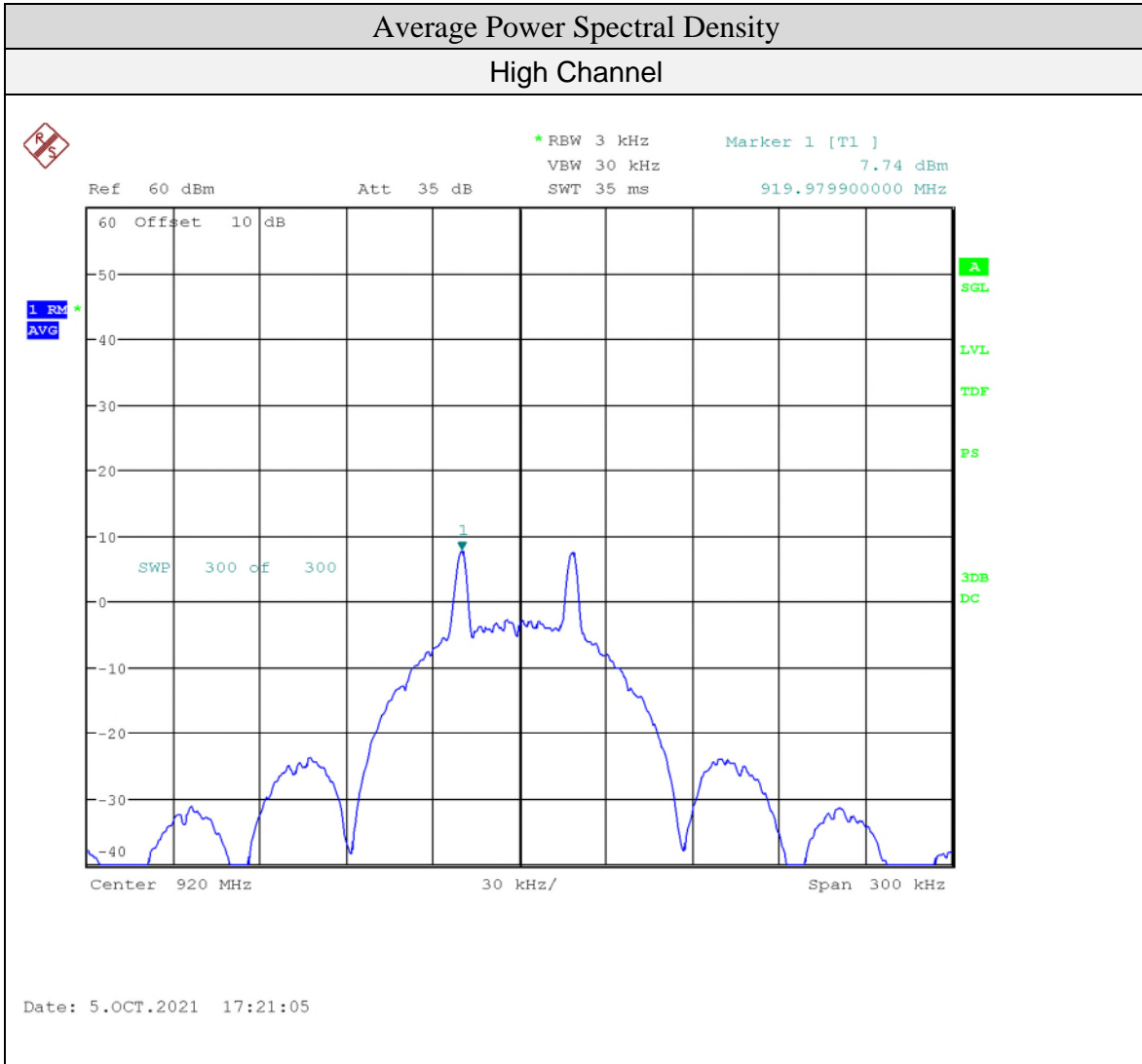

See 'Appendix B – EUT and Test Setup Photos' for photos showing the test set-up.

Test Equipment List

Equipment	Model No.	Manufacturer	Last Calibration Date	Next Calibration Date	Asset #
Spectrum Analyzer	ESU 40	Rohde & Schwarz	Jan. 15, 2020	Jan. 15, 2022	GEMC 233
Attenuator 10 dB	8493B	Agilent	Oct 4, 2021	Oct 4, 2022	GEMC133
Attenuator 10 dB	3M-10	Weinschel	Oct 4, 2021	Oct 4, 2022	GEMC 279

Client	Ecobee Inc.	
Product	ECB601/ECB501	
Standard(s)	RSS 247 Issue 2:2017 FCC Part 15 Subpart 15.247	

Antenna Spurious Conducted Emissions (20dBc)

Purpose

The purpose of this test is to ensure that the maximum power conducted to the radiating element at frequencies outside of the authorized spectrum does not exceed the limits specified. This ensures that the only the intended signal is delivered to the radiating element.

Limits and Method

The limits are defined in 15.247(d) and RSS-247 5.5. In any 100 kHz band, the peak spurious harmonics emissions must be at least 30 dB below the fundamental. Spurious conducted emissions are to be evaluated up to the 10th harmonic. This -30 dBc requirement also applies at the ‘band edge’.

The method is given in ANSI C63.10 Section 11.11.

Results

The EUT passed. Low, and high bands were measured. The -30 dBc requirement is shown for the lower band edge at 902MHz in the low band and for the higher band edge at 928MHz in the high band. Band edge testing was performed with the transmitter in hopping mode and with hopping mode turned off.

Client	Ecobee Inc.	
Product	ECB601/ECB501	
Standard(s)	RSS 247 Issue 2:2017 FCC Part 15 Subpart 15.247	

Graphs

The graphs shown below show the power output of the device during the conducted measurement operation of the EUT.



Client	Ecobee Inc.	
Product	ECB601/ECB501	
Standard(s)	RSS 247 Issue 2:2017 FCC Part 15 Subpart 15.247	

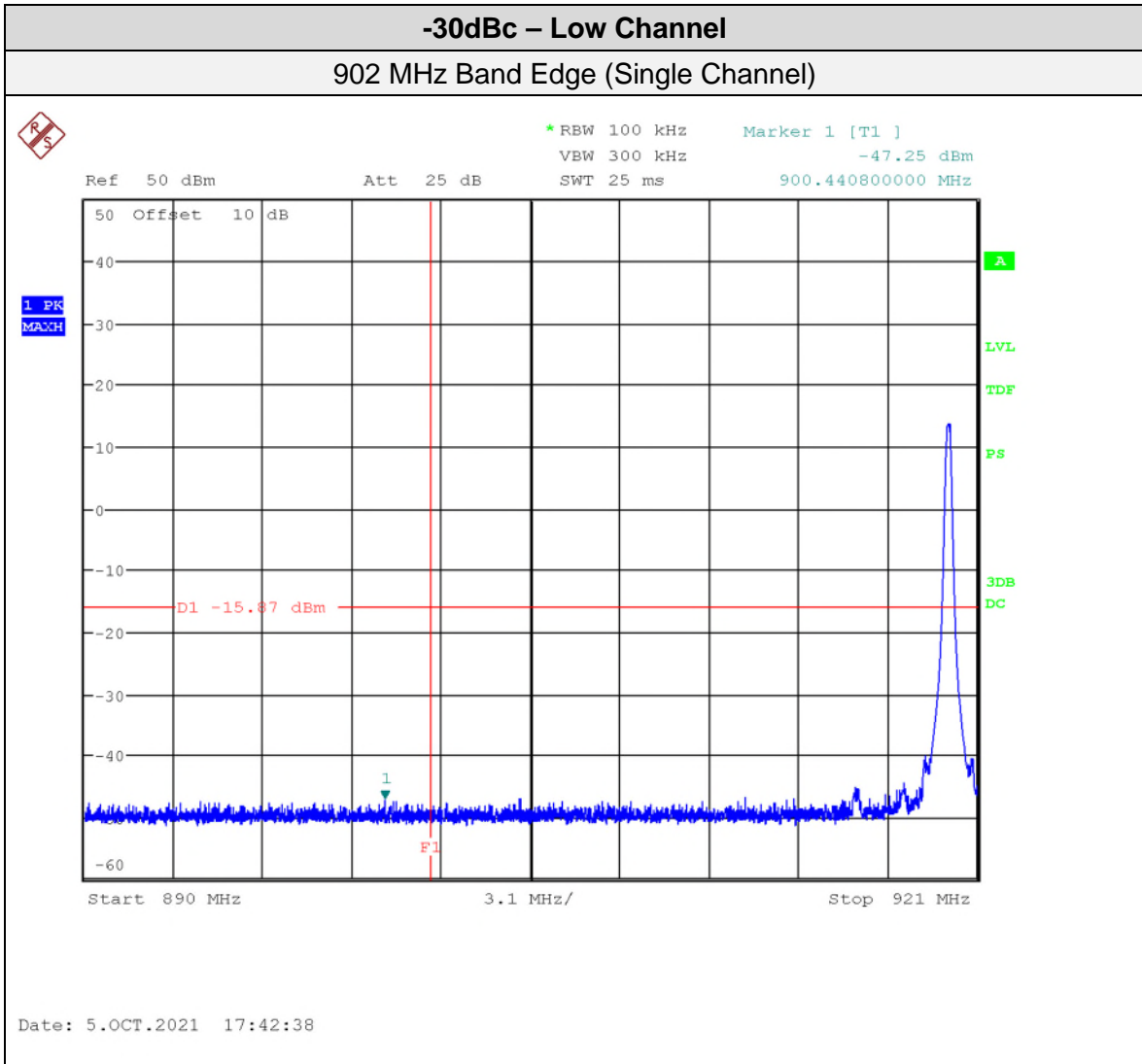

Client	Ecobee Inc.	
Product	ECB601/ECB501	
Standard(s)	RSS 247 Issue 2:2017 FCC Part 15 Subpart 15.247	

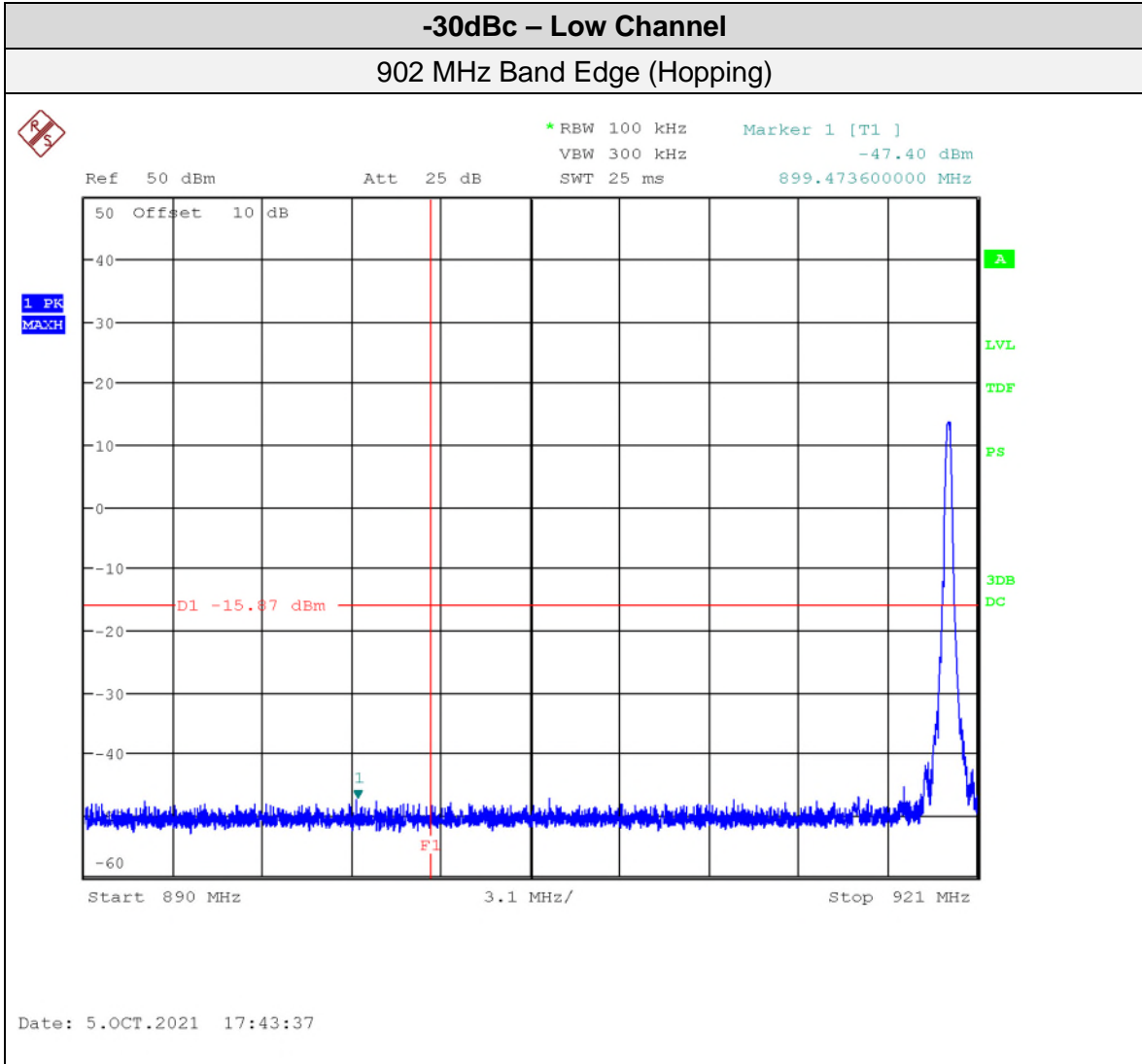

Client	Ecobee Inc.	
Product	ECB601/ECB501	
Standard(s)	RSS 247 Issue 2:2017 FCC Part 15 Subpart 15.247	

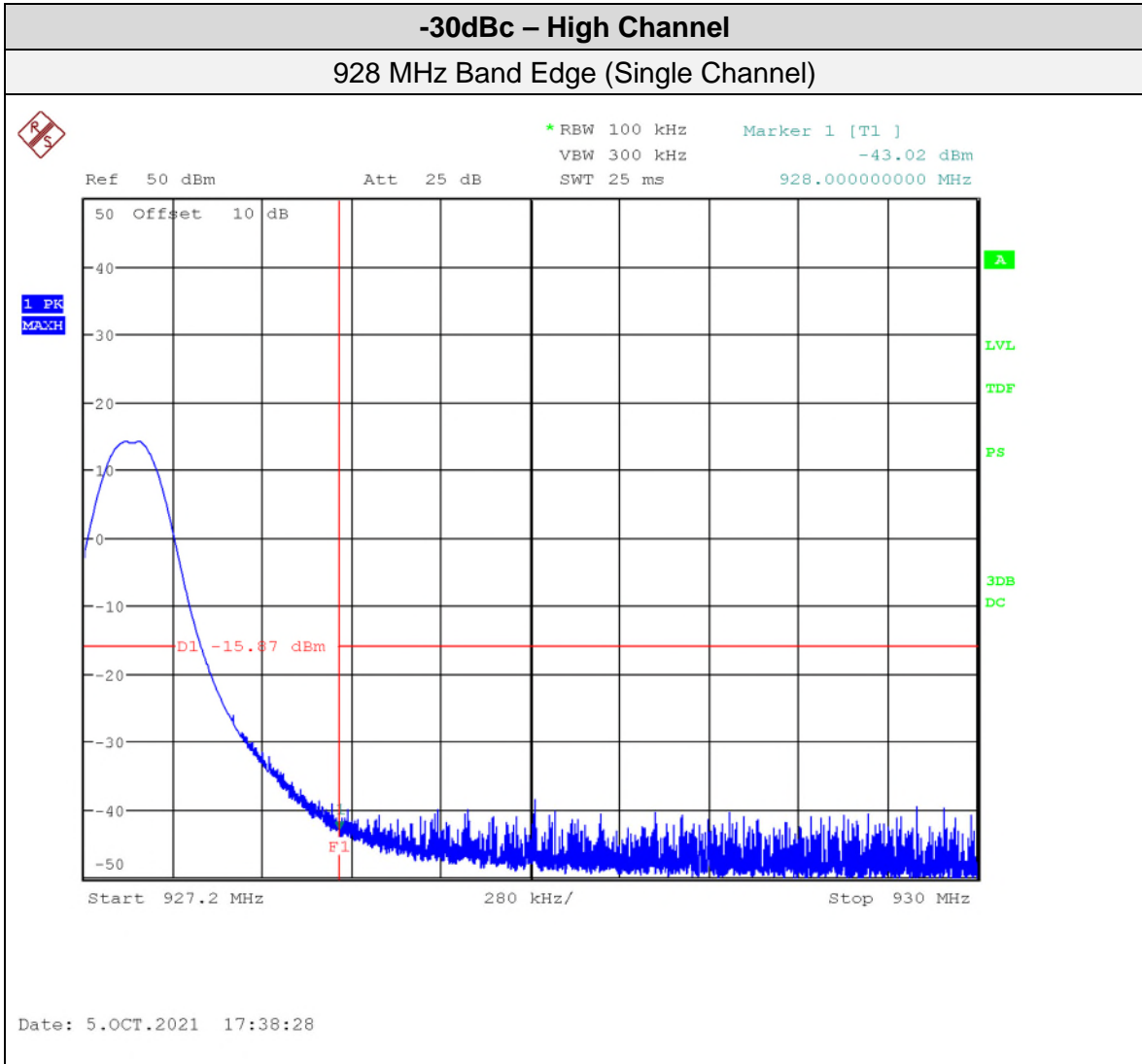

Client	Ecobee Inc.	
Product	ECB601/ECB501	
Standard(s)	RSS 247 Issue 2:2017 FCC Part 15 Subpart 15.247	

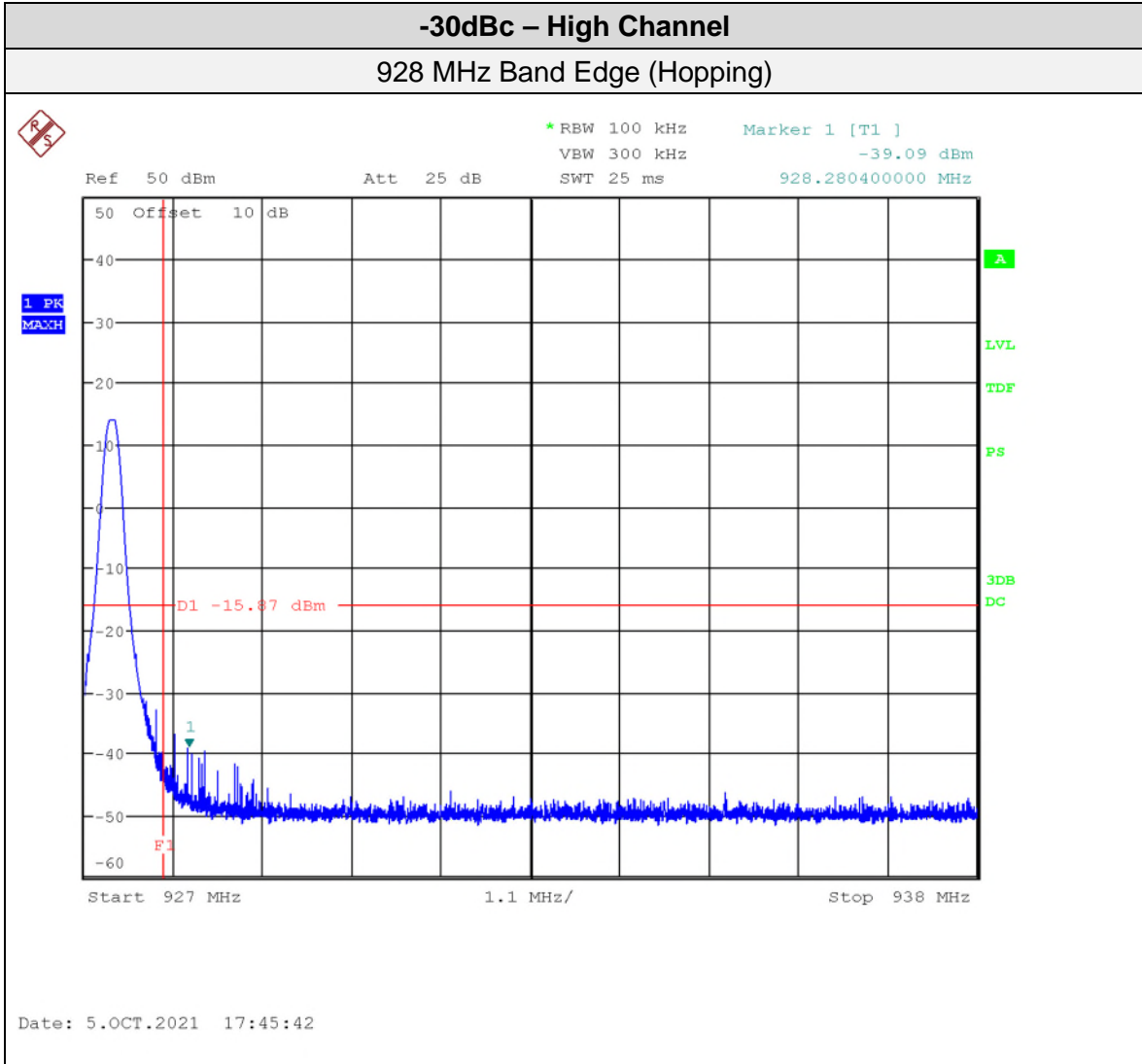

Client	Ecobee Inc.	
Product	ECB601/ECB501	
Standard(s)	RSS 247 Issue 2:2017 FCC Part 15 Subpart 15.247	

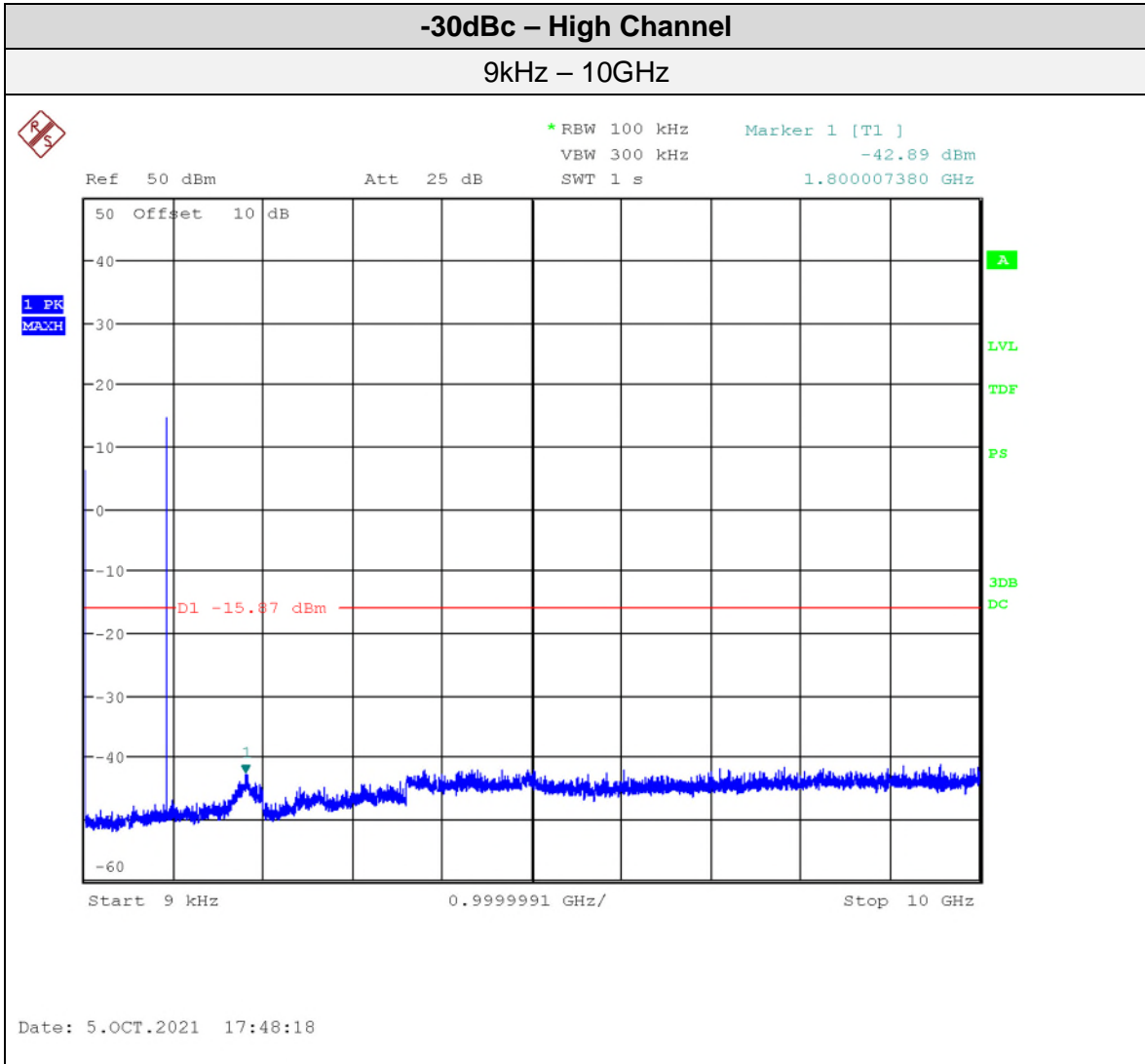

See 'Appendix B – EUT and Test Setup Photos' for photos showing the test set-up.

Client	Ecobee Inc.	
Product	ECB601/ECB501	
Standard(s)	RSS 247 Issue 2:2017 FCC Part 15 Subpart 15.247	

Test Equipment List

Equipment	Model No.	Manufacturer	Last Calibration Date	Next Calibration Date	Asset #
Spectrum Analyzer	ESU 40	Rohde & Schwarz	Jan. 15, 2020	Jan. 15, 2022	GEMC 233
Attenuator 10 dB	8493B	Agilent	Oct 4, 2021	Oct 4, 2022	GEMC133
Attenuator 10 dB	3M-10	Weinschel	Oct 4, 2021	Oct 4, 2022	GEMC 279

Client	Ecobee Inc.	
Product	ECB601/ECB501	
Standard(s)	RSS 247 Issue 2:2017 FCC Part 15 Subpart 15.247	

Transmitter Spurious Radiated Emissions

Purpose

The purpose of this test is to ensure that the RF energy unintentionally emitted from the EUT does not exceed the limits listed below as defined in the applicable test standard, as measured from a receiving antenna. This helps protect broadcast radio services such as television, FM radio, pagers, cellular telephones, emergency services, and so on, from unwanted interference.

Limits and Method

The limits, as defined in 15.247(d) for unintentional radiated emissions, apply for those emissions that fall in the restricted bands, as defined in Section 15.205(a). These emissions must comply with the radiated emission limits specified in Section 15.209(a).

The method is as defined in ANSI C63.10 Section 7.8.6.

All unintentional emissions must also meet the ‘Spurious Conducted Emissions’ requirements of -30 dBc or greater. See also ‘Antenna Spurious Conducted Emissions’ for further details.

Frequency	Field Strength Limit ($\mu\text{V}/\text{m}$)	Field Strength at 3m (dB$\mu\text{V}/\text{m}$)
0.009 MHz – 0.490 MHz	2400/F(kHz) ^a (at 300m)	128.5 to 93.8 ^a
0.490 MHz – 1.705 MHz	24000/F(kHz) ^a (at 30m)	73.8 to 63.0 ^a
1.705 MHz – 30 MHz	30 ^a (at 30m)	69.5 ^a
30 MHz – 88 MHz	100 ^a (at 3m)	40.0 ^a
88 MHz – 216 MHz	150 ^a (at 3m)	43.5 ^a
216 MHz – 960 MHz	200 ^a (at 3m)	46.0 ^a
Above 960 MHz	500 ^a (at 3m)	54.0 ^a
Above 1000 MHz	500 ^b (at 3m)	54.0 ^b
Above 1000 MHz	5 mV/m ^c (at 3m)	74.0 ^c

^aLimit is with Quasi Peak detector with bandwidths as defined in CISPR-16-1-1

^bLimit is with 1 MHz measurement bandwidth and using an Average detector

^cLimit is with 1 MHz measurement bandwidth and using a Peak detector

Based on ANSI C63.4 Section 4.2, if the Peak detector measurements do not exceed the Quasi-Peak limits, where defined, then the EUT is deemed to have passed the requirements.

Page 39 of 58	Report Issued: 5/3/2022	Report File #: 7169010244RF-001 (DSS – SubGig(Hybrid))
------------------	-------------------------	--

Client	Ecobee Inc.	
Product	ECB601/ECB501	
Standard(s)	RSS 247 Issue 2:2017 FCC Part 15 Subpart 15.247	

Typical Radiated Emissions Setup

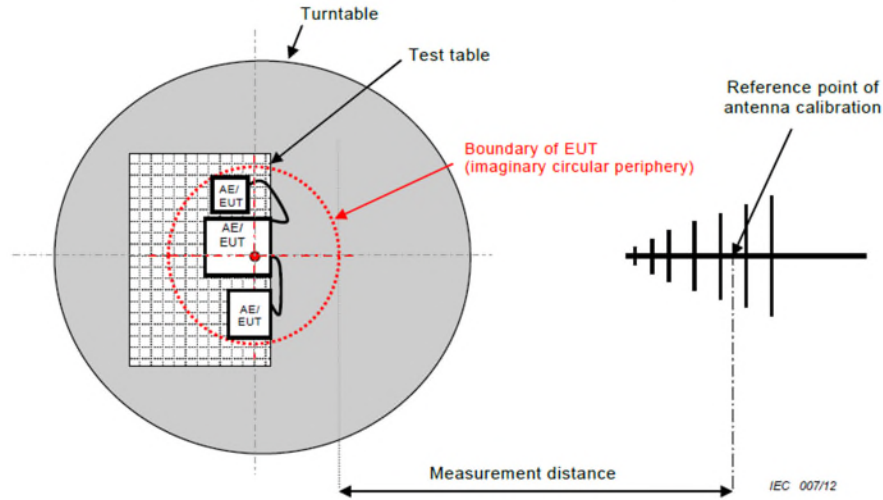

Measurement Uncertainty

The expanded measurement uncertainty is calculated in accordance with CISPR 16-4-2 and is $\pm 5.67\text{dB}$ for 30MHz – 1GHz and $\pm 4.58\text{dB}$ for 1GHz – 18GHz with a 'k=2' coverage factor and a 95% confidence level.

Preliminary Graphs

The graphs shown below are maximized peak measurement graphs measured with a resolution bandwidth greater than or equal to the final required detector over a full 0-360°. This peaking process is done as a worst-case measurement and enables the detection of frequencies of concern for final measurement. For final measurements with the appropriate detector, where applicable, please refer to the tables under Final Measurements.

In accordance with FCC Part 15, Subpart A, Section 15.33, the device was scanned to the 10th harmonic (a minimum of 9280 MHz).

Devices scanned may be scanned at alternate test distances and in accordance with FCC Part 15, Subpart A, Section 15.31, an extrapolation factor of 20 dB/decade was used above 30 MHz and 40 dB/decade below 30 MHz. For example, for 1 meter measurements, an extrapolation factor 9.5 dB from 20 Log (1m / 3m) is applied.

Peak output power for low and high channels were checked. The worst case was used for the spurious emissions.

Client	Ecobee Inc.	
Product	ECB601/ECB501	
Standard(s)	RSS 247 Issue 2:2017 FCC Part 15 Subpart 15.247	

Spurious Emissions

High Channel
9 kHz – 150 kHz
Peak Emission Graph

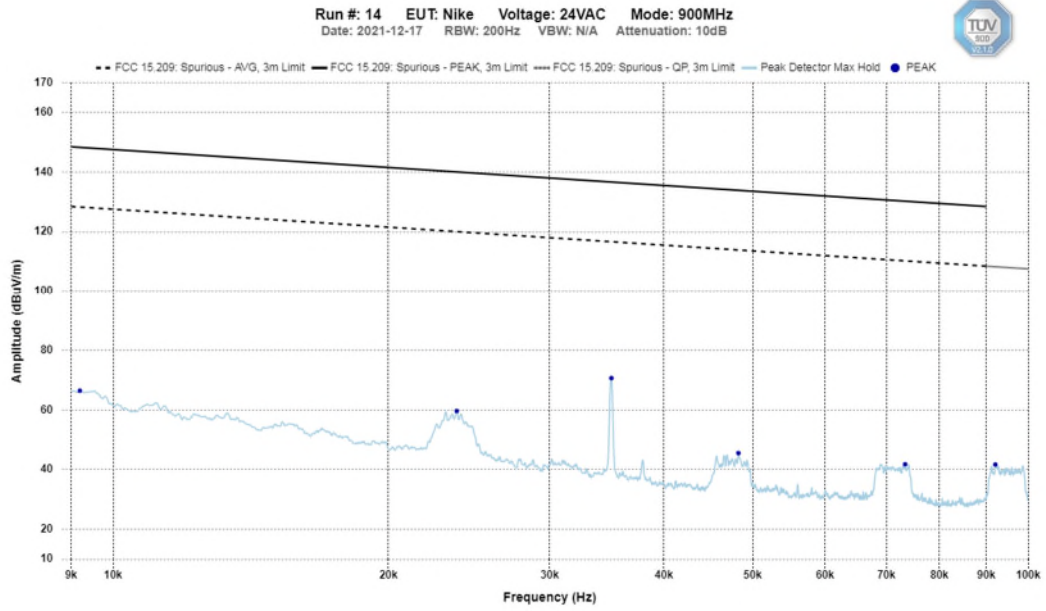

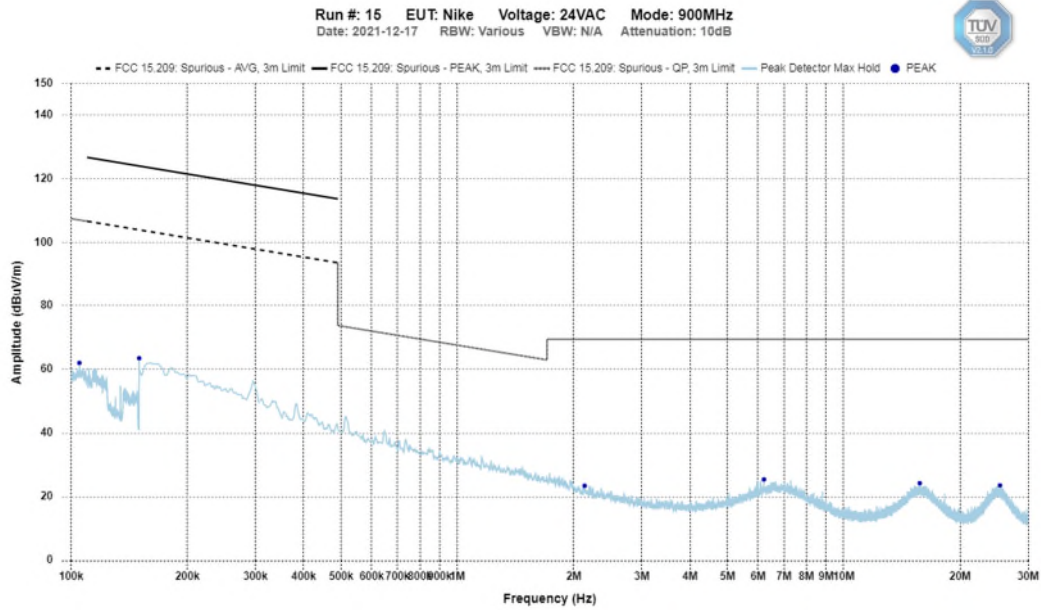

Client	Ecobee Inc.	
Product	ECB601/ECB501	
Standard(s)	RSS 247 Issue 2:2017 FCC Part 15 Subpart 15.247	

High Channel 150 kHz – 30 MHz Peak Emission Graph

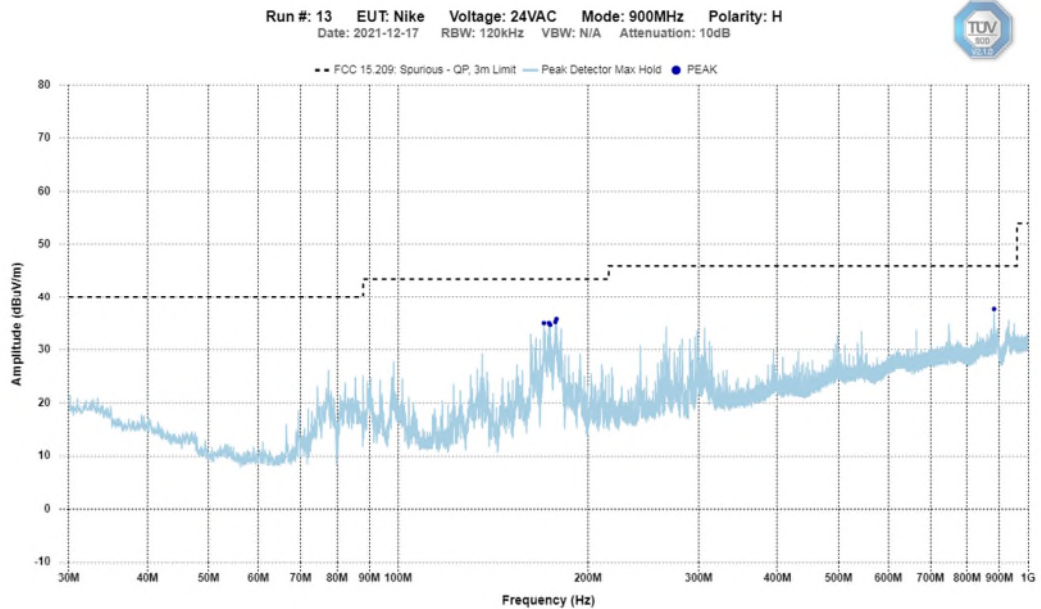

High Channel – 30 MHz – 1 GHz Horizontal - Peak Emission Graph



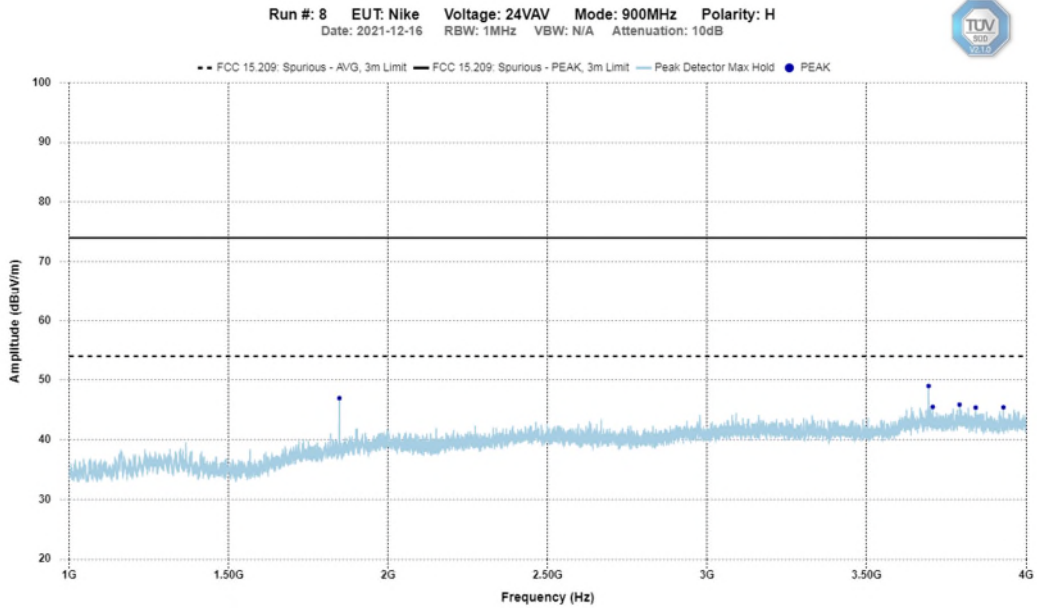

Client	Ecobee Inc.	
Product	ECB601/ECB501	
Standard(s)	RSS 247 Issue 2:2017 FCC Part 15 Subpart 15.247	

High Channel – 1 GHz – 4 GHz Horizontal - Peak Emission Graph

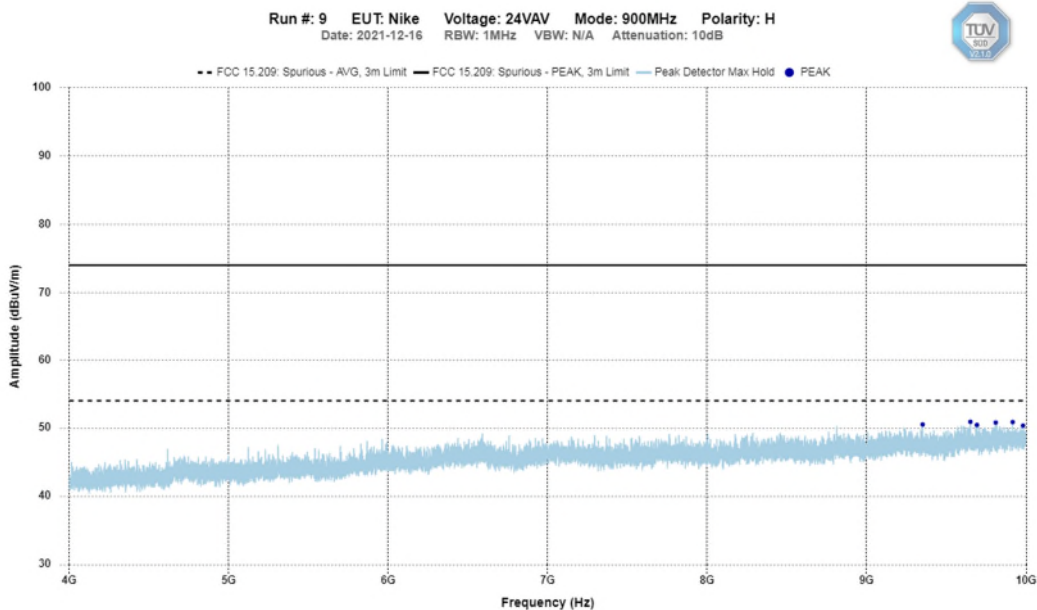

High Channel – 4 GHz – 10 GHz Horizontal - Peak Emission Graph



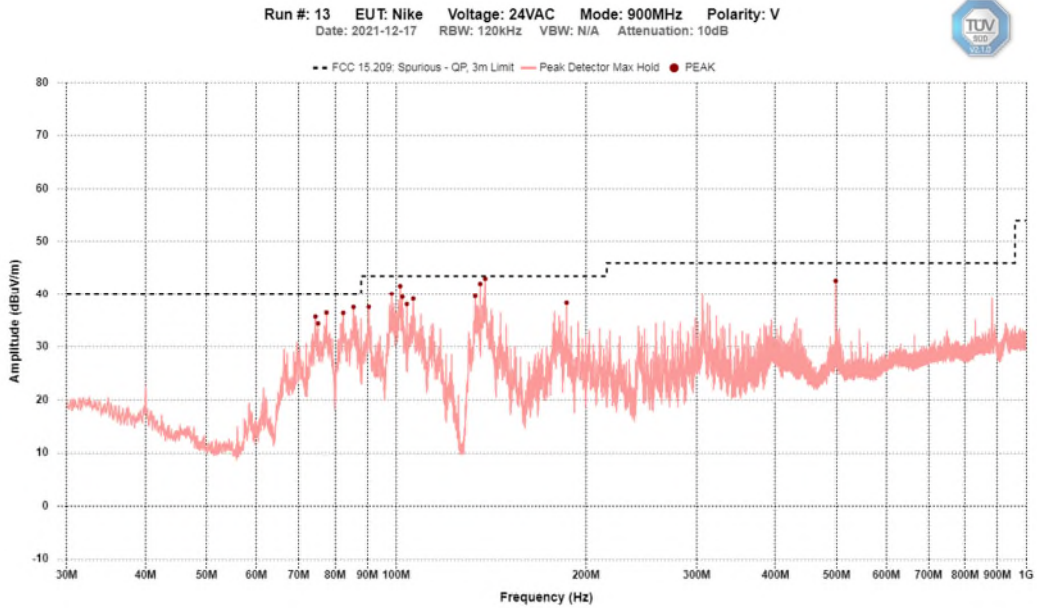

Client	Ecobee Inc.	
Product	ECB601/ECB501	
Standard(s)	RSS 247 Issue 2:2017 FCC Part 15 Subpart 15.247	

High Channel – 30 MHz – 1 GHz Vertical - Peak Emission Graph

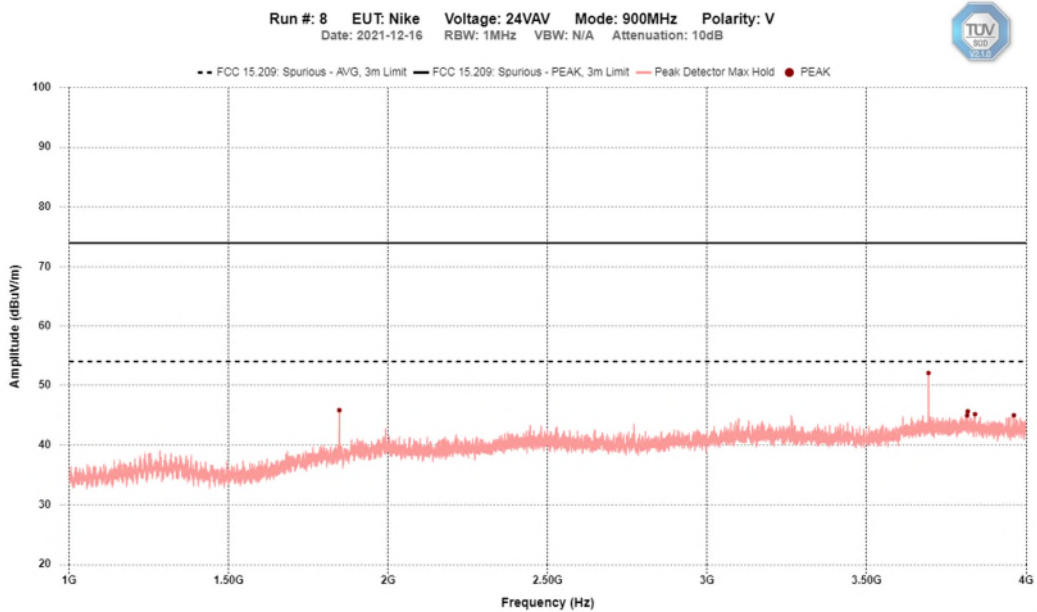

High Channel – 1 GHz – 4 GHz Vertical - Peak Emission Graph



Client	Ecobee Inc.	
Product	ECB601/ECB501	
Standard(s)	RSS 247 Issue 2:2017 FCC Part 15 Subpart 15.247	

High Channel – 4 GHz – 10 GHz
Vertical - Peak Emission Graph

Run #: 9 EUT: Nike Voltage: 24VAV Mode: 900MHz Polarity: V
Date: 2021-12-16 RBW: 1MHz VBW: N/A Attenuation: 10dB

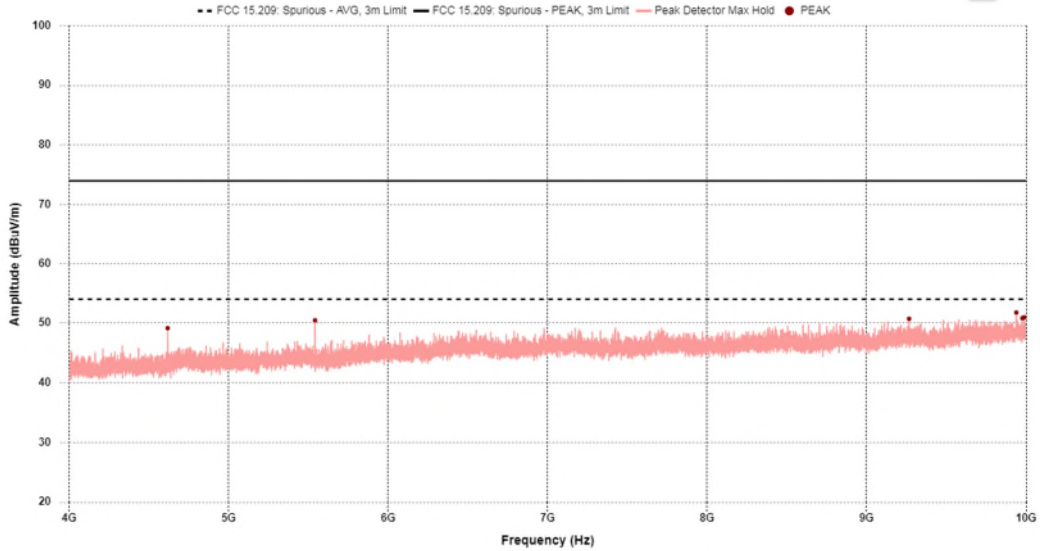

Client	Ecobee Inc.	
Product	ECB601/ECB501	
Standard(s)	RSS 247 Issue 2:2017 FCC Part 15 Subpart 15.247	

Final Measurements and Results

The EUT passed.

In accordance with 15.247(d), only frequencies exceeding the 15.209 limit that occur within the bands listed in 15.205 need to be verified with a final detector.

The measurements were maximized by rotating the turn table over a full 0-360 rotation and the antenna height was varied from 1 m to 4 m.

EUT Name		EB601				
Limit		FCC 15.209, Spurious				
Power Supply		24VAC				
Frequency (Hz)	Detector	Correction Factor (dB)	Level (dBuV/m)	QP Limit (dBuV/m)	QP Margin (dB)	Test Result
Antenna Horizontal						
178.44M	PEAK	-13.7	35.8	43.5	7.7	Pass
177.72M	PEAK	-13.7	35.3	43.5	8.2	Pass
883.32M	PEAK	5.0	37.7	46.0	8.3	Pass
170.43M	PEAK	-13.9	35.1	43.5	8.4	Pass
173.61M	PEAK	-13.7	35.0	43.5	8.5	Pass
174.33M	PEAK	-13.7	34.7	43.5	8.8	Pass
Antenna Vertical						
138.51M	QP	-16.8	27.6	43.5	15.9	Pass
136.02M	QP	-16.7	40.3	43.5	3.2	Pass
101.52M	QP	-16.4	27.1	43.5	16.4	Pass
85.59M	QP	-18.1	22.4	40.0	17.6	Pass
88.01M	QP	-18.1	35.1	40.0	4.9	Pass
498.57M	QP	-2.7	42.6	46.0	3.4	Pass
98.43M	QP	-16.6	29.2	43.5	14.3	Pass
104.01M	QP	-16.4	32.0	43.5	11.5	Pass

Client	Ecobee Inc.	 Canada
Product	ECB601/ECB501	
Standard(s)	RSS 247 Issue 2:2017 FCC Part 15 Subpart 15.247	

Test Frequency (MHz)	Detection Mode	Antenna Polarity (Horz/Vert)	Received Signal (dBµV)	Antenna Factor (dB/m)	Cable Factor (dB)	Attenuator (dB)	Pre-Amp Gain (dB)	Level (dBµV/m)	Emission Limit (dBµV/m)	Margin (dB)	Result
Low Channel -0 (920 MHz)											
1840	Peak	Horz	52.0	30.5	2.8	0.0	-34.9	50.3	74.0	23.7	PASS
1840	Avg	Horz	48.0	30.5	2.8	0.0	-34.9	46.4	54.0	7.6	PASS
1840	Peak	Vert	51.5	30.5	2.8	0.0	-34.9	49.9	74.0	24.1	PASS
1840	Avg	Vert	47.0	30.5	2.8	0.0	-34.9	45.3	54.0	8.7	PASS
2760	Peak	Horz	44.9	32.3	3.4	0.0	-34.2	46.3	74.0	27.7	PASS
2760	Avg	Horz	33.3	32.3	3.4	0.0	-34.2	34.7	54.0	19.3	PASS
2760	Peak	Vert	46.0	32.3	3.4	0.0	-34.2	47.4	74.0	26.6	PASS
2760	Avg	Vert	35.5	32.3	3.4	0.0	-34.2	36.9	54.0	17.1	PASS
3680	Peak	Horz	48.0	33.1	4.1	0.0	-32.9	52.2	74.0	21.8	PASS
3680	Avg	Horz	42.1	33.1	4.1	0.0	-32.9	46.4	54.0	7.6	PASS
3680	Peak	Vert	50.6	33.1	4.1	0.0	-32.9	54.9	74.0	19.1	PASS
3680	Avg	Vert	47.0	33.1	4.1	0.0	-32.9	51.3	54.0	2.7	PASS
4600	Peak	Horz	44.7	34.2	3.9	0.0	-32.8	50.0	74.0	24.0	PASS
4600	Avg	Horz	37.6	34.2	3.9	0.0	-32.8	42.9	54.0	11.1	PASS
4600	Peak	Vert	46.1	34.2	3.9	0.0	-32.8	51.4	74.0	22.6	PASS
4600	Avg	Vert	39.9	34.2	3.9	0.0	-32.8	45.2	54.0	8.8	PASS
5520	Peak	Horz	43.1	34.7	4.8	0.0	-32.3	50.3	74.0	23.7	PASS
5520	Avg	Horz	32.5	34.7	4.8	0.0	-32.3	39.6	54.0	14.4	PASS
5520	Peak	Vert	46.0	34.7	4.8	0.0	-32.3	53.2	74.0	20.8	PASS
5520	Avg	Vert	39.6	34.7	4.8	0.0	-32.3	46.8	54.0	7.2	PASS

Test Frequency (MHz)	Detection Mode	Antenna Polarity (Horz/Vert)	Received Signal (dBµV)	Antenna Factor (dB/m)	Cable Factor (dB)	Attenuator (dB)	Pre-Amp Gain (dB)	Level (dBµV/m)	Emission Limit (dBµV/m)	Margin (dB)	Result
Mid Channel - 24 (923.60 MHz)											
1847.2	Peak	Horz	51.5	30.5	2.8	0.0	-34.9	49.9	74.0	24.1	PASS
1847.2	Avg	Horz	47.6	30.5	2.8	0.0	-34.9	46.0	54.0	8.0	PASS
1847.2	Peak	Vert	51.1	30.5	2.8	0.0	-34.9	49.5	74.0	24.5	PASS
1847.2	Avg	Vert	47.0	30.5	2.8	0.0	-34.9	45.3	54.0	8.7	PASS
2770.8	Peak	Horz	45.5	32.3	3.4	0.0	-34.3	46.9	74.0	27.1	PASS
2770.8	Avg	Horz	33.9	32.3	3.4	0.0	-34.3	35.3	54.0	18.7	PASS
2770.8	Peak	Vert	46.9	32.3	3.4	0.0	-34.3	48.3	74.0	25.7	PASS
2770.8	Avg	Vert	35.9	32.3	3.4	0.0	-34.3	37.3	54.0	16.7	PASS
3694.4	Peak	Horz	47.4	33.1	4.2	0.0	-32.9	51.8	74.0	22.2	PASS
3694.4	Avg	Horz	42.2	33.1	4.2	0.0	-32.9	46.5	54.0	7.5	PASS
3694.4	Peak	Vert	49.5	33.1	4.2	0.0	-32.9	53.8	74.0	20.2	PASS
3694.4	Avg	Vert	45.5	33.1	4.2	0.0	-32.9	49.8	54.0	4.2	PASS
4618	Peak	Horz	45.3	34.2	4.1	0.0	-32.8	50.8	74.0	23.2	PASS
4618	Avg	Horz	37.7	34.2	4.1	0.0	-32.8	43.2	54.0	10.8	PASS
4618	Peak	Vert	46.7	34.2	4.1	0.0	-32.8	52.2	74.0	21.8	PASS
4618	Avg	Vert	39.8	34.2	4.1	0.0	-32.8	45.4	54.0	8.6	PASS
5541.6	Peak	Horz	44.0	34.7	4.7	0.0	-32.3	51.1	74.0	22.9	PASS
5541.6	Avg	Horz	36.2	34.7	4.7	0.0	-32.3	43.3	54.0	10.7	PASS
5541.6	Peak	Vert	45.9	34.7	4.7	0.0	-32.3	53.0	74.0	21.0	PASS
5541.6	Avg	Vert	39.8	34.7	4.7	0.0	-32.3	46.9	54.0	7.1	PASS

Client	Ecobee Inc.	
Product	ECB601/ECB501	
Standard(s)	RSS 247 Issue 2:2017 FCC Part 15 Subpart 15.247	

Test Frequency (MHz)	Detection Mode	Antenna Polarity (Horz/Vert)	Received Signal (dBµV)	Antenna Factor (dB/m)	Cable Factor (dB)	Attenuator (dB)	Pre-Amp Gain (dB)	Level (dBµV/m)	Emission Limit (dBµV/m)	Margin (dB)	Result
High Channel - 49 (927.35 MHz)											
1854.7	Peak	Horz	53.0	30.5	2.8	0.0	-34.9	51.4	74.0	22.6	PASS
1854.7	Avg	Horz	49.2	30.5	2.8	0.0	-34.9	47.6	54.0	6.4	PASS
1854.7	Peak	Vert	52.4	30.5	2.8	0.0	-34.9	50.8	74.0	23.2	PASS
1854.7	Avg	Vert	48.3	30.5	2.8	0.0	-34.9	46.8	54.0	7.2	PASS
2782.05	Peak	Horz	51.0	32.3	3.4	0.0	-34.3	52.3	74.0	21.7	PASS
2782.05	Avg	Horz	46.1	32.3	3.4	0.0	-34.3	47.5	54.0	6.5	PASS
2782.05	Peak	Vert	51.7	32.3	3.4	0.0	-34.3	53.1	74.0	20.9	PASS
2782.05	Avg	Vert	47.6	32.3	3.4	0.0	-34.3	49.0	54.0	5.0	PASS
3709.4	Peak	Horz	52.0	33.1	4.2	0.0	-32.9	56.5	74.0	17.5	PASS
3709.4	Avg	Horz	47.4	33.1	4.2	0.0	-32.9	51.8	54.0	2.2	PASS
3709.4	Peak	Vert	52.0	33.1	4.2	0.0	-32.9	56.4	74.0	17.6	PASS
3709.4	Avg	Vert	47.5	33.1	4.2	0.0	-32.9	51.9	54.0	2.1	PASS
4636.75	Peak	Horz	45.8	34.3	4.3	0.0	-32.7	51.6	74.0	22.4	PASS
4636.75	Avg	Horz	39.0	34.3	4.3	0.0	-32.7	44.8	54.0	9.2	PASS
4636.75	Peak	Vert	46.7	34.3	4.3	0.0	-32.7	52.5	74.0	21.5	PASS
4636.75	Avg	Vert	41.1	34.3	4.3	0.0	-32.7	46.9	54.0	7.1	PASS
5564.1	Peak	Horz	45.5	34.7	4.7	0.0	-32.3	52.5	74.0	21.5	PASS
5564.1	Avg	Horz	38.4	34.7	4.7	0.0	-32.3	45.4	54.0	8.6	PASS
5564.1	Peak	Vert	47.0	34.7	4.7	0.0	-32.3	54.0	74.0	20.0	PASS
5564.1	Avg	Vert	41.1	34.7	4.7	0.0	-32.3	48.1	54.0	5.9	PASS

Client	Ecobee Inc.	
Product	ECB601/ECB501	
Standard(s)	RSS 247 Issue 2:2017 FCC Part 15 Subpart 15.247	

Test Equipment List

Equipment	Model No.	Manufacturer	Last Calibration Date	Next Calibration Date	Asset #
Spectrum Analyzer	ESU 40	Rohde & Schwarz	Jan. 15, 2020	Jan. 15, 2022	GEMC 233
Loop Antenna	EM 6871	Electro-Metrics	Feb 26, 2021	Feb 26, 2023	GEMC 70
Loop Antenna	EM 6872	Electro-Metrics	Feb 26, 2021	Feb 26, 2023	GEMC 71
BiLog Antenna	3142-C	ETS-Lindgren	Mar. 26, 2021	Mar. 26, 2023	GEMC 137
Horn Antenna 1 – 10 GHz	3117	ETS-Lindgren	Feb. 17, 2020	Feb. 17, 2022	GEMC 340
Attenuator 6 dB	6N5W-06	Inmet	NCR	NCR	GEMC 346
Pre-Amp 9 kHz – 1 GHz	CPA9230	Chase	May 22, 2020	May 22, 2022	GEMC 301
Pre-Amp 1 – 26.5 GHz	HP 8449B	HP	Aug. 4, 2020	Aug. 4, 2022	GEMC 312
902-928MHz Notch Filter	BRC50722	Micro-Tronics	NCR	NCR	GEMC 186
0.98GHz HPF	8IH40-980	K & L Microwave	NCR	NCR	GEMC 4256
4GHz HPF	11SH10- 4000/T12000	K & L Microwave	NCR	NCR	GEMC 119
RF Cable <1GHz	LMR-400	LexTec	NCR	NCR	GEMC 27
RF Cable <1GHz	HP305S	Semflex	NCR	NCR	GEMC 310
RF Cable >1GHz	EMC2	MegaPhase	NCR	NCR	GEMC 370
Emissions Software	V2.1.0	TUV SUD Canada, Inc.	NCR	NCR	GEMC 361

Client	Ecobee Inc.	
Product	ECB601/ECB501	
Standard(s)	RSS 247 Issue 2:2017 FCC Part 15 Subpart 15.247	

Power Line Conducted Emissions

Purpose

The purpose of this test is to ensure that the RF energy unintentionally emitted from the EUT's power line does not exceed the limits listed below as defined in the applicable test standard and measured from a LISN. This helps protect lower frequency radio services such as AM radio, shortwave radio, amateur radio, maritime radio, CB radio, and so on, from unwanted interference.

Limits & Method

The method is as defined in ANSI C63.10. The limits are as defined in FCC Part 15 Section 15.107 and ICES-003 Section 6.1:

Average Limits		Quasi-Peak Limits	
150 kHz – 500 kHz	56 to 46* dB μ V	150 kHz – 500 kHz	66 to 56* dB μ V
500 kHz – 5 MHz	46 dB μ V	500 kHz – 5 MHz	56 dB μ V
5 MHz – 30 MHz	50 dB μ V	5 MHz – 30 MHz	60 dB μ V

* Decreases linearly with the logarithm of the frequency

Both Quasi-Peak and Average limits are applicable, and each is specified as being measured with a resolution bandwidth of 9 kHz. For Quasi-Peak, a video bandwidth at least three times greater than the resolution bandwidth is used.

If the Peak or Quasi-Peak detector measurements do not exceed the Average limits, then the EUT is deemed to have passed the requirements.

Client	Ecobee Inc.	
Product	ECB601/ECB501	
Standard(s)	RSS 247 Issue 2:2017 FCC Part 15 Subpart 15.247	

Typical Setup Diagram

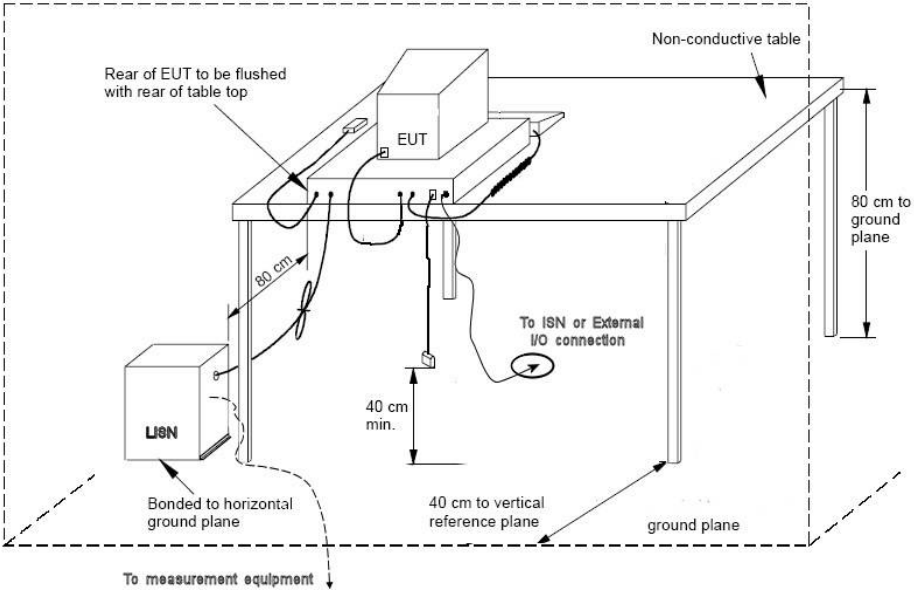

Measurement Uncertainty

The expanded measurement uncertainty is calculated in accordance with CISPR 16-4-2 and is $\pm 2.27\text{dB}$ with a 'k=2' coverage factor and a 95% confidence level.

Preliminary Graphs

The graphs shown below are maximized peak measurement graphs measured with a resolution bandwidth greater than or equal to the final required detector. This peaking process is done as a worst case measurement and enables the detection of frequencies of concern for final measurement. For final measurements with the appropriate detector, where applicable, please refer to the tables under Final Measurements.

Client	Ecobee Inc.	
Product	ECB601/ECB501	
Standard(s)	RSS 247 Issue 2:2017 FCC Part 15 Subpart 15.247	

Line (L) – 120Vac 60Hz

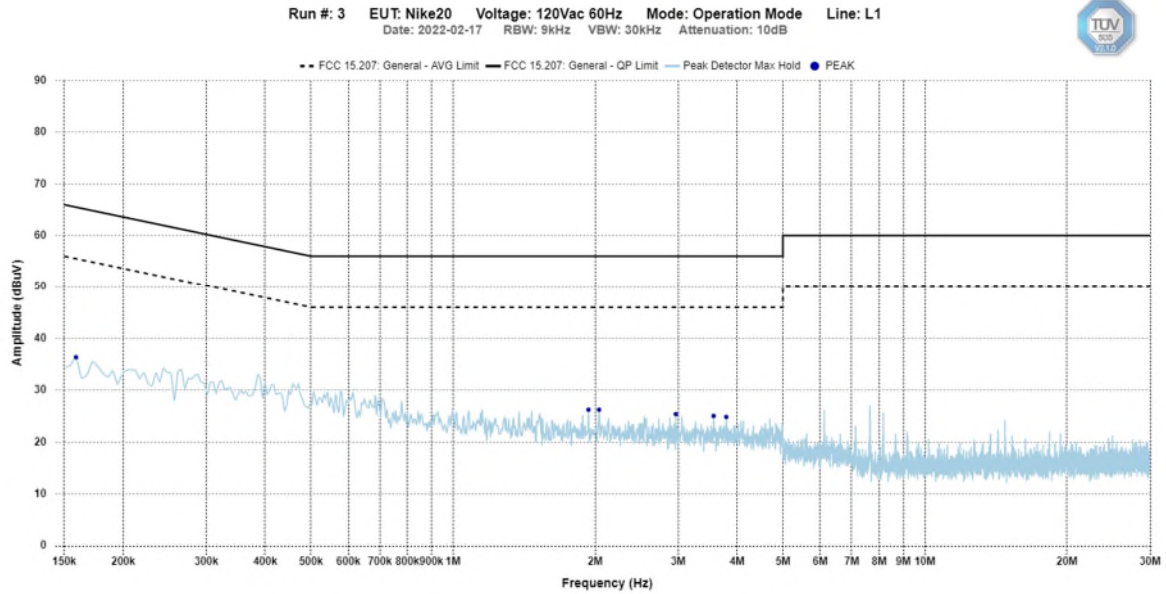

Neutral (N) – 120Vac 60Hz

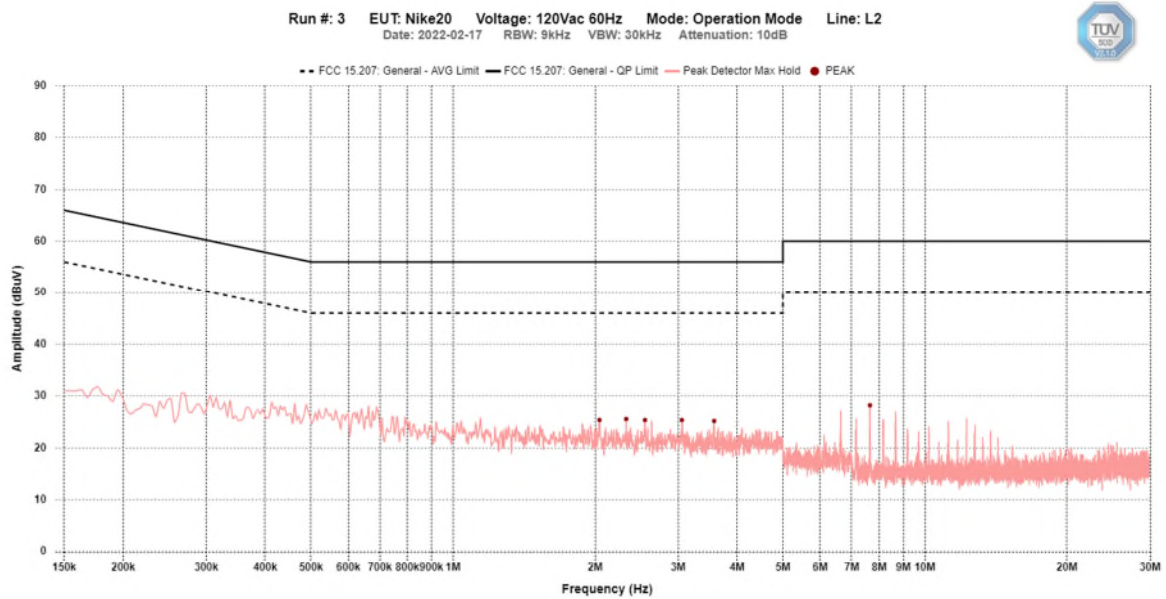

Client	Ecobee Inc.	
Product	ECB601/ECB501	
Standard(s)	RSS 247 Issue 2:2017 FCC Part 15 Subpart 15.247	

Final Measurements

Note a step-down transformer was used to provide 24Vac to the EUT.

Average and Quasi-Peak Emissions Table

EUT Name		EB-STATE3LT02						
Limit		FCC 15.207, General						
Power Supply		120Vac 60Hz						
Frequency (Hz)	Detector	Correction Factor (dB)	Level (dBuV)	QP Limit (dBuV)	AVG Limit (dBuV)	QP Margin (dB)	AVG Margin (dB)	Test Result
Line 1								
158.9104k	PEAK	10.1	36.4	65.7	55.7	29.4	19.4	Pass
2.039M	PEAK	10.2	26.2	56.0	46.0	29.8	19.8	Pass
1.9365M	PEAK	10.2	26.2	56.0	46.0	29.8	19.8	Pass
2.9657M	PEAK	10.2	25.4	56.0	46.0	30.6	20.6	Pass
3.5672M	PEAK	10.2	25.0	56.0	46.0	31.0	21.0	Pass
3.7944M	PEAK	10.2	24.8	56.0	46.0	31.2	21.2	Pass
Line 2								
2.3286M	PEAK	10.2	25.6	56.0	46.0	30.4	20.4	Pass
2.0435M	PEAK	10.2	25.4	56.0	46.0	30.6	20.6	Pass
2.5514M	PEAK	10.2	25.4	56.0	46.0	30.6	20.6	Pass
3.0548M	PEAK	10.2	25.4	56.0	46.0	30.6	20.6	Pass
3.5761M	PEAK	10.2	25.2	56.0	46.0	30.8	20.8	Pass
7.6481M	PEAK	10.2	28.2	60.0	50.0	31.8	21.8	Pass

Note:

Peak = Peak measurement

AVG = Average measurement

QP = Quasi-Peak measurement

See 'Appendix B – EUT, Peripherals and Test Setup Photos' for photos showing the test set-up for the highest line conducted emission

Client	Ecobee Inc.	
Product	ECB601/ECB501	
Standard(s)	RSS 247 Issue 2:2017 FCC Part 15 Subpart 15.247	

Test Equipment List

Equipment	Model No.	Manufacturer	Last Calibration Date	Next Calibration Date	Asset #
Spectrum Analyzer	ESL 6	Rohde & Schwarz	Feb. 12, 2021	Feb. 12, 2023	GEMC 160
LISN	FCC-LISN-50/250-16-2-01	FCC	Feb. 10, 2021	Feb. 10, 2023	GEMC 303
RF Cable 3m	LMR-400-3M-50Ω-MN-MN	LexTec	NCR	NCR	GEMC 276
Attenuator 10 dB	6N10W-10	Inmet	NCR	NCR	GEMC 348
Emissions Software	V2.1.0	TUV SUD Canada, Inc.	NCR	NCR	GEMC 361

FCC_ICES003_PLCE_Rev1

Client	Ecobee Inc.	
Product	ECB601/ECB501	
Standard(s)	RSS 247 Issue 2:2017 FCC Part 15 Subpart 15.247	

Appendix A – EUT Summary

Client	Ecobee Inc.	
Product	ECB601/ECB501	
Standard(s)	RSS 247 Issue 2:2017 FCC Part 15 Subpart 15.247	

For further details for filing purposes, refer to filing package.

General EUT Description

Client	
Organization / Address	Ecobee Inc. 25 Dockside Drive. Suite 700 Toronto, ON. M5A 0B5, Canada
Contact	John Russomanno
Phone	416-809-2405
Email	johnr@ecobee.com
EUT Details	
EUT Name	ECB601/ECB501
FCC ID	WR955470766937
IC	7981A-55470766937
Equipment Category	Unlicensed transmitter
Basic EUT Functionality	EUT is a smart thermostat that have a 2400 – 2483.5 MHz DTS (802.11 b/g/n) and FHSS transmitters and a 902 – 928 MHz FHSS/Hybrid transmitter. 5150-5250 MHz and 5725-5850 MHz UNII transmitter.
Input Voltage and Frequency	24 Vac 60 Hz
Connectors available on EUT	1 (terminals for HVAC control)
Peripherals Required for Test	120 Vac – 24 Vac step down transformer.
Release type	Final
Intentional Radiator Frequency Range	2400 – 2483.5 MHz for DTS and FHSS 902 – 928 MHz FHSS/Hybrid 5150-5250 MHz and 5725-5850 MHz UNII transmitter.
Antenna	Flexible PCB antennas
Type of Transmitter	Hybrid, Frequency Hopping and Digitally Modulated
Modulation	FSK for Sub Gig Various for 2.4 GHz 802.11 b/g/n, FSK, etc
EUT Configuration	Test software was configured to transmit continuously at 100% duty cycle and to control

Client	Ecobee Inc.	
Product	ECB601/ECB501	
Standard(s)	RSS 247 Issue 2:2017 FCC Part 15 Subpart 15.247	

	hopping through its pseudo random sequence or single channel. Channels tested: Lowest and Highest
--	--

Note the EUT is considered to have been received the date of the commencement of the first test, unless otherwise stated. For a close-up picture of the EUT, see ‘Appendix B – EUT and Test Setup Photos’.

Client	Ecobee Inc.	
Product	ECB601/ECB501	
Standard(s)	RSS 247 Issue 2:2017 FCC Part 15 Subpart 15.247	

Appendix B – EUT and Test Setup Photos

Refer to the files separate from this test report