

# RF TEST REPORT

<b>Applicant</b>	ID TECH
<b>FCC ID</b>	WQJ-VP6825LE
<b>Product</b>	VP6825
<b>Brand</b>	ID TECH
<b>Model</b>	VP6825-8101; VP6825-8101D
<b>Report No.</b>	R2307A0810-R7
<b>Issue Date</b>	August 22, 2023

TA Technology (Shanghai) Co., Ltd. tested the above equipment in accordance with the requirements in **FCC CFR47 Part 15E (2022)**. The test results show that the equipment tested is capable of demonstrating compliance with the requirements as documented in this report.

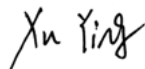

Prepared by: Xu Ying



Approved by: Xu Kai

---

## TA Technology (Shanghai) Co., Ltd.

Building 3, No.145, Jintang Rd, Pudong Shanghai, P.R.China

TEL: +86-021-50791141/2/3

FAX: +86-021-50791141/2/3-8000

## TABLE OF CONTENT

1.	Test Laboratory .....	4
1.1.	Notes of the test report.....	4
1.2.	Test facility .....	4
1.3.	Testing Location.....	4
2.	General Description of Equipment under Test.....	5
2.1.	Applicant and Manufacturer Information.....	5
2.2.	General information.....	5
3.	Applied Standards .....	7
4.	Test Configuration .....	8
5.	Test Case Results .....	10
5.1.	Unwanted Emission .....	10
5.2.	Conducted Emission .....	107
6.	Main Test Instruments.....	110
	ANNEX A: The EUT Appearance .....	111
	ANNEX B: Test Setup Photos .....	112

## Summary of measurement results

Number	Test Case	Clause in FCC rules	Verdict
1	Unwanted Emissions	15.407(b)	PASS
2	Conducted Emissions	15.207	PASS
Date of Testing: (Original) November 2, 2022 ~ December 29, 2022 and January 11, 2023 ~ February 2, 2023			
Date of Sample Received: (Original) October 13, 2022			
Note: PASS: The EUT complies with the essential requirements in the standard. FAIL: The EUT does not comply with the essential requirements in the standard. All indications of Pass/Fail in this report are opinions expressed by TA Technology (Shanghai) Co., Ltd. based on interpretations and/or observations of test results. Measurement Uncertainties were not taken into account and are published for informational purposes only.			

**VP6825-8101; VP6825-8101D (Report No.: R2307A0810-R7) is a variant model of VP6825-8100; VP6825-8100D (FCC ID: WQJ-VP6825L; Report No.: R2210A0932-R7V1).**

**For VP6825-8101; VP6825-8101D, test values all duplicated from Original for variant. There is no test for VP6825-8101; VP6825-8101D in this report.**

**For VP6825-8100; VP6825-8100D, only test Unwanted Emissions and Conducted Emissions.**

**Other test items refer to the module report (FCC ID: VPYLBEE5HY1MW; Report No.: 1802WSU008-U4).**

## 1. Test Laboratory

### 1.1. Notes of the test report

This report shall not be reproduced in full or partial, without the written approval of **TA Technology (Shanghai) Co., Ltd.** The results documented in this report apply only to the tested sample, under the conditions and modes of operation as described herein. Measurement Uncertainties were not taken into account and are published for informational purposes only. This report is written to support regulatory compliance of the applicable standards stated above.

### 1.2. Test facility

#### **FCC (Designation number: CN1179, Test Firm Registration Number: 446626)**

TA Technology (Shanghai) Co., Ltd. has been listed on the US Federal Communications Commission list of test facilities recognized to perform electromagnetic emissions measurements.

#### **A2LA (Certificate Number: 3857.01)**

TA Technology (Shanghai) Co., Ltd. has been listed by American Association for Laboratory Accreditation to perform electromagnetic emission measurement.

### 1.3. Testing Location

Company: TA Technology (Shanghai) Co., Ltd.

Address: Building 3, No.145, Jintang Rd, Pudong Shanghai, P.R.China

City: Shanghai

Post code: 201201

Country: P. R. China

Contact: Xu Kai

Telephone: +86-021-50791141/2/3

Fax: +86-021-50791141/2/3-8000

Website: <http://www.ta-shanghai.com>

E-mail: [xukai@ta-shanghai.com](mailto:xukai@ta-shanghai.com)

## 2. General Description of Equipment under Test

### 2.1. Applicant and Manufacturer Information

<b>Applicant</b>	ID TECH
<b>Applicant address</b>	10721 Walker Street, Cypress, California 90630, United States
<b>Manufacturer</b>	ID TECH TAIWAN
<b>Manufacturer address</b>	No. 16, Lane 22, GaoQing Rd., YanMei Dist., TaoYuan City 326, Taiwan

### 2.2. General information

EUT Description	
Model	VP6825-8101; VP6825-8101D
SN	(Original) 226K000755
Hardware Version	Rev.A
Software Version	v1.00
Power Supply	External power supply
Antenna Type	PIFA Antenna
Antenna Connector	A permanently attached antenna (meet with the standard FCC Part 15.203 requirement)
Antenna Gain	1.50 dBi
Operating Frequency Range(s)	U-NII-1: 5150MHz-5250MHz U-NII-2A: 5250MHz -5350MHz U-NII-2C: 5470MHz-5725MHz U-NII-3: 5725MHz -5850MHz
Modulation Type	802.11a: OFDM 802.11n(HT20/HT40): OFDM 802.11ac (VHT20/VHT40/VHT80): OFDM
Testing temperature range	-20 ° C to 50° C
Operating temperature range	-20 ° C to 70 ° C
Operating voltage range	4.75 V to 5.25 V
State DC voltage	DC 5 V

Note:

1. The EUT is sent from the applicant to TA and the information of the EUT is declared by the applicant.
2. This device support automatically discontinue transmission, while the device is not transmitting any information, the device can automatically discontinue transmission and become standby mode for power saving. The device can detect the controlling signal of ACK message transmitting from remote device and verify whether it shall resend or discontinue

transmission.

3. (a) Manufacturers implements security features in any digitally modulated devices capable of operating in any of the U-NII bands, so that third parties are not able to reprogram the device to operate outside the parameters for which the device was certified. The software prevents the user from operating the transmitter with operating frequencies, output power, modulation types or other radio frequency parameters outside those that were approved for the device.

Manufacturers uses means including, but not limited to the use of a private network that allows only authenticated users to download software, electronic signatures in software or coding in hardware that is decoded by software to verify that new software can be legally loaded into a device to meet these requirements and must describe the methods in their application for equipment authorization.

(b) Manufacturers take steps to ensure that DFS functionality cannot be disabled by the operator of the U-NII device.

4. VP6825-8100 and VP6825-8100D are the same except for different models.

### 3. Applied Standards

According to the specifications of the manufacturer, it must comply with the requirements of the following standards:

**Test standards:**

**FCC CFR47 Part 15E (2022)** Unlicensed National Information Infrastructure Devices

**ANSI C63.10-2013**

**Reference standard:**

**KDB 789033 D02 General UNII Test Procedures New Rules v02r01**

## 4. Test Configuration

### Test Mode

The EUT has been associated with peripherals and configuration operated in a manner tended to maximize its emission characteristics in a typical application.

The radiated emission was measured in the following position: EUT stand-up position (Z axis), lie-down position (X, Y axis). The worst emission was found in stand-up position (Z axis) and the worst case was recorded.

In order to find the worst case condition, Pre-tests are needed at the presence of different data rate. Preliminary tests have been done on all the configuration for confirming worst case. Data rate below means worst-case rate of each test item.

Worst-case data rates are shown as following table.

Mode	Data Rate
802.11a	6 Mbps
802.11n HT20	MCS0
802.11n HT40	MCS0
802.11ac VHT20	MCS0
802.11ac VHT40	MCS0
802.11ac VHT80	MCS0



**Wireless Technology and Frequency Range**

Wireless Technology		Bandwidth	Channel	Frequency	
Wi-Fi	U-NII-1	20 MHz	36	5180MHz	
			44	5220MHz	
			48	5240MHz	
		40 MHz	38	5190MHz	
			46	5230MHz	
			42	5210MHz	
	U-NII-2A	20 MHz	52	5260MHz	
			60	5300MHz	
			64	5320MHz	
		40 MHz	54	5270MHz	
			62	5310MHz	
			58	5290MHz	
	U-NII-2C	20 MHz	100	5500MHz	
			116	5580MHz	
			120	5600MHz	
			140	5700MHz	
			144	5720MHz	
		40 MHz	102	5510MHz	
			110	5550MHz	
			118	5590MHz	
			134	5670MHz	
142			5710MHz		
80 MHz		106	5530MHz		
		122	5610MHz		
		138	5690MHz		
		U-NII-3	20 MHz	149	5745MHz
				157	5785MHz
165	5825MHz				
40 MHz	151	5755MHz			
	159	5795MHz			
80 MHz	155	5775MHz			
Does this device support TPC Function? <input type="checkbox"/> Yes <input checked="" type="checkbox"/> No					
Does this device support TDWR Band? <input checked="" type="checkbox"/> Yes <input type="checkbox"/> No					

## 5. Test Case Results

### 5.1. Unwanted Emission

#### Ambient condition

Temperature	Relative humidity
20°C ~ 25°C	45% ~ 50%

#### Method of Measurement

The test set-up was made in accordance to the general provisions of ANSI C63.10. The Equipment Under Test (EUT) was set up on a non-conductive table in the semi-anechoic chamber. The test was performed at the distance of 3 m between the EUT and the receiving antenna. The radiated emissions measurements were made in a typical installation configuration.

Sweep the whole frequency band range from 9kHz to the 10th harmonic of the carrier, and the emissions less than 20 dB below the permissible value are reported.

During the test, the height of receive antenna shall be moved from 1 to 4 meters, and the antenna shall be performed under horizontal and vertical polarization. The turntable shall be rotated from 0 to 360 degrees for detecting the maximum of radiated spurious signal level. The measurements shall be repeated with orthogonal polarization of the test antenna. The data of cable loss and antenna factor has been calibrated in full testing frequency range before the testing.

Set the spectrum analyzer in the following:

9kHz~150 kHz

RBW=200Hz, VBW=1kHz/ Sweep=AUTO

150 kHz~30MHz

RBW=9KHz, VBW=30KHz,/ Sweep=AUTO

Below 1GHz

RBW=100kHz / VBW=300kHz / Sweep=AUTO

a) Peak emission levels are measured by setting the instrument as follows:

Above 1GHz

PEAK: RBW=1MHz VBW=3MHz/ Sweep=AUTO

b) Average emission levels are measured by setting the instrument as follows:

Above 1GHz

AVERAGE: RBW=1MHz / VBW=3MHz / Sweep=AUTO

c) Detector: The measurements employing a CISPR quasi-peak detector except for the frequency bands 9-90 kHz, 110-490 kHz and above 1000 MHz. Radiated emission limits in these three bands are based on measurements employing an average detector.

d) Averaging type = power (i.e., rms) (As an alternative, the detector and averaging type may be set for linear voltage averaging. Some instruments require linear display mode to use linear voltage averaging. Log or dB averaging shall not be used.)

e) Sweep time = auto.

f) Perform a trace average of at least 100 traces if the transmission is continuous. If the transmission

is not continuous, then the number of traces shall be increased by a factor of  $1 / D$ , where  $D$  is the duty cycle. For example, with 50% duty cycle, at least 200 traces shall be averaged. (If a specific emission is demonstrated to be continuous—i.e., 100% duty cycle—then rather than turning ON and OFF with the transmit cycle, at least 100 traces shall be averaged.)

g) If tests are performed with the EUT transmitting at a duty cycle less than 98%, then a correction factor shall be added to the measurement results prior to comparing with the emission limit, to compute the emission level that would have been measured had the test been performed at 100% duty cycle. The correction factor is computed as follows:

1) If power averaging (rms) mode was used in the preceding step e), then the correction factor is  $[10 \log (1 / D)]$ , where  $D$  is the duty cycle. For example, if the transmit duty cycle was 50%, then 3 dB shall be added to the measured emission levels.

2) If linear voltage averaging mode was used in the preceding step e), then the correction factor is  $[20 \log (1 / D)]$ , where  $D$  is the duty cycle. For example, if the transmit duty cycle was 50%, then 6 dB shall be added to the measured emission levels.

3) If a specific emission is demonstrated to be continuous (100% duty cycle) rather than turning ON and OFF with the transmit cycle, then no duty cycle correction is required for that emission.

Reduce the video bandwidth until no significant variations in the displayed signal are observed in subsequent traces, provided the video bandwidth is no less than 1 Hz. For regulatory requirements that specify averaging only over the transmit duration (e.g., digital transmission system [DTS] and Unlicensed National Information Infrastructure [U-NII]), the video bandwidth shall be greater than  $[1 / (\text{minimum transmitter on time})]$  and no less than 1 Hz.

The field strength of spurious emission was measured in the following position: EUT stand-up position (Z axis), lie-down position (X, Y axis). The worst emission was found in stand-up position (Z axis) and the loop antenna is vertical, others antenna are vertical and horizontal.

The test is in transmitting mode.

Test setup

9KHz~ 30MHz

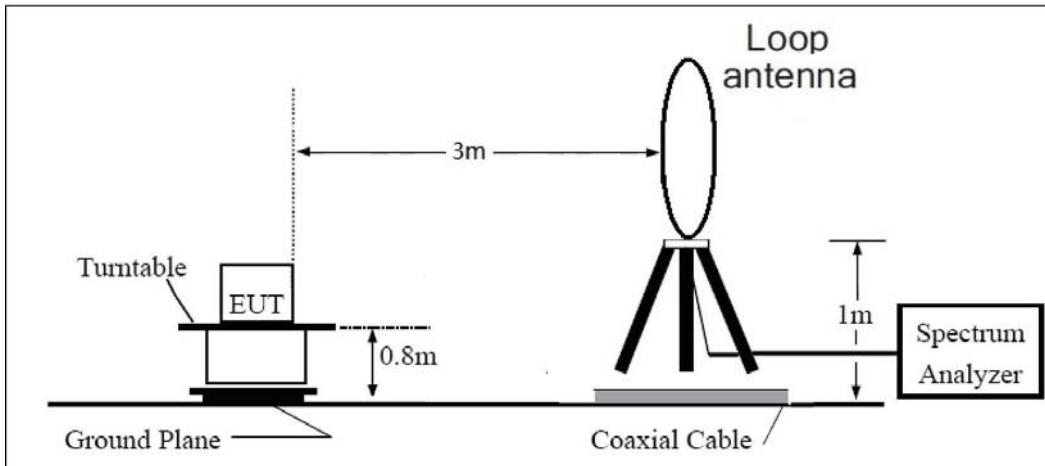

30MHz~ 1GHz

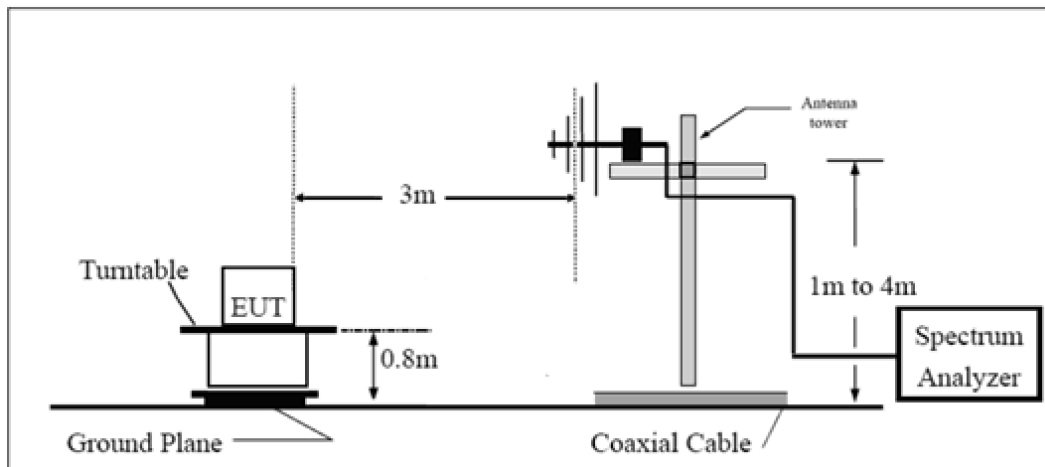

Above 1GHz

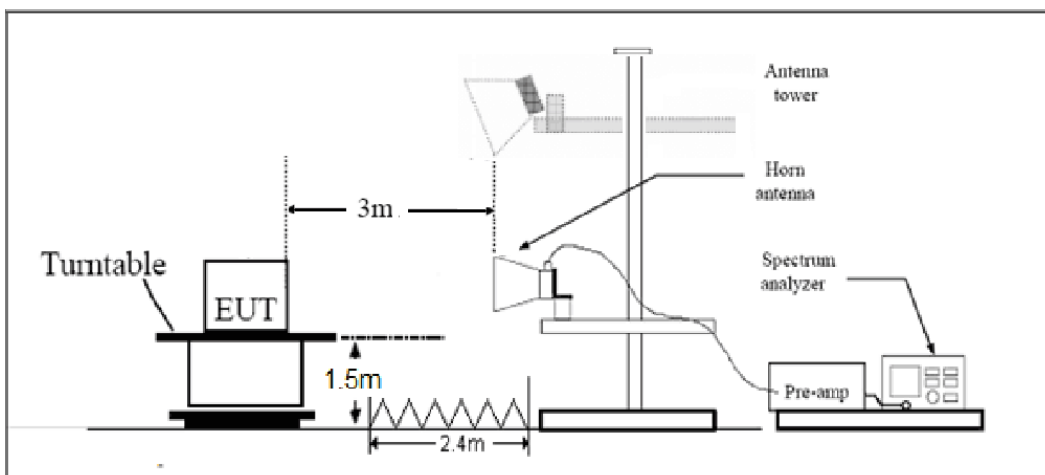

Note: Area side:2.4mX3.6m

## Limits

- (1) For transmitters operating in the 5725-5850 MHz band: All emissions shall be limited to a level of  $-27$  dBm/MHz at 75 MHz or more above or below the band edge increasing linearly to 10 dBm/MHz at 25 MHz above or below the band edge, and from 25 MHz above or below the band edge increasing linearly to a level of 15.6 dBm/MHz at 5 MHz above or below the band edge, and from 5 MHz above or below the band edge increasing linearly to a level of 27 dBm/MHz at the band edge.
- (2) For transmitters operating in the 5.15-5.25 GHz band: All emissions outside of the 5.15-5.35 GHz band shall not exceed an e.i.r.p. of  $-27$  dBm/MHz(68.2dB $\mu$ V/m).
- (3) For transmitters operating in the 5.25-5.35 GHz band: All emissions outside of the 5.15-5.35 GHz band shall not exceed an e.i.r.p. of  $-27$  dBm/MHz(68.2dB $\mu$ V/m).
- (4) For transmitters operating in the 5.47-5.725 GHz band: All emissions outside of the 5.47-5.725 GHz band shall not exceed an e.i.r.p. of  $-27$  dBm/MHz(68.2dB $\mu$ V/m).

Note: the following formula is used to convert the EIRP to field strength

§1、 $E[\text{dB}\mu\text{V}/\text{m}] = \text{EIRP}[\text{dBm}] - 20 \log(d[\text{meters}]) + 104.77$ , where E = field strength and

d = distance at which field strength limit is specified in the rules;

§2、 $E[\text{dB}\mu\text{V}/\text{m}] = \text{EIRP}[\text{dBm}] + 95.2$ , for d = 3 meters

- (5) Unwanted spurious emissions fallen in restricted bands per FCC Part15.205 shall comply with the general field strength limits set forth in § 15.209 as below table.

Frequency of emission (MHz)	Field strength( $\mu$ V/m)	Field strength(dB $\mu$ V/m)
0.009–0.490	2400/F(kHz)	/
0.490–1.705	24000/F(kHz)	/
1.705–30.0	30	/
30-88	100	40
88-216	150	43.5
216-960	200	46
Above960	500	54

MHz	MHz	MHz	GHz
0.090 - 0.110	16.42 - 16.423	399.9 - 410	4.5 - 5.15
0.495 - 0.505	16.69475 - 16.69525	608 - 614	5.35 - 5.46
2.1735 - 2.1905	16.80425 - 16.80475	960 - 1240	7.25 - 7.75
4.125 - 4.128	25.5 - 25.67	1300 - 1427	8.025 - 8.5
4.17725 - 4.17775	37.5 - 38.25	1435 - 1626.5	9.0 - 9.2
4.20725 - 4.20775	73 - 74.6	1645.5 - 1646.5	9.3 - 9.5
6.215 - 6.218	74.8 - 75.2	1660 - 1710	10.6 - 12.7
6.26775 - 6.26825	108 - 121.94	1718.8 - 1722.2	13.25 - 13.4
6.31175 - 6.31225	123 - 138	2200 - 2300	14.47 - 14.5
8.291 - 8.294	149.9 - 150.05	2310 - 2390	15.35 - 16.2
8.362 - 8.366	156.52475 - 156.52525	2483.5 - 2500	17.7 - 21.4
8.37625 - 8.38675	156.7 - 156.9	2690 - 2900	22.01 - 23.12
8.41425 - 8.41475	162.0125 - 167.17	3260 - 3267	23.6 - 24.0
12.29 - 12.293	167.72 - 173.2	3332 - 3339	31.2 - 31.8
12.51975 - 12.52025	240 - 285	3345.8 - 3358	36.43 - 36.5
12.57675 - 12.57725	322 - 335.4	3600 - 4400	( <sup>2</sup> )
13.36 - 13.41			

### Measurement Uncertainty

The assessed measurement uncertainty to ensure 95% confidence level for the normal distribution is with the coverage factor  $k = 1.96$ .

Frequency	Uncertainty
9KHz-30MHz	3.55 dB
30MHz-200MHz	4.17 dB
200MHz-1GHz	4.84 dB
1-18GHz	4.35 dB
18-26.5GHz	5.90 dB
26.5GHz~40GHz	5.92 dB

**Test Results:**

A symbol (dB V/) in the test plot below means (dBμV/m)

**The signal beyond the limit is carrier.**

**U-NII-1**

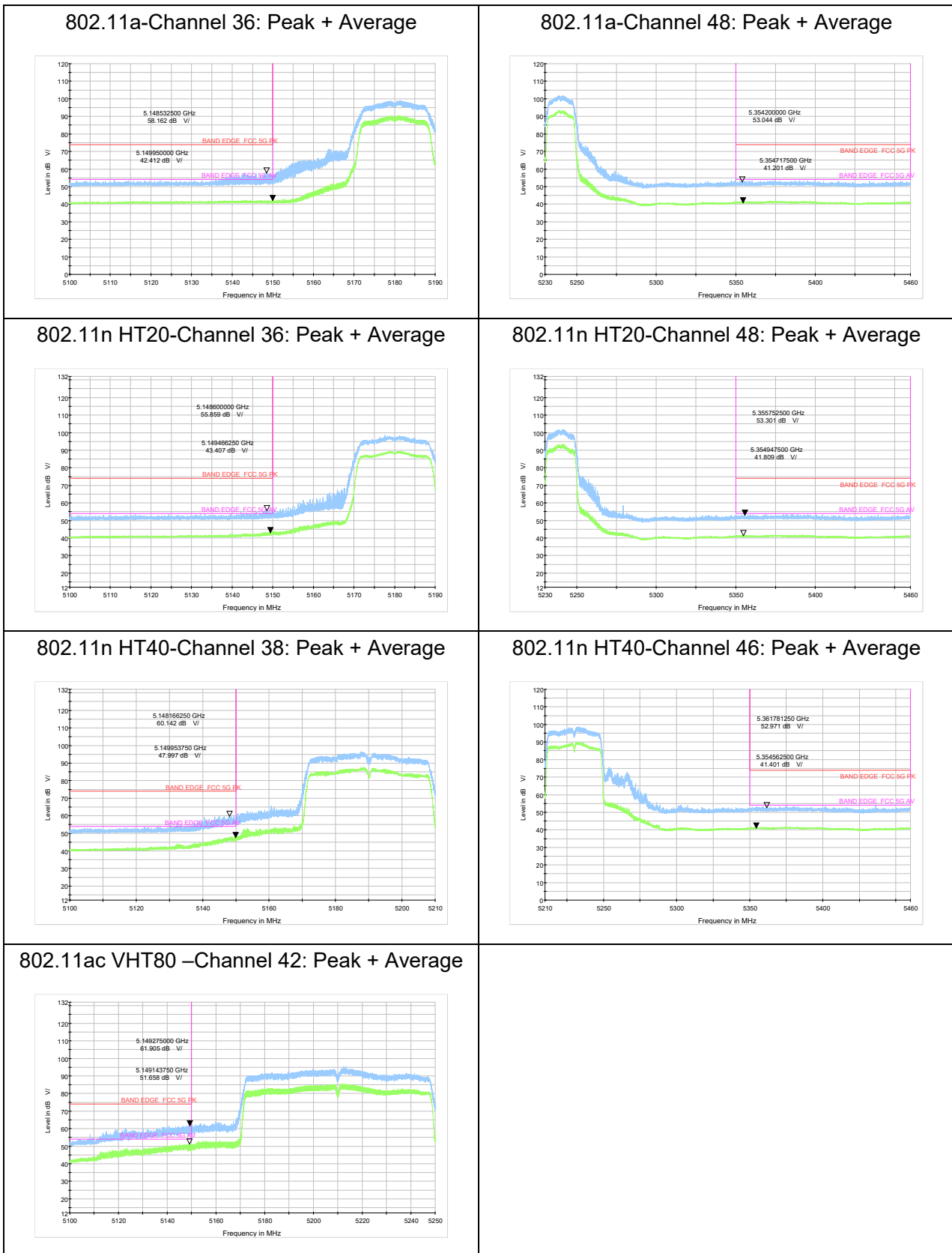

U-NII-2A

802.11a-Channel 52: Peak + Average

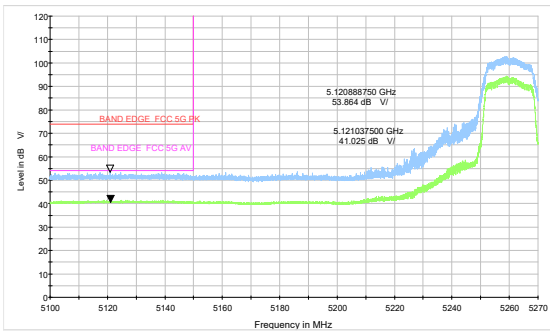

802.11a-Channel 64: Peak + Average

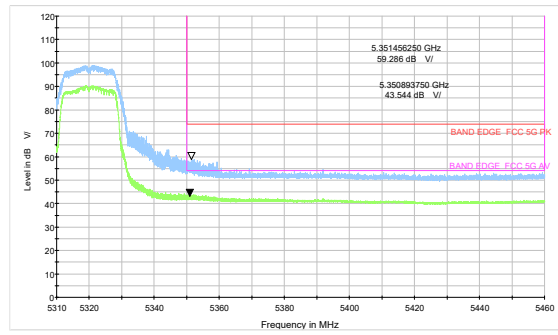

802.11n HT20-Channel 52: Peak + Average

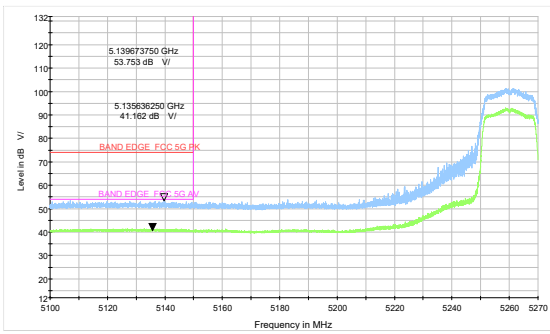

802.11n HT20-Channel 64: Peak + Average

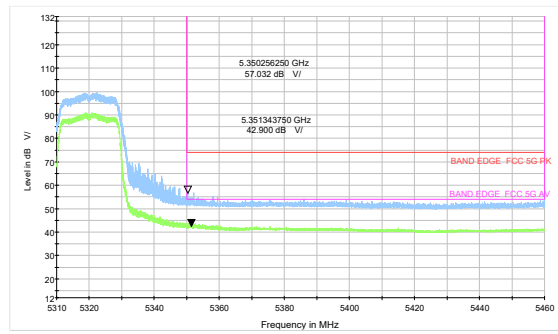

802.11n HT40-Channel 54: Peak + Average

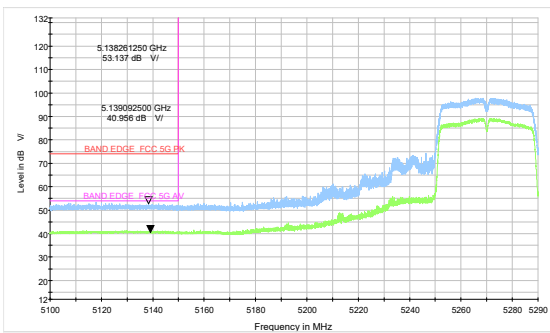

802.11n HT40-Channel 62: Peak + Average

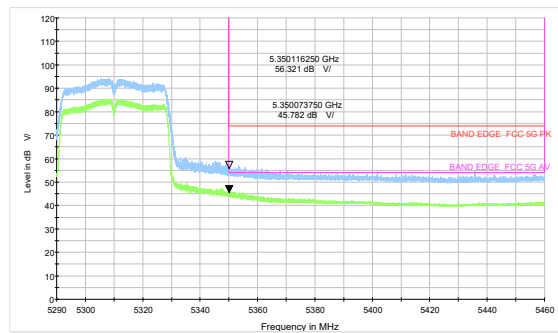

802.11ac VHT80 -Channel 58: Peak + Average

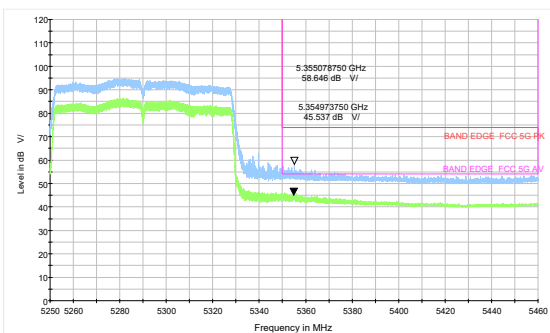



U-NII-2C

802.11a-Channel 100: Peak + Average

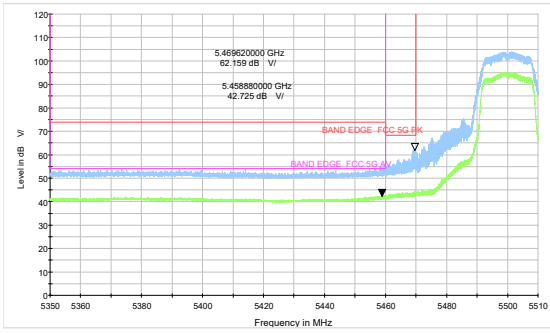

802.11n HT20-Channel 100: Peak + Average

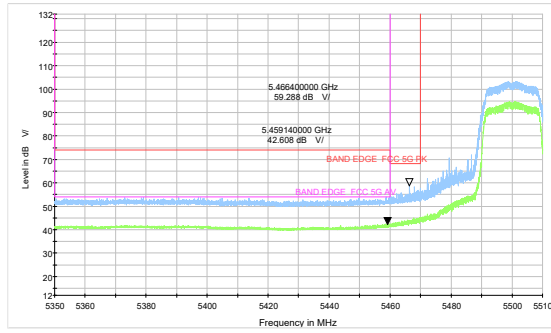

802.11a-Channel 140: Peak

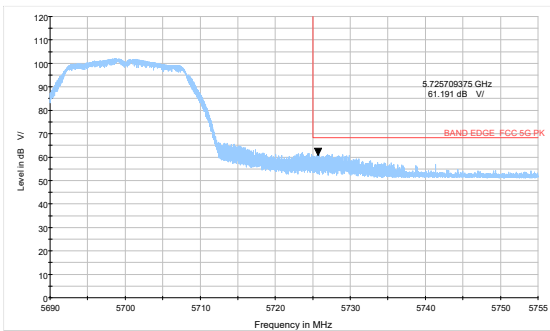

802.11n HT20-Channel 140: Peak

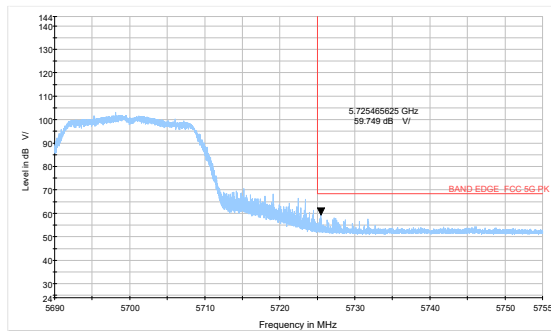

802.11a-Channel 144: Peak

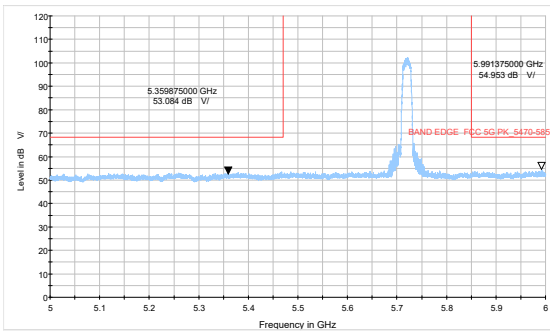

802.11n HT20-Channel 144: Peak

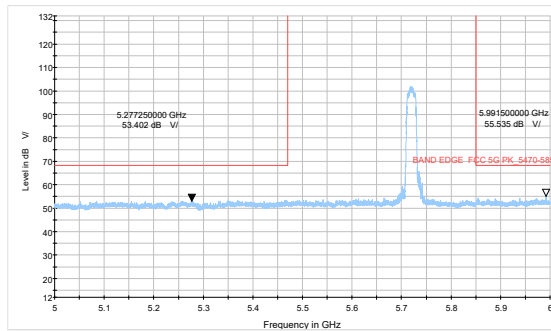

802.11n HT40-Channel 102: Peak + Average

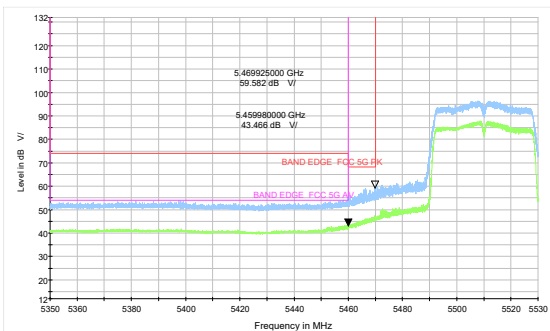

802.11n HT40-Channel 134: Peak

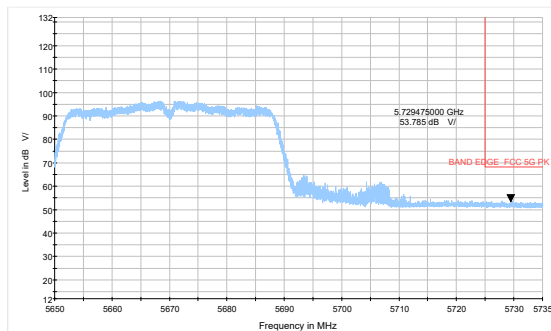

802.11n HT40-Channel 142: Peak

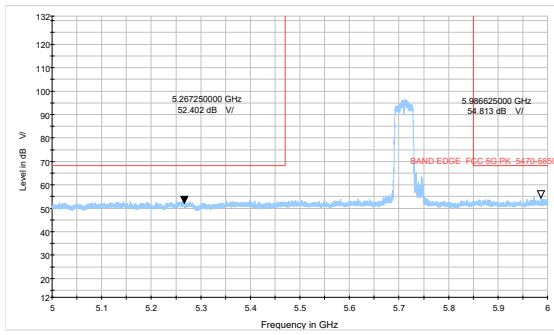

802.11ac VHT80 –Channel 106: Peak + Average

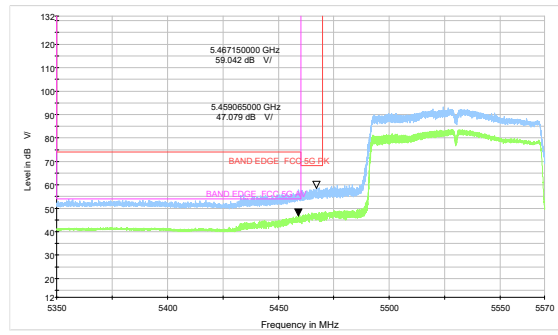

802.11ac VHT80 –Channel 122: Peak

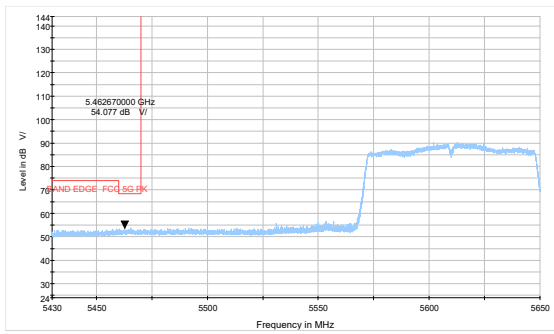

802.11ac VHT80 –Channel 138: Peak

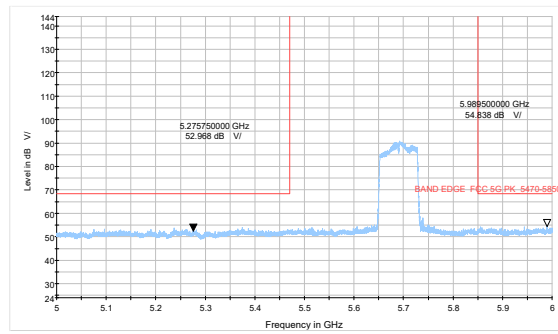

U-NII-3

802.11a-Channel 149: Peak

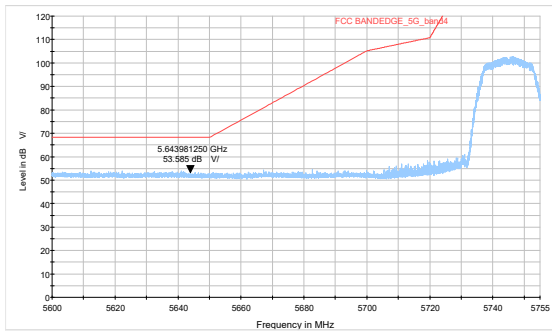

802.11a-Channel 165: Peak

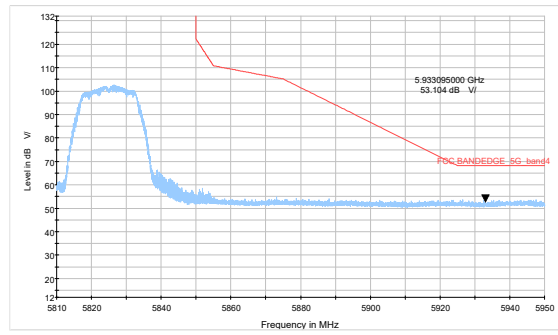

802.11n HT20-Channel 149: Peak

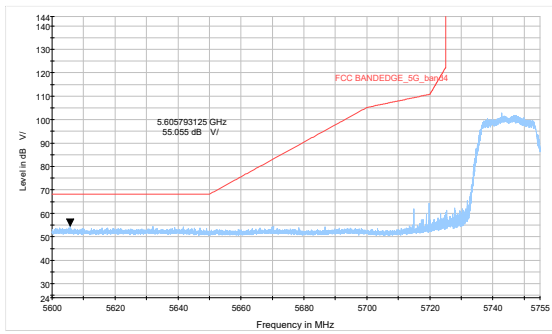

802.11n HT20-Channel 165: Peak

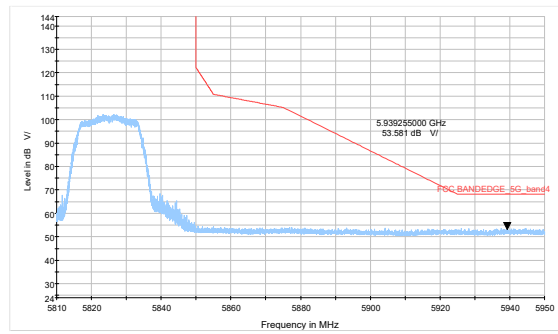

802.11n HT40-Channel 151: Peak

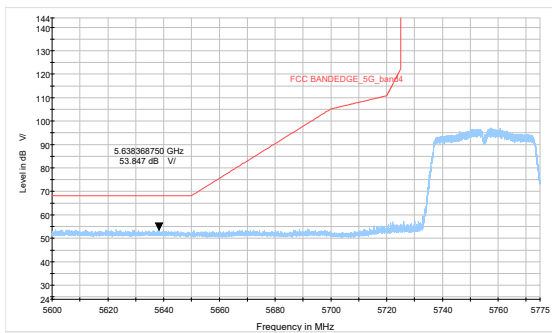

802.11n HT40-Channel 159: Peak

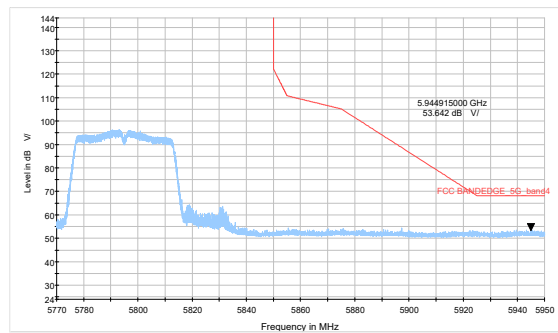

802.11ac VHT80-Channel 155: Peak

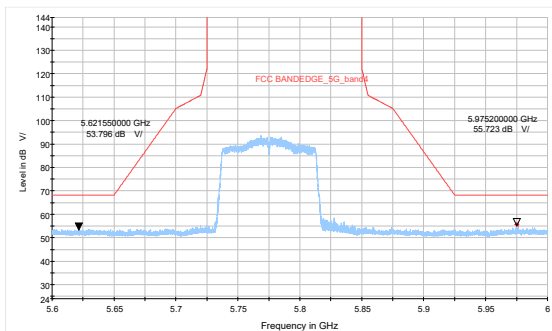

**Result of RE**

**Test result**

Sweep the whole frequency band through the range from 9kHz to the 10th harmonic of the carrier, the Emissions in the frequency band 9kHz-30MHz and 26.5GHz-40GHz are more than 20dB below the limit are not reported.

A symbol (dB V/) in the test plot below means (dBμV/m)

During the test, the Radiates Emission from 30MHz to 1GHz was performed in all modes with all channels, 802.11n (HT40) CH118 are selected as the worst condition. The test data of the worst-case condition was recorded in this report.

**Continuous TX mode:**

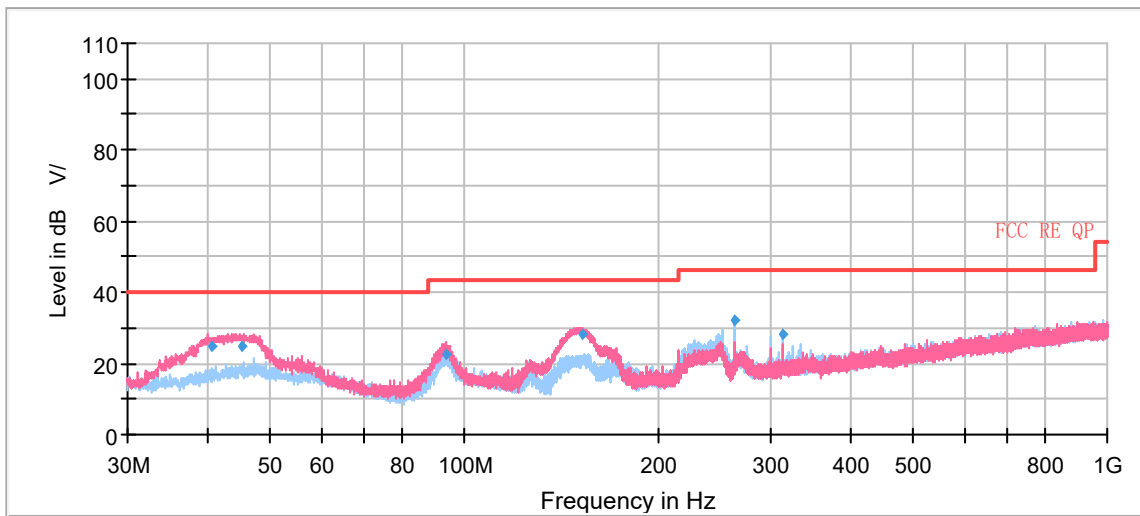

Radiates Emission from 30MHz to 1GHz

Frequency (MHz)	Quasi-Peak (dBμV/m)	Limit (dBμV/m)	Margin (dB)	Height (cm)	Polarization	Azimuth (deg)	Correct Factor (dB)
40.49	24.78	40.00	15.22	100.0	V	97.00	20
45.14	24.93	40.00	15.07	110.0	V	38.00	20
94.08	22.72	43.50	20.78	100.0	V	230.00	18
152.50	28.24	43.50	15.26	100.0	V	167.00	15
264.00	32.38	46.00	13.62	100.0	H	105.00	20
311.98	27.99	46.00	18.01	116.0	H	131.00	21

**Remark: 1. Correction Factor = Antenna factor + Insertion loss (cable loss + amplifier gain)**

**2. Margin = Limit – Quasi-Peak**

802.11a CH36

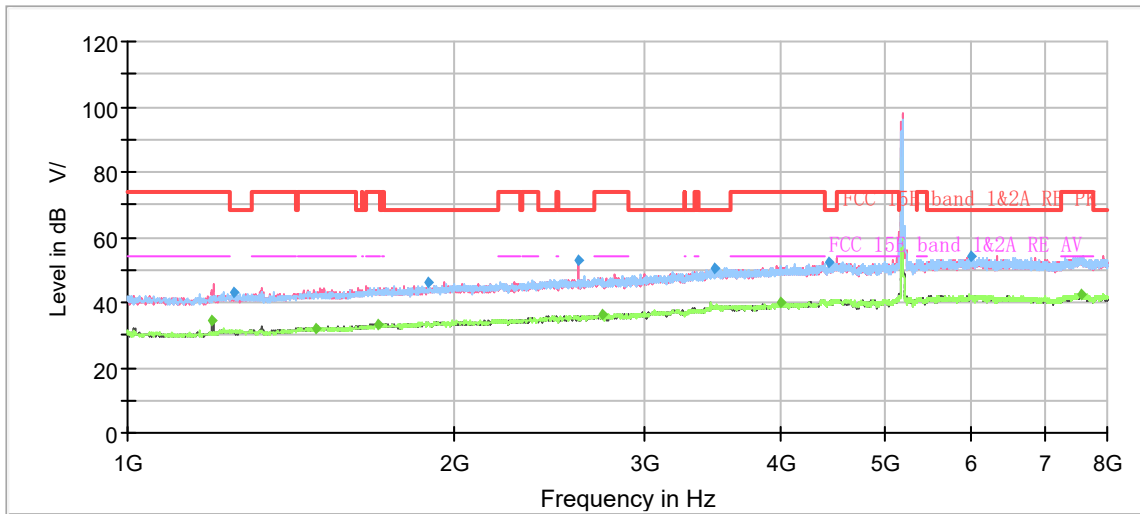

Note: The signal beyond the limit is carrier.  
Radiates Emission from 1GHz to 8GHz

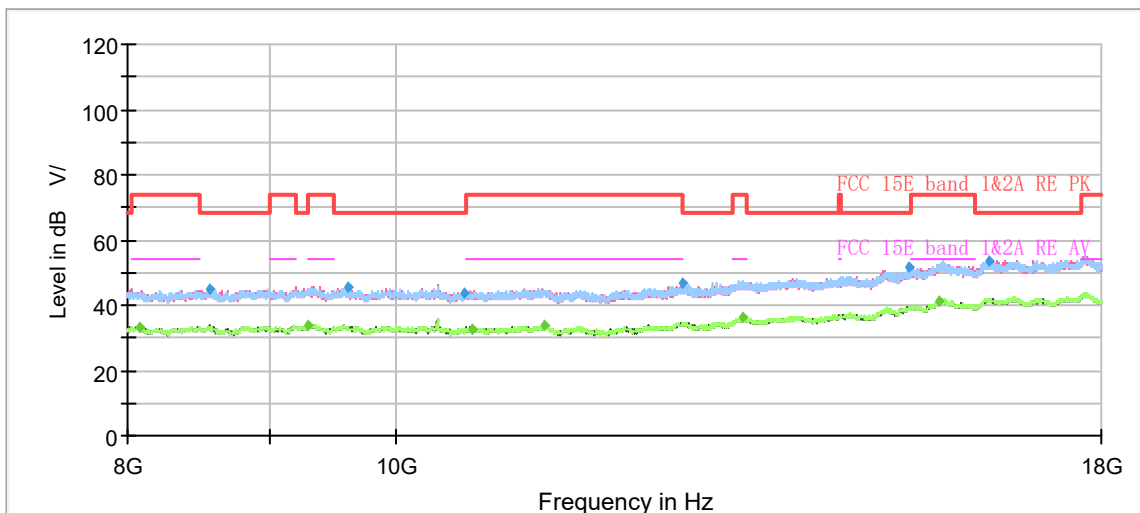

Radiates Emission from 8GHz to 18GHz

Frequency (MHz)	MaxPeak (dB $\mu$ V/m)	Average (dB $\mu$ V/m)	Limit (dB $\mu$ V/m)	Margin (dB)	Meas. Time (ms)	Height (cm)	Pol	Azimuth (deg)	Corr. (dB/m)
1196.88	---	34.42	54.00	19.58	500.00	200.0	V	248.00	-7
1250.25	43.07	---	68.20	25.13	500.00	100.0	V	176.00	-7
1491.75	---	31.83	54.00	22.17	500.00	200.0	V	65.00	-6
1700.00	---	33.42	54.00	20.58	500.00	200.0	V	11.00	-5
1895.13	45.97	---	68.20	22.23	500.00	100.0	H	0.00	-3
2603.00	53.01	---	68.20	15.19	500.00	100.0	V	9.00	0
2736.00	---	36.21	54.00	17.79	500.00	100.0	V	324.00	0
3474.50	50.68	---	68.20	17.52	500.00	100.0	V	146.00	3
3994.25	---	39.87	54.00	14.13	500.00	100.0	H	104.00	5
4436.13	52.14	---	68.20	16.06	500.00	200.0	V	310.00	6
5984.00	54.10	---	68.20	14.10	500.00	200.0	V	80.00	9
7574.75	---	42.49	54.00	11.51	500.00	200.0	V	70.00	11

**Remark: 1. Correction Factor = Antenna factor + Insertion loss (cable loss + amplifier gain)**

**2. Margin = Limit –MAX Peak/ Average**

802.11a CH44

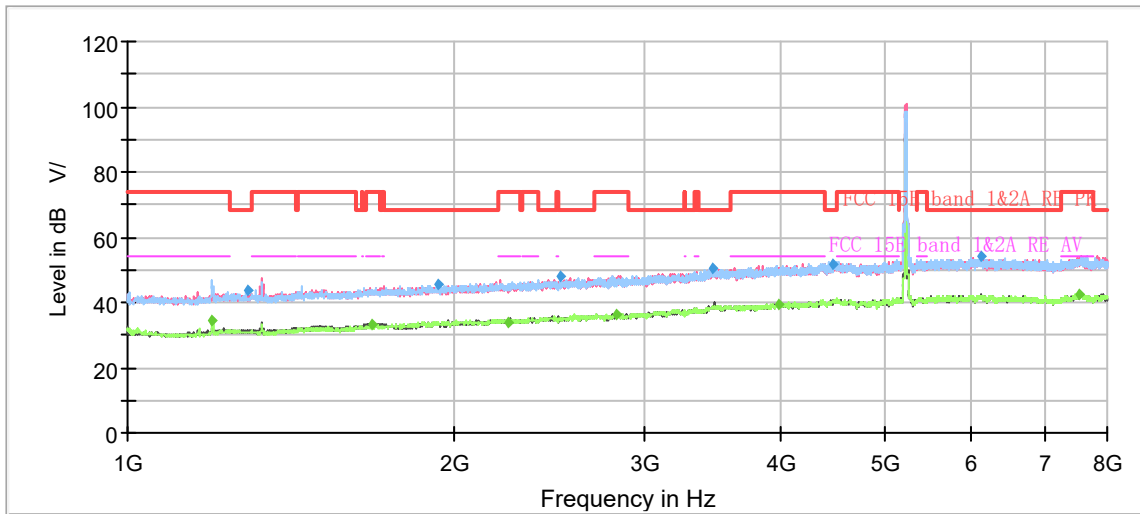

Note: The signal beyond the limit is carrier.  
Radiates Emission from 1GHz to 8GHz

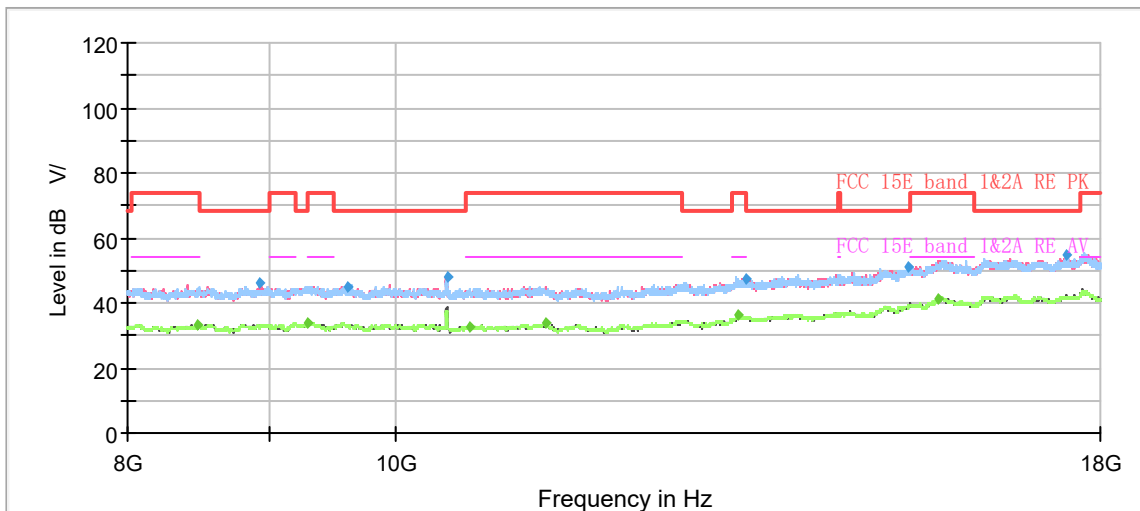

Radiates Emission from 8GHz to 18GHz

Frequency (MHz)	MaxPeak (dBμV/m)	Average (dBμV/m)	Limit (dBμV/m)	Margin (dB)	Meas. Time (ms)	Height (cm)	Pol	Azimuth (deg)	Corr. (dB/m)
1195.13	---	34.69	54.00	19.31	500.00	200.0	H	195.00	-7
1289.63	43.39	---	68.20	24.81	500.00	200.0	V	24.00	-7
1679.88	---	33.25	54.00	20.75	500.00	100.0	V	288.00	-5
1931.00	45.84	---	68.20	22.36	500.00	200.0	H	268.00	-3
2239.88	---	33.83	54.00	20.17	500.00	100.0	V	146.00	-2
2501.50	47.80	---	68.20	20.40	500.00	200.0	H	259.00	-1
2819.13	---	36.17	54.00	17.83	500.00	100.0	H	346.00	1
3464.00	50.39	---	68.20	17.81	500.00	200.0	V	220.00	3
3989.00	---	39.61	54.00	14.39	500.00	100.0	V	85.00	5
4465.88	51.87	---	68.20	16.33	500.00	100.0	V	212.00	7
6124.88	53.93	---	68.20	14.27	500.00	100.0	H	132.00	9
7552.88	---	42.57	54.00	11.43	500.00	200.0	H	268.00	11

**Remark: 1. Correction Factor = Antenna factor + Insertion loss (cable loss + amplifier gain)**

**2. Margin = Limit –MAX Peak/ Average**



802.11a CH48

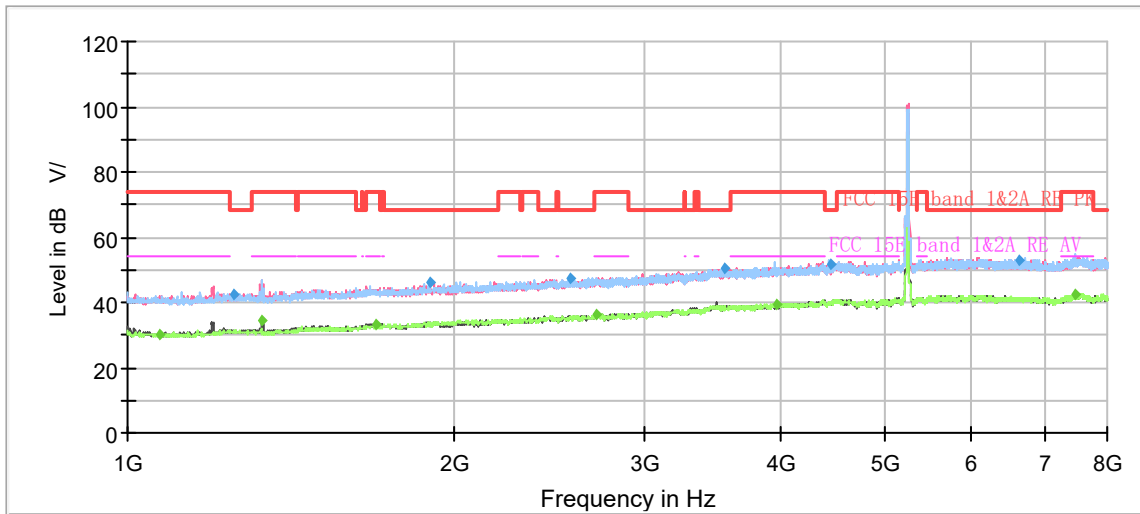

Note: The signal beyond the limit is carrier.  
Radiates Emission from 1GHz to 8GHz

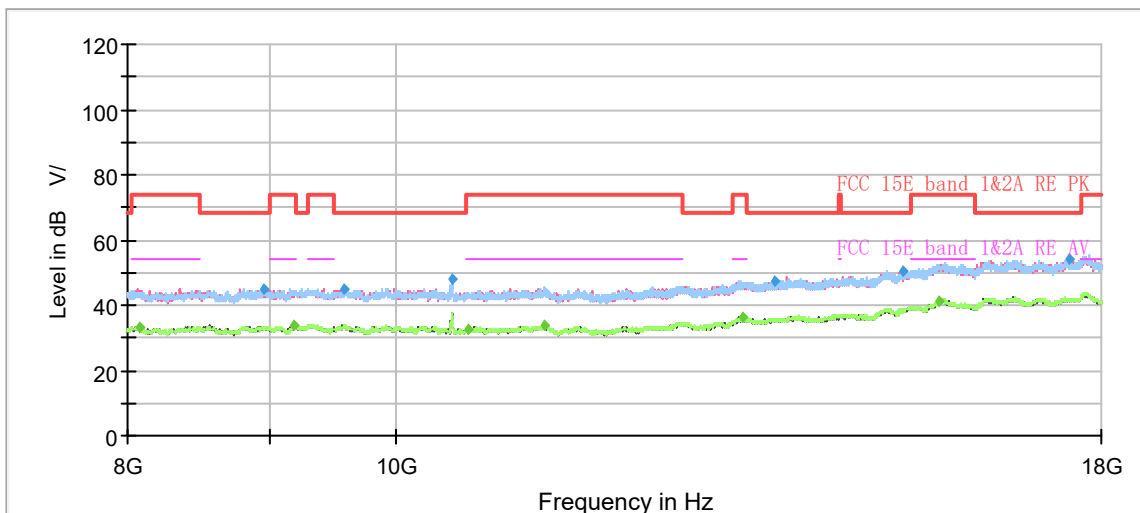

Radiates Emission from 8GHz to 18GHz

Frequency (MHz)	MaxPeak (dB $\mu$ V/m)	Average (dB $\mu$ V/m)	Limit (dB $\mu$ V/m)	Margin (dB)	Meas. Time (ms)	Height (cm)	Pol	Azimuth (deg)	Corr. (dB/m)
1070.88	---	30.21	54.00	23.79	500.00	200.0	V	0.00	-8
1254.63	42.63	---	68.20	25.57	500.00	100.0	V	129.00	-7
1329.00	---	34.23	54.00	19.77	500.00	100.0	V	0.00	-7
1694.75	---	33.43	54.00	20.57	500.00	200.0	V	234.00	-5
1897.75	46.02	---	68.20	22.18	500.00	100.0	H	3.00	-3
2556.63	47.26	---	68.20	20.94	500.00	100.0	H	343.00	0
2705.38	---	36.23	54.00	17.77	500.00	100.0	H	33.00	0
3552.38	50.35	---	68.20	17.85	500.00	200.0	H	76.00	4
3965.38	---	39.64	54.00	14.36	500.00	100.0	V	299.00	5
4455.38	51.43	---	68.20	16.77	500.00	100.0	H	0.00	6
6642.88	52.87	---	68.20	15.33	500.00	100.0	V	162.00	9
7481.13	---	42.61	54.00	11.39	500.00	100.0	H	108.00	11

**Remark: 1. Correction Factor = Antenna factor + Insertion loss (cable loss + amplifier gain)**

**2. Margin = Limit –MAX Peak/ Average**

802.11a CH52

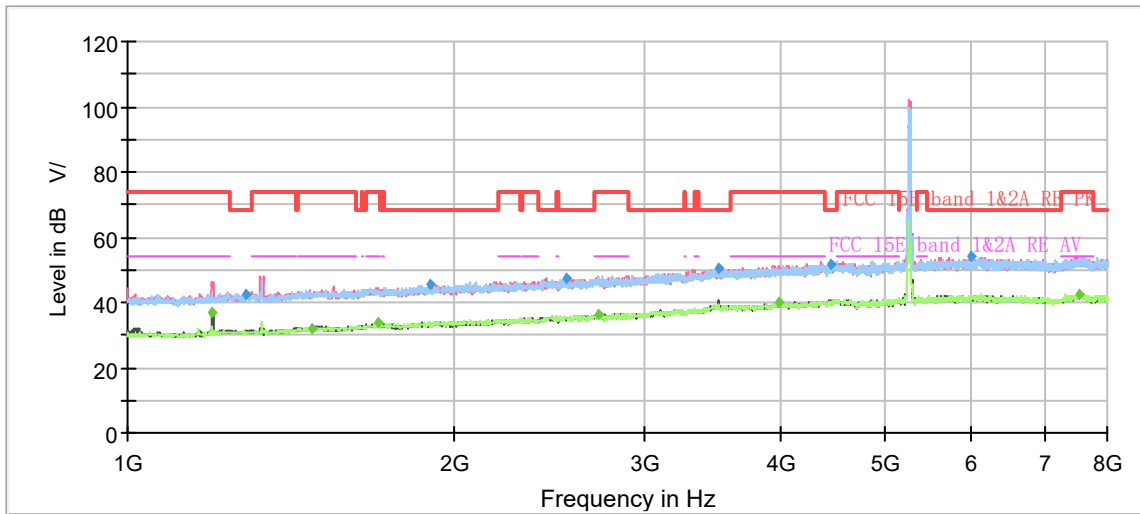

Note: The signal beyond the limit is carrier.  
Radiates Emission from 1GHz to 8GHz

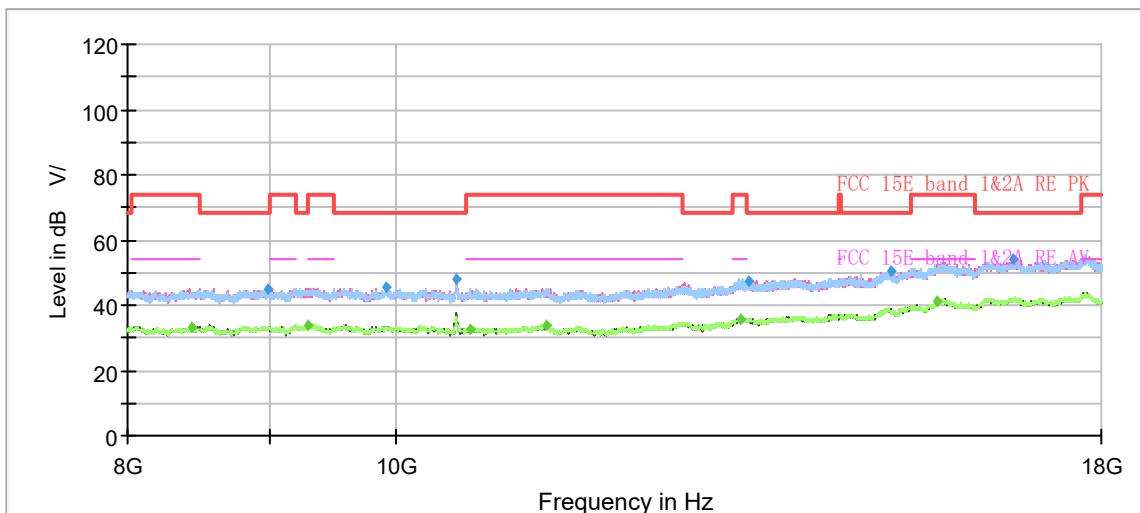

Radiates Emission from 8GHz to 18GHz

Frequency (MHz)	MaxPeak (dBμV/m)	Average (dBμV/m)	Limit (dBμV/m)	Margin (dB)	Meas. Time (ms)	Height (cm)	Pol	Azimuth (deg)	Corr. (dB/m)
1196.88	---	37.11	54.00	16.89	500.00	200.0	V	194.00	-7
1285.25	42.69	---	68.20	25.51	500.00	100.0	V	270.00	-7
1476.88	---	32.12	54.00	21.88	500.00	200.0	H	69.00	-6
1699.13	---	33.64	54.00	20.36	500.00	100.0	V	135.00	-5
1899.50	45.63	---	68.20	22.57	500.00	200.0	H	89.00	-3
2540.00	47.54	---	68.20	20.66	500.00	200.0	V	142.00	0
2722.00	---	36.33	54.00	17.67	500.00	200.0	H	207.00	0
3499.00	50.54	---	68.20	17.66	500.00	200.0	V	121.00	4
3990.75	---	40.01	54.00	13.99	500.00	200.0	V	91.00	5
4450.13	51.60	---	68.20	16.60	500.00	200.0	V	38.00	6
5982.25	53.86	---	68.20	14.34	500.00	200.0	V	28.00	9
7545.00	---	42.48	54.00	11.52	500.00	100.0	H	66.00	11

**Remark: 1. Correction Factor = Antenna factor + Insertion loss (cable loss + amplifier gain)**

**2. Margin = Limit –MAX Peak/ Average**

802.11a CH60

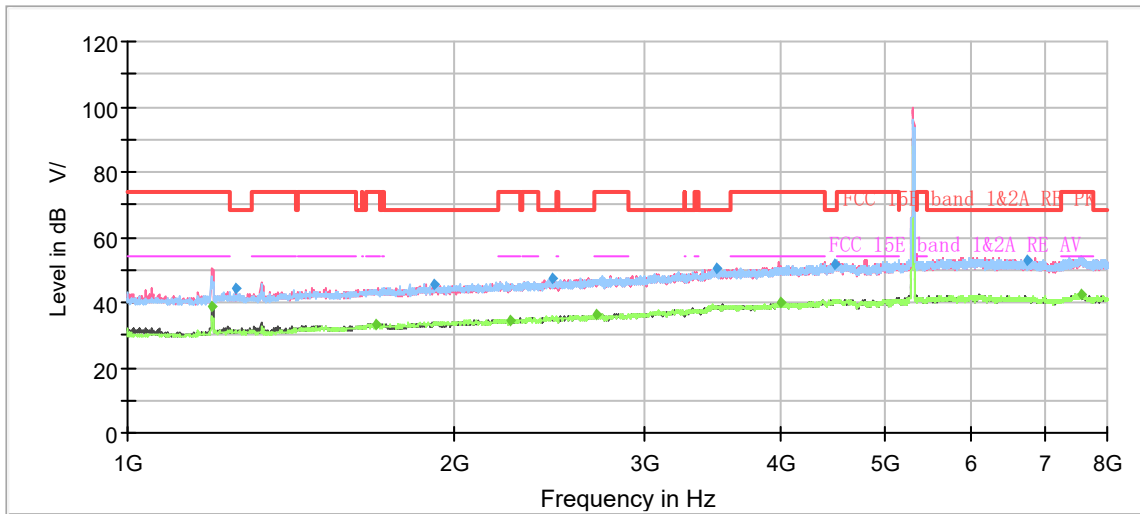

Note: The signal beyond the limit is carrier.  
Radiates Emission from 1GHz to 8GHz

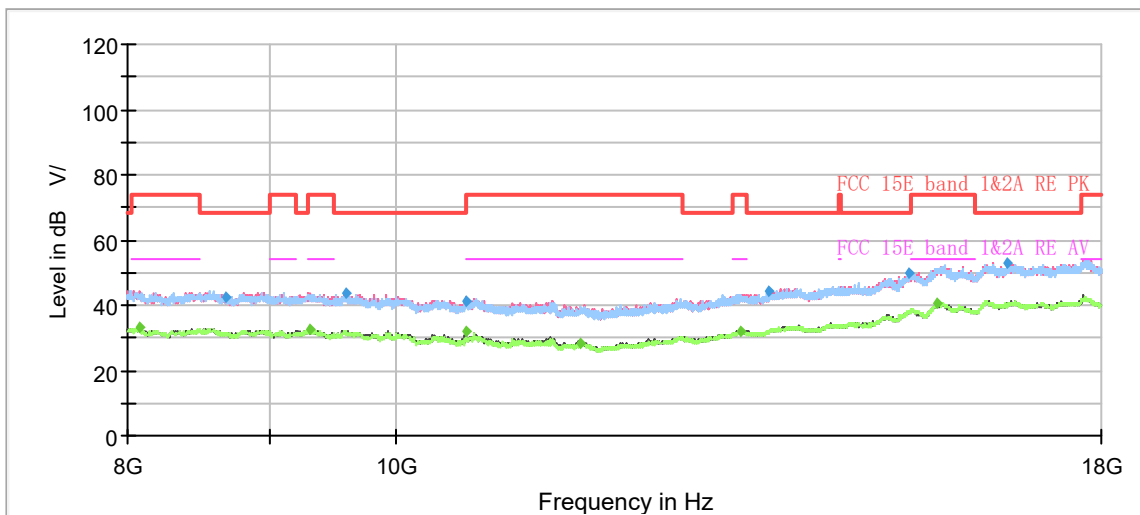

Radiates Emission from 8GHz to 18GHz

Frequency (MHz)	MaxPeak (dBμV/m)	Average (dBμV/m)	Limit (dBμV/m)	Margin (dB)	Meas. Time (ms)	Height (cm)	Pol	Azimuth (deg)	Corr. (dB/m)
1195.13	---	39.06	54.00	14.94	500.00	200.0	V	150.00	-7
1257.25	44.39	---	68.20	23.81	500.00	200.0	V	150.00	-7
1691.25	---	33.33	54.00	20.67	500.00	100.0	V	341.00	-5
1917.00	45.67	---	68.20	22.53	500.00	200.0	V	159.00	-3
2254.75	---	34.70	54.00	19.30	500.00	100.0	V	200.00	-2
2459.50	47.11	---	68.20	21.09	500.00	100.0	H	20.00	-1
2703.63	---	36.40	54.00	17.60	500.00	100.0	H	286.00	0
3487.63	50.55	---	68.20	17.65	500.00	200.0	V	356.00	4
3999.50	---	39.85	54.00	14.15	500.00	200.0	H	359.00	5
4479.88	51.96	---	68.20	16.24	500.00	100.0	V	205.00	7
6752.25	52.75	---	68.20	15.45	500.00	200.0	H	142.00	9
7566.88	---	42.50	54.00	11.50	500.00	200.0	H	340.00	11

**Remark: 1. Correction Factor = Antenna factor + Insertion loss (cable loss + amplifier gain)**

**2. Margin = Limit –MAX Peak/ Average**

802.11a CH64

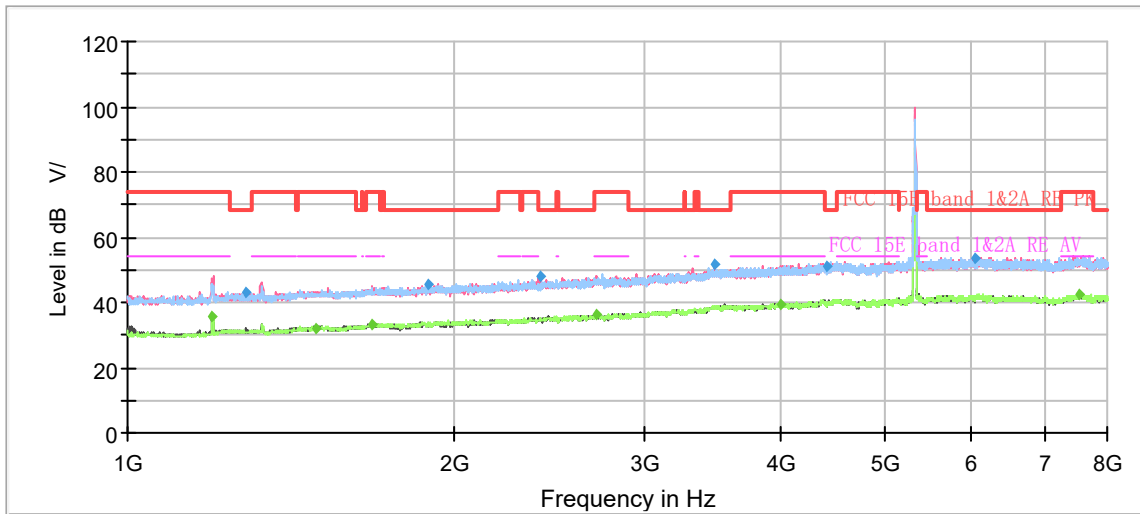

Note: The signal beyond the limit is carrier.  
Radiates Emission from 1GHz to 8GHz

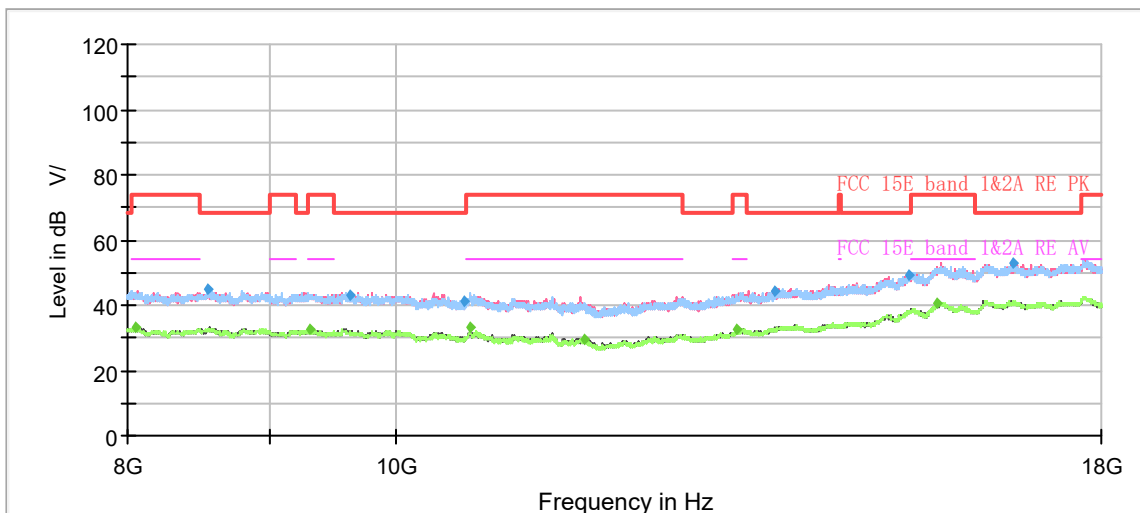

Radiates Emission from 8GHz to 18GHz

Frequency (MHz)	MaxPeak (dB $\mu$ V/m)	Average (dB $\mu$ V/m)	Limit (dB $\mu$ V/m)	Margin (dB)	Meas. Time (ms)	Height (cm)	Pol	Azimuth (deg)	Corr. (dB/m)
1196.88	---	35.76	54.00	18.24	500.00	200.0	V	253.00	-7
1287.88	43.10	---	68.20	25.10	500.00	100.0	V	0.00	-7
1491.75	---	31.87	54.00	22.13	500.00	100.0	H	0.00	-6
1680.75	---	33.34	54.00	20.66	500.00	100.0	V	227.00	-5
1893.38	45.50	---	68.20	22.70	500.00	100.0	V	110.00	-3
2399.13	47.77	---	68.20	20.43	500.00	200.0	V	194.00	-1
2710.63	---	36.39	54.00	17.61	500.00	200.0	H	68.00	0
3474.50	51.48	---	68.20	16.72	500.00	200.0	V	204.00	3
3992.50	---	39.45	54.00	14.55	500.00	200.0	V	214.00	5
4402.00	51.04	---	68.20	17.16	500.00	200.0	V	120.00	6
6037.38	53.79	---	68.20	14.41	500.00	100.0	V	358.00	9
7548.50	---	42.60	54.00	11.40	500.00	100.0	H	81.00	11

**Remark: 1. Correction Factor = Antenna factor + Insertion loss (cable loss + amplifier gain)**

**2. Margin = Limit –MAX Peak/ Average**



802.11a CH100

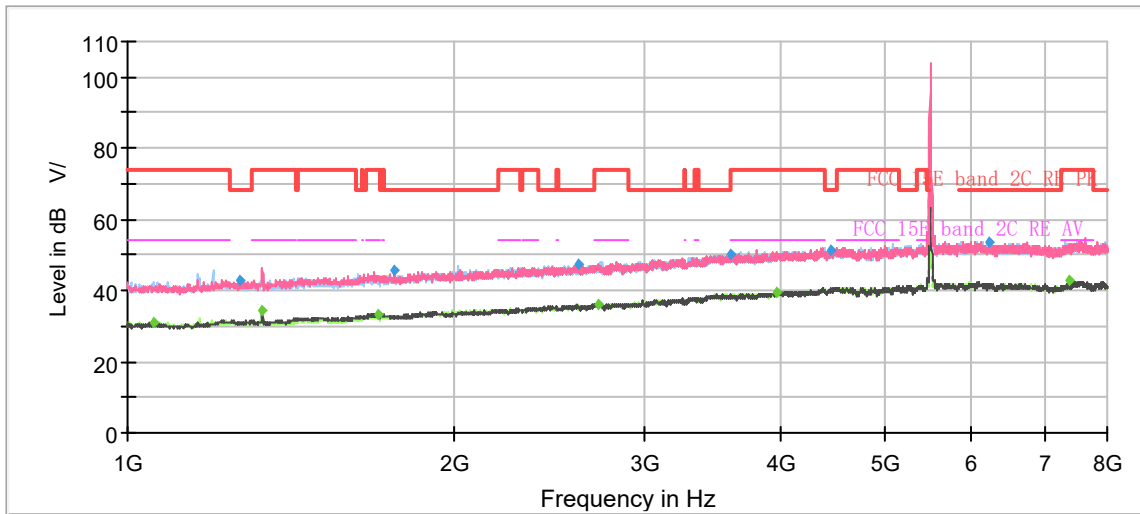

Note: The signal beyond the limit is carrier.  
Radiates Emission from 1GHz to 8GHz

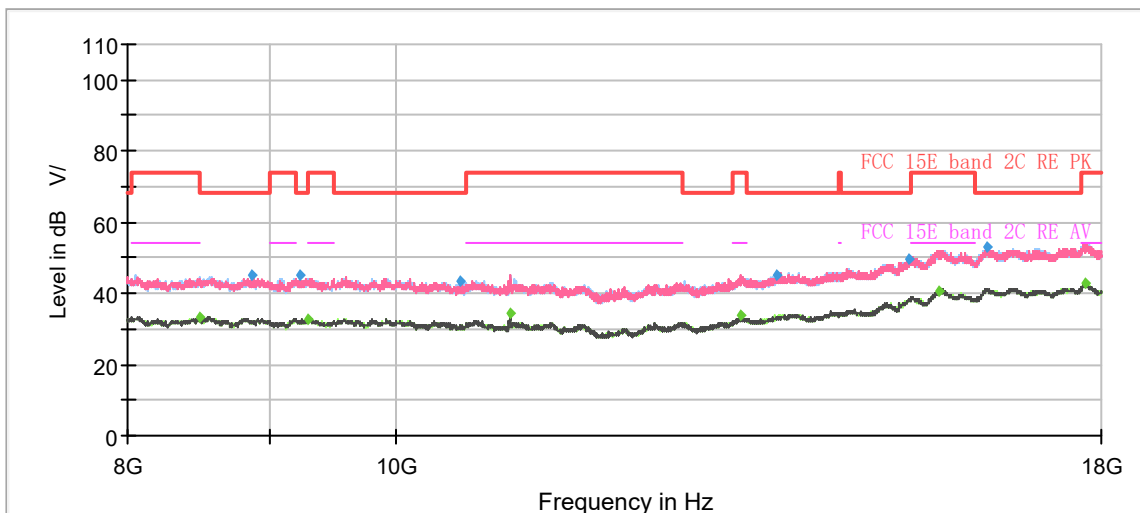

Radiates Emission from 8GHz to 18GHz

Frequency (MHz)	MaxPeak (dB $\mu$ V/m)	Average (dB $\mu$ V/m)	Limit (dB $\mu$ V/m)	Margin (dB)	Meas. Time (ms)	Height (cm)	Pol	Azimuth (deg)	Corr. (dB/m)
1058.63	---	30.82	54.00	23.18	500.00	200.0	H	204.00	-8
1269.50	42.64	---	68.20	25.56	500.00	100.0	V	95.00	-7
1329.00	---	34.20	54.00	19.80	500.00	100.0	V	185.00	-7
1701.75	---	33.30	54.00	20.70	500.00	200.0	V	349.00	-5
1763.88	45.46	---	68.20	22.74	500.00	200.0	V	251.00	-4
2600.38	47.56	---	68.20	20.64	500.00	200.0	H	71.00	0
2719.38	---	36.28	54.00	17.72	500.00	100.0	H	71.00	0
3594.38	50.42	---	68.20	17.78	500.00	200.0	H	184.00	4
3962.75	---	39.40	54.00	14.60	500.00	100.0	H	146.00	5
4453.63	51.09	---	68.20	17.11	500.00	200.0	H	0.00	6
6228.13	53.68	---	68.20	14.52	500.00	100.0	H	277.00	9
7390.13	---	42.62	54.00	11.38	500.00	100.0	V	329.00	11

**Remark: 1. Correction Factor = Antenna factor + Insertion loss (cable loss + amplifier gain)**

**2. Margin = Limit –MAX Peak/ Average**

802.11a CH116

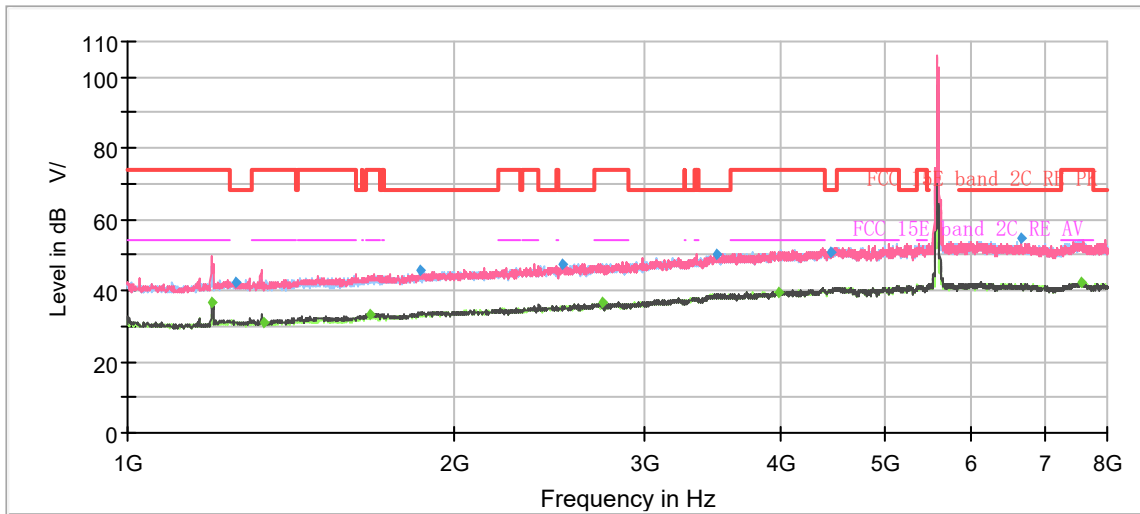

Note: The signal beyond the limit is carrier.  
Radiates Emission from 1GHz to 8GHz

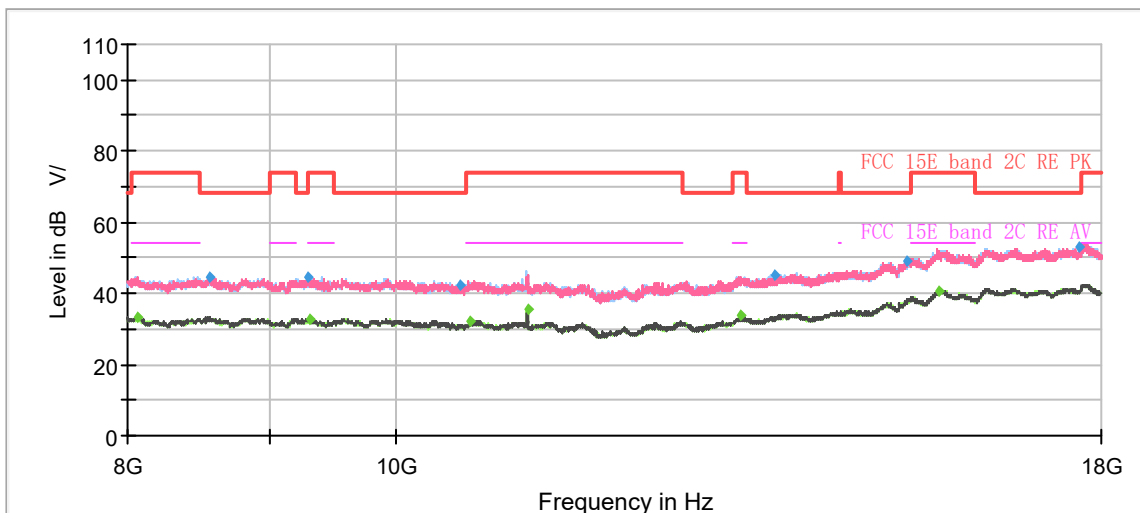

Radiates Emission from 8GHz to 18GHz

Frequency (MHz)	MaxPeak (dBμV/m)	Average (dBμV/m)	Limit (dBμV/m)	Margin (dB)	Meas. Time (ms)	Height (cm)	Pol	Azimuth (deg)	Corr. (dB/m)
1196.00	---	36.49	54.00	17.51	500.00	200.0	V	190.00	-7
1257.25	42.10	---	68.20	26.10	500.00	200.0	V	210.00	-7
1337.75	---	30.76	54.00	23.24	500.00	100.0	H	156.00	-7
1672.88	---	33.39	54.00	20.61	500.00	100.0	V	0.00	-5
1858.38	45.61	---	68.20	22.59	500.00	100.0	V	88.00	-4
2521.63	47.27	---	68.20	20.93	500.00	100.0	V	40.00	-1
2739.50	---	36.46	54.00	17.54	500.00	100.0	H	91.00	0
3489.38	50.43	---	68.20	17.77	500.00	100.0	H	277.00	4
3990.75	---	39.59	54.00	14.41	500.00	100.0	V	112.00	5
4451.00	51.03	---	68.20	17.17	500.00	200.0	V	319.00	6
6649.88	54.47	---	68.20	13.73	500.00	100.0	V	151.00	9
7565.13	---	42.42	54.00	11.58	500.00	200.0	H	113.00	11

**Remark: 1. Correction Factor = Antenna factor + Insertion loss (cable loss + amplifier gain)**

**2. Margin = Limit –MAX Peak/ Average**

802.11a CH140

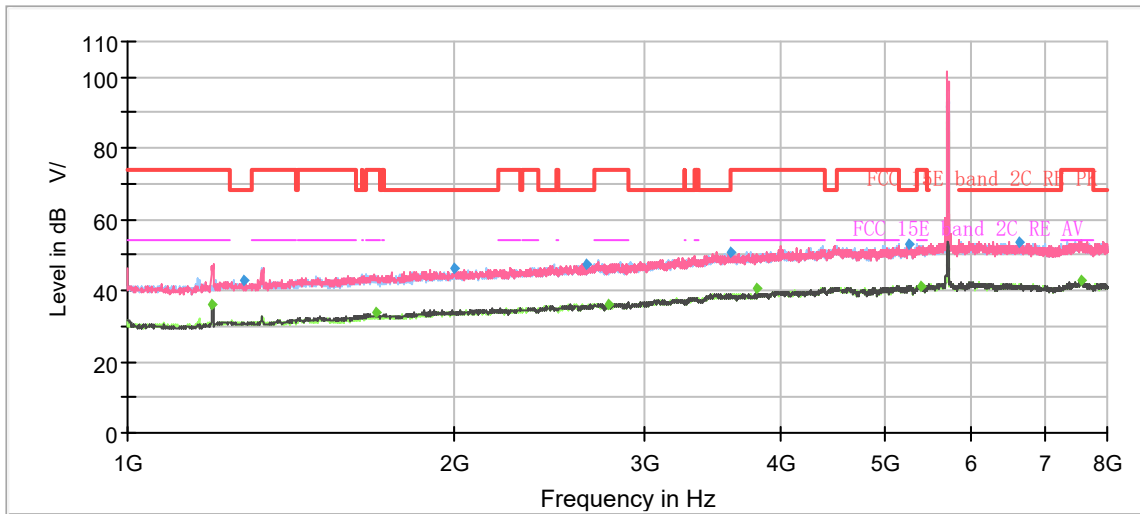

Note: The signal beyond the limit is carrier.  
Radiates Emission from 1GHz to 8GHz

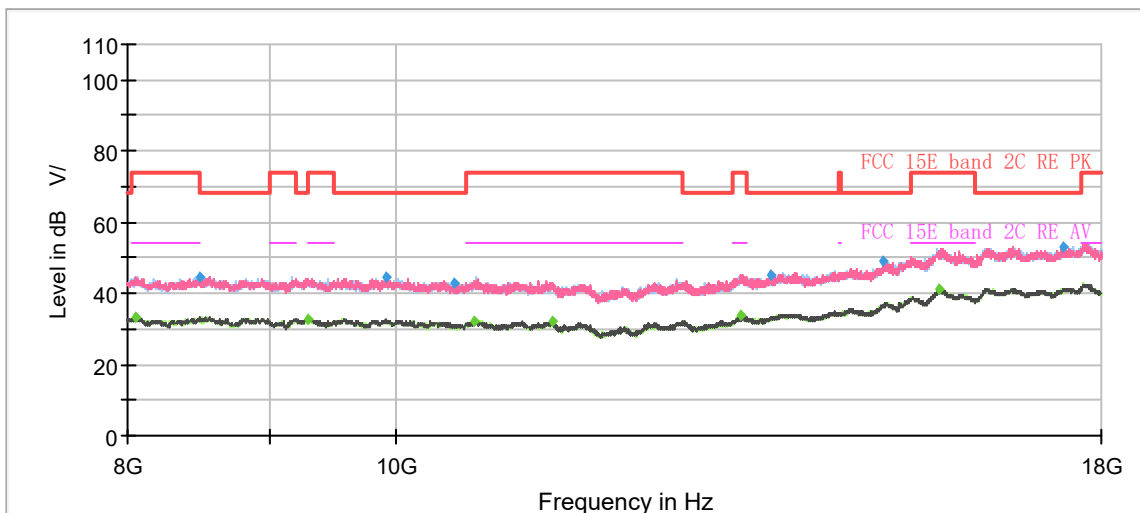

Radiates Emission from 8GHz to 18GHz

Frequency (MHz)	MaxPeak (dBμV/m)	Average (dBμV/m)	Limit (dBμV/m)	Margin (dB)	Meas. Time (ms)	Height (cm)	Pol	Azimuth (deg)	Corr. (dB/m)
1196.00	---	36.22	54.00	17.78	500.00	200.0	V	84.00	-7
1278.25	42.90	---	68.20	25.30	500.00	200.0	H	67.00	-7
1695.63	---	33.76	54.00	20.24	500.00	200.0	V	136.00	-5
1999.25	46.18	---	68.20	22.02	500.00	100.0	V	255.00	-3
2645.00	47.40	---	68.20	20.80	500.00	100.0	V	143.00	0
2779.75	---	36.30	54.00	17.70	500.00	200.0	H	38.00	0
3597.88	50.80	---	68.20	17.40	500.00	200.0	V	150.00	4
3800.00	---	40.46	54.00	13.54	500.00	200.0	H	67.00	4
5254.25	52.97	---	68.20	15.23	500.00	200.0	H	28.00	8
5380.25	---	41.42	54.00	12.58	500.00	200.0	V	227.00	9
6642.88	53.83	---	68.20	14.37	500.00	200.0	V	160.00	9
7580.88	---	42.65	54.00	11.35	500.00	200.0	H	350.00	11

**Remark: 1. Correction Factor = Antenna factor + Insertion loss (cable loss + amplifier gain)**

**2. Margin = Limit –MAX Peak/ Average**

802.11a CH144

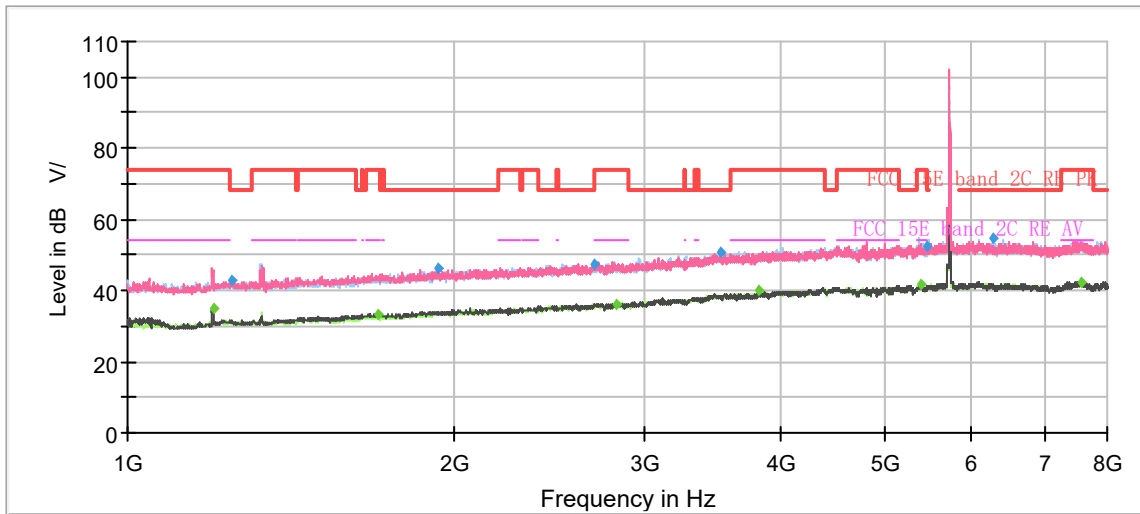

Note: The signal beyond the limit is carrier.  
Radiates Emission from 1GHz to 8GHz

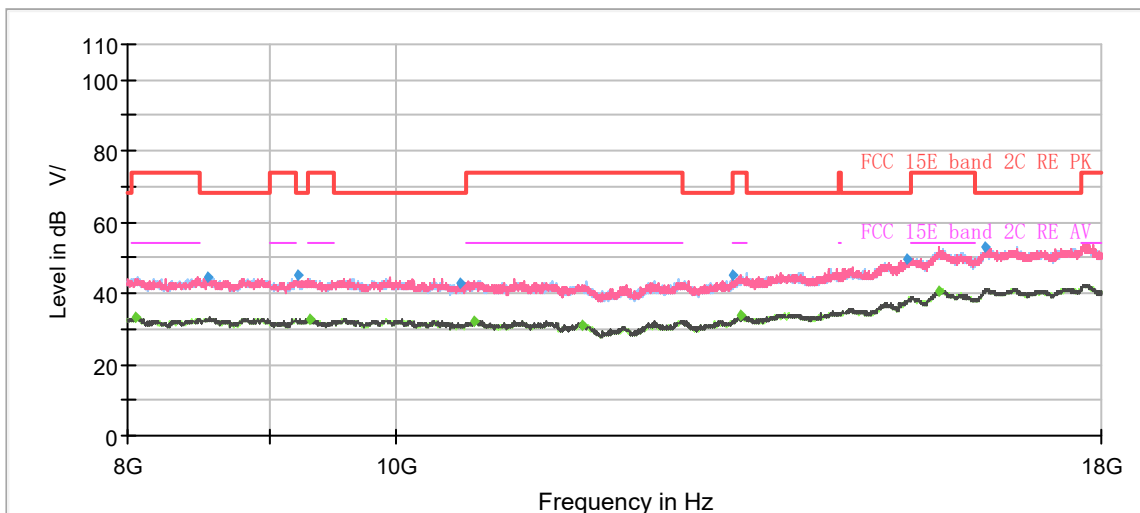

Radiates Emission from 8GHz to 18GHz

Frequency (MHz)	MaxPeak (dBμV/m)	Average (dBμV/m)	Limit (dBμV/m)	Margin (dB)	Meas. Time (ms)	Height (cm)	Pol	Azimuth (deg)	Corr. (dB/m)
1198.63	---	34.84	54.00	19.16	500.00	200.0	V	134.00	-7
1245.88	42.70	---	68.20	25.50	500.00	200.0	V	94.00	-7
1701.75	---	33.19	54.00	20.81	500.00	200.0	H	0.00	-5
1929.25	46.30	---	68.20	21.90	500.00	100.0	V	27.00	-3
2688.75	47.66	---	68.20	20.54	500.00	200.0	H	79.00	0
2827.88	---	36.20	54.00	17.80	500.00	200.0	V	257.00	1
3514.75	50.54	---	68.20	17.66	500.00	100.0	V	95.00	4
3813.13	---	40.30	54.00	13.70	500.00	200.0	H	22.00	4
5379.38	---	41.54	54.00	12.46	500.00	200.0	H	22.00	9
5464.25	52.60	---	68.20	15.60	500.00	200.0	H	42.00	9
6274.50	54.75	---	68.20	13.45	500.00	200.0	H	47.00	9
7573.00	---	42.50	54.00	11.50	500.00	200.0	V	134.00	11

**Remark: 1. Correction Factor = Antenna factor + Insertion loss (cable loss + amplifier gain)**

**2. Margin = Limit –MAX Peak/ Average**



802.11a CH149

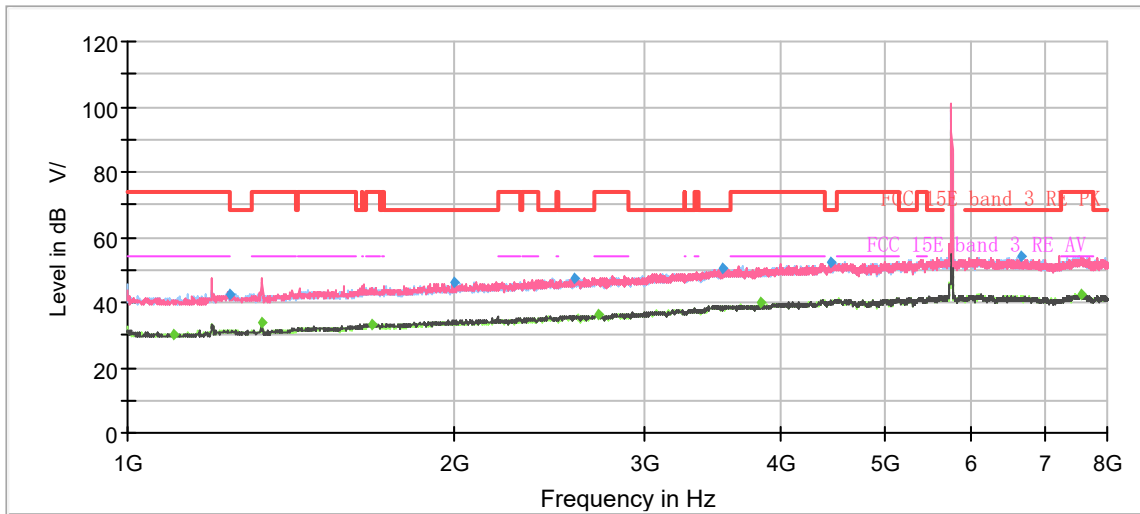

Note: The signal beyond the limit is carrier.  
Radiates Emission from 1GHz to 8GHz

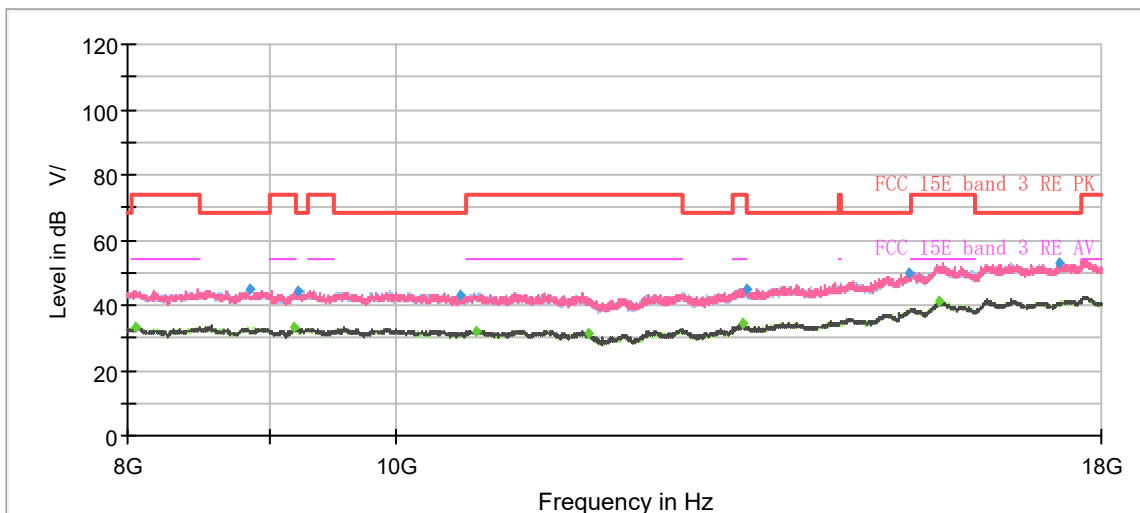

Radiates Emission from 8GHz to 18GHz

Frequency (MHz)	MaxPeak (dBμV/m)	Average (dBμV/m)	Limit (dBμV/m)	Margin (dB)	Meas. Time (ms)	Height (cm)	Pol	Azimuth (deg)	Corr. (dB/m)
1102.38	---	30.24	54.00	23.76	500.00	200.0	H	337.00	-8
1243.25	42.47	---	68.20	25.73	500.00	200.0	V	121.00	-7
1329.88	---	33.63	54.00	20.37	500.00	200.0	V	0.00	-7
1680.75	---	33.36	54.00	20.64	500.00	100.0	V	223.00	-5
1998.38	45.91	---	68.20	22.29	500.00	100.0	V	149.00	-3
2579.38	47.51	---	68.20	20.69	500.00	200.0	H	235.00	0
2721.13	---	36.36	54.00	17.64	500.00	100.0	H	27.00	0
3535.75	50.48	---	68.20	17.72	500.00	200.0	H	168.00	4
3829.75	---	40.02	54.00	13.98	500.00	200.0	H	64.00	4
4454.50	52.37	---	68.20	15.83	500.00	100.0	V	266.00	6
6663.00	54.04	---	68.20	14.16	500.00	100.0	V	163.00	9
7576.50	---	42.65	54.00	11.35	500.00	100.0	H	245.00	11

**Remark: 1. Correction Factor = Antenna factor + Insertion loss (cable loss + amplifier gain)**

**2. Margin = Limit –MAX Peak/ Average**

802.11a CH157

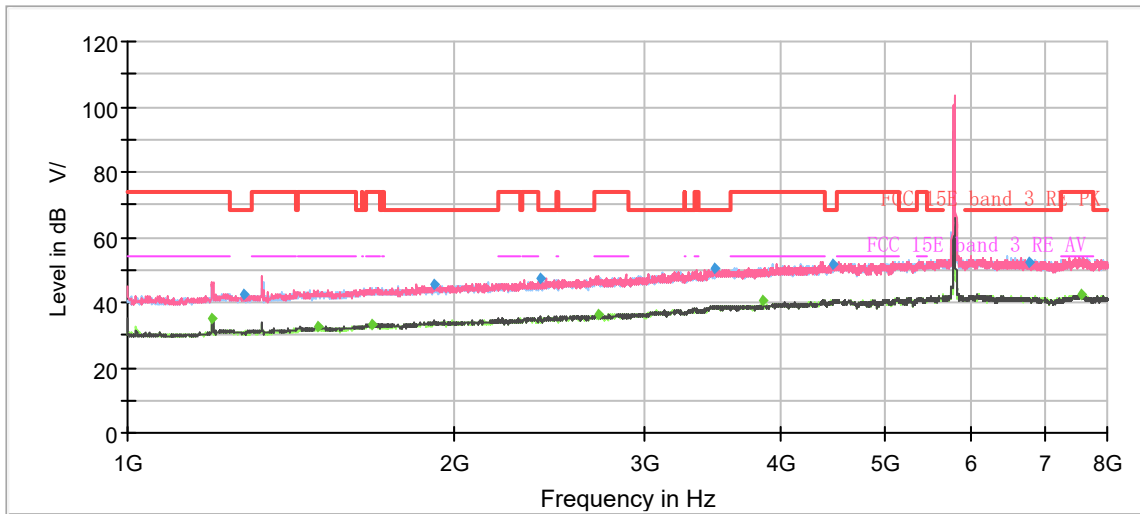

Note: The signal beyond the limit is carrier.  
Radiates Emission from 1GHz to 8GHz

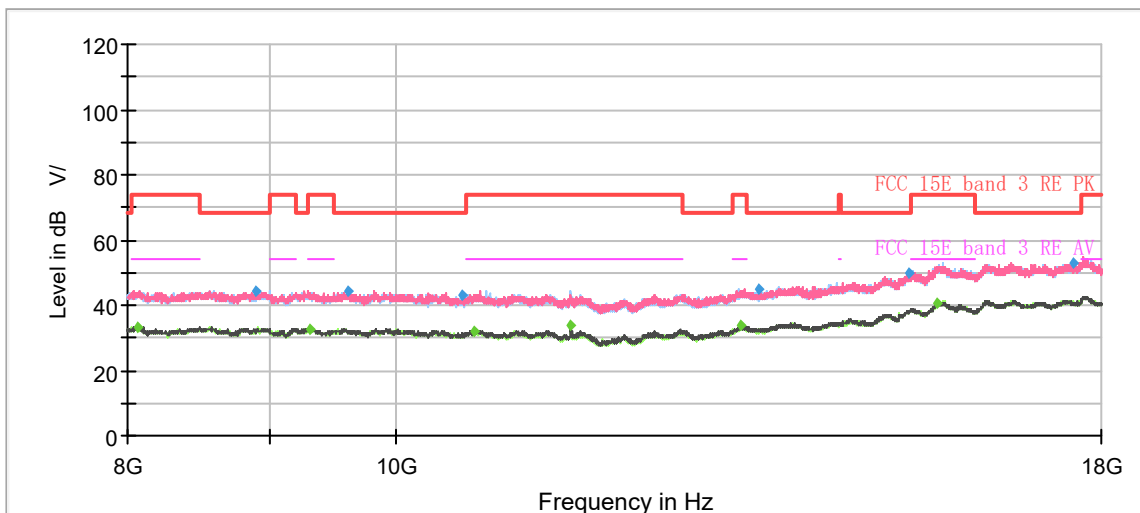

Radiates Emission from 8GHz to 18GHz

Frequency (MHz)	MaxPeak (dB $\mu$ V/m)	Average (dB $\mu$ V/m)	Limit (dB $\mu$ V/m)	Margin (dB)	Meas. Time (ms)	Height (cm)	Pol	Azimuth (deg)	Corr. (dB/m)
1196.00	---	35.10	54.00	18.90	500.00	100.0	V	0.00	-7
1280.88	42.76	---	68.20	25.44	500.00	100.0	V	144.00	-7
1500.50	---	32.43	54.00	21.57	500.00	100.0	V	256.00	-6
1681.63	---	33.31	54.00	20.69	500.00	200.0	V	84.00	-5
1914.38	45.62	---	68.20	22.58	500.00	100.0	H	11.00	-3
2396.50	47.47	---	68.20	20.73	500.00	200.0	V	190.00	-1
2715.88	---	36.40	54.00	17.60	500.00	200.0	H	0.00	0
3483.25	50.59	---	68.20	17.61	500.00	100.0	V	139.00	4
3856.88	---	40.67	54.00	13.33	500.00	200.0	H	141.00	5
4459.75	51.73	---	68.20	16.47	500.00	200.0	V	0.00	7
6775.88	52.40	---	68.20	15.80	500.00	200.0	V	23.00	9
7577.38	---	42.57	54.00	11.43	500.00	200.0	H	314.00	11

Remark: 1. Correction Factor = Antenna factor + Insertion loss (cable loss + amplifier gain)

2. Margin = Limit –MAX Peak/ Average

802.11a CH165

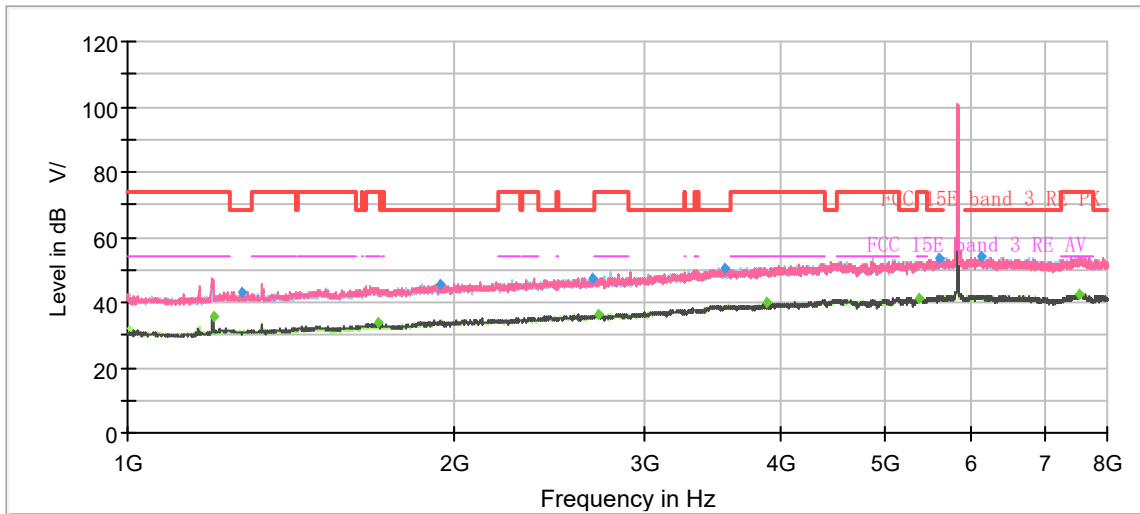

Note: The signal beyond the limit is carrier.  
Radiates Emission from 1GHz to 8GHz

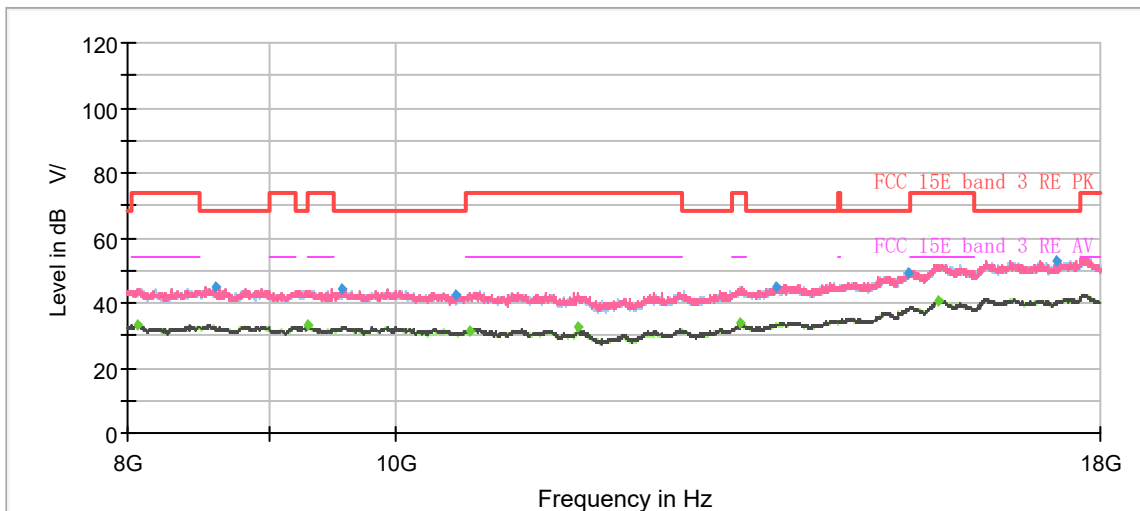

Radiates Emission from 8GHz to 18GHz

Frequency (MHz)	MaxPeak (dBμV/m)	Average (dBμV/m)	Limit (dBμV/m)	Margin (dB)	Meas. Time (ms)	Height (cm)	Pol	Azimuth (deg)	Corr. (dB/m)
1198.63	---	35.59	54.00	18.41	500.00	100.0	V	2.00	-7
1276.50	42.89	---	68.20	25.31	500.00	100.0	V	13.00	-7
1699.13	---	33.63	54.00	20.37	500.00	200.0	V	10.00	-5
1944.13	45.65	---	68.20	22.55	500.00	100.0	V	313.00	-3
2678.25	47.33	---	68.20	20.87	500.00	100.0	V	288.00	0
2714.13	---	36.32	54.00	17.68	500.00	100.0	V	217.00	0
3554.13	50.37	---	68.20	17.83	500.00	200.0	V	123.00	4
3883.13	---	40.20	54.00	13.80	500.00	200.0	H	65.00	5
5374.13	---	41.50	54.00	12.50	500.00	200.0	H	334.00	9
5607.75	53.38	---	68.20	14.82	500.00	100.0	H	97.00	9
6112.63	54.20	---	68.20	14.00	500.00	200.0	V	118.00	9
7552.88	---	42.42	54.00	11.58	500.00	200.0	V	5.00	11

**Remark: 1. Correction Factor = Antenna factor + Insertion loss (cable loss + amplifier gain)**

**2. Margin = Limit –MAX Peak/ Average**

802.11n (HT20) CH36

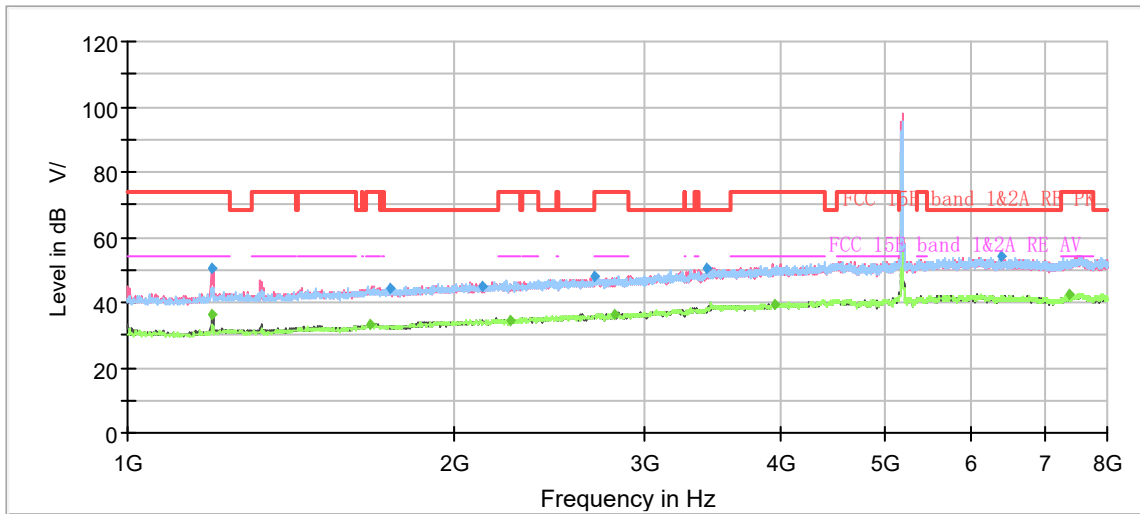

Note: The signal beyond the limit is carrier.  
Radiates Emission from 1GHz to 8GHz

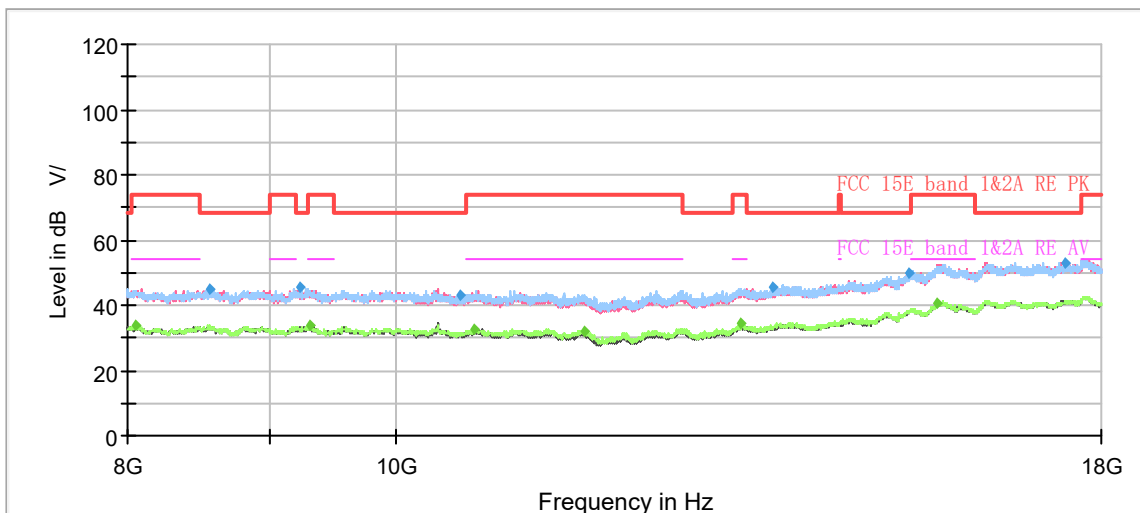

Radiates Emission from 8GHz to 18GHz

Frequency (MHz)	MaxPeak (dB $\mu$ V/m)	Average (dB $\mu$ V/m)	Limit (dB $\mu$ V/m)	Margin (dB)	Meas. Time (ms)	Height (cm)	Pol	Azimuth (deg)	Corr. (dB/m)
1194.25	50.60	---	74.00	23.40	500.00	200.0	V	216.00	-7
1197.75	---	36.53	54.00	17.47	500.00	200.0	V	216.00	-7
1671.13	---	33.45	54.00	20.55	500.00	200.0	V	211.00	-5
1744.63	44.13	---	68.20	24.07	500.00	200.0	H	70.00	-4
2120.00	45.05	---	68.20	23.15	500.00	200.0	H	15.00	-2
2252.13	---	34.54	54.00	19.46	500.00	100.0	H	150.00	-2
2687.88	47.85	---	68.20	20.35	500.00	100.0	H	207.00	0
2806.88	---	36.57	54.00	17.43	500.00	200.0	H	120.00	0
3424.63	50.54	---	68.20	17.66	500.00	200.0	V	280.00	3
3945.25	---	39.43	54.00	14.57	500.00	200.0	V	146.00	5
6383.00	54.27	---	68.20	13.93	500.00	100.0	V	358.00	9
7364.75	---	42.75	54.00	11.25	500.00	100.0	H	0.00	10

**Remark: 1. Correction Factor = Antenna factor + Insertion loss (cable loss + amplifier gain)**

**2. Margin = Limit –MAX Peak/ Average**



802.11n (HT20) CH44

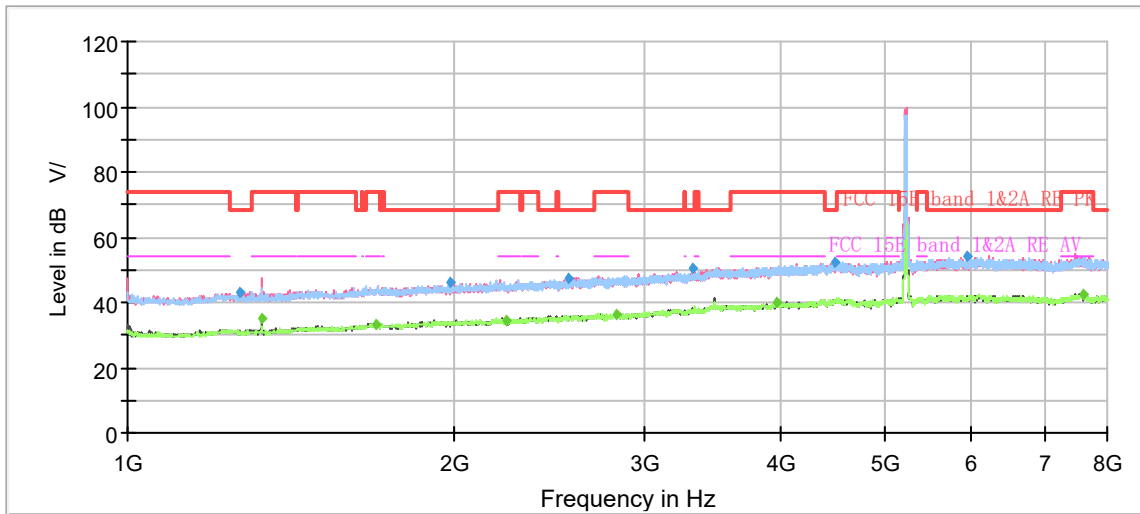

Note: The signal beyond the limit is carrier.  
Radiates Emission from 1GHz to 8GHz

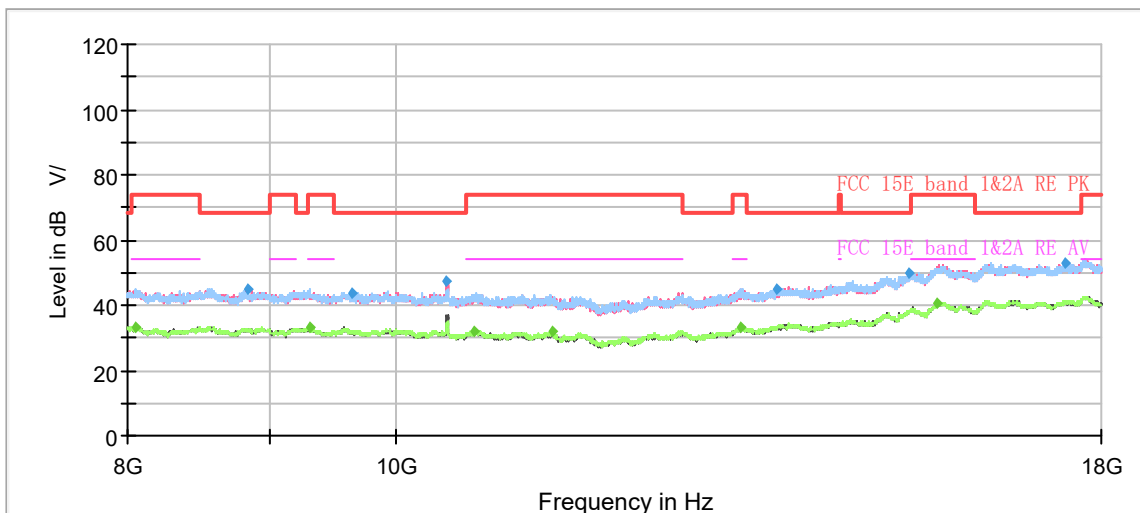

Radiates Emission from 8GHz to 18GHz

Frequency (MHz)	MaxPeak (dB $\mu$ V/m)	Average (dB $\mu$ V/m)	Limit (dB $\mu$ V/m)	Margin (dB)	Meas. Time (ms)	Height (cm)	Pol	Azimuth (deg)	Corr. (dB/m)
1270.38	43.15	---	68.20	25.05	500.00	100.0	H	255.00	-7
1329.88	---	35.22	54.00	18.78	500.00	200.0	V	1.00	-7
1697.38	---	33.32	54.00	20.68	500.00	100.0	V	69.00	-5
1979.13	46.34	---	68.20	21.86	500.00	200.0	H	333.00	-3
2235.50	---	34.59	54.00	19.41	500.00	100.0	V	204.00	-2
2545.25	47.64	---	68.20	20.56	500.00	100.0	H	193.00	0
2818.25	---	36.25	54.00	17.75	500.00	100.0	H	226.00	1
3317.00	50.45	---	68.20	17.75	500.00	200.0	V	359.00	3
3970.63	---	39.86	54.00	14.14	500.00	200.0	H	124.00	5
4479.00	52.58	---	68.20	15.62	500.00	100.0	V	140.00	7
5943.75	54.22	---	68.20	13.98	500.00	100.0	H	207.00	9
7594.00	---	42.50	54.00	11.50	500.00	200.0	V	164.00	11

**Remark: 1. Correction Factor = Antenna factor + Insertion loss (cable loss + amplifier gain)**

**2. Margin = Limit –MAX Peak/ Average**

802.11n (HT20) CH48

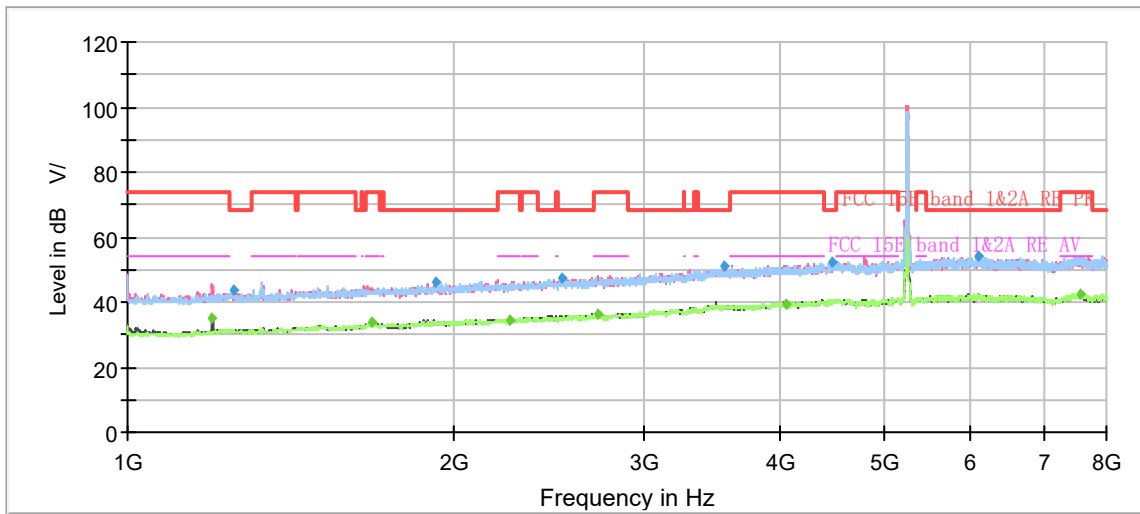

Note: The signal beyond the limit is carrier.  
Radiates Emission from 1GHz to 8GHz

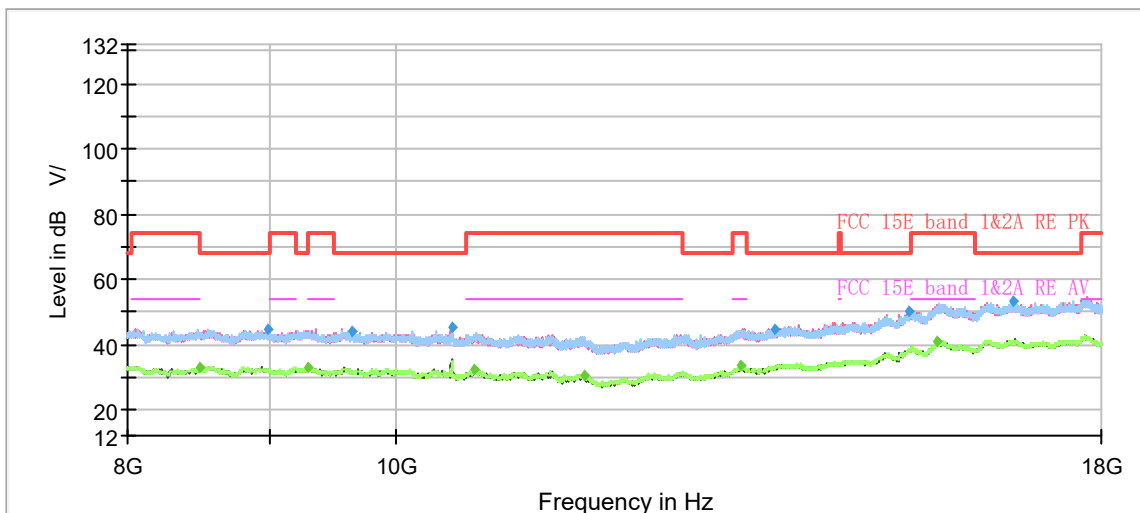

Radiates Emission from 8GHz to 18GHz

Frequency (MHz)	MaxPeak (dBμV/m)	Average (dBμV/m)	Limit (dBμV/m)	Margin (dB)	Meas. Time (ms)	Height (cm)	Pol	Azimuth (deg)	Corr. (dB/m)
1196.88	---	35.29	54.00	18.71	500.00	100.0	V	0.00	-7
1251.13	43.44	---	68.20	24.76	500.00	100.0	H	192.00	-7
1679.88	---	33.77	54.00	20.23	500.00	100.0	V	113.00	-5
1924.00	46.19	---	68.20	22.01	500.00	200.0	H	121.00	-3
2256.50	---	34.17	54.00	19.83	500.00	100.0	V	31.00	-2
2512.00	47.16	---	68.20	21.04	500.00	100.0	V	0.00	-1
2718.50	---	36.41	54.00	17.59	500.00	200.0	V	334.00	0
3558.50	50.93	---	68.20	17.27	500.00	100.0	V	118.00	4
4049.38	---	39.48	54.00	14.52	500.00	200.0	V	75.00	5
4460.63	52.55	---	68.20	15.65	500.00	100.0	V	89.00	7
6092.50	54.05	---	68.20	14.15	500.00	200.0	H	152.00	9
7585.25	---	42.55	54.00	11.45	500.00	200.0	H	137.00	11

Remark: 1. Correction Factor = Antenna factor + Insertion loss (cable loss + amplifier gain)

2. Margin = Limit –MAX Peak/ Average

802.11n (HT20) CH52

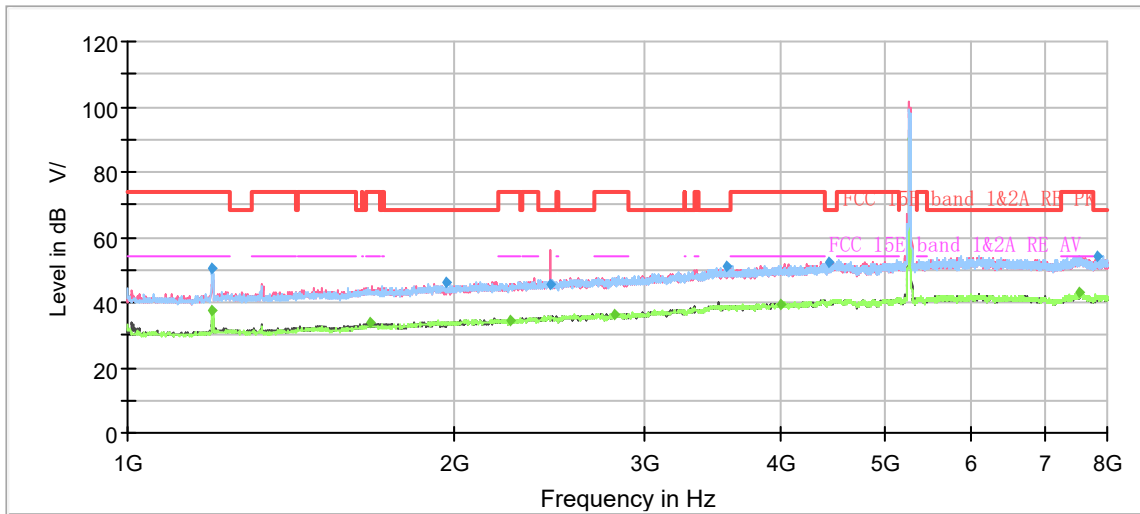

Note: The signal beyond the limit is carrier.  
Radiates Emission from 1GHz to 8GHz

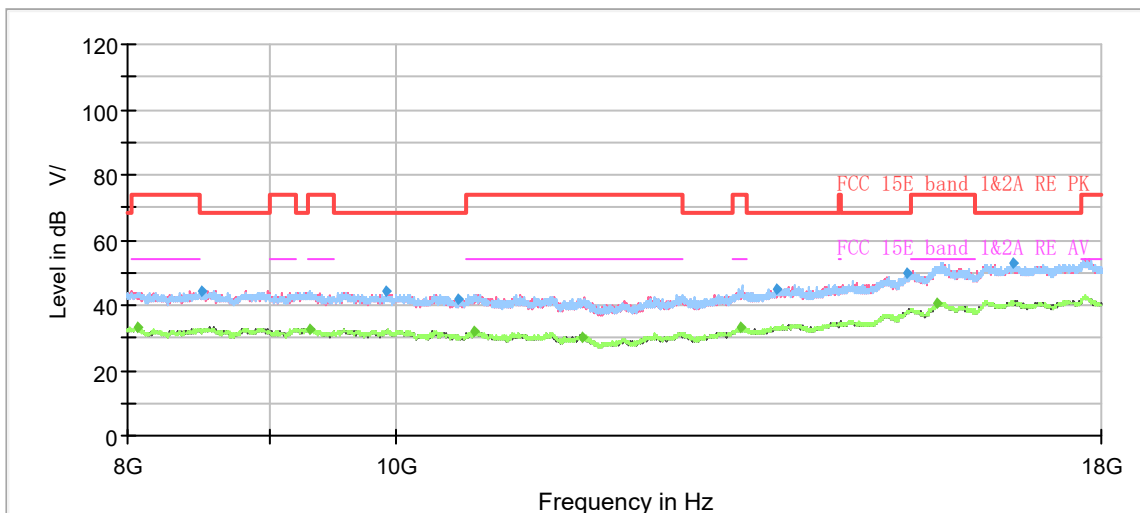

Radiates Emission from 8GHz to 18GHz

Frequency (MHz)	MaxPeak (dB $\mu$ V/m)	Average (dB $\mu$ V/m)	Limit (dB $\mu$ V/m)	Margin (dB)	Meas. Time (ms)	Height (cm)	Pol	Azimuth (deg)	Corr. (dB/m)
1195.13	50.24	---	74.00	23.76	500.00	200.0	H	99.00	-7
1197.75	---	37.71	54.00	16.29	500.00	200.0	H	109.00	-7
1672.88	---	33.57	54.00	20.43	500.00	100.0	V	36.00	-5
1969.50	46.16	---	68.20	22.04	500.00	200.0	H	339.00	-3
2249.50	---	34.73	54.00	19.27	500.00	100.0	V	45.00	-2
2453.38	45.38	---	68.20	22.82	500.00	100.0	V	74.00	-1
2813.88	---	36.30	54.00	17.70	500.00	200.0	H	214.00	0
3569.88	51.00	---	68.20	17.20	500.00	200.0	V	120.00	4
3996.88	---	39.67	54.00	14.33	500.00	200.0	H	124.00	5
4434.38	52.20	---	68.20	16.00	500.00	100.0	H	338.00	6
7542.38	---	43.25	54.00	10.75	500.00	100.0	H	0.00	11
7834.63	54.38	---	68.20	13.82	500.00	200.0	V	150.00	11

**Remark: 1. Correction Factor = Antenna factor + Insertion loss (cable loss + amplifier gain)**

**2. Margin = Limit –MAX Peak/ Average**

802.11n (HT20) CH60

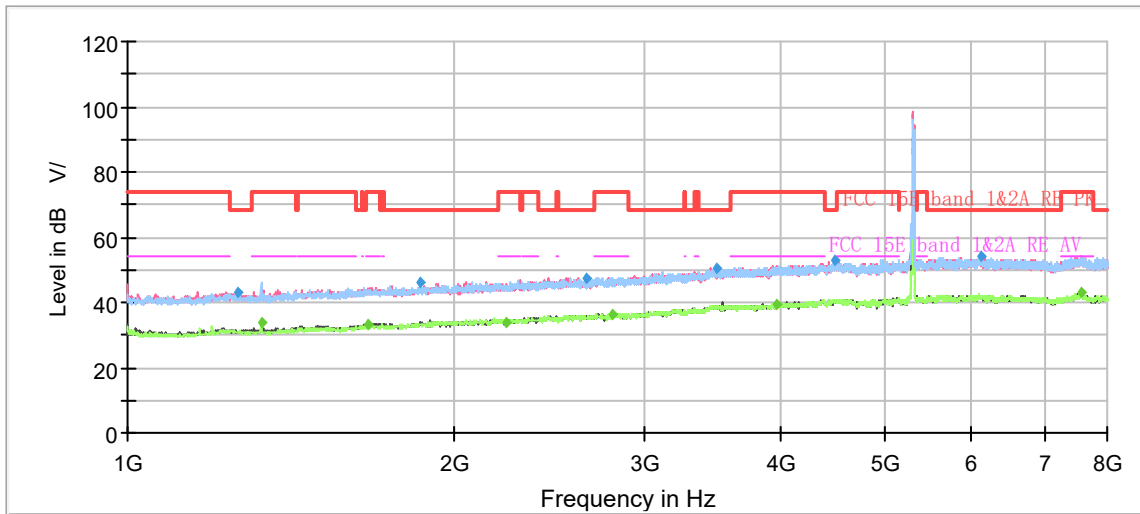

Note: The signal beyond the limit is carrier.  
Radiates Emission from 1GHz to 8GHz

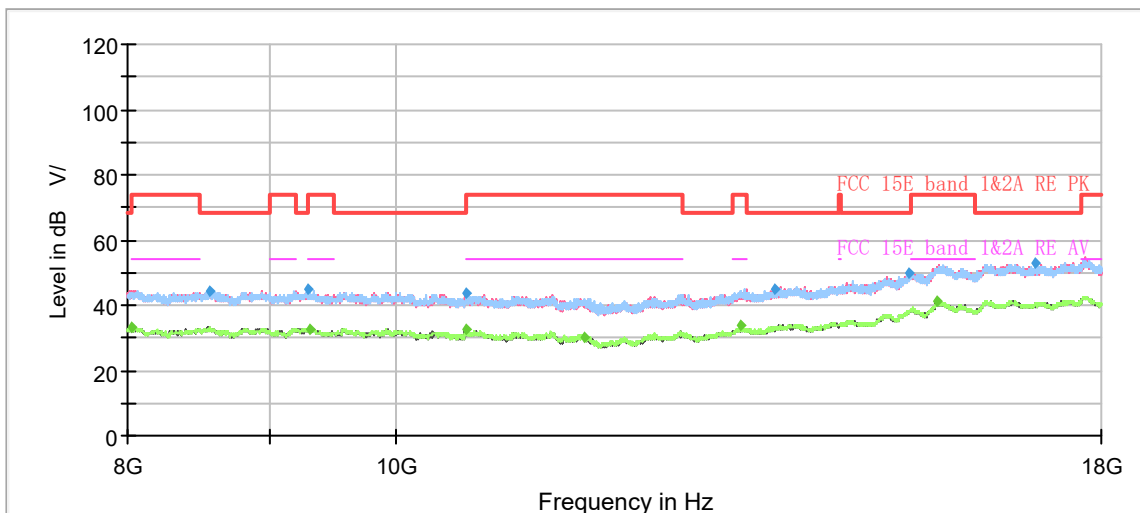

Radiates Emission from 8GHz to 18GHz

Frequency (MHz)	MaxPeak (dBμV/m)	Average (dBμV/m)	Limit (dBμV/m)	Margin (dB)	Meas. Time (ms)	Height (cm)	Pol	Azimuth (deg)	Corr. (dB/m)
1264.25	42.98	---	68.20	25.22	500.00	100.0	V	203.00	-7
1327.25	---	33.79	54.00	20.21	500.00	100.0	H	133.00	-7
1663.25	---	33.49	54.00	20.51	500.00	200.0	V	299.00	-5
1860.13	46.18	---	68.20	22.02	500.00	200.0	V	193.00	-4
2232.88	---	34.11	54.00	19.89	500.00	100.0	V	174.00	-2
2652.00	47.50	---	68.20	20.70	500.00	100.0	H	293.00	0
2802.50	---	36.29	54.00	17.71	500.00	100.0	V	74.00	0
3497.25	50.35	---	68.20	17.85	500.00	100.0	H	208.00	4
3968.88	---	39.47	54.00	14.53	500.00	200.0	H	62.00	5
4480.75	52.75	---	68.20	15.45	500.00	100.0	H	302.00	7
6115.25	53.85	---	68.20	14.35	500.00	200.0	H	38.00	9
7578.25	---	42.98	54.00	11.02	500.00	100.0	H	327.00	11

**Remark: 1. Correction Factor = Antenna factor + Insertion loss (cable loss + amplifier gain)**

**2. Margin = Limit –MAX Peak/ Average**



802.11n (HT20) CH64

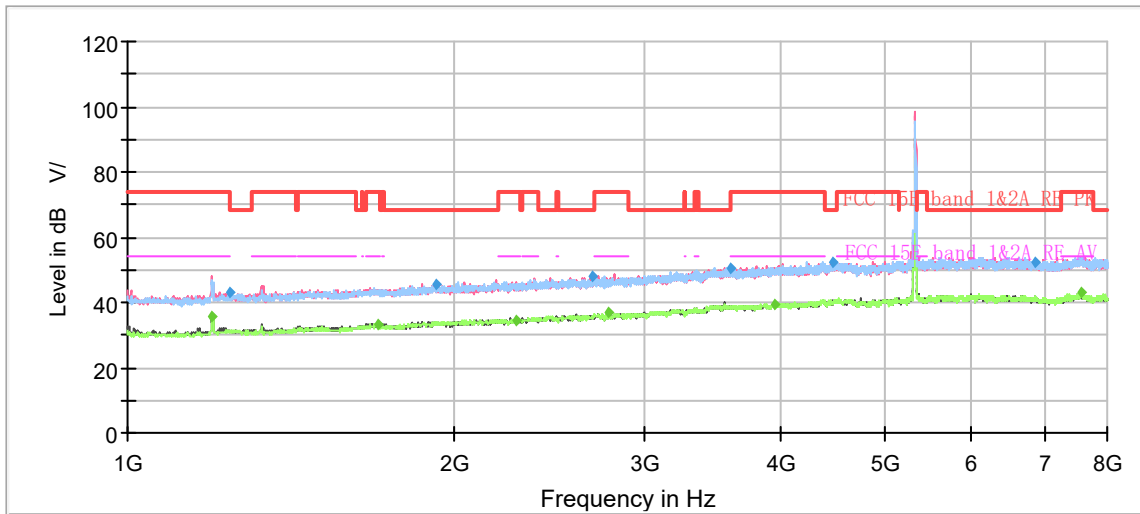

Note: The signal beyond the limit is carrier.  
Radiates Emission from 1GHz to 8GHz

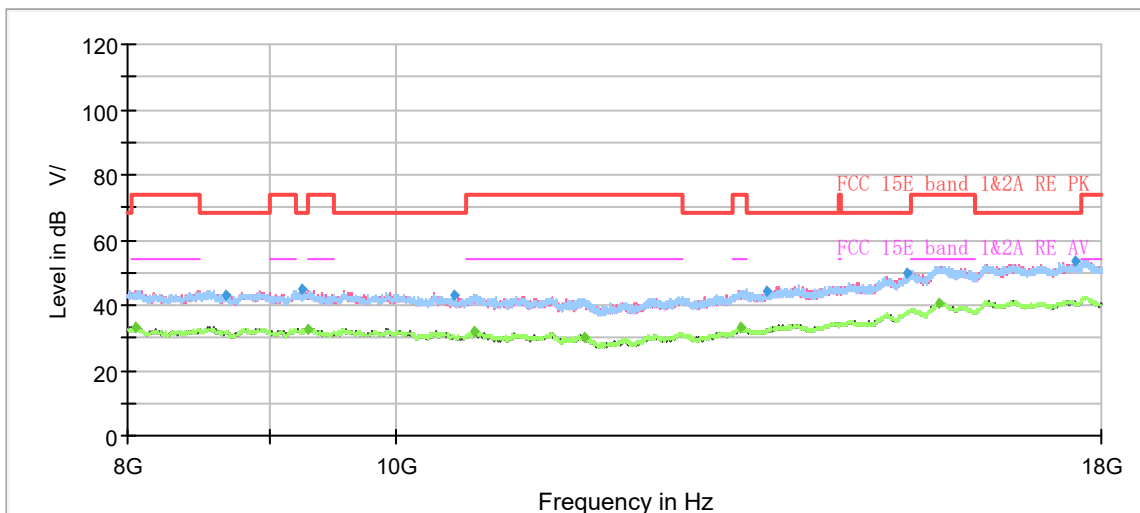

Radiates Emission from 8GHz to 18GHz

Frequency (MHz)	MaxPeak (dBμV/m)	Average (dBμV/m)	Limit (dBμV/m)	Margin (dB)	Meas. Time (ms)	Height (cm)	Pol	Azimuth (deg)	Corr. (dB/m)
1197.75	---	35.90	54.00	18.10	500.00	100.0	V	359.00	-7
1242.38	43.00	---	68.20	25.20	500.00	100.0	H	173.00	-7
1700.00	---	33.47	54.00	20.53	500.00	200.0	V	349.00	-5
1921.38	45.67	---	68.20	22.53	500.00	100.0	H	0.00	-3
2281.88	---	34.60	54.00	19.40	500.00	200.0	H	116.00	-2
2680.00	47.74	---	68.20	20.46	500.00	200.0	V	188.00	0
2778.88	---	36.66	54.00	17.34	500.00	200.0	H	116.00	0
3593.50	50.50	---	68.20	17.70	500.00	200.0	H	216.00	4
3957.50	---	39.46	54.00	14.54	500.00	100.0	H	234.00	5
4465.00	52.14	---	68.20	16.06	500.00	200.0	H	132.00	7
6850.25	52.42	---	68.20	15.78	500.00	200.0	V	349.00	9
7577.38	---	42.92	54.00	11.08	500.00	100.0	H	173.00	11

**Remark: 1. Correction Factor = Antenna factor + Insertion loss (cable loss + amplifier gain)**

**2. Margin = Limit –MAX Peak/ Average**

802.11n (HT20) CH100

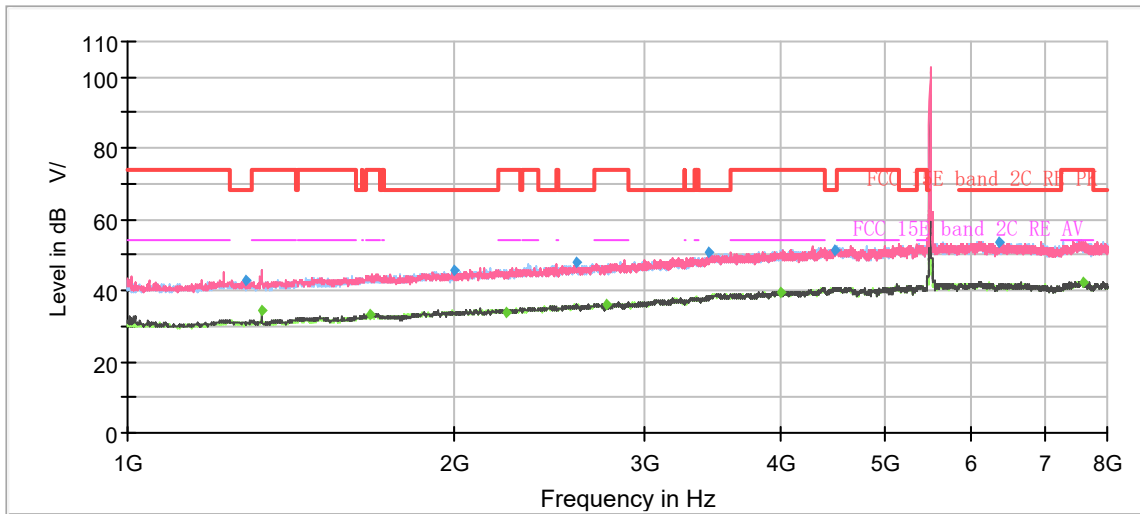

Note: The signal beyond the limit is carrier.  
Radiates Emission from 1GHz to 8GHz

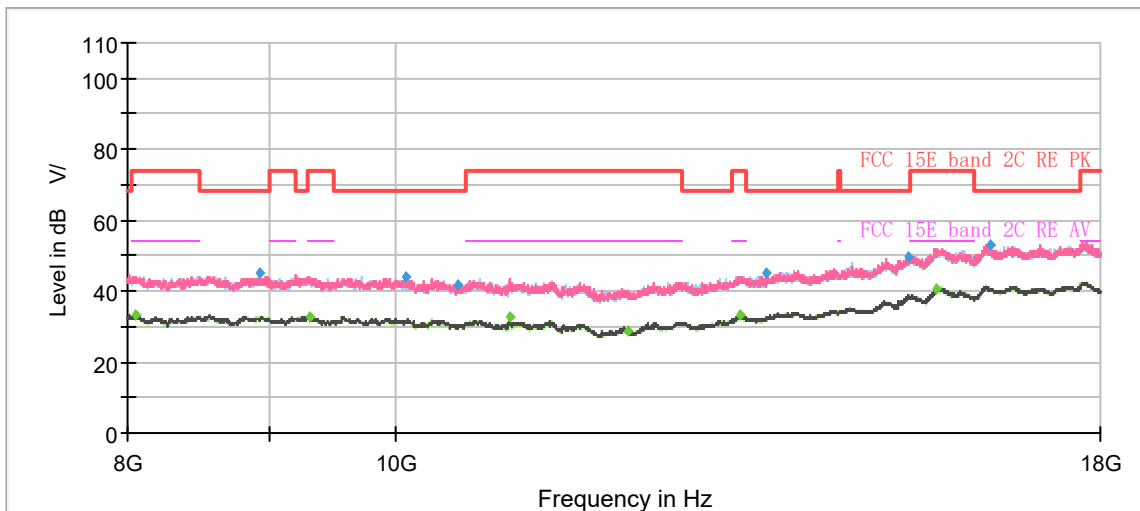

Radiates Emission from 8GHz to 18GHz

Frequency (MHz)	MaxPeak (dB $\mu$ V/m)	Average (dB $\mu$ V/m)	Limit (dB $\mu$ V/m)	Margin (dB)	Meas. Time (ms)	Height (cm)	Pol	Azimuth (deg)	Corr. (dB/m)
1286.13	42.81	---	68.20	25.39	500.00	200.0	V	25.00	-7
1330.75	---	34.25	54.00	19.75	500.00	100.0	V	4.00	-7
1671.13	---	33.37	54.00	20.63	500.00	200.0	H	334.00	-5
1997.50	45.82	---	68.20	22.38	500.00	100.0	H	178.00	-3
2232.88	---	34.10	54.00	19.90	500.00	200.0	H	354.00	-2
2591.63	47.83	---	68.20	20.37	500.00	200.0	H	349.00	0
2758.75	---	36.21	54.00	17.79	500.00	100.0	H	91.00	0
3436.88	50.52	---	68.20	17.68	500.00	200.0	V	310.00	3
3994.25	---	39.42	54.00	14.58	500.00	100.0	V	161.00	5
4479.00	51.60	---	68.20	16.60	500.00	200.0	H	222.00	7
6367.25	53.61	---	68.20	14.59	500.00	200.0	H	171.00	9
7586.13	---	42.56	54.00	11.44	500.00	100.0	V	300.00	11

**Remark: 1. Correction Factor = Antenna factor + Insertion loss (cable loss + amplifier gain)**

**2. Margin = Limit –MAX Peak/ Average**

802.11n (HT20) CH116

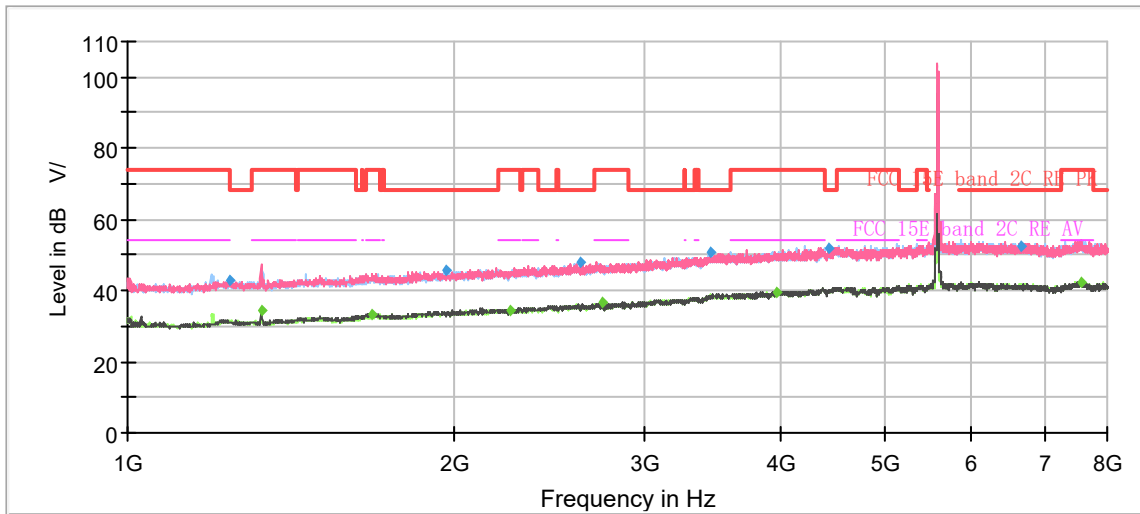

Note: The signal beyond the limit is carrier.  
Radiates Emission from 1GHz to 8GHz

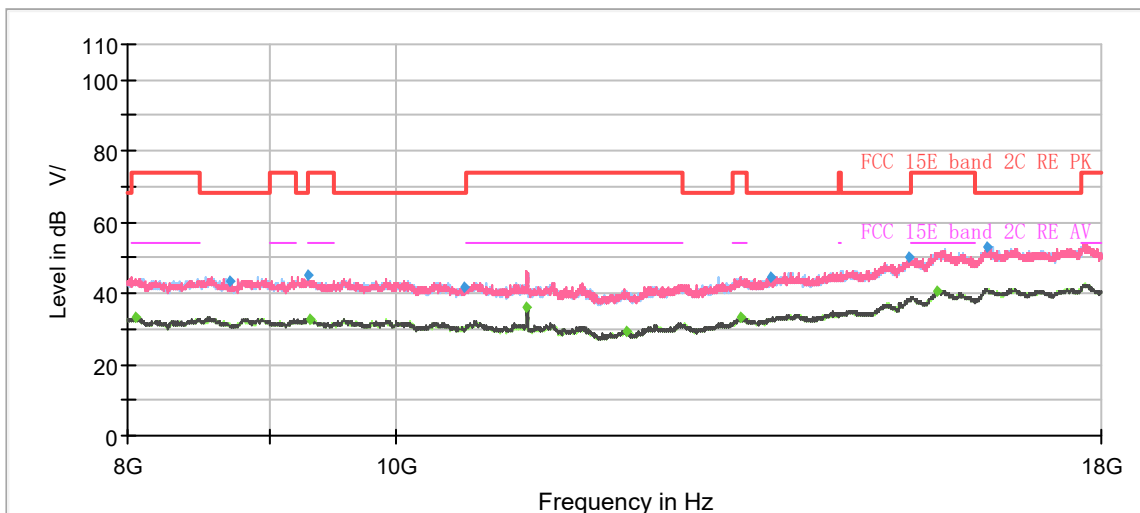

Radiates Emission from 8GHz to 18GHz

Frequency (MHz)	MaxPeak (dBμV/m)	Average (dBμV/m)	Limit (dBμV/m)	Margin (dB)	Meas. Time (ms)	Height (cm)	Pol	Azimuth (deg)	Corr. (dB/m)
1242.38	42.88	---	68.20	25.32	500.00	200.0	H	344.00	-7
1328.13	---	34.48	54.00	19.52	500.00	100.0	V	359.00	-7
1679.88	---	33.44	54.00	20.56	500.00	100.0	V	1.00	-5
1969.50	45.71	---	68.20	22.49	500.00	100.0	V	318.00	-3
2251.25	---	34.56	54.00	19.44	500.00	200.0	V	210.00	-2
2619.63	47.80	---	68.20	20.40	500.00	100.0	V	337.00	0
2739.50	---	36.71	54.00	17.29	500.00	100.0	V	282.00	0
3443.00	50.73	---	68.20	17.47	500.00	200.0	V	27.00	3
3966.25	---	39.63	54.00	14.37	500.00	100.0	H	100.00	5
4429.13	52.02	---	68.20	16.18	500.00	200.0	H	162.00	6
6671.75	52.61	---	68.20	15.59	500.00	100.0	H	51.00	9
7572.13	---	42.53	54.00	11.47	500.00	100.0	H	143.00	11

**Remark: 1. Correction Factor = Antenna factor + Insertion loss (cable loss + amplifier gain)**

**2. Margin = Limit –MAX Peak/ Average**

802.11n (HT20) CH140

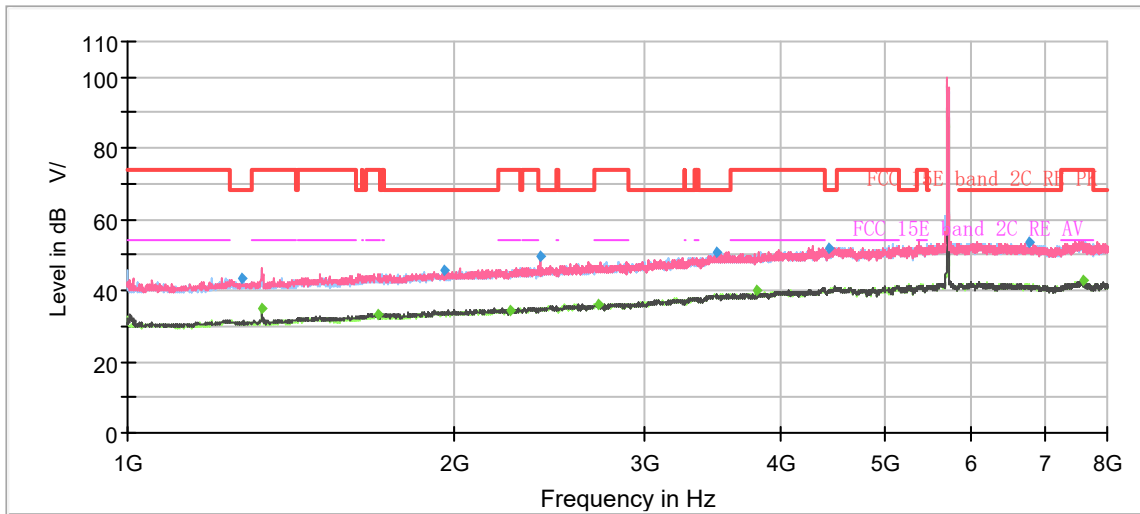

Note: The signal beyond the limit is carrier.  
Radiates Emission from 1GHz to 8GHz

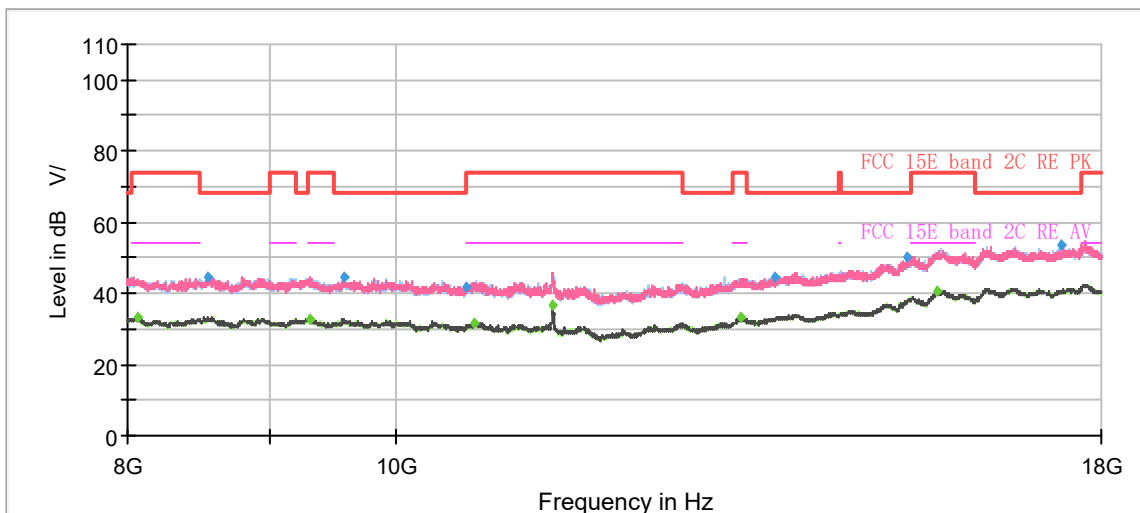

Radiates Emission from 8GHz to 18GHz

Frequency (MHz)	MaxPeak (dB $\mu$ V/m)	Average (dB $\mu$ V/m)	Limit (dB $\mu$ V/m)	Margin (dB)	Meas. Time (ms)	Height (cm)	Pol	Azimuth (deg)	Corr. (dB/m)
1274.75	43.24	---	68.20	24.96	500.00	200.0	V	0.00	-7
1328.13	---	34.77	54.00	19.23	500.00	200.0	V	7.00	-7
1698.25	---	33.27	54.00	20.73	500.00	100.0	V	253.00	-5
1959.88	45.57	---	68.20	22.63	500.00	200.0	H	124.00	-3
2248.63	---	34.57	54.00	19.43	500.00	200.0	V	27.00	-2
2399.13	49.47	---	68.20	18.73	500.00	200.0	V	194.00	-1
2718.50	---	36.34	54.00	17.66	500.00	100.0	H	26.00	0
3493.75	50.83	---	68.20	17.37	500.00	100.0	H	0.00	4
3800.00	---	40.33	54.00	13.67	500.00	200.0	H	65.00	4
4432.63	51.89	---	68.20	16.31	500.00	200.0	V	289.00	6
6772.38	53.40	---	68.20	14.80	500.00	200.0	H	70.00	9
7590.50	---	42.76	54.00	11.24	500.00	100.0	V	40.00	11

Remark: 1. Correction Factor = Antenna factor + Insertion loss (cable loss + amplifier gain)

2. Margin = Limit - MAX Peak/ Average



802.11n (HT20) CH144

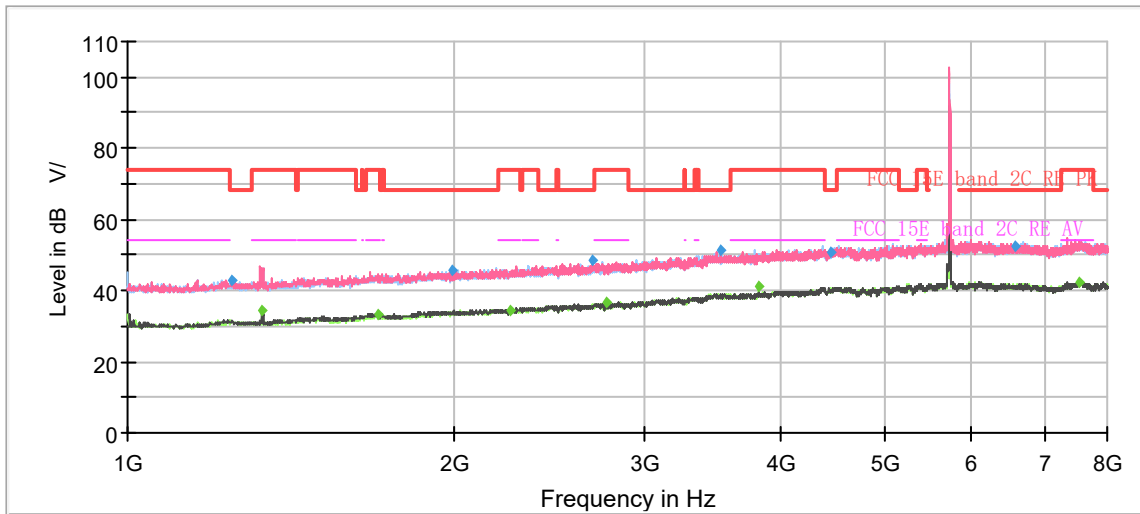

Note: The signal beyond the limit is carrier.  
Radiates Emission from 1GHz to 8GHz

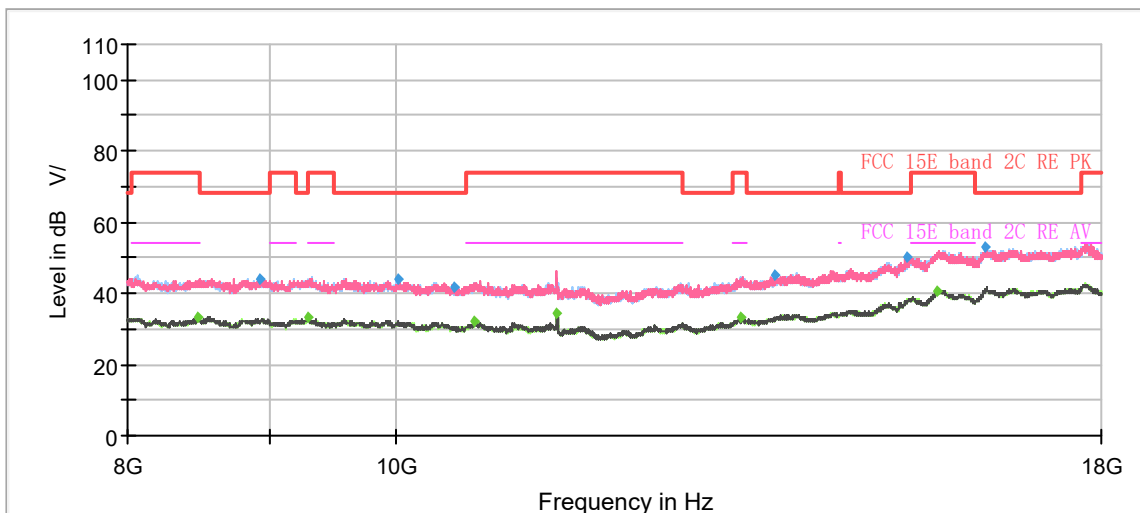

Radiates Emission from 8GHz to 18GHz

Frequency (MHz)	MaxPeak (dB $\mu$ V/m)	Average (dB $\mu$ V/m)	Limit (dB $\mu$ V/m)	Margin (dB)	Meas. Time (ms)	Height (cm)	Pol	Azimuth (deg)	Corr. (dB/m)
1245.88	42.94	---	68.20	25.26	500.00	200.0	V	71.00	-7
1329.88	---	34.65	54.00	19.35	500.00	100.0	V	356.00	-7
1700.00	---	33.30	54.00	20.70	500.00	200.0	V	220.00	-5
1993.13	45.64	---	68.20	22.56	500.00	200.0	V	156.00	-3
2257.38	---	34.52	54.00	19.48	500.00	200.0	V	0.00	-2
2685.25	48.46	---	68.20	19.74	500.00	200.0	H	204.00	0
2759.63	---	36.46	54.00	17.54	500.00	200.0	H	328.00	0
3515.63	51.48	---	68.20	16.72	500.00	100.0	H	2.00	4
3813.13	---	41.19	54.00	12.81	500.00	200.0	H	66.00	4
4442.25	50.94	---	68.20	17.26	500.00	200.0	H	16.00	6
6588.63	52.39	---	68.20	15.81	500.00	100.0	H	33.00	9
7545.00	---	42.54	54.00	11.46	500.00	200.0	H	204.00	11

**Remark: 1. Correction Factor = Antenna factor + Insertion loss (cable loss + amplifier gain)**

**2. Margin = Limit –MAX Peak/ Average**

802.11n (HT20) CH149

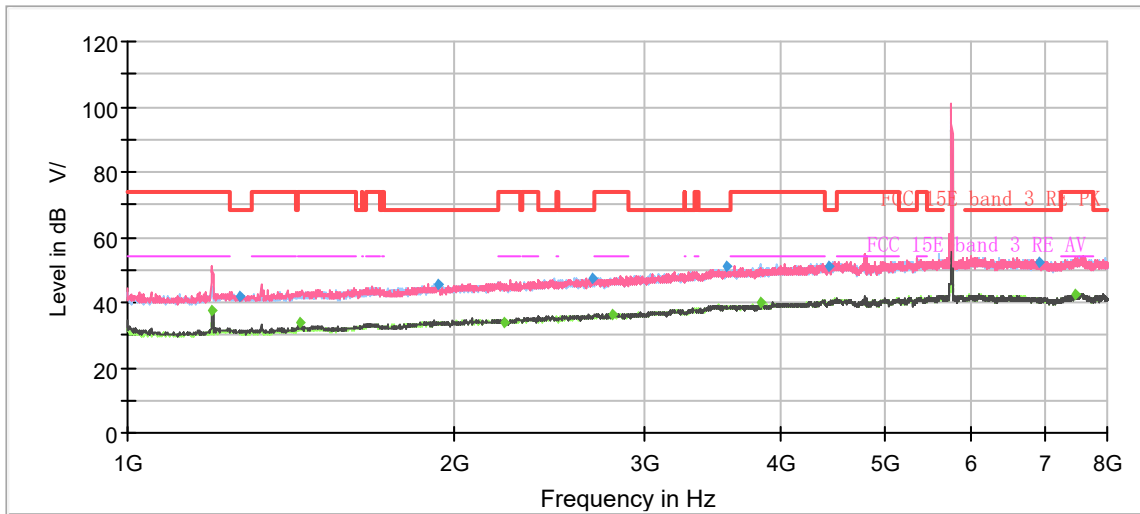

Note: The signal beyond the limit is carrier.  
Radiates Emission from 1GHz to 8GHz

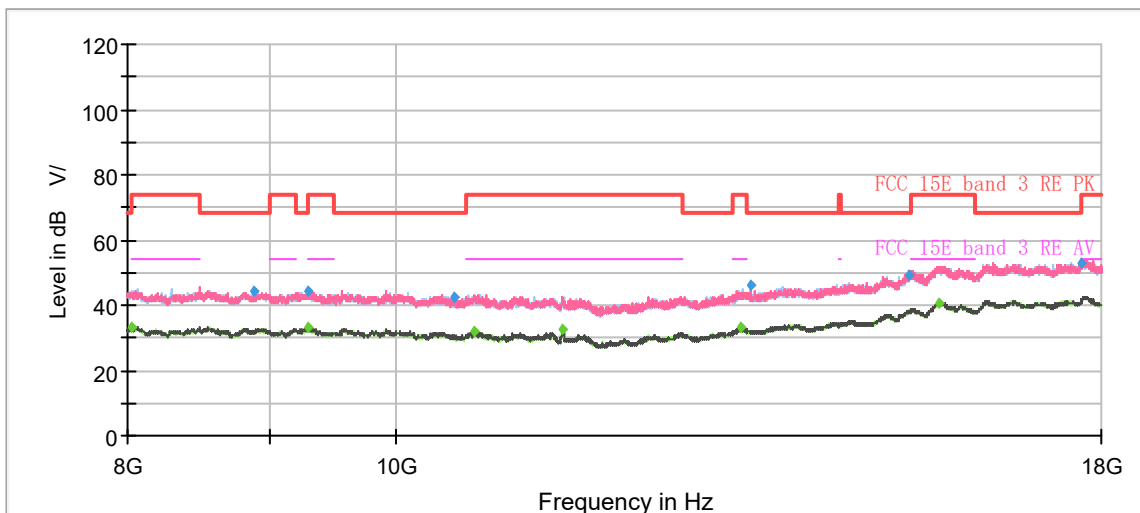

Radiates Emission from 8GHz to 18GHz

Frequency (MHz)	MaxPeak (dB $\mu$ V/m)	Average (dB $\mu$ V/m)	Limit (dB $\mu$ V/m)	Margin (dB)	Meas. Time (ms)	Height (cm)	Pol	Azimuth (deg)	Corr. (dB/m)
1270.38	42.13	---	68.20	26.07	500.00	200.0	V	185.00	-7
1196.00	---	37.68	54.00	16.32	500.00	200.0	V	185.00	-7
1441.00	---	33.57	54.00	20.43	500.00	100.0	V	115.00	-6
1930.13	45.78	---	68.20	22.42	500.00	100.0	V	0.00	-3
2221.50	---	33.92	54.00	20.08	500.00	200.0	H	279.00	-2
2685.25	47.63	---	68.20	20.57	500.00	100.0	V	169.00	0
2799.88	---	36.26	54.00	17.74	500.00	200.0	H	274.00	0
3562.00	51.37	---	68.20	16.83	500.00	200.0	V	302.00	4
3829.75	---	40.13	54.00	13.87	500.00	200.0	H	294.00	4
4438.75	51.10	---	68.20	17.10	500.00	200.0	V	209.00	6
6918.50	52.12	---	68.20	16.08	500.00	100.0	H	17.00	9
7468.00	---	42.50	54.00	11.50	500.00	100.0	V	22.00	11

**Remark: 1. Correction Factor = Antenna factor + Insertion loss (cable loss + amplifier gain)**

**2. Margin = Limit –MAX Peak/ Average**

802.11n (HT20) CH157

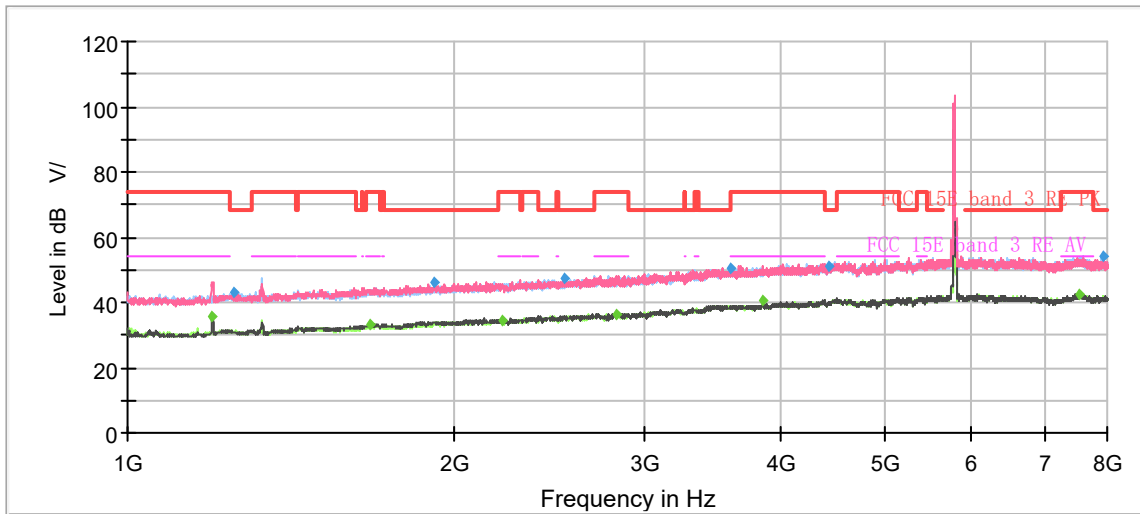

Note: The signal beyond the limit is carrier.  
Radiates Emission from 1GHz to 8GHz

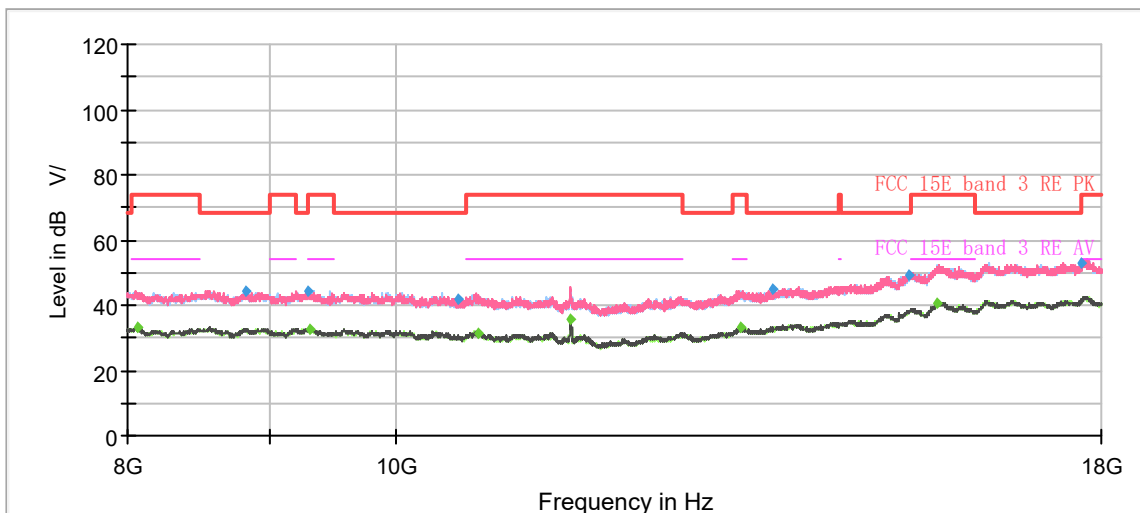

Radiates Emission from 8GHz to 18GHz

Frequency (MHz)	MaxPeak (dB $\mu$ V/m)	Average (dB $\mu$ V/m)	Limit (dB $\mu$ V/m)	Margin (dB)	Meas. Time (ms)	Height (cm)	Pol	Azimuth (deg)	Corr. (dB/m)
1197.75	---	35.71	54.00	18.29	500.00	100.0	V	356.00	-7
1251.13	43.21	---	68.20	24.99	500.00	200.0	H	135.00	-7
1671.13	---	33.26	54.00	20.74	500.00	200.0	V	116.00	-5
1916.13	46.02	---	68.20	22.18	500.00	100.0	V	356.00	-3
2215.38	---	34.29	54.00	19.71	500.00	100.0	H	17.00	-2
2531.25	47.48	---	68.20	20.72	500.00	200.0	H	244.00	0
2827.00	---	36.34	54.00	17.66	500.00	200.0	V	162.00	1
3589.13	50.34	---	68.20	17.86	500.00	100.0	V	188.00	4
3856.88	---	40.61	54.00	13.39	500.00	200.0	H	195.00	5
4432.63	51.10	---	68.20	17.10	500.00	200.0	H	0.00	6
7541.50	---	42.50	54.00	11.50	500.00	200.0	H	288.00	11
7916.00	54.06	---	68.20	14.14	500.00	200.0	H	269.00	11

**Remark: 1. Correction Factor = Antenna factor + Insertion loss (cable loss + amplifier gain)**

**2. Margin = Limit –MAX Peak/ Average**

802.11n (HT20) CH165

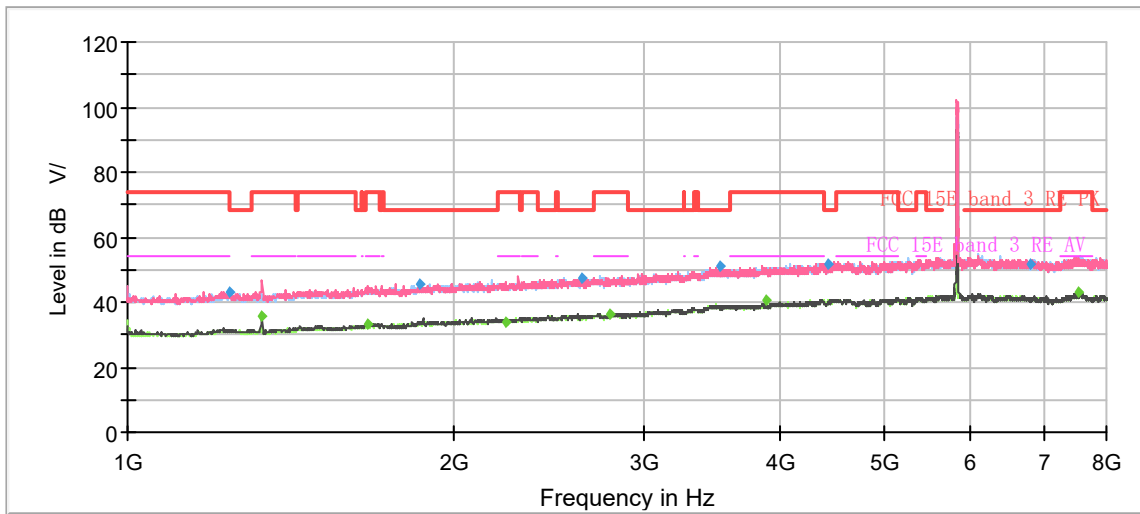

Note: The signal beyond the limit is carrier.  
Radiates Emission from 1GHz to 8GHz

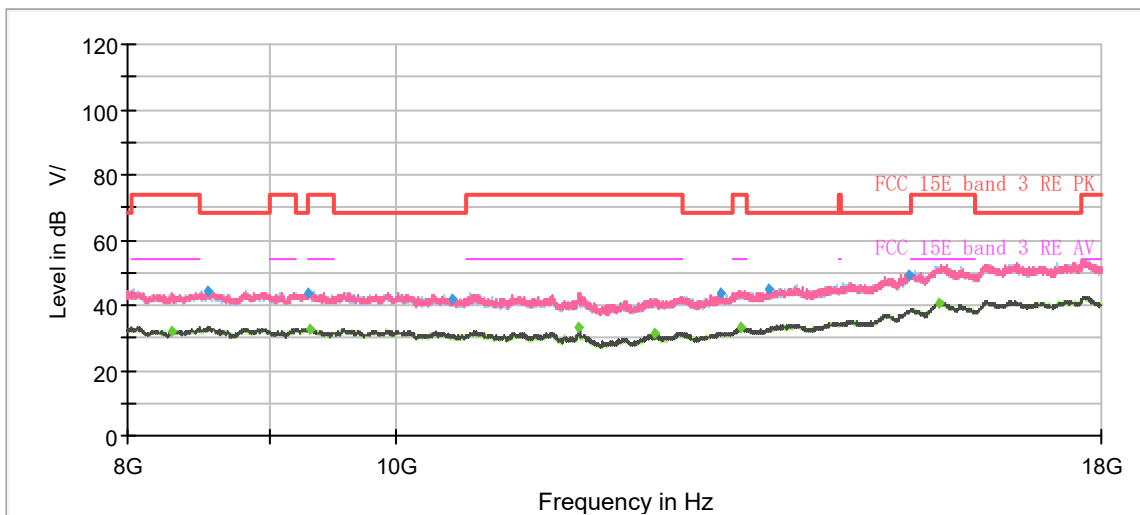

Radiates Emission from 8GHz to 18GHz

Frequency (MHz)	MaxPeak (dBμV/m)	Average (dBμV/m)	Limit (dBμV/m)	Margin (dB)	Meas. Time (ms)	Height (cm)	Pol	Azimuth (deg)	Corr. (dB/m)
1241.50	42.88	---	68.20	25.32	500.00	200.0	H	340.00	-7
1331.63	---	35.48	54.00	18.52	500.00	100.0	V	184.00	-7
1663.25	---	33.36	54.00	20.64	500.00	200.0	V	52.00	-5
1861.88	45.76	---	68.20	22.44	500.00	200.0	V	120.00	-4
2232.88	---	34.00	54.00	20.00	500.00	200.0	H	251.00	-2
2625.75	47.19	---	68.20	21.01	500.00	100.0	H	42.00	0
2781.50	---	36.37	54.00	17.63	500.00	200.0	H	321.00	0
3514.75	51.03	---	68.20	17.17	500.00	100.0	V	145.00	4
3883.13	---	40.86	54.00	13.14	500.00	200.0	H	62.00	5
4422.13	51.84	---	68.20	16.36	500.00	200.0	V	96.00	6
6810.00	51.88	---	68.20	16.32	500.00	200.0	V	72.00	9
7550.25	---	42.83	54.00	11.17	500.00	200.0	H	41.00	11

**Remark: 1. Correction Factor = Antenna factor + Insertion loss (cable loss + amplifier gain)**

**2. Margin = Limit –MAX Peak/ Average**



802.11n (HT40) CH38

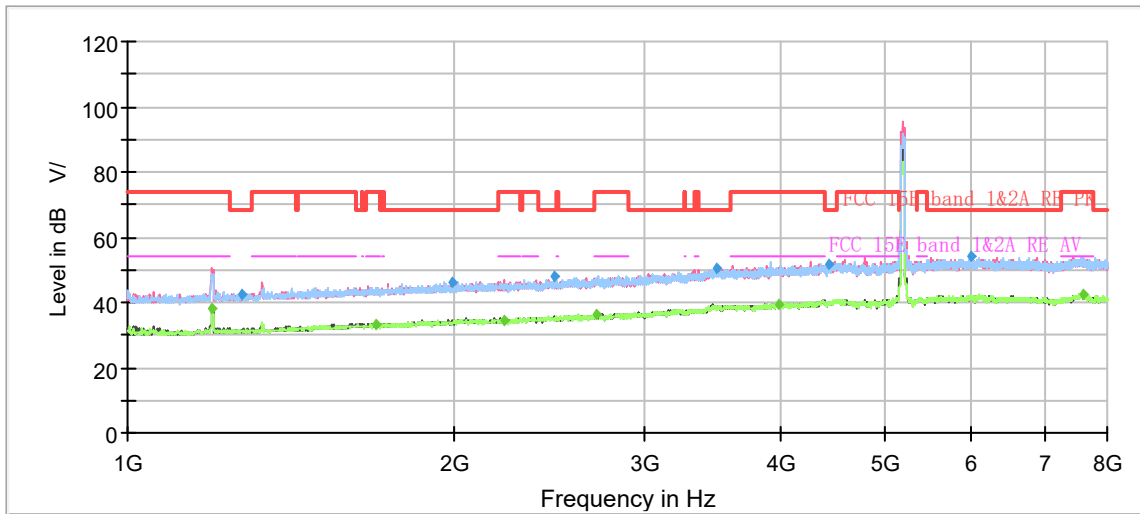

Note: The signal beyond the limit is carrier.  
Radiates Emission from 1GHz to 8GHz

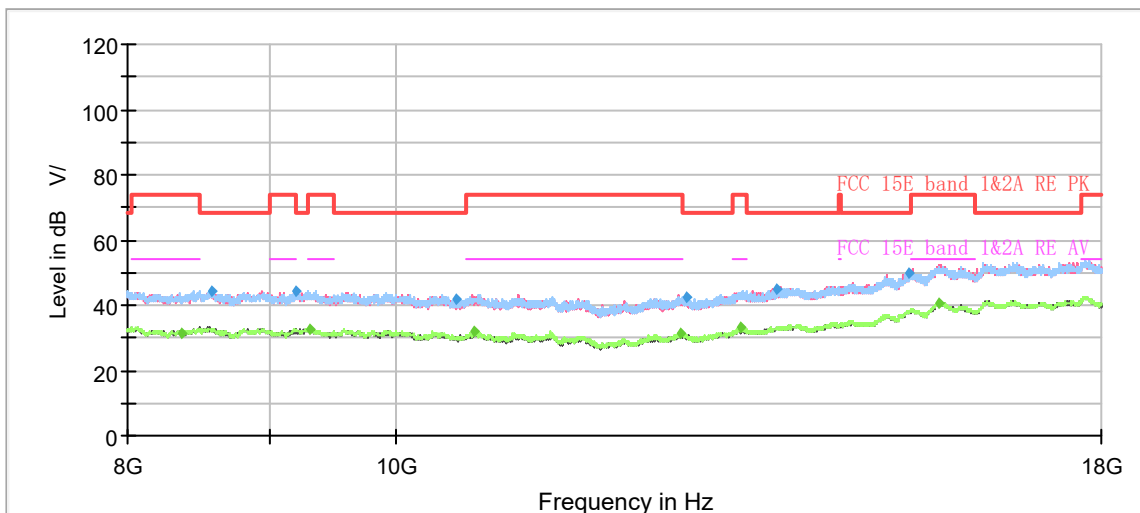

Radiates Emission from 8GHz to 18GHz

Frequency (MHz)	MaxPeak (dBμV/m)	Average (dBμV/m)	Limit (dBμV/m)	Margin (dB)	Meas. Time (ms)	Height (cm)	Pol	Azimuth (deg)	Corr. (dB/m)
1196.88	---	38.24	54.00	15.76	500.00	100.0	V	162.00	-7
1274.75	42.72	---	68.20	25.48	500.00	100.0	V	162.00	-7
1691.25	---	33.34	54.00	20.66	500.00	200.0	V	114.00	-5
1991.38	46.25	---	68.20	21.95	500.00	200.0	V	124.00	-3
2228.50	---	34.62	54.00	19.38	500.00	200.0	V	193.00	-2
2475.25	47.90	---	68.20	20.30	500.00	200.0	V	76.00	-1
2703.63	---	36.16	54.00	17.84	500.00	200.0	V	22.00	0
3491.13	50.44	---	68.20	17.76	500.00	200.0	H	150.00	4
3990.75	---	39.60	54.00	14.40	500.00	200.0	H	116.00	5
4438.75	51.54	---	68.20	16.66	500.00	100.0	V	258.00	6
6000.63	54.12	---	68.20	14.08	500.00	100.0	V	302.00	9
7590.50	---	42.48	54.00	11.52	500.00	200.0	V	90.00	11

**Remark: 1. Correction Factor = Antenna factor + Insertion loss (cable loss + amplifier gain)**

**2. Margin = Limit –MAX Peak/ Average**

802.11n (HT40) CH46

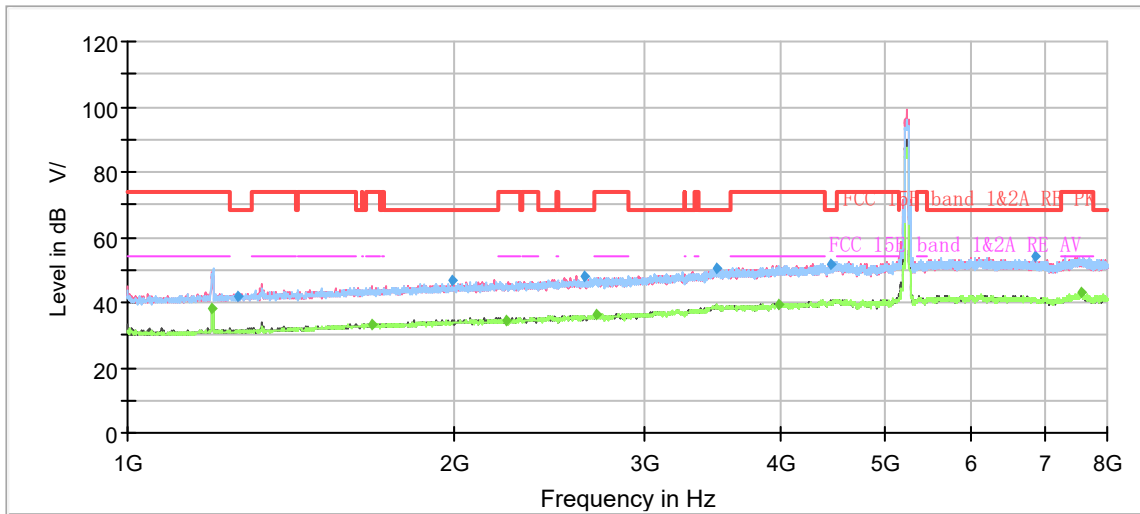

Note: The signal beyond the limit is carrier.  
Radiates Emission from 1GHz to 8GHz

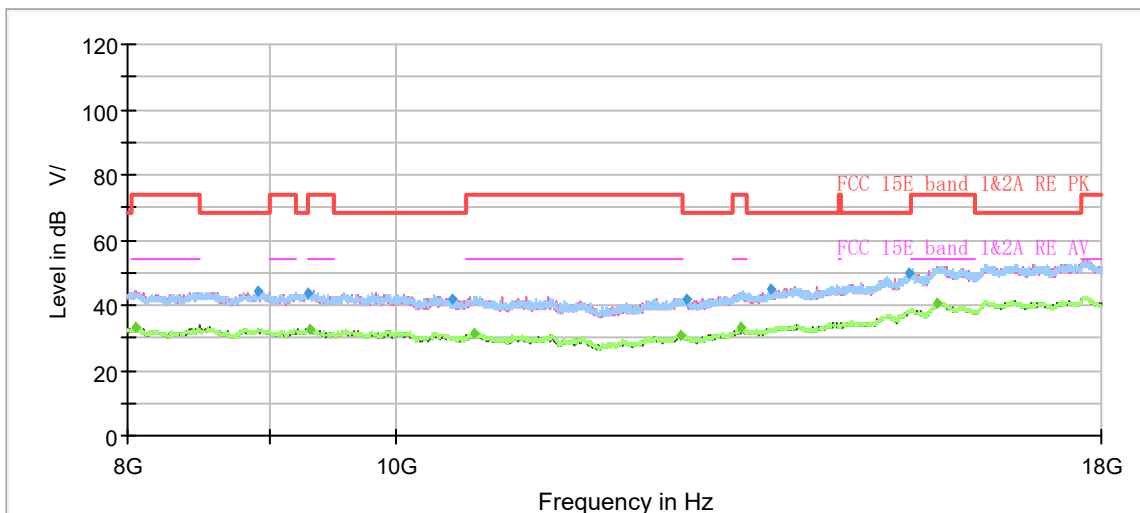

Radiates Emission from 8GHz to 18GHz

Frequency (MHz)	MaxPeak (dBμV/m)	Average (dBμV/m)	Limit (dBμV/m)	Margin (dB)	Meas. Time (ms)	Height (cm)	Pol	Azimuth (deg)	Corr. (dB/m)
1197.75	---	38.40	54.00	15.60	500.00	200.0	V	180.00	-7
1265.13	42.10	---	68.20	26.10	500.00	200.0	H	123.00	-7
1680.75	---	33.42	54.00	20.58	500.00	200.0	V	0.00	-5
1994.88	46.50	---	68.20	21.70	500.00	200.0	V	120.00	-3
2232.88	---	34.46	54.00	19.54	500.00	200.0	V	145.00	-2
2640.63	47.97	---	68.20	20.23	500.00	100.0	V	191.00	0
2702.75	---	36.30	54.00	17.70	500.00	100.0	H	12.00	0
3493.75	50.37	---	68.20	17.83	500.00	100.0	V	177.00	4
3983.75	---	39.65	54.00	14.35	500.00	100.0	V	308.00	5
4455.38	51.90	---	68.20	16.30	500.00	200.0	V	330.00	6
6853.75	54.07	---	68.20	14.13	500.00	100.0	V	17.00	9
7559.00	---	42.96	54.00	11.04	500.00	100.0	H	0.00	11

**Remark: 1. Correction Factor = Antenna factor + Insertion loss (cable loss + amplifier gain)**

**2. Margin = Limit –MAX Peak/ Average**

802.11n (HT40) CH54

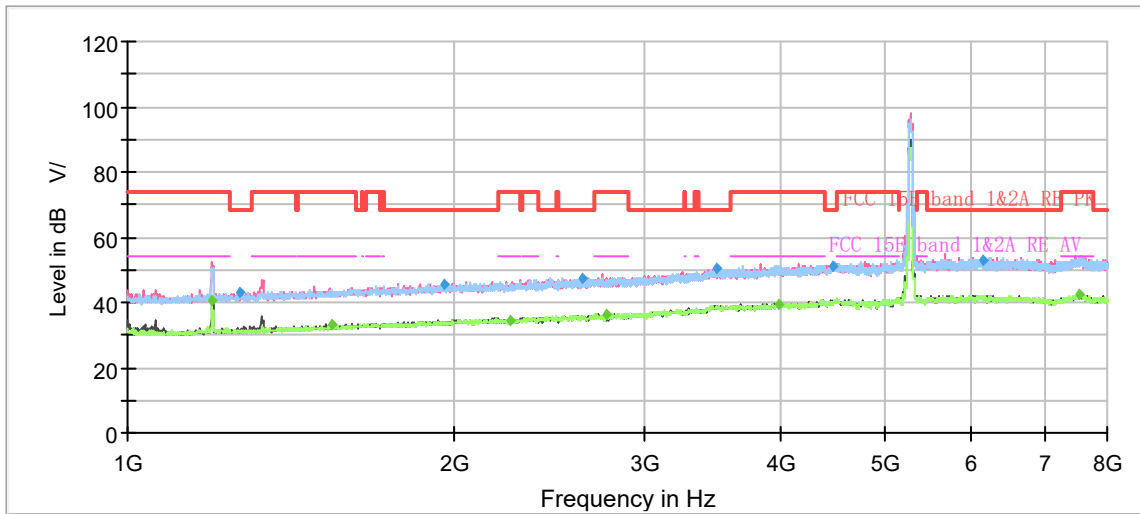

Note: The signal beyond the limit is carrier.  
Radiates Emission from 1GHz to 8GHz

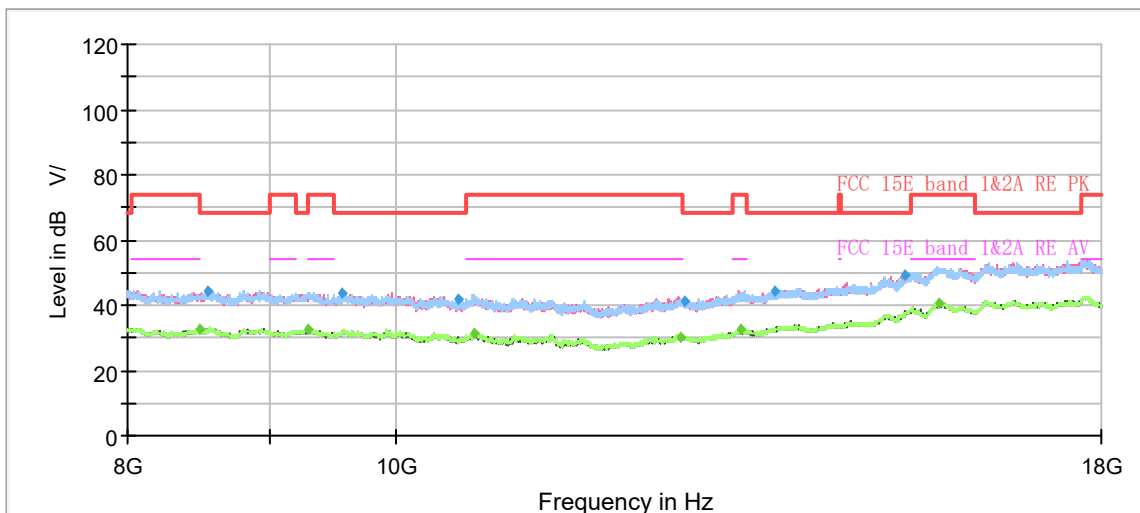

Radiates Emission from 8GHz to 18GHz

Frequency (MHz)	MaxPeak (dB $\mu$ V/m)	Average (dB $\mu$ V/m)	Limit (dB $\mu$ V/m)	Margin (dB)	Meas. Time (ms)	Height (cm)	Pol	Azimuth (deg)	Corr. (dB/m)
1197.75	---	40.41	54.00	13.59	500.00	200.0	V	153.00	-7
1266.88	42.85	---	68.20	25.35	500.00	200.0	V	144.00	-7
1540.75	---	33.41	54.00	20.59	500.00	100.0	V	104.00	-5
1959.00	45.79	---	68.20	22.41	500.00	100.0	V	37.00	-3
2251.25	---	34.37	54.00	19.63	500.00	100.0	V	230.00	-2
2622.25	47.44	---	68.20	20.76	500.00	200.0	H	81.00	0
2761.38	---	36.27	54.00	17.73	500.00	200.0	V	104.00	0
3484.13	50.70	---	68.20	17.50	500.00	200.0	H	120.00	4
3989.00	---	39.48	54.00	14.52	500.00	100.0	V	176.00	5
4465.88	51.11	---	68.20	17.09	500.00	100.0	V	66.00	7
6138.88	52.96	---	68.20	15.24	500.00	200.0	V	317.00	9
7550.25	---	42.40	54.00	11.60	500.00	100.0	V	161.00	11

**Remark: 1. Correction Factor = Antenna factor + Insertion loss (cable loss + amplifier gain)**

**2. Margin = Limit –MAX Peak/ Average**

802.11n (HT40) CH62

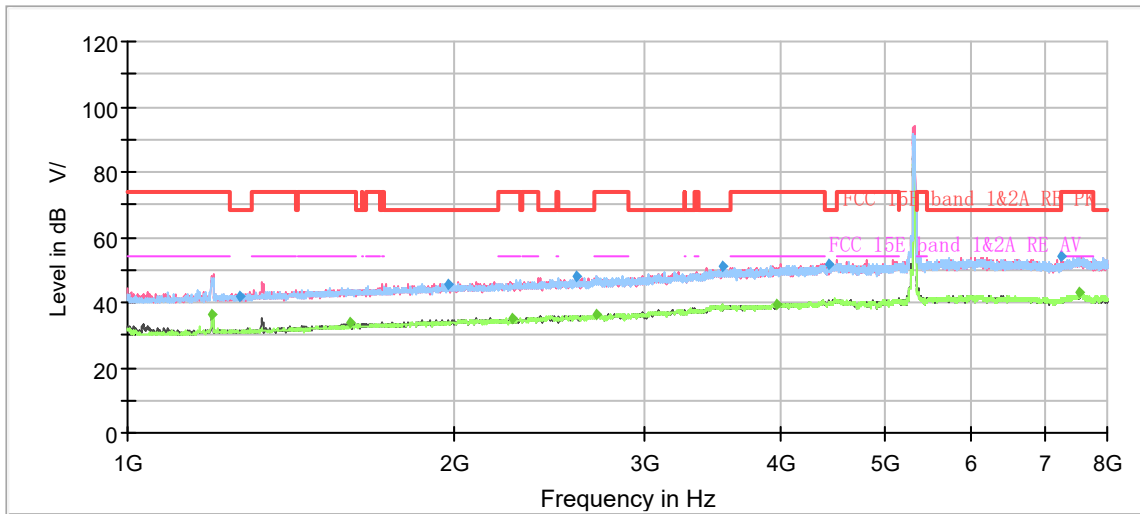

Note: The signal beyond the limit is carrier.  
Radiates Emission from 1GHz to 8GHz

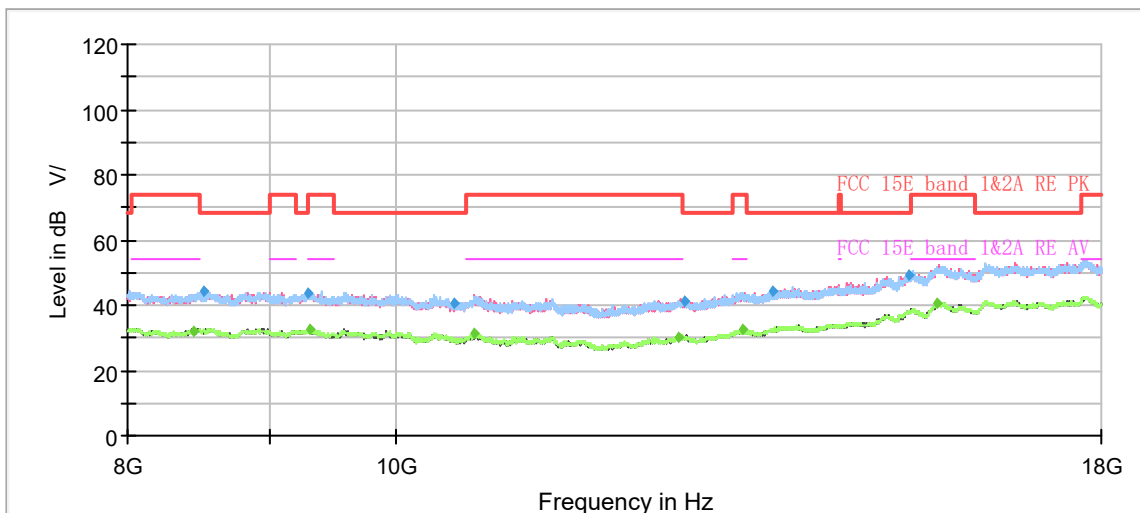

Radiates Emission from 8GHz to 18GHz

Frequency (MHz)	MaxPeak (dB $\mu$ V/m)	Average (dB $\mu$ V/m)	Limit (dB $\mu$ V/m)	Margin (dB)	Meas. Time (ms)	Height (cm)	Pol	Azimuth (deg)	Corr. (dB/m)
1196.00	---	36.51	54.00	17.49	500.00	200.0	H	65.00	-7
1266.88	42.15	---	68.20	26.05	500.00	100.0	H	155.00	-7
1601.13	---	33.99	54.00	20.01	500.00	200.0	V	122.00	-5
1971.25	45.69	---	68.20	22.51	500.00	200.0	H	37.00	-3
2261.75	---	34.95	54.00	19.05	500.00	200.0	V	327.00	-2
2587.25	47.97	---	68.20	20.23	500.00	100.0	H	233.00	0
2706.25	---	36.28	54.00	17.72	500.00	200.0	V	225.00	0
3533.13	50.87	---	68.20	17.33	500.00	100.0	H	0.00	4
3968.88	---	39.48	54.00	14.52	500.00	200.0	V	299.00	5
4432.63	51.50	---	68.20	16.70	500.00	100.0	V	231.00	6
7244.00	54.12	---	68.20	14.08	500.00	100.0	V	241.00	10
7549.38	---	42.82	54.00	11.18	500.00	100.0	H	72.00	11

**Remark: 1. Correction Factor = Antenna factor + Insertion loss (cable loss + amplifier gain)**

**2. Margin = Limit –MAX Peak/ Average**



802.11n (HT40) CH102

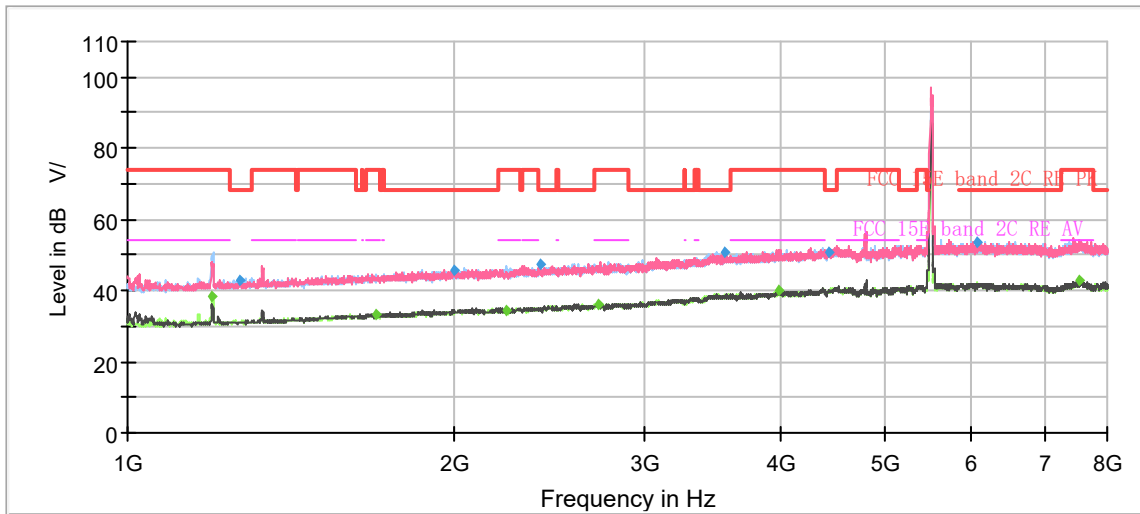

Note: The signal beyond the limit is carrier.  
Radiates Emission from 1GHz to 8GHz

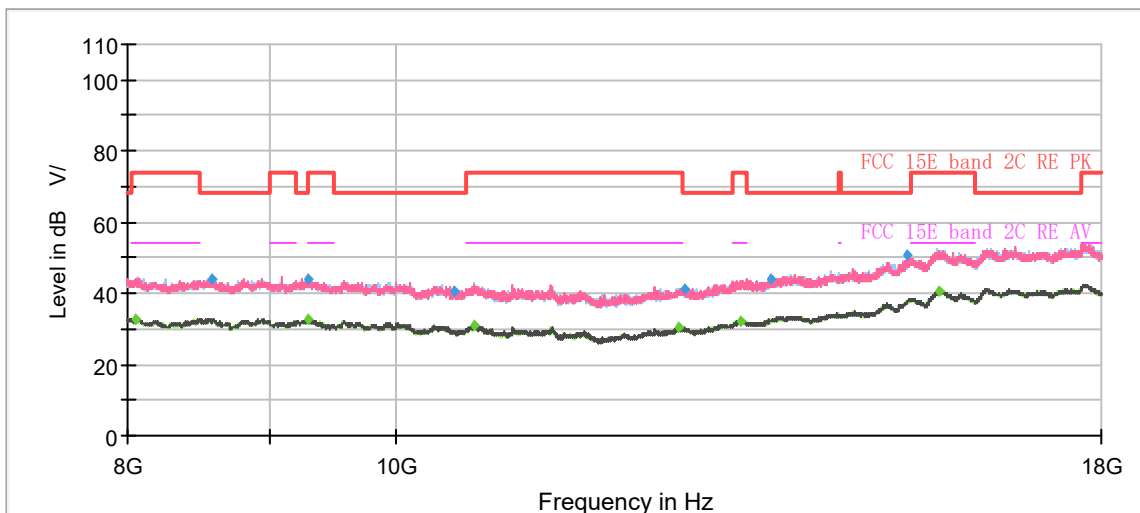

Radiates Emission from 8GHz to 18GHz

Frequency (MHz)	MaxPeak (dB $\mu$ V/m)	Average (dB $\mu$ V/m)	Limit (dB $\mu$ V/m)	Margin (dB)	Meas. Time (ms)	Height (cm)	Pol	Azimuth (deg)	Corr. (dB/m)
1196.88	---	38.34	54.00	15.66	500.00	100.0	H	154.00	-7
1269.50	42.95	---	68.20	25.25	500.00	200.0	H	99.00	-7
1693.00	---	33.21	54.00	20.79	500.00	200.0	V	197.00	-5
1998.38	45.67	---	68.20	22.53	500.00	200.0	V	215.00	-3
2229.38	---	34.42	54.00	19.58	500.00	200.0	V	131.00	-2
2396.50	47.46	---	68.20	20.74	500.00	100.0	V	103.00	-1
2718.50	---	36.22	54.00	17.78	500.00	100.0	H	243.00	0
3555.00	50.55	---	68.20	17.65	500.00	100.0	H	294.00	4
3986.38	---	39.80	54.00	14.20	500.00	100.0	V	179.00	5
4437.88	50.99	---	68.20	17.21	500.00	200.0	V	248.00	6
6073.25	53.73	---	68.20	14.47	500.00	100.0	H	39.00	9
7549.38	---	42.65	54.00	11.35	500.00	200.0	V	201.00	11

**Remark: 1. Correction Factor = Antenna factor + Insertion loss (cable loss + amplifier gain)**

**2. Margin = Limit –MAX Peak/ Average**

802.11n (HT40) CH118

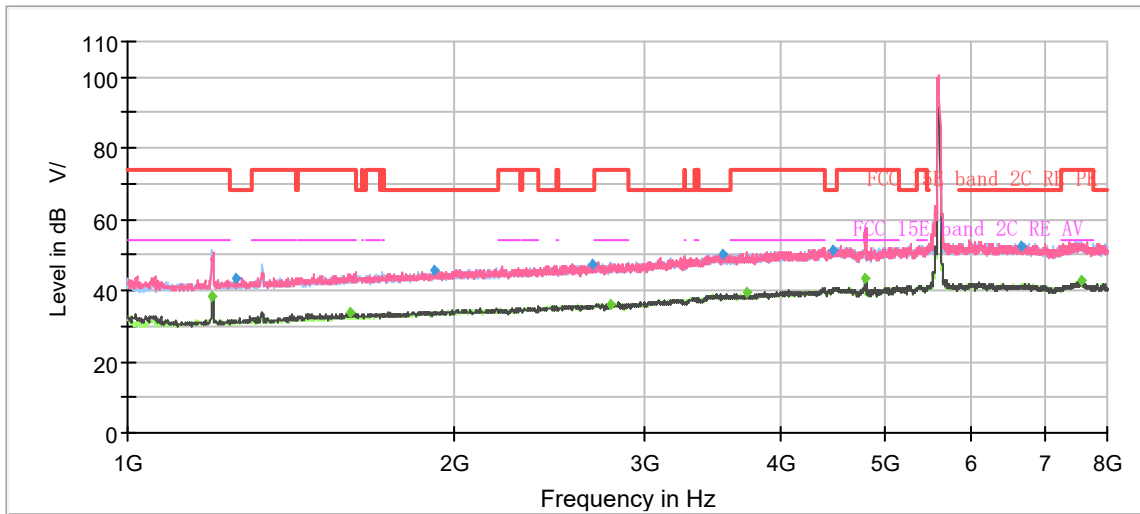

Note: The signal beyond the limit is carrier.  
Radiates Emission from 1GHz to 8GHz

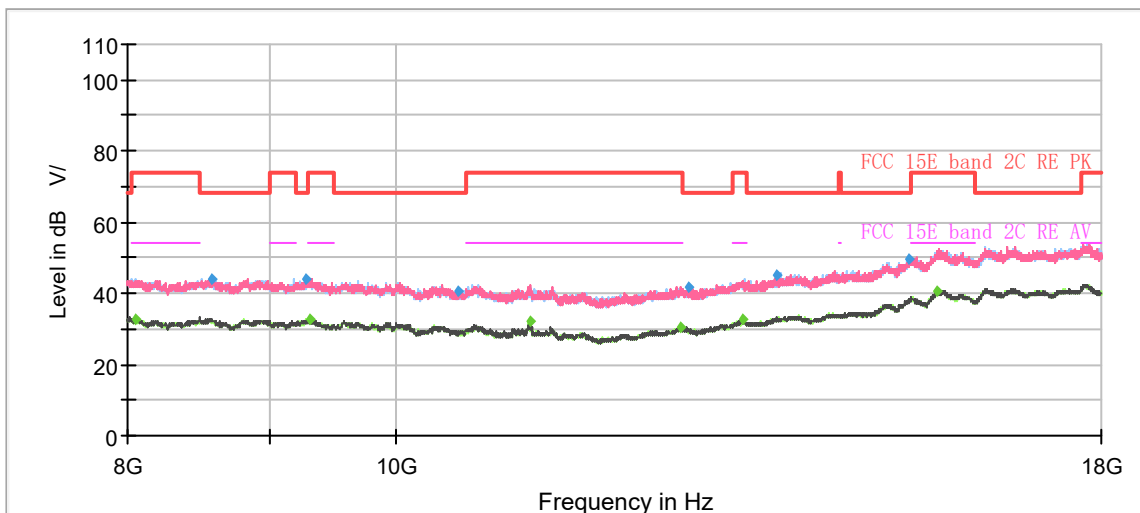

Radiates Emission from 8GHz to 18GHz

Frequency (MHz)	MaxPeak (dB $\mu$ V/m)	Average (dB $\mu$ V/m)	Limit (dB $\mu$ V/m)	Margin (dB)	Meas. Time (ms)	Height (cm)	Pol	Azimuth (deg)	Corr. (dB/m)
1196.00	---	38.56	54.00	15.44	500.00	200.0	H	125.00	-7
1260.75	43.52	---	68.20	24.68	500.00	200.0	V	141.00	-7
1601.13	---	33.63	54.00	20.37	500.00	200.0	V	121.00	-5
1913.50	45.74	---	68.20	22.46	500.00	200.0	H	236.00	-3
2687.00	47.56	---	68.20	20.64	500.00	200.0	V	108.00	0
2783.25	---	36.08	54.00	17.92	500.00	200.0	H	173.00	0
3535.75	50.05	---	68.20	18.15	500.00	200.0	V	66.00	4
3726.50	---	39.30	54.00	14.70	500.00	200.0	V	0.00	4
4466.75	51.49	---	68.20	16.71	500.00	200.0	V	0.00	7
4784.38	---	43.28	54.00	10.72	500.00	100.0	V	114.00	7
6649.88	52.39	---	68.20	15.81	500.00	100.0	V	256.00	9
7576.50	---	42.63	54.00	11.37	500.00	100.0	V	332.00	11

**Remark: 1. Correction Factor = Antenna factor + Insertion loss (cable loss + amplifier gain)**

**2. Margin = Limit - MAX Peak/ Average**

802.11n (HT40) CH134

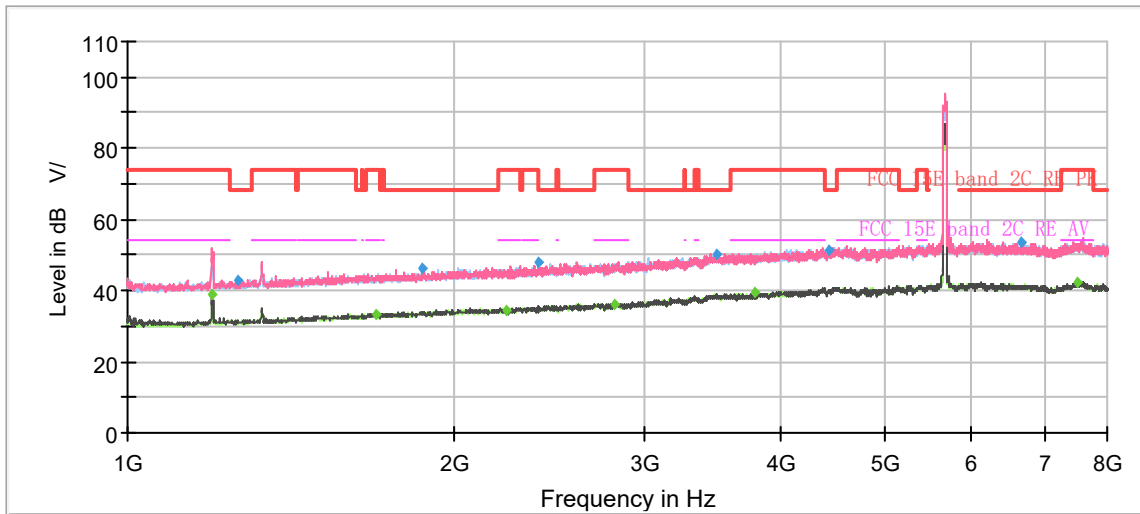

Note: The signal beyond the limit is carrier.  
Radiates Emission from 1GHz to 8GHz

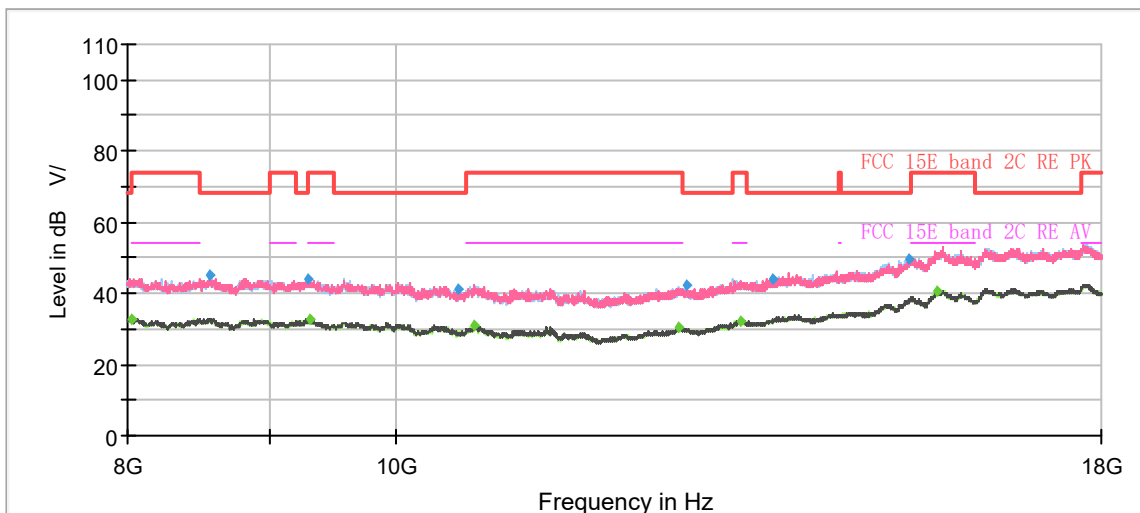

Radiates Emission from 8GHz to 18GHz

Frequency (MHz)	MaxPeak (dBμV/m)	Average (dBμV/m)	Limit (dBμV/m)	Margin (dB)	Meas. Time (ms)	Height (cm)	Pol	Azimuth (deg)	Corr. (dB/m)
1195.13	---	38.92	54.00	15.08	500.00	200.0	V	152.00	-7
1261.63	42.82	---	68.20	25.38	500.00	200.0	V	108.00	-7
1696.50	---	33.25	54.00	20.75	500.00	200.0	V	80.00	-5
1870.63	46.17	---	68.20	22.03	500.00	200.0	V	167.00	-4
2232.88	---	34.32	54.00	19.68	500.00	200.0	H	277.00	-2
2394.75	48.17	---	68.20	20.03	500.00	200.0	V	197.00	-1
2806.88	---	36.30	54.00	17.70	500.00	200.0	V	108.00	0
3491.13	50.20	---	68.20	18.00	500.00	100.0	H	81.00	4
3779.88	---	39.69	54.00	14.31	500.00	100.0	V	350.00	4
4431.75	51.58	---	68.20	16.62	500.00	200.0	H	146.00	6
6661.25	53.82	---	68.20	14.38	500.00	100.0	V	305.00	9
7518.75	---	42.08	54.00	11.92	500.00	200.0	V	94.00	11

**Remark: 1. Correction Factor = Antenna factor + Insertion loss (cable loss + amplifier gain)**

**2. Margin = Limit –MAX Peak/ Average**

802.11n (HT40) CH142

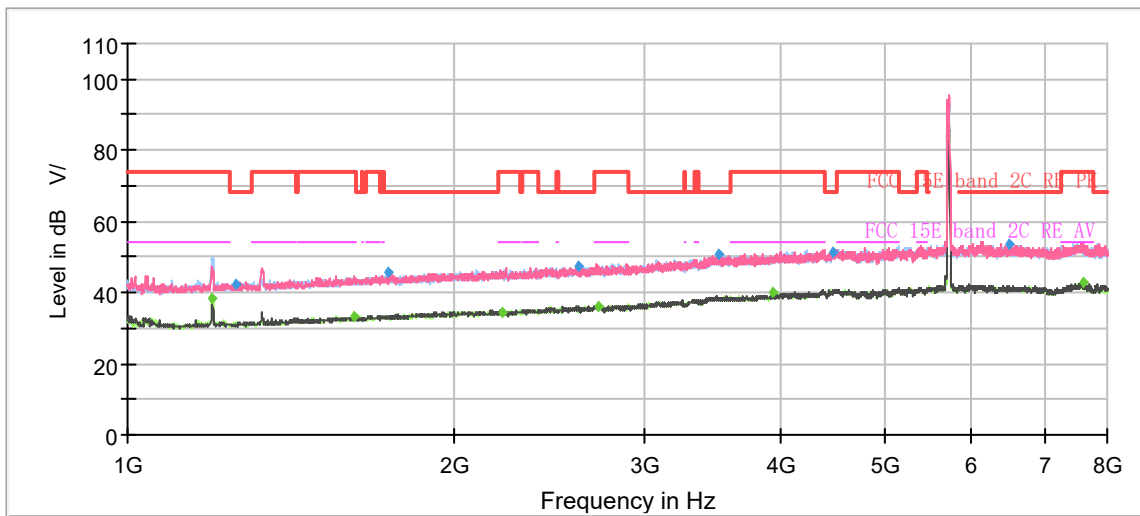

Note: The signal beyond the limit is carrier.  
Radiates Emission from 1GHz to 8GHz

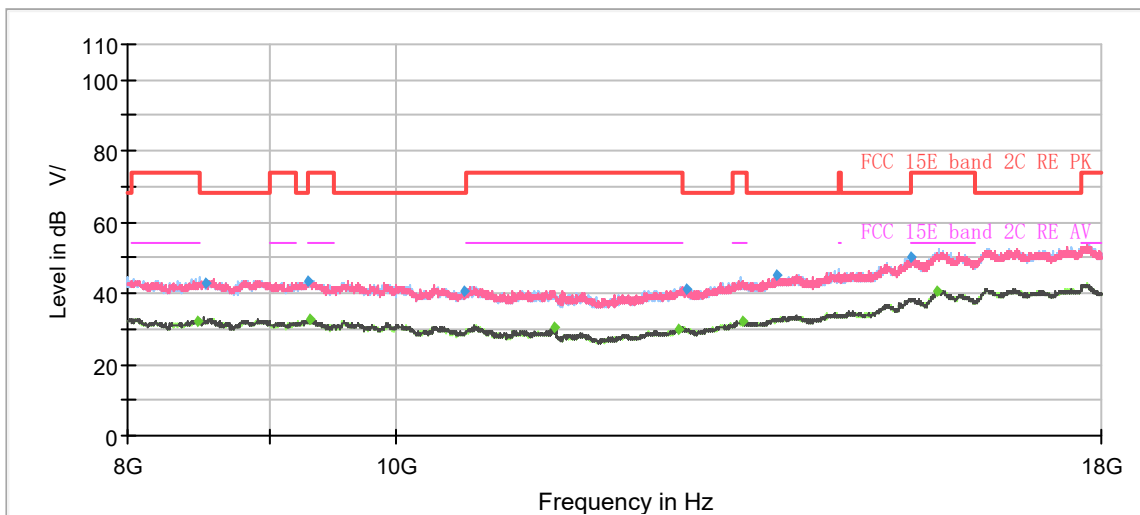

Radiates Emission from 8GHz to 18GHz

Frequency (MHz)	MaxPeak (dBμV/m)	Average (dBμV/m)	Limit (dBμV/m)	Margin (dB)	Meas. Time (ms)	Height (cm)	Pol	Azimuth (deg)	Corr. (dB/m)
1196.00	---	38.15	54.00	15.85	500.00	100.0	H	154.00	-7
1257.25	42.15	---	68.20	26.05	500.00	100.0	H	60.00	-7
1619.50	---	33.38	54.00	20.62	500.00	200.0	V	114.00	-5
1736.75	45.65	---	68.20	22.55	500.00	100.0	H	51.00	-4
2215.38	---	34.42	54.00	19.58	500.00	100.0	H	175.00	-2
2600.38	47.18	---	68.20	21.02	500.00	200.0	H	312.00	0
2716.75	---	36.27	54.00	17.73	500.00	100.0	V	97.00	0
3512.13	50.57	---	68.20	17.63	500.00	100.0	V	251.00	4
3926.00	---	39.78	54.00	14.22	500.00	100.0	V	131.00	5
4471.13	51.61	---	68.20	16.59	500.00	200.0	V	114.00	7
6493.25	53.51	---	68.20	14.69	500.00	200.0	V	184.00	9
7589.63	---	42.87	54.00	11.13	500.00	100.0	V	1.00	11

**Remark: 1. Correction Factor = Antenna factor + Insertion loss (cable loss + amplifier gain)**

**2. Margin = Limit –MAX Peak/ Average**



802.11n (HT40) CH151

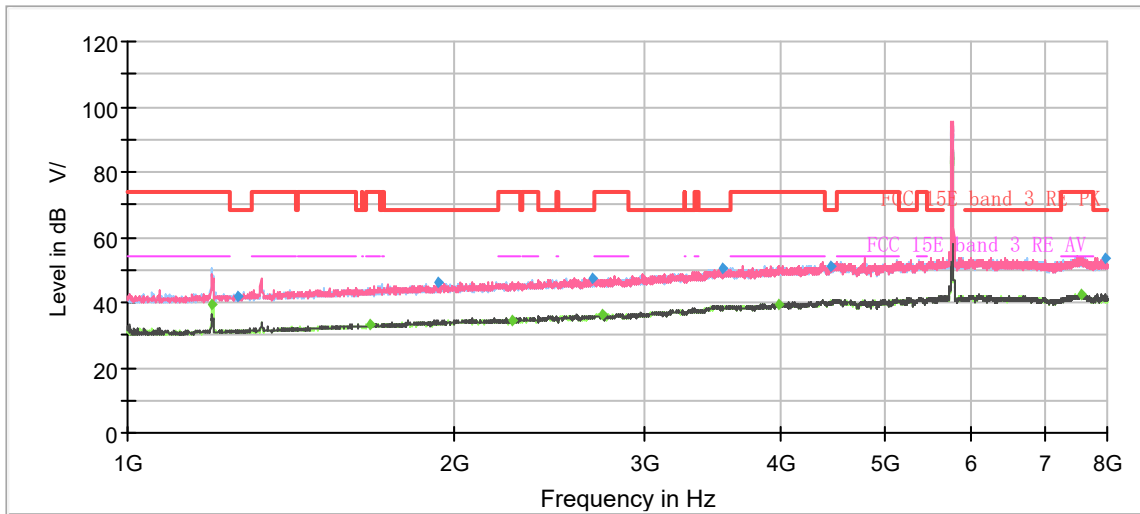

Note: The signal beyond the limit is carrier.  
Radiates Emission from 1GHz to 8GHz

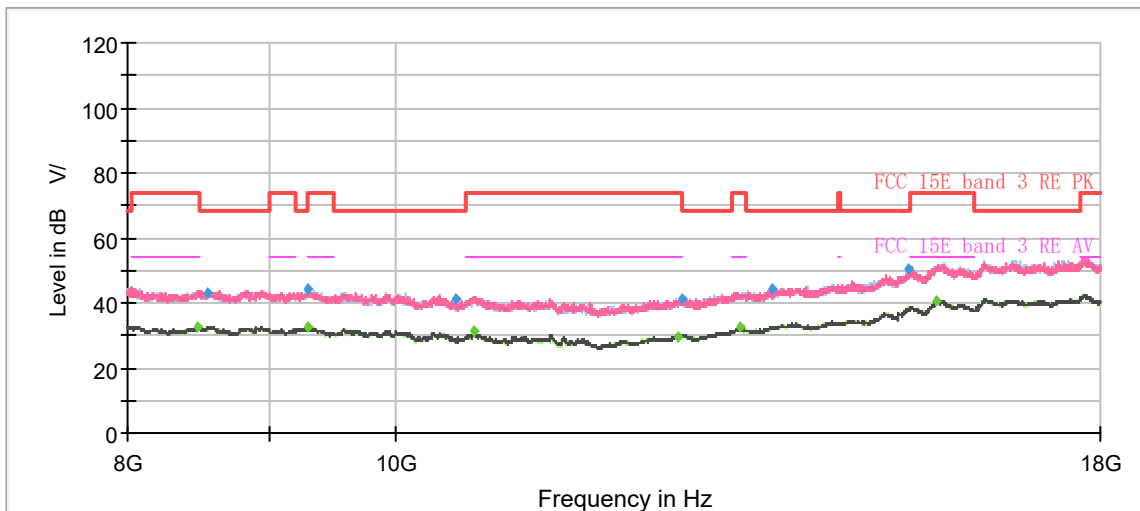

Radiates Emission from 8GHz to 18GHz

Frequency (MHz)	MaxPeak (dB $\mu$ V/m)	Average (dB $\mu$ V/m)	Limit (dB $\mu$ V/m)	Margin (dB)	Meas. Time (ms)	Height (cm)	Pol	Azimuth (deg)	Corr. (dB/m)
1196.88	---	39.26	54.00	14.74	500.00	100.0	H	103.00	-7
1262.50	42.13	---	68.20	26.07	500.00	200.0	H	313.00	-7
1672.88	---	33.37	54.00	20.63	500.00	200.0	V	199.00	-5
1930.13	46.10	---	68.20	22.10	500.00	100.0	H	143.00	-3
2264.38	---	34.34	54.00	19.66	500.00	200.0	H	357.00	-2
2683.50	47.29	---	68.20	20.91	500.00	200.0	H	283.00	0
2740.38	---	36.60	54.00	17.40	500.00	100.0	V	182.00	0
3541.88	50.49	---	68.20	17.71	500.00	200.0	V	238.00	4
3989.00	---	39.66	54.00	14.34	500.00	100.0	H	143.00	5
4455.38	51.16	---	68.20	17.04	500.00	100.0	V	282.00	6
7559.88	---	42.63	54.00	11.37	500.00	100.0	V	127.00	11
7953.63	53.67	---	68.20	14.53	500.00	100.0	H	50.00	11

**Remark: 1. Correction Factor = Antenna factor + Insertion loss (cable loss + amplifier gain)**

**2. Margin = Limit - MAX Peak/ Average**

802.11n (HT40) CH159

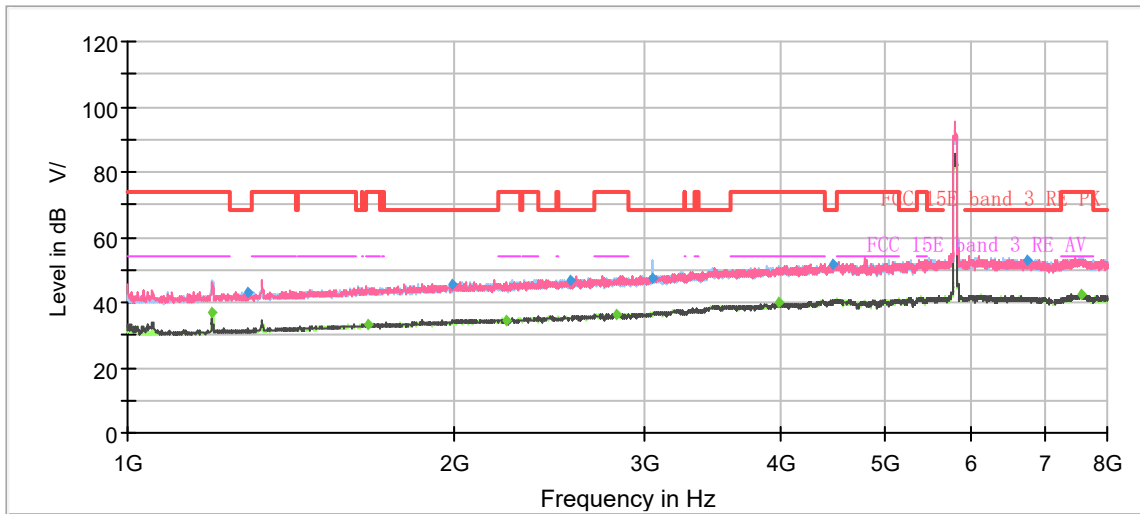

Note: The signal beyond the limit is carrier.  
Radiates Emission from 1GHz to 8GHz

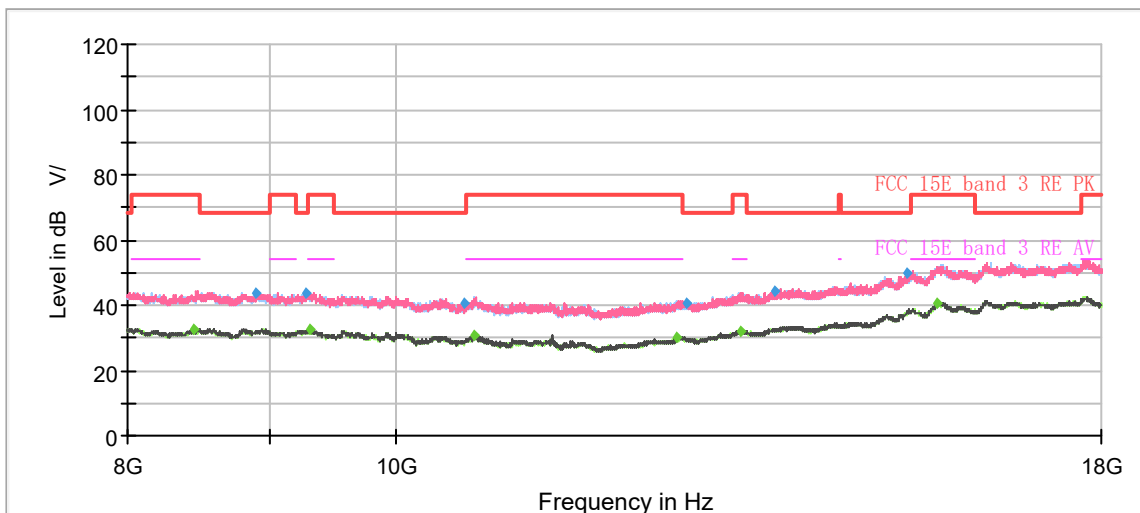

Radiates Emission from 8GHz to 18GHz

Frequency (MHz)	MaxPeak (dBμV/m)	Average (dBμV/m)	Limit (dBμV/m)	Margin (dB)	Meas. Time (ms)	Height (cm)	Pol	Azimuth (deg)	Corr. (dB/m)
1197.75	---	37.09	54.00	16.91	500.00	200.0	H	49.00	-7
1290.50	43.16	---	68.20	25.04	500.00	100.0	V	162.00	-7
1664.13	---	33.32	54.00	20.68	500.00	100.0	V	284.00	-5
1994.00	45.72	---	68.20	22.48	500.00	100.0	H	37.00	-3
2234.63	---	34.40	54.00	19.60	500.00	100.0	H	137.00	-2
2557.50	46.63	---	68.20	21.57	500.00	100.0	H	82.00	0
2817.38	---	36.42	54.00	17.58	500.00	200.0	V	86.00	0
3045.75	47.34	---	68.20	20.86	500.00	200.0	H	184.00	1
3984.63	---	39.89	54.00	14.11	500.00	100.0	V	251.00	5
4473.75	51.73	---	68.20	16.47	500.00	200.0	H	238.00	7
6741.75	53.11	---	68.20	15.09	500.00	100.0	H	112.00	9
7556.38	---	42.56	54.00	11.44	500.00	100.0	V	0.00	11

**Remark: 1. Correction Factor = Antenna factor + Insertion loss (cable loss + amplifier gain)**

**2. Margin = Limit –MAX Peak/ Average**

802.11ac (VHT80) CH42

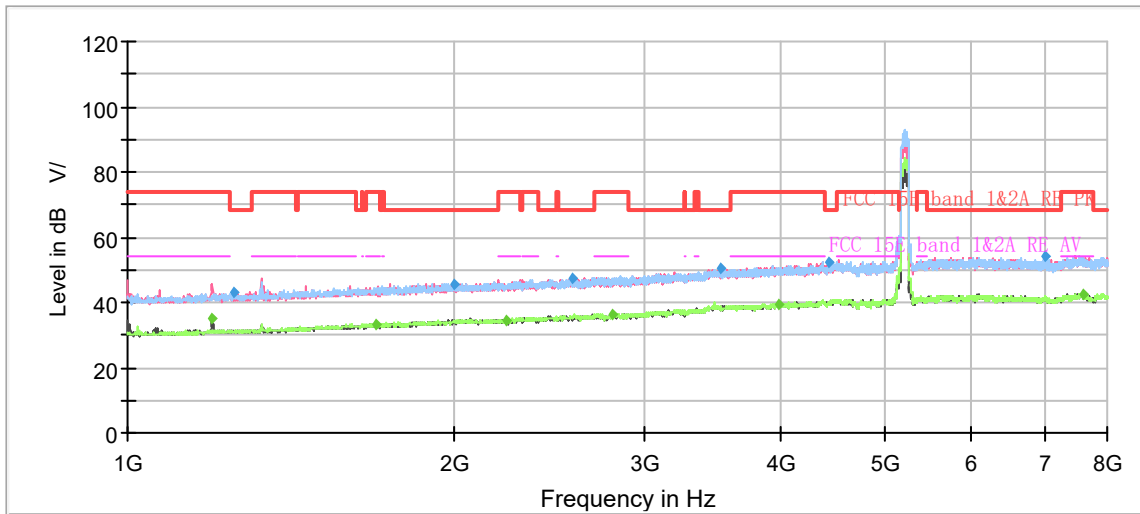

Note: The signal beyond the limit is carrier.  
Radiates Emission from 1GHz to 8GHz

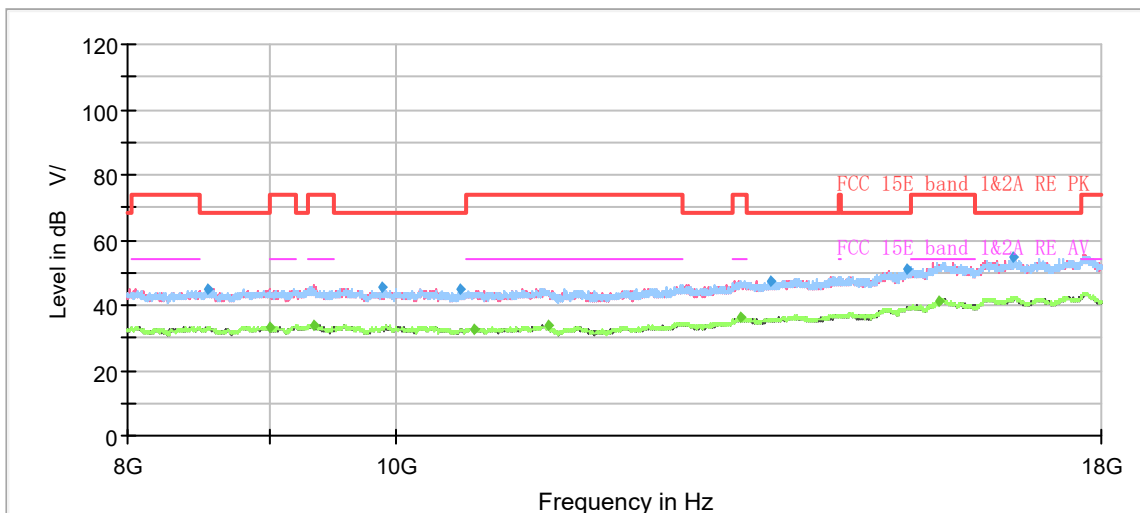

Radiates Emission from 8GHz to 18GHz

Frequency (MHz)	MaxPeak (dBμV/m)	Average (dBμV/m)	Limit (dBμV/m)	Margin (dB)	Meas. Time (ms)	Height (cm)	Pol	Azimuth (deg)	Corr. (dB/m)
1195.13	---	35.00	54.00	19.00	500.00	100.0	V	227.00	-7
1252.00	43.25	---	68.20	24.95	500.00	200.0	H	276.00	-7
1696.50	---	33.33	54.00	20.67	500.00	100.0	H	255.00	-5
1998.38	45.66	---	68.20	22.54	500.00	200.0	H	145.00	-3
2238.13	---	34.45	54.00	19.55	500.00	100.0	V	256.00	-2
2575.00	47.46	---	68.20	20.74	500.00	200.0	H	92.00	0
2803.38	---	36.48	54.00	17.52	500.00	100.0	H	79.00	0
3519.13	50.20	---	68.20	18.00	500.00	100.0	H	93.00	4
3975.88	---	39.40	54.00	14.60	500.00	100.0	H	135.00	5
4433.50	52.20	---	68.20	16.00	500.00	200.0	V	342.00	6
7013.88	54.15	---	68.20	14.05	500.00	100.0	V	318.00	9
7599.25	---	42.56	54.00	11.44	500.00	100.0	H	13.00	11

**Remark: 1. Correction Factor = Antenna factor + Insertion loss (cable loss + amplifier gain)**

**2. Margin = Limit –MAX Peak/ Average**

802.11ac (VHT80) CH58

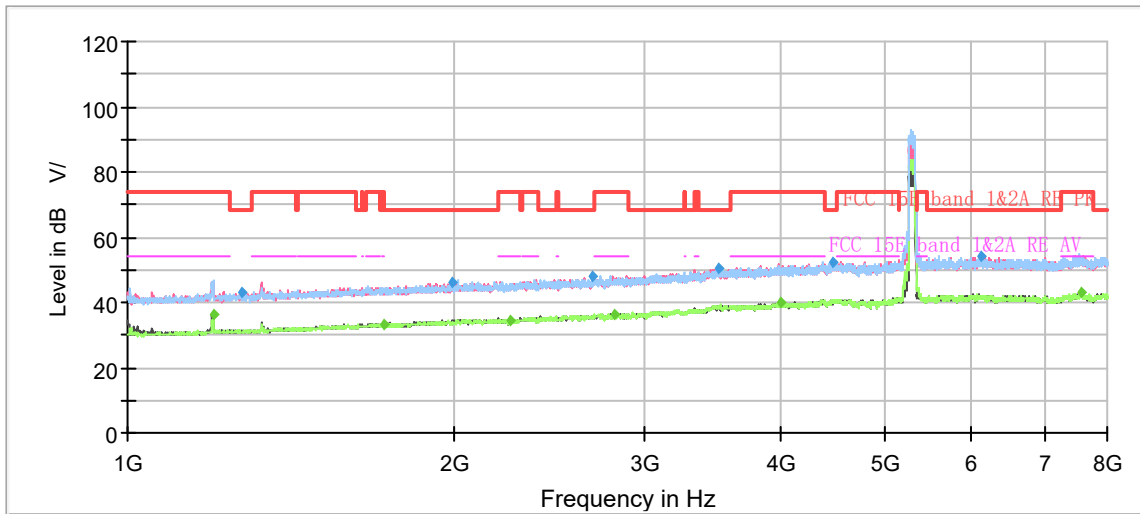

Note: The signal beyond the limit is carrier.  
Radiates Emission from 1GHz to 8GHz

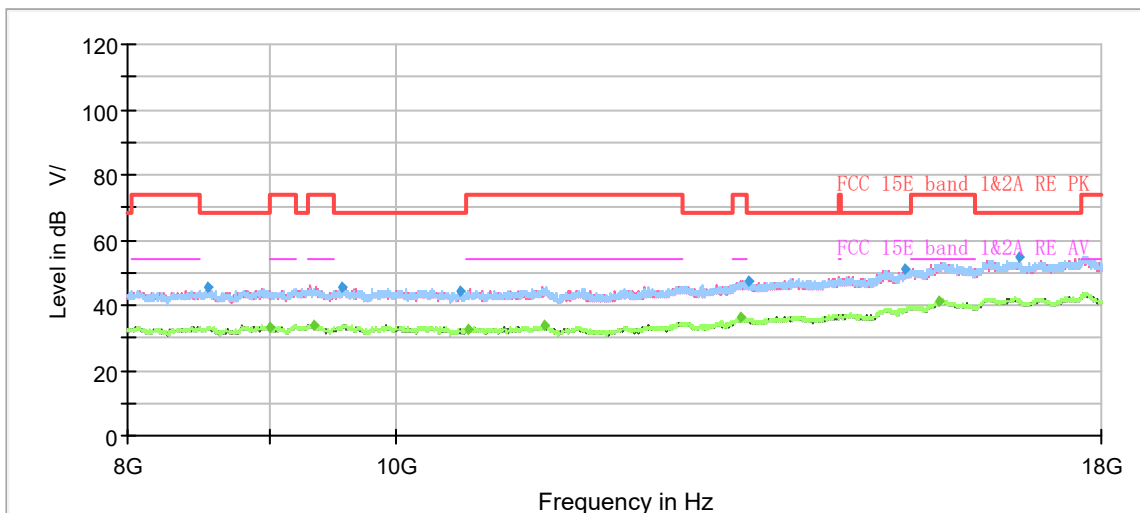

Radiates Emission from 8GHz to 18GHz

Frequency (MHz)	MaxPeak (dBμV/m)	Average (dBμV/m)	Limit (dBμV/m)	Margin (dB)	Meas. Time (ms)	Height (cm)	Pol	Azimuth (deg)	Corr. (dB/m)
1198.63	---	36.51	54.00	17.49	500.00	200.0	V	208.00	-7
1276.50	43.29	---	68.20	24.91	500.00	100.0	H	14.00	-7
1721.88	---	33.51	54.00	20.49	500.00	100.0	H	205.00	-4
1995.75	46.02	---	68.20	22.18	500.00	100.0	V	0.00	-3
2248.63	---	34.24	54.00	19.76	500.00	100.0	V	44.00	-2
2683.50	47.88	---	68.20	20.32	500.00	100.0	H	98.00	0
2809.50	---	36.31	54.00	17.69	500.00	200.0	V	116.00	0
3512.13	50.57	---	68.20	17.63	500.00	200.0	V	33.00	4
3993.38	---	39.92	54.00	14.08	500.00	200.0	V	218.00	5
4465.00	52.06	---	68.20	16.14	500.00	100.0	H	14.00	7
6124.00	53.88	---	68.20	14.32	500.00	100.0	H	258.00	9
7584.38	---	42.91	54.00	11.09	500.00	100.0	H	234.00	11

**Remark: 1. Correction Factor = Antenna factor + Insertion loss (cable loss + amplifier gain)**

**2. Margin = Limit –MAX Peak/ Average**



802.11ac (VHT80) CH106

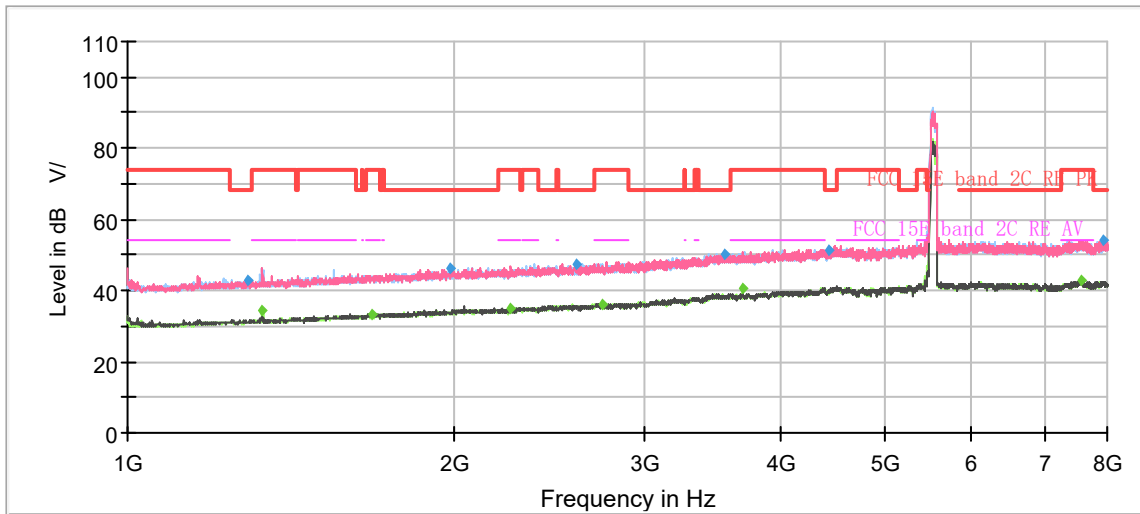

Note: The signal beyond the limit is carrier.  
Radiates Emission from 1GHz to 8GHz

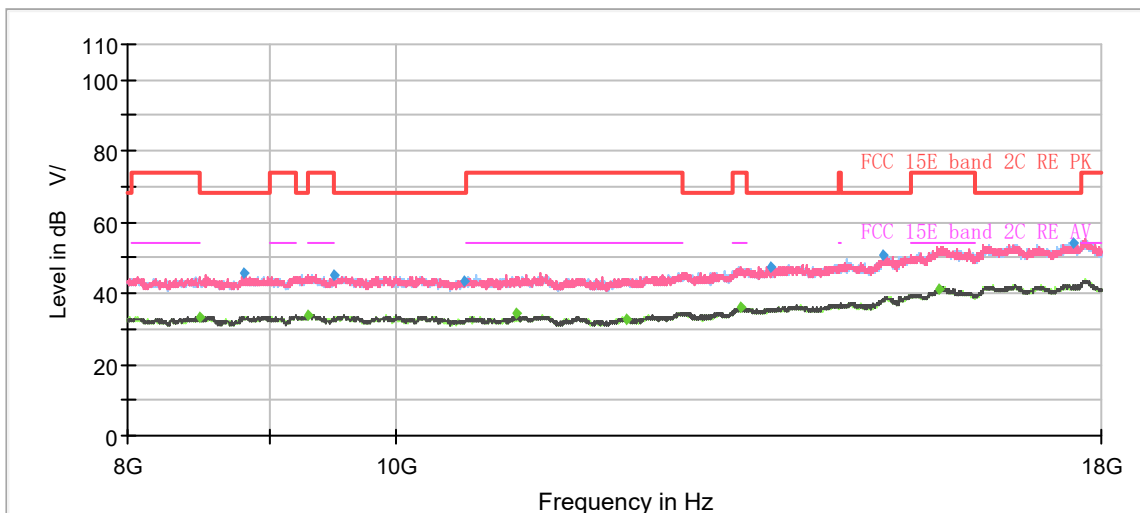

Radiates Emission from 8GHz to 18GHz

Frequency (MHz)	MaxPeak (dB $\mu$ V/m)	Average (dB $\mu$ V/m)	Limit (dB $\mu$ V/m)	Margin (dB)	Meas. Time (ms)	Height (cm)	Pol	Azimuth (deg)	Corr. (dB/m)
1289.63	42.89	---	68.20	25.31	500.00	200.0	V	23.00	-7
1329.88	---	34.53	54.00	19.47	500.00	200.0	H	277.00	-7
1681.63	---	33.27	54.00	20.73	500.00	200.0	H	243.00	-5
1987.00	46.09	---	68.20	22.11	500.00	100.0	V	251.00	-3
2257.38	---	34.78	54.00	19.22	500.00	200.0	H	163.00	-2
2593.38	47.42	---	68.20	20.78	500.00	100.0	V	6.00	0
2736.88	---	36.17	54.00	17.83	500.00	100.0	V	149.00	0
3557.63	50.34	---	68.20	17.86	500.00	200.0	V	269.00	4
3686.25	---	40.60	54.00	13.40	500.00	200.0	H	1.00	4
4432.63	51.30	---	68.20	16.90	500.00	100.0	V	98.00	6
7559.88	---	42.75	54.00	11.25	500.00	100.0	H	84.00	11
7937.88	54.14	---	68.20	14.06	500.00	200.0	V	301.00	11

**Remark: 1. Correction Factor = Antenna factor + Insertion loss (cable loss + amplifier gain)**

**2. Margin = Limit –MAX Peak/ Average**

802.11ac (VHT80) CH122

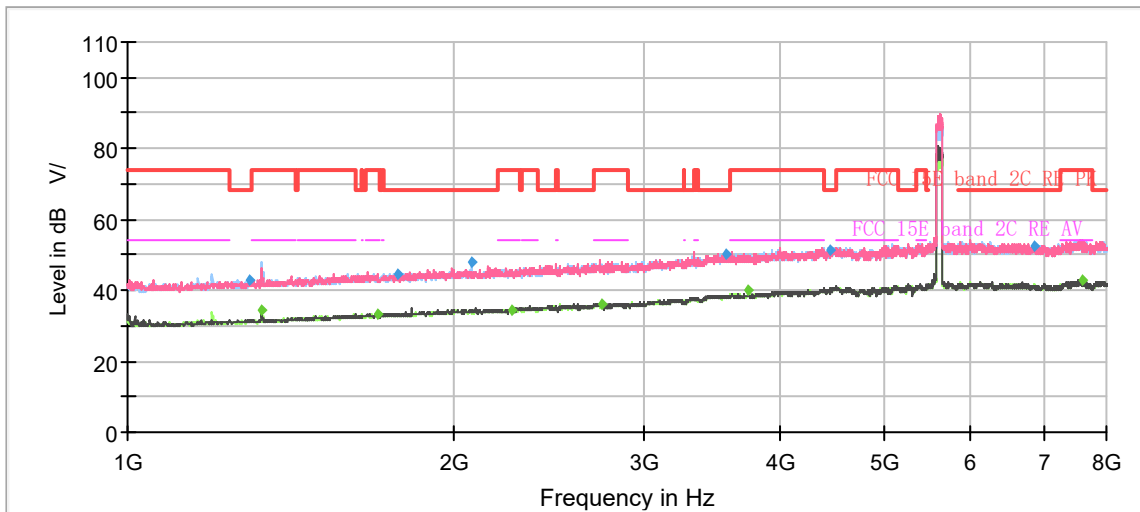

Note: The signal beyond the limit is carrier.  
Radiates Emission from 1GHz to 8GHz

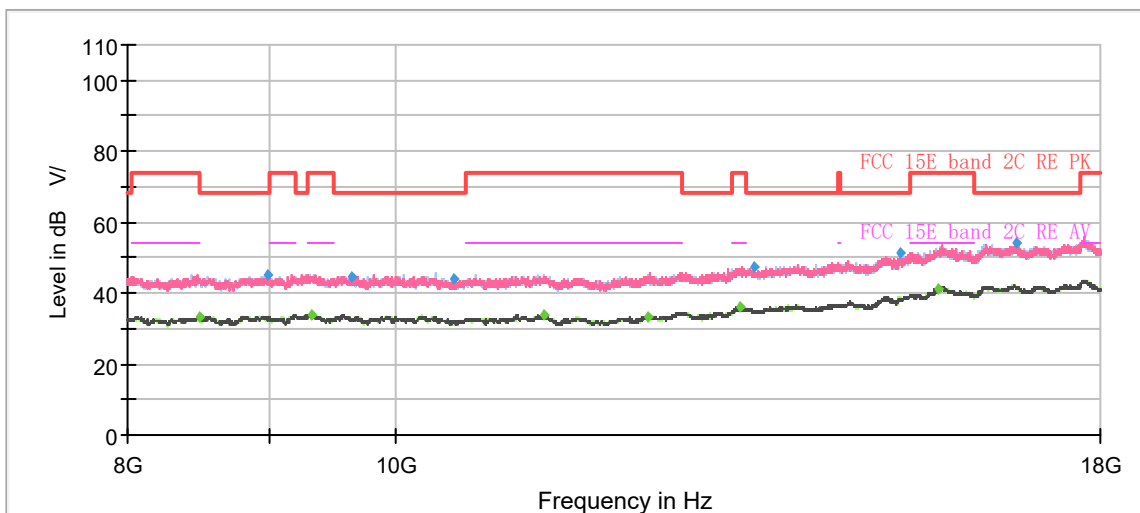

Radiates Emission from 8GHz to 18GHz

Frequency (MHz)	MaxPeak (dB $\mu$ V/m)	Average (dB $\mu$ V/m)	Limit (dB $\mu$ V/m)	Margin (dB)	Meas. Time (ms)	Height (cm)	Pol	Azimuth (deg)	Corr. (dB/m)
1295.75	43.14	---	68.20	25.06	500.00	100.0	H	250.00	-7
1329.88	---	34.57	54.00	19.43	500.00	100.0	H	232.00	-7
1699.13	---	33.25	54.00	20.75	500.00	100.0	V	117.00	-5
1773.50	44.82	---	68.20	23.38	500.00	200.0	V	328.00	-4
2074.50	48.19	---	68.20	20.01	500.00	200.0	H	50.00	-3
2259.13	---	34.41	54.00	19.59	500.00	100.0	H	0.00	-2
2736.00	---	36.25	54.00	17.75	500.00	200.0	H	31.00	0
3571.63	50.47	---	68.20	17.73	500.00	100.0	V	298.00	4
3739.63	---	40.03	54.00	13.97	500.00	200.0	H	64.00	4
4446.63	51.12	---	68.20	17.08	500.00	200.0	H	3.00	6
6855.50	52.33	---	68.20	15.87	500.00	200.0	H	91.00	9
7588.75	---	42.76	54.00	11.24	500.00	200.0	H	343.00	11

**Remark: 1. Correction Factor = Antenna factor + Insertion loss (cable loss + amplifier gain)**

**2. Margin = Limit –MAX Peak/ Average**

802.11ac (VHT80) CH138

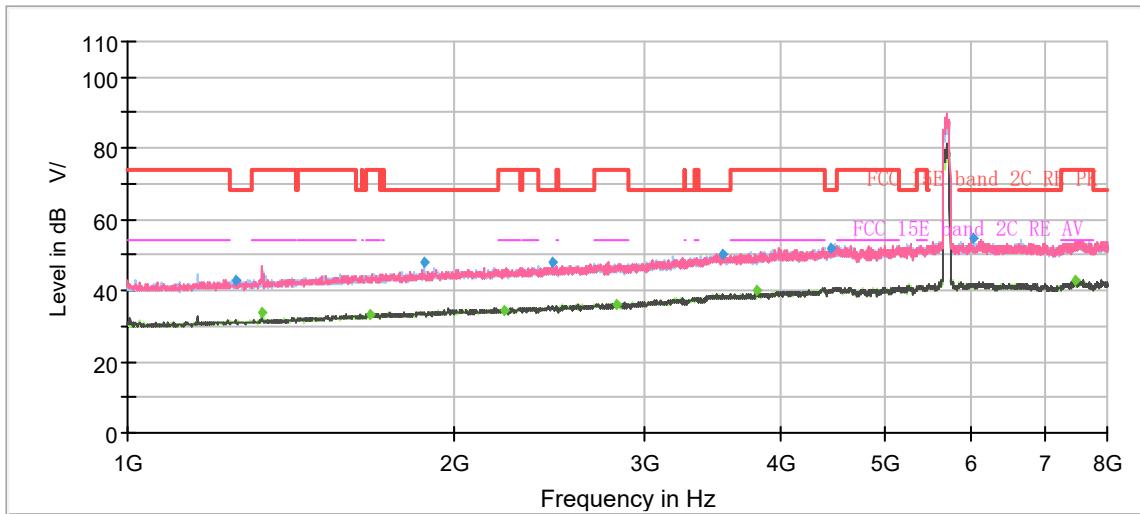

Note: The signal beyond the limit is carrier.  
Radiates Emission from 1GHz to 8GHz

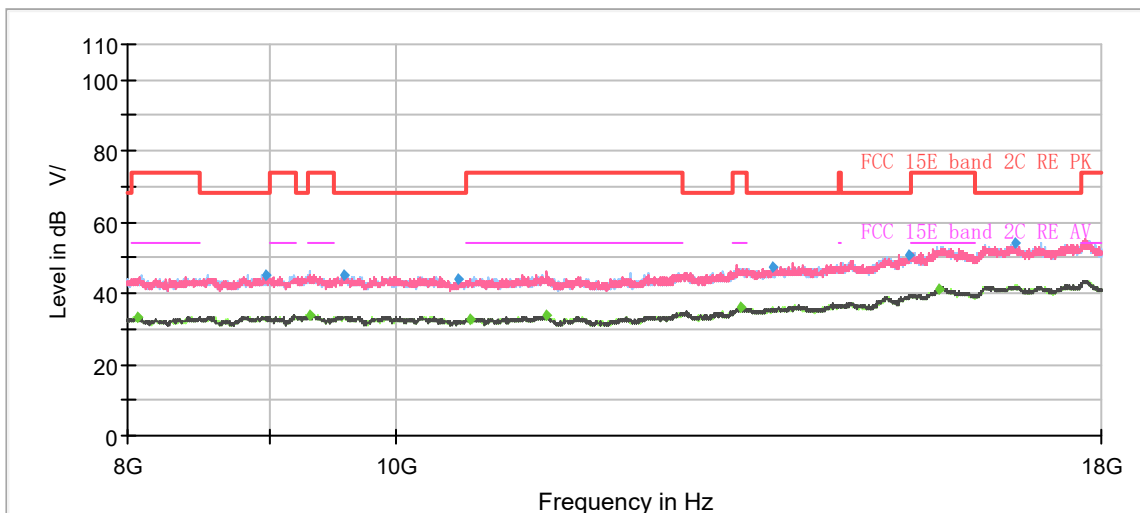

Radiates Emission from 8GHz to 18GHz

Frequency (MHz)	MaxPeak (dBμV/m)	Average (dBμV/m)	Limit (dBμV/m)	Margin (dB)	Meas. Time (ms)	Height (cm)	Pol	Azimuth (deg)	Corr. (dB/m)
1259.88	43.01	---	68.20	25.19	500.00	200.0	V	306.00	-7
1328.13	---	33.79	54.00	20.21	500.00	100.0	V	202.00	-7
1676.38	---	33.50	54.00	20.50	500.00	200.0	V	230.00	-5
1876.75	47.96	---	68.20	20.24	500.00	100.0	H	30.00	-4
2226.75	---	34.26	54.00	19.74	500.00	100.0	V	70.00	-2
2460.38	47.89	---	68.20	20.31	500.00	200.0	H	189.00	-1
2826.13	---	36.35	54.00	17.65	500.00	200.0	H	1.00	1
3537.50	50.27	---	68.20	17.93	500.00	100.0	V	65.00	4
3793.00	---	40.13	54.00	13.87	500.00	200.0	H	295.00	4
4455.38	51.88	---	68.20	16.32	500.00	200.0	V	286.00	6
6019.88	54.54	---	68.20	13.66	500.00	200.0	H	15.00	9
7475.88	---	42.88	54.00	11.12	500.00	100.0	V	271.00	11

**Remark: 1. Correction Factor = Antenna factor + Insertion loss (cable loss + amplifier gain)**

**2. Margin = Limit –MAX Peak/ Average**

802.11ac (VHT80) CH155

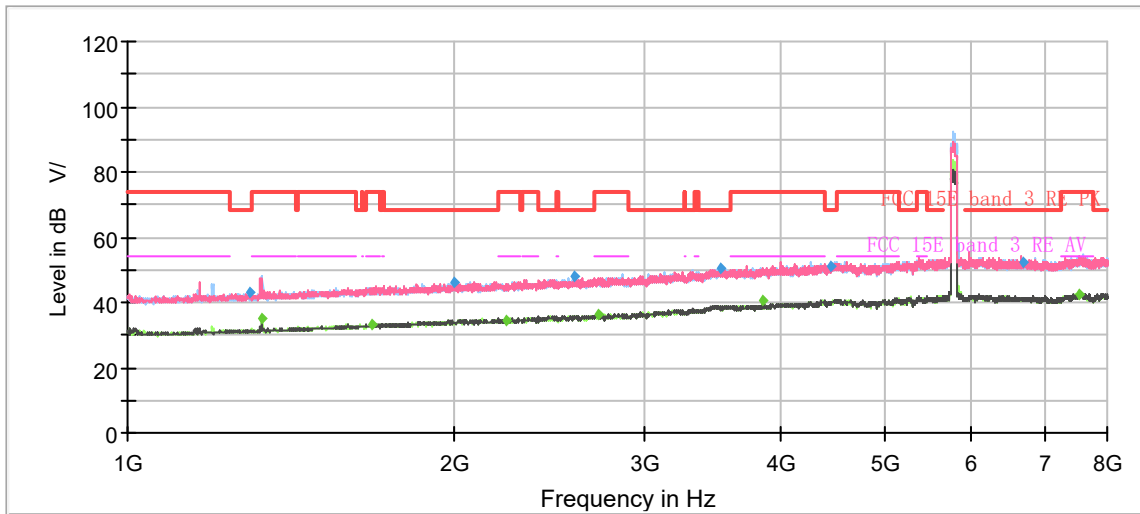

Note: The signal beyond the limit is carrier.  
Radiates Emission from 1GHz to 8GHz

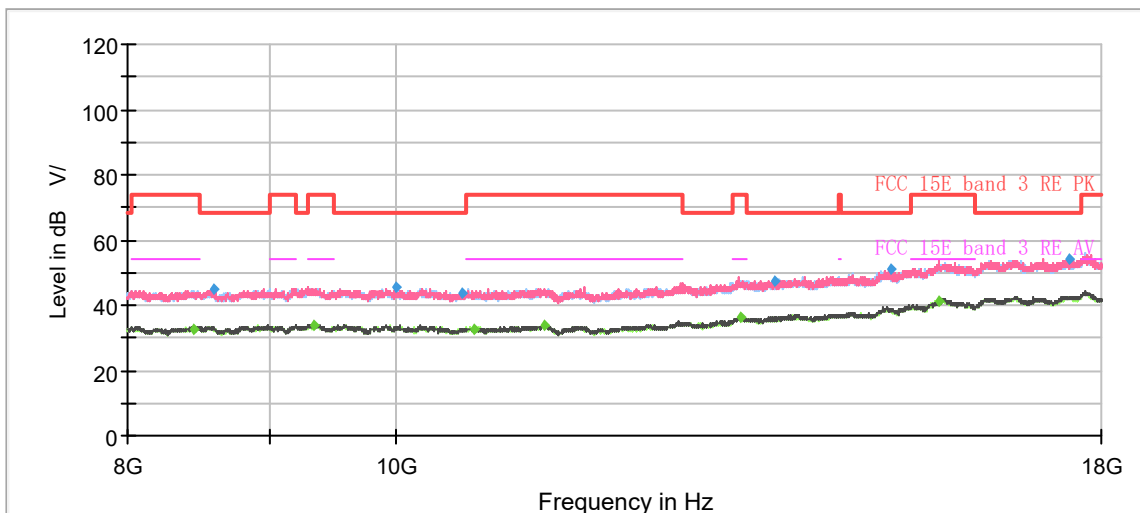

Radiates Emission from 8GHz to 18GHz

Frequency (MHz)	MaxPeak (dBμV/m)	Average (dBμV/m)	Limit (dBμV/m)	Margin (dB)	Meas. Time (ms)	Height (cm)	Pol	Azimuth (deg)	Corr. (dB/m)
1296.63	42.93	---	68.20	25.27	500.00	200.0	V	359.00	-7
1331.63	---	34.93	54.00	19.07	500.00	200.0	H	199.00	-7
1680.75	---	33.54	54.00	20.46	500.00	100.0	H	67.00	-5
1996.63	46.32	---	68.20	21.88	500.00	100.0	V	144.00	-3
2234.63	---	34.75	54.00	19.25	500.00	100.0	H	323.00	-2
2584.63	47.81	---	68.20	20.39	500.00	200.0	H	150.00	0
2717.63	---	36.40	54.00	17.60	500.00	100.0	V	26.00	0
3515.63	50.47	---	68.20	17.73	500.00	200.0	H	126.00	4
3849.88	---	40.45	54.00	13.55	500.00	200.0	H	79.00	5
4453.63	51.08	---	68.20	17.12	500.00	200.0	H	117.00	6
6700.63	52.37	---	68.20	15.83	500.00	200.0	V	9.00	9
7550.25	---	42.66	54.00	11.34	500.00	200.0	H	0.00	11

**Remark: 1. Correction Factor = Antenna factor + Insertion loss (cable loss + amplifier gain)**

**2. Margin = Limit –MAX Peak/ Average**



During the test, the Radiates Emission from 18GHz to 40GHz was performed in all modes with all channels, 802.11n (HT40) CH118 are selected as the worst condition. The test data of the worst-case condition was recorded in this report.

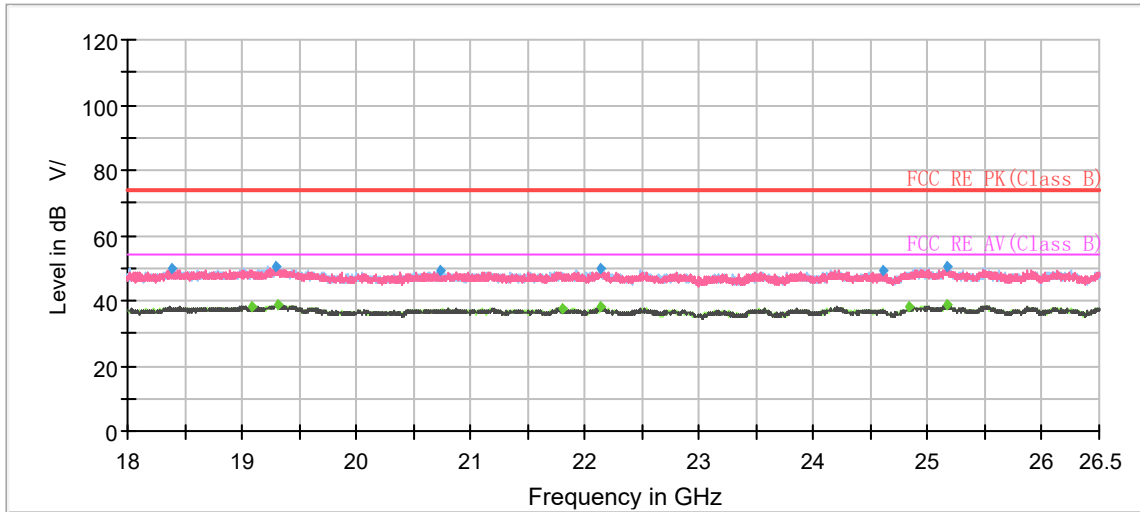

Radiates Emission from 18GHz to 26.5GHz

Frequency (MHz)	MaxPeak (dBμV/m)	Average (dBμV/m)	Limit (dBμV/m)	Margin (dB)	Meas. Time (ms)	Height (cm)	Pol	Azimuth (deg)	Corr. (dB/m)
18384.63	49.98	---	74.00	24.02	500.00	200.0	H	5.00	-7
19088.00	---	38.30	54.00	15.70	500.00	200.0	V	322.00	-7
19288.81	50.28	---	74.00	23.72	500.00	200.0	V	209.00	-6
19305.81	---	38.94	54.00	15.06	500.00	200.0	H	120.00	-6
20732.75	49.11	---	74.00	24.89	500.00	200.0	H	70.00	-7
21800.56	---	37.59	54.00	16.41	500.00	100.0	H	341.00	-6
22135.25	49.94	---	74.00	24.06	500.00	100.0	V	149.00	-6
22139.50	---	38.11	54.00	15.89	500.00	100.0	H	356.00	-6
24602.38	49.24	---	74.00	24.76	500.00	200.0	V	322.00	-5
24839.31	---	37.98	54.00	16.02	500.00	100.0	H	226.00	-4
25167.63	50.73	---	74.00	23.27	500.00	200.0	H	274.00	-3
25169.75	---	38.87	54.00	15.13	500.00	200.0	H	120.00	-3

Remark: 1. Correction Factor = Antenna factor + Insertion loss (cable loss + amplifier gain)

2. Margin = Limit-MAX Peak/ Average

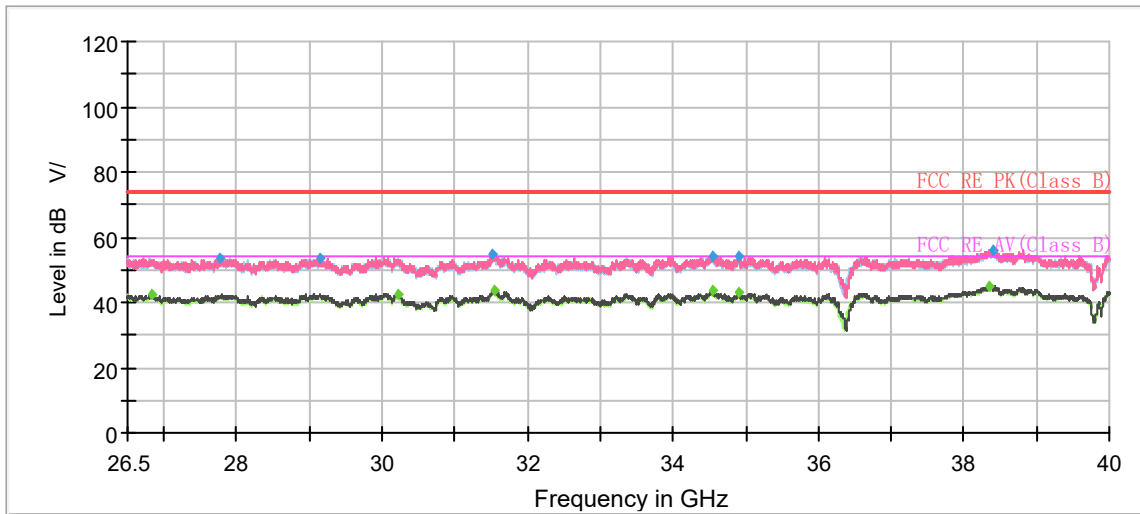

Radiates Emission from 26.5GHz to 40GHz

Frequency (MHz)	MaxPeak (dBμV/m)	Average (dBμV/m)	Limit (dBμV/m)	Margin (dB)	Meas. Time (ms)	Height (cm)	Pol	Azimuth (deg)	Corr. (dB/m)
26824.00	---	42.27	54.00	11.73	500.00	100.0	V	226.00	0
27765.63	53.81	---	74.00	20.19	500.00	100.0	V	290.00	0
29132.50	53.72	---	74.00	20.28	500.00	100.0	V	320.00	1
30215.88	---	42.68	54.00	11.32	500.00	100.0	V	84.00	-1
31527.06	54.79	---	74.00	19.21	500.00	100.0	H	337.00	0
31532.13	---	43.84	54.00	10.16	500.00	100.0	V	140.00	0
34539.25	---	43.46	54.00	10.54	500.00	100.0	V	108.00	1
34554.44	54.34	---	74.00	19.66	500.00	100.0	V	164.00	1
34898.69	53.90	---	74.00	20.10	500.00	100.0	V	9.00	1
34903.75	---	43.07	54.00	10.93	500.00	100.0	V	221.00	1
38353.00	---	45.06	54.00	8.94	500.00	100.0	V	64.00	5
38415.44	56.16	---	74.00	17.84	500.00	100.0	V	266.00	4

Remark: 1. Correction Factor = Antenna factor + Insertion loss (cable loss + amplifier gain)  
 2. Margin = Limit-MAX Peak/ Average

## 5.2. Conducted Emission

### Ambient condition

Temperature	Relative humidity
20°C ~ 25°C	45% ~ 50%

### Methods of Measurement

The EUT IS placed on a non-metallic table of 80cm height above the horizontal metal reference ground plane. During the test, the EUT was operating in its typical mode. The test method is according to ANSI C63.10. Connect the AC power line of the EUT to the LISN Use EMI receiver to detect the average and Quasi-peak value. RBW is set to 9kHz, VBW is set to 30kHz The measurement result should include both L line and N line.

The test is in transmitting mode.

### Test Setup

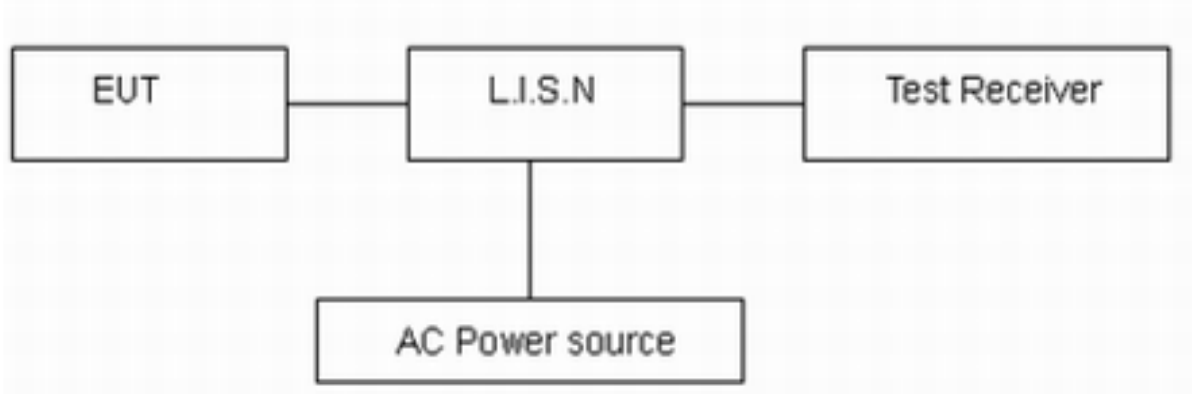

Note: AC Power source is used to change the voltage 110V/60Hz.

### Limits

Frequency (MHz)	Conducted Limits(dBμV)	
	Quasi-peak	Average
0.15 - 0.5	66 to 56 *	56 to 46 *
0.5 - 5	56	46
5 - 30	60	50

\*: Decreases with the logarithm of the frequency.

### Measurement Uncertainty

The assessed measurement uncertainty to ensure 95% confidence level for the normal distribution is with the coverage factor  $k = 1.96$ ,  $U = 2.69$  dB.

**Test Results:**

Following plots, Blue trace uses the peak detection and Green trace uses the average detection. During the test, the Conducted Emission was performed in all modes with all channels, 802.11n (HT40) CH118 are selected as the worst condition. The test data of the worst-case condition was recorded in this report.

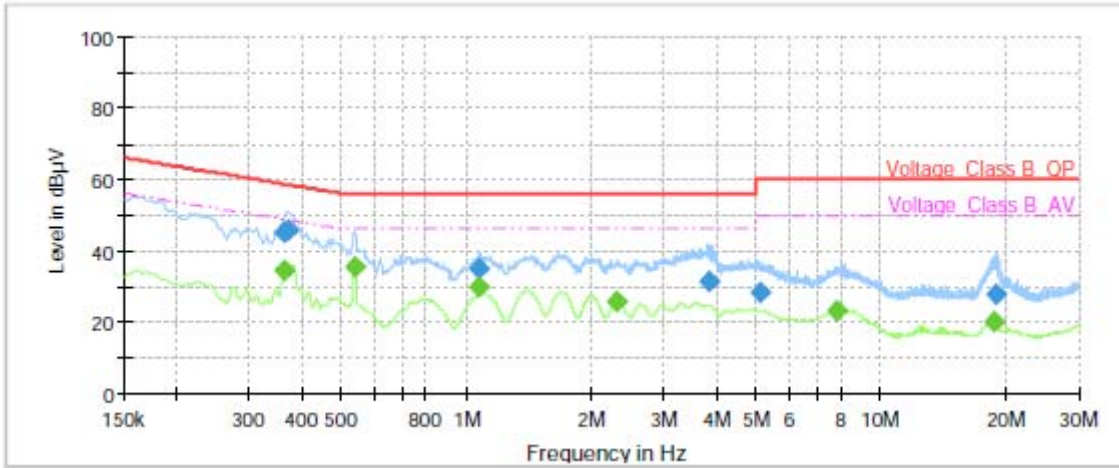

Frequency (MHz)	QuasiPeak (dBµV)	Average (dBµV)	Limit (dBµV)	Margin (dB)	Meas. Time (ms)	Bandwidth (kHz)	Line	Filter	Corr. (dB)
0.361500	45.28	---	58.69	13.41	1000.0	9.000	L1	ON	20.5
0.361500	---	34.21	48.69	14.48	1000.0	9.000	L1	ON	20.5
0.372750	45.79	---	58.44	12.65	1000.0	9.000	L1	ON	20.5
0.537000	---	35.54	46.00	10.46	1000.0	9.000	L1	ON	20.3
1.074750	---	29.57	46.00	16.43	1000.0	9.000	L1	ON	19.9
1.074750	34.80	---	56.00	21.20	1000.0	9.000	L1	ON	19.9
2.314500	---	25.65	46.00	20.35	1000.0	9.000	L1	ON	19.5
3.849000	31.08	---	56.00	24.92	1000.0	9.000	L1	ON	19.4
5.131500	28.23	---	60.00	31.77	1000.0	9.000	L1	ON	19.5
7.815750	---	22.83	50.00	27.17	1000.0	9.000	L1	ON	19.5
18.820500	---	19.75	50.00	30.25	1000.0	9.000	L1	ON	19.8
18.881250	27.84	---	60.00	32.16	1000.0	9.000	L1	ON	19.8

**Remark: Correct factor=cable loss + LISN factor**

L line Conducted Emission from 150 KHz to 30 MHz

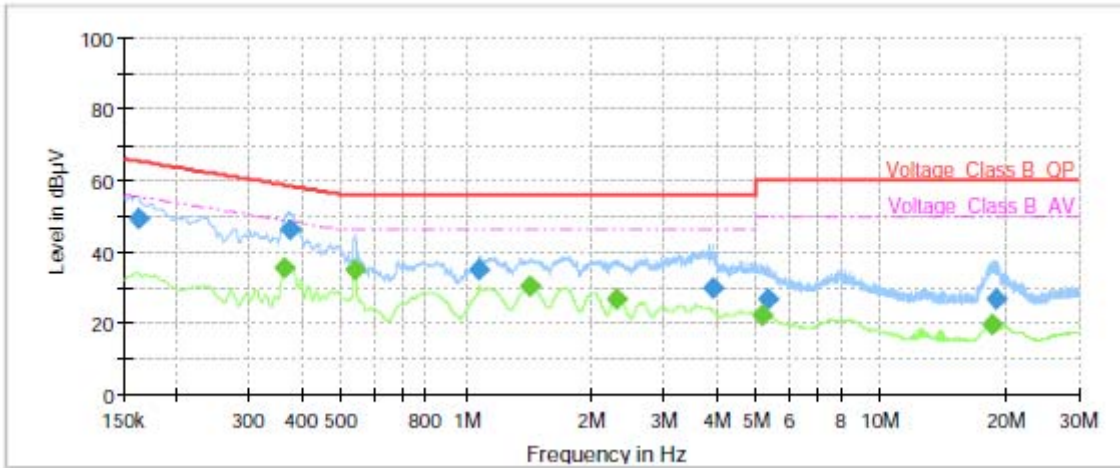

Frequency (MHz)	QuasiPeak (dBµV)	Average (dBµV)	Limit (dBµV)	Margin (dB)	Meas. Time (ms)	Bandwidth (kHz)	Line	Filter	Corr. (dB)
0.161250	49.25	---	65.40	16.15	1000.0	9.000	N	ON	20.8
0.361500	---	35.26	48.69	13.43	1000.0	9.000	N	ON	20.5
0.377250	46.23	---	58.34	12.11	1000.0	9.000	N	ON	20.5
0.539250	---	34.99	46.00	11.01	1000.0	9.000	N	ON	20.3
1.077000	34.62	---	56.00	21.38	1000.0	9.000	N	ON	19.9
1.430250	---	30.09	46.00	15.91	1000.0	9.000	N	ON	19.7
2.312250	---	26.64	46.00	19.36	1000.0	9.000	N	ON	19.5
3.932250	29.63	---	56.00	26.37	1000.0	9.000	N	ON	19.5
5.149500	---	22.26	50.00	27.74	1000.0	9.000	N	ON	19.5
5.320500	26.41	---	60.00	33.59	1000.0	9.000	N	ON	19.5
18.593250	---	19.37	50.00	30.63	1000.0	9.000	N	ON	19.8
18.957750	26.50	---	60.00	33.50	1000.0	9.000	N	ON	19.8

Remark: Correct factor=cable loss + LISN factor

N line Conducted Emission from 150 KHz to 30 MHz

## 6. Main Test Instruments

Name	Manufacturer	Type	Serial Number	Calibration Date	Expiration Date
Artificial main network	R&S	ENV216	102191	2020-12-13	2022-12-12
				2022-12-13	2024-12-09
EMI Test Receiver	R&S	ESR	101667	2022-05-25	2023-05-24
Software	R&S	EMC32	10.35.10	/	/
EMI Test Receiver	R&S	ESR	102389	2022-05-25	2023-05-24
Spectrum Analyzer	R&S	FSV40	101186	2022-05-14	2023-05-13
Loop Antenna	SCHWARZBECK	FMZB1519	1519-047	2020-04-02	2023-04-01
TRILOG Broadband Antenna	SCHWARZBECK	VULB 9163	1023	2020-05-05	2023-05-04
Horn Antenna	R&S	HF907	102723	2020-08-11	2023-08-10
Horn Antenna	ETS-Lindgren	3160-09	00102643	2021-10-10	2024-10-09
Horn Antenna	STEATITE	QSH-SL-26-40-K-15	16779	2019-12-24	2022-12-23
Software	R&S	EMC32	9.26.0	/	/
Spectrum Analyzer	KEYSIGHT	N9020A	MY50510203	2021-12-12	2022-12-11
				2022-12-10	2023-12-09
DC Power Supply	UNI-T	UTP1306S+	2205D0517232	2021-12-12	2022-12-11
				2022-12-10	2023-12-09
Climate Chamber	ESPEC	SU-242	93000506	2021-12-12	2022-12-11
				2022-12-10	2023-12-09

## ANNEX A: The EUT Appearance

The EUT Appearance are submitted separately.

## ANNEX B: Test Setup Photos

The Test Setup Photos are submitted separately.

\*\*\*\*\* END OF REPORT \*\*\*\*\*