



VP6825™ User Manual



80184501-001 Rev 56
16 June 2023

ID TECH®
10721 Walker Street Cypress, CA 90630
(714) 761-6368
www.idtechproducts.com support@idtechproducts.com

Copyright © 2023 ID TECH. All rights reserved.

This document, as well as the software and hardware described in it, is furnished under license and may be used or copied online in accordance with the terms of such license. The content of this document is furnished for information use only, is subject to change without notice, and should not be construed as a commitment by ID TECH®. While every effort has been made to ensure the accuracy of the information provided, ID TECH assumes no responsibility or liability for any unintentional errors or inaccuracies that may appear in this document. Except as permitted by such license, no part of this publication may be reproduced or transmitted by electronic, mechanical, recording, or otherwise, or translated into any language form without the express written consent of ID TECH.

ID TECH and ViVOPay® are trademarks or registered trademarks of ID TECH.

Warranty Disclaimer

The services and hardware are provided "as is" and "as-available" and the use of the services and hardware are at its own risk. ID TECH does not make, and hereby disclaims, any and all other express or implied warranties, including, but not limited to, warranties of merchantability, fitness for a particular purpose, title, and any warranties arising from a course of dealing, usage, or trade practice. ID TECH does not warrant that the services or hardware will be uninterrupted, error-free, or completely secure.

FCC warning statement

This device complies with Part 15 of the FCC Rules. Operation is subject to the following two conditions: (1) this device may not cause harmful interference, and (2) this device must accept any interference received, including interference that may cause undesired operation.

The user manual for an intentional or unintentional radiator shall caution the user that changes, or modifications not expressly approved by the party responsible for compliance could void the user’s authority to operate the equipment.



Note: The grantee is not responsible for any changes or modifications not expressly approved by the party responsible for compliance. Such modifications could void the user’s authority to operate the equipment.

Note: This equipment has been tested and found to comply with the limits for a Class B digital device, pursuant to part 15 of the FCC Rules. These limits are designed to provide reasonable protection against harmful interference in a residential installation. This equipment generates uses and can radiate radio frequency energy and, if not installed and used in accordance with the instructions, may cause harmful interference to radio communications. However, there is no guarantee that interference will not occur in a particular installation. If this equipment does cause harmful interference to radio or television reception, which can be determined by turning the equipment off and on, the user is encouraged to try to correct the interference by one or more of the following measures:

- Reorient or relocate the receiving antenna.
- Increase the separation between the equipment and the receiver.
- Connect the equipment into an outlet on a circuit different from that to which the receiver is connected.
- Consult the dealer or an experienced radio/TV technician for help.

This device complies with FCC RF radiation exposure limits set forth for an uncontrolled environment. The antenna(s) used for this transmitter must not be co-located or operating in conjunction with any other antenna or transmitter. This device should be installed to provide a separation distance of at least 20cm from a person.

Cautions and Warnings

	Caution: Use standard USB 5V power source for USB operation. Use approved power source for RS-232 operation. Device contains a lithium battery. Approved temperature range for storage: -30°C to +80°C. Disposal: Contact your local recycling center.
	Warning: Avoid close proximity to radio transmitters, which may reduce the capabilities of the reader.

ISED Warning statements

This device complies with Canada's licence-exempt RSSs. Operation is subject to the following two conditions: (1) This device may not cause interference; and (2) This device must accept any interference, including interference that may cause undesired operation of the device.

Le présent appareil est conforme aux CNR d'Industrie Canada applicables aux appareils radio exempts de licence. L'exploitation est autorisée aux deux conditions suivantes :

(1) l'appareil ne doit pas produire de brouillage, et (2) l'utilisateur de l'appareil doit accepter tout brouillage radioélectrique subi, même si le brouillage est susceptible d'en compromettre le fonctionnement.

This equipment complies with IC RSS-102 radiation exposure limits set forth for an uncontrolled environment. This equipment should be installed and operated with a minimum distance of 20cm between the radiator and any part of your body.

Pour se conformer aux exigences de conformité CNR 102 RF exposition, une distance de separation d'au moins 20 cm doit être maintenue entre l'antenne de cet appareil et toutes les personnes.

This Class B digital apparatus complies with Canadian ICES-003.

Cet appareil numérique de la classe B est conforme à la norme NMB-003 du Canada.

The device is restricted to indoor use only when operating in the 5150 to 5250 MHz frequency range. L'appareil est limité à une utilisation en intérieur uniquement lorsqu'il fonctionne dans la plage de fréquences de 5150 à 5250 MHz.

CE Caution:

RF Exposure

This equipment complies with CE radiation exposure limits set forth for an uncontrolled environment. This equipment should be installed and operated with a minimum distance of 20cm between the radiator and your body.

EU DECLARATION OF CONFORMITY



Hereby, ID TECH declares that the radio equipment type VP6825 is in compliance with Directive 2014/53/EU.

The full text of the EU declaration of conformity is available at the following Internet address: <https://idtechproducts.com/>

The device is restricted to indoor use only when operating in the 5150 to 5350 MHz frequency range.

	AT	BE	BG	HR	CY	CZ	DK
	EE	FI	FR	DE	EL	HU	IE
	IT	LV	LT	LU	MT	NL	PL
	PT	RO	SK	SI	ES	SE	UK(NI)

Notice for Operating Frequency and Output Power

Feature	Model: VP6825-800	Model: VP6825-8300
NFC	<116.7dBuV/m at 3m (Measured Value)	<116.7dBuV/m at 3m (Measured Value)
2.4G WLAN (b/g/n): 2400-2483.5 MHz (EIRP dBm)	<20	<20
5G WLAN (a/n/ac): 5150-5250/5250-5350/5470-5725 MHz (EIRP dBm)	<20	<20
BT-EDR/LE (EIRP dBm)	<10	<10
2G (dBm)	Not Applicable	GSM900: <33 GSM1800: <30
3G (dBm)	Not Applicable	Band I: <24 Band VIII: <24
4G (dBm)	Not Applicable	Band 1/20: <23 Band 3: <23 Band 7: <23 Band 8: <23 Band 20: <23 Band 28: <23

Revision History

Date	Rev	Changes	Author
10/27/2021	50	Initial VP6825 draft; forked from VP6800 rev V	CB
11/24/2022	51	Modify product spec and features for the following variants. VP6825-800 Rev. 54 VP6825-8100 Rev. 56 VP6825-8300 Rev. 56	EC
11/28/2022	52	Style and formatting changes.	CB
12/15/2022	53	Update to dimensions; separated device and envelope measurements.	CB
12/27/2022	54	Updated outstanding spec information requests. Updated mounting image.	CB
01/04/2023	55	Updates to uDemo images and mounting image.	CB
06/05/2023	56	Various spec updates. Updated configuration steps.	CB

TABLE OF CONTENTS

1. OVERVIEW	8
1.1. Integration Location.....	8
1.2. Integration Options.....	8
1.3. Encryption.....	9
2. FEATURES.....	9
2.1. Agency Approvals and Compliances.....	10
3. SPECIFICATIONS.....	11
4. COMMUNICATIONS	12
4.1. Audio Support.....	12
5. CABLE INTERFACES	13
6. BASIC OPERATION	14
6.1. VP6825 Card Interfaces	14
6.2. LEDs and LCD Status Indicators.....	15
6.3. Device State and UI.....	16
6.4. Tamper and Failed Self-Check Indicators	17
6.4.1. <i>Other Status Messages</i>	18
7. INSTALLATION.....	19
7.1. Parts List for Development	19
7.2. VP6825 Mounting Guidelines and Installation.....	20
7.3. Bluetooth Connection	22
8. VP6825 CONFIGURATION SETTINGS.....	22
8.1. Configuring Ethernet Settings.....	23
8.1.1. <i>Setting the Device IP</i>	24
8.1.2. <i>Setting the Remote IP</i>	25
8.2. Configuring Wi-Fi Settings.....	27
8.3. Configuring BLE Settings.....	28
8.4. Configuring LTE Settings (Support in Phase 2).....	29
9. SECURITY GUIDE	29
10. DECOMMISSIONING PCI-CERTIFIED DEVICES	30
11. TROUBLESHOOTING.....	30
12. 24-HOUR DEVICE REBOOT.....	30
13. FIRMWARE REFERENCE.....	30
14. SOFTWARE DEVELOPMENT SUPPORT	30
15. UPDATING VP6825 FIRMWARE.....	31
16. APPENDIX A: SUPPORTED MICRO SD CARDS	34

1. Overview

The all-new VP6825 by ID TECH is a state-of-the-art, 3-in-1, PCI PTS 6.1 certified unattended payment device that can accept magstripe, chip card (EMV), and/or NFC/contactless payments. The unit features a 4.3-inch high-luminosity color touchscreen display capable of supporting PIN-on-glass transactions.

The VP6825 accepts all of today's most popular payment methods, including those based on digital wallet technology, including Apple Pay, Android Pay, and Samsung Pay, along with support for loyalty technologies such as Apple Pay VAS and Google Pay SmartTap. The VP6825 is suitable for payment solutions involving:

- Transportation
- Vending
- Parking
- Quick Service Restaurants
- POS Kiosks

1.1. Integration Location

The VP6825 is the next generation vending payment peripheral in the popular ID TECH Vending line (including Vendi, VP6300, and VP6800) of unattended contactless payment hardware. This device is intended to be deployed on unattended kiosks, parking systems, and vending machines that support a variety of different payment methods, digital advertising, and guidance using visual payment prompts.

1.2. Integration Options

ID TECH provides a feature-rich Universal SDK to aid rapid development of external (non-device-resident) payment applications that talk to the VP6825. The Universal SDK is available for the C# language on Windows and comes with sample code for demo apps. To obtain the SDK and other useful utilities, demos, and downloads for the VP6825, be sure to check the Downloads link on the [ID TECH Knowledge Base](#) (no registration required).

1.3. Encryption

The VP6825 supports industry-standard Triple DES or AES encryption technology, with DUKPT-based key management (per ANSI X.9-24). Encryption can be configured to occur with a PIN variant key, or Data variant, as desired. ID TECH operates a certified Key Injection Facility, capable of injecting your unit(s) with any required keys. Remote Key Injection (RKI) is also available. Consult your ID TECH representative to learn about all available options involving key injection.

As a PCI-validated SRED device, the VP6825 conducts periodic self-checks and incorporates tamper detection features which, if triggered, cause automatic zeroization of sensitive data and keys. Because of its SRED features, the VP6825 is fully capable of being incorporated into a P2PE certified solution.

2. Features

- 4.3-inch color digital display (480 x 272 pixels)
- Supports PIN on glass
- Concealed contactless antenna
- PCI PTS 6.2 certified with SRED validation
- Connectivity interface – RS-232, USB 2.0 via USB-C, Ethernet 10/100M¹, Wi-Fi/BLE, and optional LTE 4G²
- Audio Line Out through mini-HDMI port
- Camera or 1D/2D scanner
- Supports EVA standard external mounting
- Support Common Contact L2 Kernel
- Support for contactless loyalty protocols (Apple Pay VAS, Google Pay SmartTap)
- Contactless payments (Apple Pay, Google Pay, Samsung Pay)
- Supports the latest EMV Contactless L2 kernels: AMEX, Discover, Interac, Mastercard, Visa
- Environmental certifications (RoHS, REACH, RED)
- Encryption support (TDES, AES, RSA)
- Remote Key Injection Support (PCI validated)
- Firmware upgradeable in the field

¹ Note: the VP6825 must be power-cycled to switch between 10M and 100M.

² Note: Only VP6825-8100, VP6825-8300, and VP6825-8600 support LTE.

2.1. Agency Approvals and Compliances

- CE
- EMV Contact L1 & L2
- EMV Contactless L1
- EMV Contactless L2s:
 - Amex
 - Discover
 - Interac
 - JCB
 - MasterCard
 - UPI
 - Visa
- FCC (Part 15, Class-B)
- Felica
- MIC (Japan)
- PCI PTS 6.2
- REACH
- RoHS3
- Telec (Japan)
- UL
- USB 2.0

3. Specifications

Hardware	
CPU	528 MHz application processor
Memory	512Mb SDRAM, 1Gb NAND flash
Camera	VGA (300K pixel) camera for barcode scanning
SAMs	4 SAMs (3 SAMs with LTE radio option*)
SIMs	2 SIMs (with LTE radio option*)
SD card slot	1 slot
Audio	Audio Line Out through mini-HDMI port
Interface	USB, RS232, Ethernet, BLE/Wi-Fi, LTE 4G CAT1 (Optional*)
Power Supply	+5VDC 2A
Power Consumption	Active Power mode: 3.0w
Physical	
External Dimensions	132mm x 88mm x 27.5mm
Envelope Dimensions	132mm x 88mm x 43mm
Screen	
Dimensions (in pixels)	480 (height) x 272 (width)
Luminance/Brightness	Up to 800 NITs
Touch Interface Type	Capacitive
Environmental	
Operating Temperature	-20° C to 70° C (-4° F to 158° F), max change of 10° C per hour
Storage Temperature	-30° C to 80° C (-22° F to 176° F)
Operating Humidity	Up to 95% non-condensing
Storage Humidity	15% to 90% non-condensing, duration three months
IK Rating	IK 08
IP Rating	IP 65
Durability	
Product Life	Five years
MSR Swipe Durability	1,000,000 times
ICC Connector Reliability	500,000 times

* Only VP6825-8100, VP6825-8300, and VP6825-8600 support LTE.

Note: Boot-up time can vary for VP6825 readers depending on configuration; boot-up is usually complete within 30 seconds. "Power On" is defined as the length of time from pressing the power button to the screen displaying the ID TECH logo; "Wake Up" is defined as the length of time from tapping the screen to the screen displaying the ID TECH logo.

Mode	Boot Up Time	
	Average	Maximum
Power On	15s	30s
Wake Up from Sleep Mode	0.5s	1s

4. Communications

The VP6825 can communicate with a host via serial (RS-232), Wi-Fi, Bluetooth, USB, Ethernet, or LTE 4G connections. The diagram below illustrates the layout of various ports.

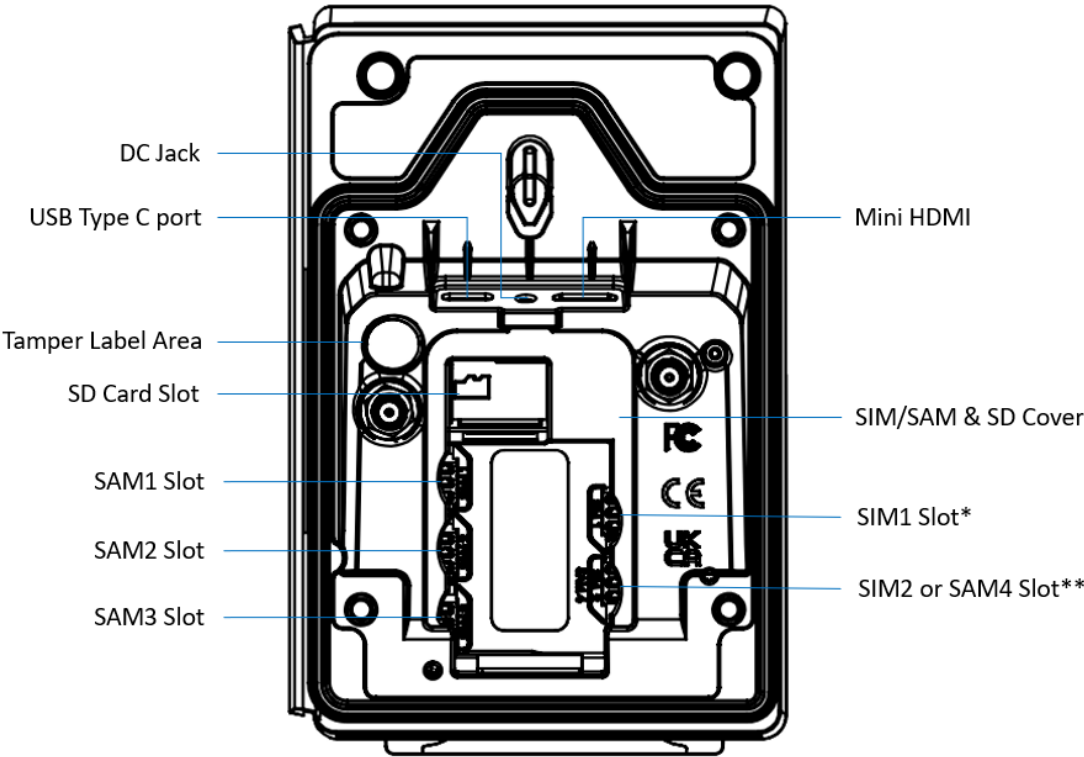

* Only VP6825-8100, VP6825-8300, and VP6825-8600 support SIM1.

** Only VP6825-8100, VP6825-8300, and VP6825-8600 support SIM2. VP6825-800 units use it as SAM4.

4.1. Audio Support

VP6825 is equipped with an internal speaker to host 16mb .WAV files and can also connect to an external speaker via Audio Line Out through mini-HDMI port (this requires an extra direct cable or multi-port cable for the connection).

5. Cable Interfaces

The VP6825 can use a USB -C cable or multi-port cable to connect to the host. The MP cable can bridge out the signals of USB-C (slave), USB Type A (host), Ethernet, RS232, and Audio Line Out. VP6825 readers require a power supply from a PD adapter.

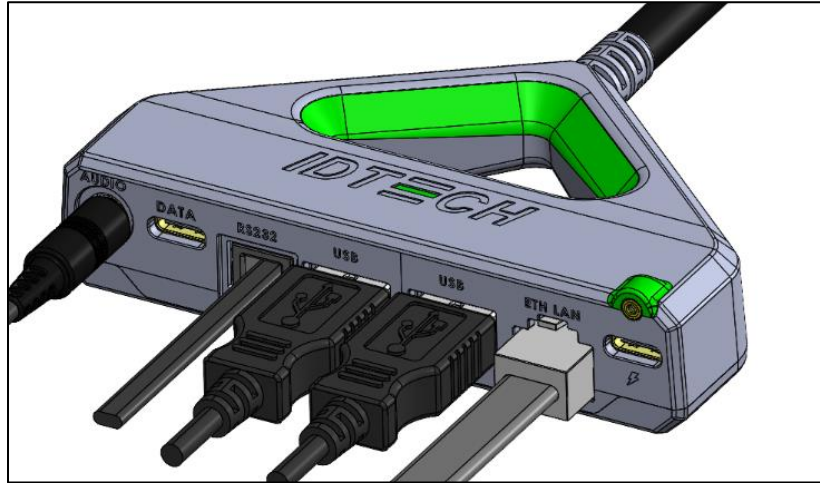

The table below illustrates the MP cable's pin out definitions.

Signal	Pin
ETHERNET_TXP	J982.14
ETHERNET_TXN	J982.15
ETHERNET_RXP	J982.17
ETHERNET_RXN	J982.18
USBA_DP	J982.5
USBA_DN	J982.6
USB_OTG1_DP	J981.B6,A6
USB_OTG1_DN	J981.B7,A7
LINEOUT_L	J982.1
LINEOUT_R	J982.2
DC_IN	J980.1
DC_GND	J980.2
MULTIPOINT_ID	J982.3
AP_RS232_TX	J982.8
AP_RS232_RX	J982.9
CC1	J981.A5
CC2 not use	J981.B5
HEADSET_DET	J982.11
USB-C_VIN_UFP_IOBOARD	J982.12

6. Basic Operation

When powered on, the VP6825 boots automatically and illuminates within about five seconds. For development purposes, integrators can use a multi-port cable. Plug the terminal connector into the back of the VP6825, and supply 5V/2A power via multi-port cable with a PD adapter. Optionally, integrators can connect a standard Ethernet cable between the RJ45 ports on the multi-port cable and the network port of the host system.

6.1. VP6825 Card Interfaces

VP6825 readers have the following card interface points, shown below.

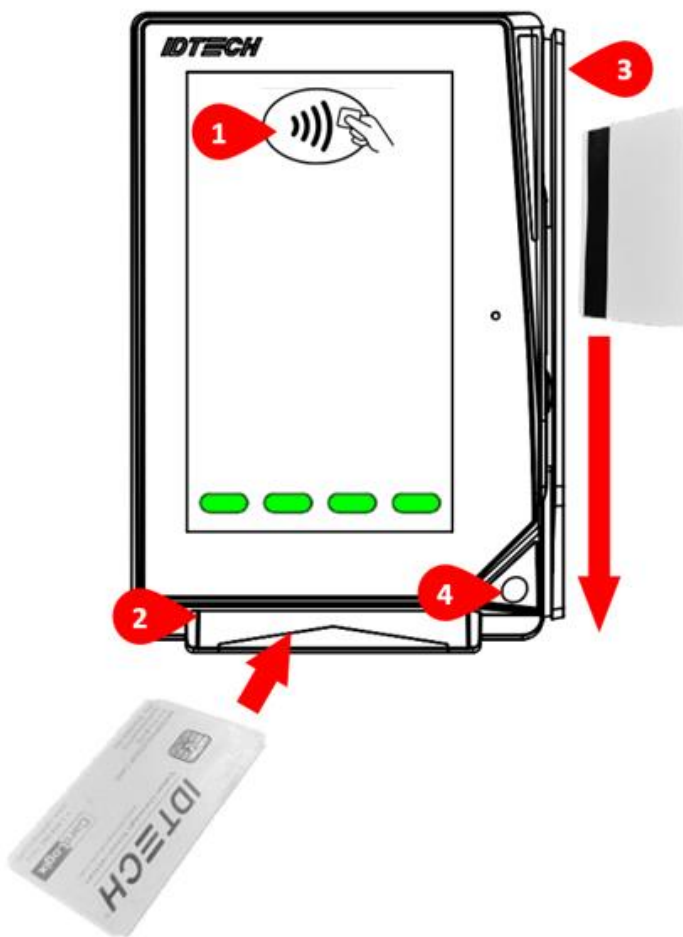

Interface	Note
1. Contactless antenna	None.
2. ICC slot	Smart chip must face upward for ICC transactions.
3. MSR slot	MagStripe must face left for MSR swipes.
4. QR Code camera	Rotate image 45 degree facing the camera.

6.2. LEDs and LCD Status Indicators

The VP6825 uses LEDs and the main LCD display to denote its status during transactions and in case of errors. Contactless LED lights appear on the digital display.

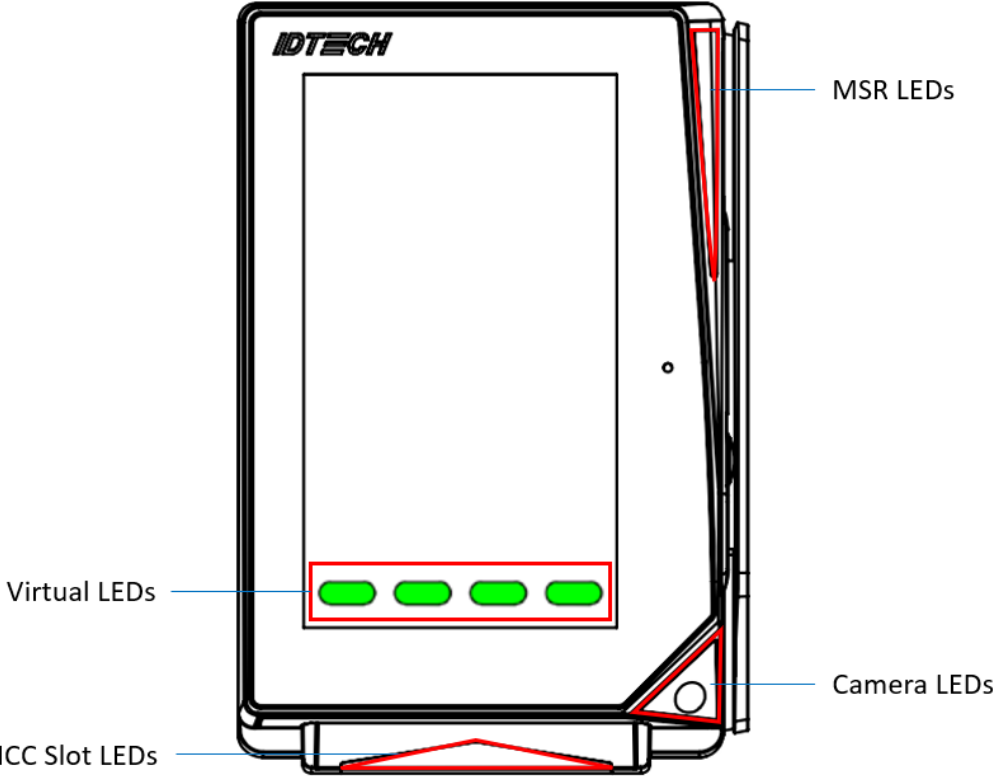

LED and Behavior	Status Indicated
First left virtual LED blink green regularly	VP6825 in standby awaiting transaction
First left virtual LED is solid green	Contactless transaction started
All four virtual LEDs blink green	Contactless transaction complete
ICC slot green LED is on	ICC transaction started
ICC slot red LED is on	Device error(s)
MSR LEDs on	MSR transaction started
Camera LEDs on	Camera is on and ready for capture

6.3. Device State and UI

State	Beep	LCD	Indicating
De-activated	Beep every 5 seconds	"DEACTIVATED"	Device is in "Manufactory mode;" no security functions enabled.
Activated	No Beeper	"ACTIVATED"	Manufactory data and certificate loaded into device, but no working keys.
Common	No Beeper	"NO KEY INJECTED"	Device activated but not ready for sensitive functions. The reason should be due to missing required keys.
Ready	No Beeper	"WELCOME"	Device ready for sensitive functions, like transaction, Get PIN ,GET account, etc.
Tamper	Alarm Tone	"TAMPERED"	Device was tampered by physical, temperature, or voltage attack. All sensitive information is erased or unrecoverable. Device blocks all sensitive function. There is no way to recover except to return to manufacturer.

6.4. Tamper and Failed Self-Check Indicators

The VP6825 displays the following indicators when it has been tampered or has any of the other following internal issues, such as an expired certificate, missing key, or similar fault discovered during a self-check.

Note that the Tampered screen also displays configuration information used to diagnose the cause of the issue, similar to the image below on the right:

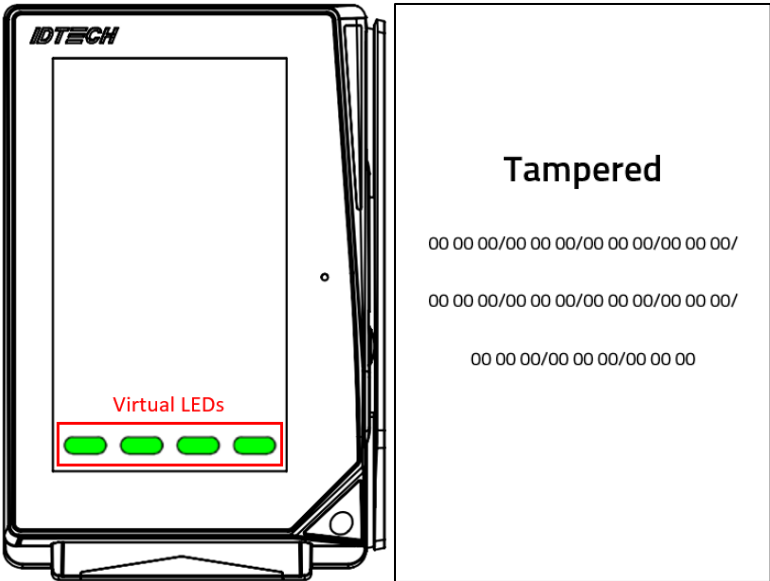

Indicator	Tampered Status	Other Issue Status
Virtual LEDs	All Virtual LEDs off	All Virtual LEDs off
LCD Display Message	TAMPERED	See below
Speaker	Alarm tone	See below

6.4.1. Other Status Messages

The VP6825's LCD can display the following messages for both regular status and in the event of a failed self-check:

State	Speaker	LCD	Indicating
Tamper triggered	Alarm Tone	"TAMPERED"	Device was tampered by physical, temperature, or voltage attack. All sensitive information is erased or unrecoverable. The reader blocks all sensitive functions. There is no way to recover the reader except to return it to ID TECH.
Certification check fail	No sound	"Cert Fail"	Certificate tree self-check has failed (example of failure: expiration of certification).
Firmware integrity check fail	No sound	"MSRFail"	MSR failure, usually caused by the abnormal state of the MSR module.
	No sound	"FW/BL Fail"	Firmware self-check has failed
Abnormal Key Status	No sound	"Keys Fail"	Encryption key self-check has failed.
	No sound	"NO KEY INJECTED"	The reader is activated but not ready for sensitive functions. The reason is most likely due to missing required keys.
Deactivated	Beep every 5 seconds	"DEACTIVATED"	The reader is in "Manufactory mode;" no security functions are enabled.
Activated	No sound	"ACTIVATED"	Manufactory data and certificate are loaded into the reader, but no working keys.
Ready	No sound	"WELCOME"	The reader is ready for sensitive functions like transactions, Get PIN ,GET account, and similar commands.
Restrict	No sound	"RESTRICTED"	Device is suspended due to reach the retry limitation (3 times in succession) of bad signature verification, may recover after 15 mins. Once recovered, a good signature verification may reset the retry limitation, but a bad signature verification may suspend another 15 mins.

If your VP6825 is tampered, contact [ID TECH support](#) for assistance.

7. Installation

The sections below describe VP6825 installation.

7.1. Parts List for Development

Verify that you have the following hardware for the installation of the VP6825:

- USB-C cable or multi-port cable
- 5V/2A DC Power supply or a PD Power supply when connected with the multi-port cable

7.2. VP6825 Mounting Guidelines and Installation

Mount the unit according to the drawings shown, with #8-32 studs spaced 65mm apart horizontally and 67mm vertically. The pitch of the nuts is the same as those used for Vendi, VP6300, and VP6800 readers. Use a torque wrench to tighten the screws to 8kg-cm.

For safety reasons, make sure to mount the VP6825 at a height no greater than two meters or no lower than 1.2 meters from the floor.

Warning: The antenna's RF field is sensitive to the proximity of metal. There are three options for mounting the VP6825 on a metal surface:

- Mount with the RF emitting surface of the antenna at least 1cm *in front* of any metal.
- Mount with the RF emitting surface of the antenna at least 1cm *behind* any metal. **This will reduce the effective range of the antenna and is not recommended.**
- Mount flush with the metal, but allow a minimum of 1cm distance from the metal

Above all else, do not mount the VP6825 in a location where it is surrounded by metal.

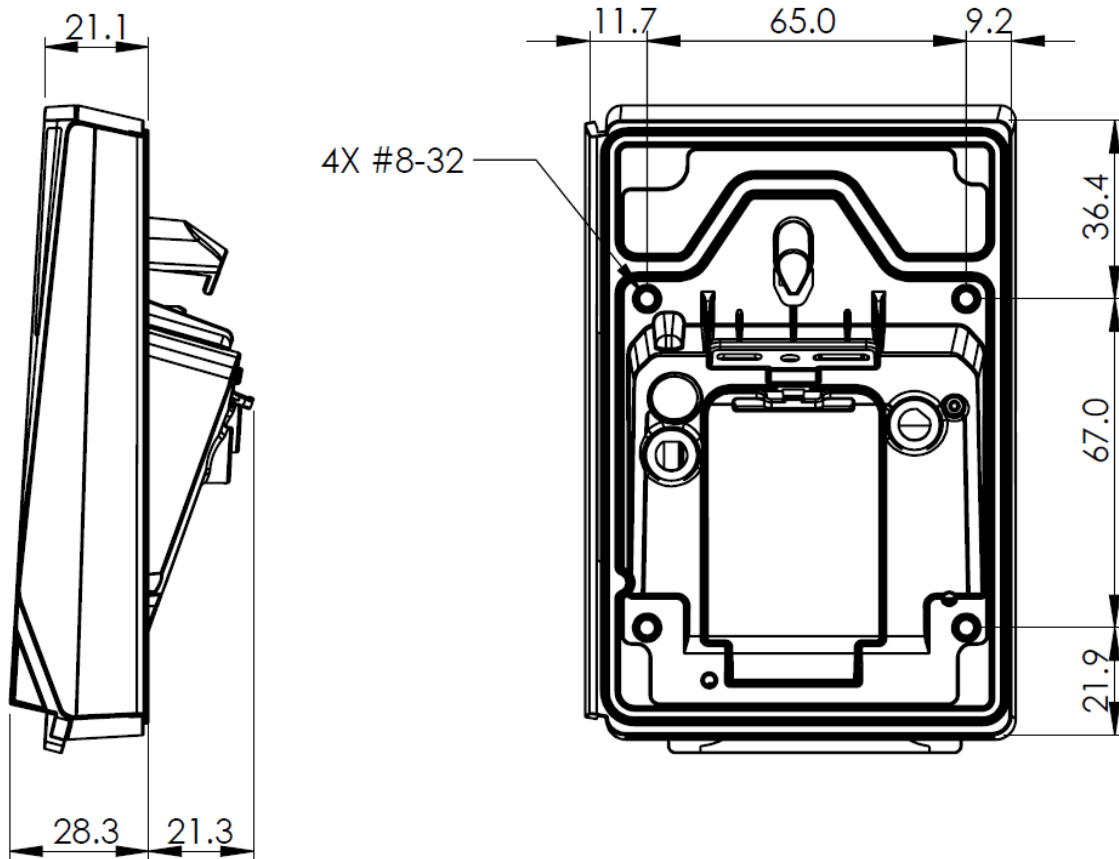

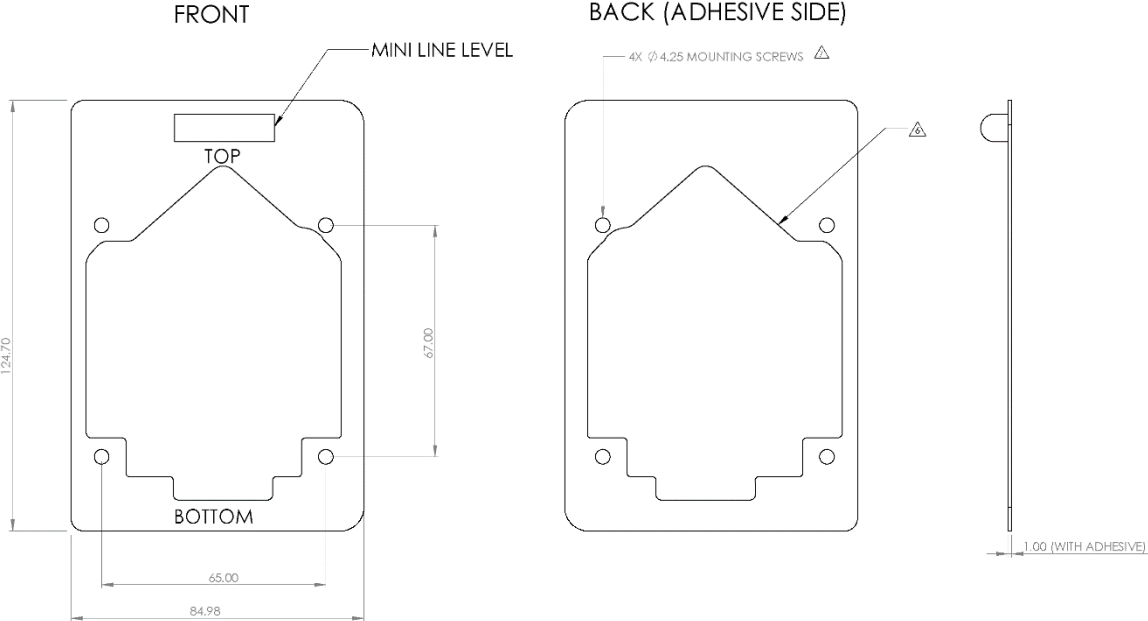

7.3. Bluetooth Connection

When using Bluetooth communication with the host, follow these steps:

1. Search for Bluetooth name of **VP6825** on the mobile host.
2. Select **Pairing**.
3. The VP6825 will display a window with a random passkey.
4. Enter the random passkey on your mobile to set up the link.

8. VP6825 Configuration Settings

Setting up the VP6825 requires users to enter the main menu **each time they enter a sub-menu, even if they do not save any setting changes.**

Note that users can change many of the settings below via firmware commands. To use firmware commands to configure a VP6825 unit, refer to the *NEO 2 Interface Developer's Guide*, available from your ID TECH representative.

Follow the steps below to access the main menu.

1. Power on the VP6825.
2. Perform a quick press in the top-right corner, then a long press in the top-left corner to enter the **Settings** menu.

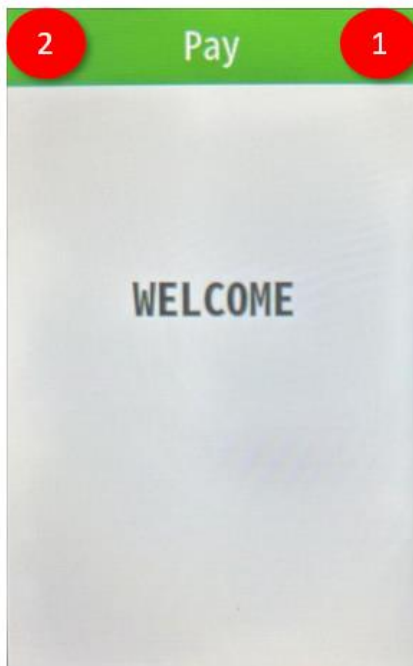

8.1. Configuring Ethernet Settings

Follow the steps below to configure ethernet settings.

1. Enter the main menu and select **Ethernet**.



2. Swipe the button to right to turn on Ethernet.

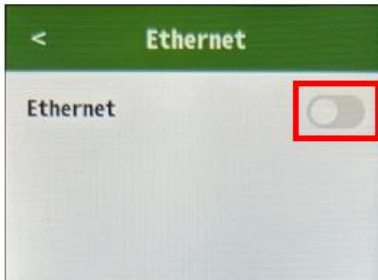

- a. Select **Configure IP** or **Remote Settings** as needed.

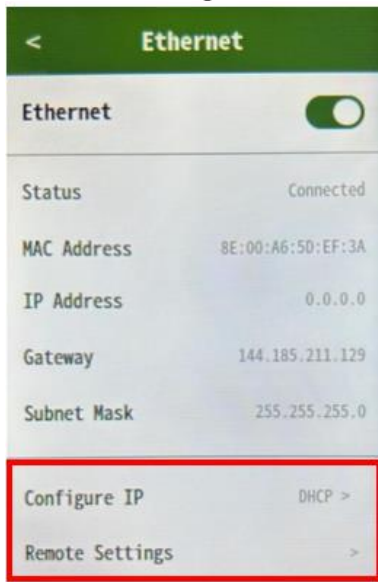

8.1.1. Setting the Device IP

1. Select **Configure IP**.

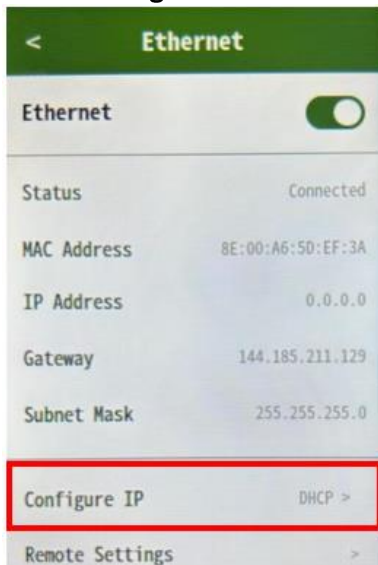

2. Select IP Configuration Mode as needed: **Static** or **DHCP**.

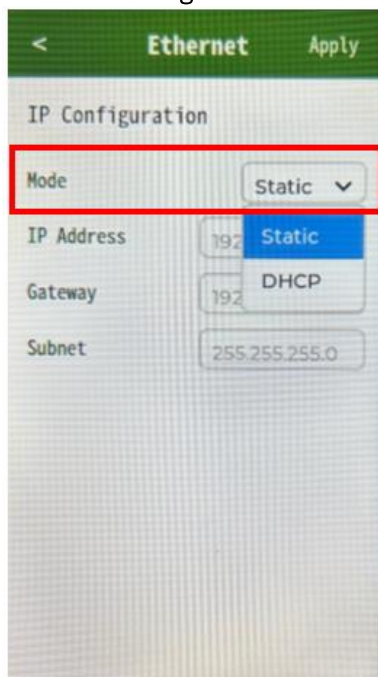

3. If **Static** is selected,
 - a. Enter **IP Address**, **Gateway**, and **Subnet** information.
 - b. Select **Apply** to complete the configuration.

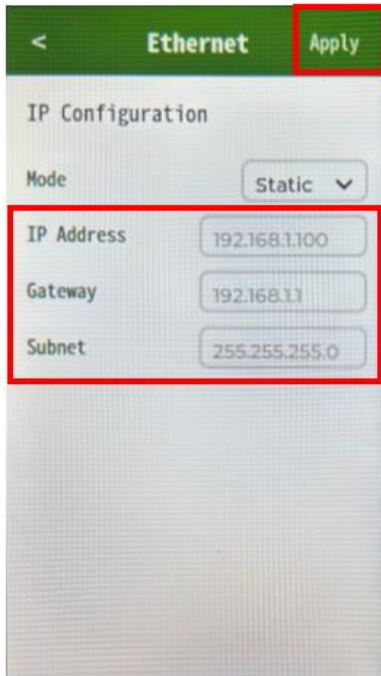

8.1.2. Setting the Remote IP

1. To set the Remote IP, enter the required IP address information.
2. Select **Apply** to complete the configuration.

ID TECH's Encryption protocol port is **1443**; make sure to enter that number as the port.

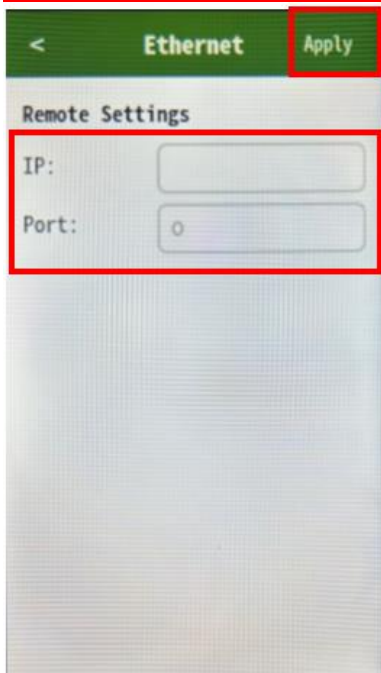

3. The VP6825's screen displays an **IP is Set** dialog on success.

- Next, on a Windows computer, open **Network & Internet Settings** by right-clicking the internet connection icon in the taskbar.

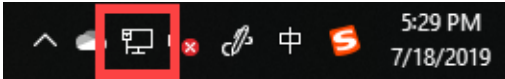

- Click **Change Adapter Options**.

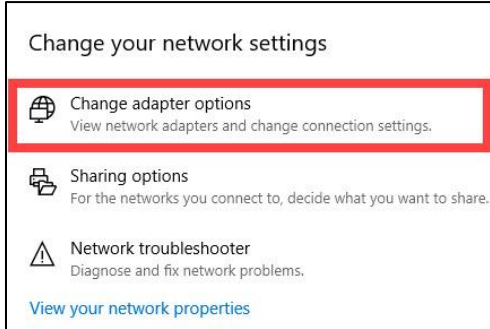

- Right-click on your Network Connection and select **Properties**.

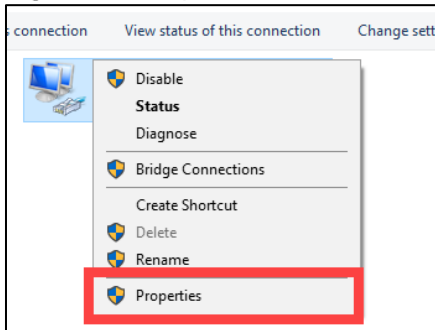

- Select **Use the following IP address**, enter the required IP information, then click **OK**.

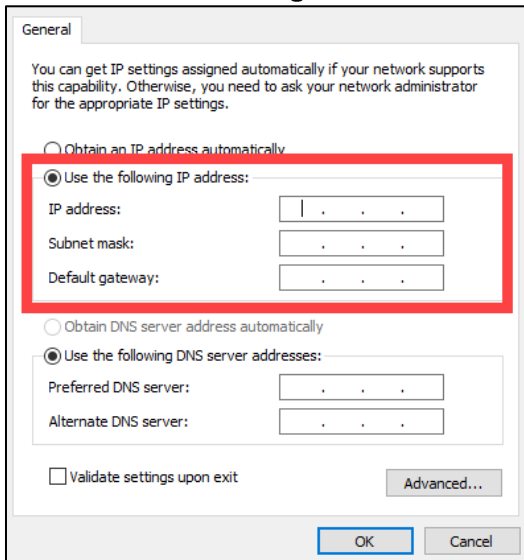

8.2. Configuring Wi-Fi Settings

Follow the steps below to configure Wi-Fi settings.

1. Enter the main menu and select **Wi-Fi**.



2. Swipe the button to right to turn on Wi-Fi.

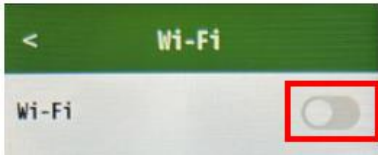

3. Choose the SSID you want to connect to from **Available Networks**.

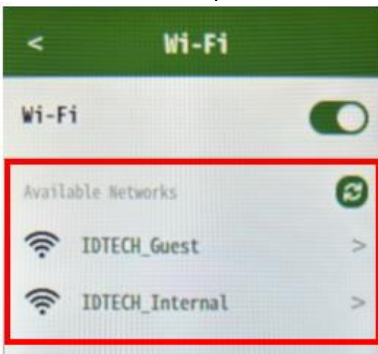

4. Enter Password and select Connect to complete the configuration.



8.3. Configuring BLE Settings

Follow the steps below to configure Bluetooth name settings.

1. Enter the main menu and select **Bluetooth**.



2. Swipe the button to right to turn on Bluetooth.

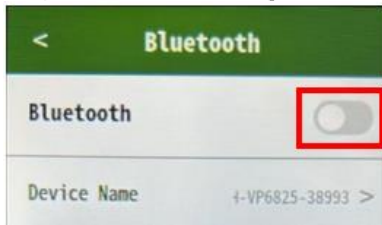

3. The default Device Name is "IDTECH-VP6825-" plus the last 5 digit of device serial number. Select **Device Name** if a new name is needed.

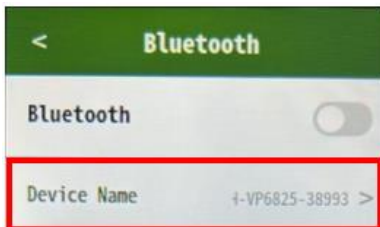

4. Enter the new name and select **Apply** to complete the configuration.



8.4. Configuring LTE Settings (Support in Phase 2)

9. Security Guide

The VP6825 is an unattended device. Contact your ID TECH representative or send an e-mail to support@idtechproducts.com if you have any questions involving the product's daily use. We recommend you conduct daily checks of the device as follows:

- Check the tamper evidence physical seals, to make sure they are intact.
- Power on the device, check the beeper, and the display message, making sure there is no tamper indication (see earlier chart for beeper interpretation). Also read the firmware version, making sure the firmware version is correct.
- Check the touchpad, to make sure there is no physical overlay on the touchpad.
- Check the appearance of device, to make sure there isn't any hole on the device or suspicious object around the ICC card slot.
- Check the MSR (magnetic stripe) slot, to make sure there is no alteration of the device.

10. Decommissioning PCI-Certified Devices

All PCI devices require proper decommissioning prior to device disposal in order to ensure the protection of all sensitive financial card data. For instructions on decommissioning your device, see [Decommissioning of PCI-Certified Devices](#) on the ID TECH Knowledge Base.

11. Troubleshooting

Consult the [ID TECH Knowledge Base](#) for troubleshooting assistance.

12. 24-Hour Device Reboot

Per PCI Requirements, this device reboots every 24 hours. Please contact your device integrator if you need to check the reboot time for your unit.

13. Firmware Reference

The VP6825 uses ID TECH's NEO 2 firmware. For a comprehensive guide to the device's firmware-level commands, ask your ID TECH representative for the *NEO 2 Interface Developer's Guide* (or IDG). It is available at no charge to customers on request.

14. Software Development Support

To facilitate integration of the VP6825 into vending, POS, and other environments, ID TECH makes available a Universal SDK that enables the rapid development of software apps for the VP6825 using C# on Windows or C++ on Linux. To obtain the Universal SDK, go to the ID TECH [Knowledge Base](#) and choose the VP6825 from the Product page listings. Further information will be available there.

The Universal SDK contains redistributable libraries, sample code, and other materials that will aid you in quickly creating the VP6825 applications, greatly reducing the time spent in configuring the device, parsing transaction data, etc.

15. Updating VP6825 Firmware

The steps below describe the process for updating VP6825's firmware (for both its K81 and RT1052 processors) via the Universal SDK Demo.

Note: Before you begin, contact your ID TECH representative to receive the most recent VP6825 firmware. Download the ZIP file and extract it to your computer.

1. Connect the VP6825 to your PC via USB or serial port.
2. Download and install the latest [USDK Demo app](#) from the ID TECH Knowledge Base (if you cannot access the link, please [contact support](#)).
3. Open the USDK Demo app from the Windows Start menu.

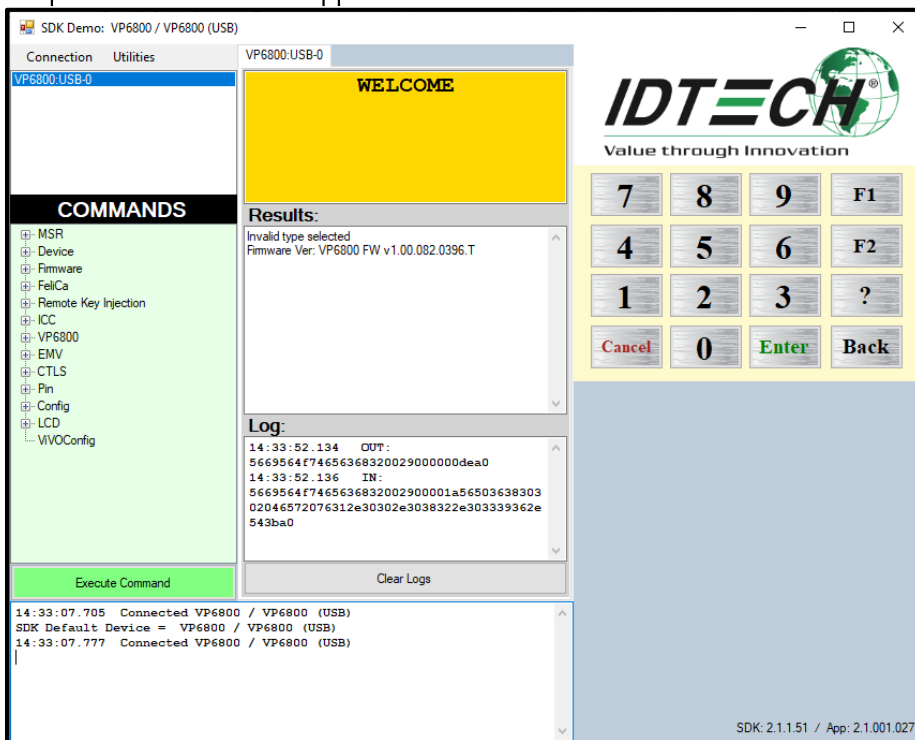

- Under **Firmware**, select **Update Device Firmware**, then click **Execute Command**.

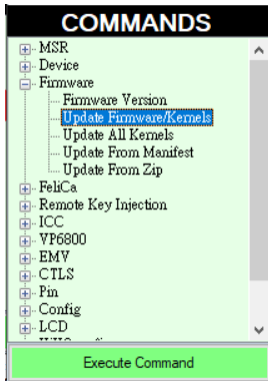

- In the **Firmware Type** dialog, enter **255** for **K81 FW** and click **OK**.



- In the File Explorer window, navigate to the directory where you saved the K81 firmware update, select the FW file that starts with **VP6825_FM_...** and click **Open**.
- The VP6825 reboots and enters the bootloader, at which point the USDK Demo app begins updating the device's K81 firmware.
- When the K81 firmware update completes, the VP6825 reboots again and the USDK Demo app prints **Firmware Update Successful** in the **Results** panel.

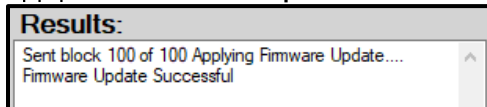

- Next, to update the RT1050 Firmware select **Firmware**, select **Update Device Firmware**, then click **Execute Command** again.

10. This time in the **Firmware Type** dialog, enter **16** for **RT1050 FW** and click **OK**.



11. In the File Explorer window, navigate to the directory where you saved the RT1050 firmware update, select the RT1050 FW file that starts with **VP6825_Ext_FM_...** and click **Open**.
12. The VP6825 reboots and enters the bootloader again to update the device's RT1050 firmware.
13. When the RT1050 firmware update completes, the VP6825 reboots again and the USDK Demo app prints **Firmware Update Successful** in the **Results** panel.

16. Appendix A: Supported Micro SD Cards

The VP6825 supports a limited number of Micro SD cards; the following cards have been tested and verified for the device:

- Kingston/SDCS/16GB
- Kingston/SDCS/32GB
- SanDisk/micro SDHC UHS-I card/16G
- SanDisk/micro SDHC UHS-I card/32G