

# Test report

**360804-3TRFWL**

Date of issue: April 10, 2019

Applicant:

**Siemens Canada Limited**

Product:

**CPE**

Model:

**WIN5137**

Model variants:

**WIN5137-AC, WIN5137-DC, WIN5237, WIN5137-AC-IS,  
WIN5237-IS, WIN5137-V, WIN5137-V-GPS**

FCC ID:

**WQE5237001**

Specifications:

◆ **FCC 47 CFR Part 96**

Citizens Broadband Radio Service

Test location

---

Company name	Nemko Canada Inc.
Address	303 River Road
City	Ottawa
Province	Ontario
Postal code	K1V 1H2
Country	Canada
Telephone	+1 613 737 9680
Facsimile	+1 613 737 9691
Toll free	+1 800 563 6336
Website	www.nemko.com
Site number	FCC: CA2040 (3 m semi anechoic chamber)

Tested by	Andrey Adelberg, Senior Wireless/EMC Specialist
Reviewed by	Kevin Rose, Wireless/EMC Specialist
Date	April 10, 2019
Signature of reviewer	

Limits of responsibility

---

Note that the results contained in this report relate only to the items tested and were obtained in the period between the date of initial receipt of samples and the date of issue of the report.

This test report has been completed in accordance with the requirements of ISO/IEC 17025. All results contain in this report are within Nemko Canada's ISO/IEC 17025 accreditation.

Copyright notification

---

Nemko Canada Inc. authorizes the applicant to reproduce this report provided it is reproduced in its entirety and for use by the company's employees only. Any use which a third party makes of this report, or any reliance on or decisions to be made based on it, are the responsibility of such third parties.

Nemko Canada Inc. accepts no responsibility for damages, if any, suffered by any third party as a result of decisions made or actions based on this report.

© Nemko Canada Inc.

## Table of contents

<b>Table of contents</b> .....	<b>3</b>
<b>Section 1. Report summary</b> .....	<b>4</b>
1.1 Applicant and manufacturer .....	4
1.2 Test specifications .....	4
1.3 Test method .....	4
1.4 Statement of compliance .....	4
1.5 Exclusions .....	4
1.6 Test report revision history .....	4
<b>Section 2. Summary of test results</b> .....	<b>5</b>
2.1 FCC Part 96 test results .....	5
<b>Section 3. Equipment under test (EUT) details</b> .....	<b>6</b>
3.1 Sample information .....	6
3.2 EUT information .....	6
3.3 Technical information .....	6
3.4 Product description and theory of operation .....	7
3.5 EUT exercise details .....	7
3.6 EUT setup diagram .....	8
3.7 EUT sub assemblies .....	8
<b>Section 4. Engineering considerations</b> .....	<b>9</b>
4.1 Modifications incorporated in the EUT .....	9
4.2 Technical judgment .....	9
4.3 Deviations from laboratory tests procedures .....	9
<b>Section 5. Test conditions</b> .....	<b>10</b>
5.1 Atmospheric conditions .....	10
5.2 Power supply range .....	10
<b>Section 6. Measurement uncertainty</b> .....	<b>11</b>
6.1 Uncertainty of measurement .....	11
<b>Section 7. Test equipment</b> .....	<b>12</b>
7.1 Test equipment list .....	12
<b>Section 8. Testing data</b> .....	<b>13</b>
8.1 FCC 96.41(b) Output power and PSD .....	13
8.2 FCC 96.41(g) The peak-to-average power ratio (PAPR) .....	16
8.3 FCC 96.41(e)(3) Emission bandwidth and occupied bandwidth .....	18
8.4 FCC 96.41(e)(1) 3.5 GHz emissions and interference limits .....	20
8.5 FCC 96.41(e)(2) Additional protection levels .....	25
8.6 FCC 2.1055 Frequency stability .....	34
<b>Section 9. Block diagrams of test set-ups</b> .....	<b>35</b>
9.1 Radiated emissions set-up for frequencies below 1 GHz .....	35
9.2 Radiated emissions set-up for frequencies above 1 GHz .....	35
9.3 Conducted emissions set-up .....	36

## Section 1. Report summary

---

### 1.1 Applicant and manufacturer

---

Company name	Siemens Canada Limited
Address	300 Applewood Crescent
City	Concord
Province/State	ON
Postal/Zip code	L4K 5C7
Country	Canada

### 1.2 Test specifications

---

FCC 47 CFR Part 96	Citizens Broadband Radio Service
--------------------	----------------------------------

### 1.3 Test method

---

ANSI C63.26-2015	American National Standard for Compliance Testing of Transmitters Used in Licensed Radio Services
940660 D01 Part 96 CBRS Eqpt v01	Certification and test procedures for citizens broadband radio service devices authorized under Part 96

### 1.4 Statement of compliance

---

In the configuration tested, the EUT was found compliant.

Testing was completed against all relevant requirements of the test standard. Results obtained indicate that the product under test complies in full with the requirements tested. The test results relate only to the items tested.

See "Summary of test results" for full details.

### 1.5 Exclusions

---

This test report covers only general requirements of Part 96. For SAS and functionality please refer to the WINNF test report.

### 1.6 Test report revision history

---

Revision #	Details of changes made to test report
TRF	Original report issued
R1TRF	Only Category B testing

## Section 2. Summary of test results

---

---

### 2.1 FCC Part 96 test results

---

Part	Test description	Verdict
\$96.41(e)(3)	Emission and occupied bandwidth	Pass
\$96.41(b)	Power limits	Pass
\$96.41(e)(1)	3.5 GHz Emissions and Interference Limits	Pass
\$96.41(e)(2)	Additional protection levels	Pass
\$96.41(g)	The peak-to-average power ratio (PAPR)	Pass
\$2.1055	Frequency stability	Pass

Notes: None

## Section 3. Equipment under test (EUT) details

### 3.1 Sample information

Receipt date	October 1, 2018
Nemko sample ID number	1

### 3.2 EUT information

Product name	CPE
Model	WIN5137
Model variants	WIN5137-AC, WIN5137-DC, WIN5237, WIN5137-AC-IS, WIN5237-IS, WIN5137-V, WIN5137-V-GPS
Serial numbers	63741018018 (WIN5157-5-AC); 93740717002 (WIN5137-V-GPS)
Revision number	REV:15 H/W:A7 (WIN5157-5-AC); REV:01 H/W:A6 (WIN5137-V-GPS)

### 3.3 Technical information

Frequency band	3550–3700 MHz
Frequency Min (MHz)	3552.5 (5 MHz channel); 3555 (10 MHz channel)
Frequency Max (MHz)	3697.5 (5 MHz channel); 3695 (10 MHz channel)
RF total power Max (W)	16.218 (5 MHz channel, Category B); 16.106 (10 MHz channel, Category B)
Maximum declared power per port	24 dBm ±1 dB
RF power density (W/MHz)	0.073 (5 MHz channel, Category B); 0.038 (10 MHz channel, Category B)
Field strength, Units @ distance	N/A
Measured BW (kHz) (99 %)	4519 (5 MHz channel); 9167 (10 MHz channel)
Measured BW (kHz) (26 dB)	5513 (5 MHz channel); 10353 (10 MHz channel)
Type of modulation	QPSK½ to 64QAM
Emission classification (F1D, G1D, D1D)	5M00W7D; 10M0W7D
Transmitter spurious, Units @ distance	55.06 dBµV/m at 1382.84 MHz @ 3 m
Power requirements	48 V <sub>DC</sub> via PoE powered from 120 V <sub>AC</sub> / 60 Hz
Antenna information	The EUT uses a unique antenna coupling/ non-detachable antenna to the intentional radiator.

Type	Manufacturer	Model	Gain
Dual Slant (for CPE)	Wireless Edge	ANTN0028_385002-ND	18 dBi
Dual Slant (for CPE)	Wireless Edge	ANTN0064_385002-ND	18 dBi
Vehicular Antenna	Wireless Edge	MT – 000552/NV	6 dBi
Light-rail rooftop antenna	Huber+Suhner	1399.17.0099	9.5 dBi

### 3.4 Product description and theory of operation

---

The WIN51XX/WIN52XX ODU CPE is an IEEE 802.16-2005 compliant wireless device for deployment of point-to-multipoint (PMP) and point-to-point (PTP) network architectures.

The WIN51XX/WIN52XX ODU CPE is an outdoor device. The WIN51XX/WIN52XX ODU CPE is WiMAX Forum 802.16e Wave 2 (MIMO) Certified subscribers. Each subscriber registers and establishes a bi-directional data link with the base station sector controller.

The base station is connected to the head-end over IP Backhaul or via wireless channels. The outdoor CPEs are connected to the base station over wireless channels. The outdoor CPE is connected to the indoor residential gateway over Ethernet or coaxial networks.

Frequency ranges: 3550–3700 MHz  
Output power (average): 24 dBm  $\pm$ 1 dB maximum  
Bandwidth: 5 MHz, 7 MHz, 10 MHz  
Antenna types:

- Dual slant subscriber panel: 18 dBi
- Omnidirectional: 6 dBi
- Rooftop: 9.5 dBi

Model variants:

WIN5237, WIN5137-AC, WIN5137-DC, WIN5137-AC-IS, WIN5237-IS, WIN5137-V, WIN5137-V-GPS

The CPE consists of the following modules:

- Base-Band board – including the WiMAX 16e MIMO Base-Band SoC (running the 16e MAC + PHY) plus the User Interface plus the analog front end that interface the RF module.
- Power Supply board– DC/DC power supply. Converts the 48VDC to the various voltages that are feeding the Digital and the RF modules
- RF board - Single transmit dual receive module that modulate the analog WiMAX signal input from the Base-Band modem to the high frequency RF output. The power amplifier has a step gain control, down to 20 dB of nominal gain.
- Audio filter (WIN5137-DC Unit only)
- Chassis

The WIN51XX/WIN52XX CPE uses time division duplexing (TDD) to transmit and receive on the same RF channel. This is a non-contention based method for providing an efficient and predictable two-way PTP or PMP cell deployment. All uplink and downlink transmission scheduling is managed by the base station.

The WIN51XX/WIN52XX CPE implements advanced automatic transmit power control, which allows the unit to operate with the minimum power necessary for successful communications. This control is based on information transmitted by the base-station and RSSI of the base-station.

The modulation technique specifies how the data is coded within the OFDMA carriers. The base station supports QPSK, 16 QAM, and 64 QAM modulations.

### 3.5 EUT exercise details

---

EUT was controlled via PuttY interface from the computer.

### 3.6 EUT setup diagram

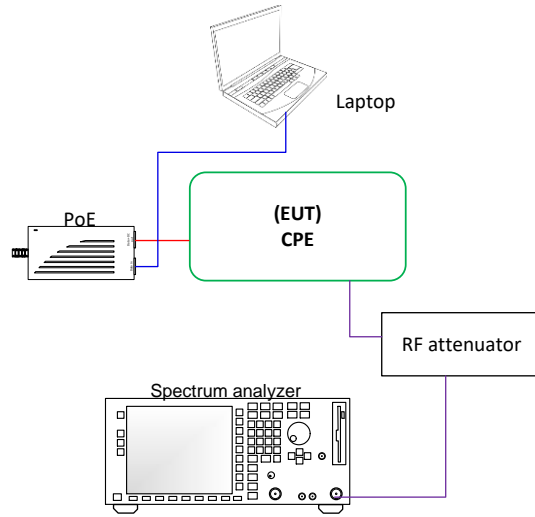


Figure 3.6-1: Setup diagram

### 3.7 EUT sub assemblies

Table 3.7-1: EUT sub assemblies

Description	Brand name	Model/Part number	Serial number
PoE	N/A	0334B5555 Black	L21450039379
Laptop	Dell	Latitude E6430	Nemko FA002851



## Section 4. Engineering considerations

---

---

### 4.1 Modifications incorporated in the EUT

---

There were no modifications performed to the EUT during this assessment.

### 4.2 Technical judgment

---

None

### 4.3 Deviations from laboratory tests procedures

---

No deviations were made from laboratory procedures.

## Section 5. Test conditions

---

---

### 5.1 Atmospheric conditions

---

Temperature	15–30 °C
Relative humidity	20–75 %
Air pressure	860–1060 mbar

---

When it is impracticable to carry out tests under these conditions, a note to this effect stating the ambient temperature and relative humidity during the tests shall be recorded and stated.

### 5.2 Power supply range

---

---

The normal test voltage for equipment to be connected to the mains shall be the nominal mains voltage. For the purpose of the present document, the nominal voltage shall be the declared voltage, or any of the declared voltages  $\pm 5\%$ , for which the equipment was designed.

## Section 6. Measurement uncertainty

---

### 6.1 Uncertainty of measurement

---

Measurement uncertainty budgets for the tests are detailed below. Measurement uncertainty calculations assume a coverage factor of  $K = 2$  with 95% certainty.

Test name	Measurement uncertainty, dB
All antenna port measurements	0.55
Conducted spurious emissions	1.13
Radiated spurious emissions	3.78

## Section 7. Test equipment

### 7.1 Test equipment list

*Table 7.1-1: Equipment list*

Equipment	Manufacturer	Model no.	Asset no.	Cal cycle	Next cal.
3 m EMI test chamber	TDK	SAC-3	FA002047	1 year	Dec. 9/18
Flush mount turntable	Sunol	FM2022	FA002082	—	NCR
Controller	Sunol	SC104V	FA002060	—	NCR
Antenna mast	Sunol	TLT2	FA002061	—	NCR
Receiver/spectrum analyzer	Rohde & Schwarz	ESU 26	FA002043	1 year	March 26/19
Spectrum analyzer	Rohde & Schwarz	FSU	FA001877	1 year	Oct 26/18
Preamp (1–18 GHz)	ETS-Lindgren	124334	FA002877	1 year	Nov. 14/18
Bilog antenna (20–3000 MHz)	Sunol	JB3	FA002108	1 year	Oct. 1/19
Horn antenna (1–18 GHz)	EMCO	3115	FA000649	1 year	Oct. 27/18
Horn antenna (18–26.5 GHz)	Electro-metrics	SH-50/60-1	FA000479	—	VOU
Horn antenna (26.5–40 GHz)	Electro-metrics	SH-50/60-2	FA000485	—	VOU
Pre-amplifier (18–26 GHz)	Narda	BBS-1826N612	FA001550	—	VOU
Pre-amplifier (26–40 GHz)	Narda	DBL-2640N610	FA001556	—	VOU
Temperature chamber	Espec	EPX-4H	FA002735	1 year	Sept. 12/19
Power meter	Agilent	N1911A	FA001946	1 year	Oct 11, 2019
Power sensor	Agilent	N1922A	FA001947	1 year	Aug 8, 2018

Note: NCR - no calibration required, VOU - verify on use

## Section 8. Testing data

### 8.1 FCC 96.41(b) Output power and PSD

#### 8.1.1 Definitions and limits

Unless otherwise specified in this section, the maximum effective isotropic radiated power (EIRP) and maximum Power Spectral Density (PSD) of any CBSD and End User Device must comply with the limits shown in the following table:

**Table 8.1-1: Output power and PSD limits**

Device	Maximum EIRP, dBm/10 MHz	Maximum PSD, dBm/MHz
End User Device	23	N/A
Category A CBSD	30	20
Category B CBSD	47	37

#### 8.1.2 Test summary

Test date October 3, 2018

#### 8.1.3 Observations, settings and special notes

**Based on the maximum RF power listed in this report, considerations pertaining to the maximum allowed EIRP and antenna type should be considered for each installation. As per manufacturer declaration: EUT doesn't transmit more than one channel bandwidth simultaneously.**

The test was performed using RMS detector of the spectrum analyzer with RBW of 1 MHz and VBW of 10 MHz and 10 MHz RBW and 30 MHz VBW. Total transmission power measurement results (in dBm units), provided below in the first 4 tables, are for the information purposes only. These values don't have limit in the section §96.41, since all the limits in the standard are expressed in dBm/10 MHz or dBm/MHz units. The measurement was performed using RMS power meter.

#### 8.1.4 Test data

**Table 8.1-2: Maximum total transmission power and EIRP for 5 MHz channel operation of CBRS Category B**

Frequency, MHz	Total Tx power, dBm	Antenna gain, dBi	EIRP, dBm
3552.5	24.10	18.00	42.10
3625.0	24.52	18.00	42.52
3697.5	23.90	18.00	41.90

**Table 8.1-3: Maximum total transmission power and EIRP for 10 MHz channel operation of CBRS Category B**

Frequency, MHz	Total Tx power, dBm	Antenna gain, dBi	EIRP, dBm
3555.0	24.17	18.00	42.17
3625.0	24.23	18.00	42.23
3695.0	24.40	18.00	42.40

**Table 8.1-4: EIRP measurement result for 5 MHz channel CBRS Category B**

Frequency, MHz	Modulation	Output power, dBm/10 MHz	Antenna gain, dBi	EIRP, dBm/10 MHz	EIRP limit, dBm/10 MHz	Margin, dB
3552.5	QPSK½	24.10	18.00	<b>42.10</b>	47.00	4.90
3625.0	QPSK½	23.74	18.00	41.74	47.00	5.26
3697.5	QPSK½	23.43	18.00	41.43	47.00	5.57
3552.5	64QAM	24.06	18.00	42.06	47.00	4.94
3625.0	64QAM	23.68	18.00	41.68	47.00	5.32
3697.5	64QAM	23.87	18.00	41.87	47.00	5.13

Note: Maximum power settings used for all antenna gains: 6 dBi, 9.5 dBi and 18 dBi.

**Table 8.1-5: EIRP measurement result for 10 MHz channel CBRS Category B**

Frequency, MHz	Modulation	Output power, dBm/10 MHz	Antenna gain, dBi	EIRP, dBm/10 MHz	EIRP limit, dBm/10 MHz	Margin, dB
3552.5	QPSK½	23.97	18.00	41.97	47.00	5.03
3625.0	QPSK½	23.41	18.00	41.41	47.00	5.59
3697.5	QPSK½	24.07	18.00	<b>42.07</b>	47.00	4.93
3552.5	64QAM	24.02	18.00	42.02	47.00	4.98
3625.0	64QAM	23.42	18.00	41.42	47.00	5.58
3697.5	64QAM	23.27	18.00	41.27	47.00	5.73

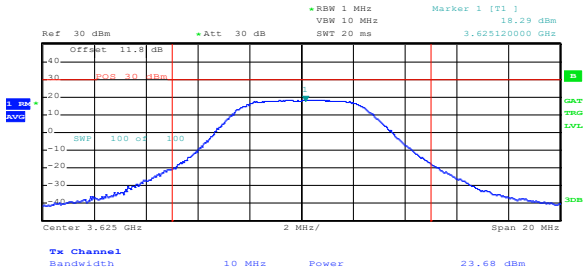
Note: Maximum power settings used for all antenna gains: 6 dBi, 9.5 dBi and 18 dBi.

**Table 8.1-6: PSD measurement result for 5 MHz channel CBRS Category B**

Frequency, MHz	Modulation	PSD, dBm/MHz	PSD Limit, dBm/MHz	Margin, dB
3552.5	QPSK½	18.61	37.00	18.39
3625.0	QPSK½	18.24	37.00	18.76
3697.5	QPSK½	17.97	37.00	19.03
3552.5	64QAM	<b>18.64</b>	37.00	18.36
3625.0	64QAM	18.29	37.00	18.71
3697.5	64QAM	18.45	37.00	18.55

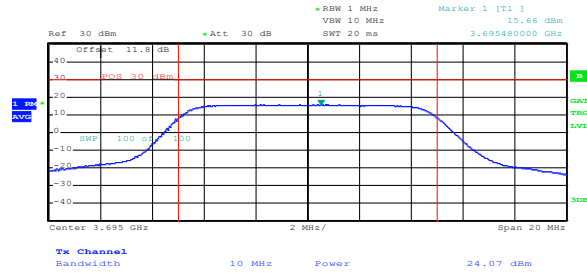
**Table 8.1-7: PSD measurement result for 10 MHz channel CBRS Category B**

Frequency, MHz	Modulation	PSD, dBm/MHz	PSD Limit, dBm/MHz	Margin, dB
3555.0	QPSK½	15.51	37.00	21.49
3625.0	QPSK½	15.00	37.00	22.00
3695.0	QPSK½	15.66	37.00	21.34
3555.0	64QAM	<b>15.81</b>	37.00	21.19
3625.0	64QAM	15.24	37.00	21.76
3695.0	64QAM	14.95	37.00	22.05



Date: 3.OCT.2018 16:30:51

Figure 8.1-1: Total power and power spectral density sample plot, 5 MHz channel



Date: 3.OCT.2018 15:49:55

Figure 8.1-2: Total power and power spectral density sample plot, 10 MHz channel

## 8.2 FCC 96.41(g) The peak-to-average power ratio (PAPR)

### 8.2.1 Definitions and limits

The peak-to-average power ratio (PAPR) of any CBSD transmitter output power must not exceed 13 dB. PAPR measurements should be made using either an instrument with complementary cumulative distribution function (CCDF) capabilities or another Commission approved procedure. The measurement must be performed using a signal corresponding to the highest PAPR expected during periods of continuous transmission.

### 8.2.2 Test summary

Test date October 12, 2018

### 8.2.3 Observations, settings and special notes

The test was performed using spectrum analyzer signal statistics' Complimentary Cumulative Distribution Function

### 8.2.4 Test data

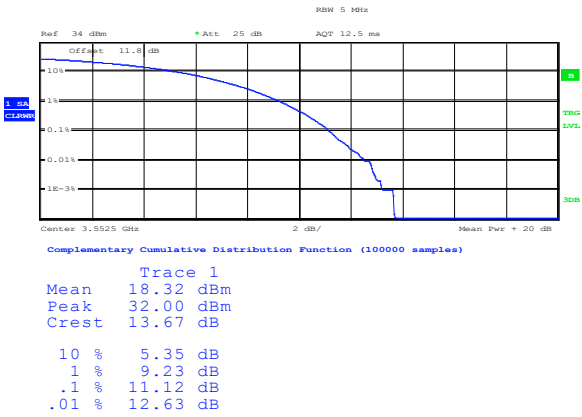
**Table 8.2-1: PAPR measurement results**

Channel BW, MHz	Modulation	Frequency, MHz	CCDF at 0.1%, dB	Limit, dB	Margin, dB
5	QPSK½	3552.5	11.12	13.00	1.88
5	QPSK½	3625.0	11.25	13.00	1.75
5	QPSK½	3697.5	11.06	13.00	1.94
5	64QAM	3552.5	11.06	13.00	1.94
5	64QAM	3625.0	11.09	13.00	1.91
5	64QAM	3697.5	11.12	13.00	1.88
10	QPSK½	3555.0	10.64	13.00	2.36
10	QPSK½	3625.0	10.90	13.00	2.10
10	QPSK½	3695.0	10.38	13.00	2.62
10	64QAM	3555.0	10.64	13.00	2.36
10	64QAM	3625.0	10.80	13.00	2.20
10	64QAM	3695.0	10.38	13.00	2.62



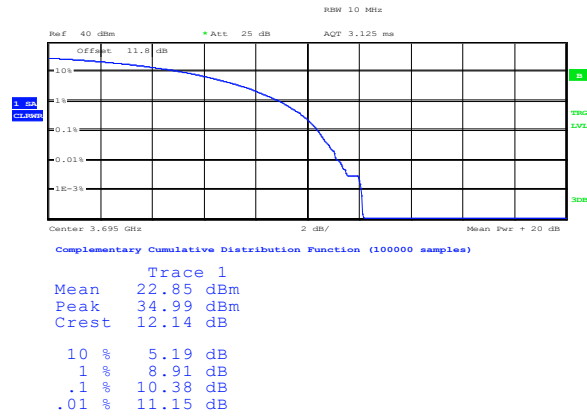
**Section 8**  
**Test name**  
**Specification**

Testing data  
 FCC 96.41(g) The peak-to-average power ratio (PAPR)  
 FCC Part 96



Date: 12.OCT.2018 10:40:07

**Figure 8.2-1:** CCDF sample plot, 5 MHz channel



Date: 12.OCT.2018 11:07:00

**Figure 8.2-2:** CCDF sample plot, 10 MHz channel

## 8.3 FCC 96.41(e)(3) Emission bandwidth and occupied bandwidth

### 8.3.1 Definitions and limits

The emission bandwidth is defined as the width of the signal between two points, one below the carrier center frequency and one above the carrier center frequency, outside of which all emissions are attenuated at least 26 dB below the transmitter power.

FCC 2.1049 The occupied bandwidth, that is the frequency bandwidth such that, below its lower and above its upper frequency limits, the mean powers radiated are each equal to 0.5 percent of the total mean power radiated by a given emission.

### 8.3.2 Test summary

Test date October 11, 2018

### 8.3.3 Observations, settings and special notes

Spectrum analyser settings for OBW measurements:

Resolution bandwidth	100 kHz
Video bandwidth	300 kHz
Detector mode	Peak
Trace mode	Max Hold

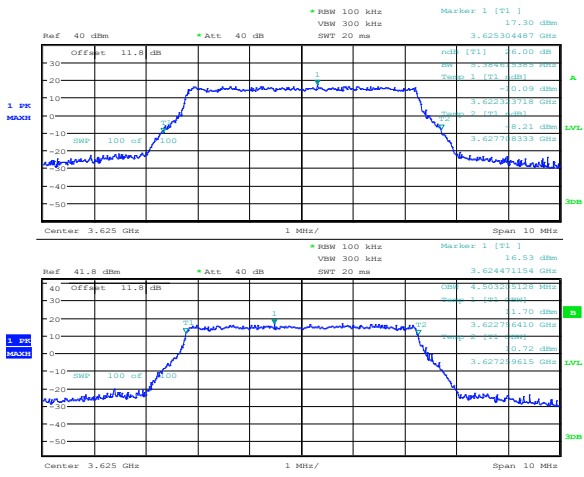
### 8.3.4 Test data

**Table 8.3-1: Occupied bandwidth measurement results for 5 MHz channel**

Frequency, MHz	Modulation	99% OBW, MHz	26 dB BW, MHz
3552.5	QPSK½	4.519	5.513
3625.0	QPSK½	4.519	5.481
3697.5	QPSK½	4.519	5.497
3552.5	64QAM	4.519	5.337
3625.0	64QAM	4.503	5.385
3697.5	64QAM	4.503	5.321

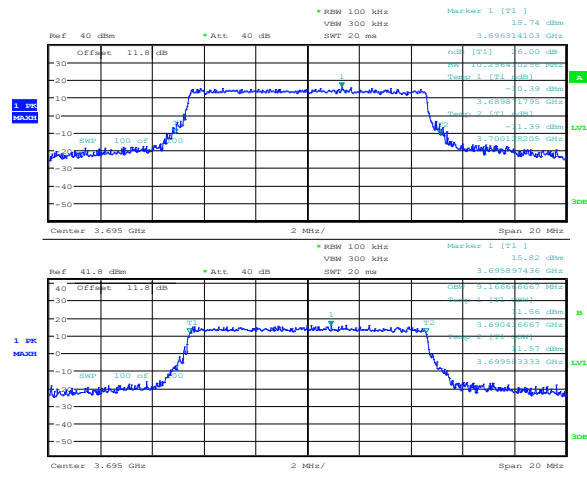
**Table 8.3-2: Occupied bandwidth measurement results for 10 MHz channel**

Frequency, MHz	Modulation	99% OBW, MHz	26 dB BW, MHz
3555.0	QPSK½	9.167	10.224
3625.0	QPSK½	9.135	10.353
3695.0	QPSK½	9.167	10.256
3555.0	64QAM	9.103	10.224
3625.0	64QAM	9.135	10.321
3695.0	64QAM	9.135	10.256



Date: 11.OCT.2018 11:16:31

Figure 8.3-1: Occupied bandwidth sample plot for 5 MHz channel



Date: 12.OCT.2018 10:00:54

Figure 8.3-2: Occupied bandwidth sample plot for 10 MHz channel

## 8.4 FCC 96.41(e)(1) 3.5 GHz emissions and interference limits

---

### 8.4.1 Definitions and limits

---

General protection levels. Except as otherwise specified in paragraph (e)(2) of this section, for channel and frequency assignments made by the SAS to CBSDs, the conducted power of any emission outside the fundamental emission (whether in or outside of the authorized band) shall not exceed -13 dBm/MHz within 0–10 MHz above the upper SAS-assigned channel edge and within 0–10 MHz below the lower SAS-assigned channel edge. At all frequencies greater than 10 MHz above the upper SAS assigned channel edge and less than 10 MHz below the lower SAS assigned channel edge, the conducted power of any emission shall not exceed -25 dBm/MHz. The upper and lower SAS assigned channel edges are the upper and lower limits of any channel assigned to a CBSD by an SAS, or in the case of multiple contiguous channels, the upper and lower limits of the combined contiguous channels.

(3) Measurement procedure. (i) Compliance with this provision is based on the use of measurement instrumentation employing a resolution bandwidth of 1 MHz or greater. However, in the 1 MHz bands immediately outside and adjacent to the licensee's authorized frequency channel, a resolution bandwidth of no less than one percent of the fundamental emission bandwidth may be employed. A narrower resolution bandwidth is permitted in all cases to improve measurement accuracy provided the measured power is integrated over the full reference bandwidth (i.e., 1 MHz or 1 percent of emission bandwidth, as specified). The emission bandwidth is defined as the width of the signal between two points, one below the carrier center frequency and one above the carrier center frequency, outside of which all emissions are attenuated at least 26 dB below the transmitter power.

### 8.4.2 Test summary

---

Test date October 3, 2018

### 8.4.3 Observations, settings and special notes

---

This test was performed at the antenna port and radiated with antenna port terminated with 50 Ohm load. Only the worst emissions (conducted) results are shown in the test data below. Spectrum analyser settings for measurements within 1 MHz from the SAS assigned channel edges:

Resolution bandwidth	30 kHz
Video bandwidth	300 kHz
Detector mode	RMS
Trace mode	Power averaging
Power integration	Over 50 kHz for 5 MHz channel; Over 100 kHz for 10 MHz channel

Spectrum analyser settings for measurements outside 1 MHz from the SAS assigned channel edges:

Resolution bandwidth	1 MHz
Video bandwidth	3 MHz
Detector mode	RMS
Trace mode	Power averaging

8.4.4 Test data

**Table 8.4-1: Emission mask measurements for 5 MHz channel with QPSK½ modulation**

Channel	Offset from the SAS assigned channel edges, MHz	Frequency of max emission, MHz	Emission level, dBm	Limit, dBm	Margin, dB
Low	0-1	3550.0	-22.44	-13.00	9.44
Low	0-1	3555.0	-22.67	-13.00	9.67
Low	1-10	3549.0	-18.46	-13.00	5.46
Low	1-10	3556.0	-19.10	-13.00	6.10
Low	>10	3540.0	-40.10	-25.00	15.10
Low	>10	3565.0	-40.03	-25.00	15.03
Mid	0-1	3622.5	-22.64	-13.00	9.64
Mid	0-1	3627.5	-23.05	-13.00	10.05
Mid	1-10	3621.5	-20.07	-13.00	7.07
Mid	1-10	3628.5	-20.90	-13.00	7.90
Mid	>10	3612.5	-40.29	-25.00	15.29
Mid	>10	3637.5	-39.88	-25.00	14.88
High	0-1	3695.0	-22.25	-13.00	9.25
High	0-1	3700.0	-23.06	-13.00	10.06
High	1-10	3694.0	-18.39	-13.00	5.39
High	1-10	3701.0	-19.37	-13.00	6.37
High	>10	3685.0	-39.90	-25.00	14.90
High	>10	3710.0	-40.32	-25.00	15.32

**Table 8.4-2: Emission mask measurements for 5 MHz channel with 64QAM modulation**

Channel	Offset from the SAS assigned channel edges, MHz	Frequency of max emission, MHz	Emission level, dBm	Limit, dBm	Margin, dB
Low	0-1	3550.0	-22.51	-13.00	9.51
Low	0-1	3555.0	-22.56	-13.00	9.56
Low	1-10	3549.0	-18.56	-13.00	5.56
Low	1-10	3556.0	-18.99	-13.00	5.99
Low	>10	3540.0	-40.20	-25.00	15.20
Low	>10	3565.0	-39.92	-25.00	14.92
Mid	0-1	3622.5	-23.42	-13.00	10.42
Mid	0-1	3627.5	-22.99	-13.00	9.99
Mid	1-10	3621.5	-19.74	-13.00	6.74
Mid	1-10	3628.5	-20.87	-13.00	7.87
Mid	>10	3612.5	-40.26	-25.00	15.26
Mid	>10	3637.5	-39.89	-25.00	14.89
High	0-1	3695.0	-22.25	-13.00	9.25
High	0-1	3700.0	-23.06	-13.00	10.06
High	1-10	3694.0	-18.39	-13.00	5.39
High	1-10	3701.0	-19.37	-13.00	6.37
High	>10	3685.0	-39.90	-25.00	14.90
High	>10	3710.0	-40.32	-25.00	15.32

**Table 8.4-3:** Emission mask measurements for 10 MHz channel with QPSK½ modulation

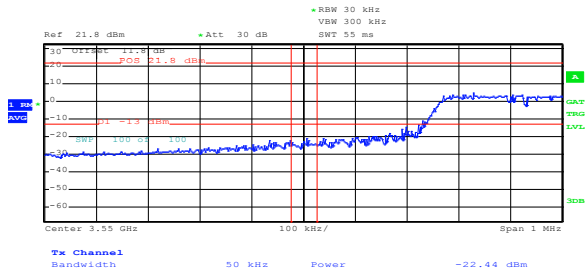
Channel	Offset from the SAS assigned channel edges, MHz	Frequency of max emission, MHz	Emission level, dBm	Limit, dBm	Margin, dB
Low	0-1	3550.0	-17.32	-13.00	4.32
Low	0-1	3560.0	-17.48	-13.00	4.48
Low	1-10	3549.0	-14.31	-13.00	1.31
Low	1-10	3561.0	-15.13	-13.00	2.13
Low	>10	3540.0	-28.64	-25.00	3.64
Low	>10	3570.0	-29.68	-25.00	4.68
Mid	0-1	3620.0	-22.16	-13.00	9.16
Mid	0-1	3630.0	-21.66	-13.00	8.66
Mid	1-10	3619.0	-21.10	-13.00	8.10
Mid	1-10	3631.0	-22.62	-13.00	9.62
Mid	>10	3610.0	-40.27	-25.00	15.27
Mid	>10	3640.0	-38.54	-25.00	13.54
High	0-1	3690.0	-20.84	-13.00	7.84
High	0-1	3700.0	-19.32	-13.00	6.32
High	1-10	3689.0	-17.15	-13.00	4.15
High	1-10	3701.0	-18.23	-13.00	5.23
High	>10	3680.0	-33.85	-25.00	8.85
High	>10	3710.0	-34.66	-25.00	9.66

**Table 8.4-4:** Emission mask measurements for 10 MHz channel with 64QAM modulation

Channel	Offset from the SAS assigned channel edges, MHz	Frequency of max emission, MHz	Emission level, dBm	Limit, dBm	Margin, dB
Low	0-1	3550.0	-21.01	-13.00	8.01
Low	0-1	3560.0	-21.63	-13.00	8.63
Low	1-10	3549.0	-19.35	-13.00	6.35
Low	1-10	3561.0	-20.62	-13.00	7.62
Low	>10	3540.0	-39.19	-25.00	14.19
Low	>10	3570.0	-38.48	-25.00	13.48
Mid	0-1	3620.0	-23.28	-13.00	10.28
Mid	0-1	3630.0	-24.38	-13.00	11.38
Mid	1-10	3619.0	-21.11	-13.00	8.11
Mid	1-10	3631.0	-22.80	-13.00	9.80
Mid	>10	3610.0	-29.68	-25.00	4.68
Mid	>10	3640.0	-40.81	-25.00	15.81
High	0-1	3690.0	-21.48	-13.00	8.48
High	0-1	3700.0	-20.33	-13.00	7.33
High	1-10	3689.0	-19.78	-13.00	6.78
High	1-10	3701.0	-21.27	-13.00	8.27
High	>10	3680.0	-38.53	-25.00	13.53
High	>10	3710.0	-38.49	-25.00	13.49

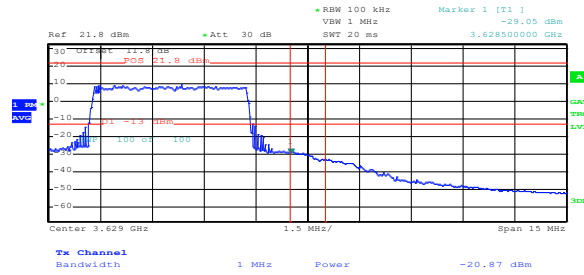
**Section 8**  
**Test name**  
**Specification**

Testing data  
 FCC 96.41(e)(1) 3.5 GHz emissions and interference limits  
 FCC Part 96, FCC Part 2.1051 and FCC Part 2.1053



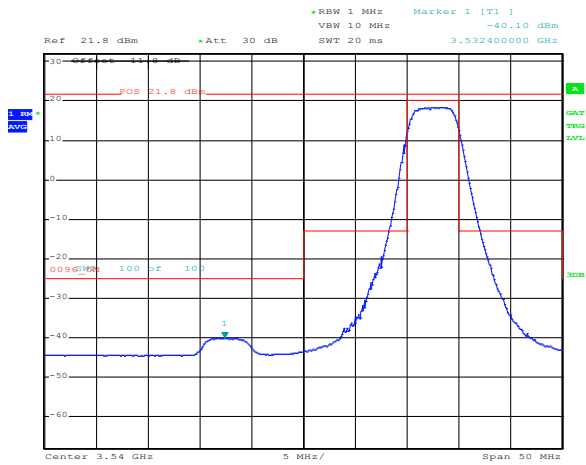
Date: 3.OCT.2018 16:16:25

**Figure 8.4-1:** Emission measurement within 0–1 MHz from the SAS assigned channel edge, sample plot for 5 MHz channel



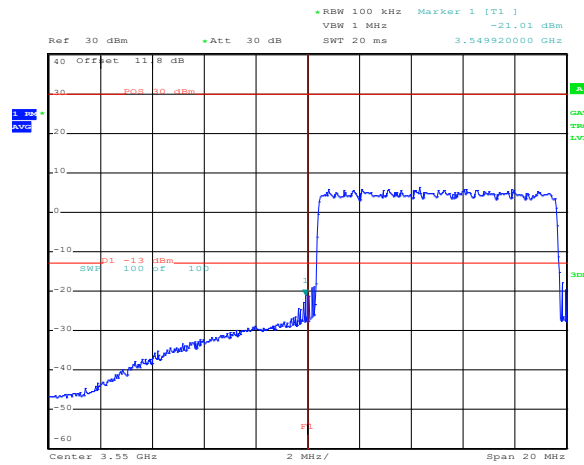
Date: 3.OCT.2018 16:33:19

**Figure 8.4-2:** Emission measurement within 1–10 MHz from the SAS assigned channel edge, sample plot for 5 MHz channel



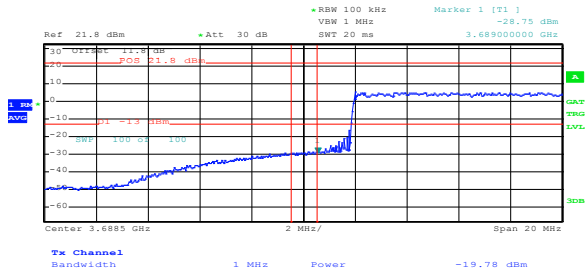
Date: 3.OCT.2018 16:20:54

**Figure 8.4-3:** Emission measurement more than 10 MHz from the SAS assigned channel edge, sample plot for 5 MHz channel



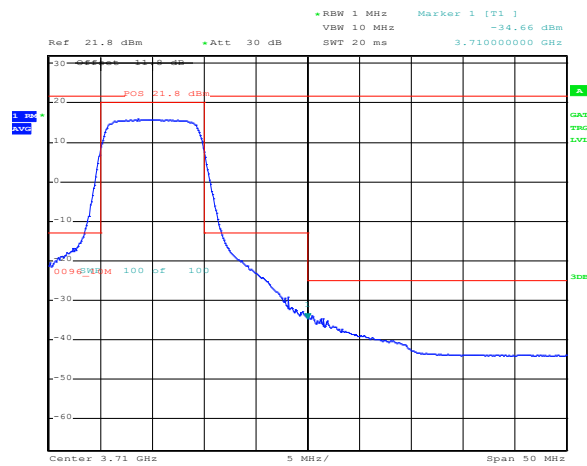
Date: 3.OCT.2018 15:22:41

**Figure 8.4-4:** Emission measurement within 0–1 MHz from the SAS assigned channel edge, sample plot for 10 MHz channel



Date: 3.OCT.2018 16:02:56

**Figure 8.4-5:** Emission measurement within 1–10 MHz from the SAS assigned channel edge, sample plot for 10 MHz channel



Date: 3.OCT.2018 15:54:51

**Figure 8.4-6:** Emission measurement more than 10 MHz from the SAS assigned channel edge, sample plot for 10 MHz channel



## 8.5 FCC 96.41(e)(2) Additional protection levels

### 8.5.1 Definitions and limits

The conducted power of any emissions below 3530 MHz or above 3720 MHz shall not exceed -40dBm/MHz.

### 8.5.2 Test summary

Test date October 9, 2018

### 8.5.3 Observations, settings and special notes

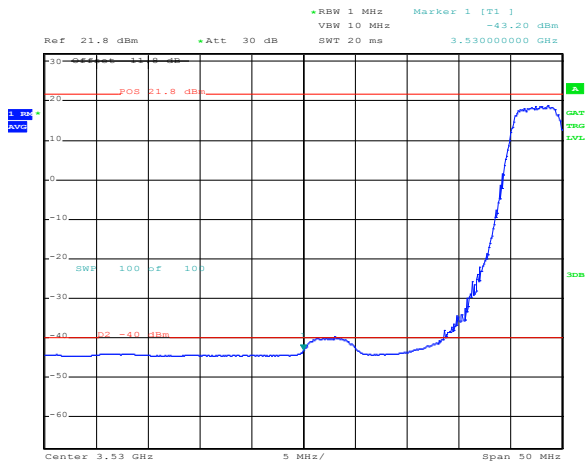
The testing was performed conducted as well as radiated with antenna port terminated with 50 Ohm load. Spurious emissions were tested from 30 MHz to the 10<sup>th</sup> harmonic. Only critical plots provided in test data below. Spectrum analyser settings:

Resolution bandwidth	100 kHz (radiated below 1 GHz) and 1 MHz (radiated above 1 GHz); 1 MHz (conducted)
Video bandwidth	3 × RBW
Detector and trace mode	RMS Power averaging (conducted), Peak Max-hold (radiated)

### 8.5.4 Test data

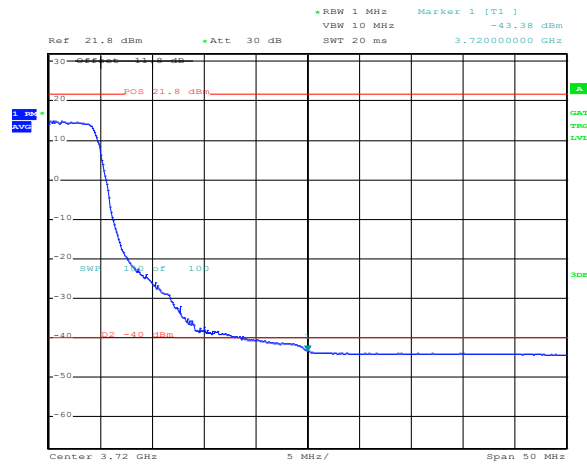
**Table 8.5-1: Additional emission measurements at 3530 and 3720 MHz**

Channel BW, MHz	Modulation	Frequency of max emission, MHz	Emission level, dBm/MHz	Limit, dBm/MHz	Margin, dB
5	QPSK½	3530	-42.82	-40.00	2.82
5	QPSK½	3720	-42.70	-40.00	2.70
5	64QAM	3530	-43.20	-40.00	3.20
5	64QAM	3720	-42.59	-40.00	2.59
10	QPSK½	3530	-41.51	-40.00	1.51
10	QPSK½	3720	-42.93	-40.00	2.93
10	64QAM	3530	-42.77	-40.00	2.77
10	64QAM	3720	-43.38	-40.00	3.38



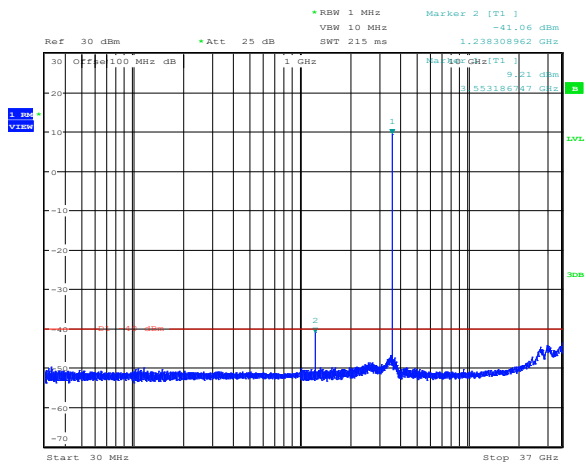
Date: 3.OCT.2018 16:23:40

Figure 8.5-1: Emission measurement at 3530 MHz sample plot



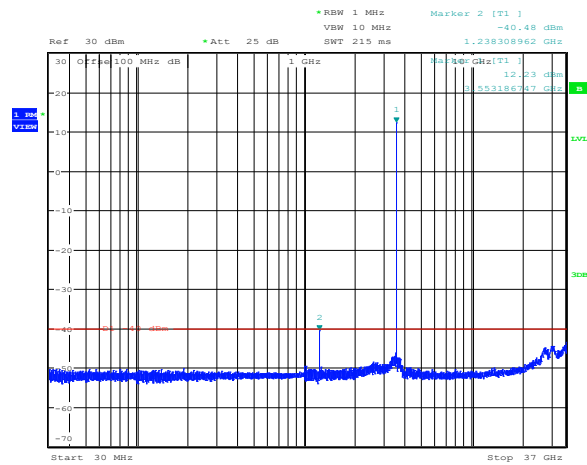
Date: 3.OCT.2018 15:58:13

Figure 8.5-2: Emission measurement at 3720 MHz sample plot



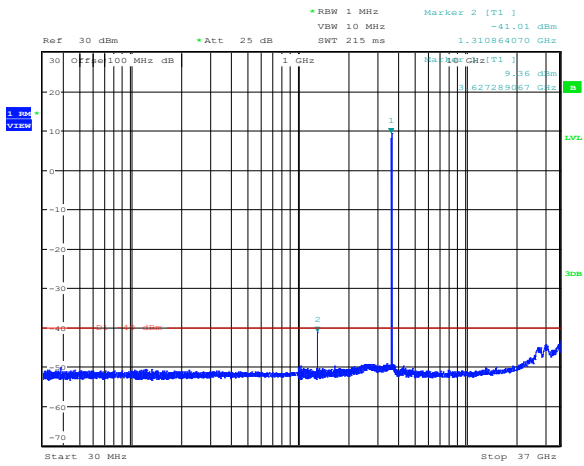
Date: 12.OCT.2018 10:24:13

Figure 8.5-3: Conducted spurious emissions with QPSK modulation on 5 MHz low channel



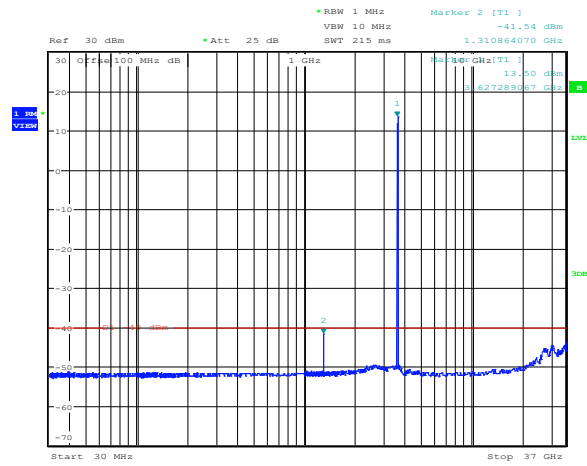
Date: 12.OCT.2018 10:25:56

Figure 8.5-4: Conducted spurious emissions with 64QAM modulation on 5 MHz low channel



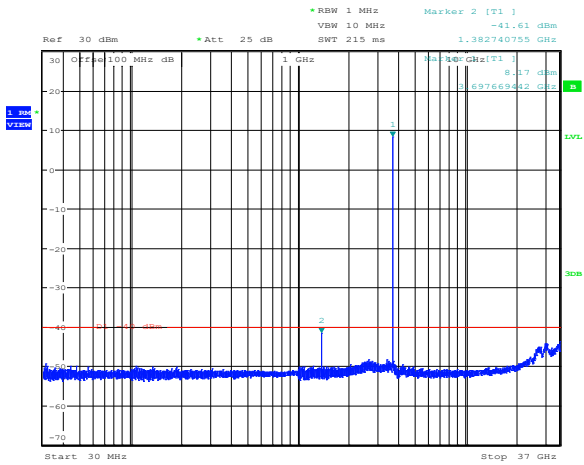
Date: 12.OCT.2018 10:28:14

**Figure 8.5-5:** Conducted spurious emissions with QPSK½ modulation on 5 MHz mid channel



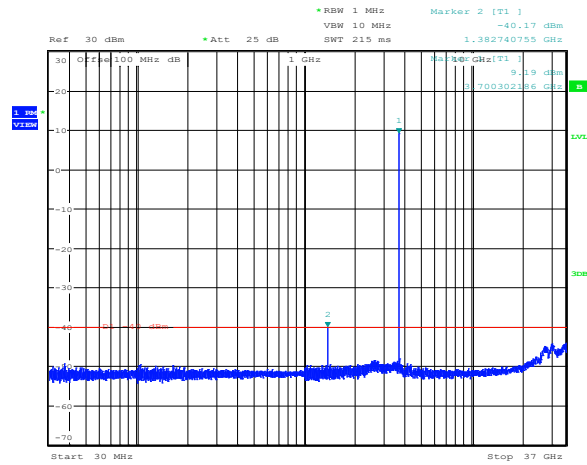
Date: 12.OCT.2018 10:27:30

**Figure 8.5-6:** Conducted spurious emissions with 64QAM modulation on 5 MHz mid channel



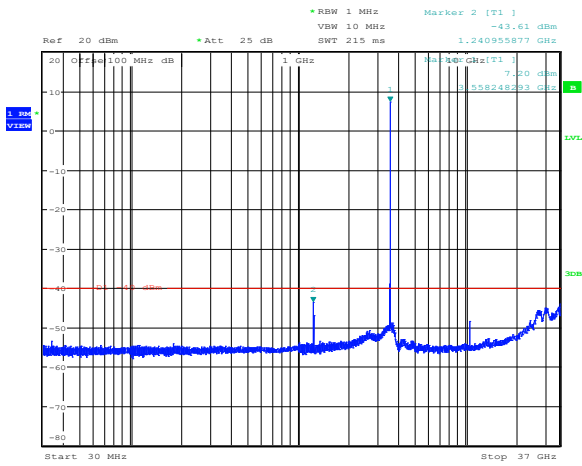
Date: 12.OCT.2018 10:29:04

**Figure 8.5-7:** Conducted spurious emissions with QPSK½ modulation on 5 MHz high channel



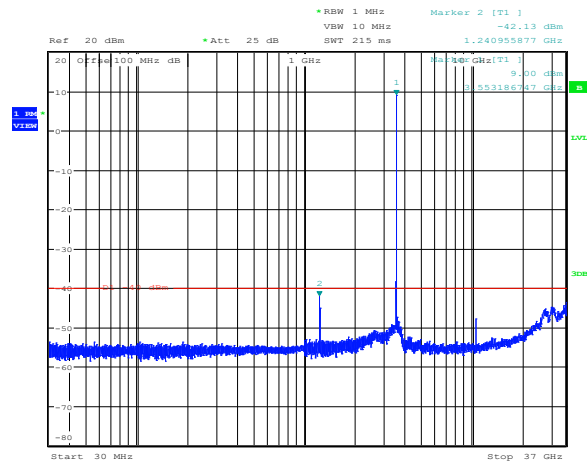
Date: 12.OCT.2018 10:29:49

**Figure 8.5-8:** Conducted spurious emissions for Antenna 1 with 64QAM modulation on 5 MHz high channel



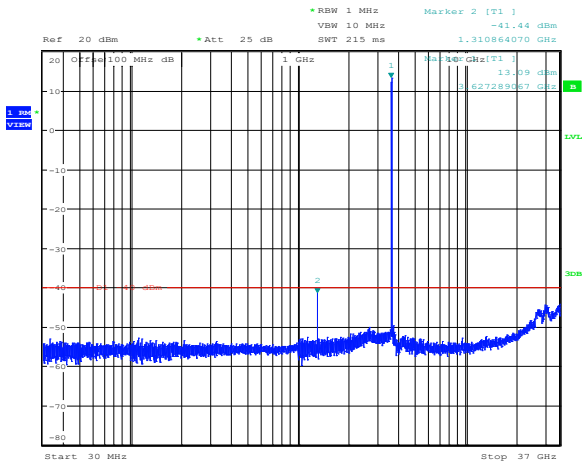
Date: 12.OCT.2018 10:12:40

**Figure 8.5-9:** Conducted spurious emissions with QPSK½ modulation on 10 MHz low channel



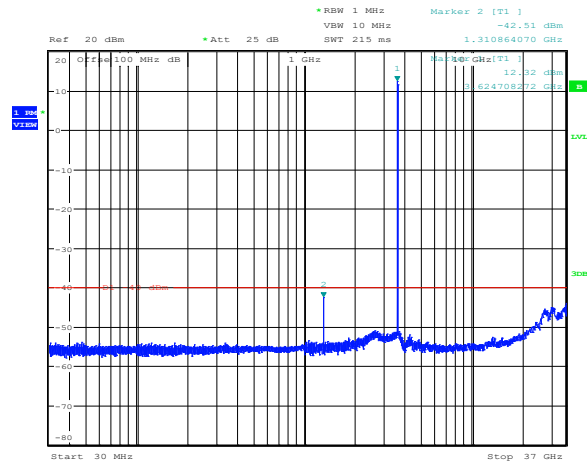
Date: 12.OCT.2018 10:13:23

**Figure 8.5-10:** Conducted spurious emissions with 64QAM modulation on 10 MHz low channel



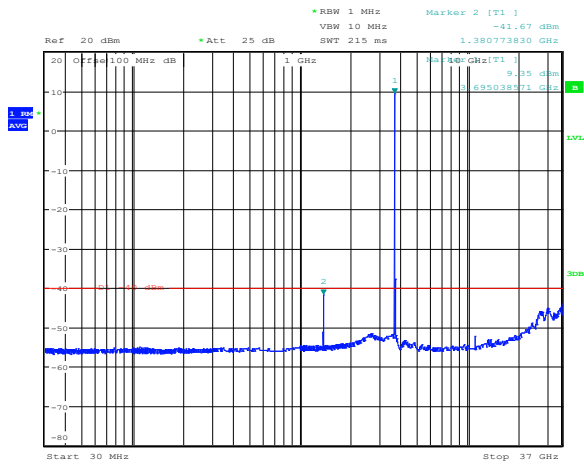
Date: 12.OCT.2018 10:11:12

**Figure 8.5-11:** Conducted spurious emissions for Antenna 1 with QPSK½ modulation on 10 MHz mid channel



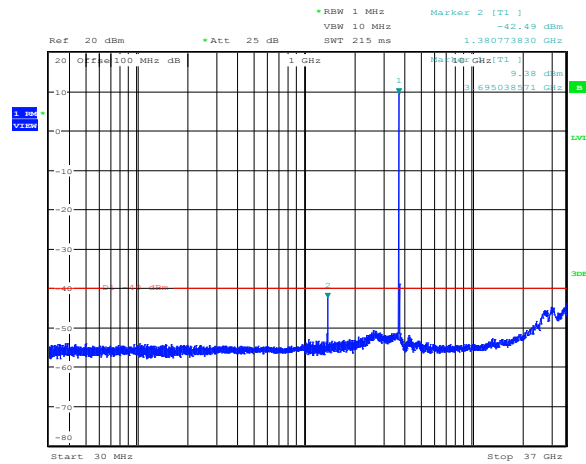
Date: 12.OCT.2018 10:10:10

**Figure 8.5-12:** Conducted spurious emissions with 64QAM modulation on 10 MHz mid channel



Date: 12.OCT.2018 10:08:41

**Figure 8.5-13:** Conducted spurious emissions with QPSK½ modulation on 10 MHz high channel

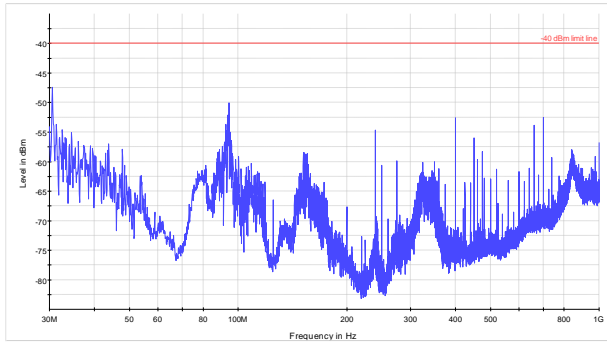


Date: 12.OCT.2018 10:09:16

**Figure 8.5-14:** Conducted spurious emissions with 64QAM modulation on 10 MHz high channel

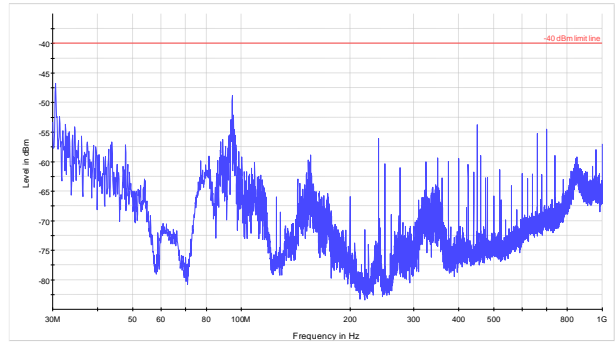
**Table 8.5-2:** Conducted spurious emission measurement results

Channel BW, MHz	Channel	Modulation	Frequency of max emission, MHz	Emission level, dBm/MHz	Limit, dBm/MHz	Margin, dB
5	Low	QPSK½	1238.31	-41.06	-40.00	1.06
5	Mid	QPSK½	1310.86	-41.01	-40.00	1.01
5	High	QPSK½	1382.74	-41.61	-40.00	1.61
5	Low	64QAM	1238.31	-40.48	-40.00	0.48
5	Mid	64QAM	1310.84	-41.54	-40.00	1.54
5	High	64QAM	1382.84	-40.17	-40.00	0.17
10	Low	QPSK½	1240.95	-43.61	-40.00	3.61
10	Mid	QPSK½	1310.86	-41.44	-40.00	1.44
10	High	QPSK½	1380.77	-41.67	-40.00	1.67
10	Low	64QAM	1240.95	-42.13	-40.00	2.13
10	Mid	64QAM	1310.86	-42.51	-40.00	2.51
10	High	64QAM	1380.77	-42.49	-40.00	2.49



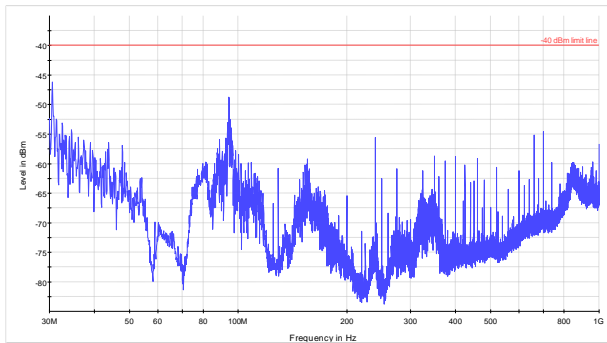
Radiated emissions  
 PK<sub>MAXH</sub>  
 -40 dBm limit line

**Figure 8.5-15:** Cabinet spurious emissions below 1 GHz 5 MHz low channel, WIN5157-5-AC



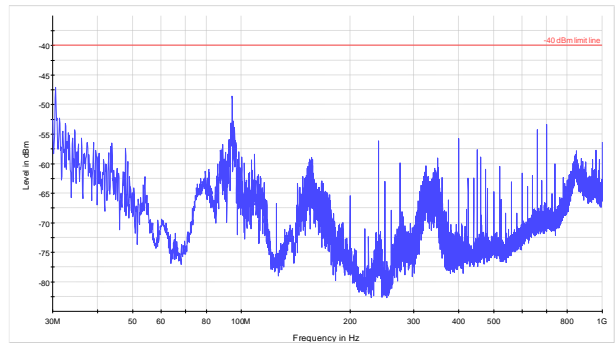
Radiated emissions  
 PK<sub>MAXH</sub>  
 -40 dBm limit line

**Figure 8.5-16:** Cabinet spurious emissions below 1 GHz 5 MHz mid channel, WIN5157-5-AC



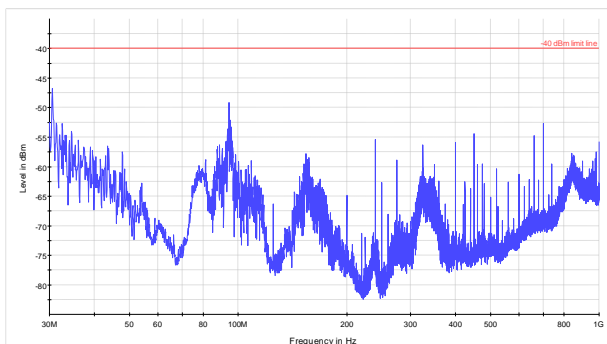
Radiated emissions  
 PK<sub>MAXH</sub>  
 -40 dBm limit line

**Figure 8.5-17:** Cabinet spurious emissions below 1 GHz 5 MHz high channel, WIN5157-5-AC



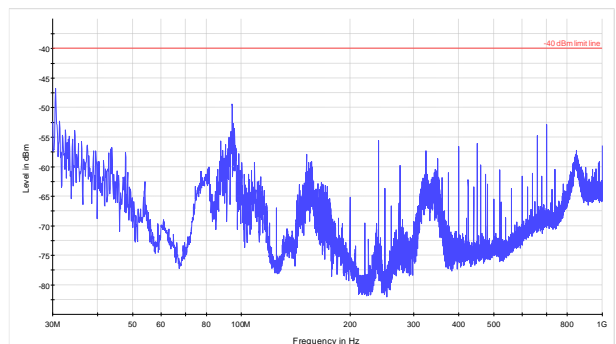
Radiated emissions  
 PK<sub>MAXH</sub>  
 -40 dBm limit line

**Figure 8.5-18:** Cabinet spurious emissions below 1 GHz 10 MHz low channel, WIN5157-5-AC



Radiated emissions  
 PK<sub>MAXH</sub>  
 -40 dBm limit line

**Figure 8.5-19:** Cabinet spurious emissions below 1 GHz 10 MHz mid channel, WIN5157-5-AC



Radiated emissions  
 PK<sub>MAXH</sub>  
 -40 dBm limit line

**Figure 8.5-20:** Cabinet spurious emissions below 1 GHz 10 MHz high channel, WIN5157-5-AC

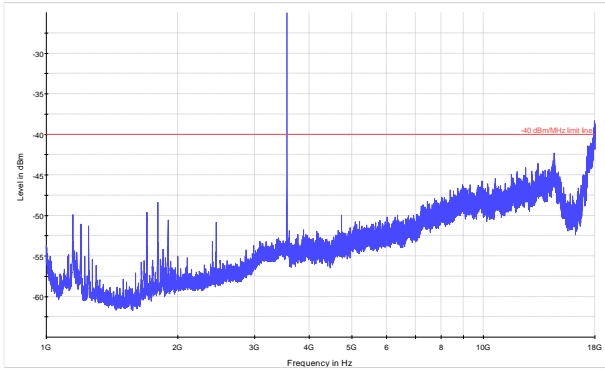


Figure 8.5-21: Cabinet spurious emissions above 1 GHz 5 MHz low channel, WIN5157-5-AC

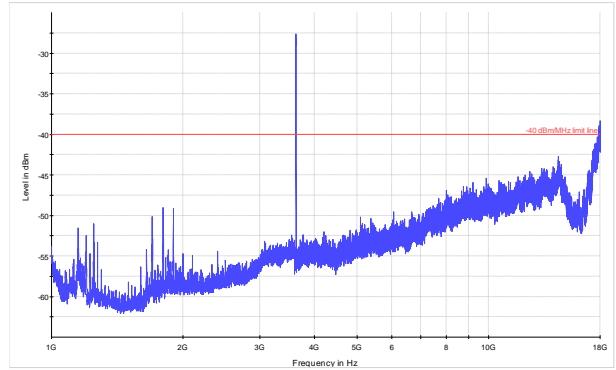


Figure 8.5-22: Cabinet spurious emissions above 1 GHz 5 MHz mid channel, WIN5157-5-AC

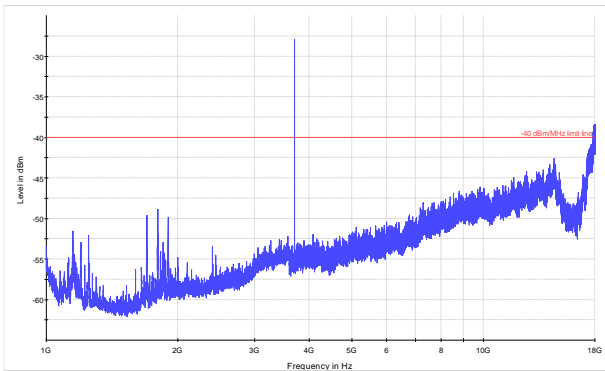


Figure 8.5-23: Cabinet spurious emissions above 1 GHz 5 MHz high channel, WIN5157-5-AC

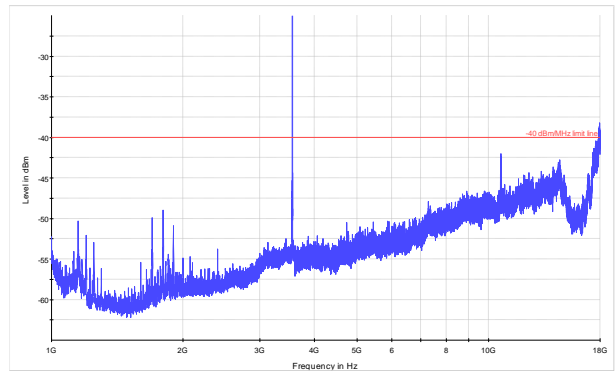


Figure 8.5-24: Cabinet spurious emissions above 1 GHz 10 MHz low channel, WIN5157-5-AC

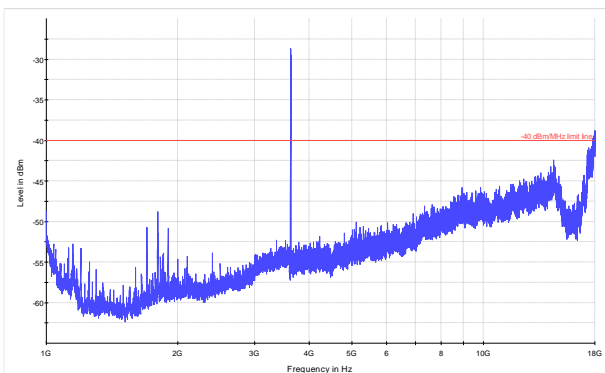


Figure 8.5-25: Cabinet spurious emissions above 1 GHz 10 MHz mid channel, WIN5157-5-AC

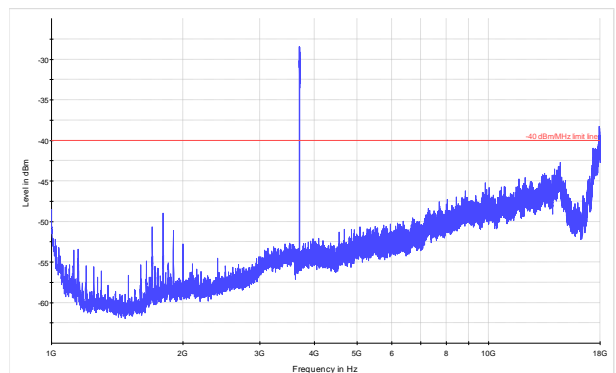
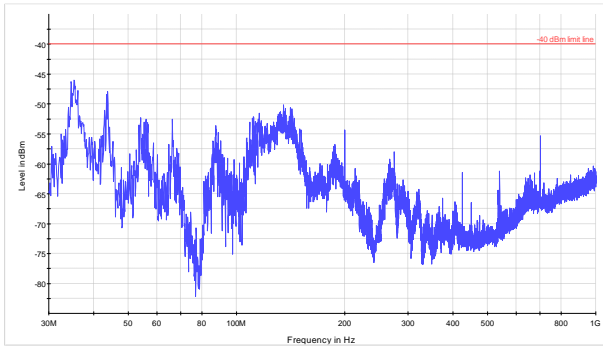
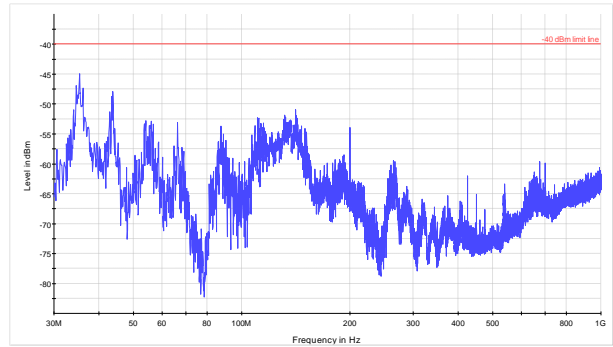


Figure 8.5-26: Cabinet spurious emissions above 1 GHz 10 MHz high channel, WIN5157-5-AC



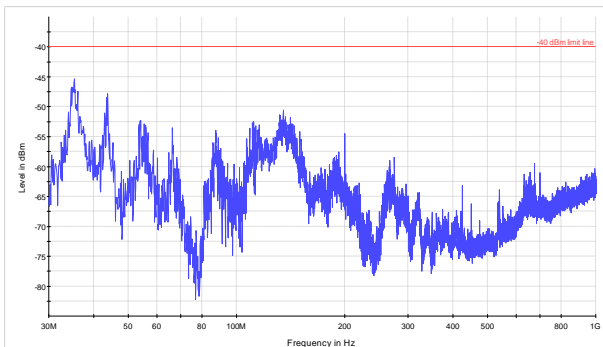
Radiated emissions  
 PK<sub>r</sub>\_MAXH  
 -40 dBm limit line

**Figure 8.5-27:** Cabinet spurious emissions below 1 GHz 5 MHz low channel, WIN5137-V-GPS



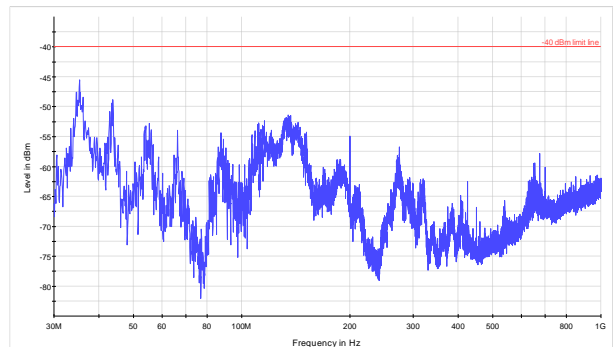
Radiated emissions  
 PK<sub>r</sub>\_MAXH  
 -40 dBm limit line

**Figure 8.5-28:** Cabinet spurious emissions below 1 GHz 5 MHz mid channel, WIN5137-V-GPS



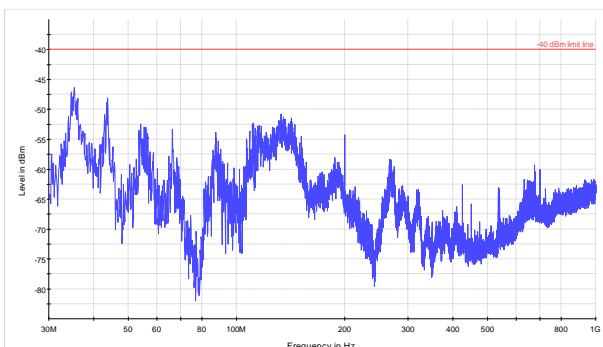
Radiated emissions  
 PK<sub>r</sub>\_MAXH  
 -40 dBm limit line

**Figure 8.5-29:** Cabinet spurious emissions below 1 GHz 5 MHz high channel, WIN5137-V-GPS



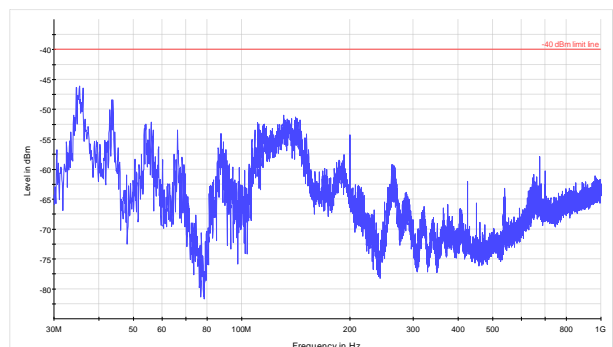
Radiated emissions  
 PK<sub>r</sub>\_MAXH  
 -40 dBm limit line

**Figure 8.5-30:** Cabinet spurious emissions below 1 GHz 10 MHz low channel, WIN5137-V-GPS



Radiated emissions  
 PK<sub>r</sub>\_MAXH  
 -40 dBm limit line

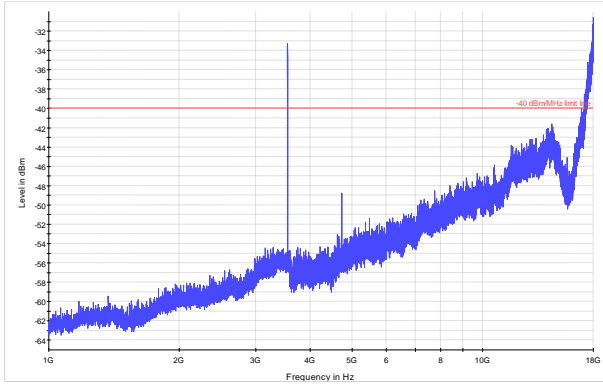
**Figure 8.5-31:** Cabinet spurious emissions below 1 GHz 10 MHz mid channel, WIN5137-V-GPS



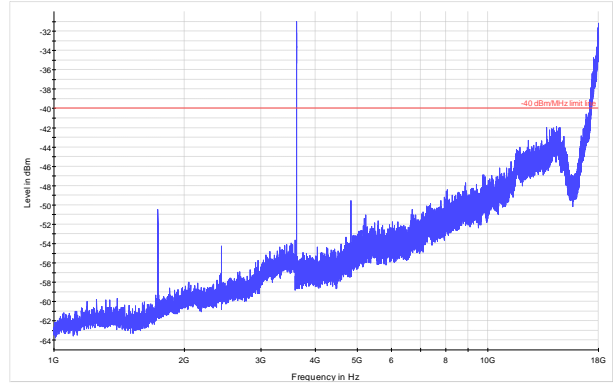
Radiated emissions  
 PK<sub>r</sub>\_MAXH  
 -40 dBm limit line

**Figure 8.5-32:** Cabinet spurious emissions below 1 GHz 10 MHz high channel, WIN5137-V-GPS

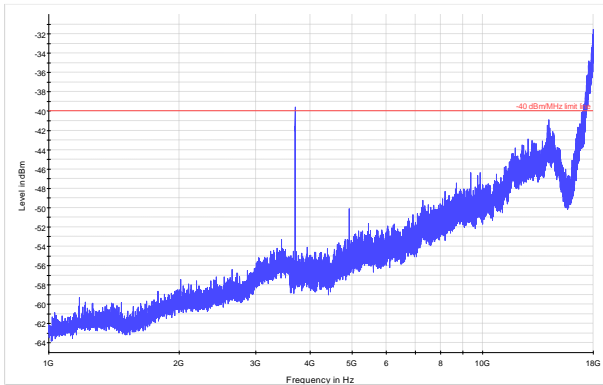




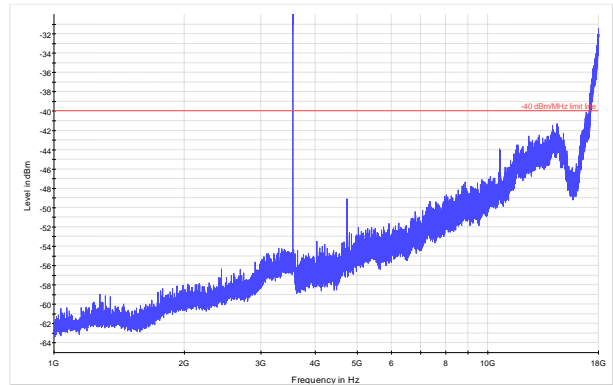
**Figure 8.5-33:** Cabinet spurious emissions above 1 GHz 5 MHz low channel, WIN5137-V-GPS



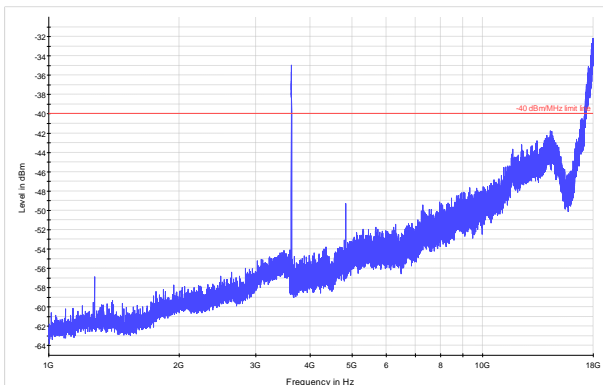
**Figure 8.5-34:** Cabinet spurious emissions above 1 GHz 5 MHz mid channel, WIN5137-V-GPS



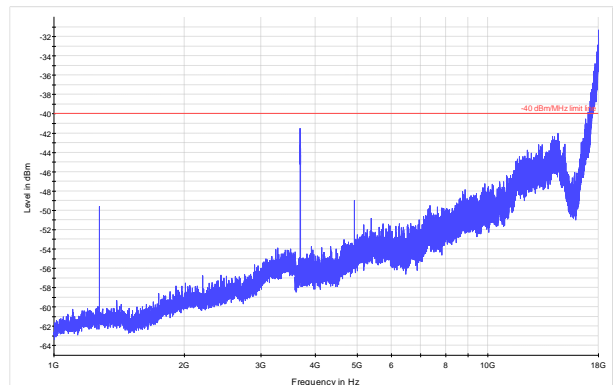
**Figure 8.5-35:** Cabinet spurious emissions above 1 GHz 5 MHz high channel, WIN5137-V-GPS



**Figure 8.5-36:** Cabinet spurious emissions above 1 GHz 10 MHz low channel, WIN5137-V-GPS



**Figure 8.5-37:** Cabinet spurious emissions above 1 GHz 10 MHz mid channel, WIN5137-V-GPS



**Figure 8.5-38:** Cabinet spurious emissions above 1 GHz 10 MHz high channel, WIN5137-V-GPS

On the plots above in the frequency range above 17 GHz the noise floor of the measuring equipment exceeded the limit. Further technical investigation led to conclusion that there are no spurious emissions and harmonics within this frequency range.

## 8.6 FCC 2.1055 Frequency stability

### 8.6.1 Definitions and limits

- (a) The frequency stability shall be measured with variation of ambient temperature as follows:  
 (1) From -30°C to +50°C for all equipment except that specified in paragraphs (a)(2) and (3) of this section  
 (b) Frequency measurements shall be made at the extremes of the specified temperature range and at intervals of not more than 10° C through the range.  
 (d) The frequency stability shall be measured with variation of primary supply voltage as follows:  
 (1) Vary primary supply voltage from 85 to 115 percent of the nominal value for other than hand carried battery equipment.

### 8.6.2 Test summary

Test date: October 13, 2018

### 8.6.3 Observations, settings and special notes

Spectrum analyser settings:

Resolution bandwidth	≥ 1 % of emission bandwidth
Video bandwidth	≥ 3 × RBW
Frequency span	Wider than emission bandwidth
Detector mode	Peak

### 8.6.4 Test data

**Table 8.6-1: Frequency drift measurement results**

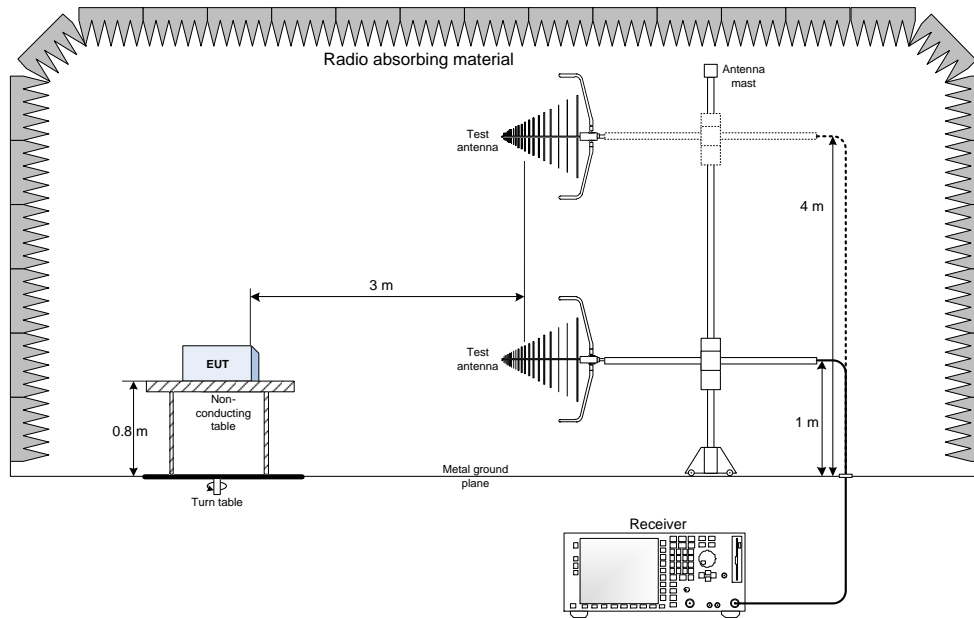
Test conditions	Frequency, Hz	Offset, ppm
+50 °C, Nominal	3624973182	-16.49
+40 °C, Nominal	3625037994	1.39
+30 °C, Nominal	3624971991	-16.82
+20 °C, +15 %	3624996610	-10.03
+20 °C, Nominal	3625032966	Reference
+20 °C, -15 %	3625038318	1.48
+10 °C, Nominal	3625003794	-8.05
0 °C, Nominal	3625030060	-0.80
-10 °C, Nominal	3625044257	3.11
-20 °C, Nominal	3625006094	-7.41
-30 °C, Nominal	3624963228	-19.24

Note: Offset was calculated as per the following formula:

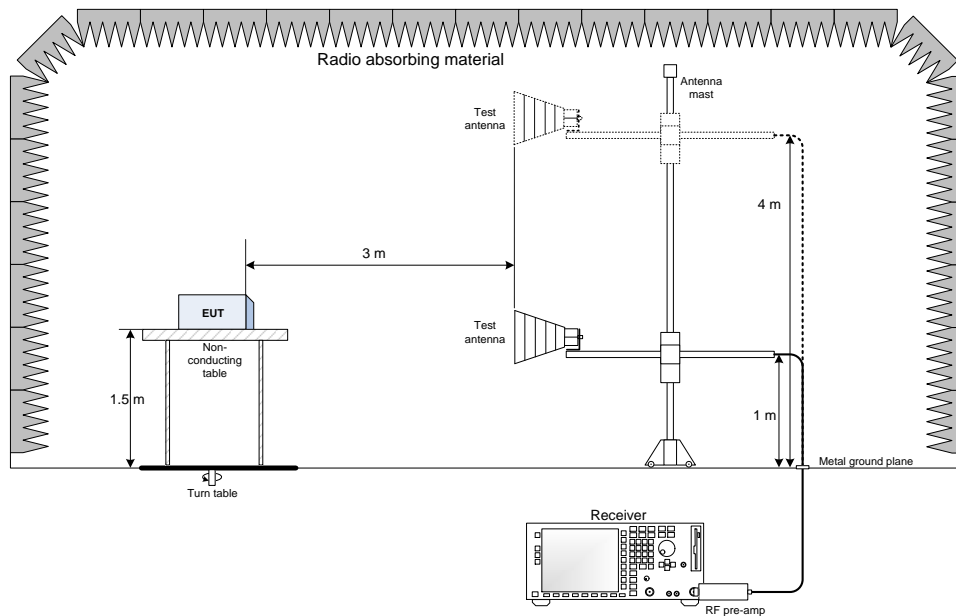
$$\frac{F_{Measured} - F_{reference}}{F_{reference}} \times 1 \cdot 10^6$$

## Section 9. Block diagrams of test set-ups

### 9.1 Radiated emissions set-up for frequencies below 1 GHz



### 9.2 Radiated emissions set-up for frequencies above 1 GHz



### 9.3 Conducted emissions set-up

---

