



Email: sales@autel.com
 Web: www.autel.com

IMPORTANT SAFETY INSTRUCTION

Trademarks

Autel®, MaxiSys®, and MaxiDAS® are trademarks of Autel Intelligent Technology Corp., Ltd., registered in China, the United States and other countries. All other marks are trademarks or registered trademarks of their respective holders.

Copyright Information

No part of this manual may be reproduced, stored in a retrieval system or transmitted, in any form or by any means, electronic, mechanical, photocopying, recording, or otherwise, without the prior written permission of Autel.

Disclaimer of Warranties and Limitation of Liabilities

All information, specifications and illustrations in this manual are based on the latest information available at the time of printing. Autel reserves the right to make changes at any time without notice.

For Services and Support:

	pro.autel.com / www.autel.com
	1-855-288-3587/1-855-AUTELUS (North America) 0086-755-86147779 (China)
	support@autel.com

For technical assistance in all other markets, please contact your selling agent.

Safety Information

For your own safety and the safety of others, and to prevent damage to the equipment and vehicles upon which it is used, it is important that the safety instructions presented throughout this manual be read and understood by all persons operating or coming into contact with the equipment.



There are various procedures, techniques, tools, and parts for servicing vehicles, as well as in the skill of the individual doing the work. Because of the vast number of test applications and variations in the products that can be tested with this instrument, we cannot possibly anticipate or provide advice or safety messages to cover every situation.

It is the automotive technician's responsibility to be knowledgeable of the system being tested. It is essential to use proper service methods and test procedures. It is important to perform tests in an appropriate and acceptable manner that does not endanger your safety, the safety of others in the work area, the equipment being used, or the vehicle being tested.

Before using the equipment, always refer to and follow the safety messages and applicable test procedures provided by the manufacturer of the vehicle or equipment being tested. Use the equipment only as described in this manual. Read, understand, and follow all safety messages and instructions in this manual.



Safety Messages

Safety messages are provided to help prevent personal injury and equipment damage. All safety messages are introduced by a signal word indicating the hazard level.

-  **DANGER:** Indicates an imminently hazardous situation which, if not avoided, will result in death or serious injury to the operator or to bystanders.
-  **WARNING:** Indicates a potentially hazardous situation which, if not avoided, could result in death or serious injury to the operator or to bystanders.

Safety Instructions

The safety messages herein cover situations Autel is aware of. Autel cannot know, evaluate or advise you as to all of the possible hazards. You must be certain that any condition or service procedure encountered does not jeopardize your personal safety.

-  **DANGER:** When an engine is operating, keep the service area WELL VENTILATED or attach a building exhaust removal system to the engine exhaust system. Engines produce carbon monoxide, an odorless, poisonous gas that causes slower reaction time and can lead to serious personal injury or loss of life.
-  **WARNINGS:**
 - Always perform automotive testing in a safe environment.
 - Wear safety eye protection that meets ANSI standards.
 - Keep clothing, hair, hands, tools, test equipment, etc. away from all moving or hot engine parts.
 - Operate the vehicle in a well ventilated work area, for exhaust gases are poisonous.
 - Put the transmission in PARK (for automatic transmission) or NEUTRAL (for manual transmission) and make sure the parking brake is engaged.
 - Put blocks in front of the drive wheels and never leave the vehicle unattended while testing.
 - Be extra cautious when working around the ignition coil, distributor cap, ignition wires and spark plugs. These components create hazardous voltages when the engine is running.
 - Keep a fire extinguisher suitable for gasoline, chemical, and electrical fires nearby.
 - Do not connect or disconnect any test equipment while the ignition is on or the engine is running.
 - Keep the test equipment dry, clean, free from oil, water or grease. Use a mild detergent in a clean cloth to clean the outside of the equipment as necessary.
 - Do not drive the vehicle and operate the test equipment at the same time. Any distraction may cause an accident.
 - Refer to the service manual for the vehicle being serviced and adhere to all diagnostic procedures and precautions. Failure to do so may result in personal injury or damage to the test equipment.
 - To avoid damaging the test equipment or generating false data, make sure the vehicle battery is fully charged and the connection to the vehicle DLC is clean and secure.
 - Do not place the test equipment on the distributor of the vehicle. Strong electro-magnetic interference can damage the equipment.

PRODUCT DESCRIPTION

The MaxiSys MS909 provides full functions and online repair information for diagnosing vehicles, identifying faults and researching repair issues. It features a powerful octa-core processor and 9.7-inch TFT-LCD capacitive touchscreen for swift diagnosis and optimum viewing. As an intelligent diagnostics and information system, MaxiSys MS909 not only displays the relevant repair fixes and cases gathered from experienced industry experts, but also provides step-by-step guidance to ensure the repair is done correctly and efficiently. Note: indoor use only

The MaxiSys MS909 has two main components:

- MaxiSys Tablet — the central processor and monitor for the system
- VCI — the vehicle communication interface

Body SAR_{1g} (2.4G WLAN) : 0.820

Body SAR_{1g} (5.2G WLAN) : 0.860

Body SAR_{1g} (5.8G WLAN) : 0.770

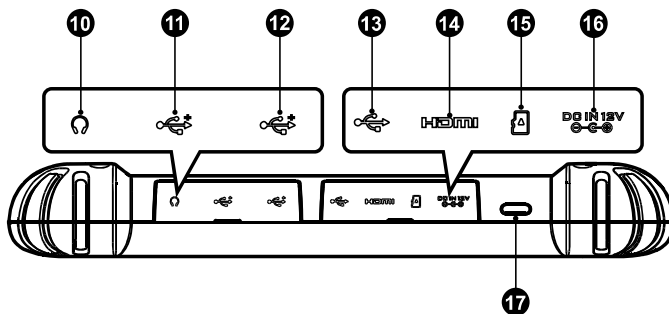
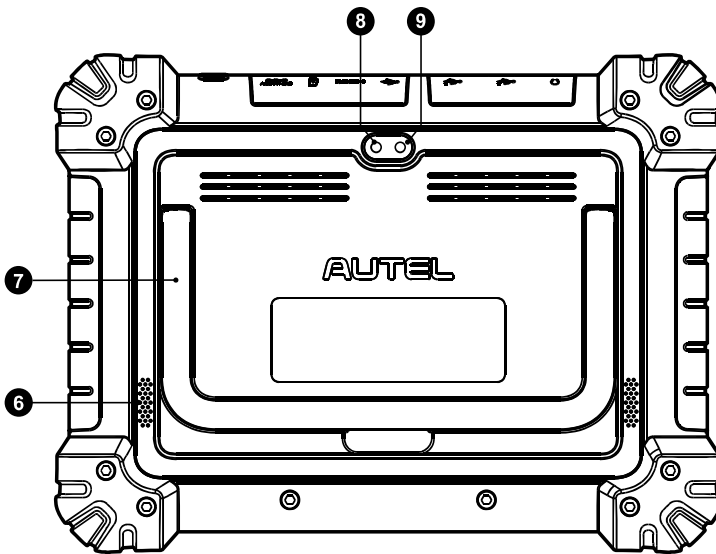
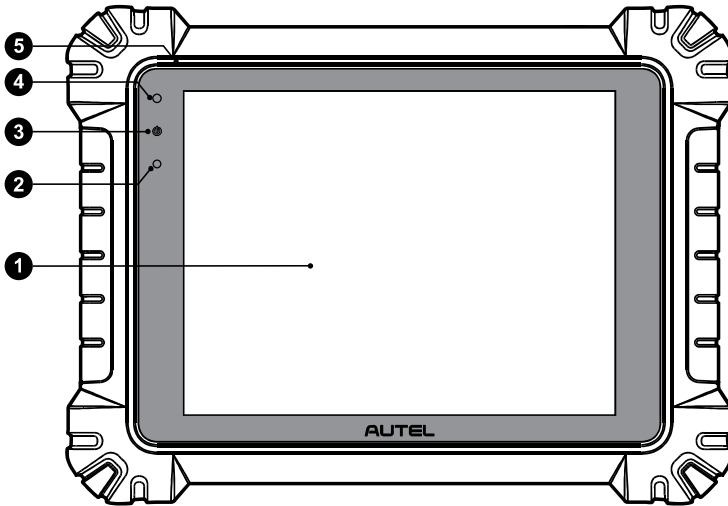

1. 9.7" TFT-LCD Capacitive Touchscreen
2. Ambient Light Sensor — detects ambient brightness
3. Power LED
4. Front Camera
5. Microphone
6. Speaker
7. Collapsible Stand — extends from the back to allow hands-free viewing of the tablet
8. Rear Camera
9. Camera Flash
10. Headphone Jack
11. USB Port
12. USB Port
13. Mini USB Port
14. HDMI (High-Definition Multimedia Interface) Port
15. Mini SD Card Slot
16. DC Power Supply Input Port
17. Lock/Power Button — long press to turn on and off the tablet, or tap the power button to lock the screen

MAXISYS MS909

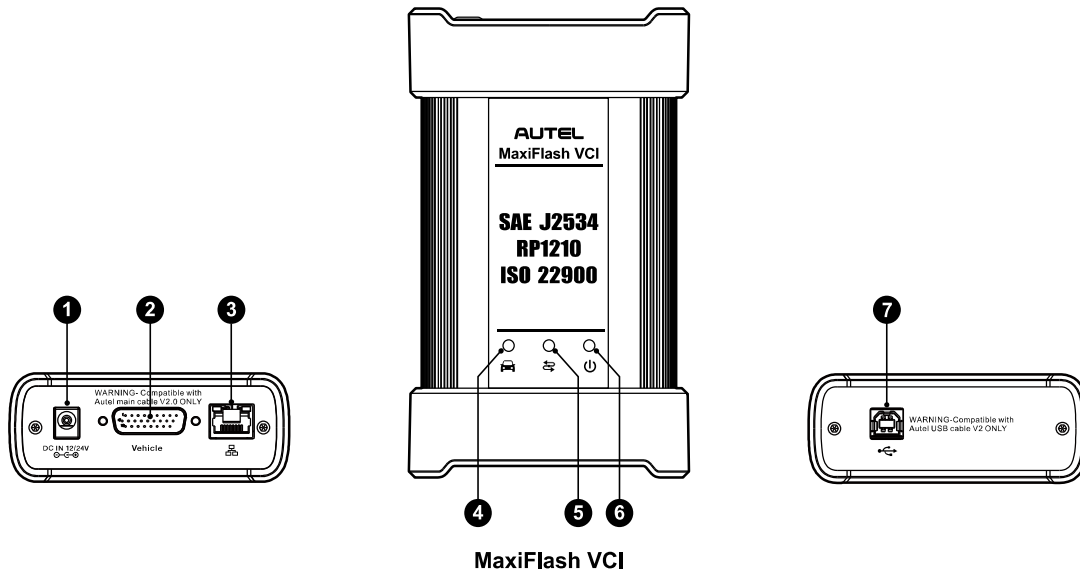

1. DC Power Supply Input Port
2. Vehicle Data Connector
3. Ethernet Port
4. Vehicle LED — flashes green when the device is communicating with the vehicle.
5. Connection LED — refer to Table 1-1 Connection LED Description for details.
6. Power LED — refer to Table 1-2 Power LED Description for details.
7. USB Port

1-1 Connection LED Description

LED	Color	Description
Connection	Green	Lights solid green when connected with the tablet via the USB cable.
	Cyan	Lights solid cyan (blue/green) when connected via Wi-Fi.
	Blue	Lights solid blue when connected via wireless Bluetooth connection.

1-2 Power LED Description

LED	Color	Description
Power	Yellow	Lights yellow automatically at power up when VCI is self-testing.
	Green	Lights solid green when powered on.
	Red	<ul style="list-style-type: none"> • Lights solid red when system failure occurs. • Flashes red when VCI is upgrading.

GETTING STARTED



IMPORTANT: Before operating or maintaining this unit, please read these instructions carefully, paying extra attention to the safety warnings and precautions. Use this unit correctly and with care. Failure to do so may cause damage and/or personal injury and will void the product warranty.



WARNING: The MaxiFlash VCI is compatible with Autel main cable V2.0 and USB cable V2 only.

- 1** Connect the main cable V2.0 to the Vehicle Data Connector on the VCI unit, and tighten the thumb screws.

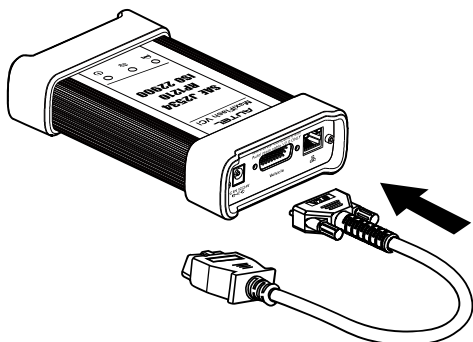

- 2** Connect the cable's 16-pin adapter to the vehicle's DLC, which is generally located under the vehicle dash.

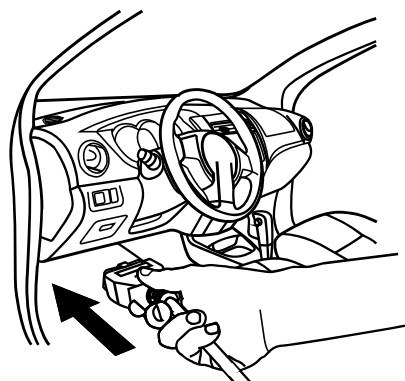

- 3** Power up the tablet. Ensure the tablet has a charged battery or is connected to the supplied DC power supply.

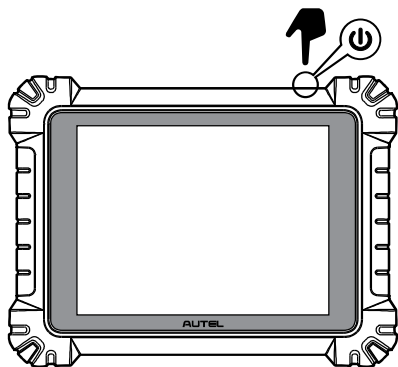

- 4** Select from Bluetooth, Wi-Fi or USB cable V2 to connect the tablet with the VCI device and establish a communication link. Use only the USB cable connection when programming.

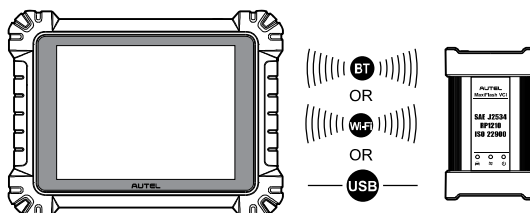

- 5** When the VCI device is properly connected to the vehicle and the tablet, the VCI status button on the bottom tool bar of the screen shows a green badge, indicating the platform is ready to start vehicle diagnosis.

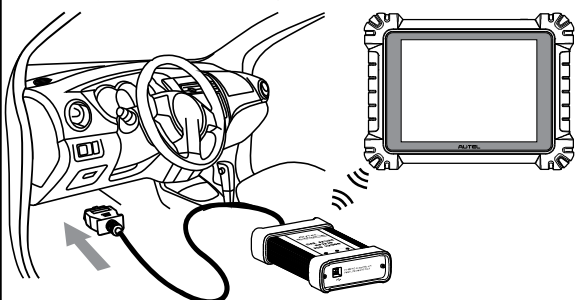

Thank you for purchasing this AUTEL MaxiSys MS909. Autel manufactures its tools to the highest standards. If properly maintained and used according to instructions, the MS909 will provide years of trouble-free use.

图号	2	3	4	5	6	7	8
A							
B							
C							
D							
E							
F							

FCC STATEMENT :

This device complies with Part 15 of the FCC Rules. Operation is subject to the following two conditions:

- (1) This device may not cause harmful interference, and
- (2) This device must accept any interference received, including interference that may cause undesired operation.

Warning: Changes or modifications not expressly approved by the party responsible for compliance could void the user's authority to operate the equipment.

NOTE: This equipment has been tested and found to comply with the limits for a Class B digital device, pursuant to Part 15 of the FCC Rules. These limits are designed to provide reasonable protection against harmful interference in a residential installation. This equipment generates uses and can radiate radio frequency energy and, if not installed and used in accordance with the instructions, may cause harmful interference to radio communications. However, there is no guarantee that interference will not occur in a particular installation. If this equipment does cause harmful interference to radio or television reception, which can be determined by turning the equipment off and on, the user is encouraged to try to correct the interference by one or more of the following measures:

- Reorient or relocate the receiving antenna.
 - Increase the separation between the equipment and receiver.
 - Connect the equipment into an outlet on a circuit different from that to which the receiver is connected.
 - Consult the dealer or an experienced radio/TV technician for help.
- RF warning statement:
The device has been evaluated to meet general RF exposure requirement. The device can be used in portable exposure condition without restriction.

IC STATEMENT :

- English: "

This device complies with Industry Canada licence-exempt RSS standard(s). Operation is subject to the following two conditions:

- (1) this device may not cause interference, and
- (2) this device must accept any interference, including interference that may cause undesired operation of the device."

- French: "

Le présent appareil est conforme aux CNR d'Industrie Canada applicables aux appareils radio exempts de licence. L'exploitation est autorisée aux deux conditions suivantes :

- (1) l'appareil ne doit pas produire de brouillage, et
- (2) l'utilisateur de l'appareil doit accepter tout brouillage radioélectrique subi, même si le brouillage est susceptible d'en compromettre le fonctionnement."

SAR STATEMENT :

This equipment complies with FCC radiation exposure limits set forth for an uncontrolled environment. End user must follow the specific operating instructions for satisfying RF exposure compliance. The device is designed to meet the requirements for exposure to radio waves established by the Federal Communications Commission (USA). These requirements set a SAR limit of 1.6 W/kg averaged over one gram of tissue. The highest SAR value reported under this standard during product certification for use when properly worn on the body is 0.860 W/kg.

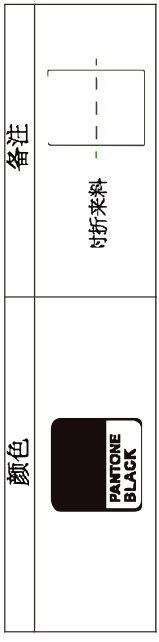

AUTEL 道通科技股份有限公司 Auto Intelligent Technology Corp Ltd.		张贝贝 兰金香 王高		张贝贝 兰金香 王高		张贝贝 兰金香 王高	
张贝贝 兰金香 王高		张贝贝 兰金香 王高		张贝贝 兰金香 王高		张贝贝 兰金香 王高	
张贝贝 兰金香 王高		张贝贝 兰金香 王高		张贝贝 兰金香 王高		张贝贝 兰金香 王高	
张贝贝 兰金香 王高		张贝贝 兰金香 王高		张贝贝 兰金香 王高		张贝贝 兰金香 王高	
张贝贝 兰金香 王高		张贝贝 兰金香 王高		张贝贝 兰金香 王高		张贝贝 兰金香 王高	
张贝贝 兰金香 王高		张贝贝 兰金香 王高		张贝贝 兰金香 王高		张贝贝 兰金香 王高	
张贝贝 兰金香 王高		张贝贝 兰金香 王高		张贝贝 兰金香 王高		张贝贝 兰金香 王高	
张贝贝 兰金香 王高		张贝贝 兰金香 王高		张贝贝 兰金香 王高		张贝贝 兰金香 王高	
张贝贝 兰金香 王高		张贝贝 兰金香 王高		张贝贝 兰金香 王高		张贝贝 兰金香 王高	
张贝贝 兰金香 王高		张贝贝 兰金香 王高		张贝贝 兰金香 王高		张贝贝 兰金香 王高	
张贝贝 兰金香 王高		张贝贝 兰金香 王高		张贝贝 兰金香 王高		张贝贝 兰金香 王高	
张贝贝 兰金香 王高		张贝贝 兰金香 王高		张贝贝 兰金香 王高		张贝贝 兰金香 王高	
张贝贝 兰金香 王高		张贝贝 兰金香 王高		张贝贝 兰金香 王高		张贝贝 兰金香 王高	
张贝贝 兰金香 王高		张贝贝 兰金香 王高		张贝贝 兰金香 王高		张贝贝 兰金香 王高	
张贝贝 兰金香 王高		张贝贝 兰金香 王高		张贝贝 兰金香 王高		张贝贝 兰金香 王高	
张贝贝 兰金香 王高		张贝贝 兰金香 王高		张贝贝 兰金香 王高		张贝贝 兰金香 王高	
张贝贝 兰金香 王高		张贝贝 兰金香 王高		张贝贝 兰金香 王高		张贝贝 兰金香 王高	
张贝贝 兰金香 王高		张贝贝 兰金香 王高		张贝贝 兰金香 王高		张贝贝 兰金香 王高	
张贝贝 兰金香 王高		张贝贝 兰金香 王高		张贝贝 兰金香 王高		张贝贝 兰金香 王高	
张贝贝 兰金香 王高		张贝贝 兰金香 王高		张贝贝 兰金香 王高		张贝贝 兰金香 王高	
张贝贝 兰金香 王高		张贝贝 兰金香 王高		张贝贝 兰金香 王高		张贝贝 兰金香 王高	
张贝贝 兰金香 王高		张贝贝 兰金香 王高		张贝贝 兰金香 王高		张贝贝 兰金香 王高	
张贝贝 兰金香 王高		张贝贝 兰金香 王高		张贝贝 兰金香 王高		张贝贝 兰金香 王高	
张贝贝 兰金香 王高		张贝贝 兰金香 王高		张贝贝 兰金香 王高		张贝贝 兰金香 王高	
张贝贝 兰金香 王高		张贝贝 兰金香 王高		张贝贝 兰金香 王高		张贝贝 兰金香 王高	
张贝贝 兰金香 王高		张贝贝 兰金香 王高		张贝贝 兰金香 王高		张贝贝 兰金香 王高	
张贝贝 兰金香 王高		张贝贝 兰金香 王高		张贝贝 兰金香 王高		张贝贝 兰金香 王高	
张贝贝 兰金香 王高		张贝贝 兰金香 王高		张贝贝 兰金香 王高		张贝贝 兰金香 王高	
张贝贝 兰金香 王高		张贝贝 兰金香 王高		张贝贝 兰金香 王高		张贝贝 兰金香 王高	
张贝贝 兰金香 王高		张贝贝 兰金香 王高		张贝贝 兰金香 王高		张贝贝 兰金香 王高	
张贝贝 兰金香 王高		张贝贝 兰金香 王高		张贝贝 兰金香 王高		张贝贝 兰金香 王高	
张贝贝 兰金香 王高		张贝贝 兰金香 王高		张贝贝 兰金香 王高		张贝贝 兰金香 王高	
张贝贝 兰金香 王高		张贝贝 兰金香 王高		张贝贝 兰金香 王高		张贝贝 兰金香 王高	
张贝贝 兰金香 王高		张贝贝 兰金香 王高		张贝贝 兰金香 王高		张贝贝 兰金香 王高	
张贝贝 兰金香 王高		张贝贝 兰金香 王高		张贝贝 兰金香 王高		张贝贝 兰金香 王高	
张贝贝 兰金香 王高		张贝贝 兰金香 王高		张贝贝 兰金香 王高		张贝贝 兰金香 王高	
张贝贝 兰金香 王高		张贝贝 兰金香 王高		张贝贝 兰金香 王高		张贝贝 兰金香 王高	
张贝贝 兰金香 王高		张贝贝 兰金香 王高		张贝贝 兰金香 王高		张贝贝 兰金香 王高	
张贝贝 兰金香 王高		张贝贝 兰金香 王高		张贝贝 兰金香 王高		张贝贝 兰金香 王高	
张贝贝 兰金香 王高		张贝贝 兰金香 王高		张贝贝 兰金香 王高		张贝贝 兰金香 王高	
张贝贝 兰金香 王高		张贝贝 兰金香 王高		张贝贝 兰金香 王高		张贝贝 兰金香 王高	
张贝贝 兰金香 王高		张贝贝 兰金香 王高		张贝贝 兰金香 王高		张贝贝 兰金香 王高	
张贝贝 兰金香 王高		张贝贝 兰金香 王高		张贝贝 兰金香 王高		张贝贝 兰金香 王高	
张贝贝 兰金香 王高		张贝贝 兰金香 王高		张贝贝 兰金香 王高		张贝贝 兰金香 王高	
张贝贝 兰金香 王高		张贝贝 兰金香 王高		张贝贝 兰金香 王高		张贝贝 兰金香 王高	
张贝贝 兰金香 王高		张贝贝 兰金香 王高		张贝贝 兰金香 王高		张贝贝 兰金香 王高	
张贝贝 兰金香 王高		张贝贝 兰金香 王高		张贝贝 兰金香 王高		张贝贝 兰金香 王高	
张贝贝 兰金香 王高		张贝贝 兰金香 王高		张贝贝 兰金香 王高		张贝贝 兰金香 王高	
张贝贝 兰金香 王高		张贝贝 兰金香 王高		张贝贝 兰金香 王高		张贝贝 兰金香 王高	
张贝贝 兰金香 王高		张贝贝 兰金香 王高		张贝贝 兰金香 王高		张贝贝 兰金香 王高	
张贝贝 兰金香 王高		张贝贝 兰金香 王高		张贝贝 兰金香 王高		张贝贝 兰金香 王高	
张贝贝 兰金香 王高		张贝贝 兰金香 王高		张贝贝 兰金香 王高		张贝贝 兰金香 王高	
张贝贝 兰金香 王高		张贝贝 兰金香 王高		张贝贝 兰金香 王高		张贝贝 兰金香 王高	
张贝贝 兰金香 王高		张贝贝 兰金香 王高		张贝贝 兰金香 王高		张贝贝 兰金香 王高	
张贝贝 兰金香 王高		张贝贝 兰金香 王高		张贝贝 兰金香 王高		张贝贝 兰金香 王高	
张贝贝 兰金香 王高		张贝贝 兰金香 王高		张贝贝 兰金香 王高		张贝贝 兰金香 王高	
张贝贝 兰金香 王高		张贝贝 兰金香 王高		张贝贝 兰金香 王高		张贝贝 兰金香 王高	
张贝贝 兰金香 王高		张贝贝 兰金香 王高		张贝贝 兰金香 王高		张贝贝 兰金香 王高	
张贝贝 兰金香 王高		张贝贝 兰金香 王高		张贝贝 兰金香 王高		张贝贝 兰金香 王高	
张贝贝 兰金香 王高		张贝贝 兰金香 王高		张贝贝 兰金香 王高		张贝贝 兰金香 王高	
张贝贝 兰金香 王高		张贝贝 兰金香 王高		张贝贝 兰金香 王高		张贝贝 兰金香 王高	
张贝贝 兰金香 王高		张贝贝 兰金香 王高		张贝贝 兰金香 王高		张贝贝 兰金香 王高	
张贝贝 兰金香 王高		张贝贝 兰金香 王高		张贝贝 兰金香 王高		张贝贝 兰金香 王高	
张贝贝 兰金香 王高		张贝贝 兰金香 王高		张贝贝 兰金香 王高		张贝贝 兰金香 王高	
张贝贝 兰金香 王高		张贝贝 兰金香 王高		张贝贝 兰金香 王高		张贝贝 兰金香 王高	
张贝贝 兰金香 王高		张贝贝 兰金香 王高		张贝贝 兰金香 王高		张贝贝 兰金香 王高	
张贝贝 兰金香 王高		张贝贝 兰金香 王高		张贝贝 兰金香 王高		张贝贝 兰金香 王高	
张贝贝 兰金香 王高		张贝贝 兰金香 王高		张贝贝 兰金香 王高		张贝贝 兰金香 王高	
张贝贝 兰金香 王高		张贝贝 兰金香 王高		张贝贝 兰金香 王高		张贝贝 兰金香 王高	
张贝贝 兰金香 王高		张贝贝 兰金香 王高		张贝贝 兰金香 王高		张贝贝 兰金香 王高	
张贝贝 兰金香 王高		张贝贝 兰金香 王高		张贝贝 兰金香 王高		张贝贝 兰金香 王高	
张贝贝 兰金香 王高		张贝贝 兰金香 王高		张贝贝 兰金香 王高		张贝贝 兰金香 王高	
张贝贝 兰金香 王高		张贝贝 兰金香 王高		张贝贝 兰金香 王高		张贝贝 兰金香 王高	
张贝贝 兰金香 王高		张贝贝 兰金香 王高		张贝贝 兰金香 王高		张贝贝 兰金香 王高	
张贝贝 兰金香 王高		张贝贝 兰金香 王高		张贝贝 兰金香 王高		张贝贝 兰金香 王高	
张贝贝 兰金香 王高		张贝贝 兰金香 王高		张贝贝 兰金香 王高		张贝贝 兰金香 王高	
张贝贝 兰金香 王高		张贝贝 兰金香 王高		张贝贝 兰金香 王高		张贝贝 兰金香 王高	
张贝贝 兰金香 王高		张贝贝 兰金香 王高		张贝贝 兰金香 王高		张贝贝 兰金香 王高	
张贝贝 兰金香 王高		张贝贝 兰金香 王高		张贝贝 兰金香 王高		张贝贝 兰金香 王高	
张贝贝 兰金香 王高		张贝贝 兰金香 王高		张贝贝 兰金香 王高		张贝贝 兰金香 王高	
张贝贝 兰金香 王高		张贝贝 兰金香 王高		张贝贝 兰金香 王高		张贝贝 兰金香 王高	
张贝贝 兰金香 王高							