



# FCC TEST REPORT

**Test report  
On Behalf of  
Autel Intelligent Tech. Corp., Ltd.  
For  
KEY PROGRAMMING DIAGNOSTICS TOOL  
Model No.: MaxiIM IM608 II, MaxiIM IM608 II Pro  
FCC ID: WQ8-IM608PRO2121**

**Prepared For:** Autel Intelligent Tech. Corp., Ltd.  
7th-8th, 10th Floor, Bldg. B1, Zhiyuan, Xueyuan Rd. Xili, Nanshan, Shenzhen,  
518055 China

**Prepared By:** Shenzhen HUAK Testing Technology Co., Ltd.  
1-2/F., Building B2, Junfeng Zhongcheng Zhizao Innovation Park, Heping,  
Fuhai Street, Bao'an District, Shenzhen, Guangdong, China

**Date of Test:** Feb. 09, 2022 ~ Mar. 07, 2022

**Date of Report:** Mar. 07, 2022

**Report Number:** HK2202090298-3E



TEST RESULT CERTIFICATION

Applicant's name : Autel Intelligent Tech. Corp., Ltd.
Address: 7th-8th, 10th Floor, Bldg. B1, Zhiyuan, Xueyuan Rd. Xili, Nanshan, Shenzhen, 518055 China
Manufacture's Name : Autel Intelligent Tech. Corp., Ltd.
Address: 7th-8th, 10th Floor, Bldg. B1, Zhiyuan, Xueyuan Rd. Xili, Nanshan, Shenzhen, 518055 China

Product description

Trade Mark: Autel
Product name: KEY PROGRAMMING DIAGNOSTICS TOOL
Model and/or type reference : MaxiIM IM608 II, MaxiIM IM608 II Pro
Standards: FCC Rules and Regulations Part 15 Subpart E Section 15.407
ANSI C63.10: 2013

This publication may be reproduced in whole or in part for non-commercial purposes as long as the Shenzhen HUAK Testing Technology Co., Ltd. is acknowledged as copyright owner and source of the material. Shenzhen HUAK Testing Technology Co., Ltd. takes no responsibility for and will not assume liability for damages resulting from the reader's interpretation of the reproduced material due to its placement and context.

Date of Test :
Date (s) of performance of tests: Feb. 09, 2022 ~ Mar. 07, 2022
Date of Issue: Mar. 07, 2022
Test Result: Pass

Testing Engineer : [Signature]
(Gary Qian)

Technical Manager : [Signature]
(Eden Hu)

Authorized Signatory : [Signature]
(Jason Zhou)



## TABLE OF CONTENTS

<b>1. TEST RESULT SUMMARY .....</b>	<b>5</b>
1.1. TEST PROCEDURES AND RESULTS.....	5
1.2. INFORMATION OF THE TEST LABORATORY .....	5
1.3. MEASUREMENT UNCERTAINTY .....	6
<b>2. EUT DESCRIPTION .....</b>	<b>7</b>
2.1. GENERAL DESCRIPTION OF EUT .....	7
2.2. OPERATION FREQUENCY EACH OF CHANNEL .....	8
2.3. OPERATION OF EUT DURING TESTING.....	8
2.4. DESCRIPTION OF TEST SETUP .....	9
<b>3. GENERA INFORMATION .....</b>	<b>10</b>
3.1. TEST ENVIRONMENT AND MODE .....	10
3.2. DESCRIPTION OF SUPPORT UNITS.....	11
<b>4. TEST RESULTS AND MEASUREMENT DATA .....</b>	<b>12</b>
4.1. CONDUCTED EMISSION.....	12
4.2. MAXIMUM CONDUCTED OUTPUT POWER.....	16
4.3. 6DB EMISSION BANDWIDTH.....	19
4.4. 26DB BANDWIDTH AND 99% OCCUPIED BANDWIDTH .....	32
4.5. POWER SPECTRAL DENSITY .....	33
4.6. BAND EDGE.....	47
4.7. SPURIOUS EMISSION .....	84
4.8. FREQUENCY STABILITY MEASUREMENT .....	102
4.9. ANTENNA REQUIREMENT .....	104
<b>5. PHOTOGRAPHS OF TEST SETUP.....</b>	<b>105</b>
<b>6. PHOTOS OF THE EUT .....</b>	<b>107</b>



**\*\* Modified History \*\***

Revision	Description	Issued Data	Remark
Revision 1.0	Initial Test Report Release	Mar. 07, 2022	Jason Zhou

The results shown in this test report refer only to the sample(s) tested unless otherwise stated and the sample(s) are retained for 30 days only. The document is issued by HUAK, this document cannot be reproduced except in full with our prior written permission. The more details and the authenticity of the report will be confirmed at <http://www.cer-mark.com>.

HUAK Testing Lab TEL : +86-755 2302 9901 FAX : +86-755 2302 9901 E-mail : [service@cer-mark.com](mailto:service@cer-mark.com)

1-2/F., Building B2, Junfeng Zhongcheng Zhizao Innovation Park, Heping, Fuhai Street, Bao'an District, Shenzhen, Guangdong, China



# 1. TEST RESULT SUMMARY

## 1.1. TEST PROCEDURES AND RESULTS

Requirement	CFR 47 Section	Result
Antenna requirement	§15.203	PASS
AC Power Line Conducted Emission	§15.207	PASS
Maximum Conducted Output Power	§15.407(a)	PASS
6dB Emission Bandwidth	§15.407(e)	PASS
26dB Emission Bandwidth & 99% Occupied Bandwidth	§15.407(a)	N/A
Power Spectral Density	§15.407(a)	PASS
Band edge	§15.407(b)/15.209/15.205	PASS
Radiated Emission	§15.407(b)/15.209/15.205	PASS
Frequency Stability	§15.407(g)	PASS

**Note:**

1. PASS: Test item meets the requirement.
2. Fail: Test item does not meet the requirement.
3. N/A: Test case does not apply to the test object.
4. The test result judgment is decided by the limit of test standard.

## 1.2. INFORMATION OF THE TEST LABORATORY

Shenzhen HUAK Testing Technology Co., Ltd.  
 Add.: 1-2/F., Building B2, Junfeng Zhongcheng Zhizao Innovation Park, Heping,  
 Fuhai Street, Bao'an District, Shenzhen, Guangdong, China

Testing Laboratory Authorization:

A2LA Accreditation Code is 4781.01.  
 FCC Designation Number is CN1229.  
 Canada IC CAB identifier is CN0045.  
 CNAS Registration Number is L9589.



### 1.3. MEASUREMENT UNCERTAINTY

The reported uncertainty of measurement  $y \pm U$ , where expanded uncertainty  $U$  is based on a standard uncertainty multiplied by a coverage factor of  $k=2$ , providing a level of confidence of approximately 95 %.

No.	Item	MU
1	Conducted Emission	$\pm 2.71\text{dB}$
2	RF power, conducted	$\pm 0.37\text{dB}$
3	Spurious emissions, conducted	$\pm 0.11\text{dB}$
4	All emissions, radiated(<1G)	$\pm 3.90\text{dB}$
5	All emissions, radiated(>1G)	$\pm 4.28\text{dB}$
6	Temperature	$\pm 0.1^\circ\text{C}$
7	Humidity	$\pm 1.0\%$



## 2. EUT DESCRIPTION

### 2.1. GENERAL DESCRIPTION OF EUT

Equipment	KEY PROGRAMMING DIAGNOSTICS TOOL
Model Name	MaxiIM IM608 II
Series Model	MaxiIM IM608 II Pro
Trade Mark	Autel
Model Difference	All model's the function, software and electric circuit are the same, only with a product model named different. Test sample mode: MaxiIM IM608 II.
FCC ID	WQ8-IM608PRO2121
Operation Frequency	IEEE 802.11a/n/ac(HT20)5.745GHz-5.825GHz IEEE 802.11n/ac(HT40)5.755GHz-5.795GHz IEEE 802.11ac(HT80) 5.775GHz
Modulation Technology	IEEE 802.11a/n/ac
Modulation Type	CCK/OFDM/DBPSK/DAPSK
Antenna Type	Internal Antenna
Antenna Gain	Antenna 1:2.6dBi Antenna 2:3.4dBi MIMO: 6.03dBi
Power Source	DC 3.8V from battery or DC 12V from adapter
Power Supply	DC 3.8V from battery or DC 12V from adapter
<p>Note: The EUT incorporates a MIMO function. Physically, it provides two completed transmitters and receivers(2T2R), two transmit signals are completely correlated, then, Direction gain=GANT + Array Gain(Array Gain=10 log(2) dB for power spectral density; Array Gain =0 for power measurement).</p>	



### 2.2. OPERATION FREQUENCY EACH OF CHANNEL

802.11a/802.11n(HT20) 802.11ac(HT20)		802.11n(HT40)/ 802.11ac(HT40)		802.11ac(HT80)	
Channel	Frequency	Channel	Frequency	Channel	Frequency
149	5745	151	5755	155	5775
153	5765	159	5790		
157	5785				
161	5805				
165	5825				

**Note:**

In section 15.31(m), regards to the operating frequency range over 10 MHz, the Lowest frequency, the middle frequency, and the highest frequency of channel were selected to perform the test, and the selected channel see below:

### 2.3. OPERATION OF EUT DURING TESTING

Band IV (5725 - 5850 MHz)		
For 802.11a/n (HT20)/ac (HT20)		
Channel Number	Channel	Frequency (MHz)
149	Low	5745
157	Mid	5785
165	High	5825

For 802.11n (HT40)/ac (HT40)		
Channel Number	Channel	Frequency (MHz)
151	Low	5755
159	High	5795

For 802.11ac (HT80)		
Channel Number	Channel	Frequency (MHz)
155	/	5775

The results shown in this test report refer only to the sample(s) tested unless otherwise stated and the sample(s) are retained for 30 days only. The document is issued by HUAK, this document cannot be reproduced except in full with our prior written permission. The more details and the authenticity of the report will be confirmed at <http://www.cer-mark.com>.



## 2.4. DESCRIPTION OF TEST SETUP

Operation of EUT during conducted testing and radiation below 1GHz testing:

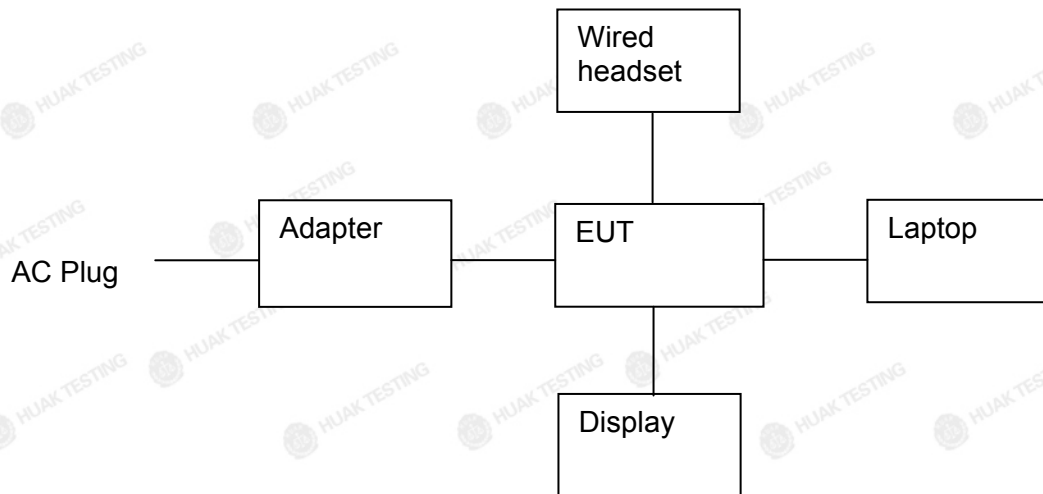

Operation of EUT during radiation above 1GHz testing:

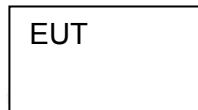

### Laptop information

Model: TP00067A  
Input: DC 20V, 2.25~3.25A  
Output: 5VDC, 0.5A

### Adapter information

Model: GME36E-120300FDR  
Input: 100-240V~50-60Hz 1.2A  
Output: 12V 3A, 36.0W

### Wired headset information

Model: H1

### Display information

Model: 24PFF3661/T3

The sample was placed (0.8m below 1GHz, 1.5m above 1GHz) above the ground plane of 3m chamber. Measurements in both horizontal and vertical polarities were performed. During the test, each emission was maximized by: having the EUT continuously working, investigated all operating modes, rotated about all 3 axis (X, Y & Z) and considered typical configuration to obtain worst position, manipulating interconnecting cables, rotating the turntable, varying antenna height from 1m to 4m in both horizontal and vertical polarizations. The emissions worst-case are shown in Test Results of the following pages. The worst case is X position.



### 3. GENERA INFORMATION

#### 3.1. TEST ENVIRONMENT AND MODE

Operating Environment:	
Temperature:	25.0 °C
Humidity:	56 % RH
Atmospheric Pressure:	1010 mbar
Test Mode:	
Engineering mode:	Keep the EUT in continuous transmitting by select channel and modulations(The value of duty cycle is 100%)
<p>The sample was placed 0.8m/1.5m for blow/above 1GHz above the ground plane of 3m chamber. Measurements in both horizontal and vertical polarities were performed. During the test, each emission was maximized by: having the EUT continuously working, investigated all operating modes, rotated about all 3 axis (X, Y &amp; Z) and considered typical configuration to obtain worst position, manipulating interconnecting cables, rotating the turntable, varying antenna height from 1m to 4m in both horizontal and vertical polarizations. The emissions worst-case are shown in Test Results of the following pages.</p>	

<p>We have verified the construction and function in typical operation. All the test modes were carried out with the EUT in transmitting operation, which was shown in this test report and defined as follows:</p>	
Per-scan all kind of data rate in lowest channel, and found the follow list which it was worst case.	
Mode	Data rate
802.11a	6 Mbps
802.11n(HT20)	MCS0
802.11n(HT40)	MCS0
802.11ac(HT20)/ac(HT40)/ac(HT80)	MCS0
Final Test Mode:	
Operation mode:	Keep the EUT in continuous transmitting with modulation

The results shown in this test report refer only to the sample(s) tested unless otherwise stated and the sample(s) are retained for 30 days only. The document is issued by HUAKE, this document cannot be reproduced except in full with our prior written permission. The more details and the authenticity of the report will be confirmed at <http://www.cer-mark.com>.



### 3.2. DESCRIPTION OF SUPPORT UNITS

The EUT has been tested as an independent unit together with other necessary accessories or support units. The following support units or accessories were used to form a representative test configuration during the tests.

Equipment	Model No.	Serial No.	FCC ID	Trade Name
/	/	/	/	/

**Note:**

1. All the equipment/cables were placed in the worst-case configuration to maximize the emission during the test.
2. Grounding was established in accordance with the manufacturer's requirements and conditions for the intended use.
3. For conducted measurements (Output Power, Emission Bandwidth, Power Spectral Density, Spurious Emissions), the antenna of EUT is connected to the test equipment via temporary antenna connector, the antenna connector is soldered on the antenna port of EUT, and the temporary antenna connector is listed in the Test Instruments.



### 4. TEST RESULTS AND MEASUREMENT DATA

#### 4.1. CONDUCTED EMISSION

##### 4.1.1. Test Specification

<b>Test Requirement:</b>	FCC Part15 C Section 15.207														
<b>Test Method:</b>	ANSI C63.10:2013														
<b>Frequency Range:</b>	150 kHz to 30 MHz														
<b>Receiver setup:</b>	RBW=9 kHz, VBW=30 kHz, Sweep time=auto														
<b>Limits:</b>	<table border="1"> <thead> <tr> <th rowspan="2">Frequency range (MHz)</th> <th colspan="2">Limit (dBuV)</th> </tr> <tr> <th>Quasi-peak</th> <th>Average</th> </tr> </thead> <tbody> <tr> <td>0.15-0.5</td> <td>66 to 56*</td> <td>56 to 46*</td> </tr> <tr> <td>0.5-5</td> <td>56</td> <td>46</td> </tr> <tr> <td>5-30</td> <td>60</td> <td>50</td> </tr> </tbody> </table>	Frequency range (MHz)	Limit (dBuV)		Quasi-peak	Average	0.15-0.5	66 to 56*	56 to 46*	0.5-5	56	46	5-30	60	50
	Frequency range (MHz)		Limit (dBuV)												
		Quasi-peak	Average												
	0.15-0.5	66 to 56*	56 to 46*												
0.5-5	56	46													
5-30	60	50													
<b>Test Setup:</b>	<p><i>Remark</i>  E.U.T: Equipment Under Test  LISN: Line Impedance Stabilization Network  Test table height=0.8m</p>														
<b>Test Mode:</b>	TX Mode														
<b>Test Procedure:</b>	<ol style="list-style-type: none"> <li>1. The E.U.T and simulators are connected to the main power through a line impedance stabilization network (L.I.S.N.). This provides a 50ohm/50uH coupling impedance for the measuring equipment.</li> <li>2. The peripheral devices are also connected to the main power through a LISN that provides a 50ohm/50uH coupling impedance with 50ohm termination. (Please refer to the block diagram of the test setup and photographs).</li> <li>3. Both sides of A.C. line are checked for maximum conducted interference. In order to find the maximum emission, the relative positions of equipment and all of the interface cables must be changed according to ANSI C63.10: 2013 on conducted measurement.</li> </ol>														
<b>Test Result:</b>	PASS														

The results shown in this test report refer only to the sample(s) tested unless otherwise stated and the sample(s) are retained for 30 days only. The document is issued by HUAK, this document cannot be reproduced except in full with our prior written permission. The more details and the authenticity of the report will be confirmed at <http://www.cer-mark.com>.



4.1.2. Test Instruments

Conducted Emission Shielding Room Test Site (843)					
Equipment	Manufacturer	Model	Serial Number	Calibration Date	Calibration Due
Receiver	R&S	ESCI 7	HKE-010	Dec. 09, 2021	Dec. 08, 2022
LISN	R&S	ENV216	HKE-002	Dec. 09, 2021	Dec. 08, 2022
Coax cable (9KHz-30MHz)	Times	381806-002	N/A	Dec. 09, 2021	Dec. 08, 2022
Conducted test software	Tonscend	TS+ Rev 2.5.0.0	HKE-081	N/A	N/A

**Note:** The calibration interval of the above test instruments is 12 months and the calibrations are traceable to international system unit (SI).



4.1.3. Test data

All the test modes completed for test. only the worst result was reported as below:

Conducted Emission on Line Terminal of the power line (150 kHz to 30MHz)

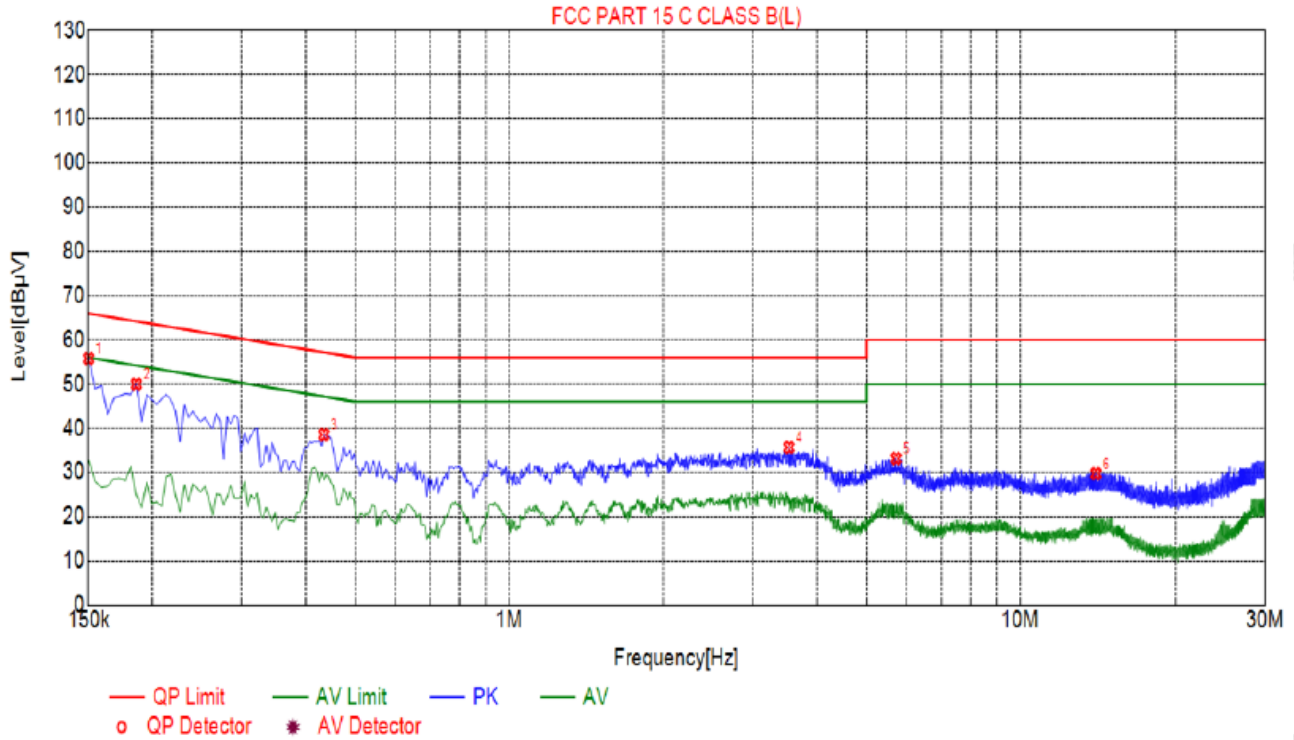

Suspected List								
NO.	Freq. [MHz]	Level [dBµV]	Factor [dB]	Limit [dBµV]	Margin [dB]	Reading [dBµV]	Detector	Type
1	0.1500	55.79	20.03	66.00	10.21	35.76	PK	L
2	0.1860	49.98	20.05	64.21	14.23	29.93	PK	L
3	0.4335	38.55	20.05	57.19	18.64	18.50	PK	L
4	3.5295	35.66	20.25	56.00	20.34	15.41	PK	L
5	5.7210	33.13	20.24	60.00	26.87	12.89	PK	L
6	13.9695	29.72	19.96	60.00	30.28	9.76	PK	L

Remark: Margin = Limit – Level  
 Correction factor = Cable lose + LISN insertion loss  
 Level=Test receiver reading + correction factor

The results shown in this test report refer only to the sample(s) tested unless otherwise stated and the sample(s) are retained for 30 days only. The document is issued by HUAKE, this document cannot be reproduced except in full with our prior written permission. The more details and the authenticity of the report will be confirmed at <http://www.cer-mark.com>.



Conducted Emission on Neutral Terminal of the power line (150 kHz to 30MHz)

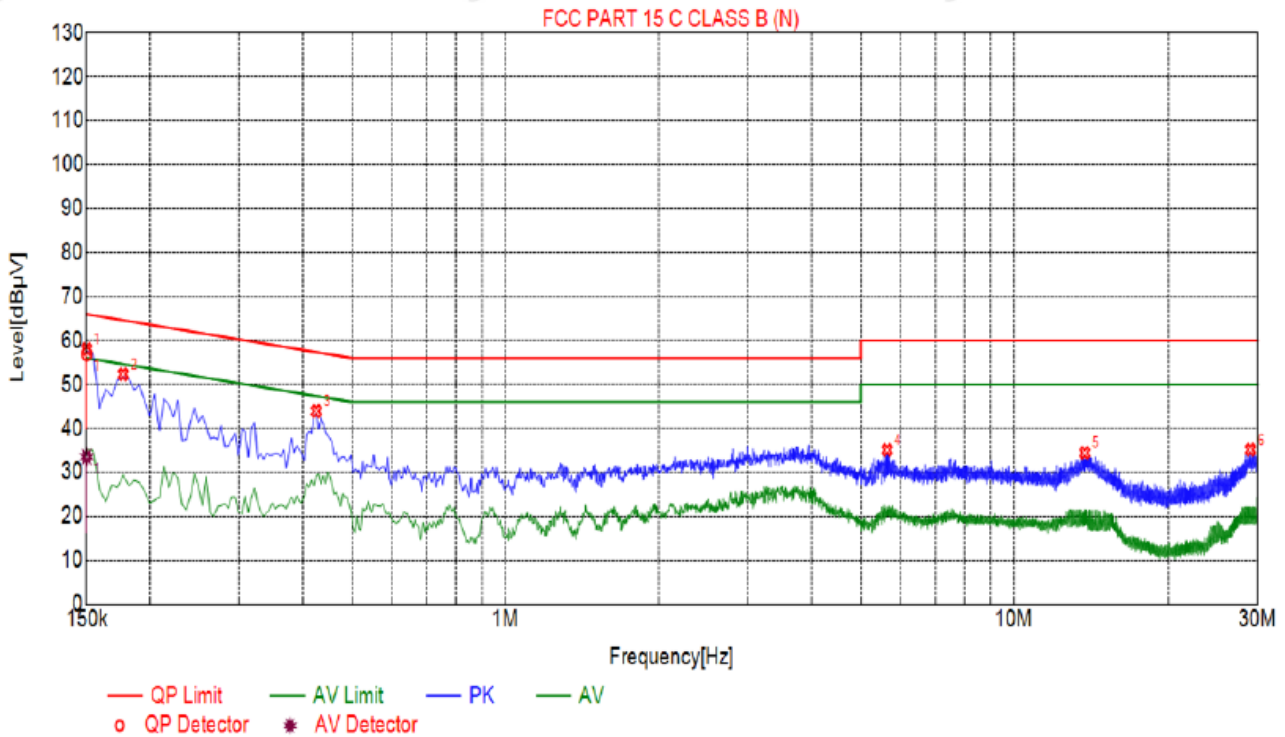

Suspected List									
NO.	Freq. [MHz]	Level [dBµV]	Factor [dB]	Limit [dBµV]	Margin [dB]	Reading [dBµV]	Detector	Type	
1	0.1500	58.08	20.03	66.00	7.92	38.05	PK	N	
2	0.1770	52.30	20.05	64.63	12.33	32.25	PK	N	
3	0.4245	43.93	20.04	57.36	13.43	23.89	PK	N	
4	5.6400	35.08	20.25	60.00	24.92	14.83	PK	N	
5	13.6950	34.41	19.96	60.00	25.59	14.45	PK	N	
6	29.0220	35.14	20.26	60.00	24.86	14.88	PK	N	

Final Data List											
NO.	Freq. [MHz]	Correction factor [dB]	QP Value [dBµV]	QP Limit [dBµV]	QP Margin [dB]	QP Reading [dBµV]	AV Value [dBµV]	AV Limit [dBµV]	AV Margin [dB]	AV Reading [dBµV]	Type
1	0.1500	20.03	56.95	66.00	9.05	36.92	33.51	56.00	22.49	13.48	N

Remark: Margin = Limit – Level  
 Correction factor = Cable lose + LISN insertion loss  
 Level=Test receiver reading + correction factor

The results shown in this test report refer only to the sample(s) tested unless otherwise stated and the sample(s) are retained for 30 days only. The document is issued by HUAKE, this document cannot be reproduced except in full with our prior written permission. The more details and the authenticity of the report will be confirmed at <http://www.cer-mark.com>.

## 4.2. MAXIMUM CONDUCTED OUTPUT POWER

### 4.2.1. Test Specification

<b>Test Requirement:</b>	FCC Part15 E Section 15.407(a)				
<b>Test Method:</b>	KDB789033 D02 General UNII Test Procedures New Rules v02.r01 Section E				
<b>Limit:</b>	<table border="1"> <thead> <tr> <th>Frequency Band (MHz)</th> <th>Limit</th> </tr> </thead> <tbody> <tr> <td>5725-5850</td> <td>1 W</td> </tr> </tbody> </table>	Frequency Band (MHz)	Limit	5725-5850	1 W
	Frequency Band (MHz)	Limit			
5725-5850	1 W				
<b>Test Setup:</b>	<p>The diagram illustrates the test setup. On the left is a green rectangular box labeled 'Power meter'. A cable connects it to a small white square labeled 'Attenuator'. Another cable connects the attenuator to a yellow rectangular box labeled 'EUT'.</p>				
<b>Test Mode:</b>	Transmitting mode with modulation				
<b>Test Procedure:</b>	<ol style="list-style-type: none"> <li>1. The testing follows the Measurement Procedure of KDB789033 D02 General UNII Test Procedures New Rules v02r01 Section E, 3, a.</li> <li>2. The RF output of EUT was connected to the power meter by RF cable and attenuator. The path loss was compensated to the results for each measurement.</li> <li>3. Set to the maximum power setting and enable the EUT transmit continuously.</li> <li>4. Measure the conducted output power and record the results in the test report.</li> </ol>				
<b>Test Result:</b>	PASS				
<b>Remark:</b>	<p>Conducted output power= measurement power +10log(1/x) X is duty cycle=1, so 10log(1/1)=0</p> <p>Conducted output power= measurement power</p>				





4.2.2. Test Instruments

RF Test Room					
Equipment	Manufacturer	Model	Serial Number	Calibration Date	Calibration Due
Spectrum analyzer	Agilent	N9020A	HKE-048	Dec. 09, 2021	Dec. 08, 2022
Power meter	Agilent	E4419B	HKE-085	Dec. 09, 2021	Dec. 08, 2022
Power Sensor	Agilent	E9300A	HKE-086	Dec. 09, 2021	Dec. 08, 2022
RF cable	Times	1-40G	HKE-034	Dec. 09, 2021	Dec. 08, 2022
RF automatic control unit	Tonscend	JS0806-2	HKE-060	Dec. 09, 2021	Dec. 08, 2022

**Note:** The calibration interval of the above test instruments is 12 months and the calibrations are traceable to international system unit (SI).



4.2.3. Test Data

Configuration Band IV (5725 - 5850 MHz )					
Mode	Test channel	Maximum Conducted Output Power (dBm)		FCC Limit (dBm)	Result
		Antenna port 1	Antenna port 2		
11a	CH149	13.63	13.06	30	PASS
11a	CH157	12.80	13.27	30	PASS
11a	CH165	13.10	14.31	30	PASS
11n(HT20)	CH149	12.66	13.12	30	PASS
11n(HT20)	CH157	12.85	14.13	30	PASS
11n(HT20)	CH165	13.12	14.14	30	PASS
11n(HT40)	CH151	12.94	13.22	30	PASS
11n(HT40)	CH159	13.00	13.40	30	PASS
11ac(HT20)	CH149	12.70	12.97	30	PASS
11ac(HT20)	CH157	12.83	13.15	30	PASS
11ac(HT20)	CH165	13.13	14.04	30	PASS
11ac(HT40)	CH151	12.88	13.06	30	PASS
11ac(HT40)	CH159	12.95	13.25	30	PASS
11ac(HT80)	CH155	13.20	13.33	30	PASS

Configuration Band IV (5725 - 5850 MHz )					
Mode	Test channel	Maximum Conducted Output Power (dBm)		FCC Limit (dBm)	Result
		MIMO			
11n(HT20)	CH149	15.91		30	PASS
11n(HT20)	CH157	16.55		30	PASS
11n(HT20)	CH165	16.67		30	PASS
11n(HT40)	CH151	16.09		30	PASS
11n(HT40)	CH159	16.21		30	PASS
11ac(HT20)	CH149	15.85		30	PASS
11ac(HT20)	CH157	16.00		30	PASS
11ac(HT20)	CH165	16.62		30	PASS
11ac(HT40)	CH151	15.98		30	PASS
11ac(HT40)	CH159	16.11		30	PASS
11ac(HT80)	CH155	16.28		30	PASS

The results shown in this test report refer only to the sample(s) tested unless otherwise stated and the sample(s) are retained for 30 days only. The document is issued by HUAKE, this document cannot be reproduced except in full with our prior written permission. The more details and the authenticity of the report will be confirmed at <http://www.cer-mark.com>.

### 4.3. 6DB EMISSION BANDWIDTH

#### 4.3.1. Test Specification

<b>Test Requirement:</b>	FCC CFR47 Part 15 Section 15.407(e)
<b>Test Method:</b>	KDB789033 D02 General UNII Test Procedures New Rules v01r04 Section C
<b>Limit:</b>	>500kHz
<b>Test Setup:</b>	 <p style="text-align: center;">Spectrum Analyzer                      EUT</p>
<b>Test Mode:</b>	Transmitting mode with modulation
<b>Test Procedure:</b>	<ol style="list-style-type: none"> <li>1. KDB789033 D02 General UNII Test Procedures New Rules v01r04 Section C.</li> <li>2. Set to the maximum power setting and enable the EUT transmit continuously.</li> <li>3. Make the measurement with the spectrum analyzer's resolution bandwidth (RBW) = 100 kHz. Set the Video bandwidth (VBW) = 300 kHz. In order to make an accurate measurement. The 6dB bandwidth must be greater than 500 kHz.</li> <li>4. Measure and record the results in the test report.</li> </ol>
<b>Test Result:</b>	PASS

#### 4.3.2. Test Instruments

RF Test Room					
Equipment	Manufacturer	Model	Serial Number	Calibration Date	Calibration Due
Spectrum analyzer	Agilent	N9020A	HKE-048	Dec. 09, 2021	Dec. 08, 2022
RF cable	Times	1-40G	HKE-034	Dec. 09, 2021	Dec. 08, 2022
RF automatic control unit	Tonscend	JS0806-2	HKE-060	Dec. 09, 2021	Dec. 08, 2022

**Note:** The calibration interval of the above test instruments is 12 months and the calibrations are traceable to international system unit (SI).



4.3.3. Test data

ANT 1

Band IV (5725 - 5850 MHz )					
Mode	Test channel	Frequency (MHz)	6 dB Bandwidth (MHz)	Limit (MHz)	Result
11a	CH149	5745	16.40	0.5	PASS
11a	CH157	5785	16.36	0.5	PASS
11a	CH165	5825	16.40	0.5	PASS
11n(HT20)	CH149	5745	17.60	0.5	PASS
11n(HT20)	CH157	5785	17.60	0.5	PASS
11n(HT20)	CH165	5825	17.60	0.5	PASS
11n(HT40)	CH151	5755	36.40	0.5	PASS
11n(HT40)	CH159	5795	36.40	0.5	PASS
11ac(HT20)	CH149	5745	17.60	0.5	PASS
11ac(HT20)	CH157	5785	17.60	0.5	PASS
11ac(HT20)	CH165	5825	17.60	0.5	PASS
11ac(HT40)	CH151	5755	36.32	0.5	PASS
11ac(HT40)	CH159	5795	36.40	0.5	PASS
11ac(HT80)	CH155	5775	75.68	0.5	PASS

Test plots as follows:



Band IV (5725 – 5850 MHz)

802.11a

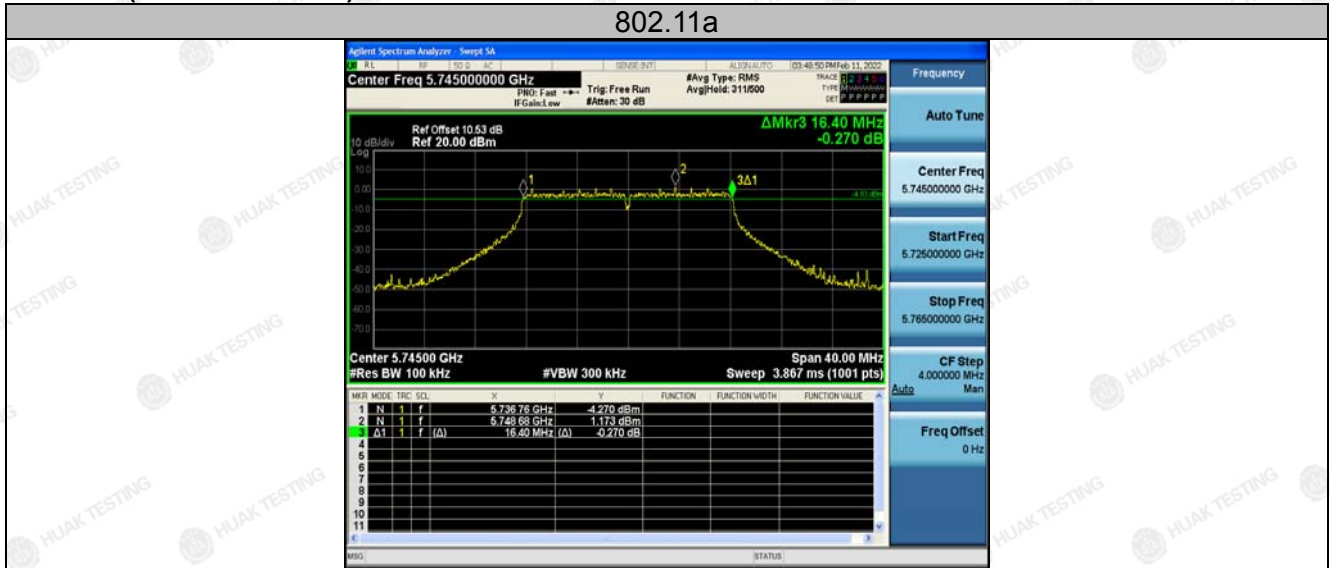

Low



Mid



High

The results shown in this test report refer only to the sample(s) tested unless otherwise stated and the sample(s) are retained for 30 days only. The document is issued by HUAJ, this document cannot be reproduced except in full with our prior written permission. The more details and the authenticity of the report will be confirmed at <http://www.cer-mark.com>.



802.11n(HT20)



Low



Mid

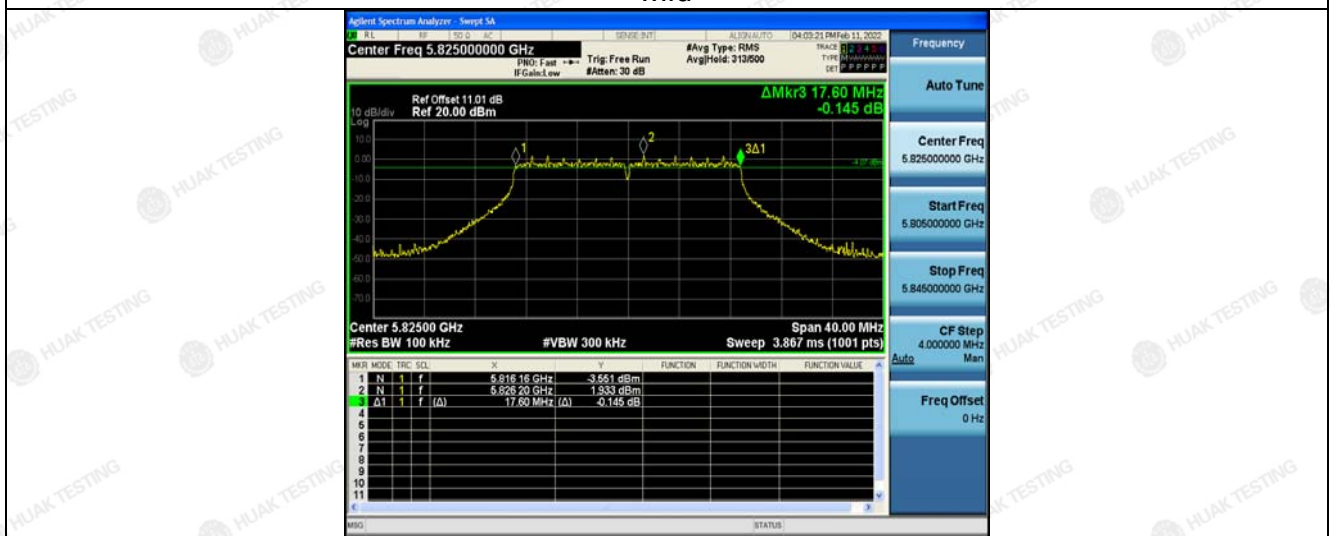

High

The results shown in this test report refer only to the sample(s) tested unless otherwise stated and the sample(s) are retained for 30 days only. The document is issued by HUAJ, this document cannot be reproduced except in full with our prior written permission. The more details and the authenticity of the report will be confirmed at <http://www.cer-mark.com>.



802.11n(HT40)

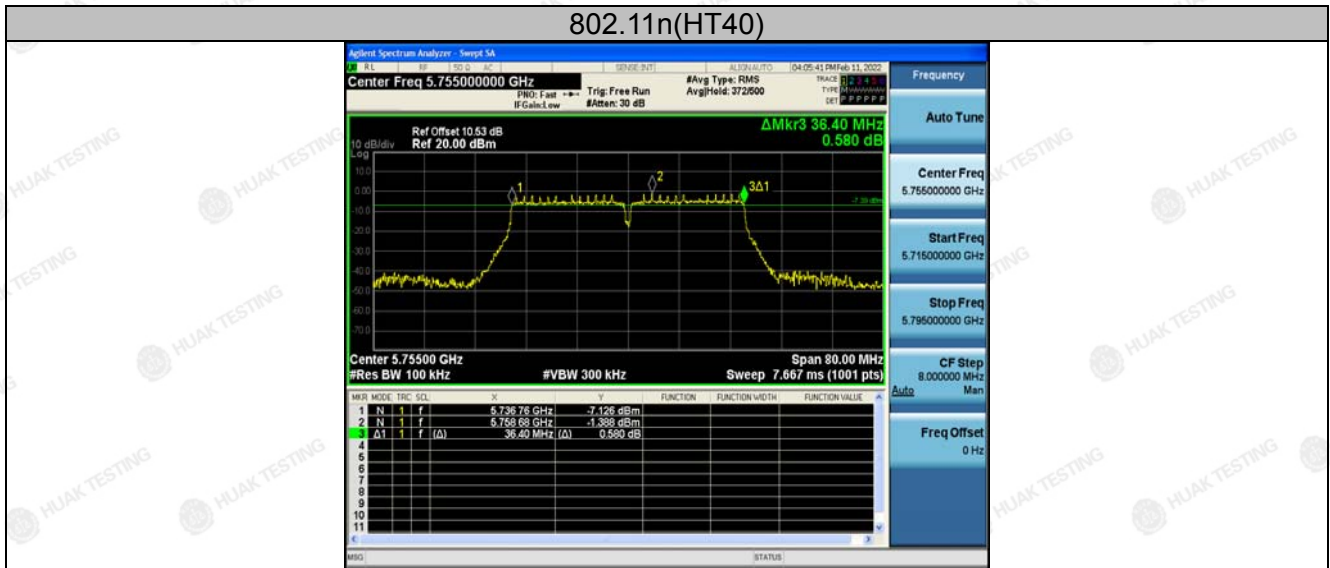

Low

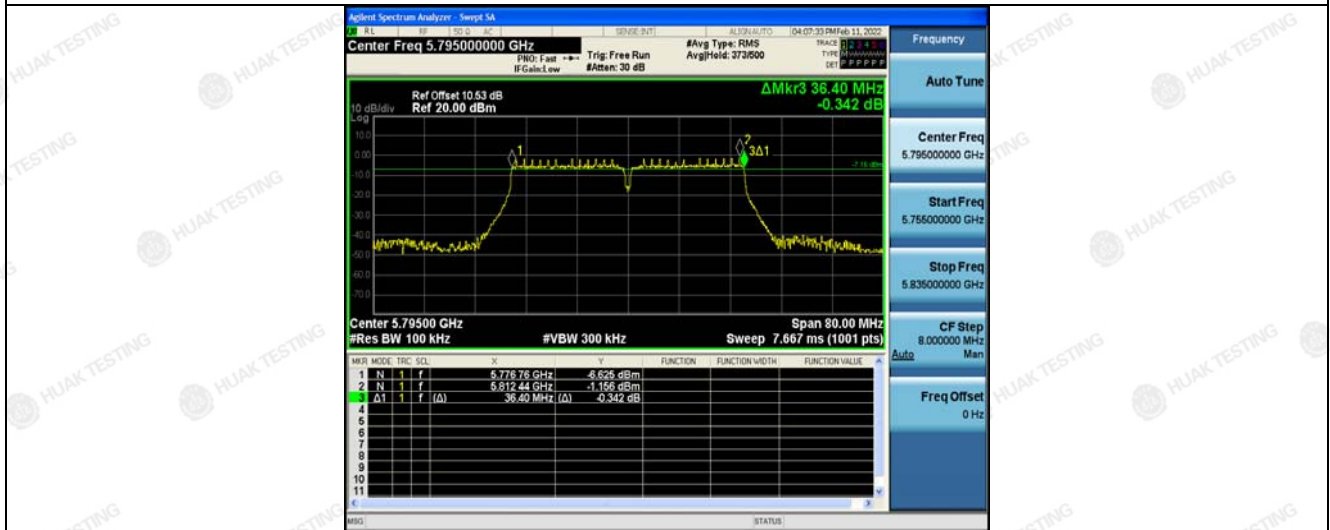

High

802.11ac(HT20)



Low

The results shown in this test report refer only to the sample(s) tested unless otherwise stated and the sample(s) are retained for 30 days only. The document is issued by HUAJ, this document cannot be reproduced except in full with our prior written permission. The more details and the authenticity of the report will be confirmed at <http://www.cer-mark.com>.



Mid



High

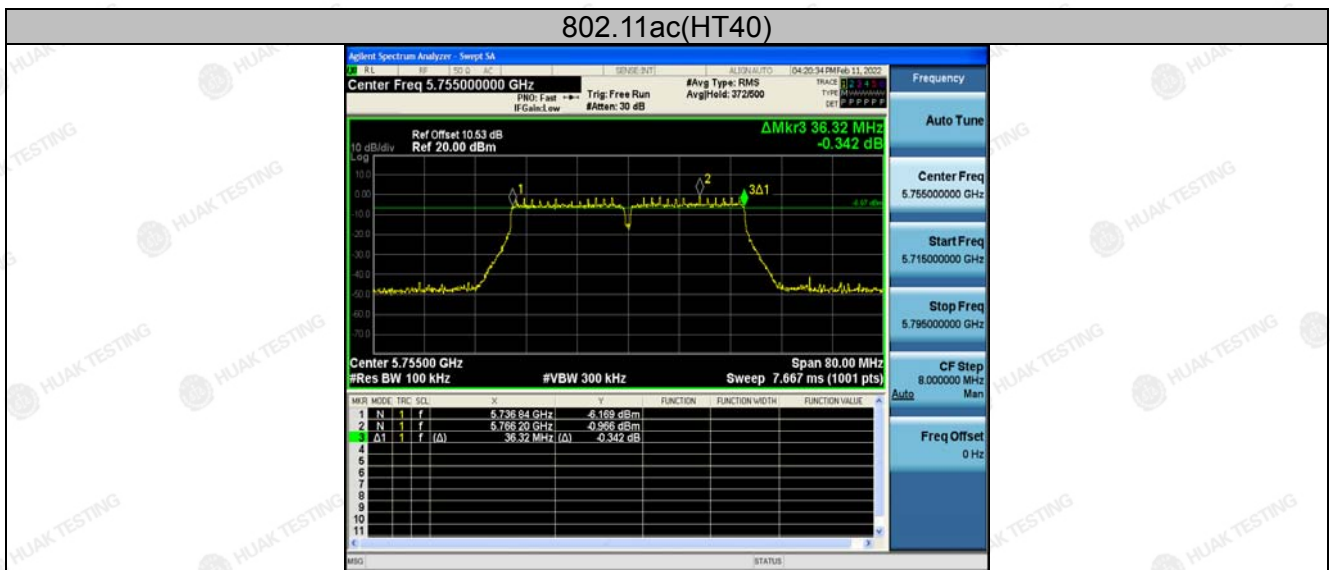

Low

The results shown in this test report refer only to the sample(s) tested unless otherwise stated and the sample(s) are retained for 30 days only. The document is issued by HUAJ, this document cannot be reproduced except in full with our prior written permission. The more details and the authenticity of the report will be confirmed at <http://www.cer-mark.com>.



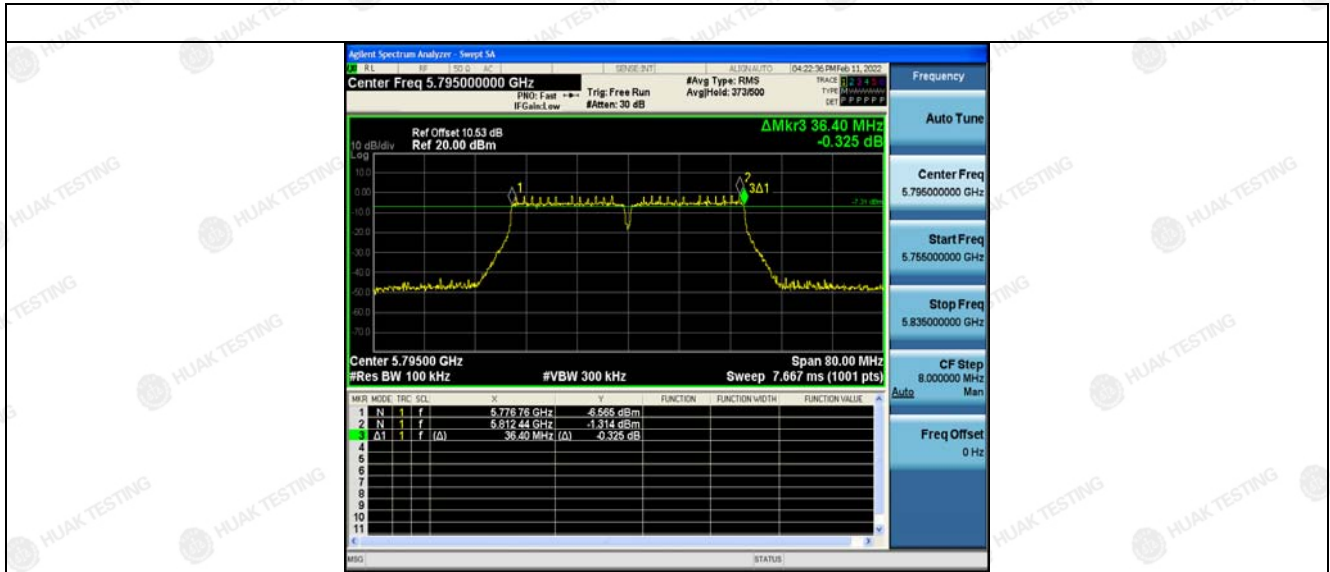

High



802.11ac(HT80)

The results shown in this test report refer only to the sample(s) tested unless otherwise stated and the sample(s) are retained for 30 days only. The document is issued by HUAJ, this document cannot be reproduced except in full with our prior written permission. The more details and the authenticity of the report will be confirmed at <http://www.cer-mark.com>.



ANT 2

Band IV (5725 - 5850 MHz )					
Mode	Test channel	Frequency (MHz)	6 dB Bandwidth (MHz)	Limit (MHz)	Result
11a	CH149	5745	16.36	0.5	PASS
11a	CH157	5785	16.36	0.5	PASS
11a	CH161	5825	16.36	0.5	PASS
11n(HT20)	CH149	5745	17.60	0.5	PASS
11n(HT20)	CH157	5785	17.64	0.5	PASS
11n(HT20)	CH161	5825	17.60	0.5	PASS
11n(HT40)	CH151	5755	36.32	0.5	PASS
11n(HT40)	CH159	5795	36.40	0.5	PASS
11ac(HT20)	CH149	5745	17.60	0.5	PASS
11ac(HT20)	CH157	5785	17.60	0.5	PASS
11ac(HT20)	CH165	5825	17.60	0.5	PASS
11ac(HT40)	CH151	5755	36.32	0.5	PASS
11ac(HT40)	CH159	5795	36.40	0.5	PASS
11ac(HT80)	CH155	5775	76.00	0.5	PASS

Test plots as follows:



Band IV (5725 – 5850 MHz)

802.11a

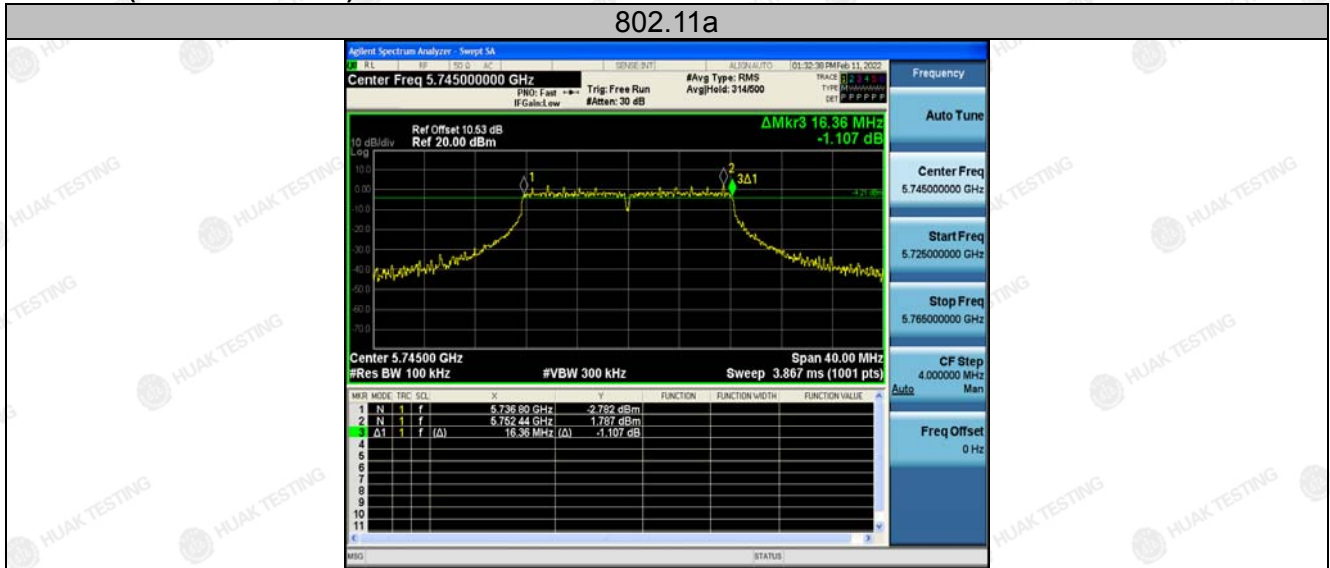

Low



Mid



High

The results shown in this test report refer only to the sample(s) tested unless otherwise stated and the sample(s) are retained for 30 days only. The document is issued by HUAJ, this document cannot be reproduced except in full with our prior written permission. The more details and the authenticity of the report will be confirmed at <http://www.cer-mark.com>.



802.11n(HT20)

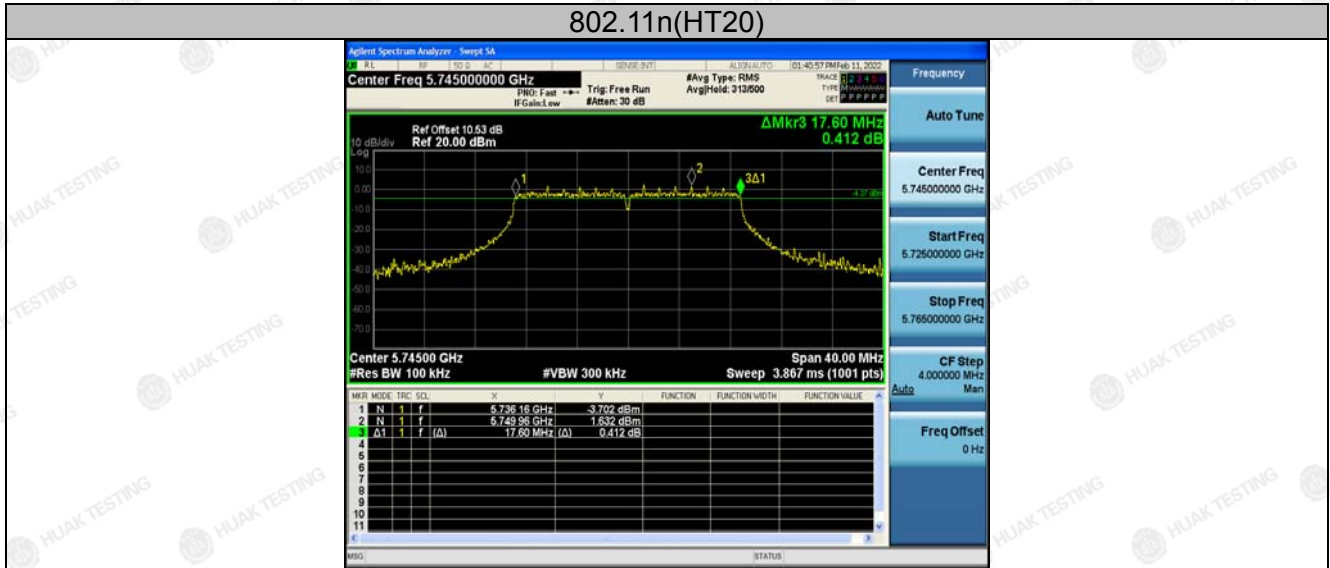

Low



Mid



High

The results shown in this test report refer only to the sample(s) tested unless otherwise stated and the sample(s) are retained for 30 days only. The document is issued by HUAJ, this document cannot be reproduced except in full with our prior written permission. The more details and the authenticity of the report will be confirmed at <http://www.cer-mark.com>.



802.11n(HT40)

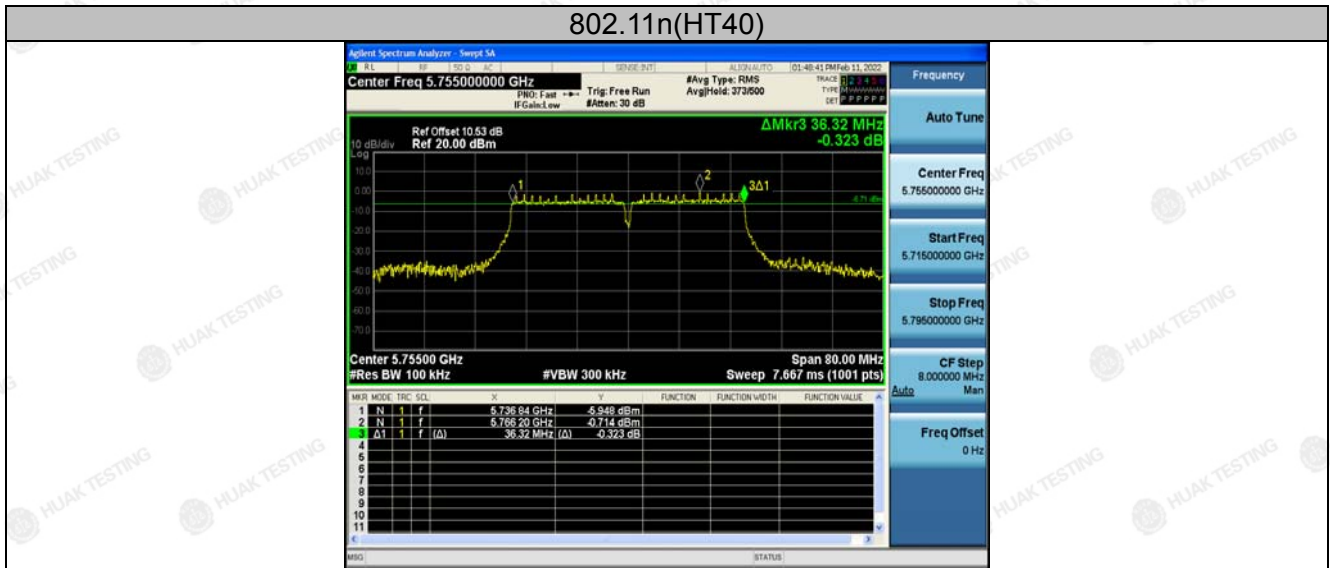

Low



High

802.11ac(HT20)



Low

The results shown in this test report refer only to the sample(s) tested unless otherwise stated and the sample(s) are retained for 30 days only. The document is issued by HUAK, this document cannot be reproduced except in full with our prior written permission. The more details and the authenticity of the report will be confirmed at <http://www.cer-mark.com>.



Mid



High

802.11ac(HT40)



Low

The results shown in this test report refer only to the sample(s) tested unless otherwise stated and the sample(s) are retained for 30 days only. The document is issued by HUAKE, this document cannot be reproduced except in full with our prior written permission. The more details and the authenticity of the report will be confirmed at <http://www.cer-mark.com>.

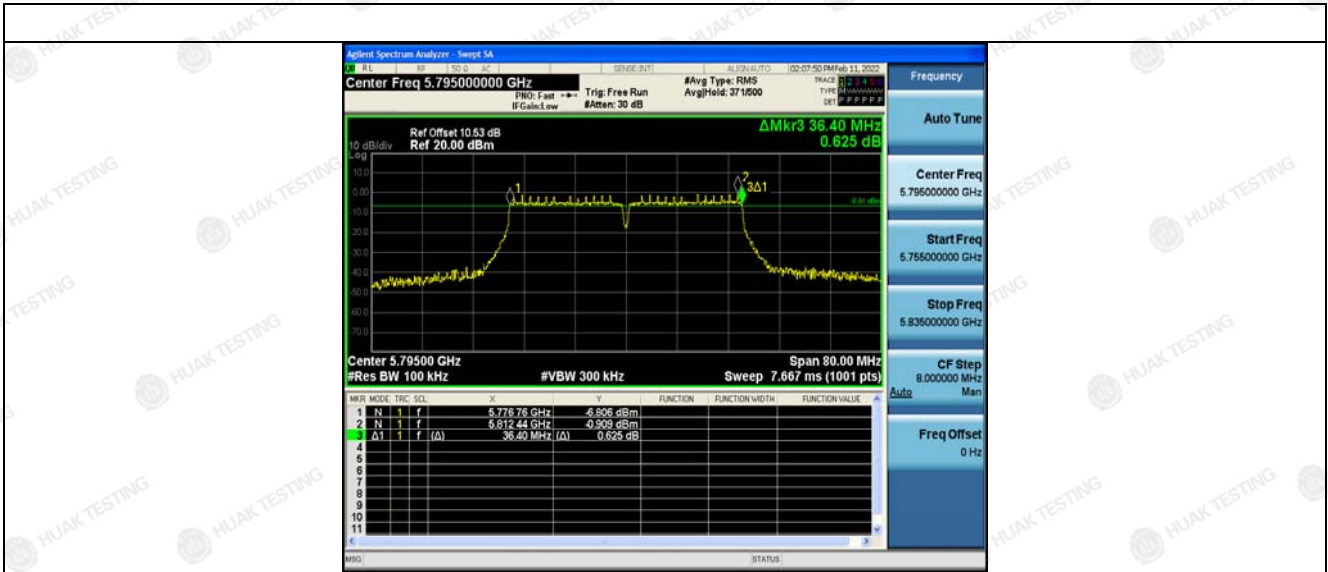

High  
802.11ac(HT80)



The results shown in this test report refer only to the sample(s) tested unless otherwise stated and the sample(s) are retained for 30 days only. The document is issued by HUAJAK, this document cannot be reproduced except in full with our prior written permission. The more details and the authenticity of the report will be confirmed at <http://www.cer-mark.com>.

### 4.4. 26DB BANDWIDTH AND 99% OCCUPIED BANDWIDTH

#### 4.4.1. Test Specification

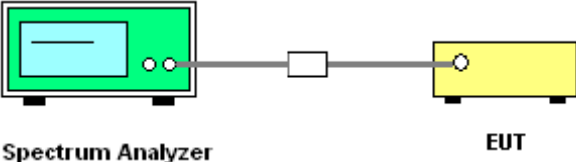
<b>Test Requirement:</b>	47 CFR Part 15C Section 15.407 (a)
<b>Test Method:</b>	KDB789033 D02 General UNII Test Procedures New Rules v02r01 Section C
<b>Limit:</b>	No restriction limits
<b>Test Setup:</b>	 <p style="text-align: center;">Spectrum Analyzer                      EUT</p>
<b>Test Mode:</b>	Transmitting mode with modulation
<b>Test Procedure:</b>	<ol style="list-style-type: none"> <li>1. KDB789033 D02 General UNII Test Procedures New Rules v02r01 Section C.</li> <li>2. Set to the maximum power setting and enable the EUT transmit continuously.</li> <li>3. Make the measurement with the spectrum analyzer's resolution bandwidth <math>RBW = 1\% EBW</math>, <math>VBW \geq 3RBW</math>, In order to make an accurate measurement.</li> <li>4. Measure and record the results in the test report.</li> </ol>
<b>Test Result:</b>	N/A

#### 4.4.2. Test Instruments

RF Test Room					
Equipment	Manufacturer	Model	Serial Number	Calibration Date	Calibration Due
Spectrum analyzer	Agilent	N9020A	HKE-048	Dec. 09, 2021	Dec. 08, 2022
RF cable	Times	1-40G	HKE-034	Dec. 09, 2021	Dec. 08, 2022
RF automatic control unit	Tonscend	JS0806-2	HKE-060	Dec. 09, 2021	Dec. 08, 2022

**Note:** The calibration interval of the above test instruments is 12 months and the calibrations are traceable to international system unit (SI).

#### 4.4.3. Test Result

N/A



## 4.5. POWER SPECTRAL DENSITY

### 4.5.1. Test Specification

<b>Test Requirement:</b>	FCC Part15 E Section 15.407 (a)
<b>Test Method:</b>	KDB789033 D02 General UNII Test Procedures New Rules v02r01 Section F
<b>Limit:</b>	≤30.00dBm/500KHz for Band IV 5725MHz-5850MHz
<b>Test Setup:</b>	 <p style="text-align: center;">Spectrum Analyzer                      EUT</p>
<b>Test Mode:</b>	Transmitting mode with modulation
<b>Test Procedure:</b>	<ol style="list-style-type: none"> <li>1. Set the spectrum analyzer or EMI receiver span to view the entire emission bandwidth.</li> <li>2. Set RBW = 510KHz, VBW ≥ 3*RBW, Sweep time = Auto, Detector = RMS.</li> <li>3. Allow the sweeps to continue until the trace stabilizes.</li> <li>4. Use the peak marker function to determine the maximum amplitude level.</li> <li>5. The E.I.R.P spectral density used radiated test method. At a test site that has been validated using the procedures of ANSI C63.4 or the latest CISPR 16-1-4 for measurements above 1 GHz, so as to simulate a near free-space environment.</li> </ol>
<b>Test Result:</b>	PASS

### 4.5.2. Test Instruments

RF Test Room					
Equipment	Manufacturer	Model	Serial Number	Calibration Date	Calibration Due
Spectrum analyzer	Agilent	N9020A	HKE-048	Dec. 09, 2021	Dec. 08, 2022
RF cable	Times	1-40G	HKE-034	Dec. 09, 2021	Dec. 08, 2022
RF automatic control unit	Tonscend	JS0806-2	HKE-060	Dec. 09, 2021	Dec. 08, 2022

**Note:** The calibration interval of the above test instruments is 12 months and the calibrations are traceable to international system unit (SI).



4.5.3. Test data

ANT 1

Mode	Test channel	Level [dBm/510kHz]	10log(500/510)	Power Spectral Density(dBm/500kHz)	Limit (dBm/500kHz)	Result
11a	CH149	4.7	-0.086	4.614	30	PASS
11a	CH157	5.14	-0.086	5.054	30	PASS
11a	CH161	5.73	-0.086	5.644	30	PASS
11n(HT20)	CH149	4.44	-0.086	4.354	30	PASS
11n(HT20)	CH157	4.87	-0.086	4.784	30	PASS
11n(HT20)	CH161	5.26	-0.086	5.174	30	PASS
11n(HT40)	CH151	2.19	-0.086	2.104	30	PASS
11n(HT40)	CH159	2.32	-0.086	2.234	30	PASS
11ac(HT20)	CH149	4.47	-0.086	4.384	30	PASS
11ac(HT20)	CH157	5.08	-0.086	4.994	30	PASS
11ac(HT20)	CH161	5.05	-0.086	4.964	30	PASS
11ac(HT40)	CH151	2.46	-0.086	2.374	30	PASS
11ac(HT40)	CH159	2.07	-0.086	1.984	30	PASS
11ac(HT80)	CH155	-0.34	-0.086	-0.426	30	PASS

Note: Power Spectral Density= Level [dBm/510kHz]+ (10log(Limit RBW/Test RBW))

Test plots as follows:



Band IV (5725 – 5850 MHz)

802.11a



Low



Mid



High

The results shown in this test report refer only to the sample(s) tested unless otherwise stated and the sample(s) are retained for 30 days only. The document is issued by HUAKE, this document cannot be reproduced except in full with our prior written permission. The more details and the authenticity of the report will be confirmed at <http://www.cer-mark.com>.



802.11n(HT20)



Low



Mid



High

The results shown in this test report refer only to the sample(s) tested unless otherwise stated and the sample(s) are retained for 30 days only. The document is issued by HUAJ, this document cannot be reproduced except in full with our prior written permission. The more details and the authenticity of the report will be confirmed at <http://www.cer-mark.com>.



802.11n(HT40)



Low

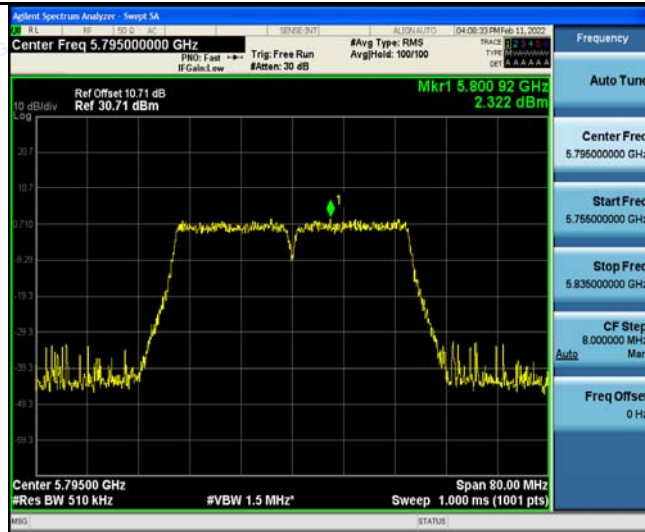

High

802.11ac(HT20)



Low

The results shown in this test report refer only to the sample(s) tested unless otherwise stated and the sample(s) are retained for 30 days only. The document is issued by HUAJ, this document cannot be reproduced except in full with our prior written permission. The more details and the authenticity of the report will be confirmed at <http://www.cer-mark.com>.

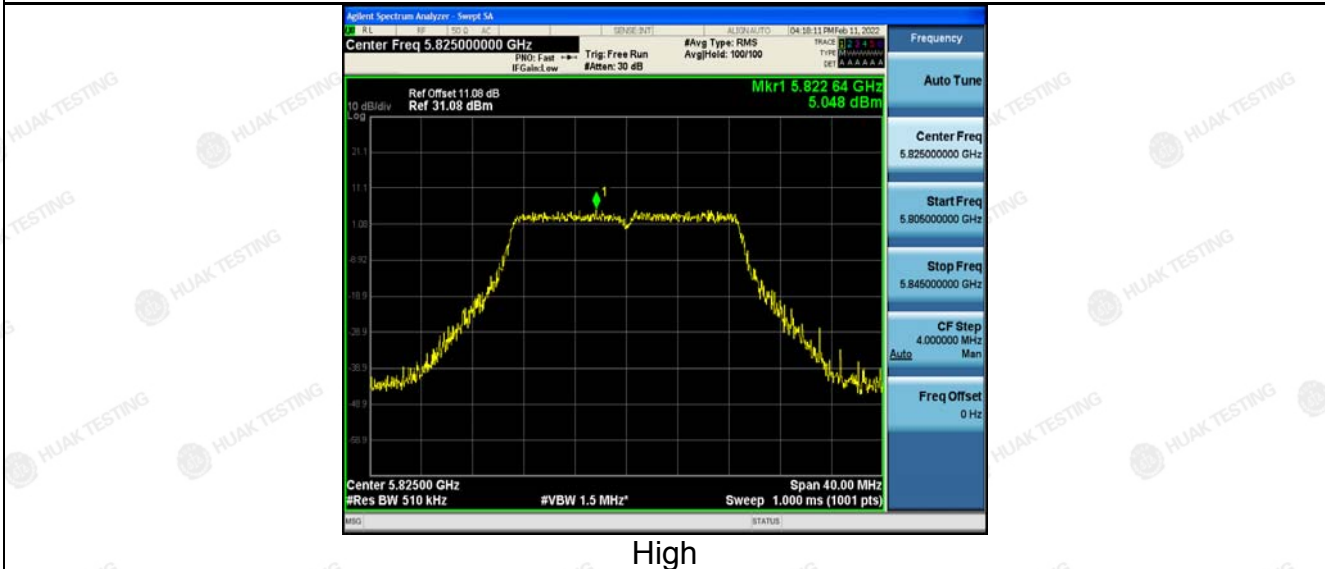
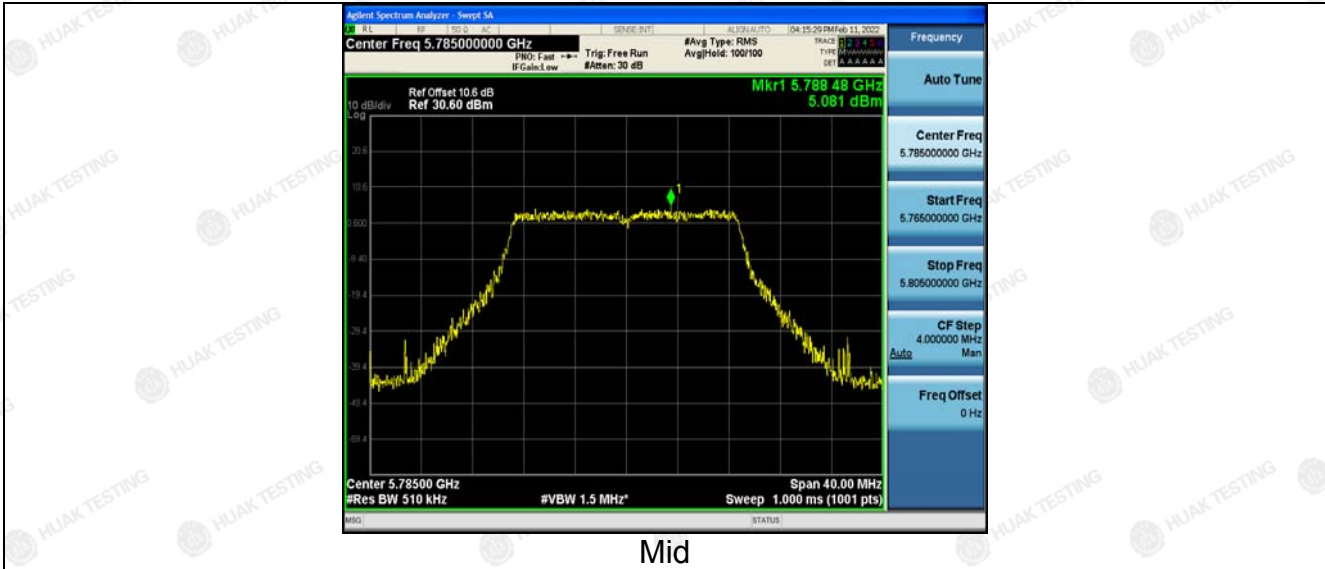

802.11ac(HT40)

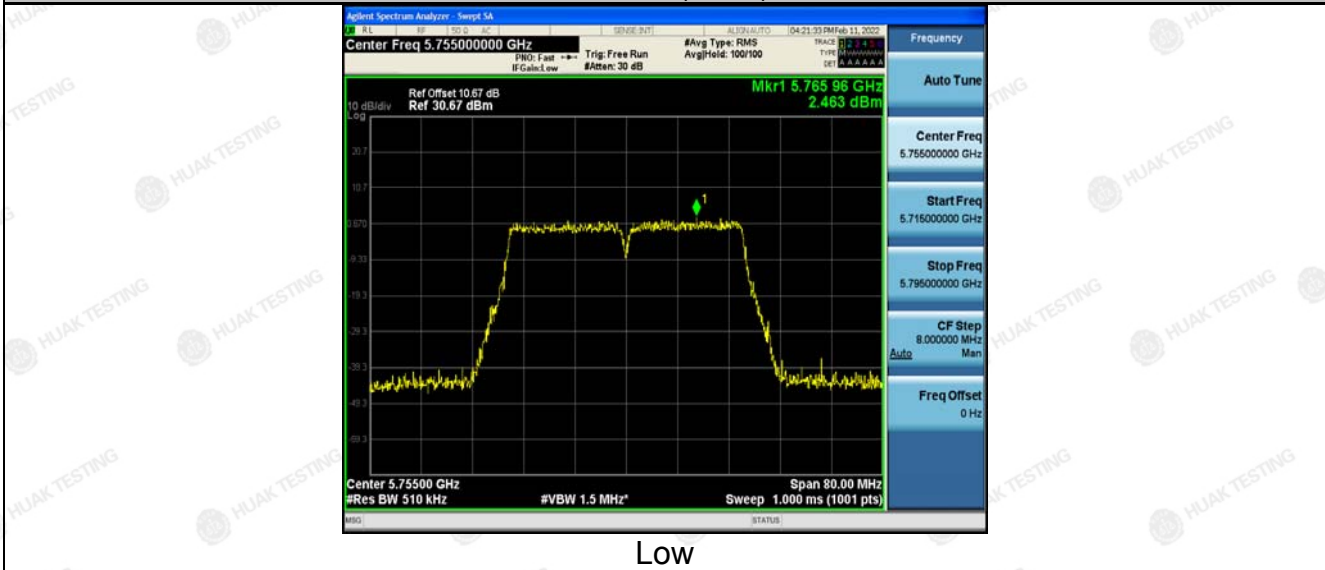

The results shown in this test report refer only to the sample(s) tested unless otherwise stated and the sample(s) are retained for 30 days only. The document is issued by HUAKE, this document cannot be reproduced except in full with our prior written permission. The more details and the authenticity of the report will be confirmed at <http://www.cer-mark.com>.



High  
802.11ac(HT80)



The results shown in this test report refer only to the sample(s) tested unless otherwise stated and the sample(s) are retained for 30 days only. The document is issued by HUAKE, this document cannot be reproduced except in full with our prior written permission. The more details and the authenticity of the report will be confirmed at <http://www.cer-mark.com>.



**ANT 2**

<b>Configuration Band IV (5725 - 5850 MHz )</b>						
Mode	Test channel	Level [dBm/510kHz]	10log(500/510)	Power Spectral Density(dBm/500kHz)	Limit (dBm/500kHz)	Result
11a	CH149	5.4	-0.086	5.314	30	PASS
11a	CH157	5.57	-0.086	5.484	30	PASS
11a	CH161	7.02	-0.086	6.934	30	PASS
11n(HT20)	CH149	5.27	-0.086	5.184	30	PASS
11n(HT20)	CH157	5.87	-0.086	5.784	30	PASS
11n(HT20)	CH161	6.16	-0.086	6.074	30	PASS
11n(HT40)	CH151	2.77	-0.086	2.684	30	PASS
11n(HT40)	CH159	2.77	-0.086	2.684	30	PASS
11ac(HT20)	CH149	4.68	-0.086	4.594	30	PASS
11ac(HT20)	CH157	5.48	-0.086	5.394	30	PASS
11ac(HT20)	CH161	5.91	-0.086	5.824	30	PASS
11ac(HT40)	CH151	2.11	-0.086	2.024	30	PASS
11ac(HT40)	CH159	2.17	-0.086	2.084	30	PASS
11ac(HT80)	CH155	-0.28	-0.086	-0.366	30	PASS

**Note: Power Spectral Density= Level [dBm/510kHz]+ (10log(Limit RBW/Test RBW))**

**Test plots as follows:**





Band IV (5725 – 5850 MHz)

802.11a



Low



Mid



High

The results shown in this test report refer only to the sample(s) tested unless otherwise stated and the sample(s) are retained for 30 days only. The document is issued by HUAJ, this document cannot be reproduced except in full with our prior written permission. The more details and the authenticity of the report will be confirmed at <http://www.cer-mark.com>.



802.11n(HT20)



Low



Mid



High

The results shown in this test report refer only to the sample(s) tested unless otherwise stated and the sample(s) are retained for 30 days only. The document is issued by HUAKE, this document cannot be reproduced except in full with our prior written permission. The more details and the authenticity of the report will be confirmed at <http://www.cer-mark.com>.



802.11n(HT40)



Low



High

802.11ac(HT20)



Low

The results shown in this test report refer only to the sample(s) tested unless otherwise stated and the sample(s) are retained for 30 days only. The document is issued by HUAJ, this document cannot be reproduced except in full with our prior written permission. The more details and the authenticity of the report will be confirmed at <http://www.cer-mark.com>.

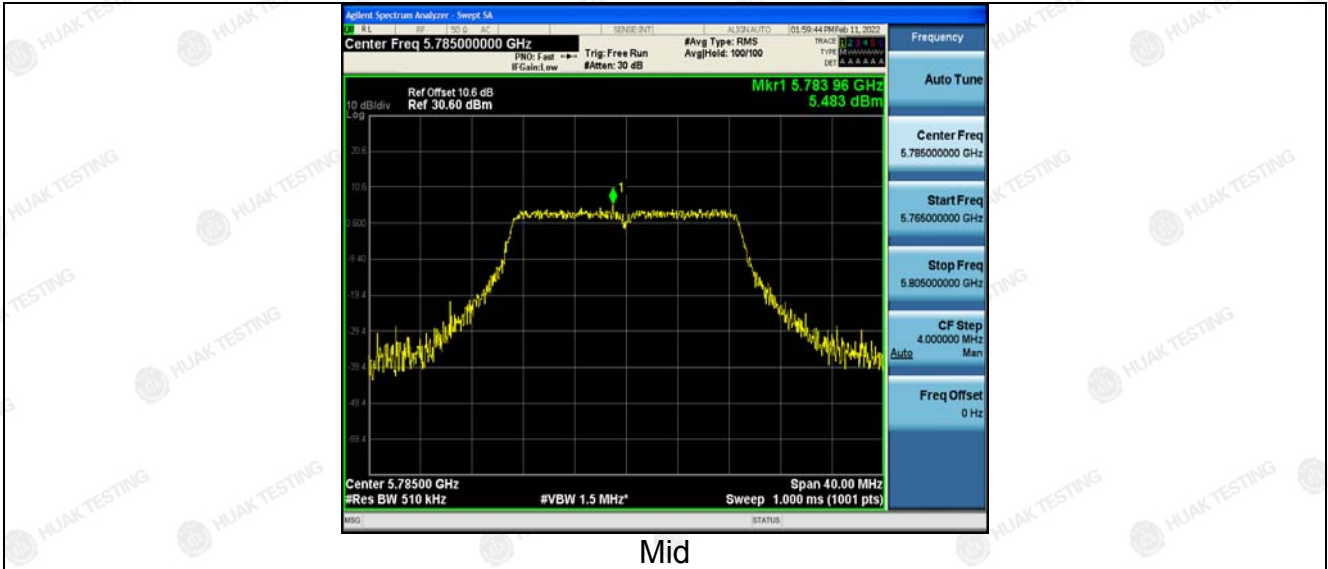

Mid

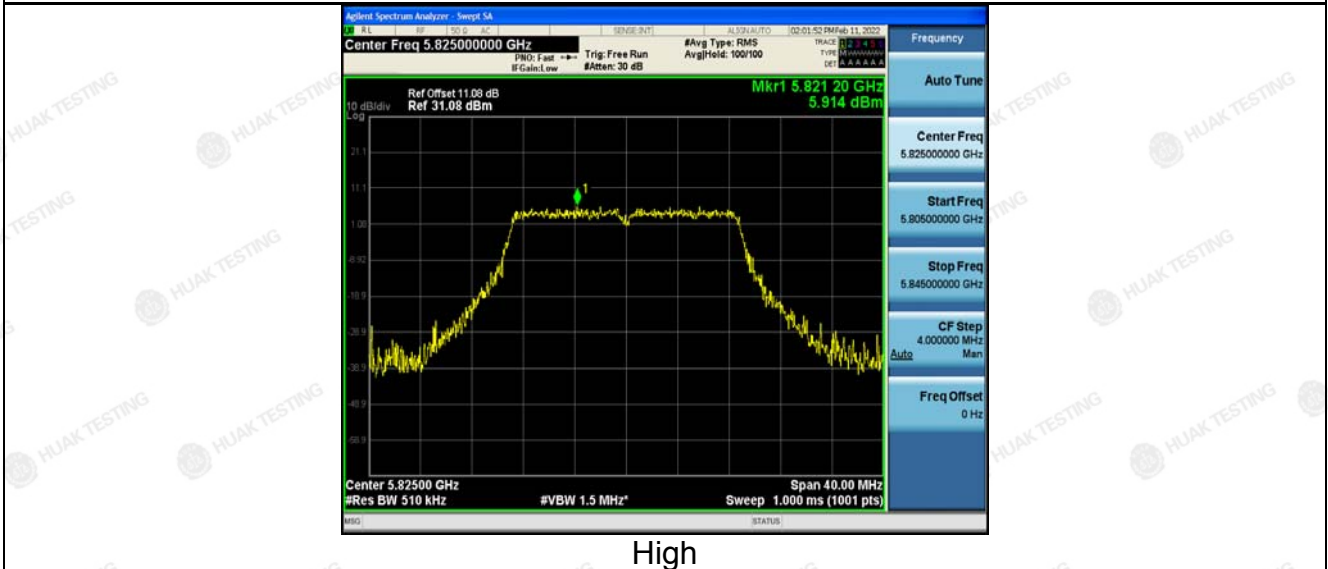

High

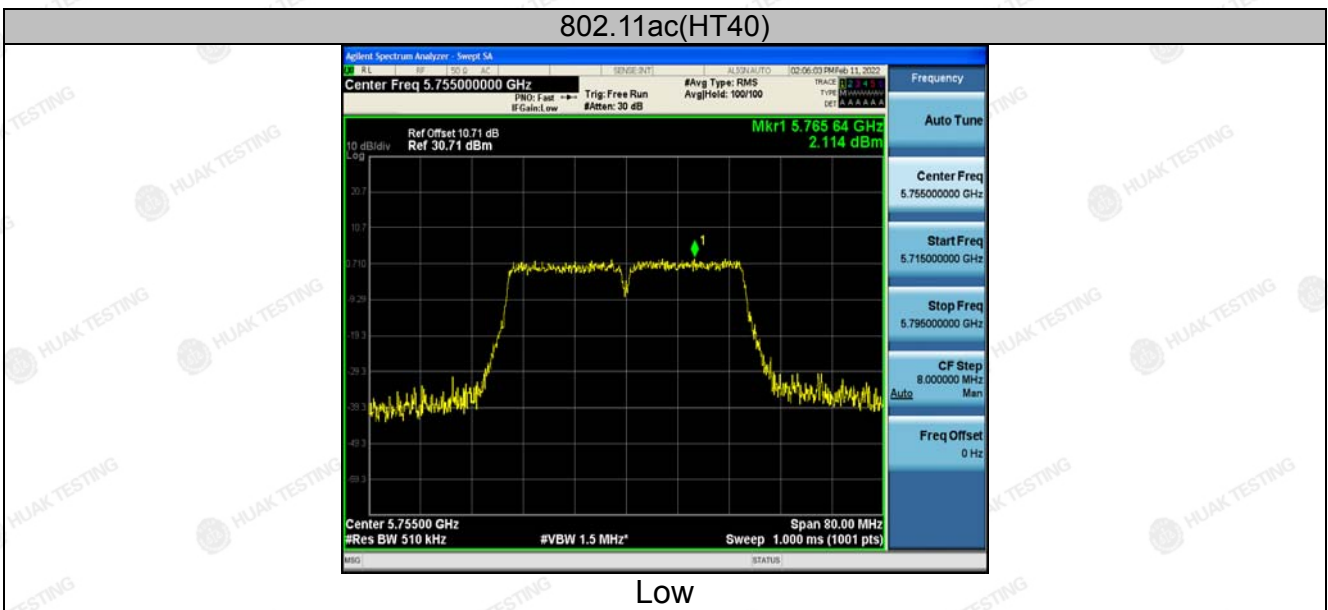

Low

The results shown in this test report refer only to the sample(s) tested unless otherwise stated and the sample is retained for 30 days only. The document is issued by HUAKE, this document cannot be reproduced except in full with our prior written permission. The more details and the authenticity of the report will be confirmed at <http://www.cer-mark.com>.



High  
802.11ac(T80)



The results shown in this test report refer only to the sample(s) tested unless otherwise stated and the sample(s) are retained for 30 days only. The document is issued by HUAJ, this document cannot be reproduced except in full with our prior written permission. The more details and the authenticity of the report will be confirmed at <http://www.cer-mark.com>.



For MIMO antenna port 1+antenna port 2

Configuration Band IV (5725 - 5850 MHz )

Mode	Test channel	Power Density (dBm/500KHz)	Limit (dBm/500KHz)	Result
11n(HT20)	CH149	7.80	29.97	PASS
11n(HT20)	CH157	8.32	29.97	PASS
11n(HT20)	CH161	8.66	29.97	PASS
11n(HT40)	CH151	5.41	29.97	PASS
11n(HT40)	CH159	5.48	29.97	PASS
11ac(HT20)	CH149	7.50	29.97	PASS
11ac(HT20)	CH157	8.21	29.97	PASS
11ac(HT20)	CH161	8.43	29.97	PASS
11ac(HT40)	CH151	5.21	29.97	PASS
11ac(HT40)	CH159	5.04	29.97	PASS
11ac(HT80)	CH155	2.61	29.97	PASS

Note: 1 According to KDB 662911, Result power =  $10\log(10^{(ant1/10)}+10^{(ant2/10)})$ .  
 2. limit=30dBm-(direction gain-6dBi)=29.97dBm

Note: This product supports antenna 1 and antenna 2 launch, but only support 802.11 n/ac for MIMO mode, not support 802.11 a for MIMO mode.

## 4.6. BAND EDGE

### 4.6.1. Test Specification

<b>Test Requirement:</b>	FCC CFR47 Part 15E Section 15.407
<b>Test Method:</b>	ANSI C63.10 2013
<b>Limit:</b>	<p>(1) For transmitters operating in the 5.725-5.85 GHz band:          (i) All emissions shall be limited to a level of <math>-27</math> dBm/MHz at 75 MHz or more above or below the band edge increasing linearly to 10 dBm/MHz at 25 MHz above or below the band edge, and from 25 MHz above or below the band edge increasing linearly to a level of 15.6 dBm/MHz at 5 MHz above or below the band edge, and from 5 MHz above or below the band edge increasing linearly to a level of 27 dBm/MHz at the band edge.          The limit of frequency below 1GHz and which fall in restricted bands should complies 15.209.</p>
<b>Test Setup:</b>	<p>The diagram illustrates the test setup. An EUT (Equipment Under Test) is placed on a turn table at a height of 1.5 m. The turn table is positioned 3 m away from an antenna tower. The antenna tower has an antenna feed point at a height of 1-4 m. The entire setup is on a ground plane. A receiver and amplifier (Amp.) are connected to the antenna tower.</p>
<b>Test Mode:</b>	Transmitting mode with modulation
	<ol style="list-style-type: none"> <li>1. The EUT was placed on the top of a rotating table 0.8 meters above the ground at a 3 meter camber. The table was rotated 360 degrees to determine the position of the highest radiation.</li> <li>2. The EUT was set 3 meters away from the interference-receiving antenna, which was mounted on the top of a variable-height antenna tower.</li> <li>3. The antenna height is varied from one meter to four meters above the ground to determine the maximum value of the field strength. Both horizontal and vertical polarizations of the antenna are set to make the measurement.</li> <li>4. For each suspected emission, the EUT was arranged to its worst case and then the antenna was tuned to heights from 1 meter to 4 meters and the rota table was turned from 0 degrees to 360 degrees to find the maximum reading.</li> </ol>



<b>Test Procedure:</b>	5. The test-receiver system was set to Peak Detect Function and Specified Bandwidth with Maximum Hold Mode. 6. If the emission level of the EUT in peak mode was 10dB lower than the limit specified, then testing could be stopped and the peak values of the EUT would be reported. Otherwise the emissions that did not have 10dB margin would be re-tested one by one using peak, quasi peak or average method as specified and then reported in a data sheet.
<b>Test Result:</b>	PASS





**4.6.2. Test Instruments**

Radiated Emission Test Site (966)					
Name of Equipment	Manufacturer	Model	Serial Number	Calibration Date	Calibration Due
Receiver	R&S	ESRP3	HKE-005	Dec. 09, 2021	Dec. 08, 2022
Spectrum analyzer	Agilent	N9020A	HKE-048	Dec. 09, 2021	Dec. 08, 2022
Preamplifier	EMCI	EMC051845S E	HKE-015	Dec. 09, 2021	Dec. 08, 2022
Preamplifier	Agilent	83051A	HKE-016	Dec. 09, 2021	Dec. 08, 2022
Loop antenna	Schwarzbeck	FMZB 1519 B	HKE-014	Dec. 09, 2021	Dec. 08, 2022
Broadband antenna	Schwarzbeck	VULB 9163	HKE-012	Dec. 09, 2021	Dec. 08, 2022
Horn antenna	Schwarzbeck	9120D	HKE-013	Dec. 09, 2021	Dec. 08, 2022
Antenna Mast	Keleto	CC-A-4M	N/A	N/A	N/A
Position controller	Taiwan MF	MF7802	HKE-011	Dec. 09, 2021	Dec. 08, 2022
Radiated test software	Tonscend	TS+ Rev 2.5.0.0	HKE-082	N/A	N/A
RF cable (9KHz-1GHz)	Times	381806-001	N/A	N/A	N/A
Hf antenna	Schwarzbeck	LB-180400-KF	HKE-031	Dec. 09, 2021	Dec. 08, 2022
RF cable	Tonscend	1-18G	HKE-099	Dec. 09, 2021	Dec. 08, 2022
RF cable	Times	1-40G	HKE-034	Dec. 09, 2021	Dec. 08, 2022
Horn Antenna	Schwarzbeck	BBHA 9170	HKE-017	Dec. 09, 2021	Dec. 08, 2022
Spectrum analyzer	R&S	FSP40	HKE-025	Dec. 09, 2021	Dec. 08, 2022

**Note:** The calibration interval of the above test instruments is 12 months and the calibrations are traceable to international system unit (SI).



4.6.3. Test Data

ANT 1

Operation Mode: 802.11a Mode with 5.8G TX CH Low

Horizontal:

Frequency (MHz)	Meter Reading (dBμV)	Factor (dB)	Emission Level (dBμV/m)	Limits (dBμV/m)	Margin (dB)	Detector Type
5650	56.51	-2.06	54.45	68.2	-13.75	
5700	86.77	-1.96	84.81	105.2	-20.39	peak
5720	90.98	-2.87	88.11	110.8	-22.69	peak
5725	100.21	-2.14	98.07	122.2	-24.13	peak

Remark: Factor = Antenna Factor + Cable Loss – Pre-amplifier.

Vertical:

Frequency (MHz)	Meter Reading (dBμV)	Factor (dB)	Emission Level (dBμV/m)	Limits (dBμV/m)	Margin (dB)	Detector Type
5650	54.97	-2.06	52.91	68.2	-15.29	
5700	89.01	-1.96	87.05	105.2	-18.15	peak
5720	90.93	-2.87	88.06	110.8	-22.74	peak
5725	100.71	-2.14	98.57	122.2	-23.63	peak

Remark: Factor = Antenna Factor + Cable Loss – Pre-amplifier.



Operation Mode: TX CH High with 5.8G

Horizontal:

Frequency	Meter Reading	Factor	Emission Level	Limits	Margin	Detector Type
(MHz)	(dBμV)	(dB)	(dBμV/m)	(dBμV/m)	(dB)	
5850	98.97	-1.97	97	122.2	-25.2	peak
5855	91.77	-2.13	89.64	110.8	-21.16	peak
5875	85.52	-2.65	82.87	105.2	-22.33	peak
5925	50.19	-2.28	47.91	68.2	-20.29	peak

Remark: Factor = Antenna Factor + Cable Loss – Pre-amplifier.

Vertical:

Frequency	Meter Reading	Factor	Emission Level	Limits	Margin	Detector Type
(MHz)	(dBμV)	(dB)	(dBμV/m)	(dBμV/m)	(dB)	
5850	95.45	-1.97	93.48	122.2	-28.72	peak
5855	92.34	-2.13	90.21	110.8	-20.59	peak
5875	82.15	-2.65	79.5	105.2	-25.7	peak
5925	51.76	-2.28	49.48	68.2	-18.72	peak

Remark: Factor = Antenna Factor + Cable Loss – Pre-amplifier.



Operation Mode: 802.11n20 Mode with 5.8G TX CH Low

Horizontal:

Frequency	Meter Reading	Factor	Emission Level	Limits	Margin	Detector Type
(MHz)	(dBμV)	(dB)	(dBμV/m)	(dBμV/m)	(dB)	
5650	55.84	-2.06	53.78	68.2	-14.42	peak
5700	87.89	-1.96	85.93	105.2	-19.27	peak
5720	91.18	-2.87	88.31	110.8	-22.49	peak
5725	96.25	-2.14	94.11	122.2	-28.09	peak

Remark: Factor = Antenna Factor + Cable Loss – Pre-amplifier.

Vertical:

Frequency	Meter Reading	Factor	Emission Level	Limits	Margin	Detector Type
(MHz)	(dBμV)	(dB)	(dBμV/m)	(dBμV/m)	(dB)	
5650	60.16	-2.06	58.1	68.2	-10.1	peak
5700	94.63	-1.96	92.67	105.2	-12.53	peak
5720	93.28	-2.87	90.41	110.8	-20.39	peak
5725	94.88	-2.14	92.74	122.2	-29.46	peak

Remark: Factor = Antenna Factor + Cable Loss – Pre-amplifier.



Operation Mode: TX CH High with 5.8G

Horizontal:

Frequency	Meter Reading	Factor	Emission Level	Limits	Margin	Detector Type
(MHz)	(dBµV)	(dB)	(dBµV/m)	(dBµV/m)	(dB)	
5850	94.16	-1.97	92.19	122.2	-30.01	peak
5855	91.08	-2.13	88.95	110.8	-21.85	peak
5875	87.81	-2.65	85.16	105.2	-20.04	peak
5925	51.14	-2.28	48.86	68.2	-19.34	peak

Remark: Factor = Antenna Factor + Cable Loss – Pre-amplifier.

Vertical:

Frequency	Meter Reading	Factor	Emission Level	Limits	Margin	Detector Type
(MHz)	(dBµV)	(dB)	(dBµV/m)	(dBµV/m)	(dB)	
5850	93.51	-1.97	91.54	122.2	-30.66	peak
5855	91.61	-2.13	89.48	110.8	-21.32	peak
5875	83.79	-2.65	81.14	105.2	-24.06	peak
5925	54.49	-2.28	52.21	68.2	-15.99	peak

Remark: Factor = Antenna Factor + Cable Loss – Pre-amplifier.



Operation Mode: 802.11n40 Mode with 5.8G TX CH Low

Horizontal:

Frequency	Meter Reading	Factor	Emission Level	Limits	Margin	Detector Type
(MHz)	(dBμV)	(dB)	(dBμV/m)	(dBμV/m)	(dB)	
5650	54.32	-2.06	52.26	68.2	-15.94	peak
5700	90.05	-1.96	88.09	105.2	-17.11	peak
5720	93.66	-2.87	90.79	110.8	-20.01	peak
5725	97.44	-2.14	95.3	122.2	-26.9	peak

Remark: Factor = Antenna Factor + Cable Loss – Pre-amplifier.

Vertical:

Frequency	Meter Reading	Factor	Emission Level	Limits	Margin	Detector Type
(MHz)	(dBμV)	(dB)	(dBμV/m)	(dBμV/m)	(dB)	
5650	59.52	-2.06	57.46	68.2	-10.74	peak
5700	91.14	-1.96	89.18	105.2	-16.02	peak
5720	87.27	-2.87	84.4	110.8	-26.4	peak
5725	93.99	-2.14	91.85	122.2	-30.35	peak

Remark: Factor = Antenna Factor + Cable Loss – Pre-amplifier.



Operation Mode: TX CH High with 5.8G

Horizontal:

Frequency	Meter Reading	Factor	Emission Level	Limits	Margin	Detector Type
(MHz)	(dBμV)	(dB)	(dBμV/m)	(dBμV/m)	(dB)	
5850	96.05	-1.97	94.08	122.2	-28.12	peak
5855	91.63	-2.13	89.5	110.8	-21.3	peak
5875	83.31	-2.65	80.66	105.2	-24.54	peak
5925	52.15	-2.28	49.87	68.2	-18.33	peak

Remark: Factor = Antenna Factor + Cable Loss – Pre-amplifier.

Vertical:

Frequency	Meter Reading	Factor	Emission Level	Limits	Margin	Detector Type
(MHz)	(dBμV)	(dB)	(dBμV/m)	(dBμV/m)	(dB)	
5850	97.64	-1.97	95.67	122.2	-26.53	peak
5855	89.06	-2.13	86.93	110.8	-23.87	peak
5875	84.74	-2.65	82.09	105.2	-23.11	peak
5925	52.59	-2.28	50.31	68.2	-17.89	peak

Remark: Factor = Antenna Factor + Cable Loss – Pre-amplifier.



Operation Mode: 802.11ac20 Mode with 5.8G TX CH Low

Horizontal:

Frequency	Meter Reading	Factor	Emission Level	Limits	Margin	Detector Type
(MHz)	(dBμV)	(dB)	(dBμV/m)	(dBμV/m)	(dB)	
5650	54.02	-2.06	51.96	68.2	-16.24	peak
5700	84.08	-1.96	82.12	105.2	-23.08	peak
5720	89.12	-2.87	86.25	110.8	-24.55	peak
5725	96.41	-2.14	94.27	122.2	-27.93	peak

Remark: Factor = Antenna Factor + Cable Loss – Pre-amplifier.

Vertical:

Frequency	Meter Reading	Factor	Emission Level	Limits	Margin	Detector Type
(MHz)	(dBμV)	(dB)	(dBμV/m)	(dBμV/m)	(dB)	
5650	53.27	-2.06	51.21	68.2	-16.99	peak
5700	90.25	-1.96	88.29	105.2	-16.91	peak
5720	90.71	-2.87	87.84	110.8	-22.96	peak
5725	96.98	-2.14	94.84	122.2	-27.36	peak

Remark: Factor = Antenna Factor + Cable Loss – Pre-amplifier.





Operation Mode: TX CH High with 5.8G

Horizontal:

Frequency	Meter Reading	Factor	Emission Level	Limits	Margin	Detector Type
(MHz)	(dBμV)	(dB)	(dBμV/m)	(dBμV/m)	(dB)	
5850	99.41	-1.97	97.44	122.2	-24.76	peak
5855	92.38	-2.13	90.25	110.8	-20.55	peak
5875	86.57	-2.65	83.92	105.2	-21.28	peak
5925	51.87	-2.28	49.59	68.2	-18.61	peak

Remark: Factor = Antenna Factor + Cable Loss – Pre-amplifier.

Vertical:

Frequency	Meter Reading	Factor	Emission Level	Limits	Margin	Detector Type
(MHz)	(dBμV)	(dB)	(dBμV/m)	(dBμV/m)	(dB)	
5850	94.53	-1.97	92.56	122.2	-29.64	peak
5855	86.69	-2.13	84.56	110.8	-26.24	peak
5875	81.58	-2.65	78.93	105.2	-26.27	peak
5925	55.72	-2.28	53.44	68.2	-14.76	peak

Remark: Factor = Antenna Factor + Cable Loss – Pre-amplifier.



Operation Mode: 802.11ac40 Mode with 5.8G TX CH Low

Horizontal:

Frequency	Meter Reading	Factor	Emission Level	Limits	Margin	Detector Type
(MHz)	(dBµV)	(dB)	(dBµV/m)	(dBµV/m)	(dB)	
5650	55.79	-2.06	53.73	68.2	-14.47	peak
5700	88.12	-1.96	86.16	105.2	-19.04	peak
5720	93.65	-2.87	90.78	110.8	-20.02	peak
5725	94.72	-2.14	92.58	122.2	-29.62	peak

Remark: Factor = Antenna Factor + Cable Loss – Pre-amplifier.

Vertical:

Frequency	Meter Reading	Factor	Emission Level	Limits	Margin	Detector Type
(MHz)	(dBµV)	(dB)	(dBµV/m)	(dBµV/m)	(dB)	
5650	56.11	-2.06	54.05	68.2	-14.15	peak
5700	83.74	-1.96	81.78	105.2	-23.42	peak
5720	91.84	-2.87	88.97	110.8	-21.83	peak
5725	94.25	-2.14	92.11	122.2	-30.09	peak

Remark: Factor = Antenna Factor + Cable Loss – Pre-amplifier.



Operation Mode: TX CH High with 5.8G

Horizontal:

Frequency	Meter Reading	Factor	Emission Level	Limits	Margin	Detector Type
(MHz)	(dBμV)	(dB)	(dBμV/m)	(dBμV/m)	(dB)	
5850	93.82	-1.97	91.85	122.2	-30.35	peak
5855	90.49	-2.13	88.36	110.8	-22.44	peak
5875	86.59	-2.65	83.94	105.2	-21.26	peak
5925	50.49	-2.28	48.21	68.2	-19.99	peak

Remark: Factor = Antenna Factor + Cable Loss – Pre-amplifier.

Vertical:

Frequency	Meter Reading	Factor	Emission Level	Limits	Margin	Detector Type
(MHz)	(dBμV)	(dB)	(dBμV/m)	(dBμV/m)	(dB)	
5850	94.13	-1.97	92.16	122.2	-30.04	peak
5855	86.95	-2.13	84.82	110.8	-25.98	peak
5875	85.35	-2.65	82.7	105.2	-22.5	peak
5925	54.39	-2.28	52.11	68.2	-16.09	peak

Remark: Factor = Antenna Factor + Cable Loss – Pre-amplifier.



Operation Mode: 802.11ac80 Mode with 5.8G TX CH Low

Horizontal:

Frequency	Meter Reading	Factor	Emission Level	Limits	Margin	Detector Type
(MHz)	(dBμV)	(dB)	(dBμV/m)	(dBμV/m)	(dB)	
5650	52.35	-2.06	50.29	68.2	-17.91	peak
5700	84.68	-1.96	82.72	105.2	-22.48	peak
5720	92.25	-2.87	89.38	110.8	-21.42	peak
5725	91.25	-2.14	89.11	122.2	-33.09	peak

Remark: Factor = Antenna Factor + Cable Loss – Pre-amplifier.

Vertical:

Frequency	Meter Reading	Factor	Emission Level	Limits	Margin	Detector Type
(MHz)	(dBμV)	(dB)	(dBμV/m)	(dBμV/m)	(dB)	
5650	53.17	-2.06	51.11	68.2	-17.09	peak
5700	87.92	-1.96	85.96	105.2	-19.24	peak
5720	91.25	-2.87	88.38	110.8	-22.42	peak
5725	95.14	-2.14	93	122.2	-29.2	peak

Remark: Factor = Antenna Factor + Cable Loss – Pre-amplifier.



Operation Mode: TX CH High with 5.8G

Horizontal:

Frequency	Meter Reading	Factor	Emission Level	Limits	Margin	Detector Type
(MHz)	(dBμV)	(dB)	(dBμV/m)	(dBμV/m)	(dB)	
5850	96.88	-1.97	94.91	122.2	-27.29	peak
5855	89.78	-2.13	87.65	110.8	-23.15	peak
5875	83.63	-2.65	80.98	105.2	-24.22	peak
5925	51.42	-2.28	49.14	68.2	-19.06	peak

Remark: Factor = Antenna Factor + Cable Loss – Pre-amplifier.

Vertical:

Frequency	Meter Reading	Factor	Emission Level	Limits	Margin	Detector Type
(MHz)	(dBμV)	(dB)	(dBμV/m)	(dBμV/m)	(dB)	
5850	92.31	-1.97	90.34	122.2	-31.86	peak
5855	91.28	-2.13	89.15	110.8	-21.65	peak
5875	78.76	-2.65	76.11	105.2	-29.09	peak
5925	54.53	-2.28	52.25	68.2	-15.95	peak

Remark: Factor = Antenna Factor + Cable Loss – Pre-amplifier.



**ANT 2**

Operation Mode: 802.11a Mode with 5.8G TX CH Low

Horizontal:

Frequency	Meter Reading	Factor	Emission Level	Limits	Margin	Detector Type
(MHz)	(dBμV)	(dB)	(dBμV/m)	(dBμV/m)	(dB)	
5650	53.12	-2.06	51.06	68.2	-17.14	peak
5700	89.82	-1.96	87.86	105.2	-17.34	peak
5720	92.26	-2.87	89.39	110.8	-21.41	peak
5725	93.95	-2.14	91.81	122.2	-30.39	peak

Remark: Factor = Antenna Factor + Cable Loss – Pre-amplifier.

Vertical:

Frequency	Meter Reading	Factor	Emission Level	Limits	Margin	Detector Type
(MHz)	(dBμV)	(dB)	(dBμV/m)	(dBμV/m)	(dB)	
5650	55.02	-2.06	52.96	68.2	-15.24	peak
5700	90.19	-1.96	88.23	105.2	-16.97	peak
5720	92.61	-2.87	89.74	110.8	-21.06	peak
5725	93.28	-2.14	91.14	122.2	-31.06	peak

Remark: Factor = Antenna Factor + Cable Loss – Pre-amplifier.



Operation Mode: TX CH High with 5.8G

Horizontal:

Frequency	Meter Reading	Factor	Emission Level	Limits	Margin	Detector Type
(MHz)	(dBµV)	(dB)	(dBµV/m)	(dBµV/m)	(dB)	
5850	95.63	-1.97	93.66	122.2	-28.54	peak
5855	93.73	-2.13	91.6	110.8	-19.2	peak
5875	83.57	-2.65	80.92	105.2	-24.28	peak
5925	53.41	-2.28	51.13	68.2	-17.07	peak

Remark: Factor = Antenna Factor + Cable Loss – Pre-amplifier.

Vertical:

Frequency	Meter Reading	Factor	Emission Level	Limits	Margin	Detector Type
(MHz)	(dBµV)	(dB)	(dBµV/m)	(dBµV/m)	(dB)	
5850	96.75	-1.97	94.78	122.2	-27.42	peak
5855	91.86	-2.13	89.73	110.8	-21.07	peak
5875	85.67	-2.65	83.02	105.2	-22.18	peak
5925	54.16	-2.28	51.88	68.2	-16.32	peak

Remark: Factor = Antenna Factor + Cable Loss – Pre-amplifier.



Operation Mode: 802.11n20 Mode with 5.8G TX CH Low

Horizontal:

Frequency	Meter Reading	Factor	Emission Level	Limits	Margin	Detector Type
(MHz)	(dBµV)	(dB)	(dBµV/m)	(dBµV/m)	(dB)	
5650	57.77	-2.06	55.71	68.2	-12.49	peak
5700	85.19	-1.96	83.23	105.2	-21.97	peak
5720	90.18	-2.87	87.31	110.8	-23.49	peak
5725	95.77	-2.14	93.63	122.2	-28.57	peak

Remark: Factor = Antenna Factor + Cable Loss – Pre-amplifier.

Vertical:

Frequency	Meter Reading	Factor	Emission Level	Limits	Margin	Detector Type
(MHz)	(dBµV)	(dB)	(dBµV/m)	(dBµV/m)	(dB)	
5650	56.07	-2.06	54.01	68.2	-14.19	peak
5700	92.87	-1.96	90.91	105.2	-14.29	peak
5720	90.24	-2.87	87.37	110.8	-23.43	peak
5725	93.95	-2.14	91.81	122.2	-30.39	peak

Remark: Factor = Antenna Factor + Cable Loss – Pre-amplifier.





Operation Mode: TX CH High with 5.8G

Horizontal:

Frequency	Meter Reading	Factor	Emission Level	Limits	Margin	Detector Type
(MHz)	(dBμV)	(dB)	(dBμV/m)	(dBμV/m)	(dB)	
5850	95.72	-1.97	93.75	122.2	-28.45	peak
5855	91.29	-2.13	89.16	110.8	-21.64	peak
5875	83.75	-2.65	81.1	105.2	-24.1	peak
5925	50.52	-2.28	48.24	68.2	-19.96	peak

Remark: Factor = Antenna Factor + Cable Loss – Pre-amplifier.

Vertical:

Frequency	Meter Reading	Factor	Emission Level	Limits	Margin	Detector Type
(MHz)	(dBμV)	(dB)	(dBμV/m)	(dBμV/m)	(dB)	
5850	94.26	-1.97	92.29	122.2	-29.91	peak
5855	91.25	-2.13	89.12	110.8	-21.68	peak
5875	82.18	-2.65	79.53	105.2	-25.67	peak
5925	54.42	-2.28	52.14	68.2	-16.06	peak

Remark: Factor = Antenna Factor + Cable Loss – Pre-amplifier.



Operation Mode: 802.11n40 Mode with 5.8G TX CH Low

Horizontal:

Frequency	Meter Reading	Factor	Emission Level	Limits	Margin	Detector Type
(MHz)	(dBμV)	(dB)	(dBμV/m)	(dBμV/m)	(dB)	
5650	53.39	-2.06	51.33	68.2	-16.87	peak
5700	91.47	-1.96	89.51	105.2	-15.69	peak
5720	87.65	-2.87	84.78	110.8	-26.02	peak
5725	96.57	-2.14	94.43	122.2	-27.77	peak

Remark: Factor = Antenna Factor + Cable Loss – Pre-amplifier.

Vertical:

Frequency	Meter Reading	Factor	Emission Level	Limits	Margin	Detector Type
(MHz)	(dBμV)	(dB)	(dBμV/m)	(dBμV/m)	(dB)	
5650	60.09	-2.06	58.03	68.2	-10.17	peak
5700	93.33	-1.96	91.37	105.2	-13.83	peak
5720	88.36	-2.87	85.49	110.8	-25.31	peak
5725	98.73	-2.14	96.59	122.2	-25.61	peak

Remark: Factor = Antenna Factor + Cable Loss – Pre-amplifier.



Operation Mode: TX CH High with 5.8G

Horizontal:

Frequency	Meter Reading	Factor	Emission Level	Limits	Margin	Detector Type
(MHz)	(dBμV)	(dB)	(dBμV/m)	(dBμV/m)	(dB)	
5850	97.57	-1.97	95.6	122.2	-26.6	peak
5855	91.83	-2.13	89.7	110.8	-21.1	peak
5875	87.18	-2.65	84.53	105.2	-20.67	peak
5925	50.91	-2.28	48.63	68.2	-19.57	peak

Remark: Factor = Antenna Factor + Cable Loss – Pre-amplifier.

Vertical:

Frequency	Meter Reading	Factor	Emission Level	Limits	Margin	Detector Type
(MHz)	(dBμV)	(dB)	(dBμV/m)	(dBμV/m)	(dB)	
5850	94.79	-1.97	92.82	122.2	-29.38	peak
5855	93.84	-2.13	91.71	110.8	-19.09	peak
5875	84.67	-2.65	82.02	105.2	-23.18	peak
5925	50.32	-2.28	48.04	68.2	-20.16	peak

Remark: Factor = Antenna Factor + Cable Loss – Pre-amplifier.



Operation Mode: 802.11ac20 Mode with 5.8G TX CH Low

Horizontal:

Frequency	Meter Reading	Factor	Emission Level	Limits	Margin	Detector Type
(MHz)	(dBµV)	(dB)	(dBµV/m)	(dBµV/m)	(dB)	
5650	55.89	-2.06	53.83	68.2	-14.37	peak
5700	91.64	-1.96	89.68	105.2	-15.52	peak
5720	90.93	-2.87	88.06	110.8	-22.74	peak
5725	96.96	-2.14	94.82	122.2	-27.38	peak

Remark: Factor = Antenna Factor + Cable Loss – Pre-amplifier.

Vertical:

Frequency	Meter Reading	Factor	Emission Level	Limits	Margin	Detector Type
(MHz)	(dBµV)	(dB)	(dBµV/m)	(dBµV/m)	(dB)	
5650	58.44	-2.06	56.38	68.2	-11.82	peak
5700	86.85	-1.96	84.89	105.2	-20.31	peak
5720	93.21	-2.87	90.34	110.8	-20.46	peak
5725	95.84	-2.14	93.7	122.2	-28.5	peak

Remark: Factor = Antenna Factor + Cable Loss – Pre-amplifier.



Operation Mode: TX CH High with 5.8G

Horizontal:

Frequency	Meter Reading	Factor	Emission Level	Limits	Margin	Detector Type
(MHz)	(dBμV)	(dB)	(dBμV/m)	(dBμV/m)	(dB)	
5850	95.29	-1.97	93.32	122.2	-28.88	peak
5855	92.62	-2.13	90.49	110.8	-20.31	peak
5875	83.11	-2.65	80.46	105.2	-24.74	peak
5925	53.01	-2.28	50.73	68.2	-17.47	peak

Remark: Factor = Antenna Factor + Cable Loss – Pre-amplifier.

Vertical:

Frequency	Meter Reading	Factor	Emission Level	Limits	Margin	Detector Type
(MHz)	(dBμV)	(dB)	(dBμV/m)	(dBμV/m)	(dB)	
5850	93.11	-1.97	91.14	122.2	-31.06	peak
5855	90.77	-2.13	88.64	110.8	-22.16	peak
5875	82.09	-2.65	79.44	105.2	-25.76	peak
5925	51.74	-2.28	49.46	68.2	-18.74	peak

Remark: Factor = Antenna Factor + Cable Loss – Pre-amplifier.



Operation Mode: 802.11ac40 Mode with 5.8G TX CH Low

Horizontal:

Frequency	Meter Reading	Factor	Emission Level	Limits	Margin	Detector Type
(MHz)	(dBµV)	(dB)	(dBµV/m)	(dBµV/m)	(dB)	
5650	56.26	-2.06	54.2	68.2	-14	peak
5700	84.57	-1.96	82.61	105.2	-22.59	peak
5720	90.14	-2.87	87.27	110.8	-23.53	peak
5725	93.48	-2.14	91.34	122.2	-30.86	peak

Remark: Factor = Antenna Factor + Cable Loss – Pre-amplifier.

Vertical:

Frequency	Meter Reading	Factor	Emission Level	Limits	Margin	Detector Type
(MHz)	(dBµV)	(dB)	(dBµV/m)	(dBµV/m)	(dB)	
5650	55.98	-2.06	53.92	68.2	-14.28	peak
5700	90.84	-1.96	88.88	105.2	-16.32	peak
5720	94.52	-2.87	91.65	110.8	-19.15	peak
5725	92.74	-2.14	90.6	122.2	-31.6	peak

Remark: Factor = Antenna Factor + Cable Loss – Pre-amplifier.



Operation Mode: TX CH High with 5.8G

Horizontal:

Frequency	Meter Reading	Factor	Emission Level	Limits	Margin	Detector Type
(MHz)	(dBμV)	(dB)	(dBμV/m)	(dBμV/m)	(dB)	
5850	97.98	-1.97	96.01	122.2	-26.19	peak
5855	91.97	-2.13	89.84	110.8	-20.96	peak
5875	85.02	-2.65	82.37	105.2	-22.83	peak
5925	53.06	-2.28	50.78	68.2	-17.42	peak

Remark: Factor = Antenna Factor + Cable Loss – Pre-amplifier.

Vertical:

Frequency	Meter Reading	Factor	Emission Level	Limits	Margin	Detector Type
(MHz)	(dBμV)	(dB)	(dBμV/m)	(dBμV/m)	(dB)	
5850	96.21	-1.97	94.24	122.2	-27.96	peak
5855	90.74	-2.13	88.61	110.8	-22.19	peak
5875	83.75	-2.65	81.1	105.2	-24.1	peak
5925	54.25	-2.28	51.97	68.2	-16.23	peak

Remark: Factor = Antenna Factor + Cable Loss – Pre-amplifier.



Operation Mode: 802.11ac80 Mode with 5.8G TX CH Low

Horizontal:

Frequency	Meter Reading	Factor	Emission Level	Limits	Margin	Detector Type
(MHz)	(dBμV)	(dB)	(dBμV/m)	(dBμV/m)	(dB)	
5650	55.76	-2.06	53.7	68.2	-14.5	peak
5700	90.06	-1.96	88.1	105.2	-17.1	peak
5720	86.93	-2.87	84.06	110.8	-26.74	peak
5725	95.73	-2.14	93.59	122.2	-28.61	peak

Remark: Factor = Antenna Factor + Cable Loss – Pre-amplifier.

Vertical:

Frequency	Meter Reading	Factor	Emission Level	Limits	Margin	Detector Type
(MHz)	(dBμV)	(dB)	(dBμV/m)	(dBμV/m)	(dB)	
5650	55.01	-2.06	52.95	68.2	-15.25	peak
5700	87.21	-1.96	85.25	105.2	-19.95	peak
5720	92.23	-2.87	89.36	110.8	-21.44	peak
5725	96.67	-2.14	94.53	122.2	-27.67	peak

Remark: Factor = Antenna Factor + Cable Loss – Pre-amplifier.





Operation Mode: TX CH High with 5.8G

Horizontal:

Frequency	Meter Reading	Factor	Emission Level	Limits	Margin	Detector Type
(MHz)	(dBμV)	(dB)	(dBμV/m)	(dBμV/m)	(dB)	
5850	97.04	-1.97	95.07	122.2	-27.13	peak
5855	90.15	-2.13	88.02	110.8	-22.78	peak
5875	82.71	-2.65	80.06	105.2	-25.14	peak
5925	51.87	-2.28	49.59	68.2	-18.61	peak

Remark: Factor = Antenna Factor + Cable Loss – Pre-amplifier.

Vertical:

Frequency	Meter Reading	Factor	Emission Level	Limits	Margin	Detector Type
(MHz)	(dBμV)	(dB)	(dBμV/m)	(dBμV/m)	(dB)	
5850	97.62	-1.97	95.65	122.2	-26.55	peak
5855	91.47	-2.13	89.34	110.8	-21.46	peak
5875	82.89	-2.65	80.24	105.2	-24.96	peak
5925	55.09	-2.28	52.81	68.2	-15.39	peak

Remark: Factor = Antenna Factor + Cable Loss – Pre-amplifier.



MIMO:

Operation Mode: 802.11n20 Mode with 5.8G TX CH Low

Horizontal:

Frequency (MHz)	Meter Reading (dBμV)	Factor (dB)	Emission Level (dBμV/m)	Limits (dBμV/m)	Margin (dB)	Detector Type
5650	57.86	-2.06	55.8	68.2	-12.4	peak
5700	90.68	-1.96	88.72	105.2	-16.48	peak
5720	94.02	-2.87	91.15	110.8	-19.65	peak
5725	100.28	-2.14	98.14	122.2	-24.06	peak

Remark: Factor = Antenna Factor + Cable Loss – Pre-amplifier.

Vertical:

Frequency (MHz)	Meter Reading (dBμV)	Factor (dB)	Emission Level (dBμV/m)	Limits (dBμV/m)	Margin (dB)	Detector Type
5650	60.82	-2.06	58.76	68.2	-9.44	peak
5700	94.61	-1.96	92.65	105.2	-12.55	peak
5720	93.44	-2.87	90.57	110.8	-20.23	peak
5725	96.17	-2.14	94.03	122.2	-28.17	peak

Remark: Factor = Antenna Factor + Cable Loss – Pre-amplifier.



Operation Mode: TX CH High with 5.8G

Horizontal:

Frequency	Meter Reading	Factor	Emission Level	Limits	Margin	Detector Type
(MHz)	(dBμV)	(dB)	(dBμV/m)	(dBμV/m)	(dB)	
5850	95.85	-1.97	93.88	122.2	-28.32	peak
5855	94.23	-2.13	92.1	110.8	-18.7	peak
5875	86.15	-2.65	83.5	105.2	-21.7	peak
5925	51.95	-2.28	49.67	68.2	-18.53	peak

Remark: Factor = Antenna Factor + Cable Loss – Pre-amplifier.

Vertical:

Frequency	Meter Reading	Factor	Emission Level	Limits	Margin	Detector Type
(MHz)	(dBμV)	(dB)	(dBμV/m)	(dBμV/m)	(dB)	
5850	96.67	-1.97	94.7	122.2	-27.5	peak
5855	92.74	-2.13	90.61	110.8	-20.19	peak
5875	84.32	-2.65	81.67	105.2	-23.53	peak
5925	54.48	-2.28	52.2	68.2	-16	peak

Remark: Factor = Antenna Factor + Cable Loss – Pre-amplifier.

The results shown in this test report refer only to the sample(s) tested unless otherwise stated and the sample(s) are retained for 30 days only. The document is issued by HUAK, this document cannot be reproduced except in full with our prior written permission. The more details and the authenticity of the report will be confirmed at <http://www.cer-mark.com>.



Operation Mode: 802.11n40 Mode with 5.8G TX CH Low

Horizontal:

Frequency	Meter Reading	Factor	Emission Level	Limits	Margin	Detector Type
(MHz)	(dBμV)	(dB)	(dBμV/m)	(dBμV/m)	(dB)	
5650	55.66	-2.06	53.6	68.2	-14.6	peak
5700	94.24	-1.96	92.28	105.2	-12.92	peak
5720	91.74	-2.87	88.87	110.8	-21.93	peak
5725	95.94	-2.14	93.8	122.2	-28.4	peak

Remark: Factor = Antenna Factor + Cable Loss – Pre-amplifier.

Vertical:

Frequency	Meter Reading	Factor	Emission Level	Limits	Margin	Detector Type
(MHz)	(dBμV)	(dB)	(dBμV/m)	(dBμV/m)	(dB)	
5650	60.37	-2.06	58.31	68.2	-9.89	peak
5700	95.29	-1.96	93.33	105.2	-11.87	peak
5720	91.01	-2.87	88.14	110.8	-22.66	peak
5725	94.83	-2.14	92.69	122.2	-29.51	peak

Remark: Factor = Antenna Factor + Cable Loss – Pre-amplifier.



Operation Mode: TX CH High with 5.8G

Horizontal:

Frequency	Meter Reading	Factor	Emission Level	Limits	Margin	Detector Type
(MHz)	(dBμV)	(dB)	(dBμV/m)	(dBμV/m)	(dB)	
5850	102.19	-1.97	100.22	122.2	-21.98	peak
5855	95.12	-2.13	92.99	110.8	-17.81	peak
5875	85.47	-2.65	82.82	105.2	-22.38	peak
5925	53.24	-2.28	50.96	68.2	-17.24	peak

Remark: Factor = Antenna Factor + Cable Loss – Pre-amplifier.

Vertical:

Frequency	Meter Reading	Factor	Emission Level	Limits	Margin	Detector Type
(MHz)	(dBμV)	(dB)	(dBμV/m)	(dBμV/m)	(dB)	
5850	100.74	-1.97	98.77	122.2	-23.43	peak
5855	90.88	-2.13	88.75	110.8	-22.05	peak
5875	84.41	-2.65	81.76	105.2	-23.44	peak
5925	55.06	-2.28	52.78	68.2	-15.42	peak

Remark: Factor = Antenna Factor + Cable Loss – Pre-amplifier.



Operation Mode: 802.11ac20 Mode with 5.8G TX CH Low

Horizontal:

Frequency	Meter Reading	Factor	Emission Level	Limits	Margin	Detector Type
(MHz)	(dBµV)	(dB)	(dBµV/m)	(dBµV/m)	(dB)	
5650	55.29	-2.06	53.23	68.2	-14.97	peak
5700	90.34	-1.96	88.38	105.2	-16.82	peak
5720	91.02	-2.87	88.15	110.8	-22.65	peak
5725	97.34	-2.14	95.2	122.2	-27	peak

Remark: Factor = Antenna Factor + Cable Loss – Pre-amplifier.

Vertical:

Frequency	Meter Reading	Factor	Emission Level	Limits	Margin	Detector Type
(MHz)	(dBµV)	(dB)	(dBµV/m)	(dBµV/m)	(dB)	
5650	56.76	-2.06	54.7	68.2	-13.5	peak
5700	86.95	-1.96	84.99	105.2	-20.21	peak
5720	90.72	-2.87	87.85	110.8	-22.95	peak
5725	94.84	-2.14	92.7	122.2	-29.5	peak

Remark: Factor = Antenna Factor + Cable Loss – Pre-amplifier.



Operation Mode: TX CH High with 5.8G

Horizontal:

Frequency	Meter Reading	Factor	Emission Level	Limits	Margin	Detector Type
(MHz)	(dBμV)	(dB)	(dBμV/m)	(dBμV/m)	(dB)	
5850	100.61	-1.97	98.64	122.2	-23.56	peak
5855	93.33	-2.13	91.2	110.8	-19.6	peak
5875	88.37	-2.65	85.72	105.2	-19.48	peak
5925	50.98	-2.28	48.7	68.2	-19.5	peak

Remark: Factor = Antenna Factor + Cable Loss – Pre-amplifier.

Vertical:

Frequency	Meter Reading	Factor	Emission Level	Limits	Margin	Detector Type
(MHz)	(dBμV)	(dB)	(dBμV/m)	(dBμV/m)	(dB)	
5850	94.81	-1.97	92.84	122.2	-29.36	peak
5855	86.98	-2.13	84.85	110.8	-25.95	peak
5875	83.87	-2.65	81.22	105.2	-23.98	peak
5925	53.03	-2.28	50.75	68.2	-17.45	peak

Remark: Factor = Antenna Factor + Cable Loss – Pre-amplifier.



Operation Mode: 802.11ac40 Mode with 5.8G TX CH Low

Horizontal:

Frequency	Meter Reading	Factor	Emission Level	Limits	Margin	Detector Type
(MHz)	(dBµV)	(dB)	(dBµV/m)	(dBµV/m)	(dB)	
5650	56.63	-2.06	54.57	68.2	-13.63	peak
5700	87.22	-1.96	85.26	105.2	-19.94	peak
5720	95.93	-2.87	93.06	110.8	-17.74	peak
5725	92.86	-2.14	90.72	122.2	-31.48	peak

Remark: Factor = Antenna Factor + Cable Loss – Pre-amplifier.

Vertical:

Frequency	Meter Reading	Factor	Emission Level	Limits	Margin	Detector Type
(MHz)	(dBµV)	(dB)	(dBµV/m)	(dBµV/m)	(dB)	
5650	55.17	-2.06	53.11	68.2	-15.09	peak
5700	87.82	-1.96	85.86	105.2	-19.34	peak
5720	95.62	-2.87	92.75	110.8	-18.05	peak
5725	96.71	-2.14	94.57	122.2	-27.63	peak

Remark: Factor = Antenna Factor + Cable Loss – Pre-amplifier.





Operation Mode: TX CH High with 5.8G

Horizontal:

Frequency	Meter Reading	Factor	Emission Level	Limits	Margin	Detector Type
(MHz)	(dBμV)	(dB)	(dBμV/m)	(dBμV/m)	(dB)	
5850	98.27	-1.97	96.3	122.2	-25.9	peak
5855	90.16	-2.13	88.03	110.8	-22.77	peak
5875	83.55	-2.65	80.9	105.2	-24.3	peak
5925	55.62	-2.28	53.34	68.2	-14.86	peak

Remark: Factor = Antenna Factor + Cable Loss – Pre-amplifier.

Vertical:

Frequency	Meter Reading	Factor	Emission Level	Limits	Margin	Detector Type
(MHz)	(dBμV)	(dB)	(dBμV/m)	(dBμV/m)	(dB)	
5850	93.55	-1.97	91.58	122.2	-30.62	peak
5855	90.37	-2.13	88.24	110.8	-22.56	peak
5875	87.95	-2.65	85.3	105.2	-19.9	peak
5925	55.12	-2.28	52.84	68.2	-15.36	peak

Remark: Factor = Antenna Factor + Cable Loss – Pre-amplifier.



Operation Mode: 802.11ac80 Mode with 5.8G TX CH Low

Horizontal:

Frequency	Meter Reading	Factor	Emission Level	Limits	Margin	Detector Type
(MHz)	(dBµV)	(dB)	(dBµV/m)	(dBµV/m)	(dB)	
5650	55.91	-2.06	53.85	68.2	-14.35	peak
5700	87.37	-1.96	85.41	105.2	-19.79	peak
5720	93.58	-2.87	90.71	110.8	-20.09	peak
5725	95.27	-2.14	93.13	122.2	-29.07	peak

Remark: Factor = Antenna Factor + Cable Loss – Pre-amplifier.

Vertical:

Frequency	Meter Reading	Factor	Emission Level	Limits	Margin	Detector Type
(MHz)	(dBµV)	(dB)	(dBµV/m)	(dBµV/m)	(dB)	
5650	57.18	-2.06	55.12	68.2	-13.08	peak
5700	88.46	-1.96	86.5	105.2	-18.7	peak
5720	91.18	-2.87	88.31	110.8	-22.49	peak
5725	96.09	-2.14	93.95	122.2	-28.25	peak

Remark: Factor = Antenna Factor + Cable Loss – Pre-amplifier.



Operation Mode: TX CH High with 5.8G

Horizontal:

Frequency	Meter Reading	Factor	Emission Level	Limits	Margin	Detector Type
(MHz)	(dBμV)	(dB)	(dBμV/m)	(dBμV/m)	(dB)	
5850	100.74	-1.97	98.77	122.2	-23.43	peak
5855	93.36	-2.13	91.23	110.8	-19.57	peak
5875	84.48	-2.65	81.83	105.2	-23.37	peak
5925	53.89	-2.28	51.61	68.2	-16.59	peak

Remark: Factor = Antenna Factor + Cable Loss – Pre-amplifier.

Vertical:

Frequency	Meter Reading	Factor	Emission Level	Limits	Margin	Detector Type
(MHz)	(dBμV)	(dB)	(dBμV/m)	(dBμV/m)	(dB)	
5850	96.73	-1.97	94.76	122.2	-27.44	peak
5855	94.03	-2.13	91.9	110.8	-18.9	peak
5875	81.21	-2.65	78.56	105.2	-26.64	peak
5925	54.34	-2.28	52.06	68.2	-16.14	peak

Remark: Factor = Antenna Factor + Cable Loss – Pre-amplifier.

## 4.7. SPURIOUS EMISSION

### 4.7.1. Test Specification

<b>Test Requirement:</b>	FCC CFR47 Part 15 Section 15.407 & 15.209 & 15.205																													
<b>Test Method:</b>	KDB 789033 D02 v02r01																													
<b>Frequency Range:</b>	9kHz to 40GHz																													
<b>Measurement Distance:</b>	3 m																													
<b>Antenna Polarization:</b>	Horizontal & Vertical																													
<b>Operation mode:</b>	Transmitting mode with modulation																													
<b>Receiver Setup:</b>	<table border="1"> <thead> <tr> <th>Frequency</th> <th>Detector</th> <th>RBW</th> <th>VBW</th> <th>Remark</th> </tr> </thead> <tbody> <tr> <td>9kHz- 150kHz</td> <td>Quasi-peak</td> <td>200Hz</td> <td>1kHz</td> <td>Quasi-peak Value</td> </tr> <tr> <td>150kHz- 30MHz</td> <td>Quasi-peak</td> <td>9kHz</td> <td>30kHz</td> <td>Quasi-peak Value</td> </tr> <tr> <td>30MHz-1GHz</td> <td>Quasi-peak</td> <td>120KHz</td> <td>300KHz</td> <td>Quasi-peak Value</td> </tr> <tr> <td rowspan="2">Above 1GHz</td> <td>Peak</td> <td>1MHz</td> <td>3MHz</td> <td>Peak Value</td> </tr> <tr> <td>Peak</td> <td>1MHz</td> <td>10Hz</td> <td>Average Value</td> </tr> </tbody> </table>	Frequency	Detector	RBW	VBW	Remark	9kHz- 150kHz	Quasi-peak	200Hz	1kHz	Quasi-peak Value	150kHz- 30MHz	Quasi-peak	9kHz	30kHz	Quasi-peak Value	30MHz-1GHz	Quasi-peak	120KHz	300KHz	Quasi-peak Value	Above 1GHz	Peak	1MHz	3MHz	Peak Value	Peak	1MHz	10Hz	Average Value
	Frequency	Detector	RBW	VBW	Remark																									
	9kHz- 150kHz	Quasi-peak	200Hz	1kHz	Quasi-peak Value																									
	150kHz- 30MHz	Quasi-peak	9kHz	30kHz	Quasi-peak Value																									
	30MHz-1GHz	Quasi-peak	120KHz	300KHz	Quasi-peak Value																									
Above 1GHz	Peak	1MHz	3MHz	Peak Value																										
	Peak	1MHz	10Hz	Average Value																										
<b>Limit:</b>	<p>(1) For transmitters operating in the 5.725-5.85 GHz band:</p> <p>(i) All emissions shall be limited to a level of -27 dBm/MHz at 75 MHz or more above or below the band edge increasing linearly to 10 dBm/MHz at 25 MHz above or below the band edge, and from 25 MHz above or below the band edge increasing linearly to a level of 15.6 dBm/MHz at 5 MHz above or below the band edge, and from 5 MHz above or below the band edge increasing linearly to a level of 27 dBm/MHz at the band edge.</p> <p>The limit of frequency below 1GHz and which fall in restricted b ands should complies 15.209.</p>																													
<b>Test setup:</b>	<p>For radiated emissions below 30MHz</p> <p>30MHz to 1GHz</p>																													

	<p><b>Above 1GHz</b></p>
<p><b>Test Procedure:</b></p>	<ol style="list-style-type: none"> <li>1. The EUT was placed on the top of a rotating table 0.8 meters above the ground at a 3 meter camber. The table was rotated 360 degrees to determine the position of the highest radiation.</li> <li>2. The EUT was set 3 meters away from the interference-receiving antenna, which was mounted on the top of a variable-height antenna tower.</li> <li>3. The antenna height is varied from one meter to four meters above the ground to determine the maximum value of the field strength. Both horizontal and vertical polarizations of the antenna are set to make the measurement.</li> <li>4. For each suspected emission, the EUT was arranged to its worst case and then the antenna was tuned to heights from 1 meter to 4 meters and the rotatable was turned from 0 degrees to 360 degrees to find the maximum reading.</li> <li>5. The test-receiver system was set to Peak Detect Function and Specified Bandwidth with Maximum Hold Mode.</li> <li>6. If the emission level of the EUT in peak mode was 10dB lower than the limit specified, then testing could be stopped and the peak values of the EUT would be reported. Otherwise the emissions that did not have 10dB margin would bere-tested one by one using peak, quasi-peak or average method as specified and then reported in a data sheet.</li> </ol>
<p><b>Test results:</b></p>	<p>PASS</p>

The results shown in this test report refer only to the sample(s) tested unless otherwise stated and the sample(s) are retained for 30 days only. The document is issued by HUAK, this document cannot be reproduced except in full with our prior written permission. The more details and the authenticity of the report will be confirmed at <http://www.cer-mark.com>.



### 4.7.2. Test Data

test mode: TX 802.11a 5745MHz

All the test modes completed for test. The worst case of Radiated Emission; the test data of this mode was reported.

#### Below 1GHz

#### Horizontal

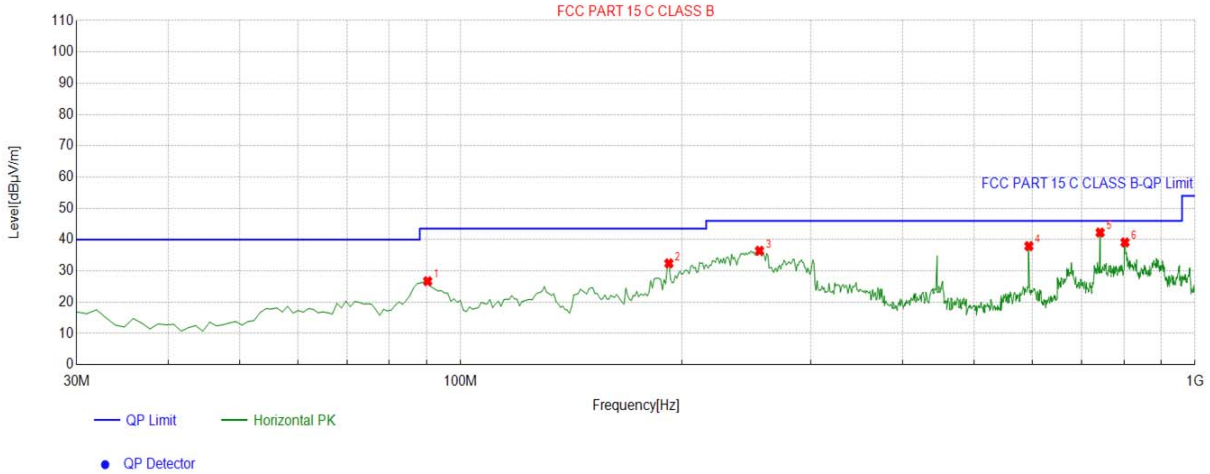

Suspected List									
NO.	Freq. [MHz]	Factor [dB]	Reading [dBµV/m]	Level [dBµV/m]	Limit [dBµV/m]	Margin [dB]	Height [cm]	Angle [°]	Polarity
1	90.2002	-17.04	43.72	26.68	43.50	16.82	100	133	Horizontal
2	192.1522	-15.81	48.19	32.38	43.50	11.12	100	153	Horizontal
3	255.2653	-13.46	49.87	36.41	46.00	9.59	100	351	Horizontal
4	594.1341	-6.50	44.42	37.92	46.00	8.08	100	359	Horizontal
5	742.6927	-4.02	46.27	42.25	46.00	3.75	100	53	Horizontal
6	802.8929	-3.07	42.17	39.10	46.00	6.90	100	331	Horizontal

Remark: Factor = Cable loss + Antenna factor – Preamplifier; Level = Reading + Factor; Margin = Limit – Level



Vertical

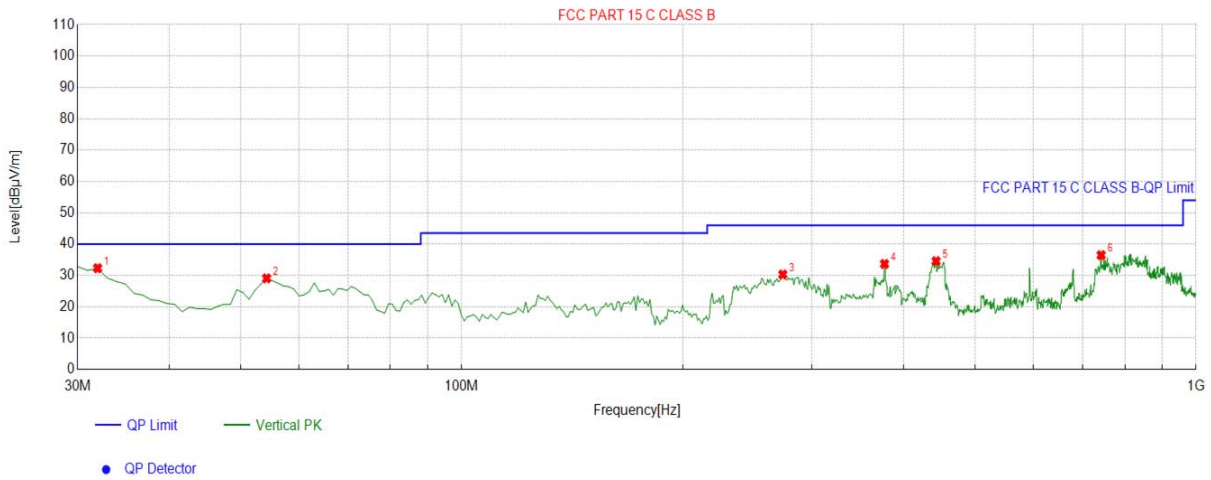

Suspected List									
NO.	Freq. [MHz]	Factor [dB]	Reading [dBµV/m]	Level [dBµV/m]	Limit [dBµV/m]	Margin [dB]	Height [cm]	Angle [°]	Polarity
1	31.9419	-16.26	48.57	32.31	40.00	7.69	100	306	Vertical
2	54.2743	-14.30	43.37	29.07	40.00	10.93	100	68	Vertical
3	273.7137	-13.51	43.80	30.29	46.00	15.71	100	33	Vertical
4	376.6366	-10.88	44.54	33.66	46.00	12.34	100	25	Vertical
5	442.6627	-9.31	43.86	34.55	46.00	11.45	100	5	Vertical
6	742.6927	-4.02	40.49	36.47	46.00	9.53	100	1	Vertical

Remark: Factor = Cable loss + Antenna factor – Pre-amplifier; Level = Reading + Factor; Margin = Limit – Level

**Harmonics and Spurious Emissions**  
**Frequency Range (9 kHz-30MHz)**

Frequency (MHz)	Level@3m (dBµV/m)	Limit@3m (dBµV/m)
--	--	--
--	--	--
--	--	--
--	--	--

**Note:** 1. Emission Level=Reading+ Cable loss-Antenna factor-Amp factor.  
 2. The emission levels are 20 dB below the limit value, which are not reported. It is deemed to comply with the requirement.



**Above 1GHz**

5.8G 802.11 a Mode

All modes of operation were investigated and the worst-case of Antenna 1 are reported.

LOW CH 149

Horizontal:

Frequency (MHz)	Meter Reading (dBµV)	Factor (dB)	Emission Level (dBµV/m)	Limits (dBµV/m)	Margin (dB)	Detector Type
3368	63.13	-4.59	58.54	68.2	-9.66	peak
11096	52.35	4.21	56.56	74	-17.44	peak
11096	42.65	4.21	46.86	54	-7.14	AVG

Remark: Factor = Antenna Factor + Cable Loss – Pre-amplifier.

Vertical:

Frequency (MHz)	Meter Reading (dBµV)	Factor (dB)	Emission Level (dBµV/m)	Limits (dBµV/m)	Margin (dB)	Detector Type
3368	62.06	-4.59	57.47	68.2	-10.73	peak
11096	52.95	4.21	57.16	74	-16.84	peak
11096	39.16	4.21	43.37	54	-10.63	AVG

Remark: Factor = Antenna Factor + Cable Loss – Pre-amplifier.





MID CH157

Horizontal:

Frequency	Meter Reading	Factor	Emission Level	Limits	Margin	Detector Type
(MHz)	(dBμV)	(dB)	(dBμV/m)	(dBμV/m)	(dB)	
3172	60.49	-4.59	55.9	68.2	-12.3	peak
10523	50.56	4.21	54.77	68.2	-13.43	peak

Remark: Factor = Antenna Factor + Cable Loss – Pre-amplifier.

Vertical:

Frequency	Meter Reading	Factor	Emission Level	Limits	Margin	Detector Type
(MHz)	(dBμV)	(dB)	(dBμV/m)	(dBμV/m)	(dB)	
3172	56.09	-4.59	51.5	68.2	-16.7	peak
10523	54.25	4.21	58.46	68.2	-9.74	peak

Remark: Factor = Antenna Factor + Cable Loss – Pre-amplifier.



HIGH CH165

Horizontal:

Frequency (MHz)	Meter Reading (dBµV)	Factor (dB)	Emission Level (dBµV/m)	Limits (dBµV/m)	Margin (dB)	Detector Type
2705	58.18	-4.59	53.59	74	-20.41	peak
2705	46.22	-4.59	41.63	54	-12.37	AVG
11717	53.32	4.84	58.16	74	-15.84	peak
11717	34.27	4.84	39.11	54	-14.89	AVG

Remark: Factor = Antenna Factor + Cable Loss – Pre-amplifier.

Vertical:

Frequency (MHz)	Meter Reading (dBµV)	Factor (dB)	Emission Level (dBµV/m)	Limits (dBµV/m)	Margin (dB)	Detector Type
2705	56.13	-4.59	51.54	74	-22.46	peak
2705	45.73	-4.59	41.14	54	-12.86	AVG
11717	51.09	4.84	55.93	74	-18.07	peak
11717	37.86	4.84	42.7	54	-11.3	AVG

Remark: Factor = Antenna Factor + Cable Loss – Pre-amplifier.

Remark:

- (1) Measuring frequencies from 1 GHz to the 40 GHz.
- (2) "F" denotes fundamental frequency; "H" denotes spurious frequency; "E" denotes band edge frequency.
- (3) \* denotes emission frequency which appearing within the Restricted Bands specified in provision of 15.205, then the general radiated emission limits in 15.209 apply.
- (4) The emissions are attenuated more than 20dB below the permissible limits are not record in the report.
- (5) The IF bandwidth of EMI Test Receiver between 30MHz to 1GHz was 120KHz, 1 MHz for measuring above 1 GHz, below 30MHz was 10KHz.
- (6) When the test results of Peak Detected below the limits of Average Detected, the Average Detected is not need completed. For example: Top Channel at Fundamental 73.16dBuV/m(PK Value) <93.98(AV Limit), at harmonic 53.20 dBuV/m(PK Value) <54 dBuV/m(AV Limit), the Average Detected not need to completed.



5.8G 802.11n20 Mode

All modes of operation were investigated and the worst-case of MIMO are reported.

LOW CH 149

Horizontal:

Frequency	Meter Reading	Factor	Emission Level	Limits	Margin	Detector Type
(MHz)	(dBμV)	(dB)	(dBμV/m)	(dBμV/m)	(dB)	
3368	60.05	-4.59	55.46	68.2	-12.74	peak
11096	53.83	4.21	58.04	74	-15.96	peak
11096	44.11	4.21	48.32	54	-5.68	AVG

Remark: Factor = Antenna Factor + Cable Loss – Pre-amplifier.

Vertical:

Frequency	Meter Reading	Factor	Emission Level	Limits	Margin	Detector Type
(MHz)	(dBμV)	(dB)	(dBμV/m)	(dBμV/m)	(dB)	
3368	61.25	-4.59	56.66	68.2	-11.54	peak
11096	56.09	4.21	60.3	74	-13.7	peak
11096	36.46	4.21	40.67	54	-13.33	AVG

Remark: Factor = Antenna Factor + Cable Loss – Pre-amplifier.



MID CH157

Horizontal:

Frequency	Meter Reading	Factor	Emission Level	Limits	Margin	Detector Type
(MHz)	(dBμV)	(dB)	(dBμV/m)	(dBμV/m)	(dB)	
3172	61.92	-4.59	57.33	68.2	-10.87	peak
10523	53.03	4.21	57.24	68.2	-10.96	peak

Remark: Factor = Antenna Factor + Cable Loss – Pre-amplifier.

Vertical:

Frequency	Meter Reading	Factor	Emission Level	Limits	Margin	Detector Type
(MHz)	(dBμV)	(dB)	(dBμV/m)	(dBμV/m)	(dB)	
3172	58.38	-4.59	53.79	68.2	-14.41	peak
10523	55.25	4.21	59.46	68.2	-8.74	peak

Remark: Factor = Antenna Factor + Cable Loss – Pre-amplifier.



HIGH CH165

Horizontal:

Frequency (MHz)	Meter Reading (dBµV)	Factor (dB)	Emission Level (dBµV/m)	Limits (dBµV/m)	Margin (dB)	Detector Type
2705	56.55	-4.59	51.96	74	-22.04	peak
2705	47.93	-4.59	43.34	54	-10.66	AVG
11717	54.21	4.84	59.05	74	-14.95	peak
11717	37.46	4.84	42.3	54	-11.7	AVG

Remark: Factor = Antenna Factor + Cable Loss – Pre-amplifier.

Vertical:

Frequency (MHz)	Meter Reading (dBµV)	Factor (dB)	Emission Level (dBµV/m)	Limits (dBµV/m)	Margin (dB)	Detector Type
2705	58.06	-4.59	53.47	74	-20.53	peak
2705	44.86	-4.59	40.27	54	-13.73	AVG
11717	54.25	4.84	59.09	74	-14.91	peak
11717	40.14	4.84	44.98	54	-9.02	AVG

Remark: Factor = Antenna Factor + Cable Loss – Pre-amplifier.

Remark:

- (1) Measuring frequencies from 1 GHz to the 40 GHz.
- (2) "F" denotes fundamental frequency; "H" denotes spurious frequency; "E" denotes band edge frequency.
- (3) \* denotes emission frequency which appearing within the Restricted Bands specified in provision of 15.205, then the general radiated emission limits in 15.209 apply.
- (4) The emissions are attenuated more than 20dB below the permissible limits are not record in the report.
- (5) The IF bandwidth of EMI Test Receiver between 30MHz to 1GHz was 120KHz, 1 MHz for measuring above 1 GHz, below 30MHz was 10KHz.
- (6) When the test results of Peak Detected below the limits of Average Detected, the Average Detected is not need completed. For example: Top Channel at Fundamental 73.16dBuV/m(PK Value) <93.98(AV Limit), at harmonic 53.20 dBuV/m(PK Value) <54 dBuV/m(AV Limit), the Average Detected not need to completed.



5.8G 802.11n40 Mode

All modes of operation were investigated and the worst-case of MIMO are reported.

LOW CH 151

Horizontal:

Frequency (MHz)	Meter Reading (dBμV)	Factor (dB)	Emission Level (dBμV/m)	Limits (dBμV/m)	Margin (dB)	Detector Type
3368	63.27	-4.59	58.68	68.2	-9.52	peak
11096	50.87	4.21	55.08	74	-18.92	peak
11096	41.04	4.21	45.25	54	-8.75	AVG

Remark: Factor = Antenna Factor + Cable Loss – Pre-amplifier.

Vertical:

Frequency (MHz)	Meter Reading (dBμV)	Factor (dB)	Emission Level (dBμV/m)	Limits (dBμV/m)	Margin (dB)	Detector Type
3368	61.77	-4.59	57.18	68.2	-11.02	peak
11096	56.87	4.21	61.08	74	-12.92	peak
11096	35.44	4.21	39.65	54	-14.35	AVG

Remark: Factor = Antenna Factor + Cable Loss – Pre-amplifier.



MID CH159

Horizontal:

Frequency	Meter Reading	Factor	Emission Level	Limits	Margin	Detector Type
(MHz)	(dBμV)	(dB)	(dBμV/m)	(dBμV/m)	(dB)	
3172	64.72	-4.59	60.13	68.2	-8.07	peak
10523	52.85	4.21	57.06	68.2	-11.14	peak

Remark: Factor = Antenna Factor + Cable Loss – Pre-amplifier.

Vertical:

Frequency	Meter Reading	Factor	Emission Level	Limits	Margin	Detector Type
(MHz)	(dBμV)	(dB)	(dBμV/m)	(dBμV/m)	(dB)	
3172	57.12	-4.59	52.53	68.2	-15.67	peak
10523	55.41	4.21	59.62	68.2	-8.58	peak

Remark: Factor = Antenna Factor + Cable Loss – Pre-amplifier.

Remark:

- (1) Measuring frequencies from 1 GHz to the 40 GHz.
- (2) "F" denotes fundamental frequency; "H" denotes spurious frequency; "E" denotes band edge frequency.
- (3) \* denotes emission frequency which appearing within the Restricted Bands specified in provision of 15.205, then the general radiated emission limits in 15.209 apply.
- (4) The emissions are attenuated more than 20dB below the permissible limits are not record in the report.
- (5) The IF bandwidth of EMI Test Receiver between 30MHz to 1GHz was 120KHz, 1 MHz for measuring above 1 GHz, below 30MHz was 10KHz.
- (6) When the test results of Peak Detected below the limits of Average Detected, the Average Detected is not need completed. For example: Top Channel at Fundamental 73.16dBuV/m(PK Value) <93.98(AV Limit), at harmonic 53.20 dBuV/m(PK Value) <54 dBuV/m(AV Limit), the Average Detected not need to completed.



5.8G 802.11ac20 Mode

All modes of operation were investigated and the worst-case of MIMO are reported.

LOW CH 149

Horizontal:

Frequency (MHz)	Meter Reading (dBμV)	Factor (dB)	Emission Level (dBμV/m)	Limits (dBμV/m)	Margin (dB)	Detector Type
3368	68.73	-4.59	64.14	68.2	-4.06	peak
11096	51.24	4.21	55.45	74	-18.55	peak
11096	36.53	4.21	40.74	54	-13.26	AVG

Remark: Factor = Antenna Factor + Cable Loss – Pre-amplifier.

Vertical:

Frequency (MHz)	Meter Reading (dBμV)	Factor (dB)	Emission Level (dBμV/m)	Limits (dBμV/m)	Margin (dB)	Detector Type
3368	63.65	-4.59	59.06	68.2	-9.14	peak
11096	53.44	4.21	57.65	74	-16.35	peak
11096	36.49	4.21	40.7	54	-13.3	AVG

Remark: Factor = Antenna Factor + Cable Loss – Pre-amplifier.





MID CH157

Horizontal:

Frequency	Meter Reading	Factor	Emission Level	Limits	Margin	Detector Type
(MHz)	(dBμV)	(dB)	(dBμV/m)	(dBμV/m)	(dB)	
3172	62.66	-4.59	58.07	68.2	-10.13	peak
10523	53.83	4.21	58.04	68.2	-10.16	peak

Remark: Factor = Antenna Factor + Cable Loss – Pre-amplifier.

Vertical:

Frequency	Meter Reading	Factor	Emission Level	Limits	Margin	Detector Type
(MHz)	(dBμV)	(dB)	(dBμV/m)	(dBμV/m)	(dB)	
3172	56.59	-4.59	52	68.2	-16.2	peak
10523	54.11	4.21	58.32	68.2	-9.88	peak

Remark: Factor = Antenna Factor + Cable Loss – Pre-amplifier.



HIGH CH165

Horizontal:

Frequency (MHz)	Meter Reading (dBμV)	Factor (dB)	Emission Level (dBμV/m)	Limits (dBμV/m)	Margin (dB)	Detector Type
2705	60.54	-4.59	55.95	74	-18.05	peak
2705	47.13	-4.59	42.54	54	-11.46	AVG
11717	56.25	4.84	61.09	74	-12.91	peak
11717	40.95	4.84	45.79	54	-8.21	AVG

Remark: Factor = Antenna Factor + Cable Loss – Pre-amplifier.

Vertical:

Frequency (MHz)	Meter Reading (dBμV)	Factor (dB)	Emission Level (dBμV/m)	Limits (dBμV/m)	Margin (dB)	Detector Type
2705	58.41	-4.59	53.82	74	-20.18	peak
2705	44.79	-4.59	40.2	54	-13.8	AVG
11717	51.11	4.84	55.95	74	-18.05	peak
11717	39.08	4.84	43.92	54	-10.08	AVG

Remark: Factor = Antenna Factor + Cable Loss – Pre-amplifier.

Remark:

- (1) Measuring frequencies from 1 GHz to the 40 GHz.
- (2) "F" denotes fundamental frequency; "H" denotes spurious frequency; "E" denotes band edge frequency.
- (3) \* denotes emission frequency which appearing within the Restricted Bands specified in provision of 15.205, then the general radiated emission limits in 15.209 apply.
- (4) The emissions are attenuated more than 20dB below the permissible limits are not record in the report.
- (5) The IF bandwidth of EMI Test Receiver between 30MHz to 1GHz was 120KHz, 1 MHz for measuring above 1 GHz, below 30MHz was 10KHz.
- (6) When the test results of Peak Detected below the limits of Average Detected, the Average Detected is not need completed. For example: Top Channel at Fundamental 73.16dBuV/m(PK Value) <93.98(AV Limit), at harmonic 53.20 dBuV/m(PK Value) <54 dBuV/m(AV Limit), the Average Detected not need to completed.



5.8G 802.11ac40 Mode

All modes of operation were investigated and the worst-case of MIMO are reported.

LOW CH 151

Horizontal:

Frequency	Meter Reading	Factor	Emission Level	Limits	Margin	Detector Type
(MHz)	(dBμV)	(dB)	(dBμV/m)	(dBμV/m)	(dB)	
3368	64.13	-4.59	59.54	68.2	-8.66	peak
11096	50.27	4.21	54.48	74	-19.52	peak
11096	41.64	4.21	45.85	54	-8.15	AVG

Remark: Factor = Antenna Factor + Cable Loss – Pre-amplifier.

Vertical:

Frequency	Meter Reading	Factor	Emission Level	Limits	Margin	Detector Type
(MHz)	(dBμV)	(dB)	(dBμV/m)	(dBμV/m)	(dB)	
3368	61.18	-4.59	56.59	68.2	-11.61	peak
11096	52.71	4.21	56.92	74	-17.08	peak
11096	39.87	4.21	44.08	54	-9.92	AVG

Remark: Factor = Antenna Factor + Cable Loss – Pre-amplifier.



MID CH159

Horizontal:

Frequency	Meter Reading	Factor	Emission Level	Limits	Margin	Detector Type
(MHz)	(dBμV)	(dB)	(dBμV/m)	(dBμV/m)	(dB)	
3172	61.88	-4.59	57.29	68.2	-10.91	peak
10523	53.96	4.21	58.17	68.2	-10.03	peak

Remark: Factor = Antenna Factor + Cable Loss – Pre-amplifier.

Vertical:

Frequency	Meter Reading	Factor	Emission Level	Limits	Margin	Detector Type
(MHz)	(dBμV)	(dB)	(dBμV/m)	(dBμV/m)	(dB)	
3172	58.26	-4.59	53.67	68.2	-14.53	peak
10523	53.05	4.21	57.26	68.2	-10.94	peak

Remark: Factor = Antenna Factor + Cable Loss – Pre-amplifier.

Remark:

- (1) Measuring frequencies from 1 GHz to the 40 GHz.
- (2) "F" denotes fundamental frequency; "H" denotes spurious frequency; "E" denotes band edge frequency.
- (3) \* denotes emission frequency which appearing within the Restricted Bands specified in provision of 15.205, then the general radiated emission limits in 15.209 apply.
- (4) The emissions are attenuated more than 20dB below the permissible limits are not record in the report.
- (5) The IF bandwidth of EMI Test Receiver between 30MHz to 1GHz was 120KHz, 1 MHz for measuring above 1 GHz, below 30MHz was 10KHz.
- (6) When the test results of Peak Detected below the limits of Average Detected, the Average Detected is not need completed. For example: Top Channel at Fundamental 73.16dBuV/m(PK Value) <93.98(AV Limit), at harmonic 53.20 dBuV/m(PK Value) <54 dBuV/m(AV Limit), the Average Detected not need to completed.



5.8G 802.11ac80 Mode

All modes of operation were investigated and the worst-case of MIMO are reported.  
CH 155

Horizontal:

Frequency	Meter Reading	Factor	Emission Level	Limits	Margin	Detector Type
(MHz)	(dBµV)	(dB)	(dBµV/m)	(dBµV/m)	(dB)	
3368	66.46	-4.59	61.87	68.2	-6.33	peak
11096	52.19	4.21	56.4	74	-17.6	peak
11096	40.61	4.21	44.82	54	-9.18	AVG

Remark: Factor = Antenna Factor + Cable Loss – Pre-amplifier.

Vertical:

Frequency	Meter Reading	Factor	Emission Level	Limits	Margin	Detector Type
(MHz)	(dBµV)	(dB)	(dBµV/m)	(dBµV/m)	(dB)	
3368	61.49	-4.59	56.9	68.2	-11.3	peak
11096	56.67	4.21	60.88	74	-13.12	peak
11096	37.28	4.21	41.49	54	-12.51	AVG

Remark: Factor = Antenna Factor + Cable Loss – Pre-amplifier.

Remark:

- (1) Measuring frequencies from 1 GHz to the 40 GHz.
- (2) "F" denotes fundamental frequency; "H" denotes spurious frequency; "E" denotes band edge frequency.
- (3) \* denotes emission frequency which appearing within the Restricted Bands specified in provision of 15.205, then the general radiated emission limits in 15.209 apply.
- (4) The emissions are attenuated more than 20dB below the permissible limits are not record in the report.
- (5) The IF bandwidth of EMI Test Receiver between 30MHz to 1GHz was 120KHz, 1 MHz for measuring above 1 GHz, below 30MHz was 10KHz.
- (6) When the test results of Peak Detected below the limits of Average Detected, the Average Detected is not need completed. For example: Top Channel at Fundamental 73.16dBuV/m(PK Value) <93.98(AV Limit), at harmonic 53.20 dBuV/m(PK Value) <54 dBuV/m(AV Limit), the Average Detected not need to completed.



### 4.8. FREQUENCY STABILITY MEASUREMENT

#### 4.8.1. Test Specification

<b>Test Requirement:</b>	FCC Part15 Section 15.407(g)
<b>Test Method:</b>	ANSI C63.10: 2013
<b>Limit:</b>	The frequency tolerance shall be maintained within the band of operation frequency over a temperature variation of 0 degrees to 35 degrees C at normal supply voltage, and for a variation in the primary supply voltage from 85% to 115% of the rated supply voltage at a temperature of 20 degrees C.
<b>Test Setup:</b>	<pre> graph LR     SA[Spectrum Analyzer] --- EUT[EUT]     subgraph TC [Temperature Chamber]         EUT     end     P[AC/DC Power supply] --- EUT </pre>
<b>Test Procedure:</b>	The EUT was placed inside the environmental test chamber and powered by nominal AC/DC voltage. b. Turn the EUT on and couple its output to a spectrum analyzer. c. Turn the EUT off and set the chamber to the highest temperature specified. d. Allow sufficient time (approximately 30 min) for the temperature of the chamber to stabilize. e. Repeat step 2 and 3 with the temperature chamber set to the lowest temperature. f. The test chamber was allowed to stabilize at +20 degree C for a minimum of 30 minutes. The supply voltage was then adjusted on the EUT from 85% to 115% and the frequency record.
<b>Test Result:</b>	PASS
<b>Remark:</b>	N/A

The results shown in this test report refer only to the sample(s) tested unless otherwise stated and the sample(s) are retained for 30 days only. The document is issued by HUAKE, this document cannot be reproduced except in full with our prior written permission. The more details and the authenticity of the report will be confirmed at <http://www.cer-mark.com>.



Test Result as follows:

Mode	Voltage (V)	FHL (5745MHz)	Deviation (KHz)	FHH (5825MHz)	Deviation (KHz)
5.8G Band	10.20V	5744.985	-15	5825.014	14
	12.00V	5745.029	29	5824.976	-24
	13.80V	5744.973	-27	5824.981	-19

Mode	Temperature (°C)	FHL (5745MHz)	Deviation (KHz)	FHH (5825MHz)	Deviation (KHz)
5.8G Band	-30	5744.984	-16	5824.968	-32
	-20	5745.012	12	5825.018	18
	-10	5745.009	9	5824.985	-15
	0	5745.017	17	5824.979	-21
	10	5744.975	-25	5824.981	-19
	20	5744.964	-36	5824.982	-18
	30	5745.023	23	5824.971	-29
	40	5744.972	-28	5824.955	-45
	50	5744.976	-24	5825.012	12

The results shown in this test report refer only to the sample(s) tested unless otherwise stated and the sample(s) are retained for 30 days only. The document is issued by HUAKE, this document cannot be reproduced except in full with our prior written permission. The more details and the authenticity of the report will be confirmed at <http://www.cer-mark.com>.

## 4.9. ANTENNA REQUIREMENT

### Standard Applicable

For intentional device, according to FCC 47 CFR Section 15.203, an intentional radiator shall be designed to ensure that no antenna other than that furnished by the responsible party shall be used with the device. And according to FCC 47 CFR Section 15.249, if transmitting antennas of directional gain greater than 6dBi are used, the power shall be reduced by the amount in dB that the directional gain of the antenna exceeds 6dBi.

### Refer to statement below for compliance.

The manufacturer may design the unit so that the user can replace a broken antenna, but the use of a standard antenna jack or electrical connector is prohibited. Further, this requirement does not apply to intentional radiators that must be professionally installed.

### Antenna Connected Construction

The antenna used in this product is a Internal Antenna, need professional installation, It conforms to the standard requirements. and the best case gain of the antenna is Antenna port 1:2.6dBi and Antenna port 2:3.4dBi.

### WIFI ANTENNA

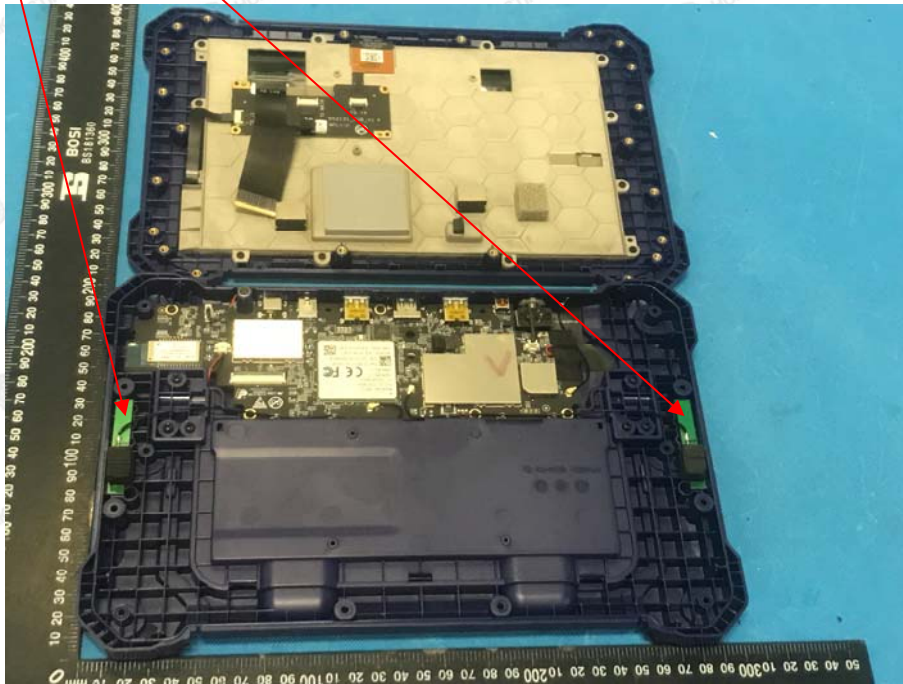





## 5. PHOTOGRAPHS OF TEST SETUP

### Radiated Emission

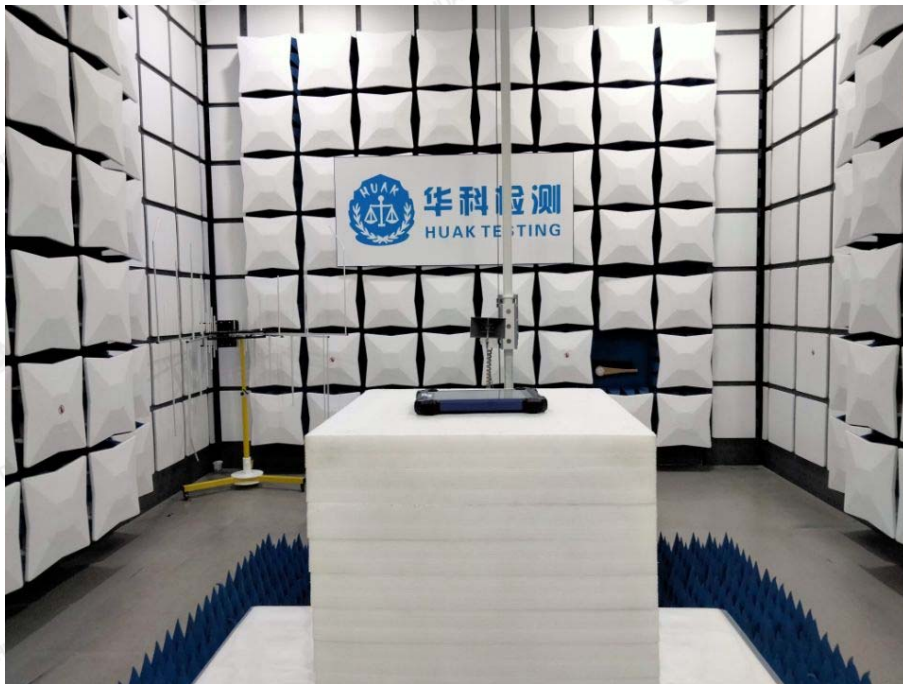
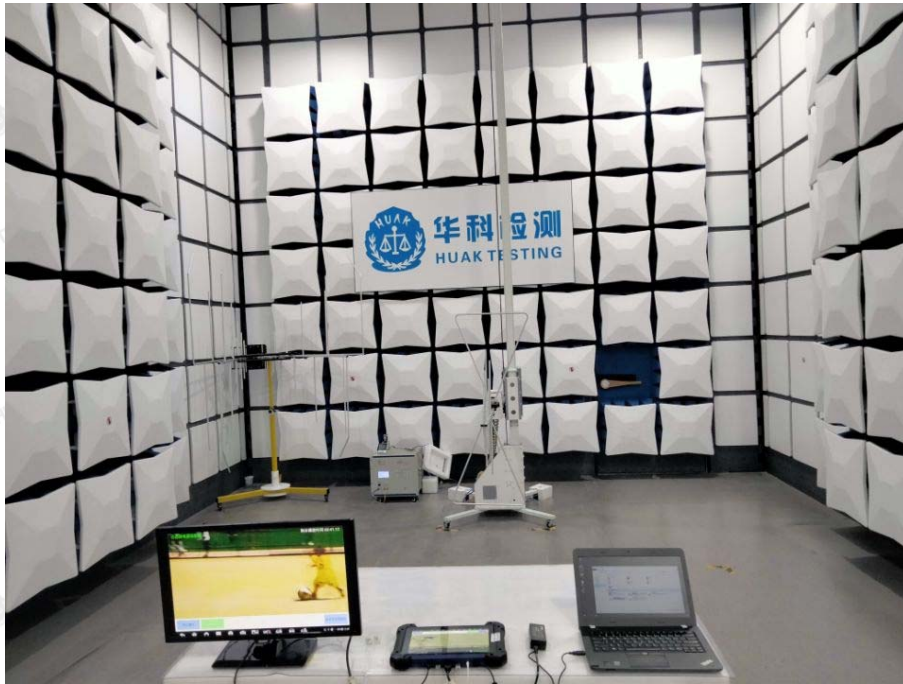

The results shown in this test report refer only to the sample(s) tested unless otherwise stated and the sample(s) are retained for 30 days only. The document is issued by HUAK, this document cannot be reproduced except in full with our prior written permission. The more details and the authenticity of the report will be confirmed at <http://www.cer-mark.com>.

HUAK Testing Lab TEL : +86-755 2302 9901 FAX : +86-755 2302 9901 E-mail : [service@cer-mark.com](mailto:service@cer-mark.com)

1-2/F., Building B2, Junfeng Zhongcheng Zhizao Innovation Park, Heping, Fuhai Street, Bao'an District, Shenzhen, Guangdong, China



### Conducted Emission



The results shown in this test report refer only to the sample(s) tested unless otherwise stated and the sample(s) are retained for 30 days only. The document is issued by HUAK, this document cannot be reproduced except in full with our prior written permission. The more details and the authenticity of the report will be confirmed at <http://www.cer-mark.com>.

**HUAK Testing Lab** TEL : +86-755 2302 9901 FAX : +86-755 2302 9901 E-mail : [service@cer-mark.com](mailto:service@cer-mark.com)

1-2/F., Building B2, Junfeng Zhongcheng Zhizao Innovation Park, Heping, Fuhai Street, Bao'an District, Shenzhen, Guangdong, China



## **6. PHOTOS OF THE EUT**

Reference to the report: ANNEX A of external photos and ANNEX B of internal photos.

-----End of report-----