



FCC TEST REPORT

FCC ID: WQ8-DV2221

Report Number: ZKT-230619L4592E2

Date of Test..... Jun. 15, 2023 – Jun. 28, 2023

Date of issue.....: Jul. 13, 2023

Total number of pages 75

Test Result: PASS

Testing Laboratory.....: Shenzhen ZKT Technology Co., Ltd.

Address: 1/F, No. 101, Building B, No. 6, Tangwei Community Industrial Avenue, Fuhai Street, Bao'an District, Shenzhen, China

Applicant's name: Autel Intelligent Technology Corp., Ltd.

Address: Floor 2, Caihong Keji Building, 36 Hi-tech North Six Road, Songpingshan Community, Xili Sub-district, Nanshan District, Shenzhen City, China

Manufacturer's name: Autel Intelligent Technology Corp., Ltd.

Address: Floor 2, Caihong Keji Building, 36 Hi-tech North Six Road, Songpingshan Community, Xili Sub-district, Nanshan District, Shenzhen City, China

Test specification:

Standard: FCC CFR Title 47 Part 15 Subpart C Section 15.247
ANSI C63.10:2013

Test procedure: /

Non-standard test method: N/A

Test Report Form No.: TRF-EL-112_V0

Test Report Form(s) Originator....: ZKT Testing

Master TRF: Dated: 2021-04-22

This device described above has been tested by ZKT, and the test results show that the equipment under test (EUT) is in compliance with the FCC requirements. And it is applicable only to the tested sample identified in the report.

This report shall not be reproduced except in full, without the written approval of ZKT, this document may be altered or revised by ZKT, personal only, and shall be noted in the revision of the document.

Product name.....: ADVANCED DIAGNOSTICS & INFORMATION SYSTEM

Trademark: AUTEL

Model/Type reference.....: MaxiSys MS908S3

Input: 12V--- 3A

Ratings.....: Battery: 3.85V--- 11600mAh, 44.66Wh



Testing procedure and testing location:

Testing Laboratory: Shenzhen ZKT Technology Co., Ltd.

Address.....: 1/F, No. 101, Building B, No. 6, Tangwei Community Industrial Avenue, Fuhai Street, Bao'an District, Shenzhen, China

Tested by (name + signature): Tom Zou

Reviewer (name + signature).....: Jackson Fang

Approved (name + signature): Lake Xie



Table of Contents

	Page
1. VERSION	5
2. TEST SUMMARY	6
2.1 TEST FACILITY	7
2.2 MEASUREMENT UNCERTAINTY	7
3. GENERAL INFORMATION	8
3.1 GENERAL DESCRIPTION OF EUT	8
3.2 Test Setup Configuration.....	9
3.3 Support Equipment.....	10
3.4 Test Mode	10
3.5 EQUIPMENTS LIST FOR ALL TEST ITEMS	11
4. EMC EMISSION TEST	13
4.1 Conducted emissions	13
4.1.1 POWER LINE CONDUCTED EMISSION Limits	13
4.1.2 TEST PROCEDURE	13
4.1.3 DEVIATION FROM TEST STANDARD.....	13
4.1.4 TEST SETUP	13
4.1.5 EUT OPERATING CONDITIONS.....	14
4.2 Radiated emissions	17
4.2.1 Radiated Emission Limits	17
4.2.2 TEST PROCEDURE	17
4.2.3 DEVIATION FROM TEST STANDARD.....	18
4.2.4 TEST SETUP	18
4.2.5 EUT OPERATING CONDITIONS.....	19
4.2.6 TEST RESULTS.....	19
5. RADIATED BAND EMISSION MEASUREMENT	25
5.1 Test Requirement:.....	25
5.2 TEST PROCEDURE	25
5.3 DEVIATION FROM TEST STANDARD.....	26
5.4 TEST SETUP	26
5.5 EUT OPERATING CONDITIONS.....	26
5.6 TEST RESULT	27
6. CONDUCTED BAND EDGE AND SPURIOUS EMISSION	29
6.1 Limit.....	29
6.2 Test Setup	29
6.3 Test procedure	29
6.4 DEVIATION FROM STANDARD.....	29
6.5 Test Result	30
7. 20DB BANDWIDTH	46
7.1 Test Setup	46
7.2 Limit.....	46
7.3 Test procedure	46
7.4 DEVIATION FROM STANDARD.....	46
7.5 Test Result	46
8. MAXIMUM PEAK OUTPUT POWER	52
8.1 Block Diagram Of Test Setup.....	52
8.2 Limit.....	52
8.3 Test procedure	52
8.4 DEVIATION FROM STANDARD.....	52
8.5 Test Result	52



9. HOPPING CHANNEL SEPARATION	58
9.1 Test Setup	58
9.2 Test procedure	58
9.3 DEVIATION FROM STANDARD	58
9.4 Test Result	59
10. NUMBER OF HOPPING FREQUENCY	61
10.1 Test Setup	61
10.2 Test procedure	61
10.3 DEVIATION FROM STANDARD	61
10.4 Test Result	62
11. DWELL TIME	64
11.1 Test Setup	64
11.2 Test procedure	64
11.3 DEVIATION FROM STANDARD	64
11.4 Test Result	64
12. ANTENNA REQUIREMENT	74
13. TEST SETUP PHOTO	75
14. EUT CONSTRUCTIONAL DETAILS	75



1. VERSION

Report No.	Version	Description	Approved
ZKT-230619L4591E2	Rev.01	Initial issue of report	Jul. 13, 2023



2. TEST SUMMARY

Test procedures according to the technical standards:

FCC Part15 (15.247) , Subpart C			
Standard Section	Test Item	Result	Remark
15.203/15.247 (c)	Antenna Requirement	PASS	
15.207	AC Power Line Conducted Emission	PASS	
15.247 (b)(1)	Conducted Peak Output Power	PASS	
15.247 (a)(1)	20dB Occupied Bandwidth	PASS	
15.247 (a)(1)	Carrier Frequencies Separation	PASS	
15.247 (a)(1)(iii)	Hopping Channel Number	PASS	
15.247 (a)(1)(iii)	Dwell Time	PASS	
15.205/15.209	Radiated Emission and Restricted Band	PASS	
15.247(d)	Conducted Unwanted emissions and Band Edge	PASS	

NOTE:

(1) "N/A" denotes test is not applicable in this Test Report



2.1 TEST FACILITY

Shenzhen ZKT Technology Co., Ltd.
Add.: 1/F, No. 101, Building B, No. 6, Tangwei Community Industrial Avenue, Fuhai Street,
Bao'an District, Shenzhen, China

FCC Test Firm Registration Number: 692225
Designation Number: CN1299
IC Registered No.: 27033
Designation Number: CN0110

2.2 MEASUREMENT UNCERTAINTY

The reported uncertainty of measurement $y \pm U$, where expanded uncertainty U is based on a standard uncertainty multiplied by a coverage factor of $k=2$, providing a level of confidence of approximately 95%.

No.	Item	Uncertainty
1	3m chamber Radiated spurious emission(9KHz-30MHz)	U=4.5dB
2	3m chamber Radiated spurious emission(30MHz-1GHz)	U=4.8dB
3	3m chamber Radiated spurious emission(1GHz-6GHz)	U=4.9dB
4	3m chamber Radiated spurious emission(6GHz-40GHz)	U=5.0dB
5	Conducted disturbance	U=3.2dB
6	RF Band Edge	U=1.68dB
7	RF power conducted	U=1.86dB
8	RF conducted Spurious Emission	U=2.2dB
9	RF Occupied Bandwidth	U=1.8dB
10	RF Power Spectral Density	U=1.75dB
11	humidity uncertainty	U=5.3%
12	Temperature uncertainty	U=0.59°C



3. GENERAL INFORMATION

3.1 GENERAL DESCRIPTION OF EUT

Product Name:	ADVANCED DIAGNOSTICS & INFORMATION SYSTEM
Model No.:	MaxiSys MS908S3
Model Different.:	N/A
Serial No.:	N/A
Hardware Version:	DV2221_MAIN_V2
Software Version:	V01.01.00
Sample ID.:	ZKT-230619L4592E-1
Sample(s) Status:	Engineer sample
Channel numbers:	79
Operation Frequency:	2402MHz~2480MHz
Modulation technology:	GFSK, $\pi/4$ -DQPSK, 8-DPSK
Antenna Type:	PIFA Antenna
Antenna gain:	2.8 dBi
Power supply:	AC 120V, 60Hz/AC 240V, 60Hz DC 3.85V via Battery

Operation Frequency each of channel							
Channel	Frequency	Channel	Frequency	Channel	Frequency	Channel	Frequency
1	2402MHz	21	2422MHz	41	2442MHz	61	2462MHz
2	2403MHz	22	2423MHz	42	2443MHz	62	2463MHz
3	2404MHz	23	2424MHz	43	2444MHz	63	2464MHz
4	2405MHz	24	2425MHz	44	2445MHz	64	2465MHz
5	2406MHz	25	2426MHz	45	2446MHz	65	2466MHz
6	2407MHz	26	2427MHz	46	2447MHz	66	2467MHz
7	2408MHz	27	2428MHz	47	2448MHz	67	2468MHz
8	2409MHz	28	2429MHz	48	2449MHz	68	2469MHz
9	2410MHz	29	2430MHz	49	2450MHz	69	2470MHz
10	2411MHz	30	2431MHz	50	2451MHz	70	2471MHz
11	2412MHz	31	2432MHz	51	2452MHz	71	2472MHz
12	2413MHz	32	2433MHz	52	2453MHz	72	2473MHz
13	2414MHz	33	2434MHz	53	2454MHz	73	2474MHz
14	2415MHz	34	2435MHz	54	2455MHz	74	2475MHz
15	2416MHz	35	2436MHz	55	2456MHz	75	2476MHz
16	2417MHz	36	2437MHz	56	2457MHz	76	2477MHz
17	2418MHz	37	2438MHz	57	2458MHz	77	2478MHz
18	2419MHz	38	2439MHz	58	2459MHz	78	2479MHz



19	2420MHz	39	2440MHz	59	2460MHz	79	2480MHz
20	2421MHz	40	2441MHz	60	2461MHz		

Note:

In section 15.31(m), regards to the operating frequency range over 10 MHz, the Lowest frequency, the middle frequency, and the highest frequency of channel were selected to perform the test, and the selected channel see below:

Test channel	Frequency
The lowest channel	2402MHz
The middle channel	2441MHz
The Highest channel	2480MHz

3.2 Test Setup Configuration

Conducted Emission

AC Line

Radiated Emission

Conducted Spurious



3.3 Support Equipment

The EUT has been tested as an independent unit together with other necessary accessories or support units. The following support units or accessories were used to form a representative test configuration during the tests.

Item	Equipment	Mfr/Brand	Model/Type No.	Series No.	Note
E-1	ADVANCED DIAGNOSTICS & INFORMATION SYSTEM	AUTEL	MaxiSys MS908S3	N/A	EUT
A-1	MaxiFlash LVCI	AUTEL	MaxiFlash LVCI	N/A	Auxiliary
A-2	Adapter	AUTEL	N/A	N/A	Auxiliary

Item	Shielded Type	Ferrite Core	Length	Note

Note:

- (1) The support equipment was authorized by Declaration of Confirmation.
- (2) For detachable type I/O cable should be specified the length in cm in 『Length』 column.

3.4 Test Mode

Transmitting mode	Keep the EUT in continuously transmitting mode.
Remark: During the test, the test voltage was tuned from 85% to 115% of the nominal rated supply voltage, and found that the worst case was under the nominal rated supply condition. So the report just shows that condition's data.	

Test Software	BT Test Tool
Power level setup	<7dBm



3.5 EQUIPMENTS LIST FOR ALL TEST ITEMS

Radiation Test equipment

Item	Equipment	Manufacturer	Type No.	Serial No.	Last calibration	Calibrated until
1	Spectrum Analyzer (9kHz-26.5GHz)	KEYSIGHT	9020A	MY55370835	Oct. 28, 2022	Oct. 27, 2023
2	Spectrum Analyzer (10kHz-39.9GHz)	R&S	FSQ	100363	Oct. 28, 2022	Oct. 27, 2023
3	EMI Test Receiver (9kHz-7GHz)	R&S	ESC17	101169	Oct. 28, 2022	Oct. 27, 2023
4	Bilog Antenna (30MHz-1500MHz)	Schwarzbeck	VULB9168	N/A	Nov. 02, 2022	Nov. 01, 2023
5	Horn Antenna (1GHz-18GHz)	Agilent	AH-118	071145	Nov. 01, 2022	Oct. 31, 2023
6	Horn Antenna (15GHz-40GHz)	A.H.System	SAS-574	588	Oct. 28, 2022	Oct. 27, 2023
7	Loop Antenna	TESEQ	HLA6121	58357	Nov. 01, 2022	Oct. 31, 2023
8	Amplifier (30-1000MHz)	EM Electronics	EM330 Amplifier	060747	Nov. 15, 2022	Nov. 14, 2023
9	Amplifier (1GHz-26.5GHz)	Agilent	8449B	3008A00315	Oct. 28, 2022	Oct. 27, 2023
10	Amplifier (500MHz-40GHz)	全聚达	DLE-161	097	Oct. 28, 2022	Oct. 27, 2023
11	Test Cable	N/A	R-01	N/A	Oct. 28, 2022	Oct. 27, 2023
12	Test Cable	N/A	R-02	N/A	Oct. 28, 2022	Oct. 27, 2023
13	Test Cable	N/A	R-03	N/A	Oct. 28, 2022	Oct. 27, 2023
14	Magnetic Field Probe Tester	Narda	ELT-400	0-0344	Nov. 15, 2022	Nov. 14, 2023
15	D.C. Power Supply	LongWei	TPR-6405D	N/A	\	\
16	EMC Software	Frad	EZ-EMC	Ver.EMC-CO N 3A1.1	\	\
17	Turntable	MF	MF-7802BS	N/A	\	\
18	Antenna tower	MF	MF-7802BS	N/A	\	\



Conducted emissions Test

Item	Kind of Equipment	Manufacturer	Type No.	Serial No.	Last calibration	Calibrated until
1	LISN	R&S	ENV216	101471	Oct. 21, 2022	Oct. 20, 2023
2	LISN	CYBERTEK	EM5040A	E1850400149	Oct. 21, 2022	Oct. 20, 2023
3	Test Cable	N/A	C-01	N/A	Oct. 21, 2022	Oct. 20, 2023
4	Test Cable	N/A	C-02	N/A	Oct. 21, 2022	Oct. 20, 2023
5	Test Cable	N/A	C-03	N/A	Oct. 21, 2022	Oct. 20, 2023
6	EMI Test Receiver	R&S	ESCI3	101393	Oct. 28, 2022	Oct. 27, 2023
7	EMC Software	Frad	EZ-EMC	Ver.EMC-CO N 3A1.1	\	\



4. EMC EMISSION TEST

4.1 Conducted emissions

Test Requirement:	FCC Part15 C Section 15.207
Test Method:	ANSI C63.10:2013
Test Frequency Range:	150KHz to 30MHz
Receiver setup:	RBW=9KHz, VBW=30KHz, Sweep time=auto

4.1.1 POWER LINE CONDUCTED EMISSION Limits

FREQUENCY (MHz)	Limit (dBuV)		Standard
	Quasi-peak	Average	
0.15 -0.5	66 - 56 *	56 - 46 *	FCC
0.50 -5.0	56.00	46.00	FCC
5.0 -30.0	60.00	50.00	FCC

Note:

(1) *Decreases with the logarithm of the frequency.

4.1.2 TEST PROCEDURE

- a. The EUT was placed 0.8 meters from the horizontal ground plane with EUT being connected to the power mains through a line impedance stabilization network (LISN). All other support equipments powered from additional LISN(s). The LISN provide 50 Ohm/ 50uH of coupling impedance for the measuring instrument.
- b. Interconnecting cables that hang closer than 40 cm to the ground plane shall be folded back and forth in the center forming a bundle 30 to 40 cm long.
- c. I/O cables that are not connected to a peripheral shall be bundled in the center. The end of the cable may be terminated, if required, using the correct terminating impedance. The overall length shall not exceed 1 m.
- d. LISN at least 80 cm from nearest part of EUT chassis.
- e. For the actual test configuration, please refer to the related Item –EUT Test Photos.

4.1.3 DEVIATION FROM TEST STANDARD

No deviation

4.1.4 TEST SETUP

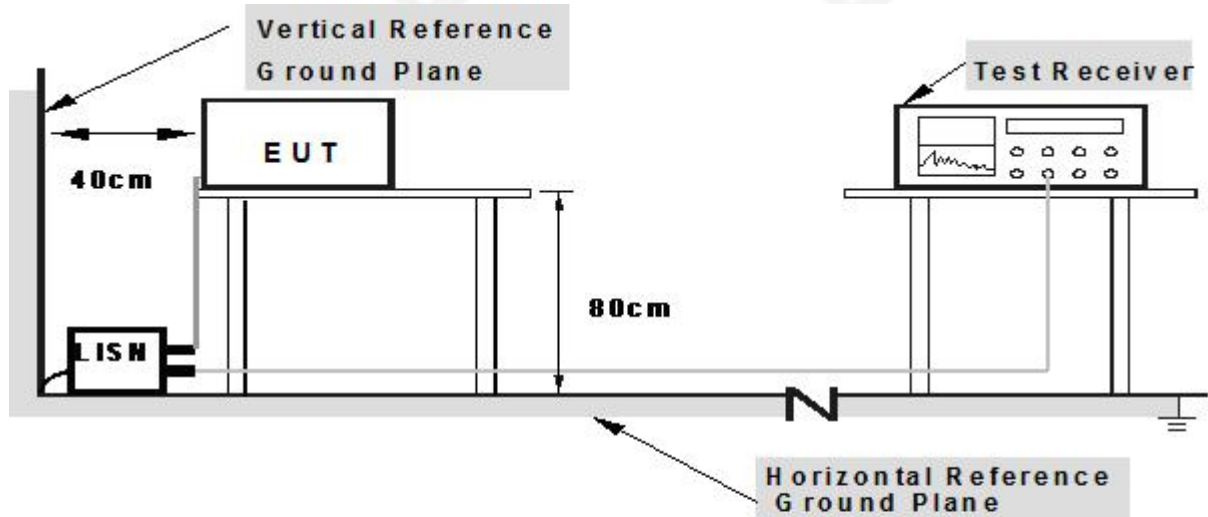

- Note: 1.Support units were connected to second LISN.**
2.Both of LISNs (AMN) are 80 cm from EUT and at least 80 from other units and other metal planes

4.1.5 EUT OPERATING CONDITIONS

The EUT was configured for testing in a typical fashion (as a customer would normally use it). The EUT has been programmed to continuously transmit during test. This operating condition was tested and used to collect the included data.

We pretest AC 120V and AC 230V, the worst voltage was AC 120V and the data recording in the report.



4.1.6 Test Result

Temperature:	26°C	Relative Humidity:	54%
Pressure:	101kPa	Phase:	L
Test Voltage:	AC 120V/60Hz		

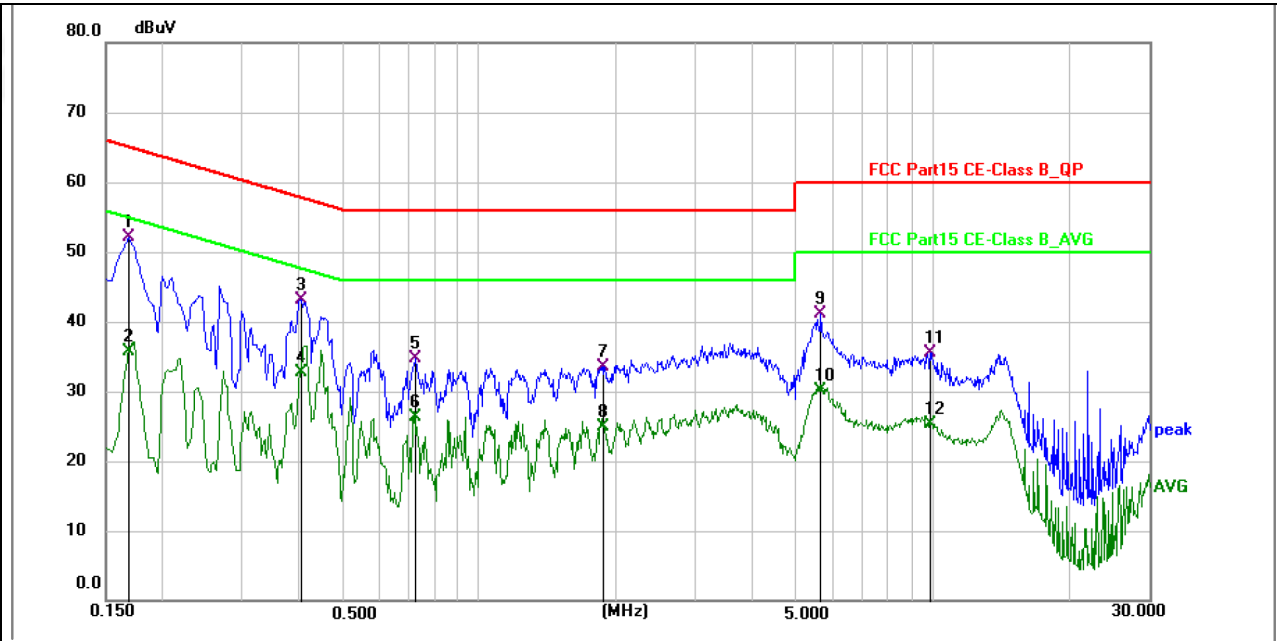

No.	Frequency (MHz)	Reading (dBuV)	Factor (dB)	Level (dBuV)	Limit (dBuV)	Margin (dB)	Detector	P/F	Remark
1 *	0.1680	42.10	9.91	52.01	65.06	-13.05	QP	P	
2	0.1680	25.83	9.91	35.74	55.06	-19.32	AVG	P	
3	0.4020	33.08	9.96	43.04	57.81	-14.77	QP	P	
4	0.4020	22.73	9.96	32.69	47.81	-15.12	AVG	P	
5	0.7260	24.70	9.99	34.69	56.00	-21.31	QP	P	
6	0.7260	16.34	9.99	26.33	46.00	-19.67	AVG	P	
7	1.8780	23.60	9.99	33.59	56.00	-22.41	QP	P	
8	1.8780	15.00	9.99	24.99	46.00	-21.01	AVG	P	
9	5.6715	31.08	10.00	41.08	60.00	-18.92	QP	P	
10	5.6715	20.01	10.00	30.01	50.00	-19.99	AVG	P	
11	9.8655	25.52	10.01	35.53	60.00	-24.47	QP	P	
12	9.8655	15.23	10.01	25.24	50.00	-24.76	AVG	P	

Notes:

1. An initial pre-scan was performed on the line and neutral lines with peak detector.
2. Quasi-Peak and Average measurement were performed at the frequencies with maximized peak emission.
3. Measurement Level = Reading level + Correct Factor



Temperature:	26°C	Relative Humidity:	54%
Pressure:	101kPa	Phase:	N
Test Voltage:	AC 120V/60Hz		

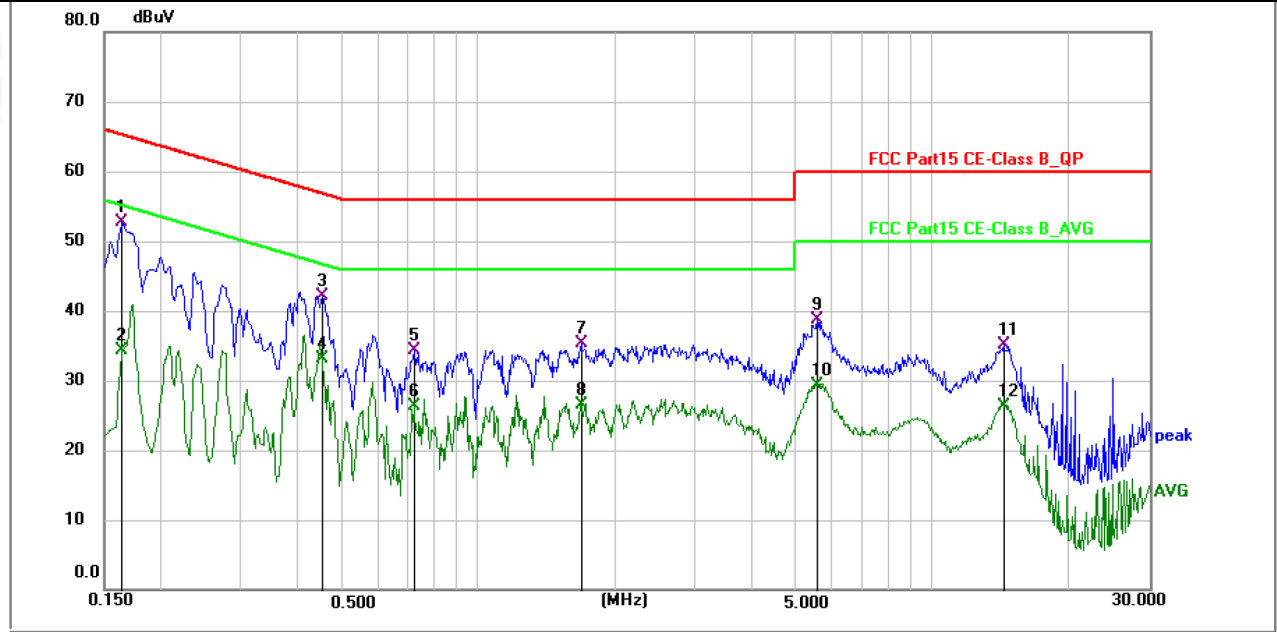

No.	Frequency (MHz)	Reading (dBuV)	Factor (dB)	Level (dBuV)	Limit (dBuV)	Margin (dB)	Detector	P/F	Remark
1 *	0.1635	42.87	9.93	52.80	65.28	-12.48	QP	P	
2	0.1635	24.44	9.93	34.37	55.28	-20.91	AVG	P	
3	0.4515	32.15	9.99	42.14	56.85	-14.71	QP	P	
4	0.4515	23.21	9.99	33.20	46.85	-13.65	AVG	P	
5	0.7215	24.31	10.01	34.32	56.00	-21.68	QP	P	
6	0.7215	16.33	10.01	26.34	46.00	-19.66	AVG	P	
7	1.6890	25.20	10.04	35.24	56.00	-20.76	QP	P	
8	1.6890	16.45	10.04	26.49	46.00	-19.51	AVG	P	
9	5.5860	28.74	10.01	38.75	60.00	-21.25	QP	P	
10	5.5860	19.32	10.01	29.33	50.00	-20.67	AVG	P	
11	14.3565	24.97	10.04	35.01	60.00	-24.99	QP	P	
12	14.3565	16.32	10.04	26.36	50.00	-23.64	AVG	P	

Notes:

1. An initial pre-scan was performed on the line and neutral lines with peak detector.
2. Quasi-Peak and Average measurement were performed at the frequencies with maximized peak emission.
3. Measurement Level = Reading level + Correct Factor



4.2 Radiated emissions

Test Requirement:	FCC Part15 C Section 15.209				
Test Method:	ANSI C63.10:2013				
Test Frequency Range:	9kHz to 25GHz				
Test site:	Measurement Distance: 3m				
Receiver setup:	Frequency	Detector	RBW	VBW	Value
	9KHz-150KHz	Quasi-peak	200Hz	MX5Hz	Quasi-peak
	150KHz-30MHz	Quasi-peak	9KHz	30KHz	Quasi-peak
	30MHz-1GHz	Quasi-peak	100KHz	300KHz	Quasi-peak
	Above 1GHz	Peak	1MHz	3MHz	Peak
		Peak	1MHz	10Hz	Average

4.2.1 Radiated Emission Limits

Frequencies (MHz)	Field Strength (micovolts/meter)	Measurement Distance (meters)
0.009~0.490	2400/F(KHz)	300
0.490~1.705	24000/F(KHz)	30
1.705~30.0	30	30
30~88	100	3
88~216	150	3
216~960	200	3
Above 960	500	3

LIMITS OF RADIATED EMISSION MEASUREMENT

FREQUENCY (MHz)	Limit (dBuV/m) (at 3M)	
	PEAK	AVERAGE
Above 1000	74	54

Notes:

- (1) The limit for radiated test was performed according to FCC PART 15C.
- (2) The tighter limit applies at the band edges.
- (3) Emission level (dBuV/m)=20log Emission level (uV/m).

4.2.2 TEST PROCEDURE

Below 1GHz test procedure as below:

- a. The EUT was placed on the top of a rotating table 0.1 meters above the ground at a 3 meter semi-anechoic chamber. The table was rotated 360 degrees to determine the position of the highest radiation.
- b. The EUT was set 3 meters away from the interference-receiving antenna, which was mounted on the top of a variable-height antenna tower.
- c. The antenna height is varied from one meter to four meters above the ground to determine the maximum value of the field strength. Both horizontal and vertical polarizations of the antenna are set to make the measurement.



- d. For each suspected emission, the EUT was arranged to its worst case and then the antenna was tuned to heights from 1 meter to 4 meters (for the test frequency of below 30MHz, the antenna was tuned to heights 1 meter) and the rotatable table was turned from 0 degrees to 360 degrees to find the maximum reading.
- e. The test-receiver system was set to Peak Detect Function and Specified Bandwidth with Maximum Hold Mode.
- f. If the emission level of the EUT in peak mode was 10dB lower than the limit specified, then testing could be stopped and the peak values of the EUT would be reported. Otherwise the emissions that did not have 10dB margin would be re-tested one by one using peak, quasi-peak or average method as specified and then reported in a data sheet.

Above 1GHz test procedure as below:

- g. Different between above is the test site, change from Semi- Anechoic Chamber to fully Anechoic Chamber and change form table 0.8 metre to 1.5 metre(Above 18GHz the distance is 1 meter and table is 1.5 metre).
- h. Test the EUT in the lowest channel ,the middle channel ,the Highest channel

Note:

Both horizontal and vertical antenna polarities were tested and performed pretest to three orthogonal axis. The worst case emissions were reported

4.2.3 DEVIATION FROM TEST STANDARD

No deviation

4.2.4 TEST SETUP

(A) Radiated Emission Test-Up Frequency Below 30MHz

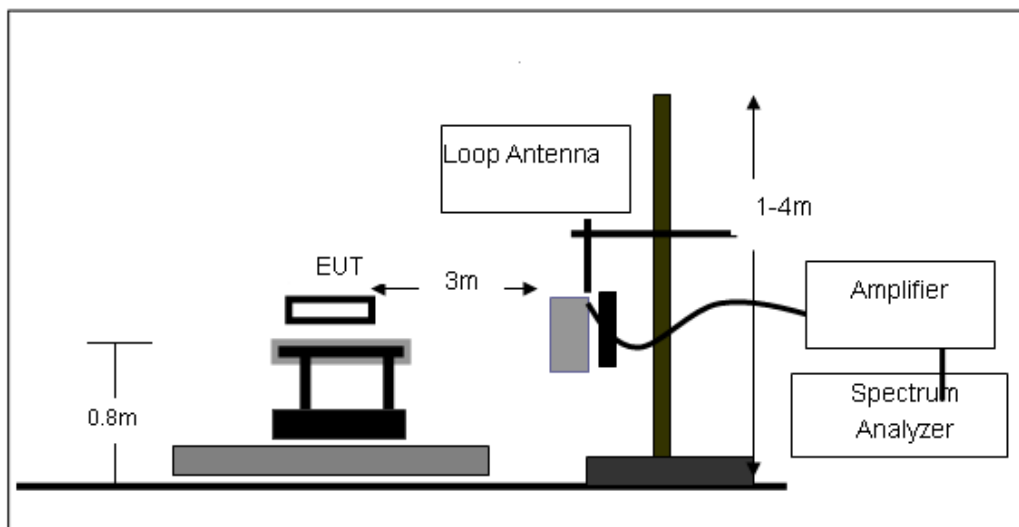



(B) Radiated Emission Test-Up Frequency 30MHz~1GHz

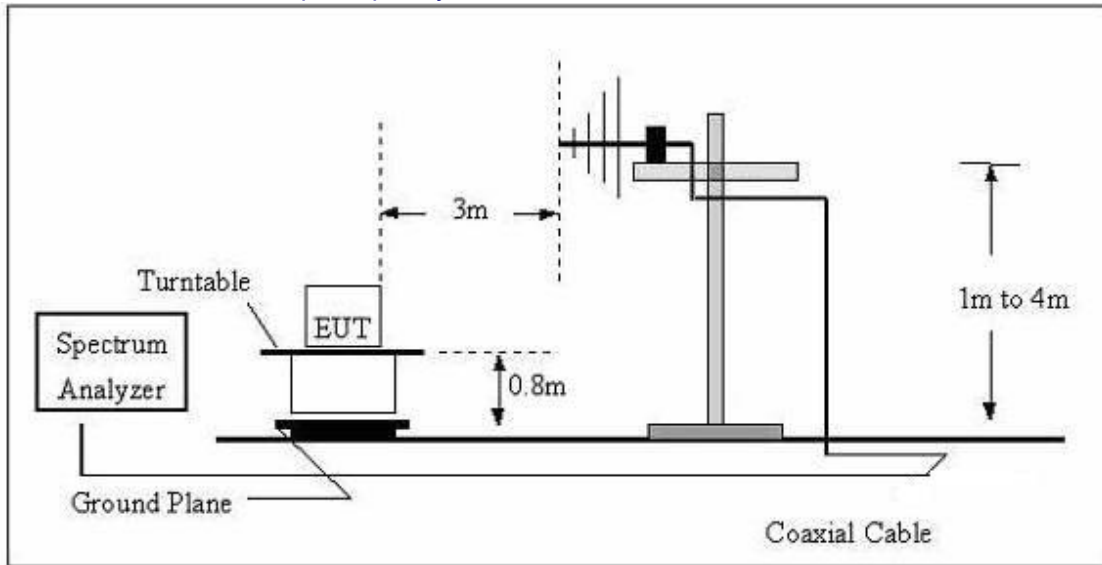

(C) Radiated Emission Test-Up Frequency Above 1GHz

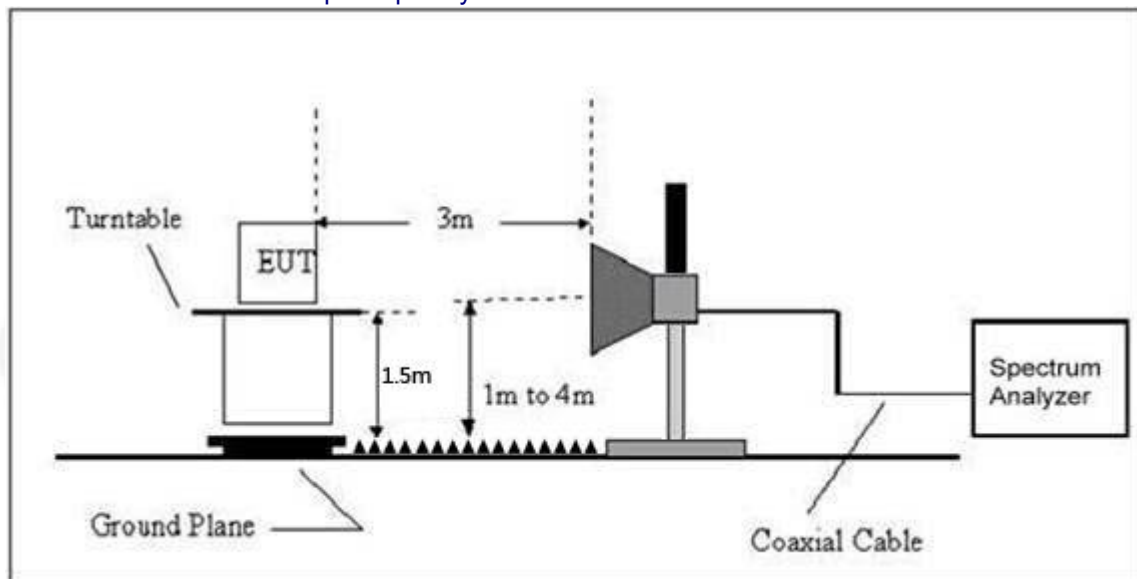

4.2.5 EUT OPERATING CONDITIONS

The EUT tested system was configured as the statements of 2.4 Unless otherwise a special operating condition is specified in the follows during the testing.

4.2.6 TEST RESULTS

Between 9KHz – 30MHz

The emission from 9 kHz to 30MHz was pre-tested and found the result was 20dB lower than the limit, and according to 15.31(o) & RSS-Gen 6.13, the test result no need to reported.



Between 30MHz – 1GHz

Temperature:	26°C	Relative Humidity:	54%
Pressure:	101 kPa	Polarization:	Horizontal
Test Voltage:	AC 120V, 60Hz		

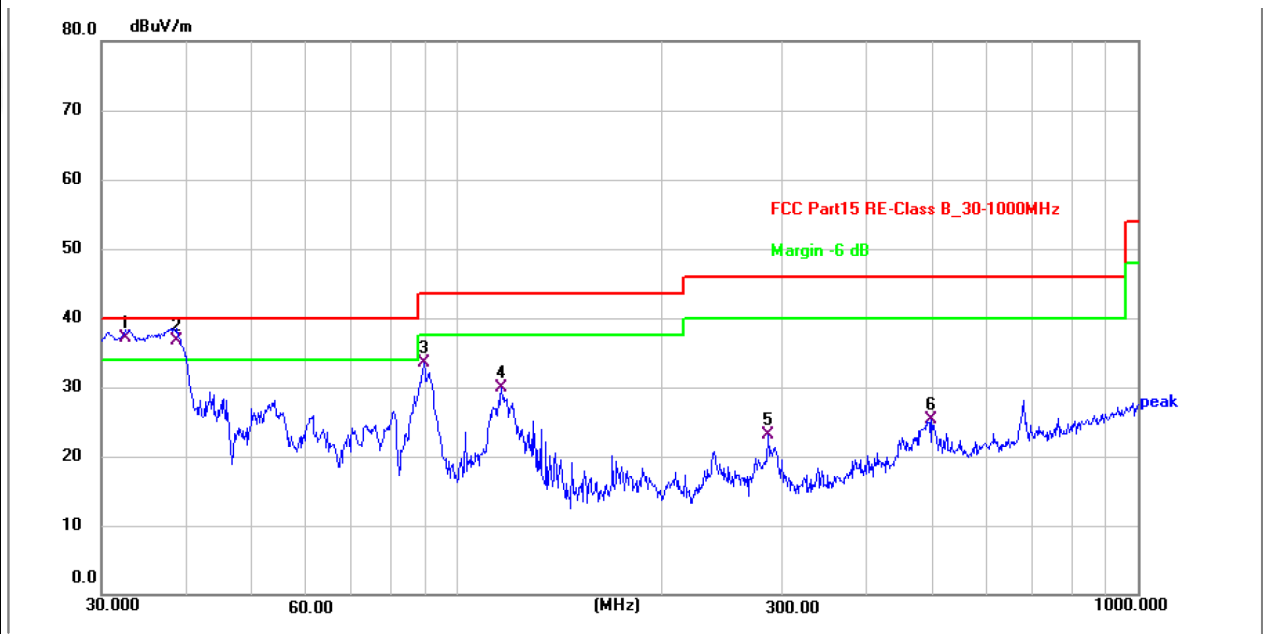

No.	Frequency (MHz)	Reading (dBuV)	Factor (dB/m)	Level (dBuV/m)	Limit (dBuV/m)	Margin (dB)	Detector	P/F	Remark
1 *	32.5198	53.61	-16.41	37.20	40.00	-2.80	QP	P	
2 !	38.7518	51.79	-15.09	36.70	40.00	-3.30	QP	P	
3	89.2764	50.69	-17.24	33.45	43.50	-10.05	QP	P	
4	116.1321	46.07	-16.21	29.86	43.50	-13.64	QP	P	
5	285.9778	35.21	-12.08	23.13	46.00	-22.87	QP	P	
6	497.6765	33.57	-8.29	25.28	46.00	-20.72	QP	P	



Temperature:	26°C	Relative Humidity:	54%
Pressure:	101kPa	Polarization:	Vertical
Test Voltage:	AC 120V, 60Hz		

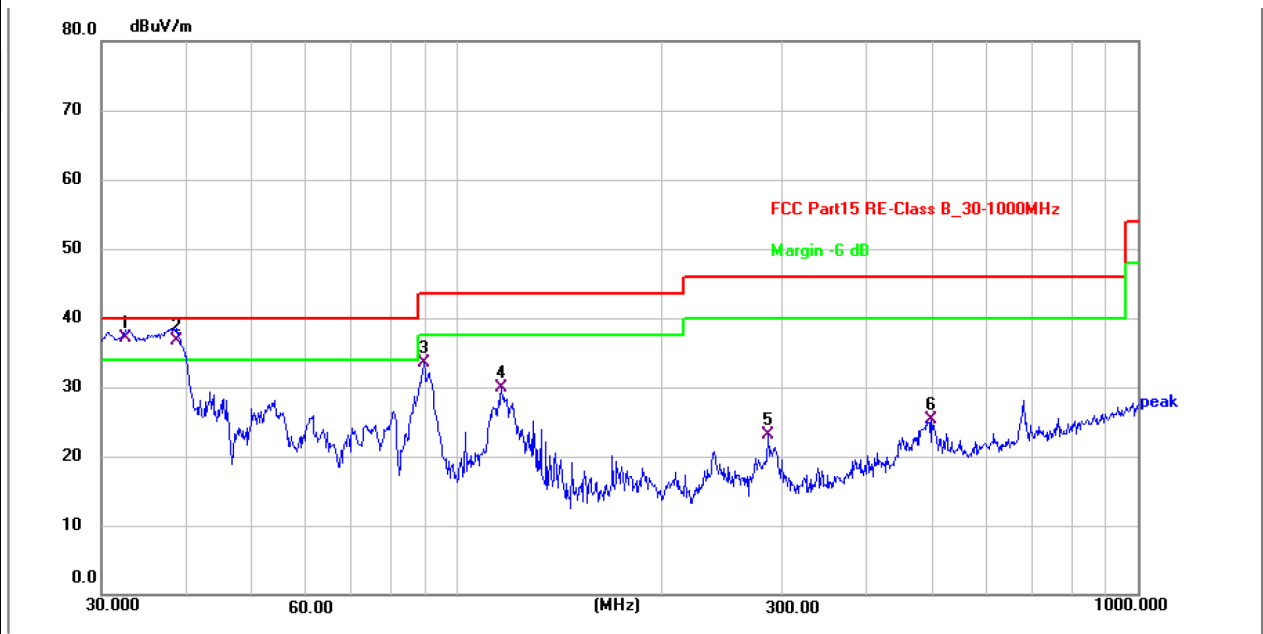

No.	Frequency (MHz)	Reading (dBuV)	Factor (dB/m)	Level (dBuV/m)	Limit (dBuV/m)	Margin (dB)	Detector	P/F	Remark
1 *	32.5198	53.61	-16.41	37.20	40.00	-2.80	QP	P	
2 !	38.7518	51.79	-15.09	36.70	40.00	-3.30	QP	P	
3	89.2764	50.69	-17.24	33.45	43.50	-10.05	QP	P	
4	116.1321	46.07	-16.21	29.86	43.50	-13.64	QP	P	
5	285.9778	35.21	-12.08	23.13	46.00	-22.87	QP	P	
6	497.6765	33.57	-8.29	25.28	46.00	-20.72	QP	P	

Remarks:

- 1.Final Level =Receiver Read level + Antenna Factor + Cable Loss
- 2.The emission levels of other frequencies are very lower than the limit and not show in test report.
- 3.During the test, pre-scan the GFSK, π/4QPSK, 8-DPSK modulation, and found the GFSK modulation Middle channel(TX Only) which is the worst case, only the worst case is recorded in the report.



Test Results (1GHz-25GHz)

Test Mode: CH01					Test channel: Lowest			
Peak Value								
Frequency (MHz)	Read Level (dBuV)	Antenna Factor (dB/m)	Cable Loss (dB)	Preamp Factor (dB)	Level (dBuV/m)	Limit (dBuV/m)	Over Limit (dB)	Pol.
4804.00	38.99	34.04	6.58	34.09	45.52	74.00	-28.48	V
7206.00	32.95	37.11	7.73	34.50	43.29	74.00	-30.71	V
9608.00	32.47	39.31	9.23	34.79	46.22	74.00	-27.78	V
12010.00	*					74.00		V
14412.00	*					74.00		V
4804.00	43.63	34.04	6.58	34.09	50.16	74.00	-23.84	H
7206.00	34.86	37.11	7.73	34.50	45.20	74.00	-28.80	H
9608.00	32.05	39.31	9.23	34.79	45.80	74.00	-28.20	H
12010.00	*					74.00		H
14412.00	*					74.00		H
Average Value								
Frequency (MHz)	Read Level (dBuV)	Antenna Factor (dB/m)	Cable Loss (dB)	Preamp Factor (dB)	Level (dBuV/m)	Limit (dBuV/m)	Over Limit (dB)	Pol.
4804.00	27.49	34.04	6.58	34.09	34.02	54.00	-19.98	V
7206.00	21.45	37.11	7.73	34.50	31.79	54.00	-22.21	V
9608.00	20.42	39.31	9.23	34.79	34.17	54.00	-19.83	V
12010.00	*					54.00		V
14412.00	*					54.00		V
4804.00	31.90	34.04	6.58	34.09	38.43	54.00	-15.57	H
7206.00	23.73	37.11	7.73	34.50	34.07	54.00	-19.93	H
9608.00	20.29	39.31	9.23	34.79	34.04	54.00	-19.96	H
12010.00	*					54.00		H
14412.00	*					54.00		H



Test Results (1GHz-25GHz)

Test Mode: CH40					Test channel: Middle			
Peak Value								
Frequency (MHz)	Read Level (dBuV)	Antenna Factor (dB/m)	Cable Loss (dB)	Preamp Factor (dB)	Level (dBuV/m)	Limit (dBuV/m)	Over Limit (dB)	Pol.
4882.00	37.70	34.38	6.69	34.09	44.68	74.00	-29.32	V
7323.00	32.09	37.22	7.78	34.53	42.56	74.00	-31.44	V
9764.00	31.70	39.46	9.35	34.80	45.71	74.00	-28.29	V
12205.00	*					74.00		V
14646.00	*					74.00		V
4882.00	42.07	34.38	6.69	34.09	49.05	74.00	-24.95	H
7323.00	33.88	37.22	7.78	34.53	44.35	74.00	-29.65	H
9764.00	31.16	39.46	9.35	34.80	45.17	74.00	-28.83	H
12205.00	*					74.00		H
14646.00	*					74.00		H
Average Value								
Frequency (MHz)	Read Level (dBuV)	Antenna Factor (dB/m)	Cable Loss (dB)	Preamp Factor (dB)	Level (dBuV/m)	Limit (dBuV/m)	Over Limit (dB)	Pol.
4882.00	26.45	34.38	6.69	34.09	33.43	54.00	-20.57	V
7323.00	20.74	37.22	7.78	34.53	31.21	54.00	-22.79	V
9764.00	19.80	39.46	9.35	34.80	33.81	54.00	-20.19	V
12205.00	*					54.00		V
14646.00	*					54.00		V
4882.00	30.73	34.38	6.69	34.09	37.71	54.00	-16.29	H
7323.00	22.94	37.22	7.78	34.53	33.41	54.00	-20.59	H
9764.00	19.56	39.46	9.35	34.80	33.57	54.00	-20.43	H
12205.00	*					54.00		H
14646.00	*					54.00		H



Test Results (1GHz-25GHz)

Test Mode: CH79					Test channel: Highest			
Peak Value								
Frequency (MHz)	Read Level (dBuV)	Antenna Factor (dB/m)	Cable Loss (dB)	Preamp Factor (dB)	Level (dBuV/m)	Limit (dBuV/m)	Over Limit (dB)	Pol.
4960.00	36.79	34.72	6.79	34.09	44.21	74.00	-29.79	V
7440.00	31.49	37.34	7.82	34.57	42.08	74.00	-31.92	V
9920.00	31.17	39.62	9.46	34.81	45.44	74.00	-28.56	V
12400.00	*					74.00		V
14880.00	*					74.00		V
4960.00	40.97	34.72	6.79	34.09	48.39	74.00	-25.61	H
7440.00	33.20	37.34	7.82	34.57	43.79	74.00	-30.21	H
9920.00	30.54	39.62	9.46	34.81	44.81	74.00	-29.19	H
12400.00	*					74.00		H
14880.00	*					74.00		H
Average Value								
Frequency (MHz)	Read Level (dBuV)	Antenna Factor (dB/m)	Cable Loss (dB)	Preamp Factor (dB)	Level (dBuV/m)	Limit (dBuV/m)	Over Limit (dB)	Pol.
4960.00	25.78	34.72	6.79	34.09	33.20	54.00	-20.80	V
7440.00	20.28	37.34	7.82	34.57	30.87	54.00	-23.13	V
9920.00	19.39	39.62	9.46	34.81	33.66	54.00	-20.34	V
12400.00	*					54.00		V
14880.00	*					54.00		V
4960.00	29.96	34.72	6.79	34.09	37.38	54.00	-16.62	H
7440.00	22.43	37.34	7.82	34.57	33.02	54.00	-20.98	H
9920.00	19.08	39.62	9.46	34.81	33.35	54.00	-20.65	H
12400.00	*					54.00		H
14880.00	*					54.00		H

Remark:

1. During the test, pre-scan the GFSK, $\pi/4$ QPSK, 8-DPSK modulation, and found the GFSK modulation is worse case, the report only record this mode.
2. Level =Receiver Read level + Antenna Factor + Cable Loss – Preamplifier Factor
3. "*" means the test results were attenuated more than 20dB below the permissible limits, so the results don't record in the report.



5. RADIATED BAND EMISSION MEASUREMENT

5.1 Test Requirement:

Test Requirement:	FCC Part15 C Section 15.209 and 15.205				
Test Method:	ANSI C63.10: 2013				
Test Frequency Range:	All of the restrict bands were tested, only the worst band's (2310MHz to 2500MHz) data was showed.				
Test site:	Measurement Distance: 3m				
Receiver setup:	Frequency	Detector	RBW	VBW	Value
	Above 1GHz	Peak	1MHz	3MHz	Peak
		Average	1MHz	3MHz	Average

LIMITS OF RADIATED EMISSION MEASUREMENT (Above 1000MHz)

FREQUENCY (MHz)	Limit (dBuV/m) (at 3M)	
	PEAK	AVERAGE
Above 1000	74	54

Notes:

- (1) The limit for radiated test was performed according to FCC PART 15C.
- (2) The tighter limit applies at the band edges.
- (3) Emission level (dBuV/m)=20log Emission level (uV/m).

Spectrum Parameter	Setting
Attenuation	Auto
Start Frequency	2300MHz
Stop Frequency	2520
RB / VB (emission in restricted band)	1 MHz / 1 MHz for Peak, 1 MHz / 10Hz for Average

5.2 TEST PROCEDURE

Above 1GHz test procedure as below:

- a. 1. The EUT was placed on the top of a rotating table 1.5 meters above the ground at a 3 meter camber. The table was rotated 360 degrees to determine the position of the highest radiation.
- b. The EUT was set 3 meters away from the interference-receiving antenna, which was mounted on the top of a variable-height antenna tower.
- c. The antenna height is varied from one meter to four meters above the ground to determine the maximum value of the field strength. Both horizontal and vertical polarizations of the antenna are set to make the measurement.
- d. For each suspected emission, the EUT was arranged to its worst case and then the antenna was tuned to heights from 1 meter to 4 meters and the rota table was turned from 0 degrees to 360 degrees to find the maximum reading.
- e. The test-receiver system was set to Peak Detect Function and Specified Bandwidth with Maximum Hold Mode.
- f. If the emission level of the EUT in peak mode was 10dB lower than the limit specified, then testing could be stopped and the peak values of the EUT would be reported. Otherwise the emissions that did not have 10dB margin would be re-tested one by one using peak, quasi-peak or average method as specified and then reported in a data sheet.
- g. Test the EUT in the lowest channel,the Highest channel

Note:

Both horizontal and vertical antenna polarities were tested and performed pretest to three orthogonal axis. The worst case emissions were reported



5.3 DEVIATION FROM TEST STANDARD

No deviation

5.4 TEST SETUP

Radiated Emission Test-Up Frequency Above 1GHz

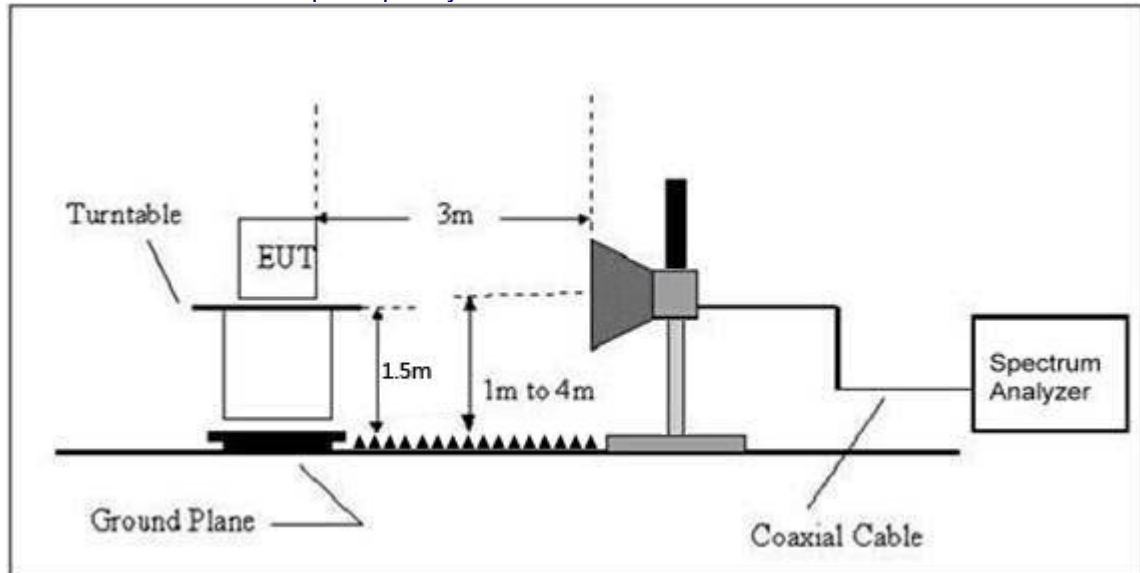

5.5 EUT OPERATING CONDITIONS

The EUT tested system was configured as the statements of 2.3 Unless otherwise a special operating condition is specified in the follows during the testing.



5.6 TEST RESULT

Test Mode: GFKS										
Pol.	Frequen cy (MHz)	Meter Reading (dBuV)	Pre-amplifier (dB)	Cable Loss (dB)	Antenna Factor (dB/m)	Emission level (dBuV/m)	Limit (dBuV/ m)	Margin (dB)	Detect or Type	Result
Low Channel: 2402MHz										
H	2310.00	45.74	29.15	3.41	34.01	44.29	74.00	-29.71	PK	PASS
H	2390.00	62.93	29.16	3.43	34.01	61.51	74.00	-12.49	PK	PASS
V	2310.00	46.56	29.15	3.41	34.01	45.11	74.00	-28.89	PK	PASS
V	2390.00	65.28	29.16	3.43	34.01	63.86	74.00	-10.14	PK	PASS
H	2310.00	35.64	29.15	3.41	34.01	34.19	54.00	-19.81	AV	PASS
H	2390.00	47.05	29.16	3.43	34.01	45.63	54.00	-8.37	AV	PASS
V	2310.00	35.79	29.15	3.41	34.01	34.34	54.00	-19.66	AV	PASS
V	2390.00	48.97	29.16	3.43	34.01	47.55	54.00	-6.45	AV	PASS
High Channel: 2480MHz										
H	2483.50	48.18	29.28	3.53	34.03	46.96	74.00	-27.04	PK	PASS
H	2500.00	46.81	29.30	3.56	34.03	45.64	74.00	-28.36	PK	PASS
V	2483.50	49.50	29.28	3.53	34.03	48.28	74.00	-25.72	PK	PASS
V	2500.00	48.08	29.30	3.56	34.03	46.91	74.00	-27.09	PK	PASS
H	2483.50	38.50	29.28	3.53	34.03	37.28	54.00	-16.72	AV	PASS
H	2500.00	36.10	29.30	3.56	34.03	34.93	54.00	-19.07	AV	PASS
V	2483.50	39.95	29.28	3.53	34.03	38.73	54.00	-15.27	AV	PASS
V	2500.00	36.26	29.30	3.56	34.03	35.09	54.00	-18.91	AV	PASS

Test Mode: π/4-DQPSK										
Pol.	Frequen cy (MHz)	Meter Reading (dBuV)	Pre-amplifier (dB)	Cable Loss (dB)	Antenna Factor (dB/m)	Emission level (dBuV/m)	Limit (dBuV/ m)	Margin (dB)	Detect or Type	Result
Low Channel: 2402MHz										
H	2310.00	45.83	29.15	3.41	34.01	44.38	74.00	-29.62	PK	PASS
H	2390.00	63.04	29.16	3.43	34.01	61.62	74.00	-12.38	PK	PASS
V	2310.00	46.66	29.15	3.41	34.01	45.21	74.00	-28.79	PK	PASS
V	2390.00	65.39	29.16	3.43	34.01	63.97	74.00	-10.03	PK	PASS
H	2310.00	35.71	29.15	3.41	34.01	34.26	54.00	-19.74	AV	PASS
H	2390.00	47.13	29.16	3.43	34.01	45.71	54.00	-8.30	AV	PASS
V	2310.00	35.87	29.15	3.41	34.01	34.42	54.00	-19.58	AV	PASS
V	2390.00	49.06	29.16	3.43	34.01	47.64	54.00	-6.36	AV	PASS
High Channel: 2480MHz										
H	2483.50	48.29	29.28	3.53	34.03	47.07	74.00	-26.94	PK	PASS
H	2500.00	46.90	29.30	3.56	34.03	45.73	74.00	-28.28	PK	PASS
V	2483.50	49.62	29.28	3.53	34.03	48.40	74.00	-25.60	PK	PASS
V	2500.00	48.18	29.30	3.56	34.03	47.01	74.00	-27.00	PK	PASS
H	2483.50	38.58	29.28	3.53	34.03	37.36	54.00	-16.65	AV	PASS
H	2500.00	36.16	29.30	3.56	34.03	34.99	54.00	-19.02	AV	PASS
V	2483.50	40.03	29.28	3.53	34.03	38.81	54.00	-15.19	AV	PASS
V	2500.00	36.32	29.30	3.56	34.03	35.15	54.00	-18.85	AV	PASS



Test Mode: 8-DPSK										
Pol.	Frequen cy (MHz)	Meter Reading (dBuV)	Pre- amplifier (dB)	Cable Loss (dB)	Antenna Factor (dB/m)	Emission level (dBuV/m)	Limit (dBuV/ m)	Margin (dB)	Detect or Type	Result
Low Channel: 2402MHz										
H	2310.00	45.87	29.15	3.41	34.01	44.42	74.00	-29.58	PK	PASS
H	2390.00	63.09	29.16	3.43	34.01	61.67	74.00	-12.33	PK	PASS
V	2310.00	46.71	29.15	3.41	34.01	45.26	74.00	-28.74	PK	PASS
V	2390.00	65.45	29.16	3.43	34.01	64.03	74.00	-9.98	PK	PASS
H	2310.00	35.75	29.15	3.41	34.01	34.30	54.00	-19.71	AV	PASS
H	2390.00	47.16	29.16	3.43	34.01	45.74	54.00	-8.26	AV	PASS
V	2310.00	35.90	29.15	3.41	34.01	34.45	54.00	-19.55	AV	PASS
V	2390.00	49.09	29.16	3.43	34.01	47.67	54.00	-6.33	AV	PASS
High Channel: 2480MHz										
H	2483.50	48.33	29.28	3.53	34.03	47.11	74.00	-26.89	PK	PASS
H	2500.00	46.93	29.30	3.56	34.03	45.76	74.00	-28.24	PK	PASS
V	2483.50	49.67	29.28	3.53	34.03	48.45	74.00	-25.55	PK	PASS
V	2500.00	48.22	29.30	3.56	34.03	47.05	74.00	-26.95	PK	PASS
H	2483.50	38.61	29.28	3.53	34.03	37.39	54.00	-16.61	AV	PASS
H	2500.00	36.18	29.30	3.56	34.03	35.01	54.00	-18.99	AV	PASS
V	2483.50	40.07	29.28	3.53	34.03	38.85	54.00	-15.15	AV	PASS
V	2500.00	36.35	29.30	3.56	34.03	35.18	54.00	-18.82	AV	PASS

Remark:

1. Emission Level = Meter Reading + Antenna Factor + Cable Loss – Pre-amplifier, Margin= Emission Level - Limit



6. CONDUCTED BAND EDGE AND SPURIOUS EMISSION

Test Requirement:	FCC Part15 C Section 15.247 (d)
Test Method:	KDB558074 D0115.247 Meas Guidancev05r02

6.1 Limit

Regulation 15.247 (d), In any 100 kHz bandwidth outside the frequency band in which the spread spectrum or digitally modulated intentional radiator is operating, the radio frequency power that is produced by the intentional radiator shall be at least 20 dB below that in the 100 kHz bandwidth within the band that contains the highest level of the desired power, based on either an RF conducted or a radiated measurement, provided the transmitter demonstrates compliance with the peak conducted power limits. If the transmitter complies with the conducted power limits based on the use of RMS averaging over a time interval, as permitted under paragraph (b)(3) of this section, the attenuation required under this paragraph shall be 30 dB instead of 20 dB. Attenuation below the general limits specified in §15.209(a) is not required. In addition, radiated emissions which fall in the restricted bands, as defined in §15.205(a), must also comply with the radiated emission limits specified in §15.209(a) (see §15.205(c)).

6.2 Test Setup



6.3 Test procedure

Using the following spectrum analyzer setting:

- A) Set the RBW = 100KHz.
- B) Set the VBW = 300KHz.
- C) Sweep time = auto couple.
- D) Detector function = peak.
- E) Trace mode = max hold.
- F) Allow trace to fully stabilize.

6.4 DEVIATION FROM STANDARD

No deviation.



6.5 Test Result

Mode	TX Type	Frequency (MHz)	Packet Type	ANT	Level of Reference (dBm)
GFSK	SISO	2402	DH5	1	10.02
		2441	DH5	1	9.39
		2480	DH5	1	9.43
$\pi/4$ -DQPSK	SISO	2402	2DH5	1	7.58
		2441	2DH5	1	7.38
		2480	2DH5	1	7.99
8-DPSK	SISO	2402	3DH5	1	7.60
		2441	3DH5	1	7.40
		2480	3DH5	1	7.99

Note1: Refer to RSS-247 Issue 2 section 5.5 and ANSI C63.10-2013, the channel contains the maximum PSD level was used to establish the reference level.

Test plots

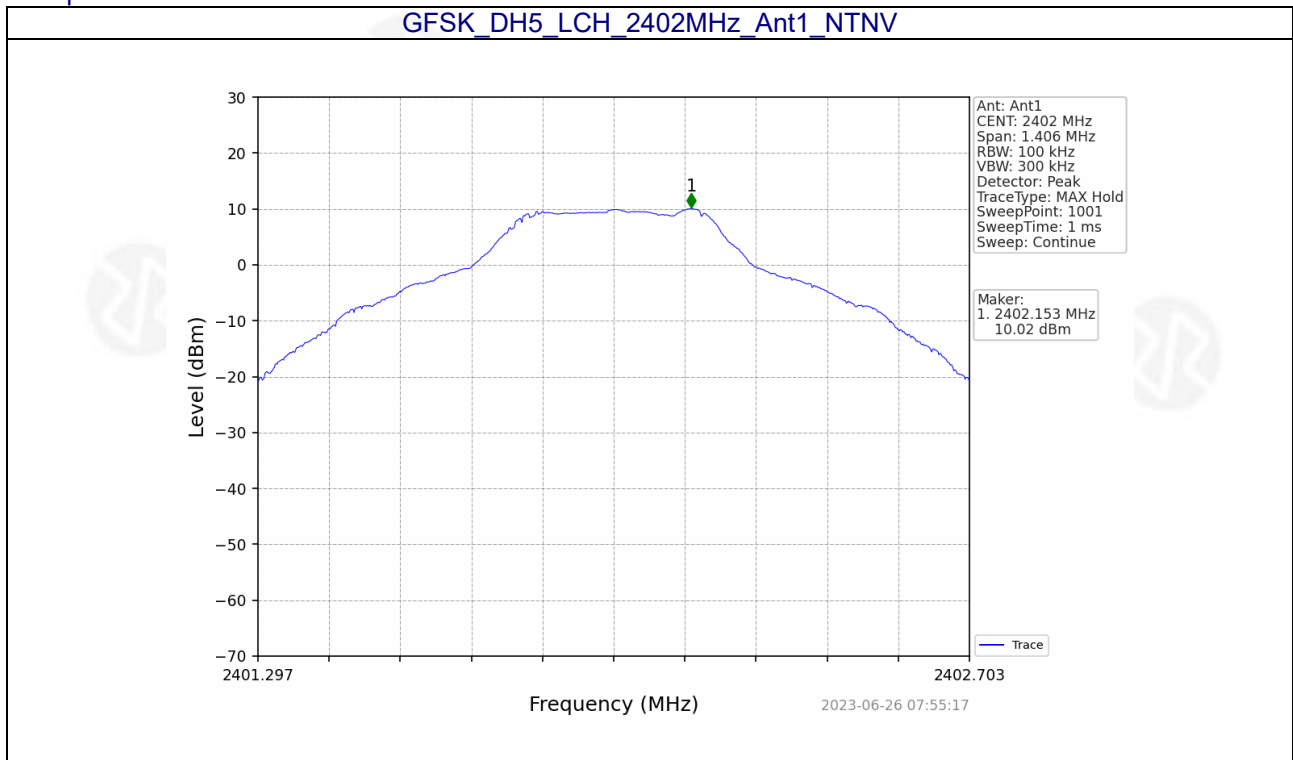



GFSK DH5 MCH 2441MHz Ant1 NTN

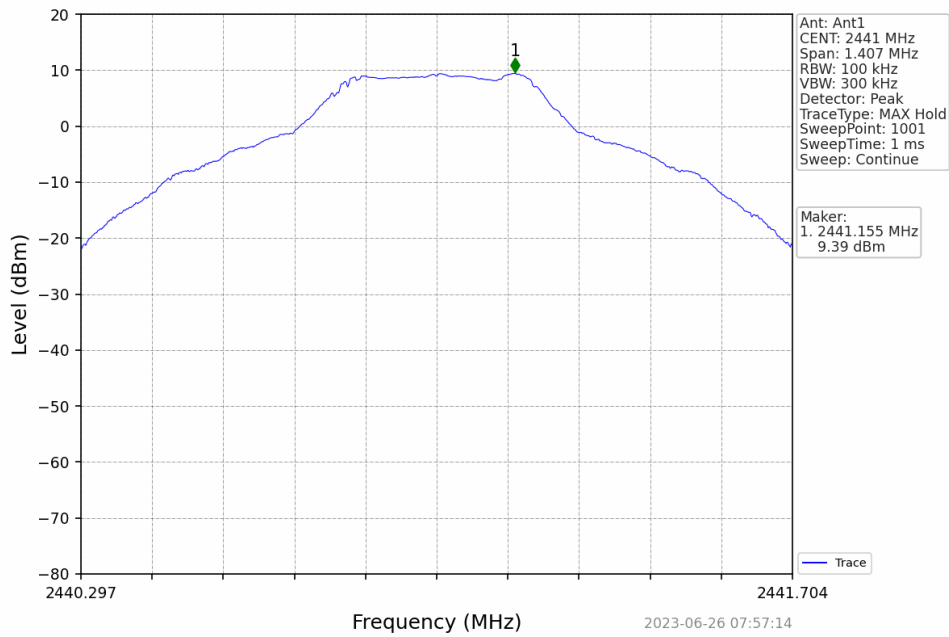

GFSK DH5 HCH 2480MHz Ant1 NTN

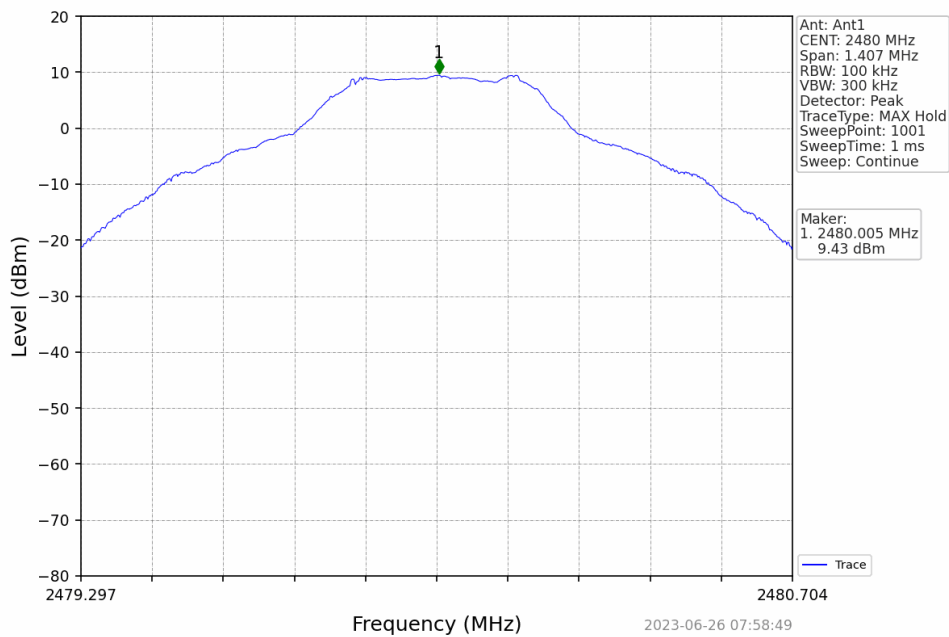



Pi/4DQPSK_2DH5_LCH_2402MHz_Ant1_NTNV

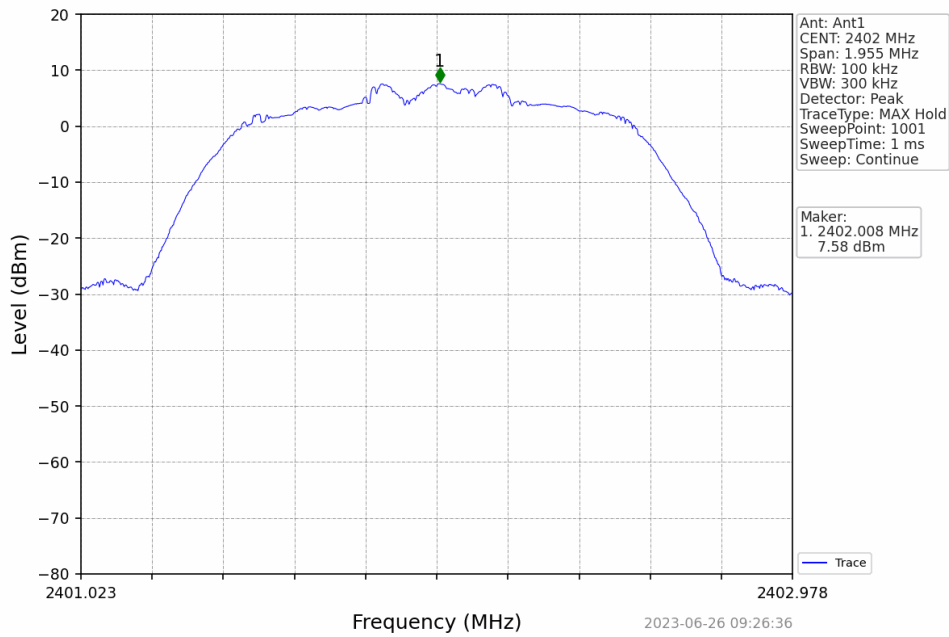

Pi/4DQPSK_2DH5_MCH_2441MHz_Ant1_NTNV

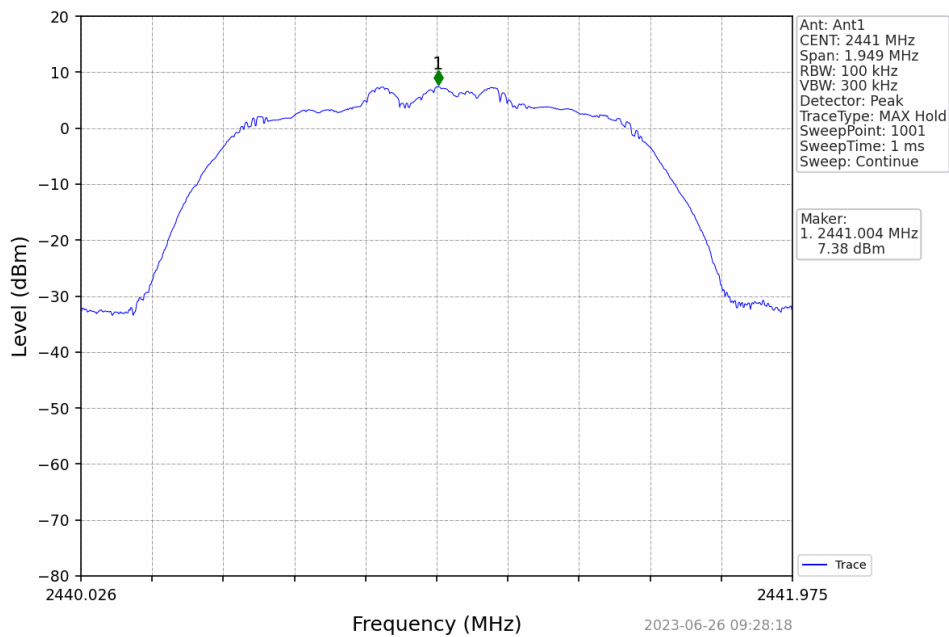



Pi/4DQPSK 2DH5 HCH 2480MHz Ant1 NTN

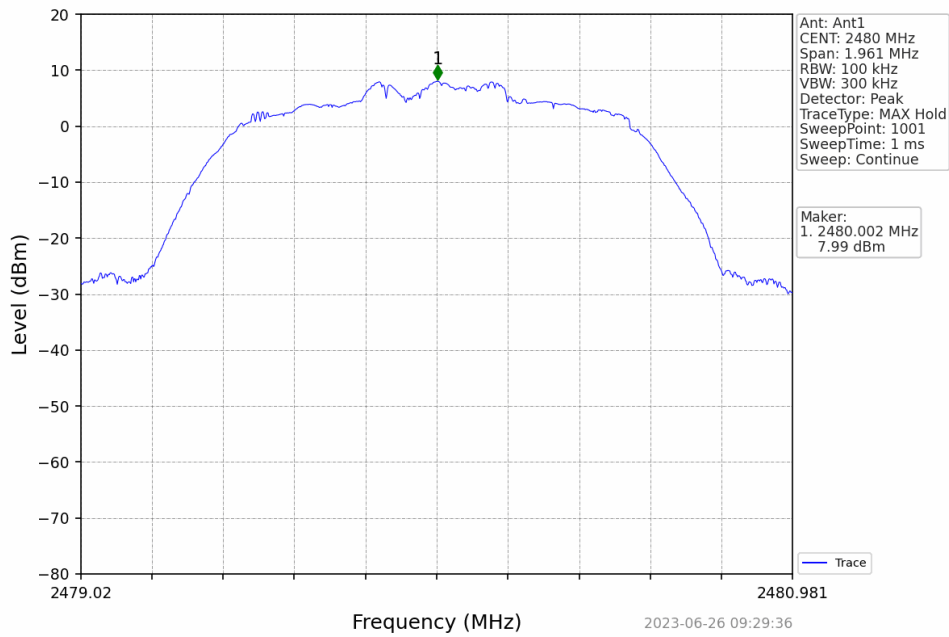

8DPSK 3DH5 LCH 2402MHz Ant1 NTN

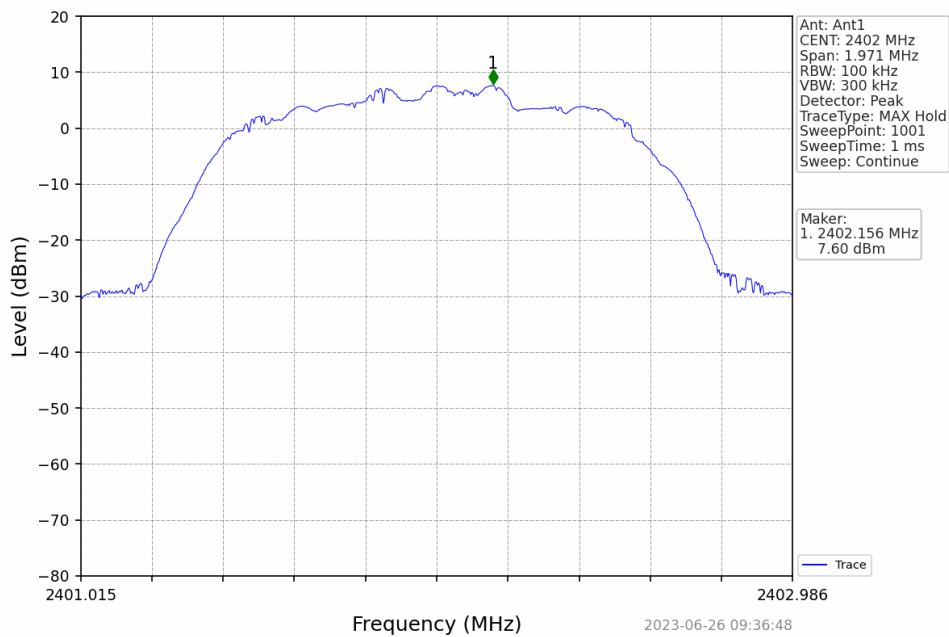



8DPSK 3DH5 MCH 2441MHz Ant1 NTV

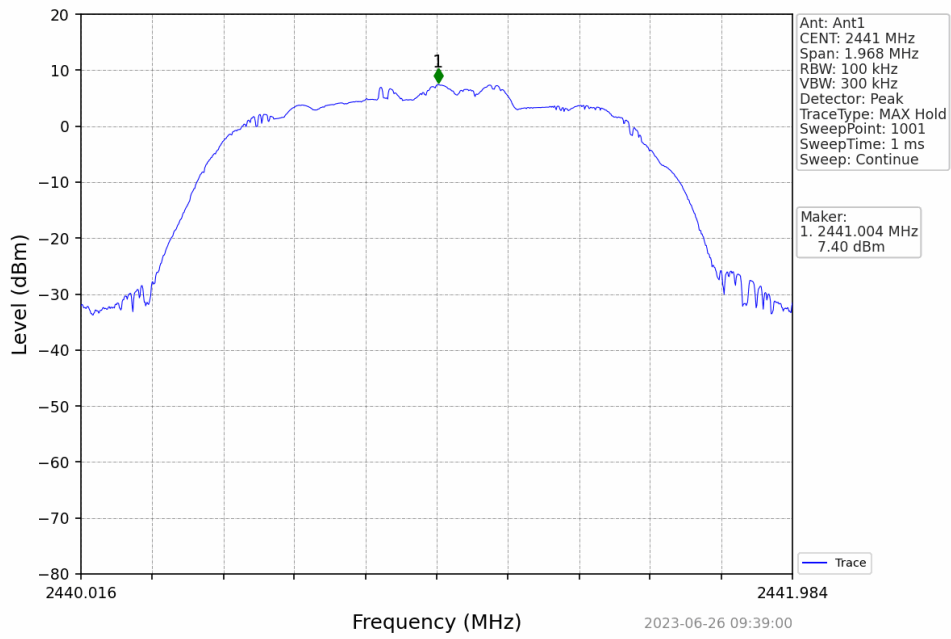

8DPSK 3DH5 HCH 2480MHz Ant1 NTV

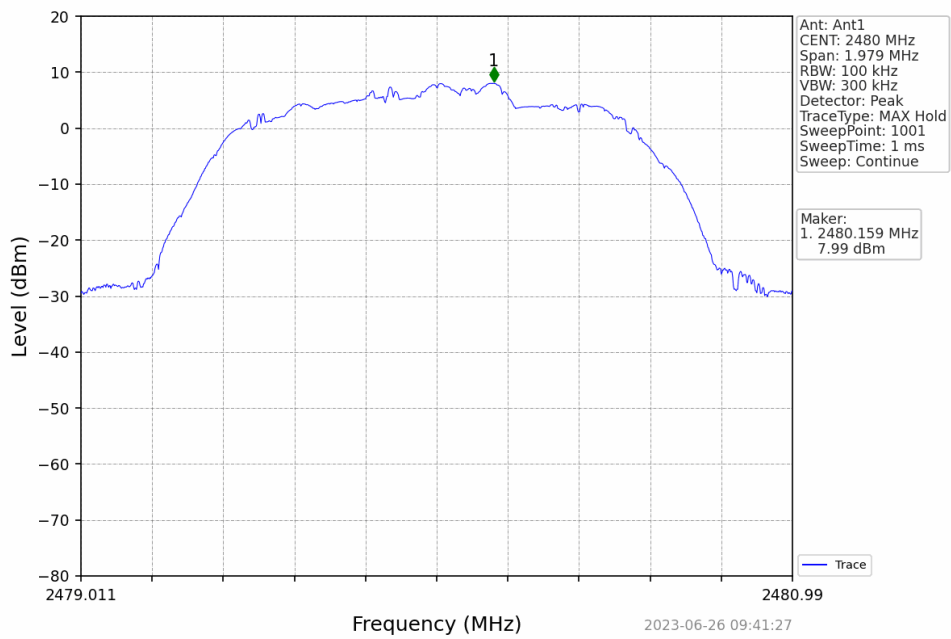



Conducted Spurious Emission

Mode	TX Type	Frequency (MHz)	Packet Type	ANT	Level of Reference (dBm)	Limit (dBm)	Verdict
GFSK	SISO	2402	DH5	1	10.02	-9.98	Pass
		2441	DH5	1	10.02	-9.98	Pass
		2480	DH5	1	10.02	-9.98	Pass
		HOPP	DH5	1	10.02	-9.98	Pass
π/4-DQPSK	SISO	2402	2DH5	1	7.99	-12.01	Pass
		2441	2DH5	1	7.99	-12.01	Pass
		2480	2DH5	1	7.99	-12.01	Pass
		HOPP	2DH5	1	7.99	-12.01	Pass
8-DPSK	SISO	2402	2DH5	1	7.99	-12.01	Pass
		2441	2DH5	1	7.99	-12.01	Pass
		2480	2DH5	1	7.99	-12.01	Pass
		HOPP	2DH5	1	7.99	-12.01	Pass

Note1: Refer to FCC Part 15.247 (d) and ANSI C63.10-2013, the channel contains the maximum PSD level was used to establish the reference level.

Test plots

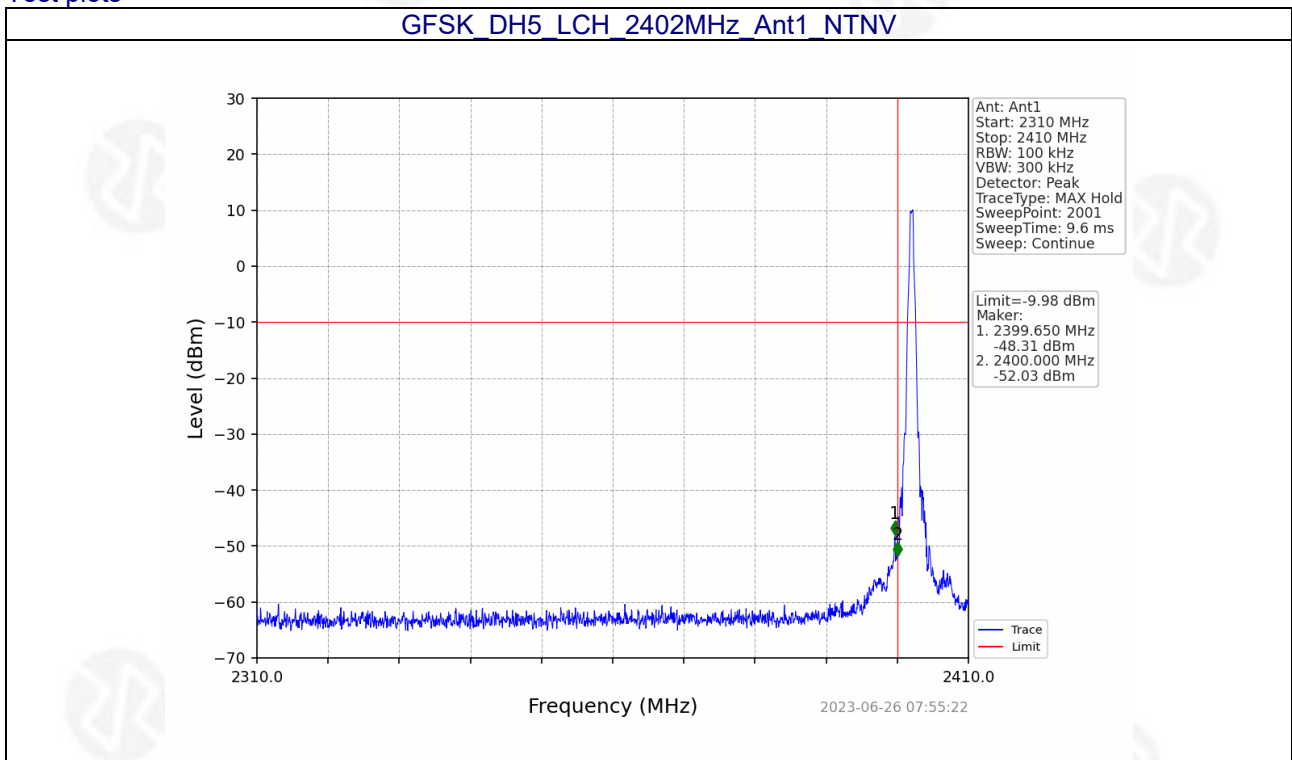

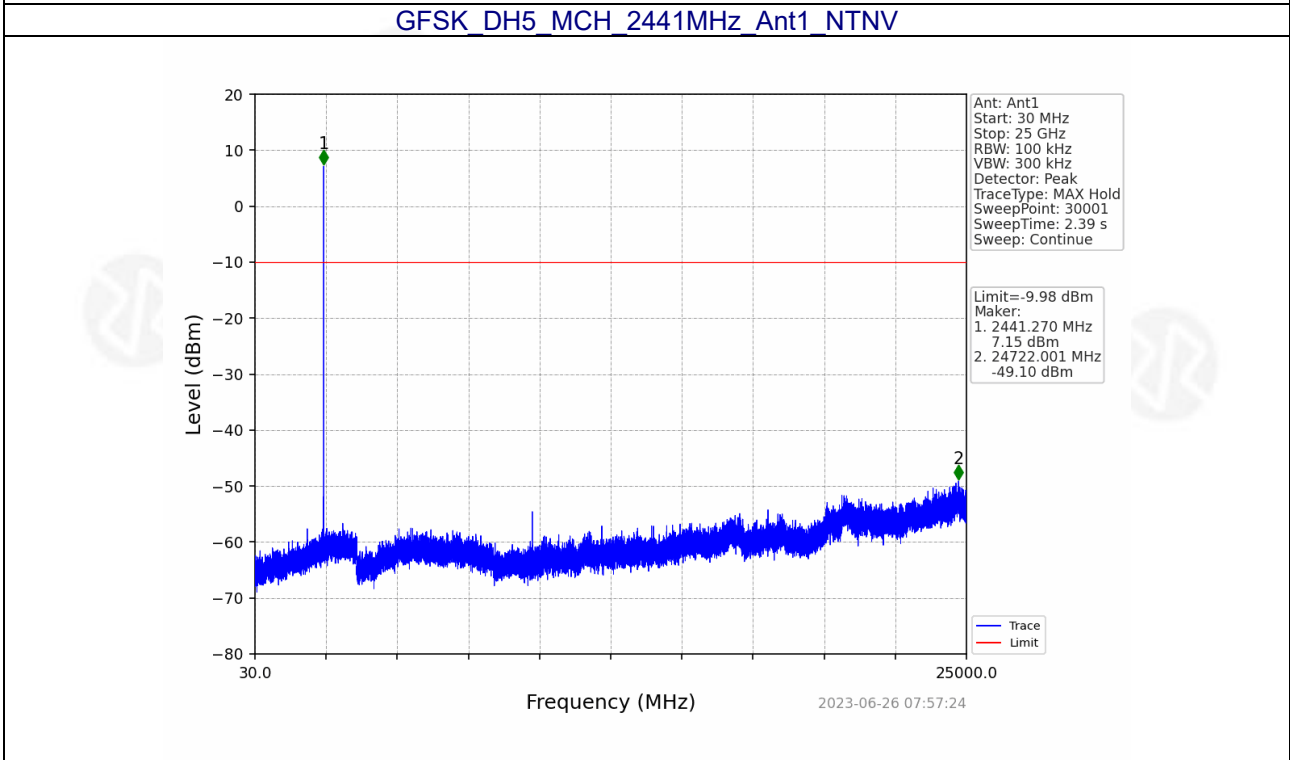
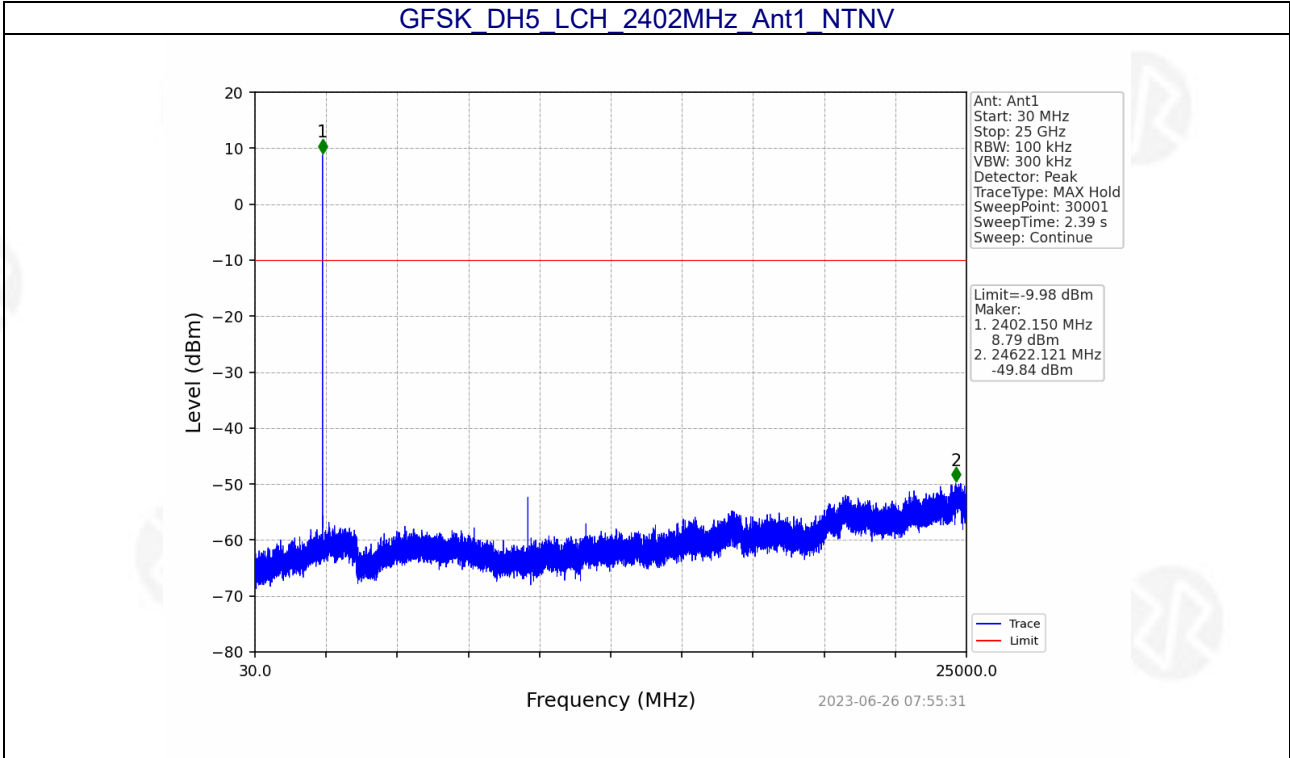



GFSK DH5 HCH 2480MHz Ant1 NTN

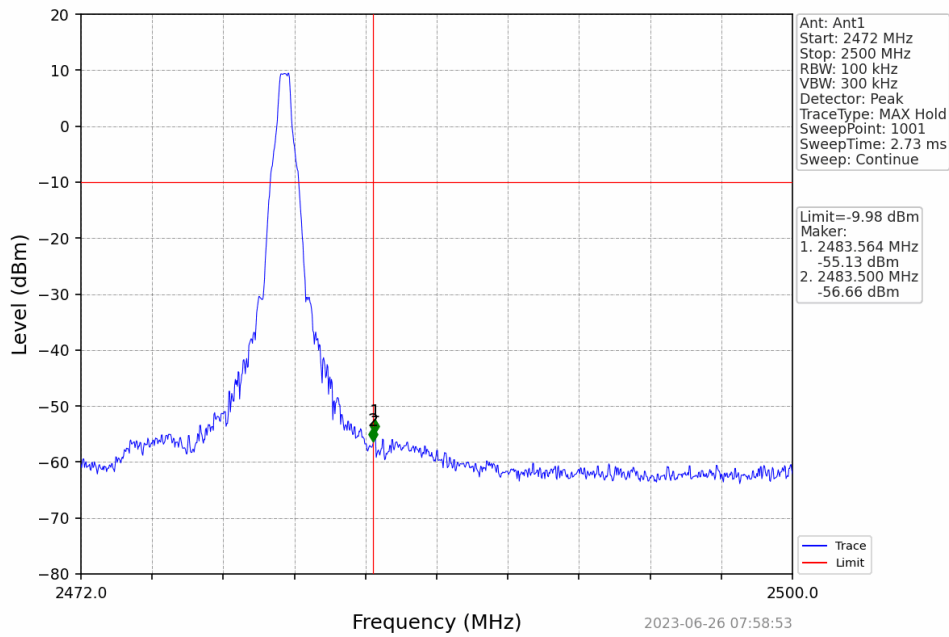

GFSK DH5 HCH 2480MHz Ant1 NTN

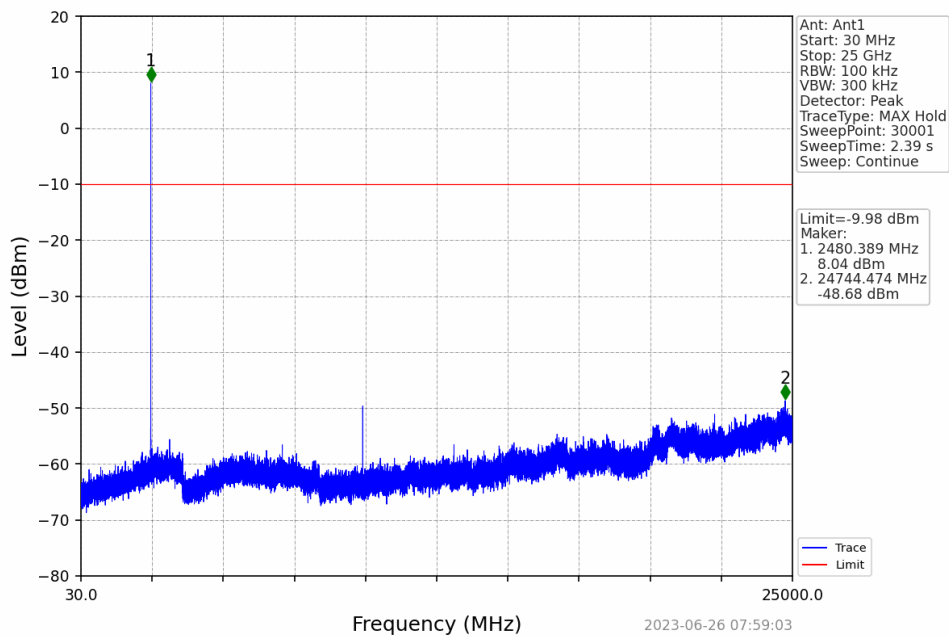



GFSK DH5_HOPP_Ant1_NTNV

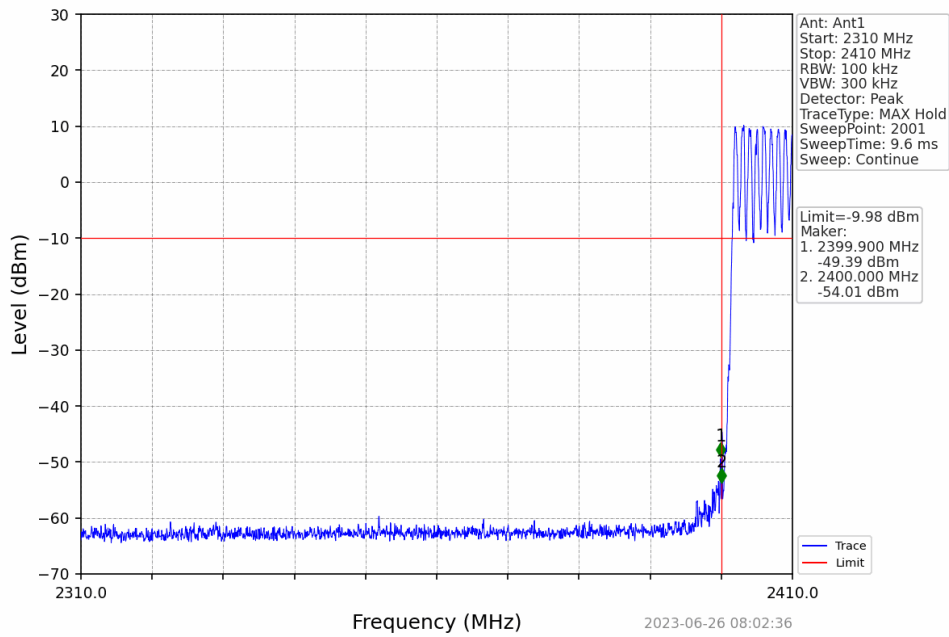

GFSK DH5_HOPP_Ant1_NTNV

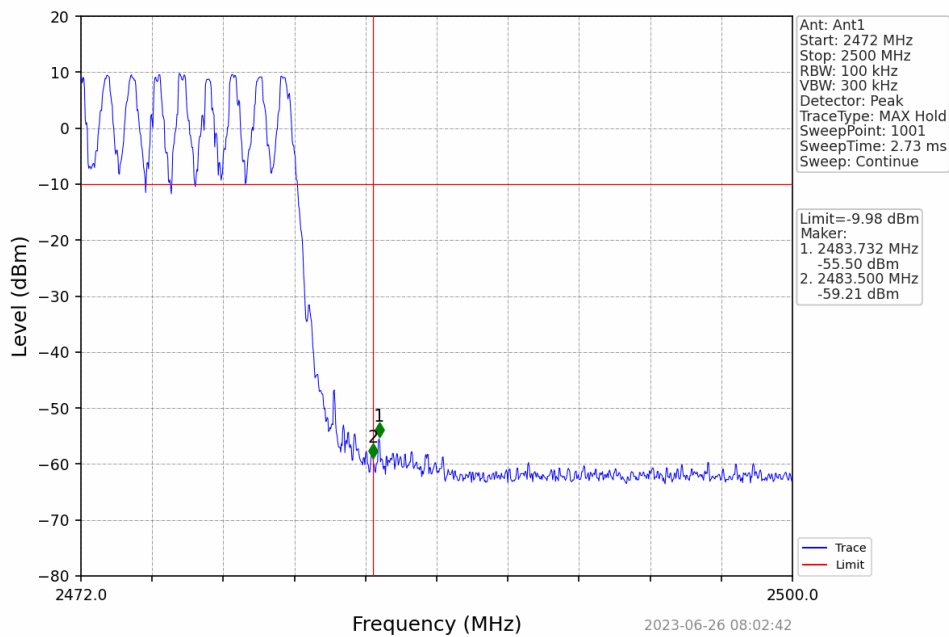



Pi/4DQPSK_2DH5_LCH_2402MHz_Ant1_NTNV

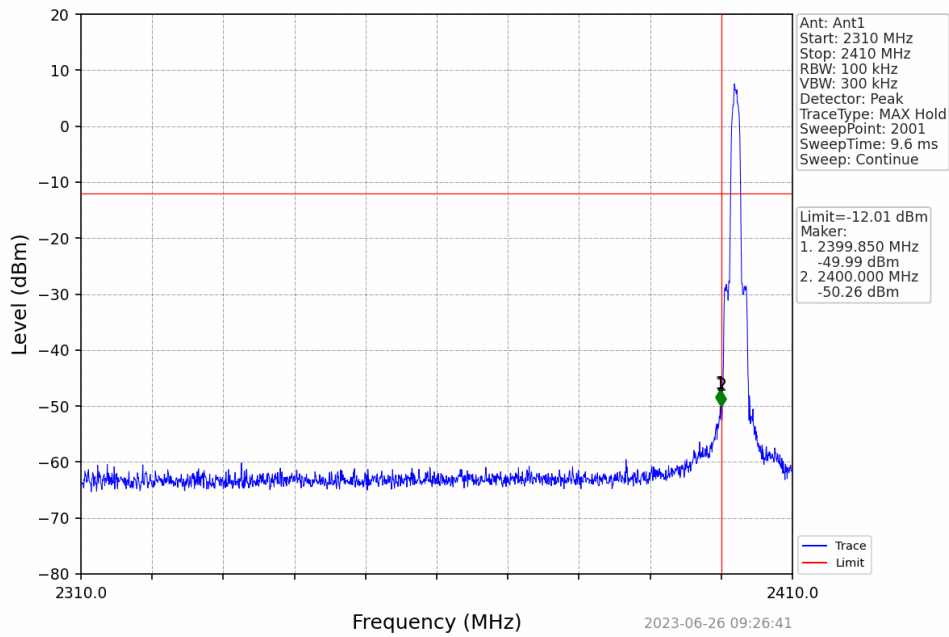

Pi/4DQPSK_2DH5_LCH_2402MHz_Ant1_NTNV

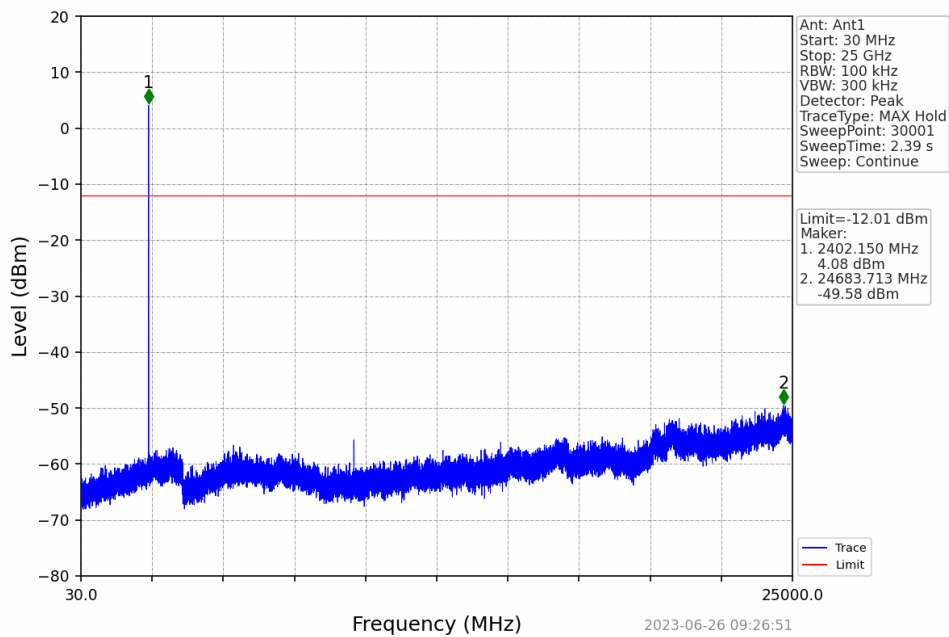



Pi/4DQPSK_2DH5_MCH_2441MHz_Ant1_NTNV

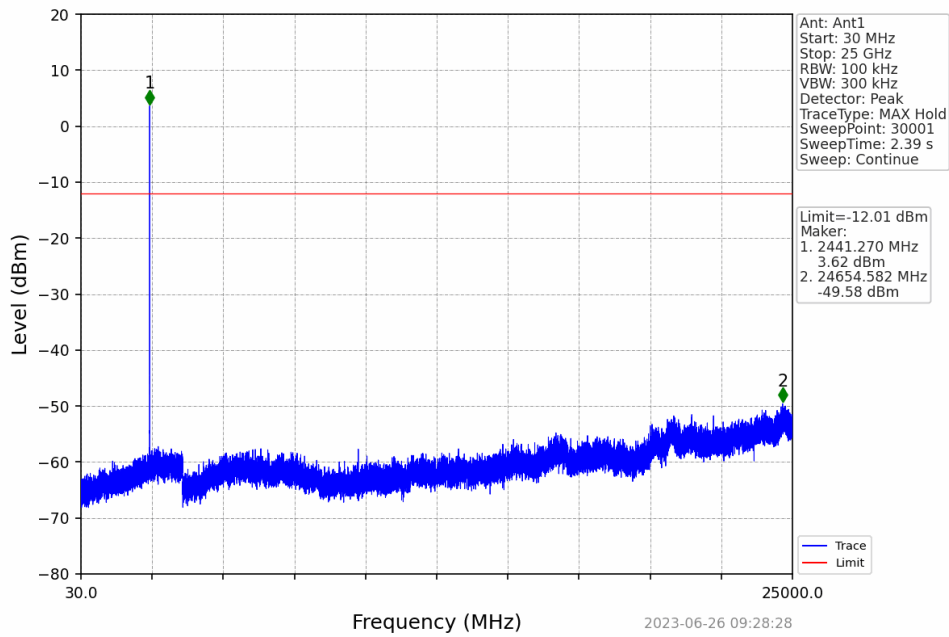

Pi/4DQPSK_2DH5_HCH_2480MHz_Ant1_NTNV

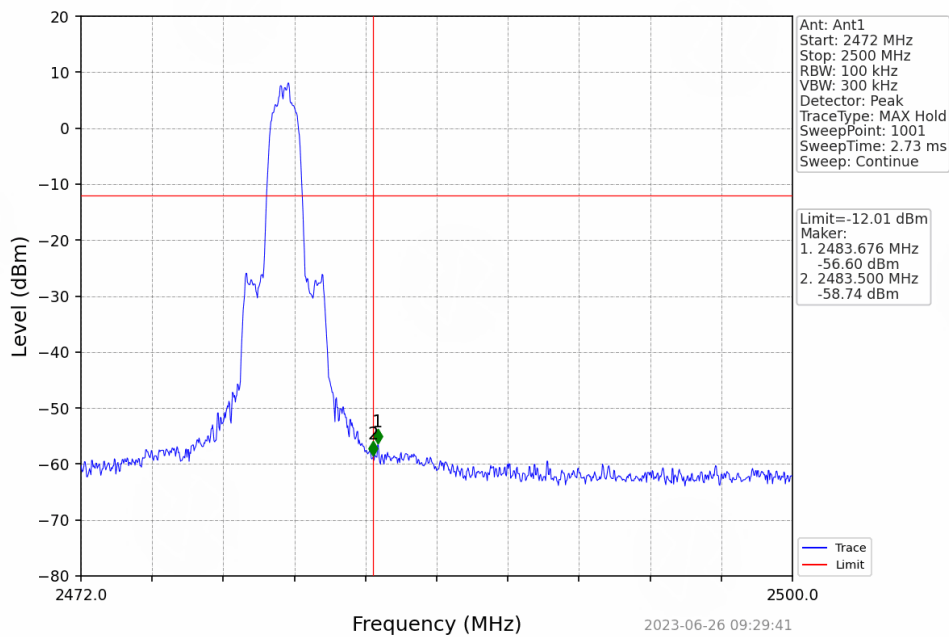



Pi/4DQPSK 2DH5 HCH 2480MHz Ant1 NTN

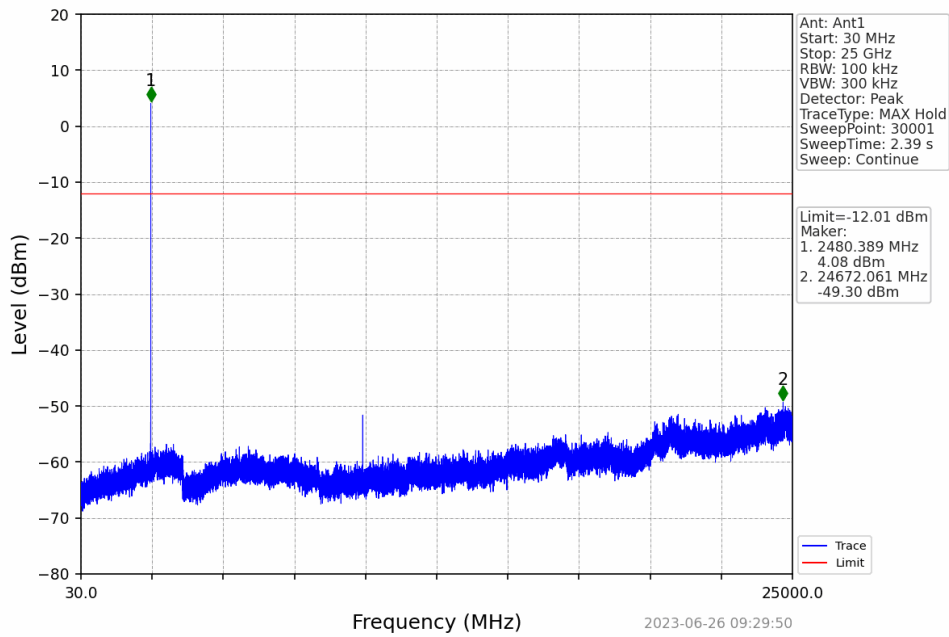

Pi/4DQPSK 2DH5 HOPP Ant1 NTN

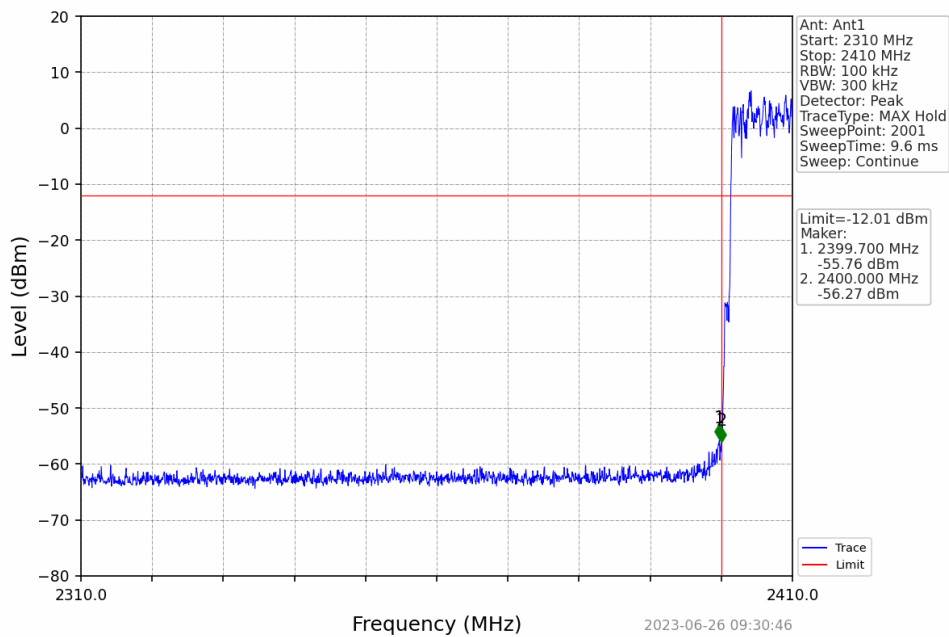

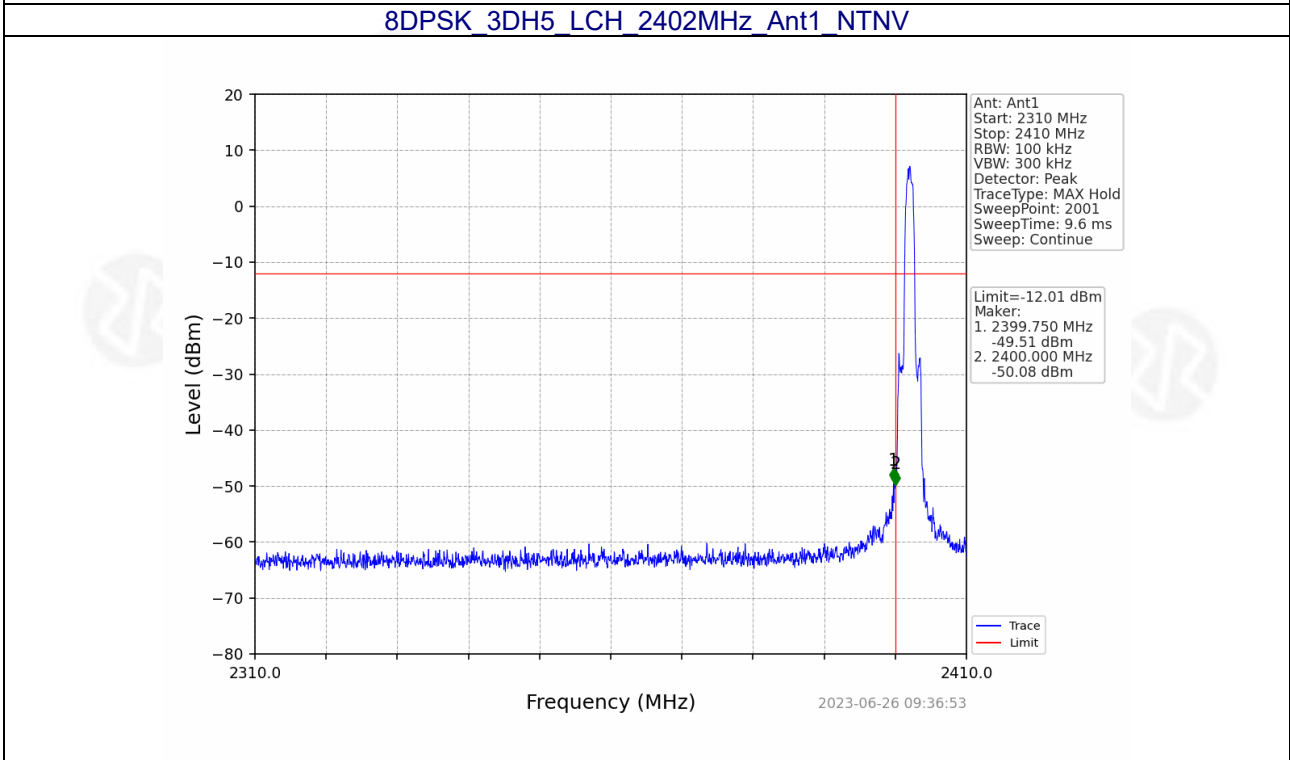
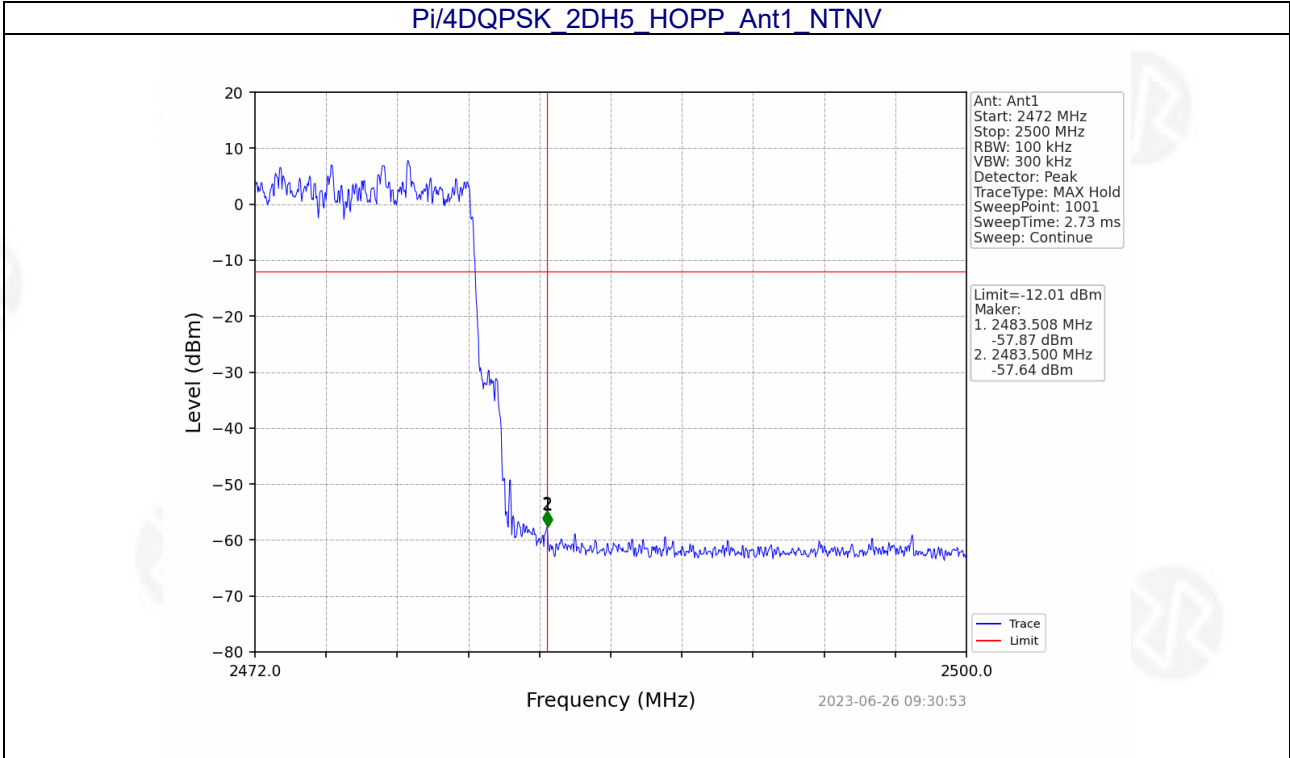



8DPSK 3DH5 LCH 2402MHz Ant1 NTV

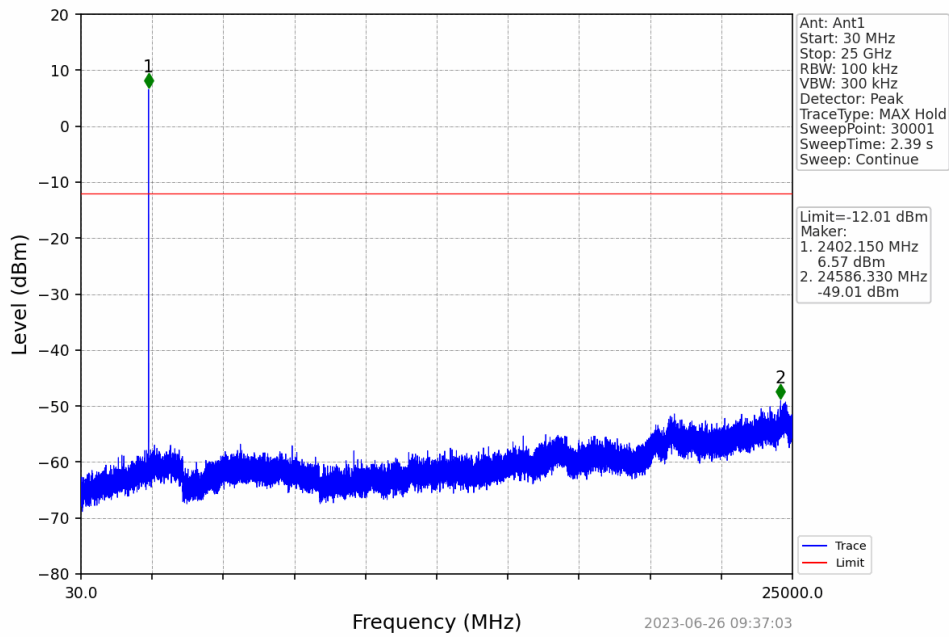

8DPSK 3DH5 MCH 2441MHz Ant1 NTV

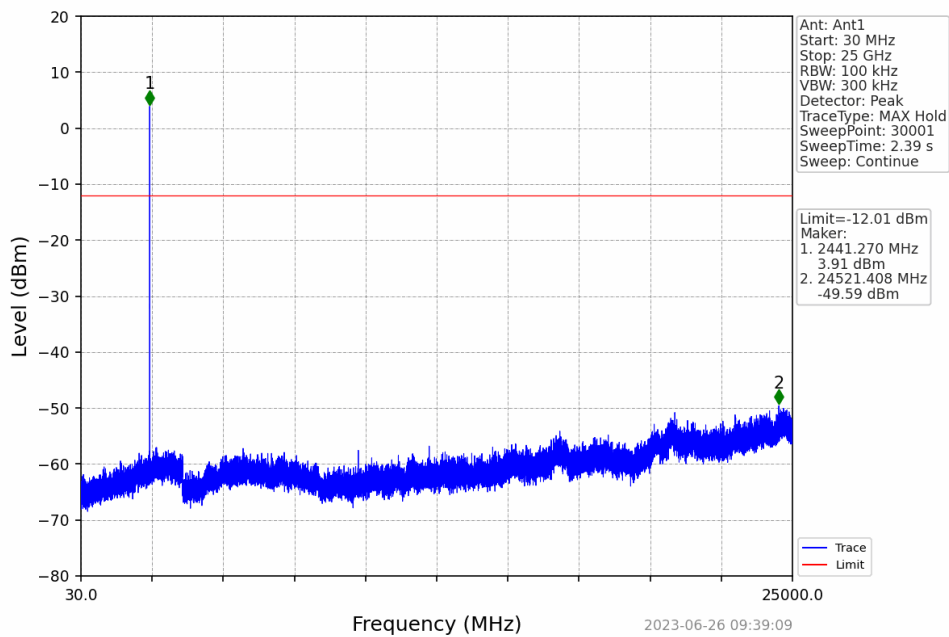

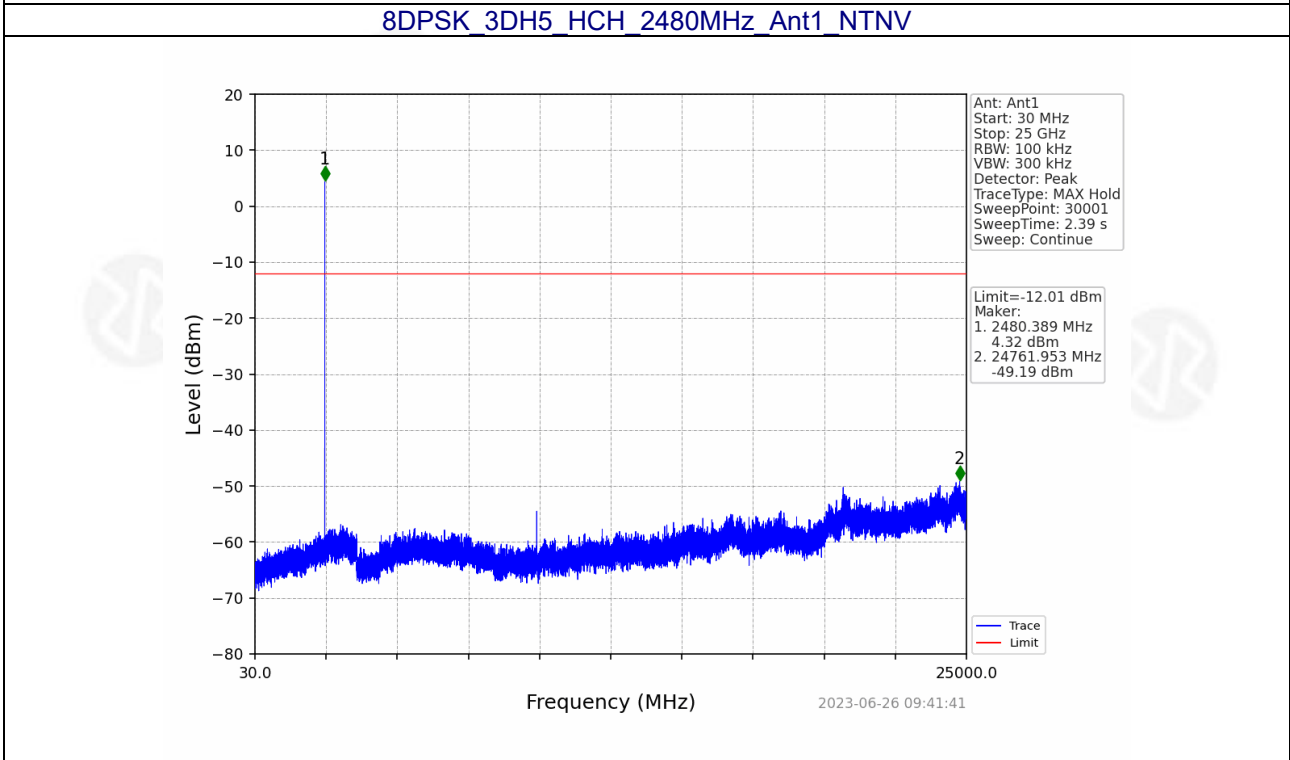
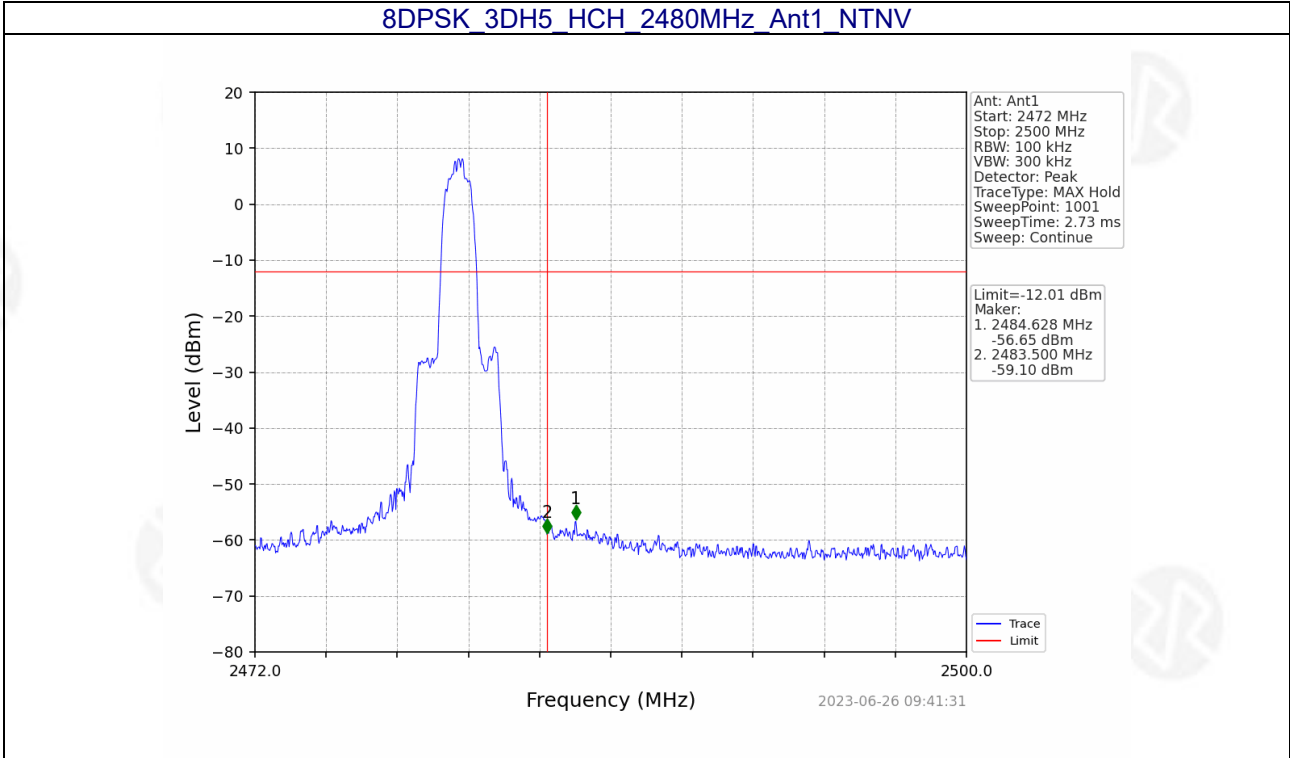

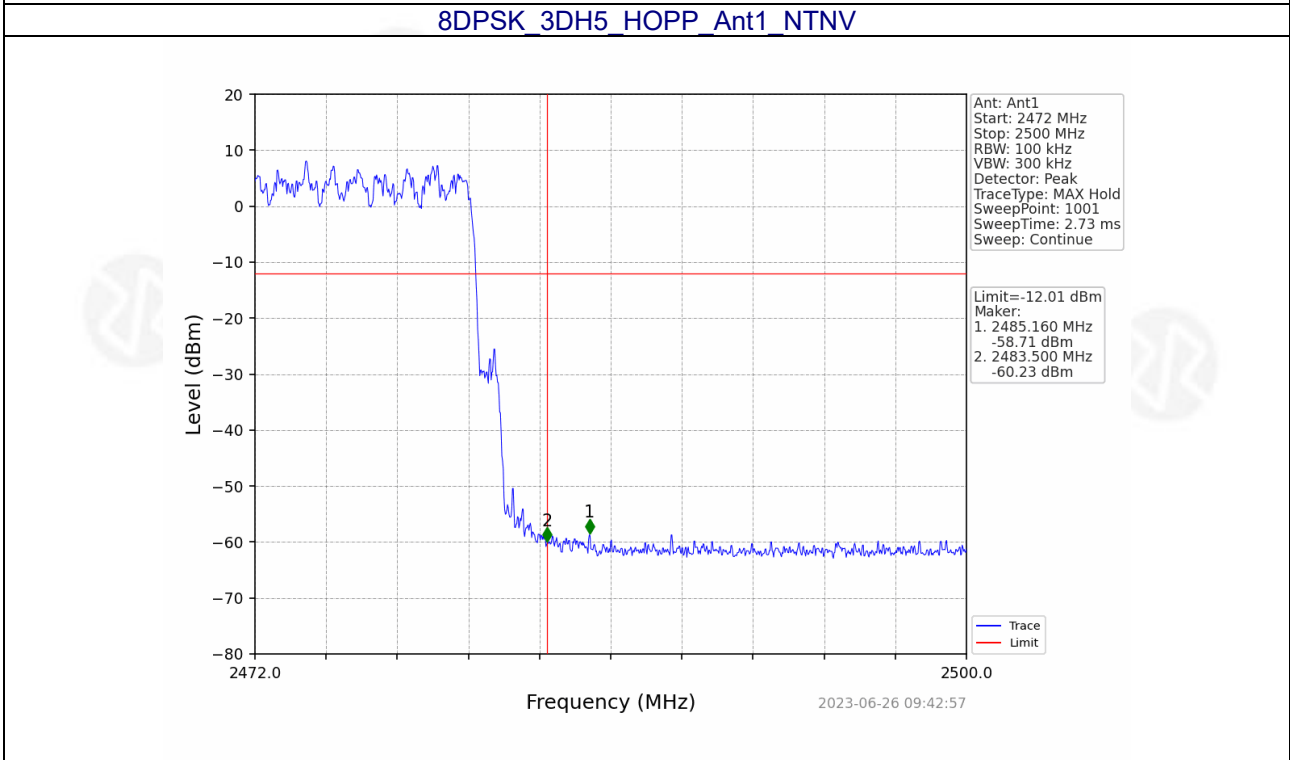
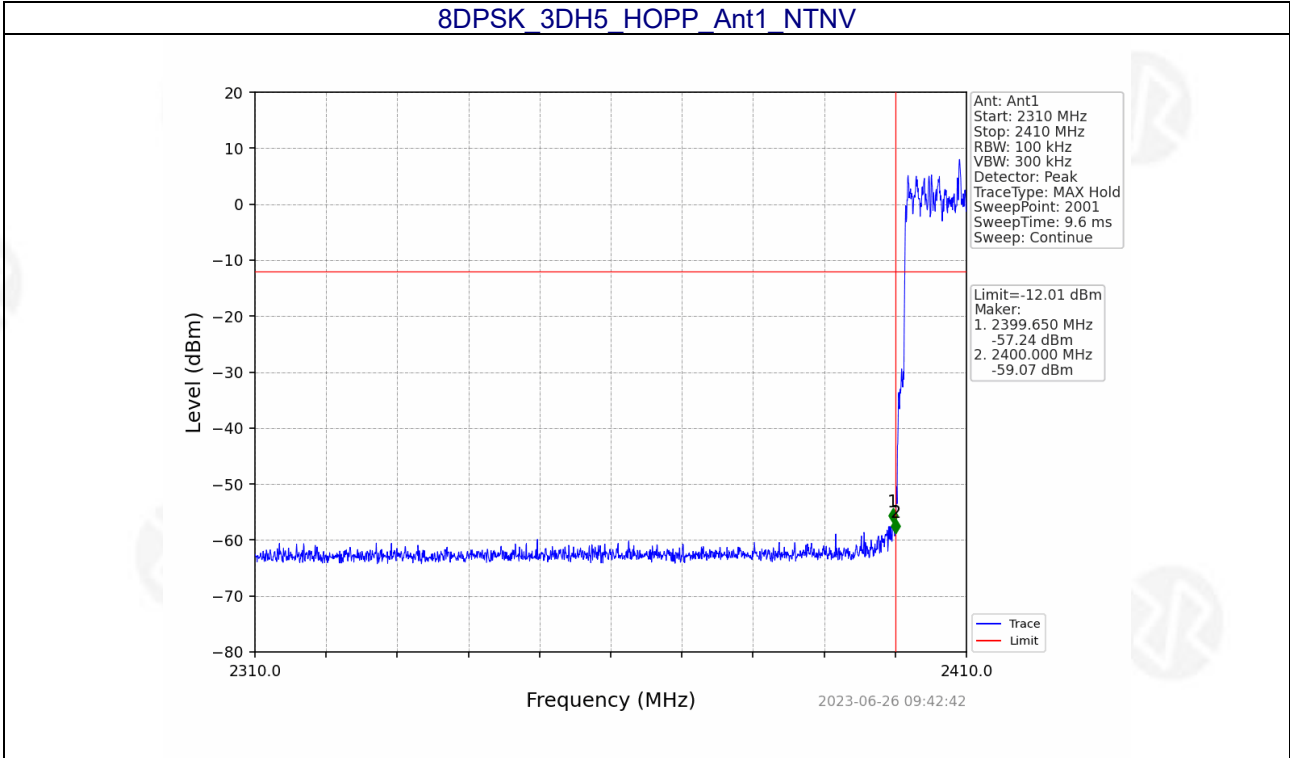



7. 20DB BANDWIDTH

Test Requirement:	FCC Part15 C Section 15.247 (a)(1)
Test Method:	ANSI C63.10:2013

7.1 Test Setup



7.2 Limit

N/A

7.3 Test procedure

1. Set RBW = 30 kHz.
2. Set the video bandwidth (VBW) $\geq 3 \times$ RBW.
3. Detector = Peak.
4. Trace mode = max hold.
5. Sweep = auto couple.
6. Allow the trace to stabilize.
7. Measure the maximum width of the emission that is constrained by the frequencies associated with the two outermost amplitude points (upper and lower frequencies) that are attenuated by 6 dB relative to the maximum level measured in the fundamental emission.

7.4 DEVIATION FROM STANDARD

No deviation.

7.5 Test Result

Mode	Test channel	20dB Emission Bandwidth (MHz)	Result
GFSK	Lowest	0.937	Pass
	Middle	0.938	
	Highest	0.938	
$\pi/4$ -DQPSK	Lowest	1.303	Pass
	Middle	1.299	
	Highest	1.307	
8-DPSK	Lowest	1.314	Pass
	Middle	1.312	
	Highest	1.319	



Test plots

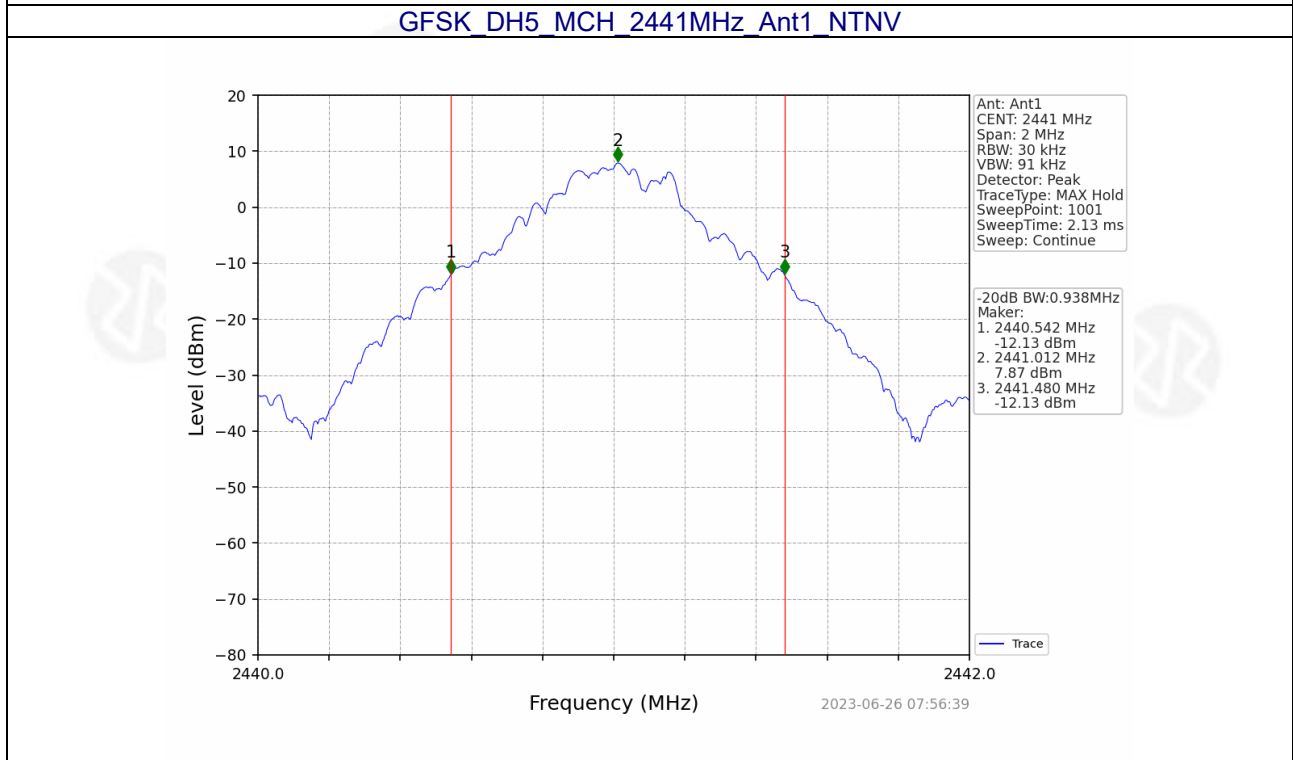
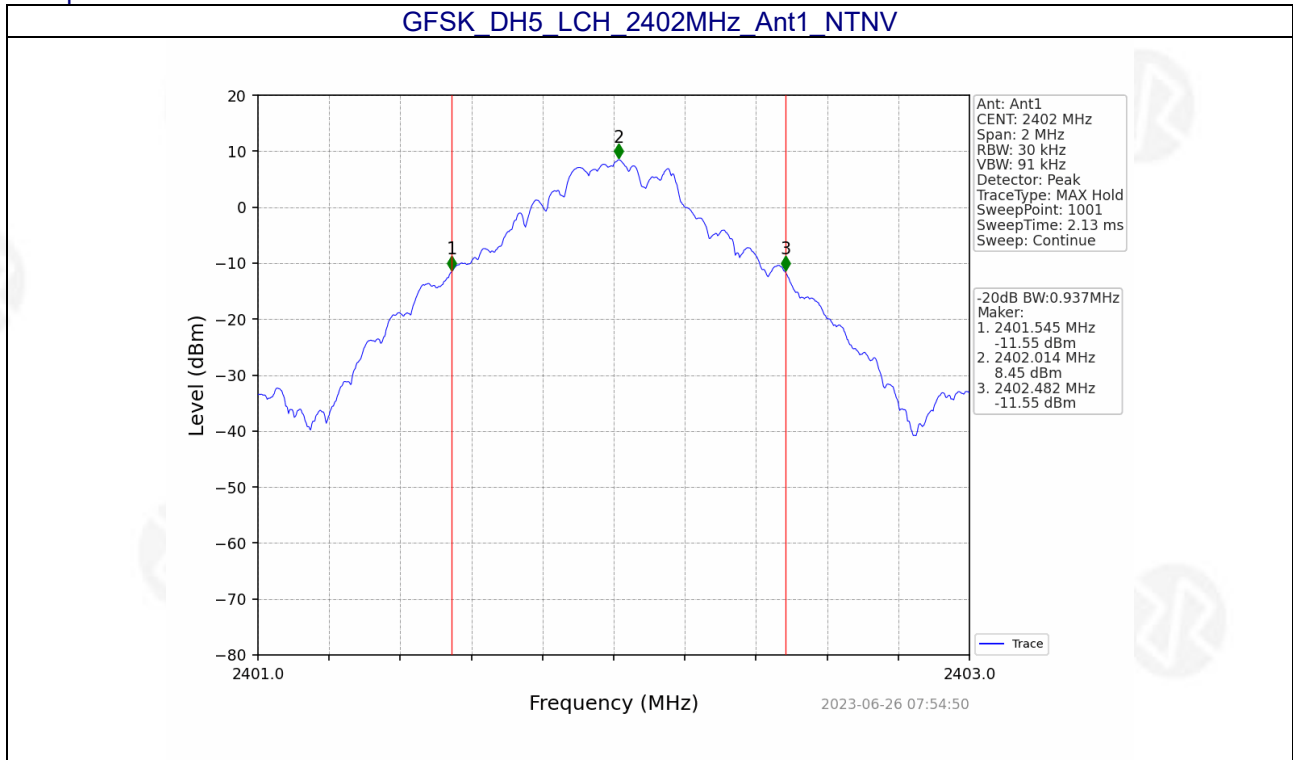

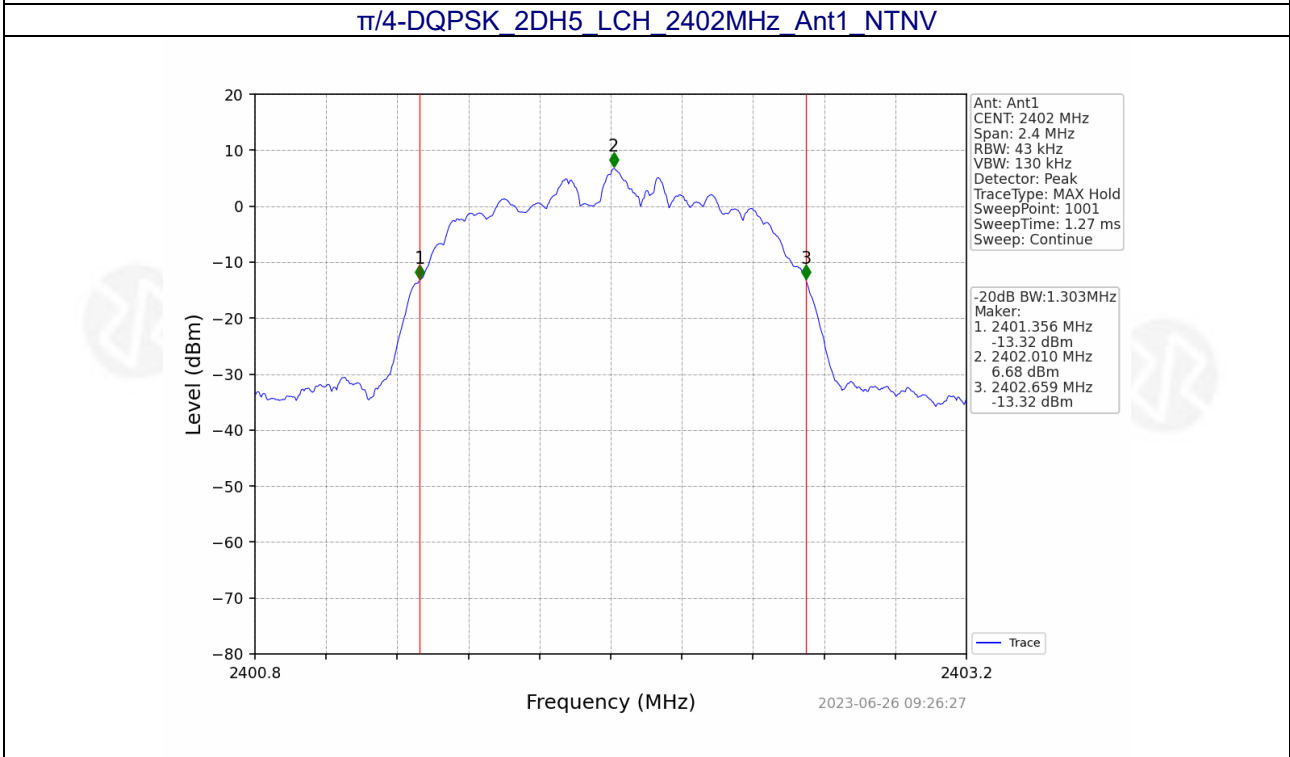
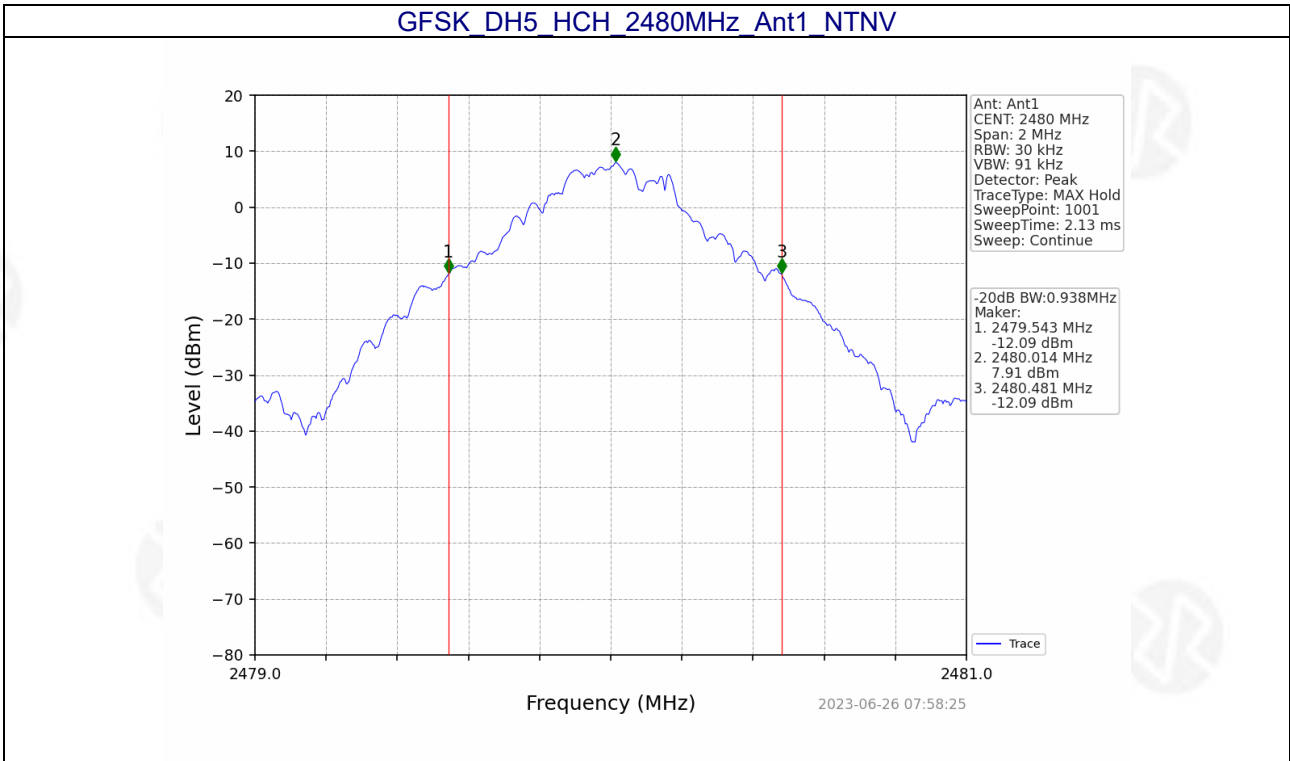

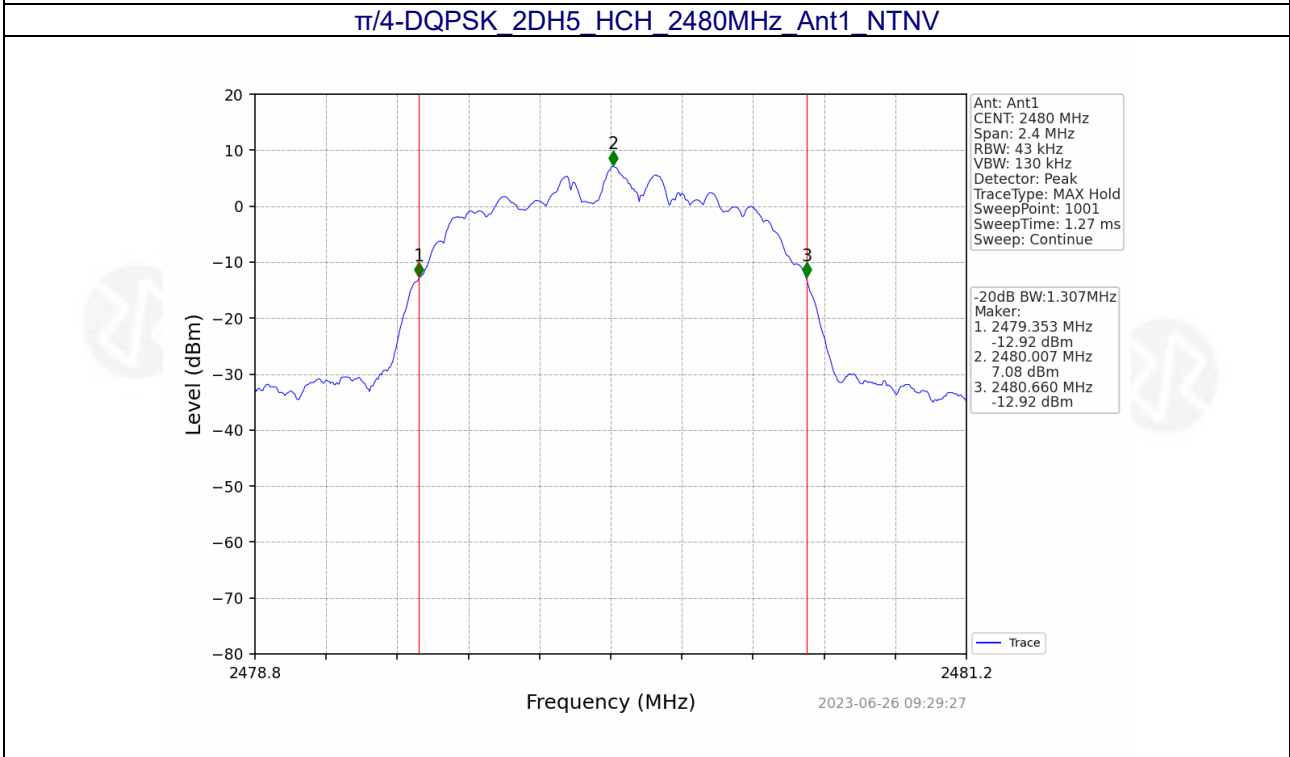
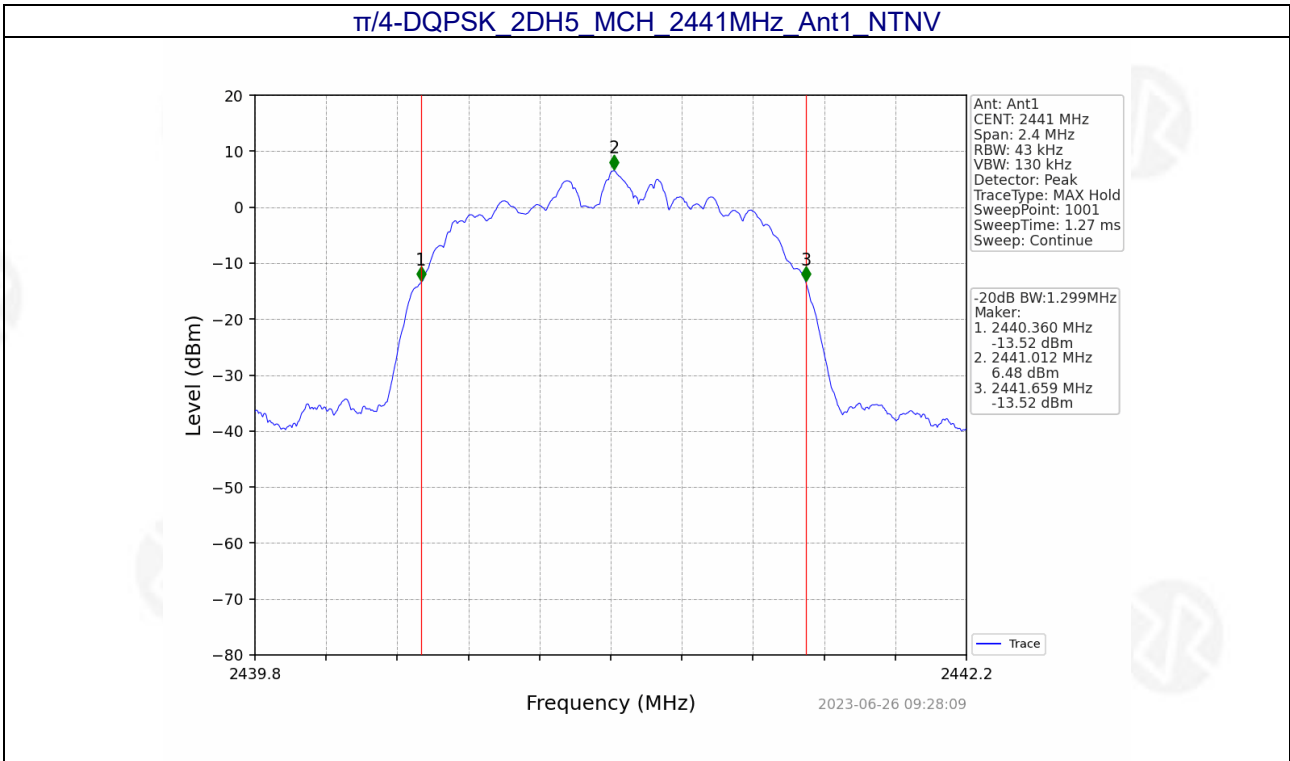

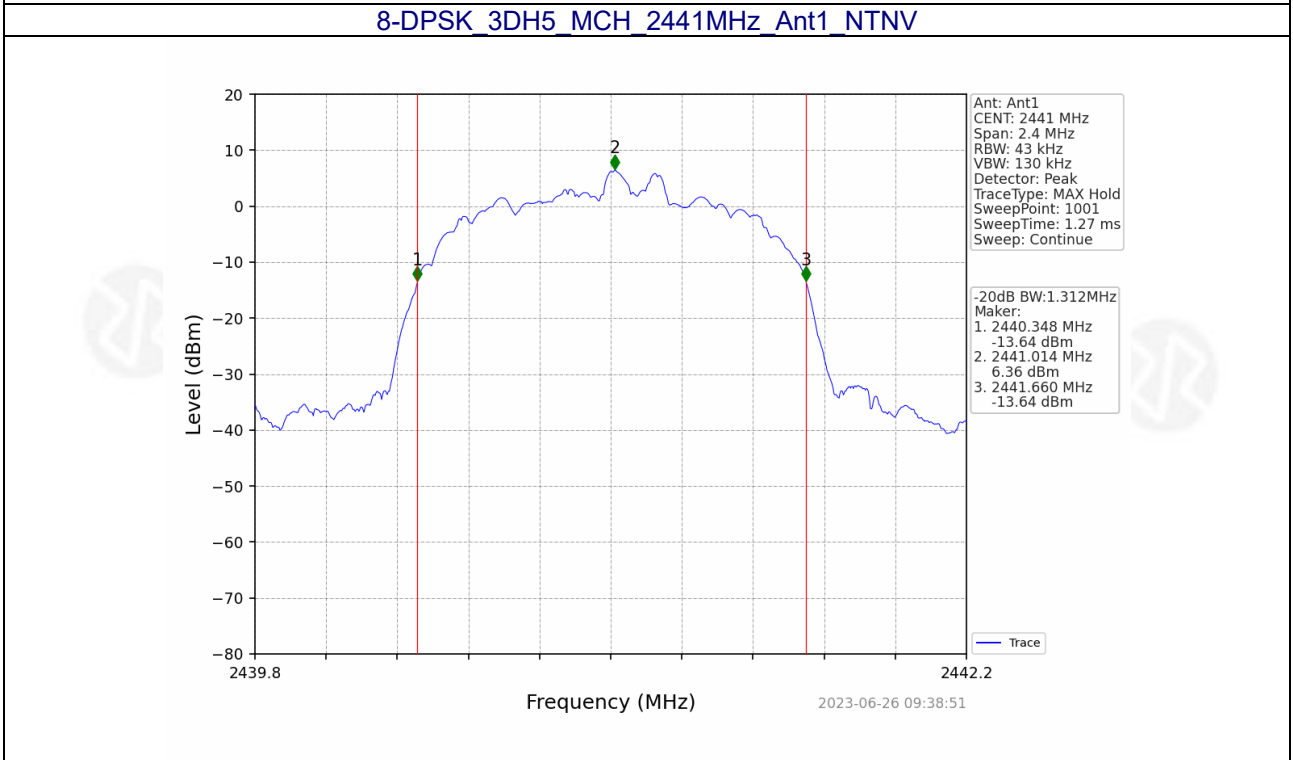
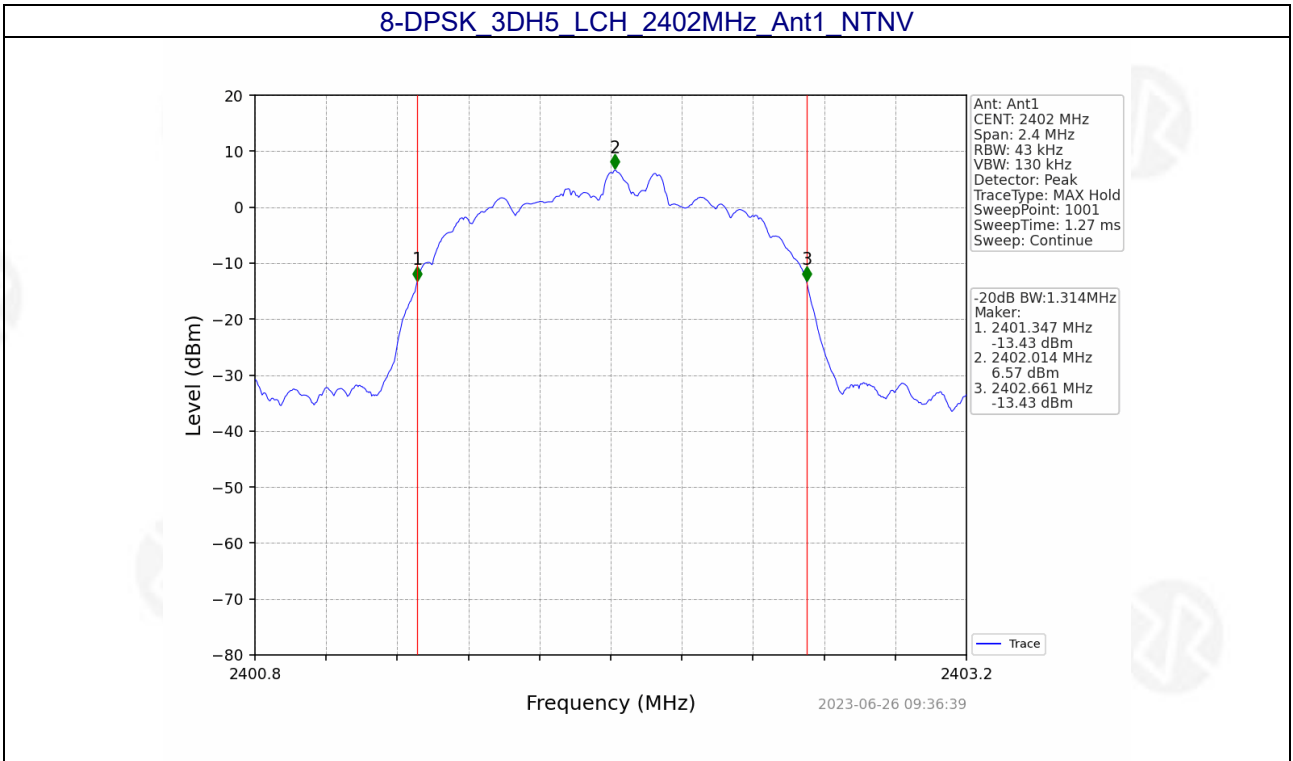

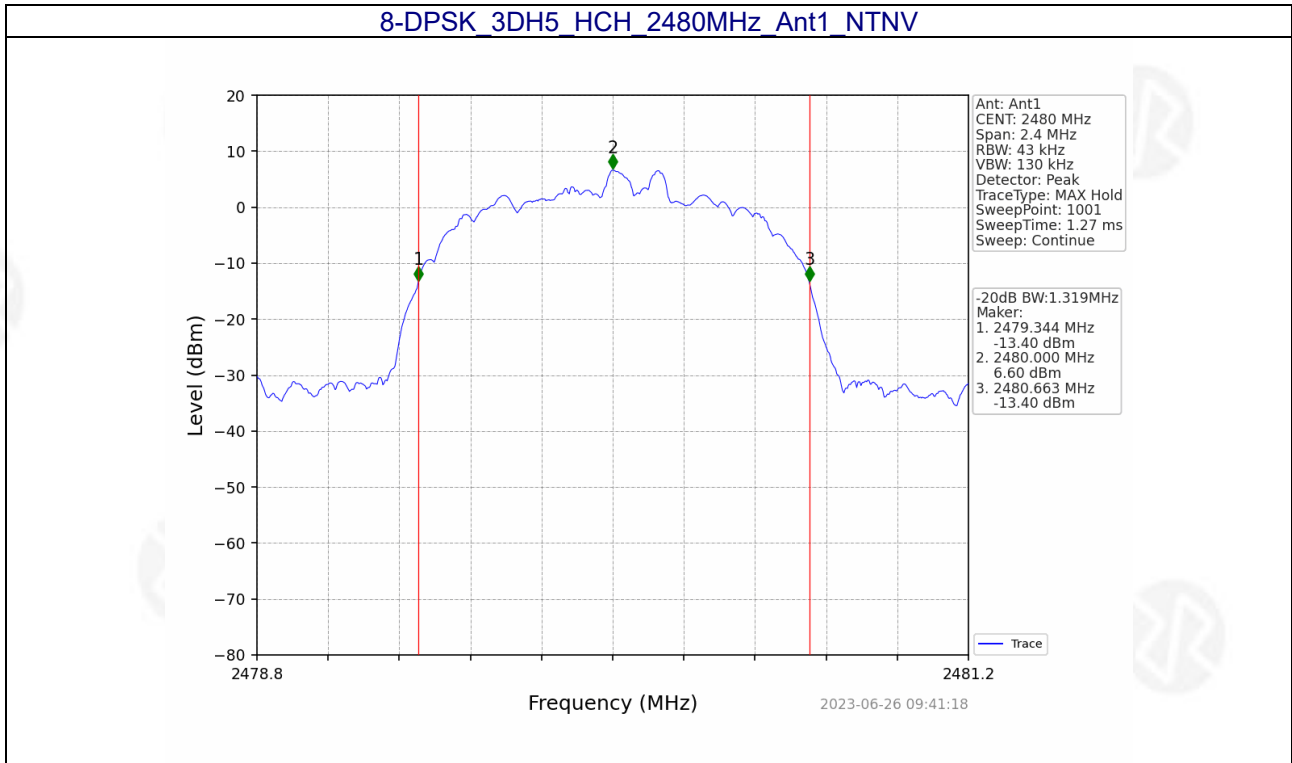



8. Maximum Peak Output Power

Test Requirement:	FCC Part15 C Section 15.247 (b)(1)
Test Method:	ANSI C63.10:2013
Limit:	GFSK:30 dBm $\pi/4$ -DQPSK & 8-DPSK:20.97 dBm

8.1 Block Diagram Of Test Setup

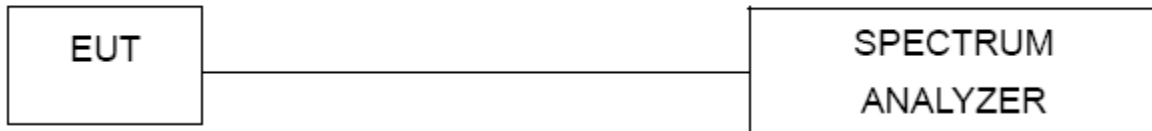

8.2 Limit

For frequency hopping systems operating in the 2400-2483.5 MHz band employing at least 75 non-overlapping hopping channels, and all frequency hopping systems in the 5725-5850 MHz band: 1 watt. For all other frequency hopping systems in the 2400-2483.5 MHz band: 0.125 watts.

For FHSs operating in the band 2400-2483.5 MHz, the maximum peak conducted output power shall not exceed 1.0 W if the hopset uses 75 or more hopping channels; the maximum peak conducted output power shall not exceed 0.125 W if the hopset uses less than 75 hopping channels. The e.i.r.p. shall not exceed 4 W.

8.3 Test procedure

1. Remove the antenna from the EUT and then connect a low RF cable from the antenna port to the spectrum.
2. Set the spectrum analyzer: RBW = 2MHz. VBW =6MHz. Sweep = auto; Detector Function = Peak.
3. Keep the EUT in transmitting at lowest, medium and highest channel individually. Record the max value.

8.4 DEVIATION FROM STANDARD

No deviation.

8.5 Test Result

Mode	Test channel	Peak Output Power (dBm)	FCC Limit (dBm)	Result
GFSK	Lowest	10.13	30.00	Pass
	Middle	9.53		
	Highest	9.60		
$\pi/4$ -DQPSK	Lowest	9.09	21.00	Pass
	Middle	9.20		
	Highest	9.47		
8-DPSK	Lowest	9.31	21.00	Pass
	Middle	9.48		
	Highest	9.69		



Test plots

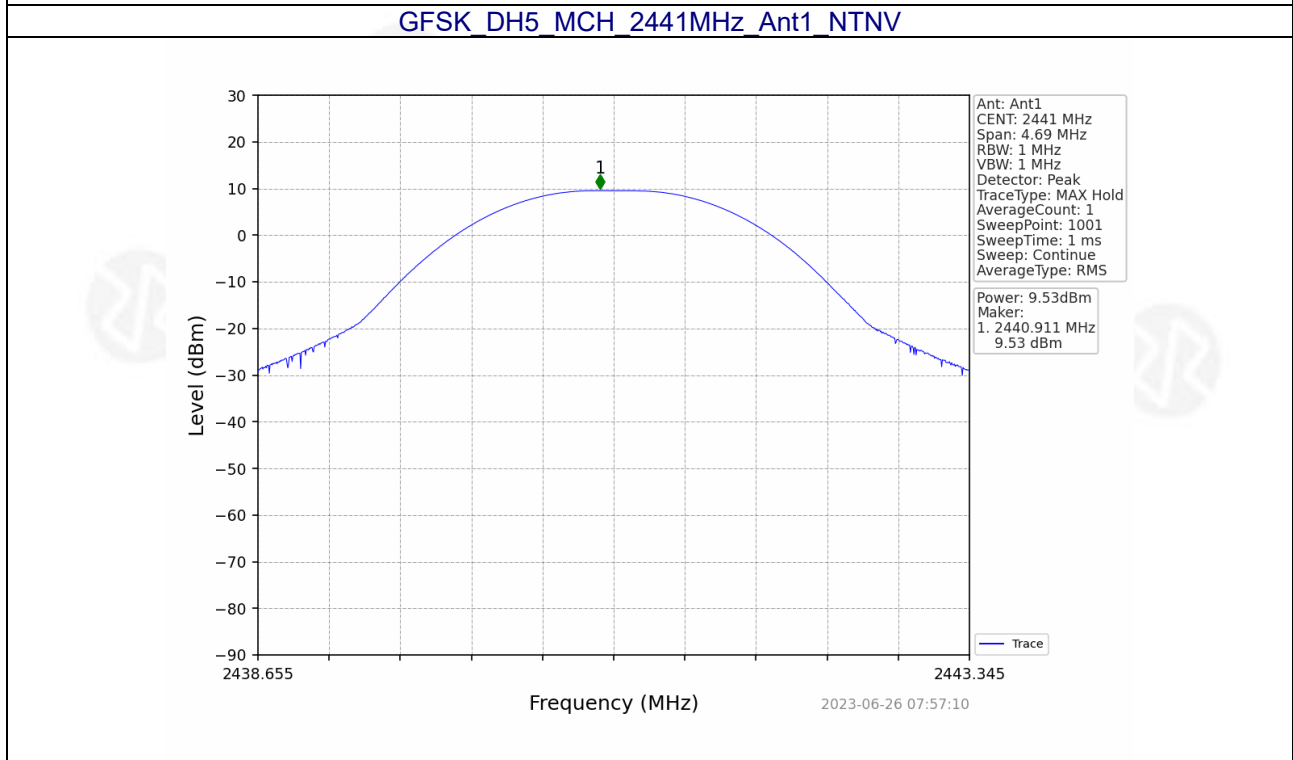
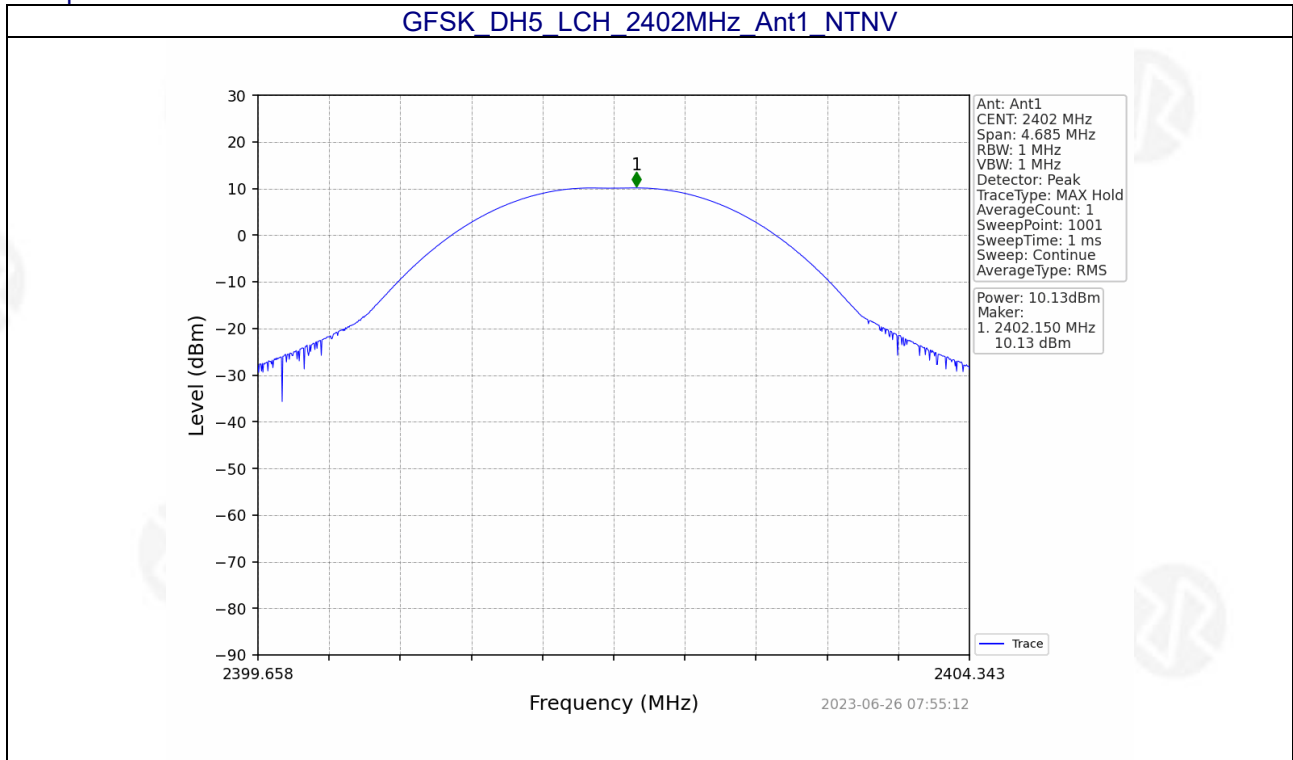

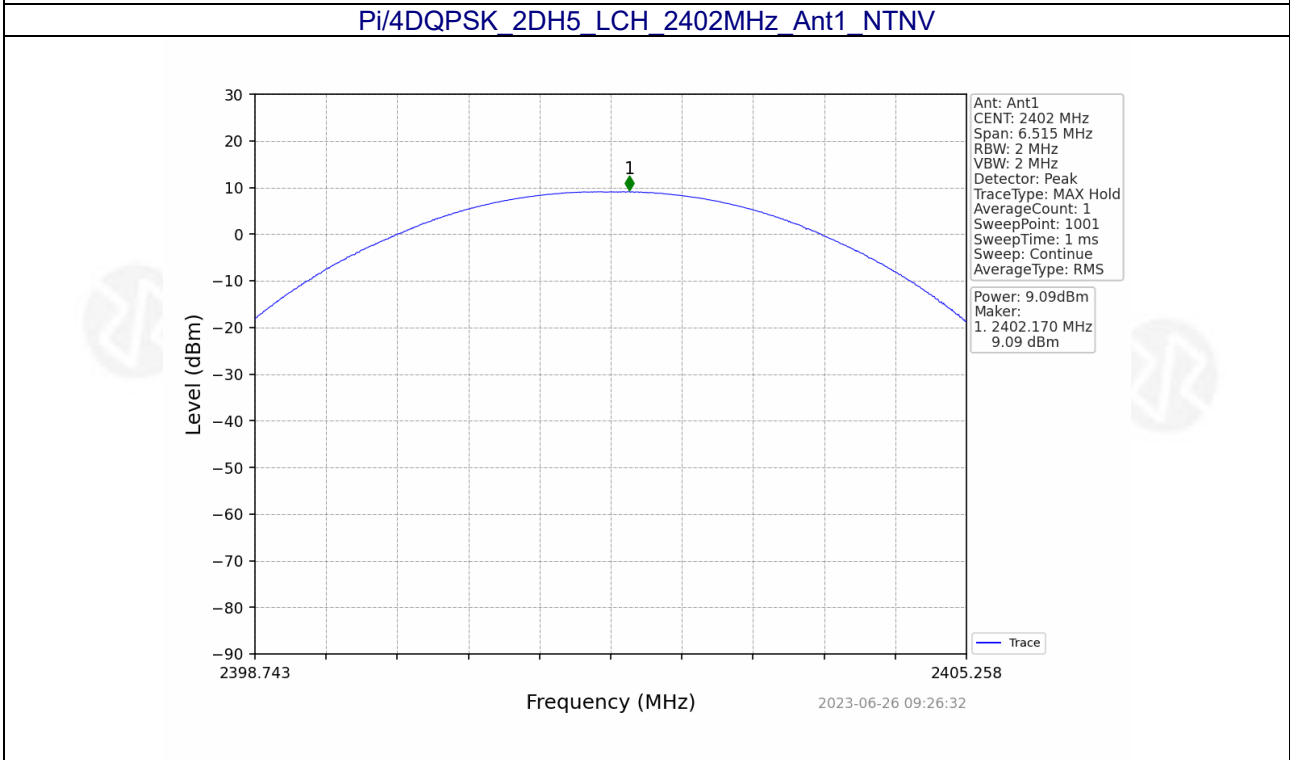
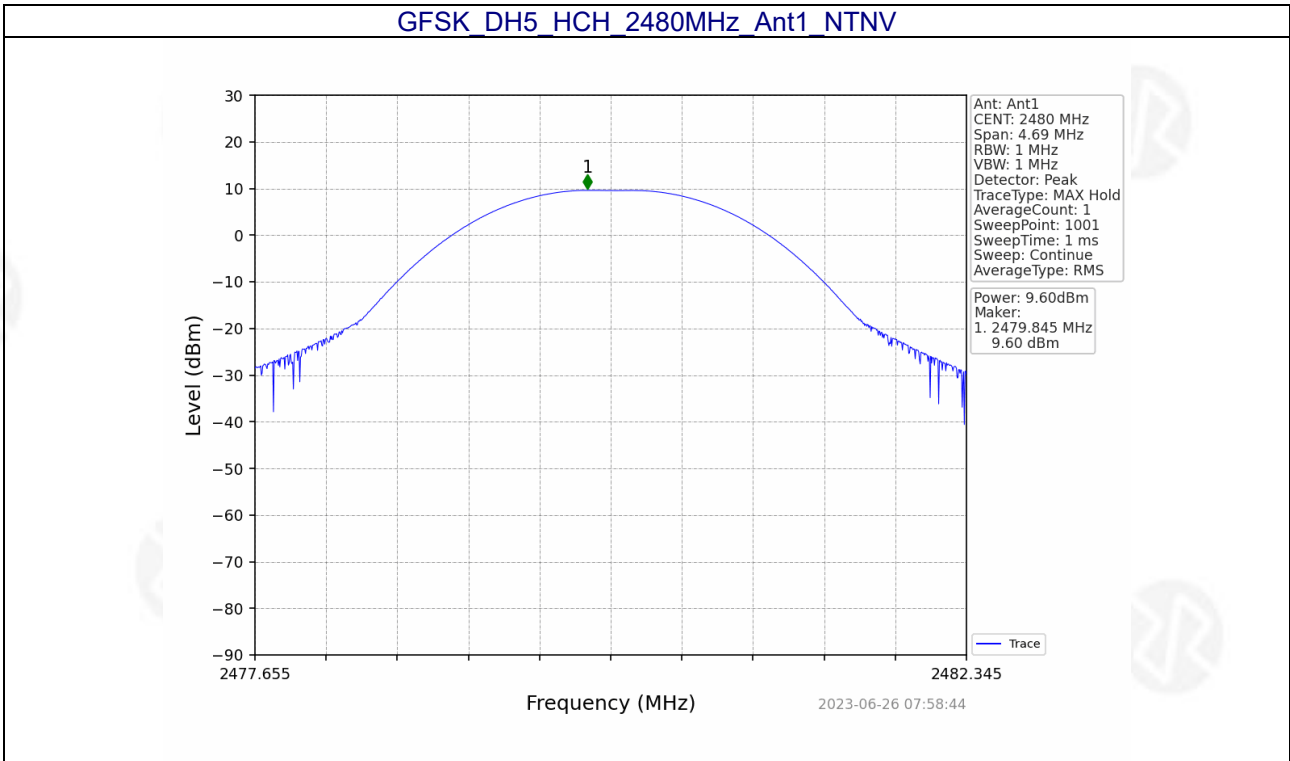



Pi/4DQPSK 2DH5 MCH 2441MHz Ant1_NTNV

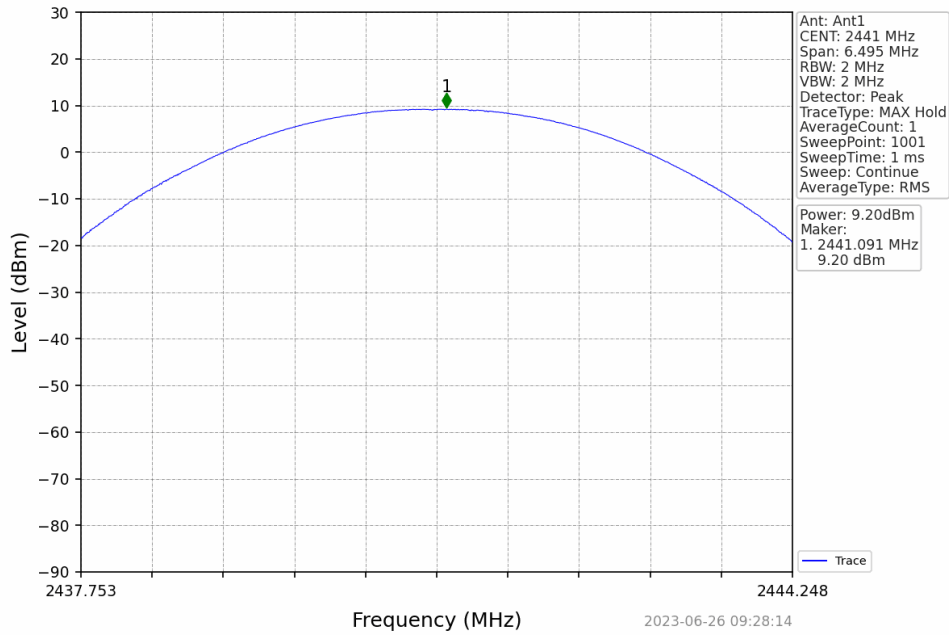

Pi/4DQPSK 2DH5 HCH 2480MHz Ant1_NTNV

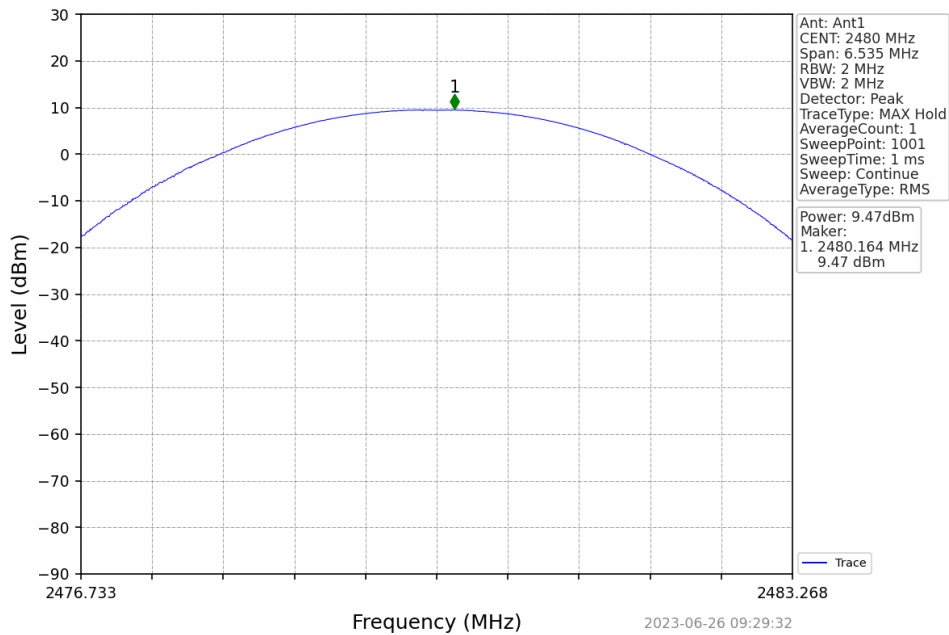

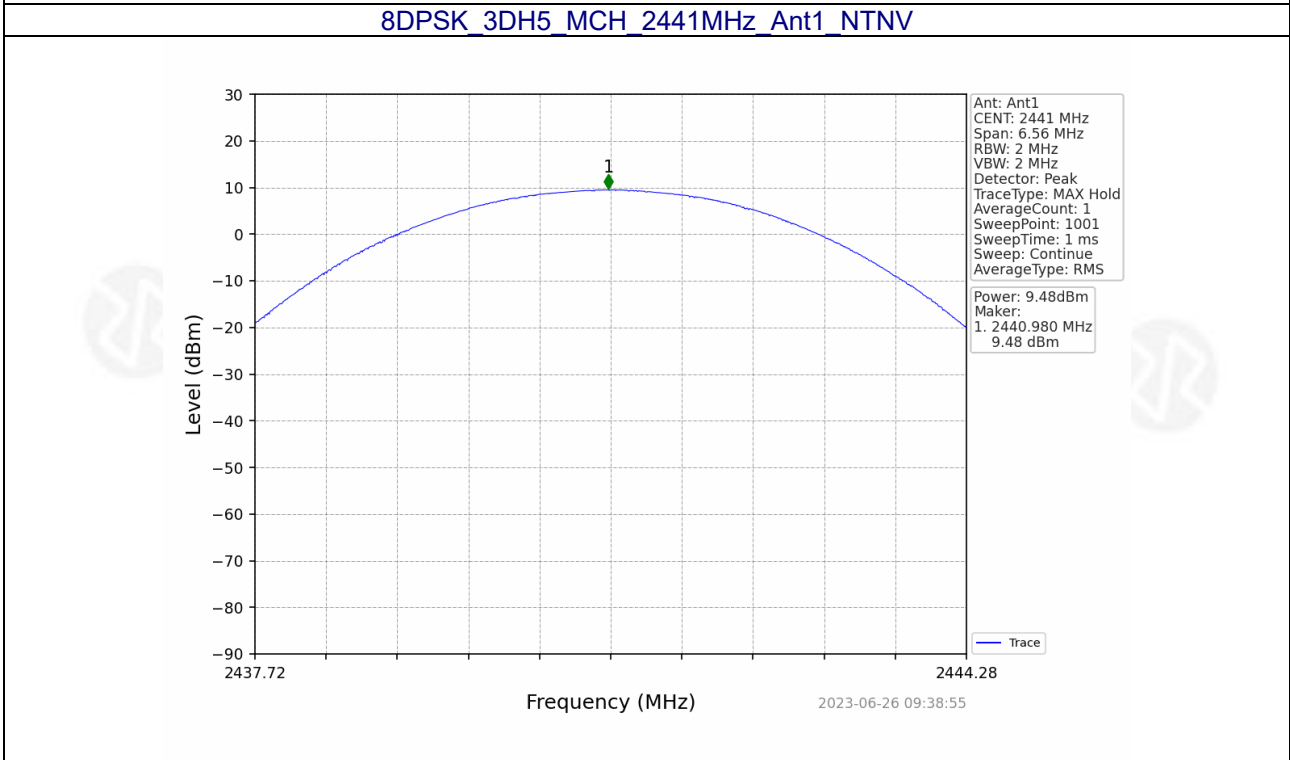
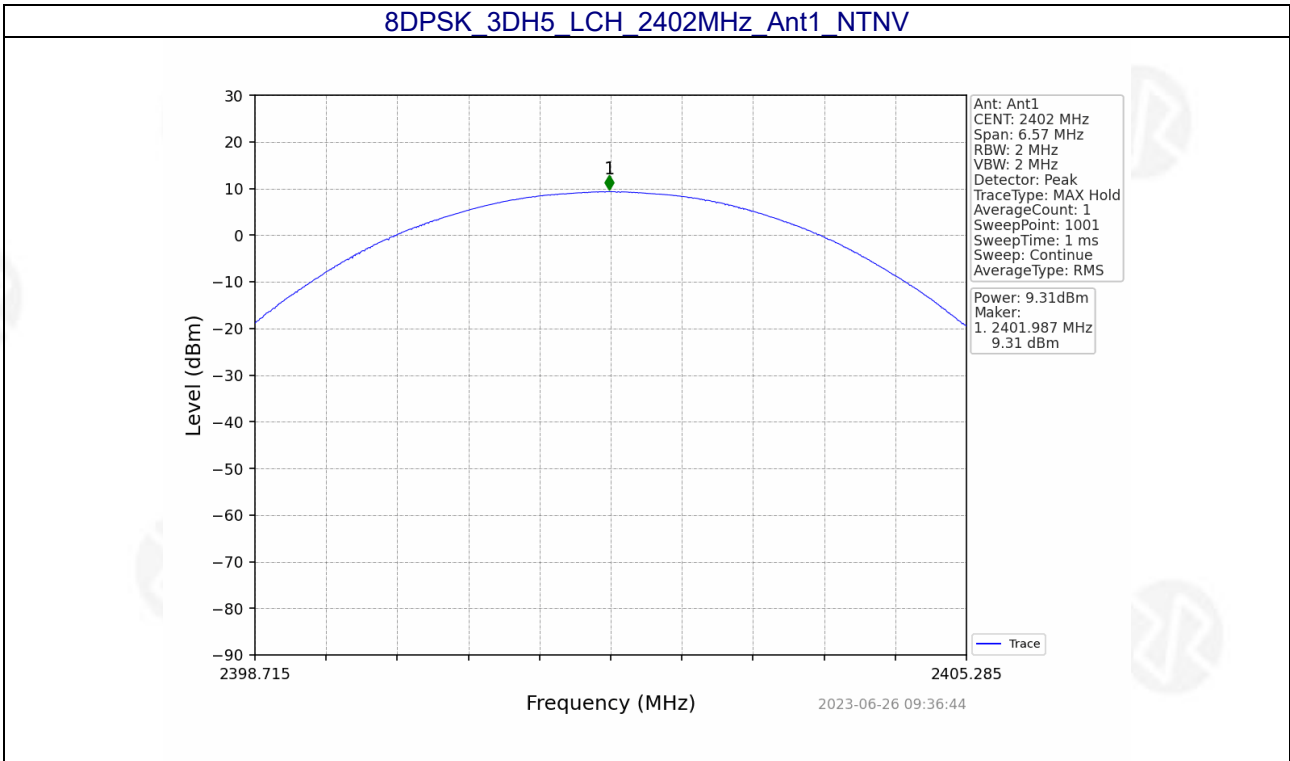

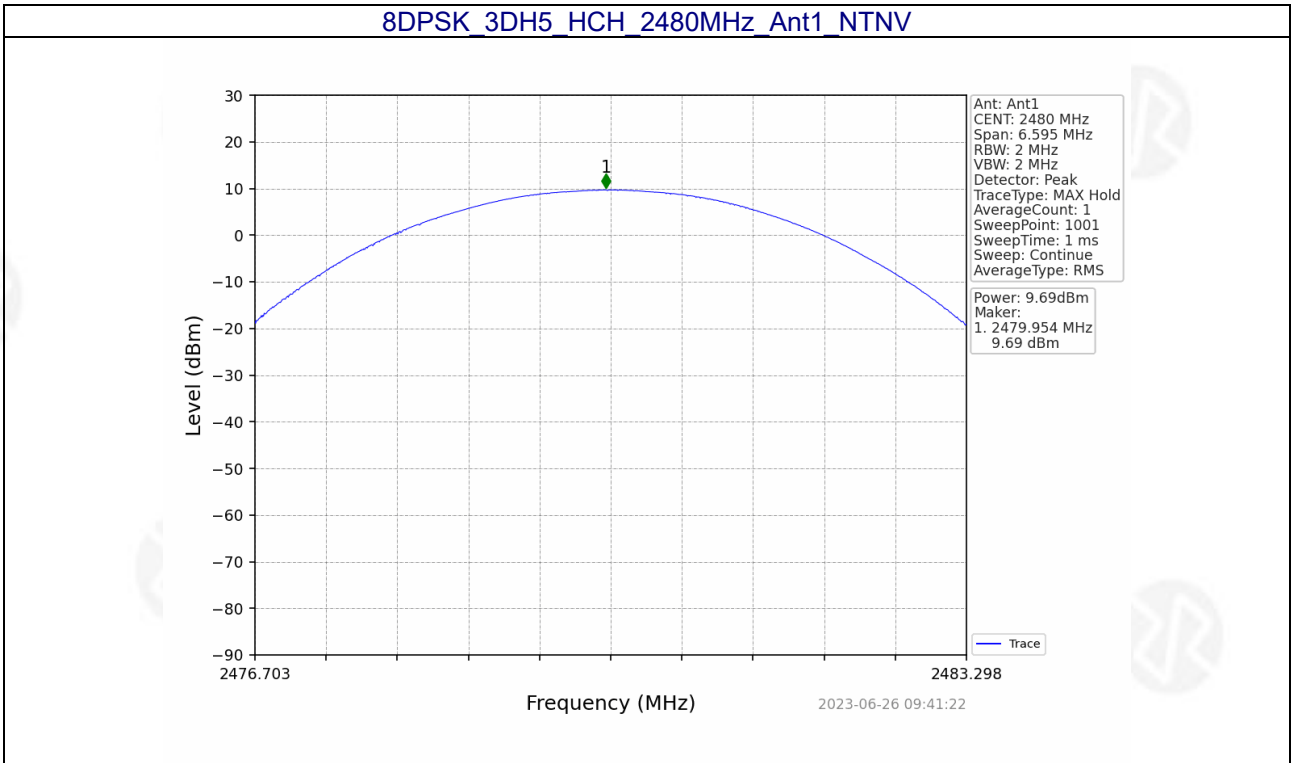



9. HOPPING CHANNEL SEPARATION

Test Requirement:	FCC Part15 C Section 15.247 (a)(1)
Test Method:	ANSI C63.10:2013
Receiver setup:	RBW=30KHz, VBW=100KHz, detector=Peak
Limit:	GFSK: 20dB bandwidth $\pi/4$ -DQPSK & 8DSK: 0.025MHz or 2/3 of the 20dB bandwidth (whichever is greater)

9.1 Test Setup



9.2 Test procedure

1. Remove the antenna from the EUT and then connect a low RF cable from the antenna port to the spectrum.
2. Set the spectrum analyzer: RBW = 30kHz. VBW = 100kHz , Span = 3.0MHz. Sweep = auto; Detector Function = Peak. Trace = Max hold.
3. Allow the trace to stabilize. Use the marker-delta function to determine the separation between the peaks of the adjacent channels. The limit is specified in one of the subparagraphs of this Section Submit this plot.

9.3 DEVIATION FROM STANDARD

No deviation.



9.4 Test Result

Mode	TX Type	Frequency (MHz)	Packet Type	Channel Separation (MHz)	20dB Bandwidth (MHz)	Limit (MHz)	Verdict
GFSK	SISO	HOPP	DH5	1.000	0.938	>=0.938	Pass
$\pi/4$ -DQPSK	SISO	HOPP	2DH5	0.998	1.307	>=0.871	Pass
8-DPSK	SISO	HOPP	2DH5	1.001	1.319	>=0.879	Pass

Test plots

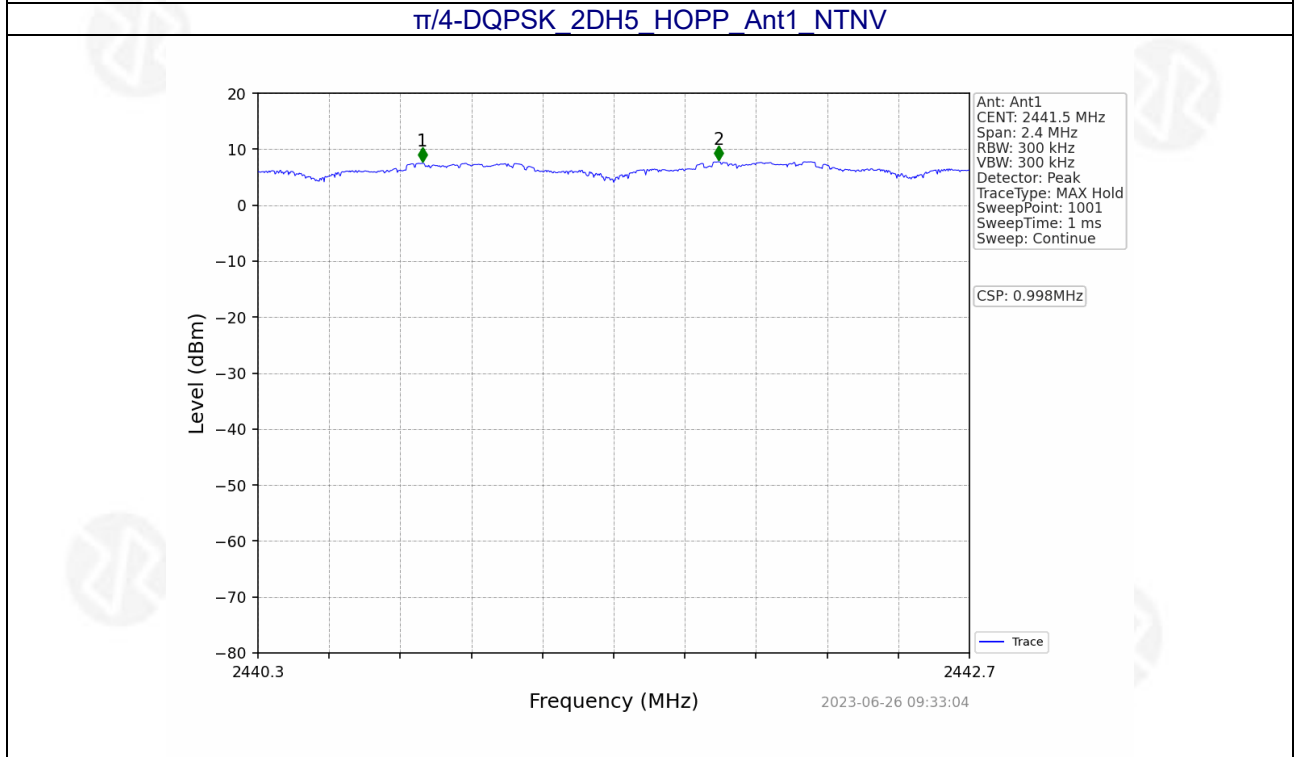
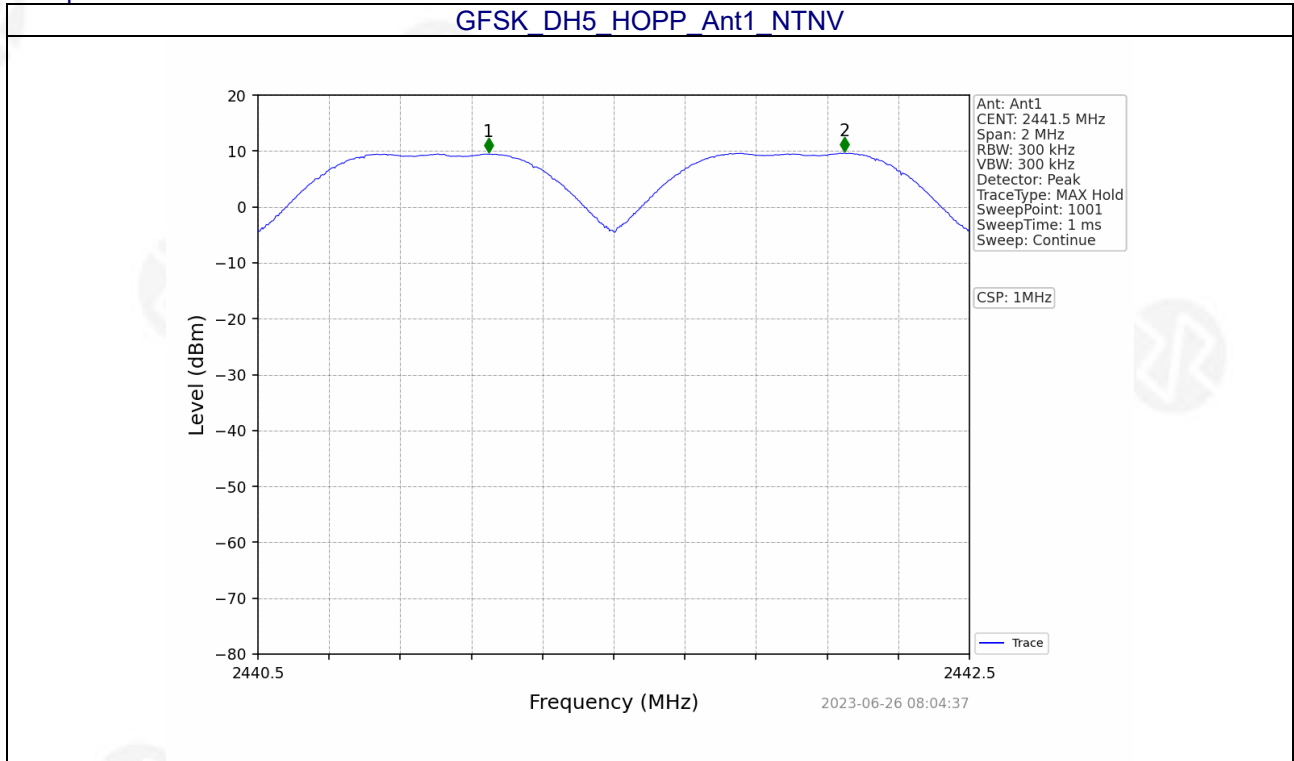

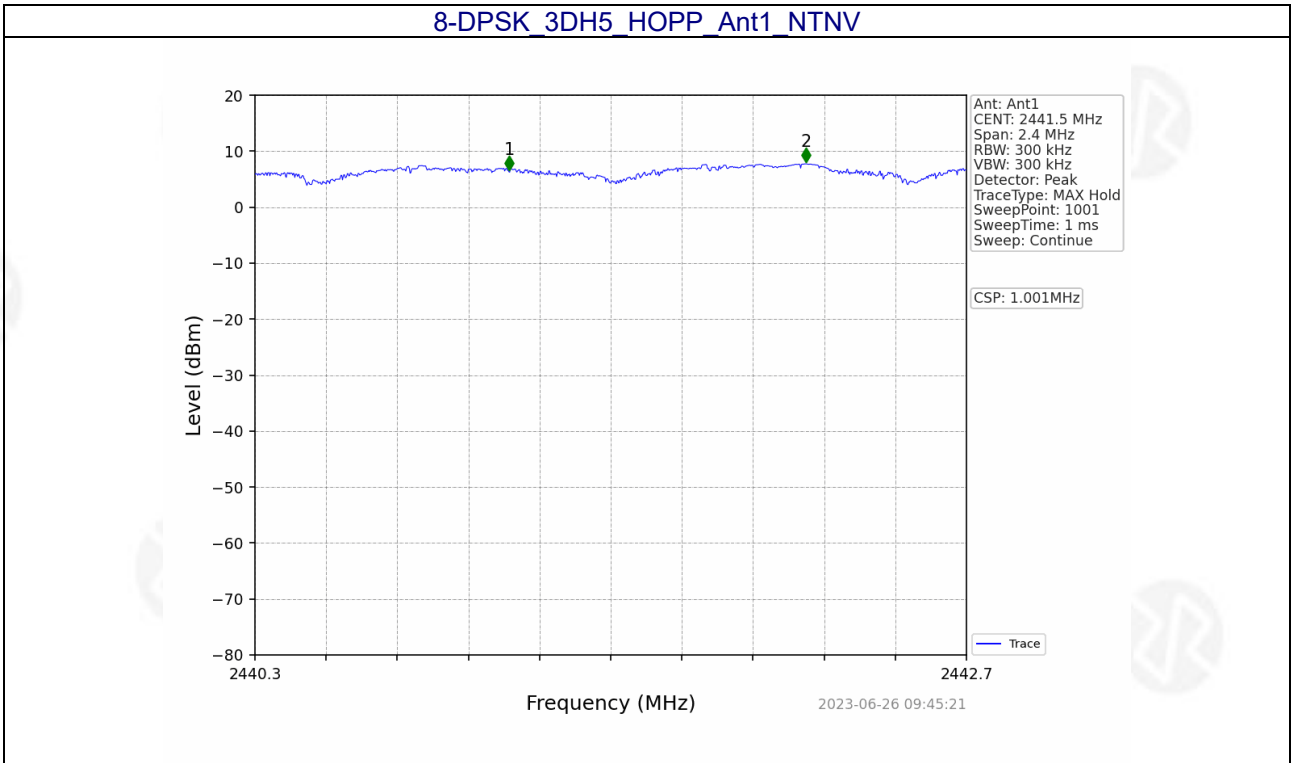



10. NUMBER OF HOPPING FREQUENCY

Test Requirement:	FCC Part15 C Section 15.247 (a)(1)(iii)
Test Method:	ANSI C63.10:2013
Receiver setup:	RBW=100kHz, VBW=300kHz, Frequency range=2400MHz-2483.5MHz, Detector=Peak
Limit:	15 channels

10.1 Test Setup



10.2 Test procedure

1. Remove the antenna from the EUT and then connect a low RF cable from the antenna port to the spectrum.
2. Set the spectrum analyzer: RBW = 100kHz. VBW = 300kHz. Sweep = auto; Detector Function = Peak. Trace = Max hold.
3. Allow the trace to stabilize. It may prove necessary to break the span up to sections. in order to clearly show all of the hopping frequencies. The limit is specified in one of the subparagraphs of this Section.
4. Set the spectrum analyzer: Start Frequency = 2.4GHz, Stop Frequency = 2.4835GHz. Sweep=auto;

10.3 DEVIATION FROM STANDARD

No deviation.



10.4 Test Result

Mode	TX Type	Frequency (MHz)	Packet Type	Num of Hopping Frequencies		Verdict
				ANT1	Limit	
GFSK	SISO	HOPP	DH5	79	>=15	Pass
$\pi/4$ -DQPSK	SISO	HOPP	2DH5	79	>=15	Pass
8-DPSK	SISO	HOPP	2DH5	79	>=15	Pass

Test plots

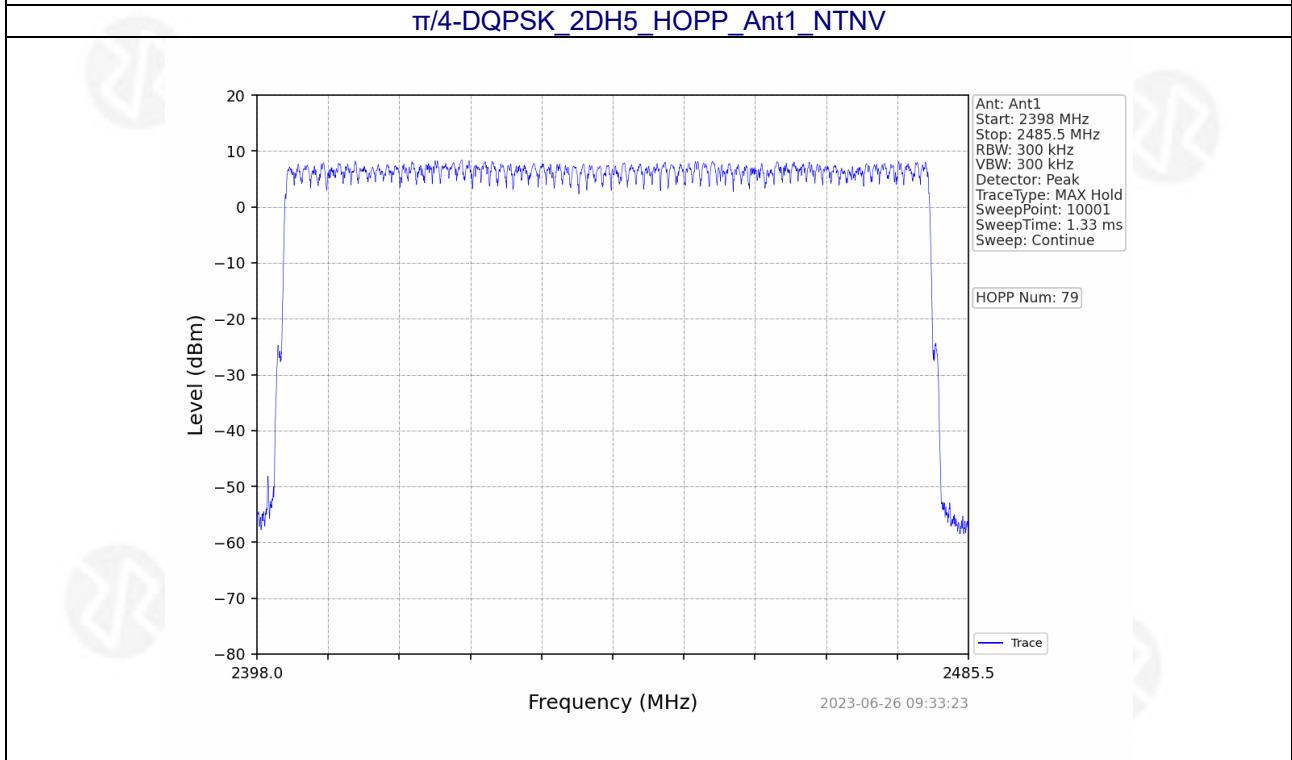
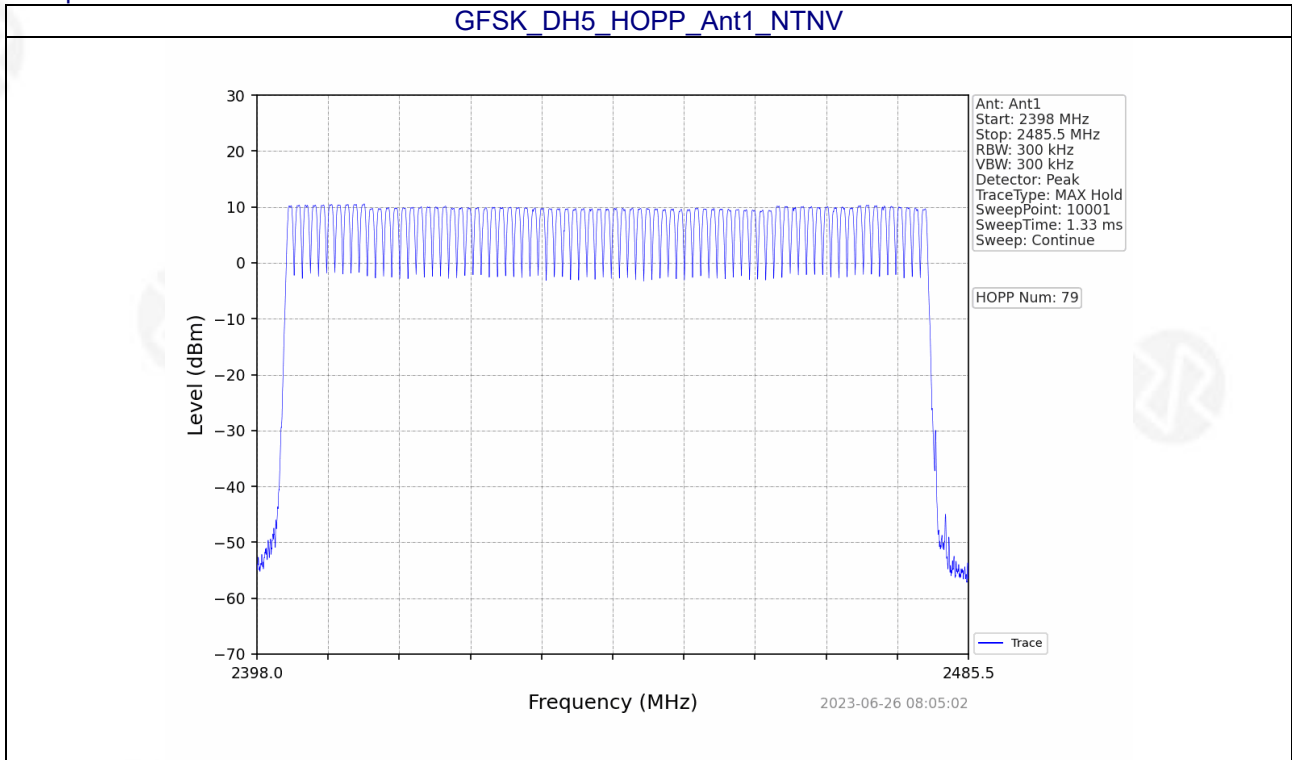

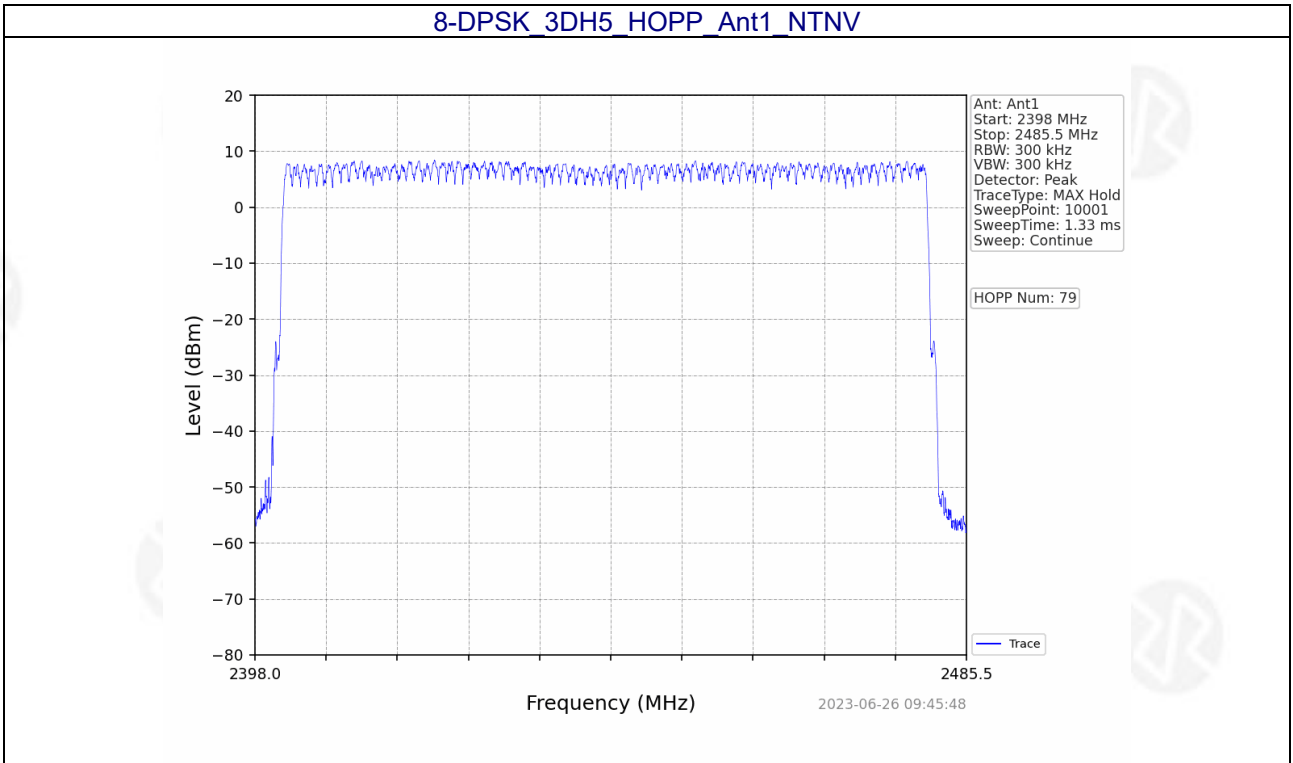



11. DWELL TIME

Test Requirement:	FCC Part15 C Section 15.247 (a)(1)(iii)
Test Method:	ANSI C63.10:2013
Receiver setup:	RBW=1MHz, VBW=3MHz, Span=0Hz, Detector=Peak
Limit:	0.4 Second

11.1 Test Setup

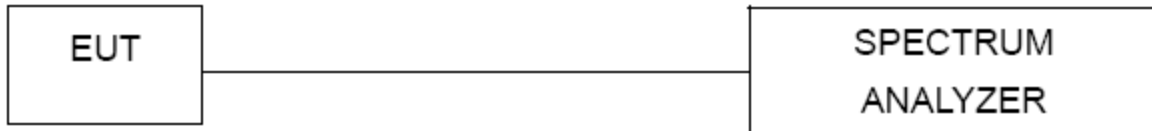

11.2 Test procedure

1. Remove the antenna from the EUT and then connect a low RF cable from the antenna port to the spectrum.
2. Set spectrum analyzer span = 0Hz;
3. Set RBW = 1MHz and VBW = 3MHz. Sweep = as necessary to capture the entire dwell time per hopping channel. Set the EUT for DH5, DH3 and DH1 packet transmitting.
4. Use the marker-delta function to determine the dwell time. If this value varies with different modes of operation (e.g.. data rate. modulation format. etc.). repeat this test for each variation. The limit is specified in one of the subparagraphs of this Section. Submit this plot(s).

11.3 DEVIATION FROM STANDARD

No deviation.

11.4 Test Result

Mode	TX Type	Frequency (MHz)	Packet Type	Duration of Single Pulse (ms)	Observation Period (s)	Num of Pulse in Observation Period	Dwell Time (ms)	Limit (ms)	Verdict
GFSK	SISO	HOPP	DH1	0.406	31.600	320	129.920	<=400	Pass
			DH3	1.644	31.600	153	251.532	<=400	Pass
			DH5	2.910	31.600	101	293.910	<=400	Pass
π/4-DQPSK	SISO	HOPP	2DH1	0.398	31.600	320	127.360	<=400	Pass
			2DH3	1.664	31.600	173	287.872	<=400	Pass
			2DH5	2.912	31.600	108	314.496	<=400	Pass
8-DPSK	SISO	HOPP	2DH1	0.390	31.600	320	124.800	<=400	Pass
			2DH3	1.662	31.600	171	284.202	<=400	Pass
			2DH5	2.914	31.600	110	320.540	<=400	Pass



Test Plots

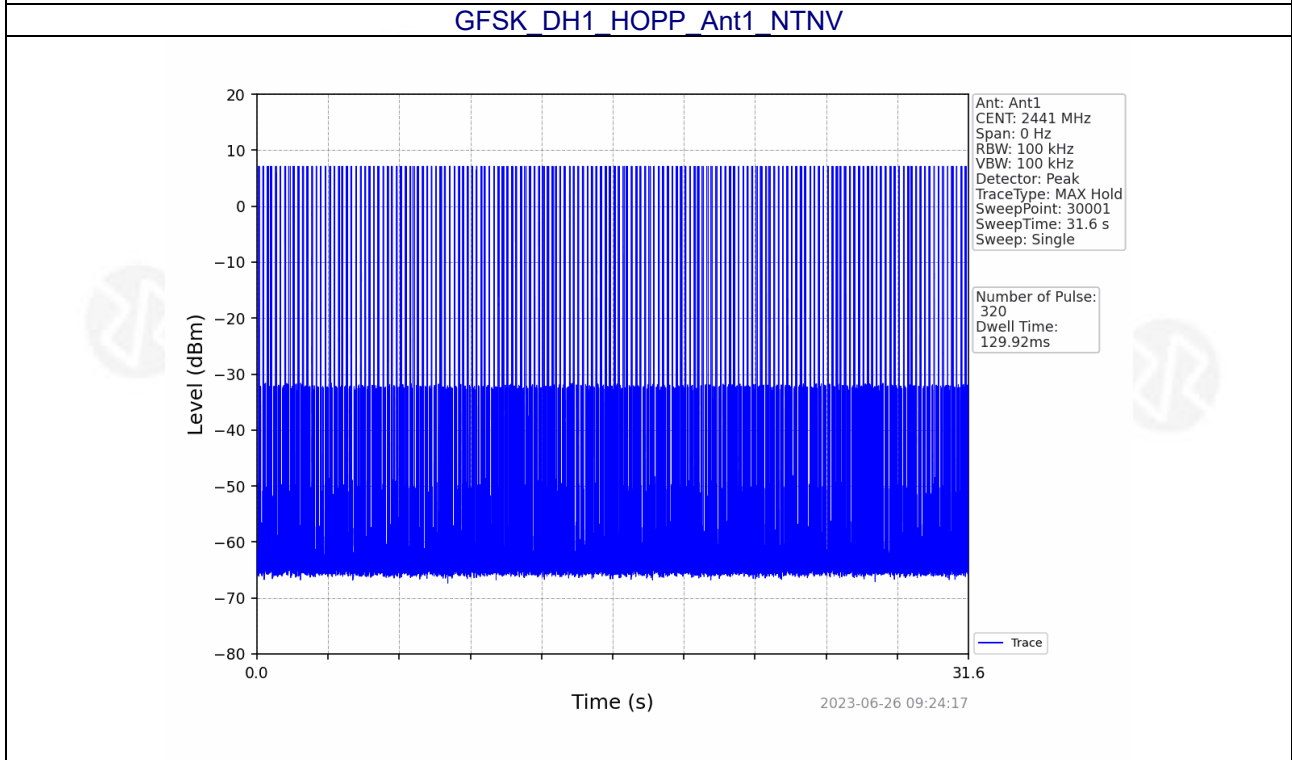
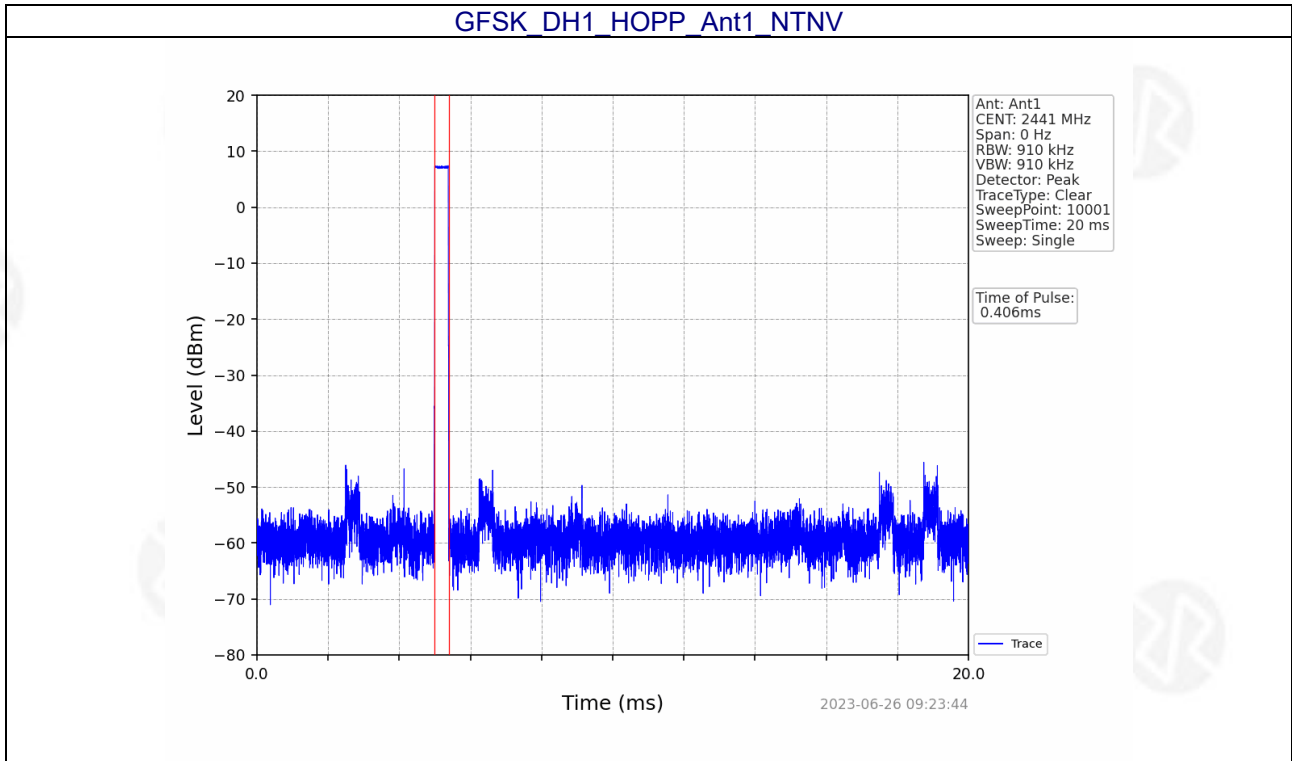



GFSK DH3_HOPP_Ant1_NTNV

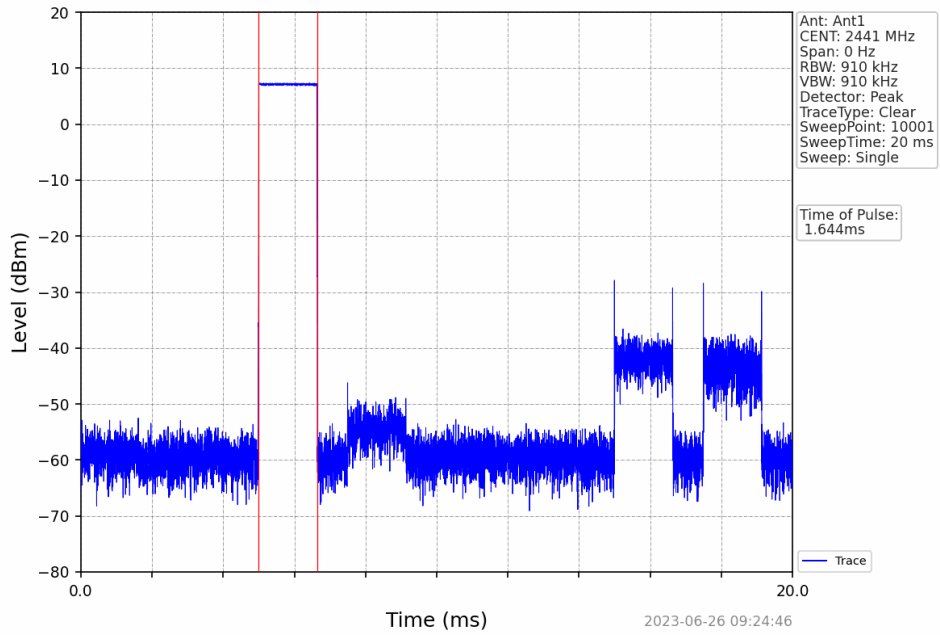

GFSK DH3_HOPP_Ant1_NTNV

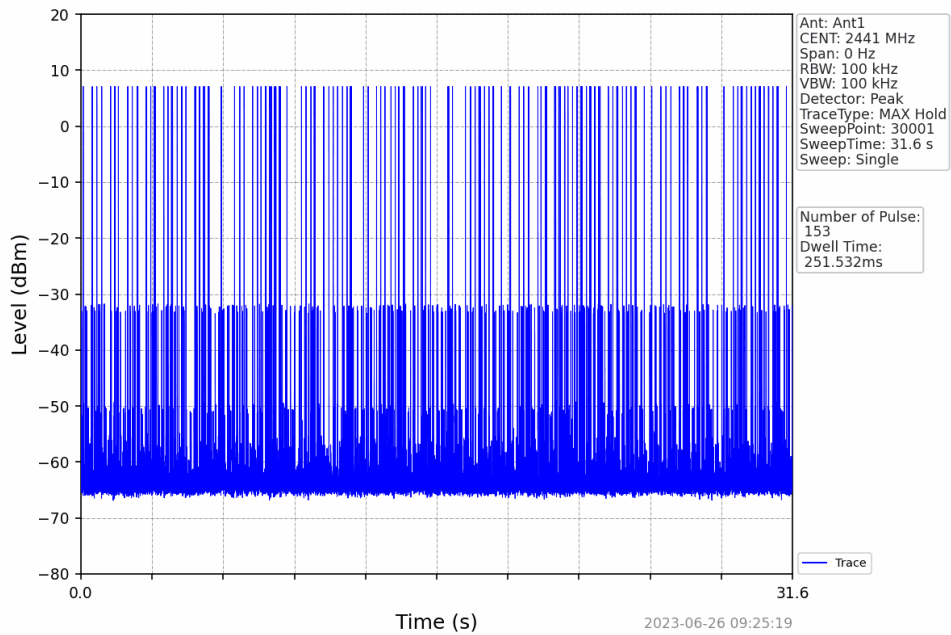



GFSK DH5_HOPP_Ant1_NTNV

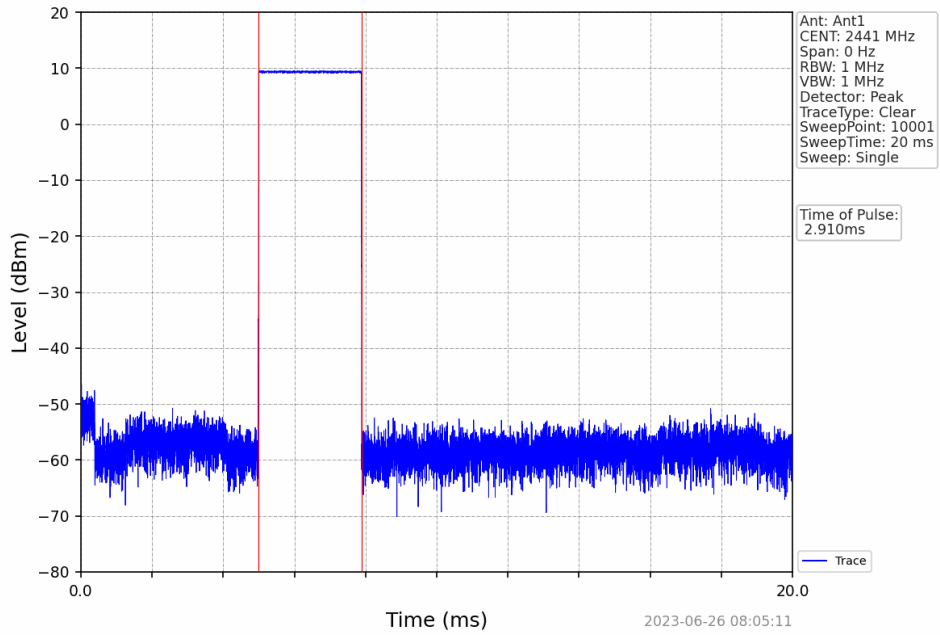

GFSK DH5_HOPP_Ant1_NTNV

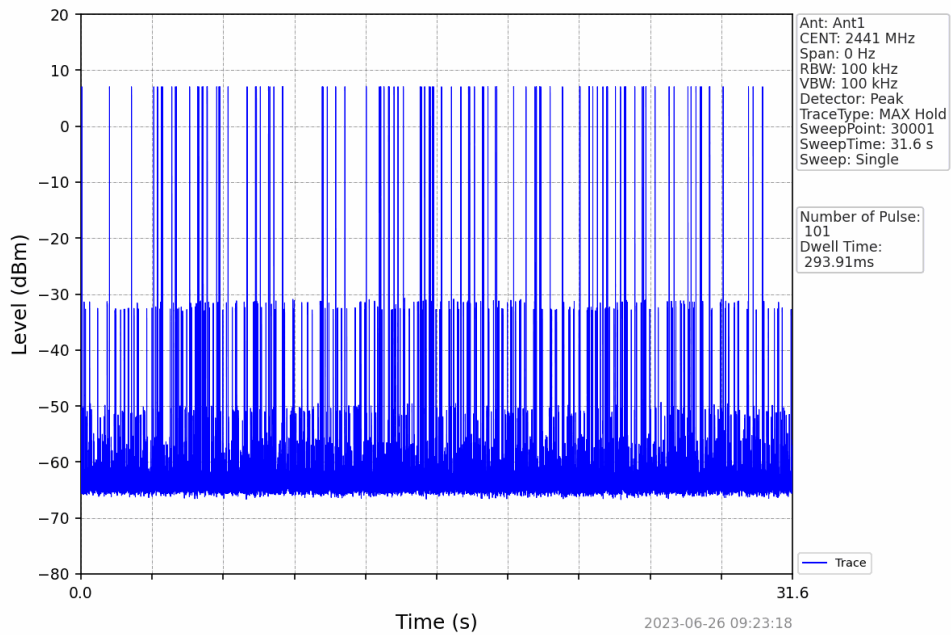

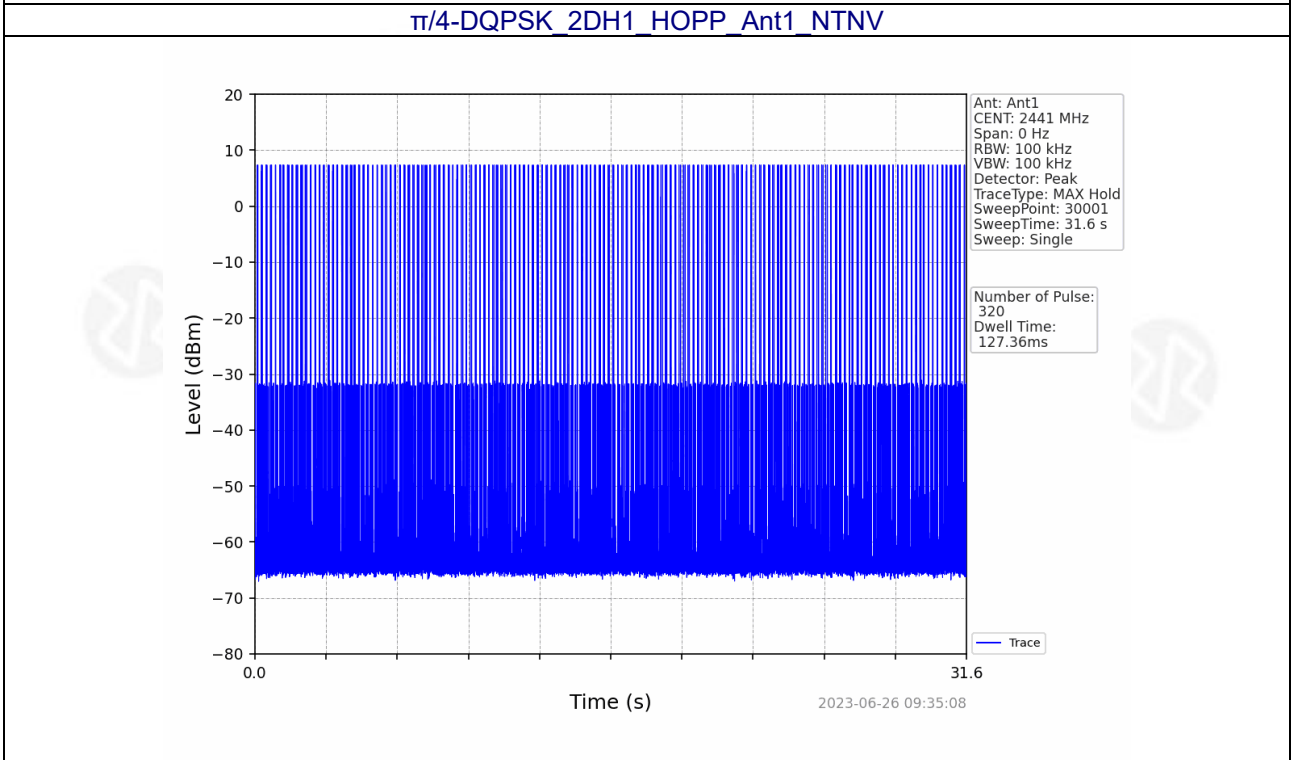
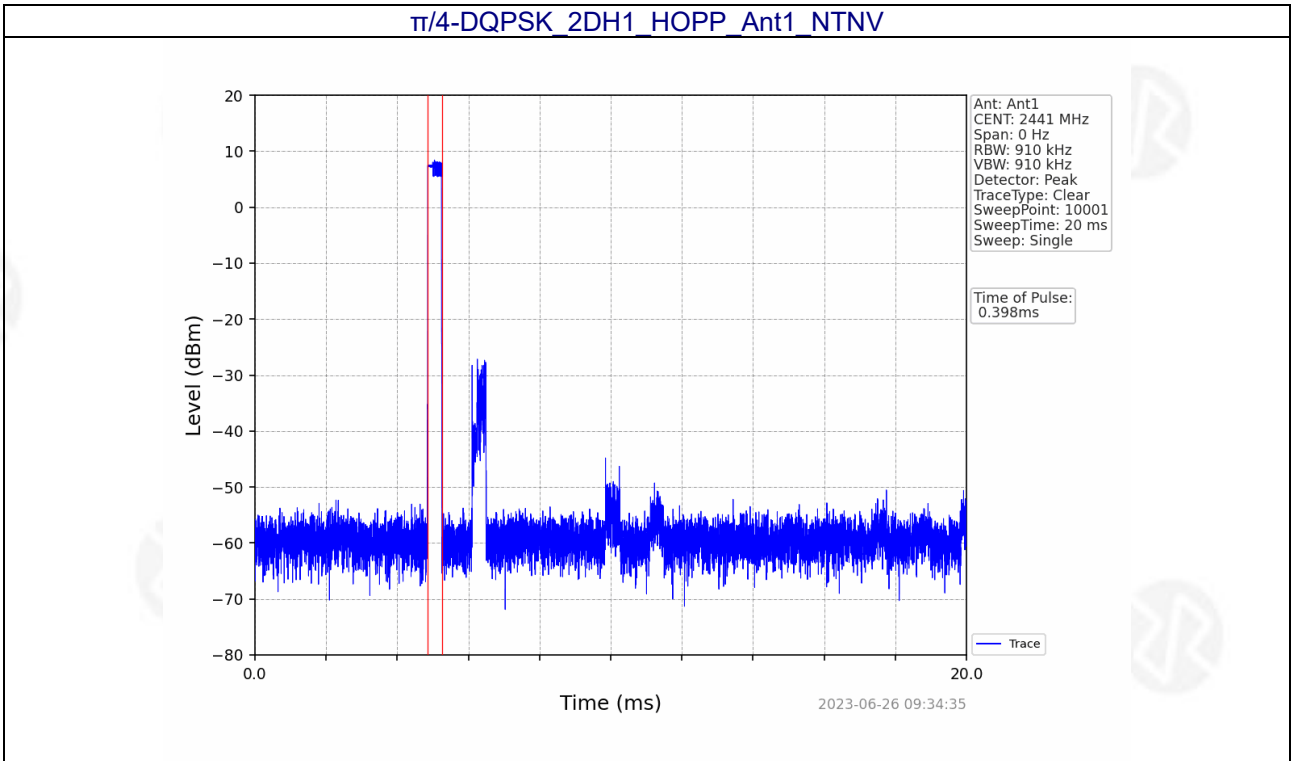

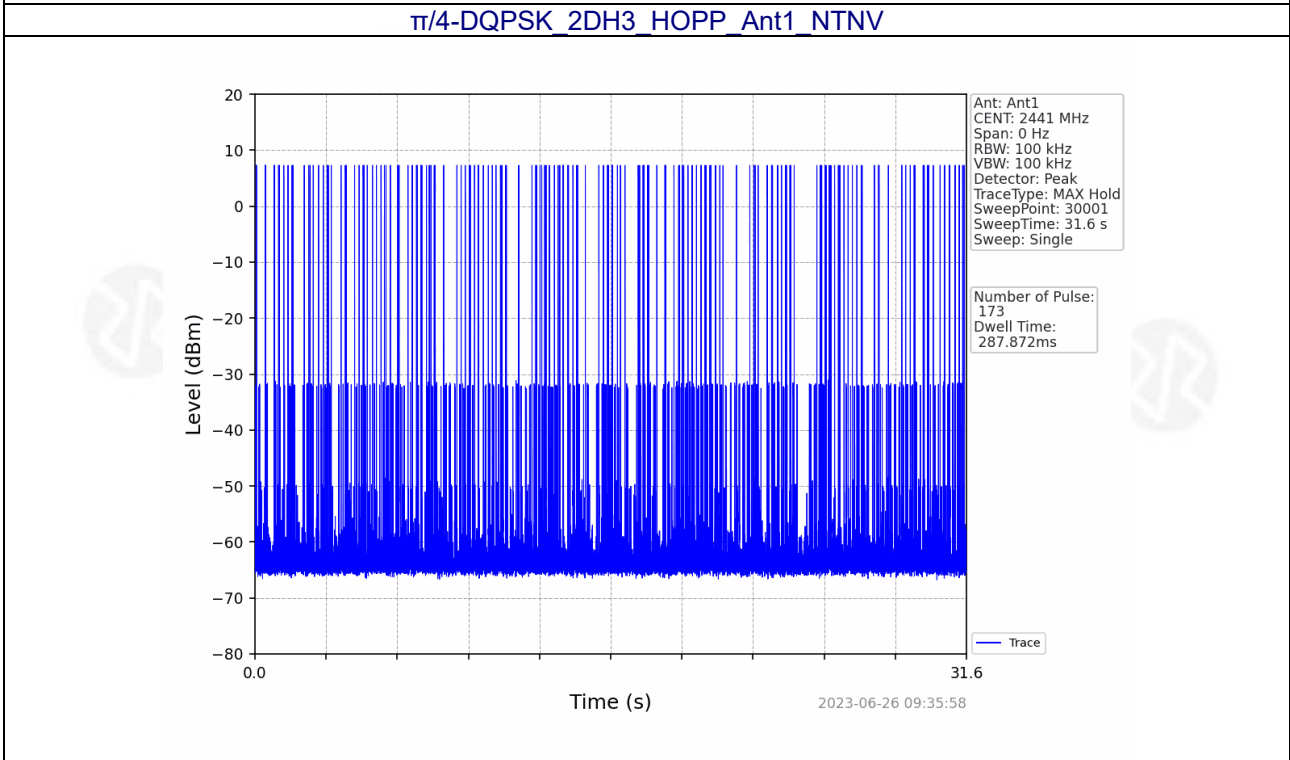
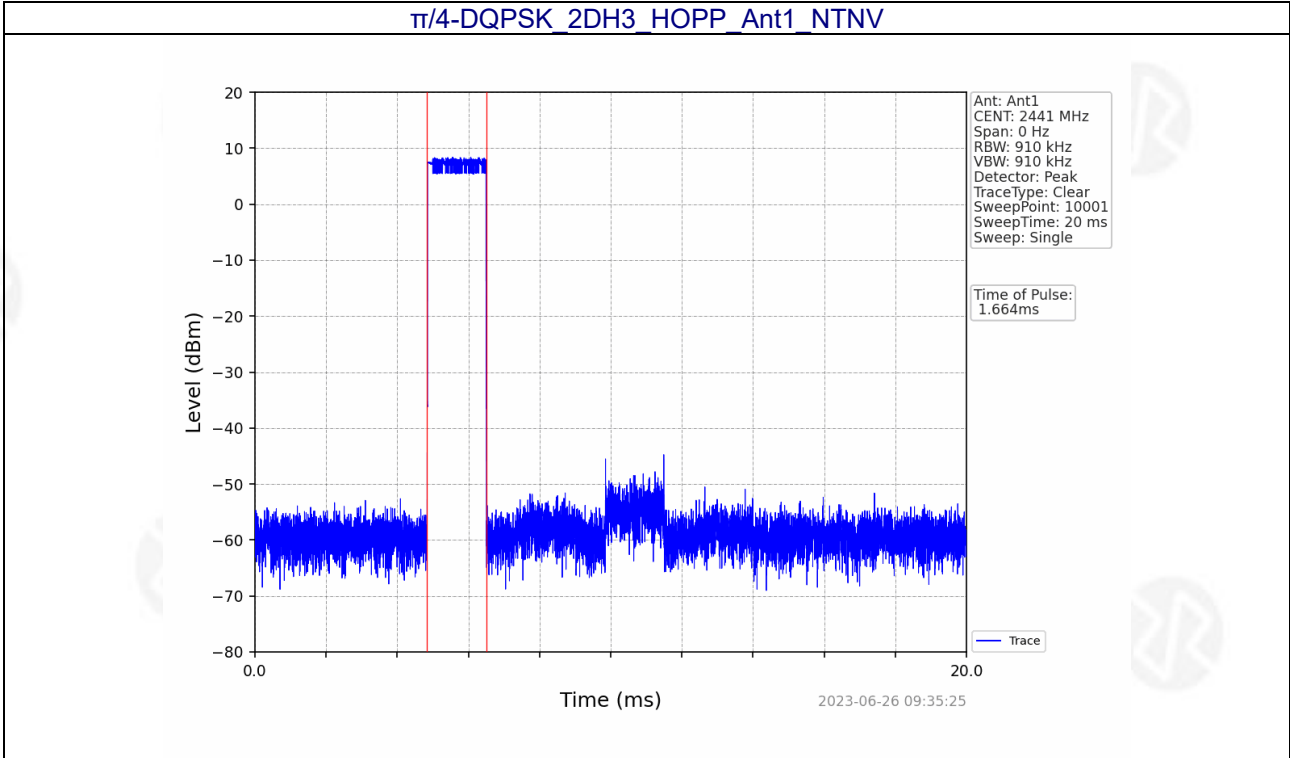

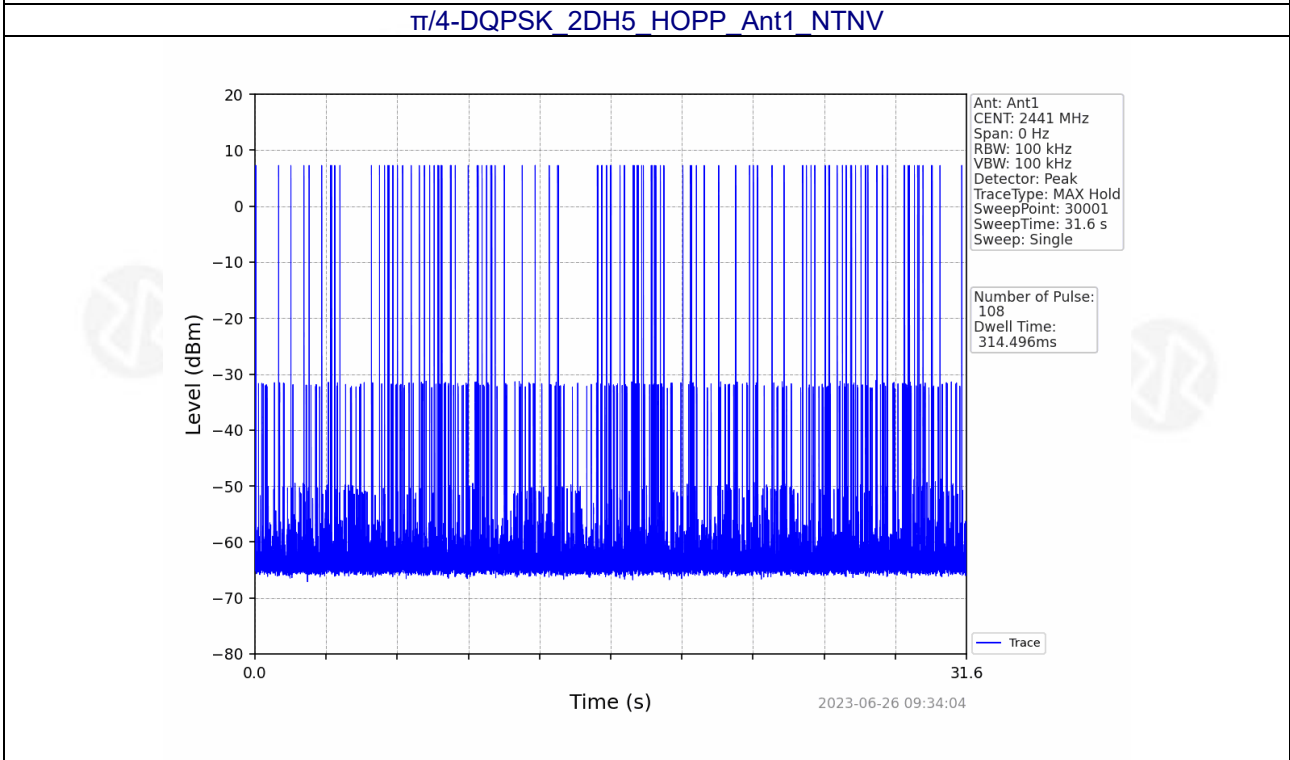
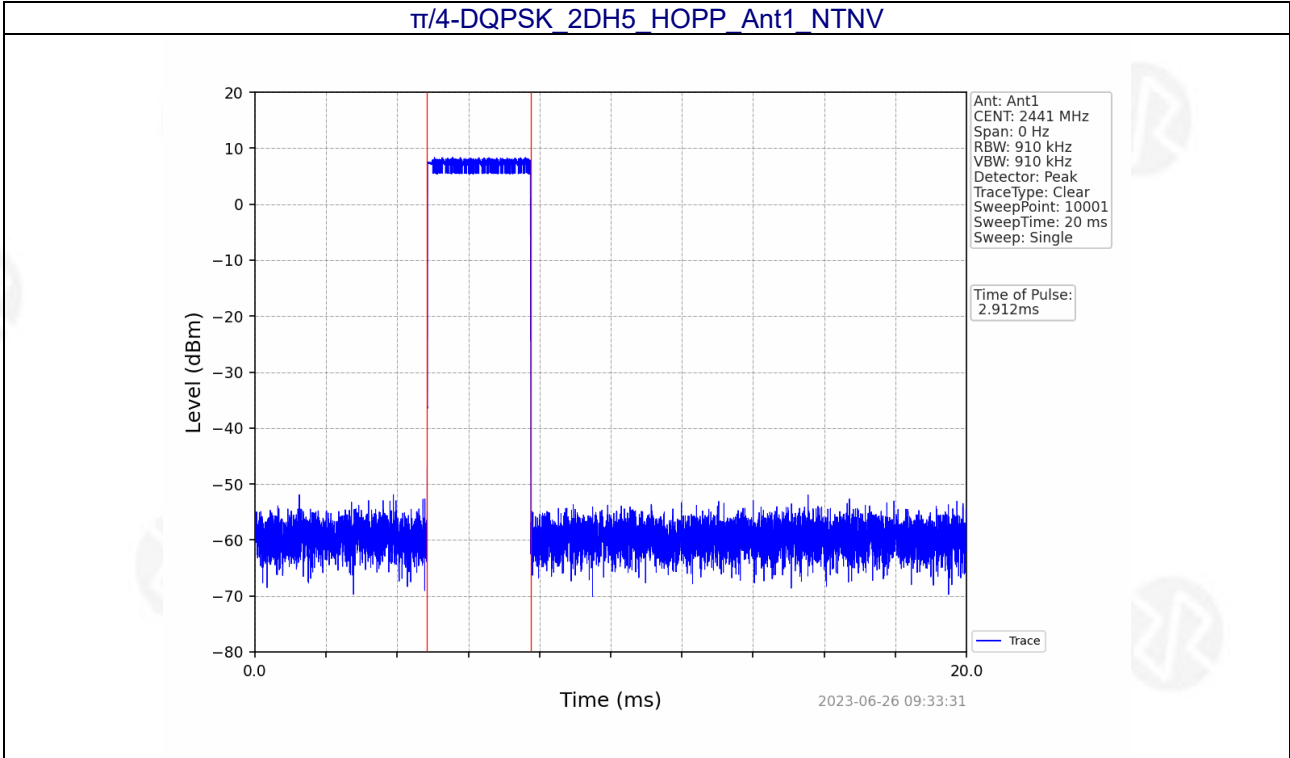



8-DPSK 3DH1_HOPP_Ant1_NTNV

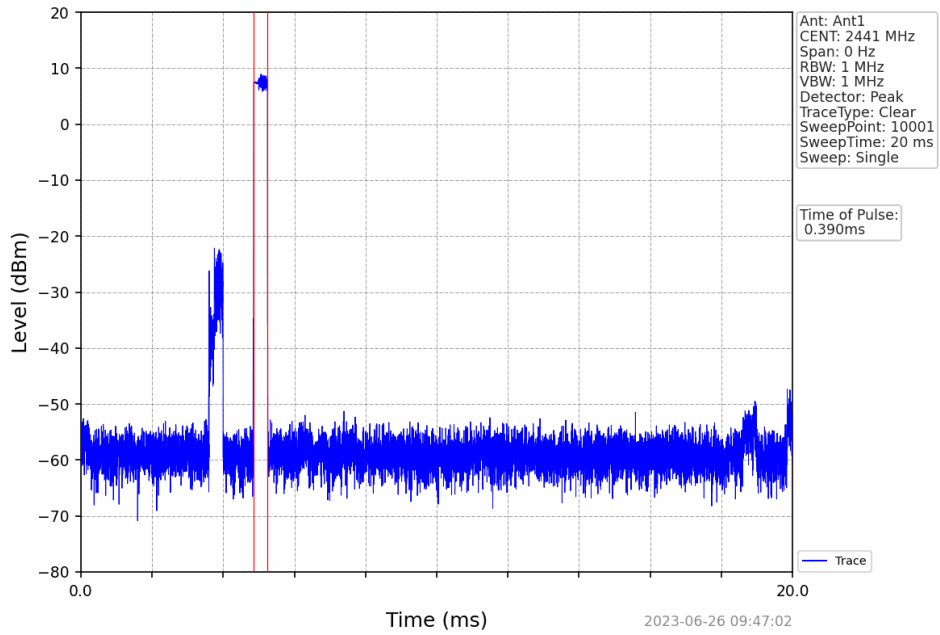

8-DPSK 3DH1_HOPP_Ant1_NTNV

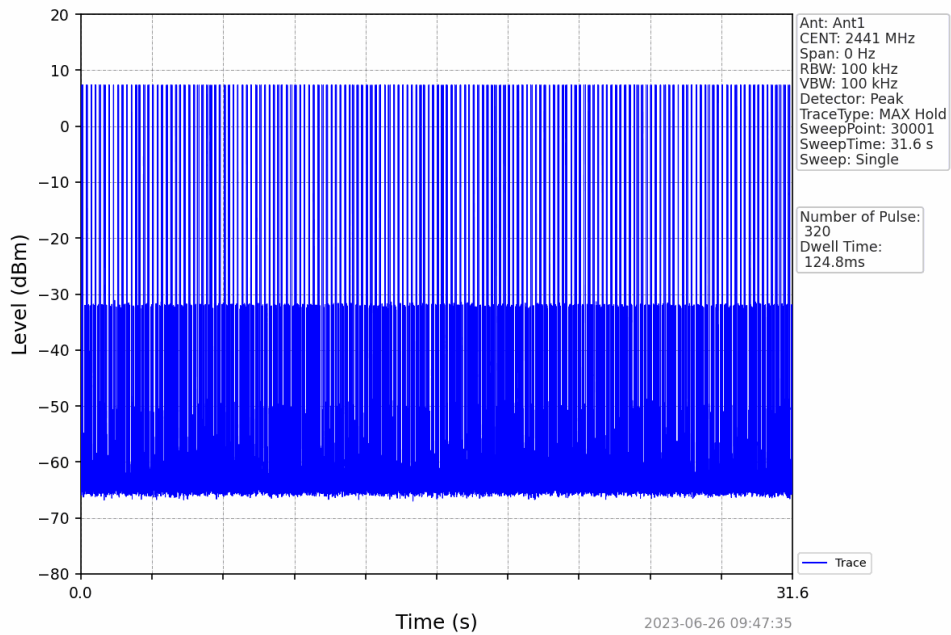



8-DPSK 3DH3_HOPP_Ant1_NTNV

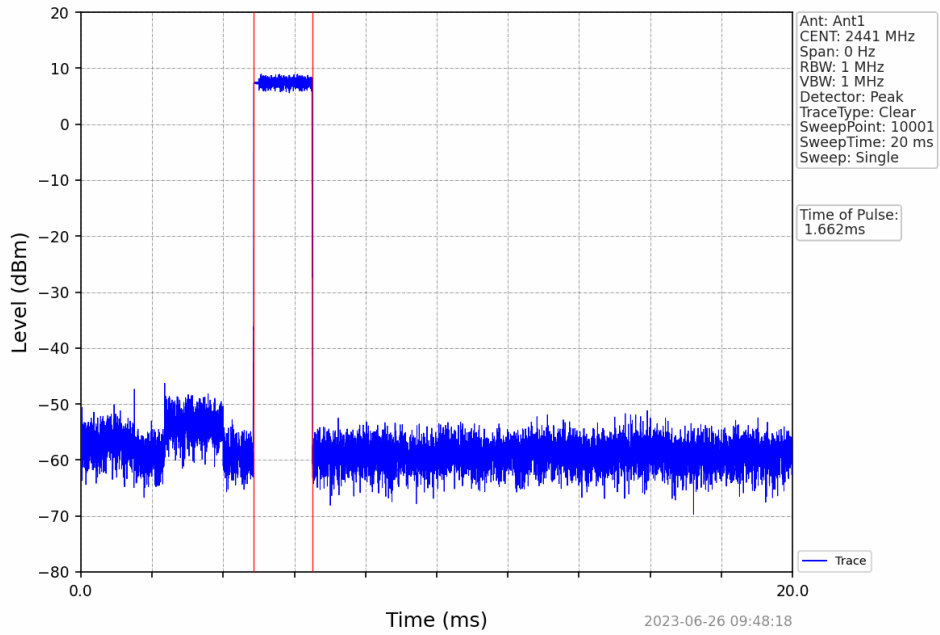

8-DPSK 3DH3_HOPP_Ant1_NTNV

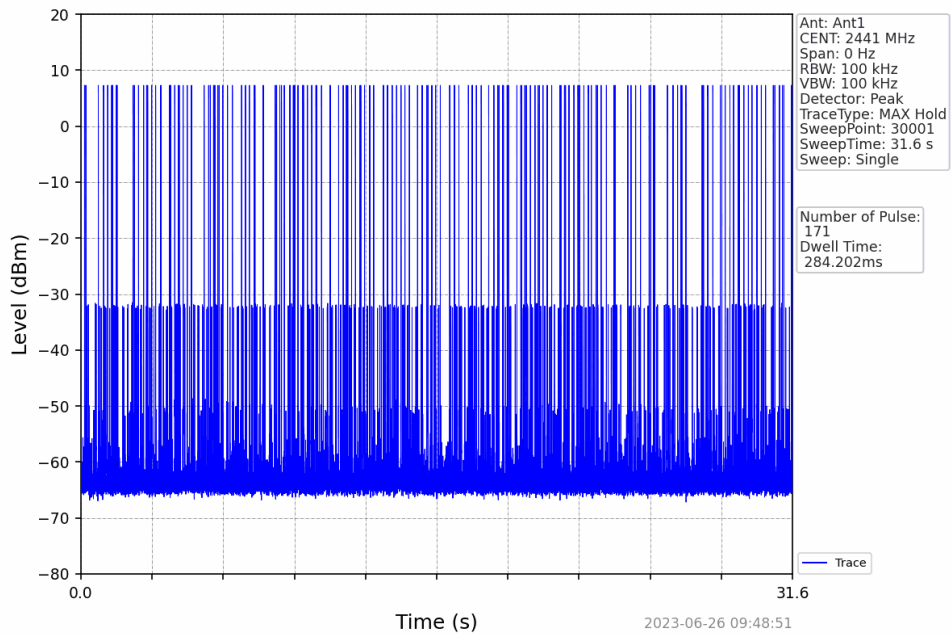

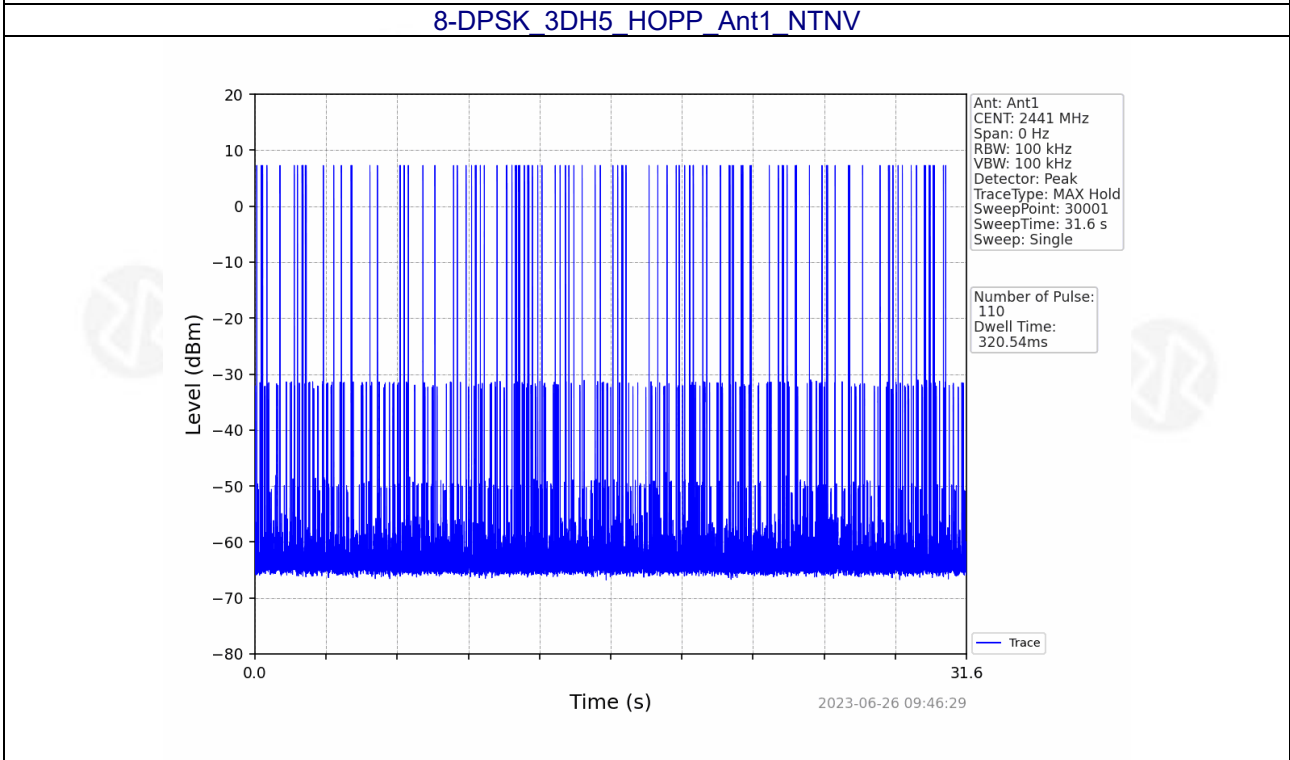
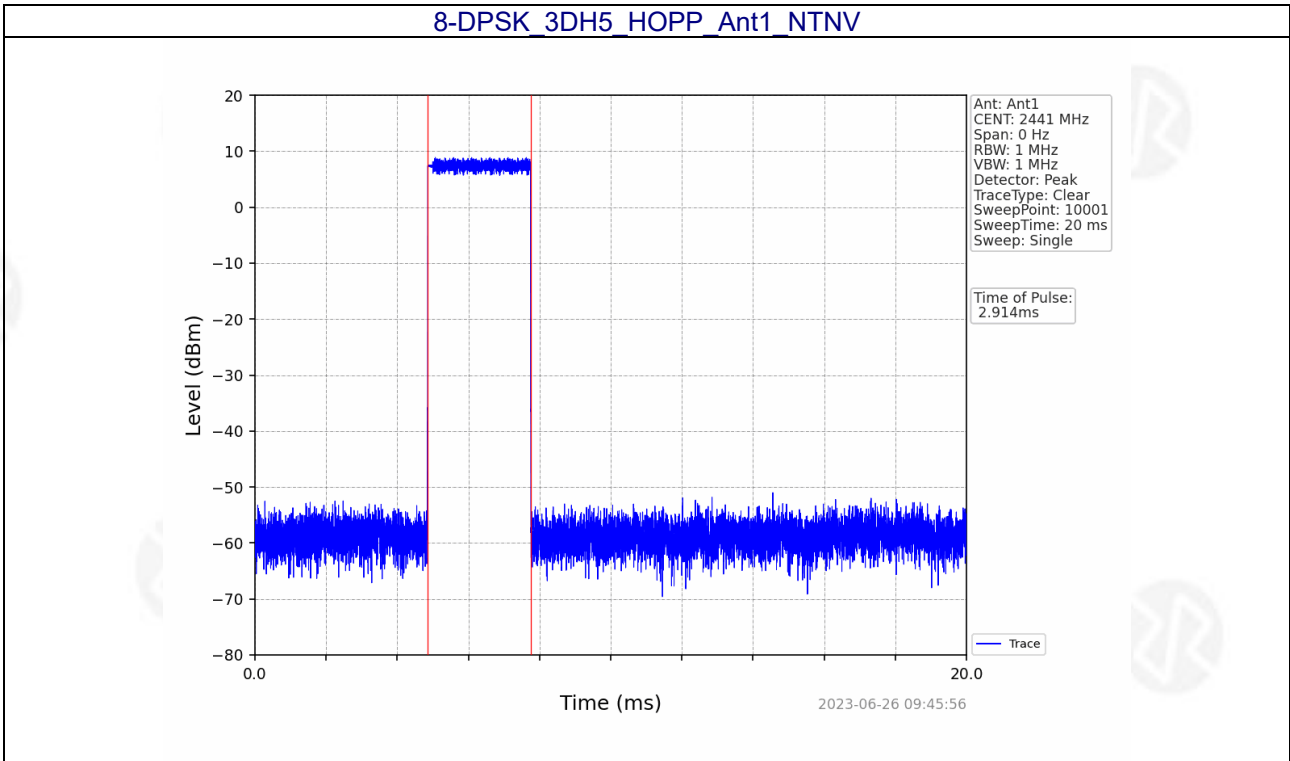



12. Antenna Requirement

Standard requirement:	FCC Part15 C Section 15.203 /247(c)
15.203 requirement: An intentional radiator shall be designed to ensure that no antenna other than that furnished by the responsible party shall be used with the device. The use of a permanently attached antenna or of an antenna that uses a unique coupling to the intentional radiator, the manufacturer may design the unit so that a broken antenna can be replaced by the user, but the use of a standard antenna jack or electrical connector is prohibited.	
15.247(c) (1)(i) requirement: (i) Systems operating in the 2400-2483.5 MHz band that is used exclusively for fixed. Point-to-point operations may employ transmitting antennas with directional gain greater than 6dBi provided the maximum conducted output power of the intentional radiator is reduced by 1 dB for every 3 dB that the directional gain of the antenna exceeds 6dBi.	
EUT Antenna:	
The antenna is PIFA antenna, the best case gain of the antennas is 2.8 dBi, reference to the appendix II for details	



13. Test Setup Photo

Reference to the appendix I for details.

14. EUT Constructional Details

Reference to the appendix II for details.

******* END OF REPORT *******