

FCC TEST REPORT

Client Name : Autel Intelligent Tech. Corp., Ltd.
Address : 7th-8th, 10th Floor, Bldg. B1, Zhiyuan, Xueyuan Rd., Xili,
Nanshan Shenzhen China
Product Name : SMARTPHONE CODE READER
Date : Jun.24, 2021

Shenzhen Anbotek Compliance Laboratory Limited



Contents

1. General Information.....	5
1.1. Client Information.....	5
1.2. Description of Device (EUT).....	5
1.3. Auxiliary Equipment Used During Test.....	6
1.4. Description of Test Modes.....	6
1.5. List of channels.....	6
1.6. Description Of Test Setup.....	7
1.7. Test Equipment List.....	8
1.8. Measurement Uncertainty.....	9
1.9. Description of Test Facility.....	9
2. Summary of Test Results.....	10
3. Conducted Emission Test.....	11
3.1. Test Standard and Limit.....	11
3.2. Test Setup.....	11
3.3. Test Procedure.....	11
3.4. Test Data.....	11
4. Radiation Spurious Emission and Band Edge.....	16
4.1. Test Standard and Limit.....	16
4.2. Test Setup.....	16
4.3. Test Procedure.....	17
4.4. Test Data.....	18
5. Maximum Peak Output Power Test.....	26
5.1. Test Standard and Limit.....	26
5.2. Test Setup.....	26
5.3. Test Procedure.....	26
5.4. Test Data.....	26
6. 6DB Occupy Bandwidth Test.....	27
6.1. Test Standard and Limit.....	27
6.2. Test Setup.....	27
6.3. Test Procedure.....	27
6.4. Test Data.....	27
7. Power Spectral Density Test.....	28
7.1. Test Standard and Limit.....	28
7.2. Test Setup.....	28
7.3. Test Procedure.....	28
7.4. Test Data.....	28
8. 100kHz Bandwidth of Frequency Band Edge Requirement.....	29
8.1. Test Standard and Limit.....	29
8.2. Test Setup.....	29

8.3. Test Procedure.....29

8.4. Test Data.....29

9. Antenna Requirement.....30

9.1. Test Standard and Requirement.....30

9.2. Antenna Connected Construction.....30

APPENDIX I -- TEST SETUP PHOTOGRAPH.....31

APPENDIX II -- EXTERNAL PHOTOGRAPH.....31

APPENDIX III -- INTERNAL PHOTOGRAPH.....31

APPENDIX IV -- Appendix Test Data.....31

TEST REPORT

Applicant : Autel Intelligent Tech. Corp., Ltd.
Manufacturer : Autel Intelligent Tech. Corp., Ltd.
Product Name : SMARTPHONE CODE READER
Model No. : AL1 Lite
Trade Mark : OTOFIX
Rating(s) : Input: DC 12V, 0.5A

Test Standard(s) : FCC Part15 Subpart C, Section 15.247

Test Method(s) : ANSI C63.10: 2013, KDB558074 D01 DTS Meas Guidance v05r02

The device described above is tested by Shenzhen Anbotek Compliance Laboratory Limited to determine the maximum emission levels emanating from the device and the severe levels of the device can endure and its performance criterion. The measurement results are contained in this test report and Shenzhen Anbotek Compliance Laboratory Limited is assumed full of responsibility for the accuracy and completeness of these measurements. Also, this report shows that the EUT (Equipment Under Test) is technically compliant with the FCC Part 15 Subpart C requirements.

This report applies to above tested sample only and shall not be reproduced in part without written approval of Shenzhen Anbotek Compliance Laboratory Limited.

Date of Receipt

May 19, 2021

Date of Test

May 19~Jun. 08, 2021

Prepared By



(Ella Liang)

Approved & Authorized Signer



(Kingkong Jin)

1. General Information

1.1. Client Information

Applicant	:	Autel Intelligent Tech. Corp., Ltd.
Address	:	7th-8th, 10th Floor, Bldg. B1, Zhiyuan, Xueyuan Rd. Xili, Nanshan, Shenzhen, China
Manufacturer	:	Autel Intelligent Tech. Corp., Ltd.
Address	:	7th-8th, 10th Floor, Bldg. B1, Zhiyuan, Xueyuan Rd. Xili, Nanshan, Shenzhen, China
Factory 1	:	Autel Intelligent Technology Corp., Ltd. Guangming Branch
Address	:	7F&6F, East Wing, Building 2, and 6F of Electronical Building, Yanxiang Industrial Zone, Gaoxin Rd, Dongzhou Community of Guangming New District, Shenzhen, China
Factory 2	:	AUTEL VIETNAM COMPANY LIMITED
Address	:	4th Floor, Factory#6, Land#CN1, An Duong Industrial Zone, Hong Phong Township, An Duong County, Hai Phong, Viet Nam

1.2. Description of Device (EUT)

Product Name	:	SMARTPHONE CODE READER
Model No.	:	AL1 Lite
Trade Mark	:	OTOFIX
Test Power Supply	:	AC 240V, 60Hz for adapter/ AC 120V, 60Hz for adapter
Test Sample No.	:	1-2-1(Normal Sample), 1-2-2(Engineering Sample)
Product Description	Operation Frequency:	2402~2480MHz
	Transfer Rate:	BDR+EDR: 1/2/3 Mbits/s BLE: 1 Mbits/s
	Number of Channel:	EDR+EDR: 79 Channels BLE: 40 Channels
	Modulation Type:	EDR+EDR: GFSK, $\pi/4$ -DQPSK, 8-DPSK BLE: GFSK
	Antenna Type:	PCB Antenna
	Antenna Gain(Peak):	0 dBi

Remark: 1) For a more detailed features description, please refer to the manufacturer's specifications or the User's Manual.

2) This report is for BLE only.

1.3. Auxiliary Equipment Used During Test

N/A	
-----	--

1.4. Description of Test Modes

To investigate the maximum EMI emission characteristics generates from EUT, the test system was pre-scanning tested base on the consideration of following EUT operation mode or test configuration mode which possible have effect on EMI emission level. Each of these EUT operation mode(s) or test configuration mode(s) mentioned above was evaluated respectively.

Pretest Mode	Description	
Mode 1	CH00	TX Only
Mode 2	CH19	
Mode 3	CH39	

Note:

- (1) The measurements are performed at the highest, middle, lowest available channels.
- (2)The data rate was set in 1Mbps for radiated emission due to the highest RF output power.

1.5. List of channels

Channel	Freq. (MHz)	Channel	Freq. (MHz)	Channel	Freq. (MHz)	Channel	Freq. (MHz)	Channel	Freq. (MHz)
00	2402	09	2420	18	2438	27	2456	36	2474
01	2404	10	2422	19	2440	28	2458	37	2476
02	2406	11	2424	20	2442	29	2460	38	2478
03	2408	12	2426	21	2444	30	2462	39	2480
04	2410	13	2428	22	2446	31	2464		
05	2412	14	2430	23	2448	32	2466		
06	2414	15	2432	24	2450	33	2468		
07	2416	16	2434	25	2452	34	2470		
08	2418	17	2436	26	2454	35	2472		

Note:

- 1. The engineering test program was provided and the EUT was programmed to be in continuously transmitting mode.
- 2. EUT built-in battery-powered, fully-charged battery use of the test battery.

1.6. Description Of Test Setup

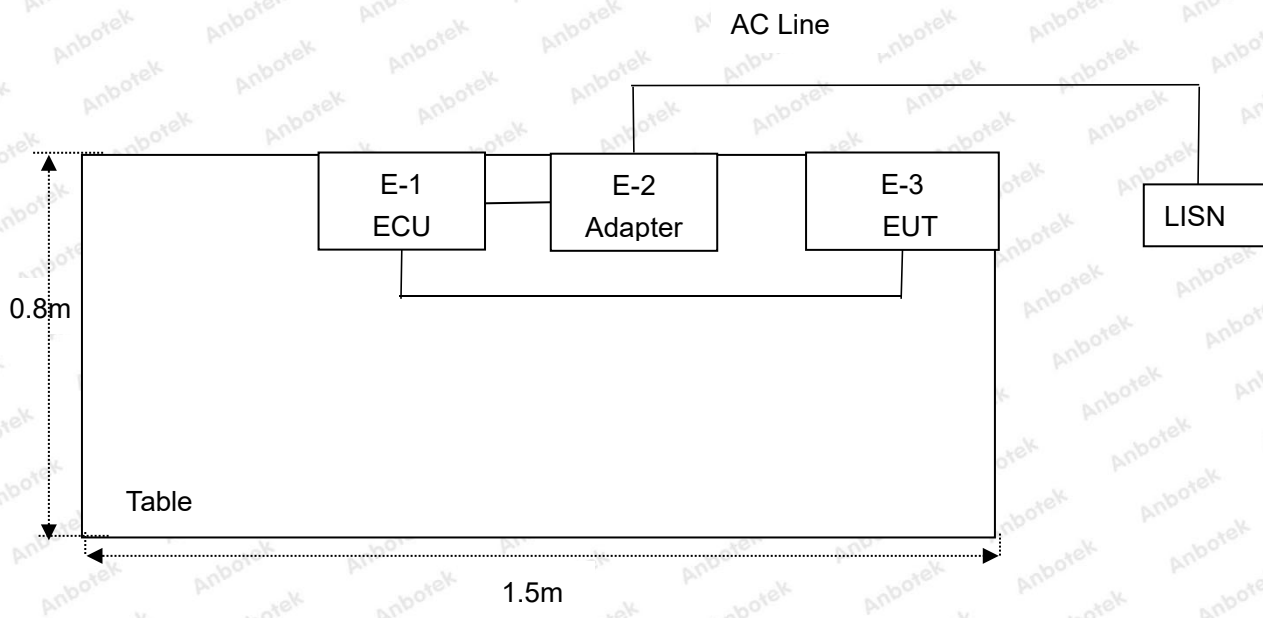

RE

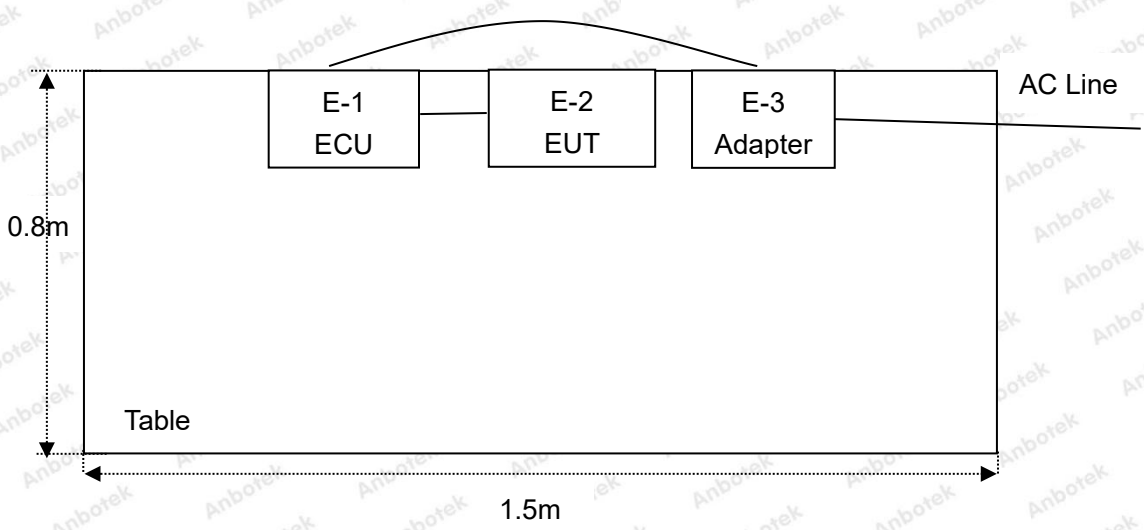

1.7. Test Equipment List

Item	Equipment	Manufacturer	Model No.	Serial No.	Last Cal.	Cal. Interval
1.	L.I.S.N. Artificial Mains Network	Rohde & Schwarz	ENV216	100055	Oct. 26, 2020	1 Year
2.	EMI Test Receiver	Rohde & Schwarz	ESCI	100627	Oct. 26, 2020	1 Year
3.	EMI Test Receiver	Rohde & Schwarz	ESR26	101481	Oct. 26, 2020	1 Year
4.	RF Switching Unit	Compliance Direction	RSU-M2	38303	Oct. 26, 2020	1 Year
5.	MAX Spectrum Analysis	Agilent	N9020A	MY51170037	Oct. 26, 2020	1 Year
6.	Preamplifier	SKET Electronic	BK1G18G30D	KD17503	Oct. 26, 2020	1 Year
7.	Double Ridged Horn Antenna	Instruments corporation	GTH-0118	351600	Nov. 02, 2020	2 Year
8.	Bilog Broadband Antenna	Schwarzbeck	VULB9163	VULB 9163-289	Nov. 02, 2020	2 Year
9.	Loop Antenna	Schwarzbeck	FMZB1519B	00053	Nov. 02, 2020	2 Year
10.	Horn Antenna	A-INFO	LB-180400-K F	J211060628	Nov. 02, 2020	2 Year
11.	Pre-amplifier	SONOMA	310N	186860	Oct. 26, 2020	1 Year
12.	EMI Test Software EZ-EMC	SHURPLE	N/A	N/A	N/A	N/A
13.	RF Test Control System	YIHENG	YH3000	2017430	Oct. 26, 2020	1 Year
14.	Power Sensor	DAER	RPR3006W	15I00041SN045	Oct. 26, 2020	1 Year
15.	Power Sensor	DAER	RPR3006W	15I00041SN046	Oct. 26, 2020	1 Year
16.	MXA Spectrum Analysis	Agilent	N9020A	MY51170037	Oct. 26, 2020	1 Year
17.	MXG RF Vector Signal Generator	Agilent	N5182A	MY48180656	Oct. 26, 2020	1 Year
18.	Signal Generator	Agilent	E4421B	MY41000743	Oct. 26, 2020	1 Year
19.	DC Power Supply	IVYTECH	IV3605	1804D360510	Oct. 26, 2020	1 Year
20.	Constant Temperature Humidity Chamber	ZHONGJIAN	ZJ-KHWS80B	N/A	Oct. 26, 2020	1 Year

1.8. Measurement Uncertainty

Radiation Uncertainty	:	Ur = 3.9 dB (Horizontal)
		Ur = 3.8 dB (Vertical)
Conduction Uncertainty	:	Uc = 3.4 dB

1.9. Description of Test Facility

The test facility is recognized, certified, or accredited by the following organizations:

FCC-Registration No.: 184111

Shenzhen Anbotek Compliance Laboratory Limited, EMC Laboratory has been registered and fully described in a report filed with the (FCC) Federal Communications Commission. The acceptance letter from the FCC is maintained in our files. Registration No. 184111, September 30, 2020.

ISED-Registration No.: 8058A

Shenzhen Anbotek Compliance Laboratory Limited, EMC Laboratory has been registered and fully described in a report filed with the (ISED) Innovation, Science and Economic Development Canada. The acceptance letter from the ISED is maintained in our files. Registration 8058A, September 30, 2020.

Test Location

Shenzhen Anbotek Compliance Laboratory Limited.

1/F, Building D, Sogood Science and Technology Park, Sanwei community, Hangcheng Street, Bao'an District, Shenzhen, Guangdong, China.518102

2. Summary of Test Results

Standard Section	Test Item	Result
15.203/15.247(c)	Antenna Requirement	PASS
15.207	Conducted Emission	PASS
15.205/15.209	Spurious Emission	PASS
15.247(b)(3)	Conducted Peak Output Power	PASS
15.247(a)(2)	6dB Occupied Bandwidth	PASS
15.247(e)	Power Spectral Density	PASS
15.247(d)	Band Edge	PASS
Remark: "N/A" is an abbreviation for Not Applicable.		

3. Conducted Emission Test

3.1. Test Standard and Limit

Test Standard	FCC Part15 Section 15.207		
Test Limit	Frequency	Maximum RF Line Voltage (dBuV)	
		Quasi-peak Level	Average Level
	150kHz~500kHz	66 ~ 56 *	56 ~ 46 *
	500kHz~5MHz	56	46
5MHz~30MHz	60	50	

Remark: (1) *Decreasing linearly with logarithm of the frequency.
(2) The lower limit shall apply at the transition frequency.

3.2. Test Setup

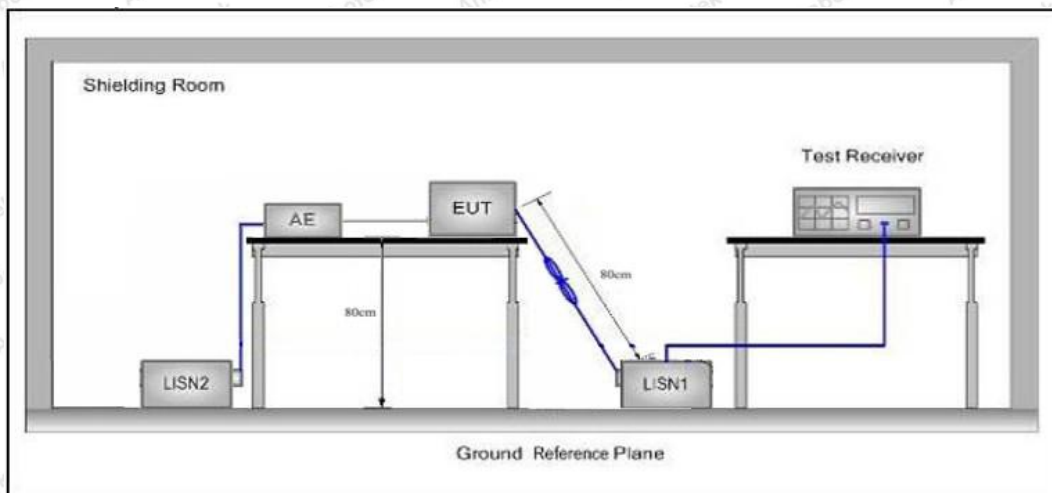

3.3. Test Procedure

The EUT system is connected to the power mains through a line impedance stabilization network (L.I.S.N.). This provides a 50ohm coupling impedance for the EUT system. Please refer the block diagram of the test setup and photographs. Both sides of AC line are checked to find out the maximum conducted emission. In order to find the maximum emission levels, the relative positions of equipment and all of the interface cables shall be changed according to FCC ANSI C63.10-2013 on Conducted Emission Measurement.

The bandwidth of test receiver (ESCI) set at 9kHz.

The frequency range from 150kHz to 30MHz is checked.

3.4. Test Data

During the test, pre-scan all modes, and found the “middle CH” which is the worst case, only the worst case is recorded in the report.

Conducted Emission Test Data

Test Site: 1# Shielded Room
 Operating Condition: Mode 2
 Test Specification: AC 120V, 60Hz for adapter
 Comment: Live Line
 Tem.: 23.6°C Hum.: 48%

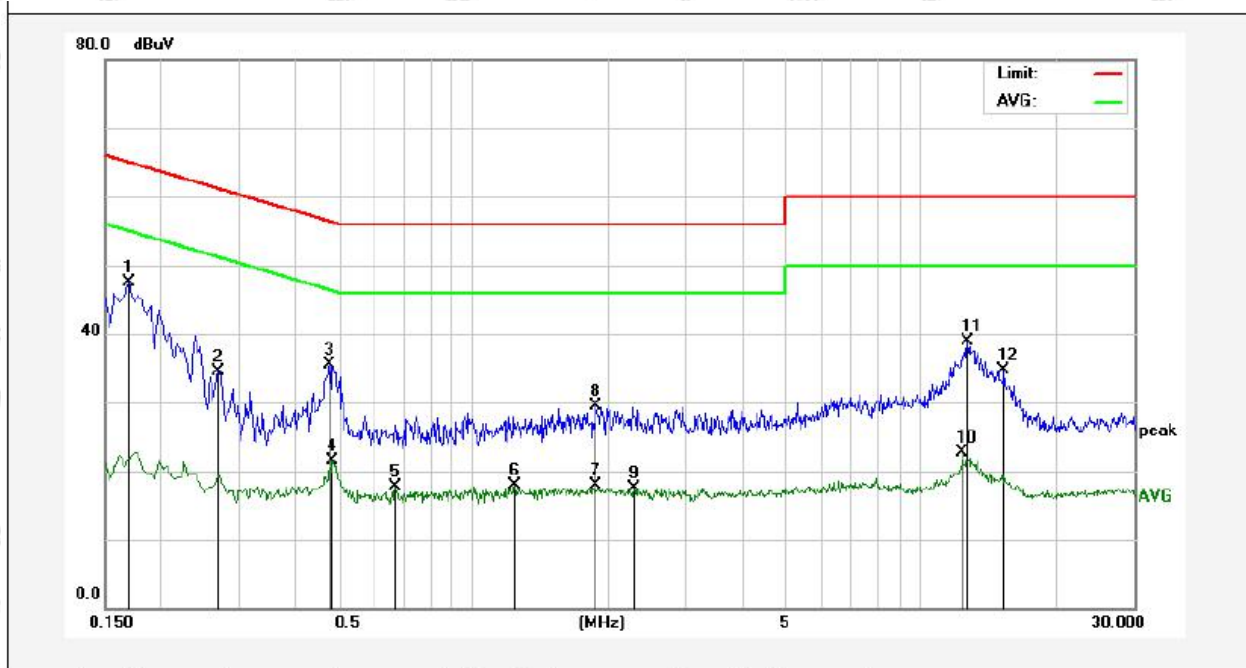

No.	Freq. (MHz)	Reading (dBuV)	Factor (dB)	Result (dBuV)	Limit (dBuV)	Over Limit (dB)	Detector	Remark
1	0.1700	27.55	19.90	47.45	64.96	-17.51	QP	
2	0.2700	14.70	19.89	34.59	61.12	-26.53	QP	
3	0.4780	15.60	19.97	35.57	56.37	-20.80	QP	
4	0.4860	1.53	19.97	21.50	46.24	-24.74	AVG	
5	0.6700	-2.32	20.03	17.71	46.00	-28.29	AVG	
6	1.2380	-2.27	20.12	17.85	46.00	-28.15	AVG	
7	1.8700	-2.33	20.14	17.81	46.00	-28.19	AVG	
8	1.8860	9.32	20.14	29.46	56.00	-26.54	QP	
9	2.2860	-2.59	20.15	17.56	46.00	-28.44	AVG	
10	12.3900	2.39	20.30	22.69	50.00	-27.31	AVG	
11	12.7540	18.64	20.30	38.94	60.00	-21.06	QP	
12	15.3300	14.34	20.27	34.61	60.00	-25.39	QP	

Conducted Emission Test Data

Test Site: 1# Shielded Room
 Operating Condition: Mode 2
 Test Specification: AC 120V, 60Hz for adapter
 Comment: Neutral Line
 Tem.: 23.6°C Hum.: 48%

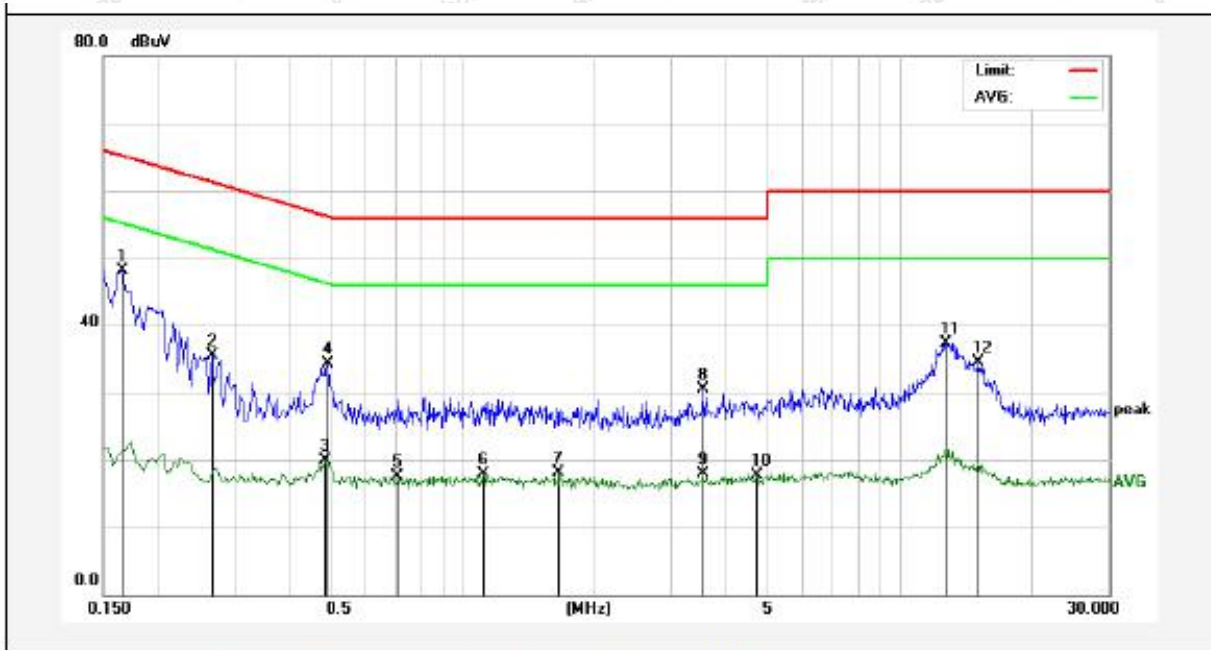

No.	Freq. (MHz)	Reading (dBuV)	Factor (dB)	Result (dBuV)	Limit (dBuV)	Over Limit (dB)	Detector	Remark
1	0.1660	28.20	19.90	48.10	65.15	-17.05	QP	
2	0.2660	15.62	19.89	35.51	61.24	-25.73	QP	
3	0.4860	-0.06	19.97	19.91	46.24	-26.33	AVG	
4	0.4900	14.23	19.98	34.21	56.17	-21.96	QP	
5	0.7100	-2.47	20.04	17.57	46.00	-28.43	AVG	
6	1.1140	-2.26	20.12	17.86	46.00	-28.14	AVG	
7	1.6540	-2.06	20.13	18.07	46.00	-27.93	AVG	
8	3.5300	10.39	20.17	30.56	56.00	-25.44	QP	
9	3.5300	-2.27	20.17	17.90	46.00	-28.10	AVG	
10	4.7060	-2.40	20.20	17.80	46.00	-28.20	AVG	
11	12.7340	17.07	20.30	37.37	60.00	-22.63	QP	
12	15.0780	14.21	20.26	34.47	60.00	-25.53	QP	

Conducted Emission Test Data

Test Site: 1# Shielded Room
 Operating Condition: Mode 2
 Test Specification: AC 240V, 60Hz for adapter
 Comment: Live Line
 Tem.: 23.6°C Hum.: 48%

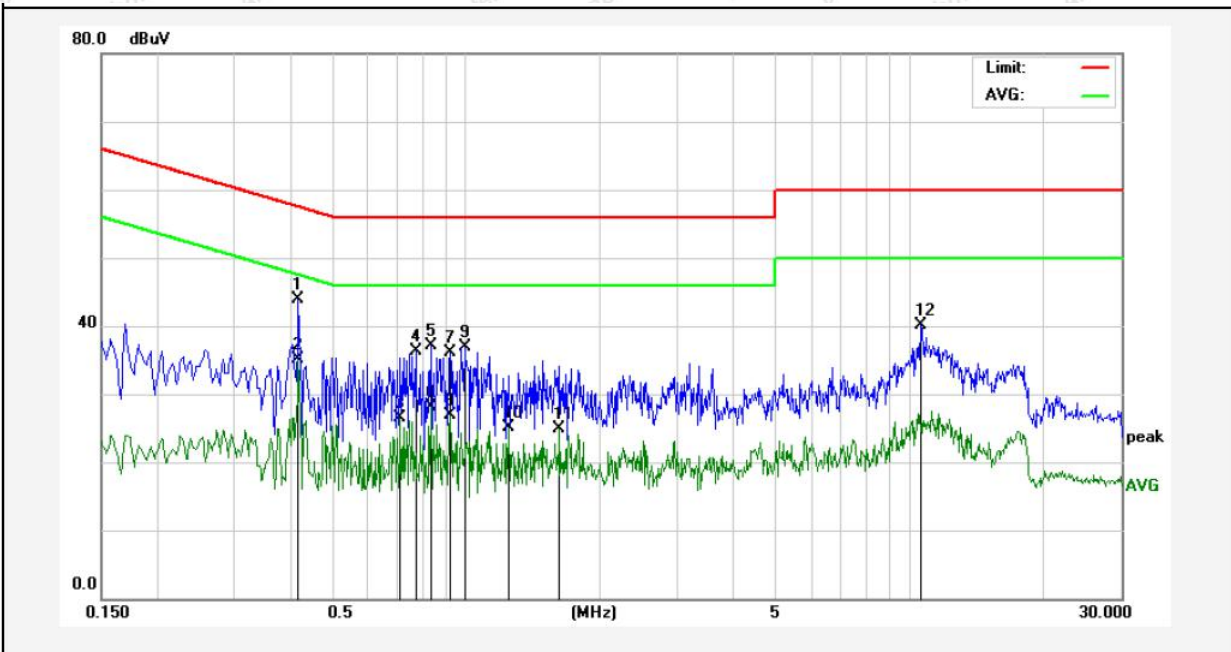

No.	Freq. (MHz)	Reading (dBuV)	Factor (dB)	Result (dBuV)	Limit (dBuV)	Over Limit (dB)	Detector	Remark
1	0.4180	23.88	19.94	43.82	57.49	-13.67	QP	
2	0.4180	15.13	19.94	35.07	47.49	-12.42	AVG	
3	0.7100	6.39	20.04	26.43	46.00	-19.57	AVG	
4	0.7700	16.16	20.06	36.22	56.00	-19.78	QP	
5	0.8340	16.97	20.08	37.05	56.00	-18.95	QP	
6	0.8340	8.06	20.08	28.14	46.00	-17.86	AVG	
7	0.9220	16.02	20.10	36.12	56.00	-19.88	QP	
8	0.9220	6.72	20.10	26.82	46.00	-19.18	AVG	
9	0.9900	16.88	20.12	37.00	56.00	-19.00	QP	
10	1.2460	4.89	20.12	25.01	46.00	-20.99	AVG	
11	1.6220	4.74	20.13	24.87	46.00	-21.13	AVG	
12	10.6100	19.84	20.33	40.17	60.00	-19.83	QP	

Conducted Emission Test Data

Test Site: 1# Shielded Room
 Operating Condition: Mode 2
 Test Specification: AC 240V, 60Hz for adapter
 Comment: Neutral Line
 Tem.: 23.6°C Hum.: 48%

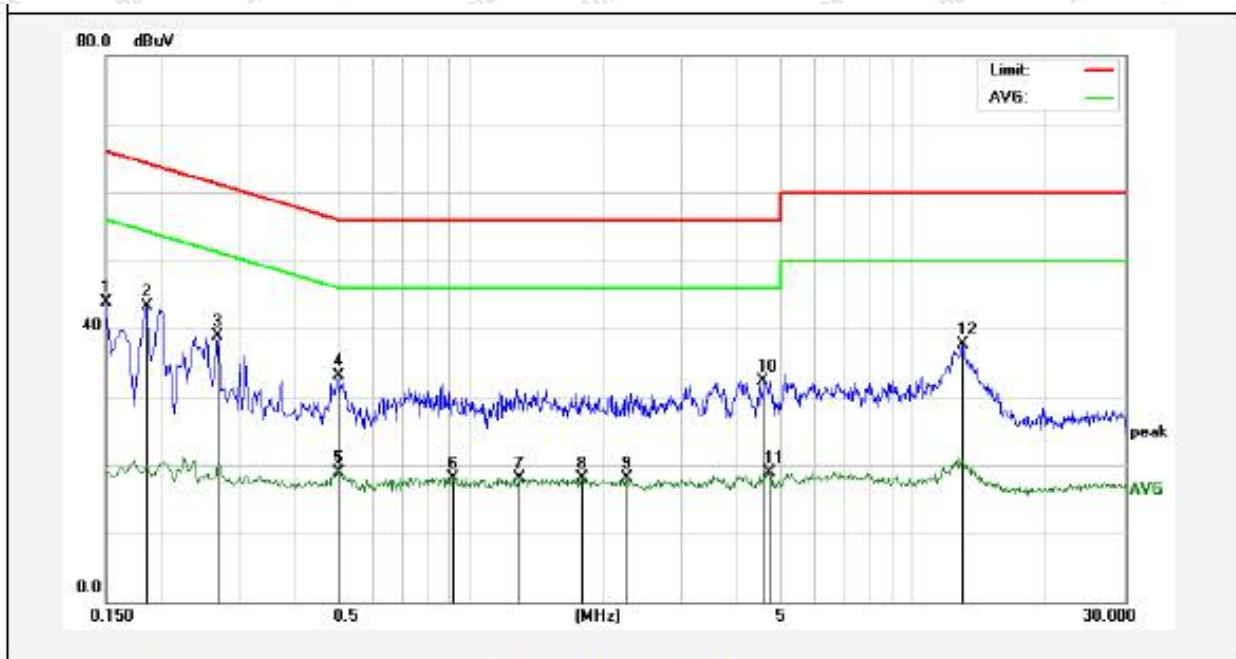

No.	Freq. (MHz)	Reading (dBuV)	Factor (dB)	Result (dBuV)	Limit (dBuV)	Over Limit (dB)	Detector	Remark
1	0.1500	24.10	19.90	44.00	65.99	-21.99	QP	
2	0.1860	23.45	19.90	43.35	64.21	-20.86	QP	
3	0.2700	19.01	19.89	38.90	61.12	-22.22	QP	
4	0.5020	13.09	19.98	33.07	56.00	-22.93	QP	
5	0.5020	-1.16	19.98	18.82	46.00	-27.18	AVG	
6	0.9100	-1.90	20.10	18.20	46.00	-27.80	AVG	
7	1.2940	-2.02	20.13	18.11	46.00	-27.89	AVG	
8	1.7900	-2.12	20.14	18.02	46.00	-27.98	AVG	
9	2.2540	-2.13	20.15	18.02	46.00	-27.98	AVG	
10	4.5860	12.07	20.20	32.27	56.00	-23.73	QP	
11	4.7060	-1.31	20.20	18.89	46.00	-27.11	AVG	
12	12.8620	17.48	20.29	37.77	60.00	-22.23	QP	

4. Radiation Spurious Emission and Band Edge

4.1. Test Standard and Limit

Test Standard	FCC Part15 C Section 15.209 and 15.205				
Test Limit	Frequency (MHz)	Field strength (microvolt/meter)	Limit (dBuV/m)	Remark	Measurement distance (m)
	0.009MHz~0.490MHz	2400/F(kHz)	-	-	300
	0.490MHz-1.705MHz	24000/F(kHz)	-	-	30
	1.705MHz-30MHz	30	-	-	30
	30MHz~88MHz	100	40.0	Quasi-peak	3
	88MHz~216MHz	150	43.5	Quasi-peak	3
	216MHz~960MHz	200	46.0	Quasi-peak	3
	960MHz~1000MHz	500	54.0	Quasi-peak	3
	Above 1000MHz	500	54.0	Average	3
-		74.0	Peak	3	

Remark:

- (1) The lower limit shall apply at the transition frequency.
- (2) 15.35(b), Unless otherwise specified, the limit on peak radio frequency emissions is 20dB above the maximum permitted average emission limit applicable to the equipment under test. This peak limit applies to the total peak emission level radiated by the device.

4.2. Test Setup

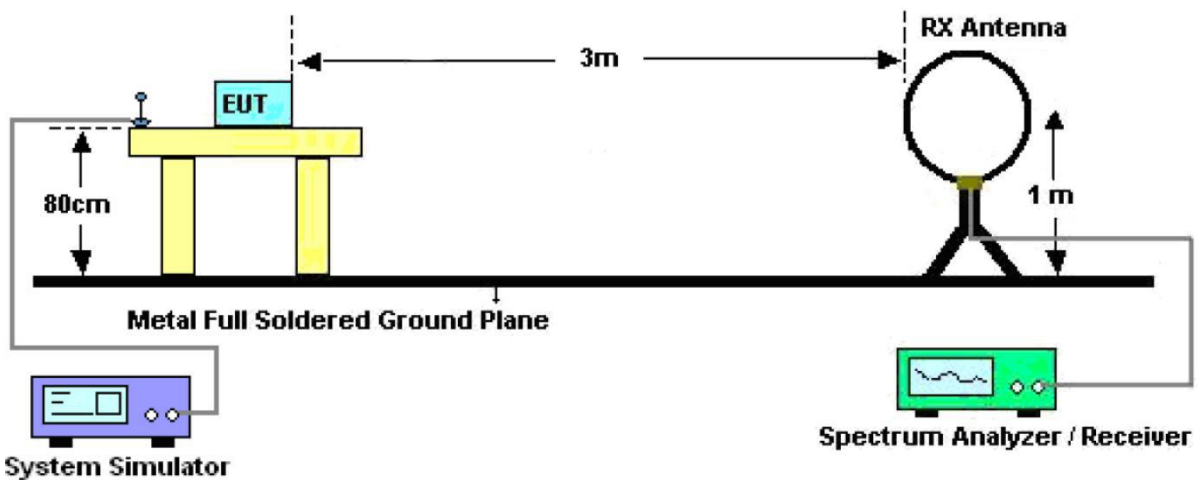

Figure 1. Below 30MHz

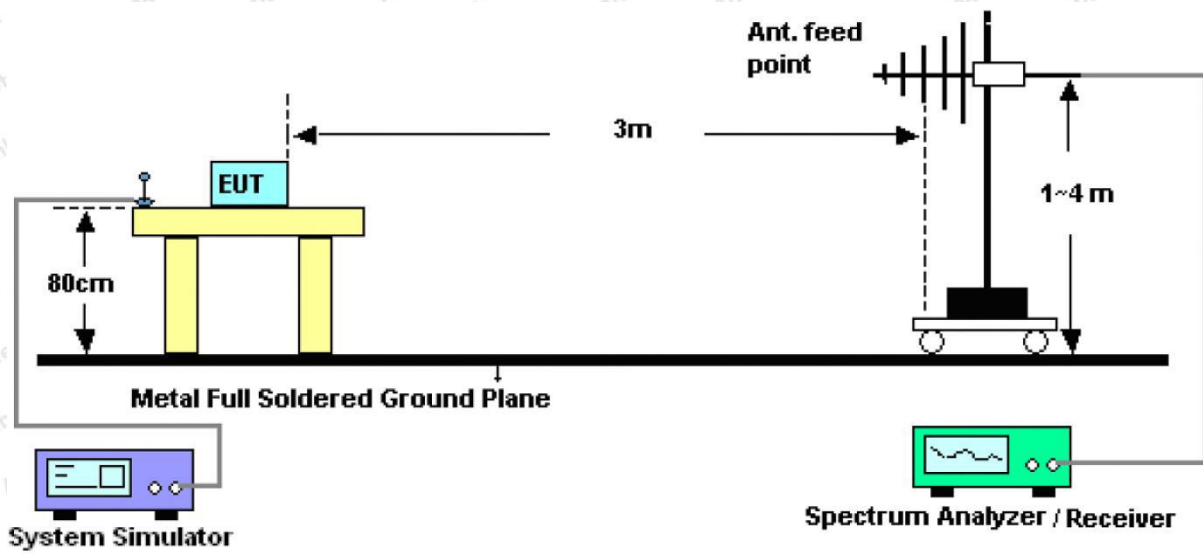

Figure 2. 30MHz to 1GHz

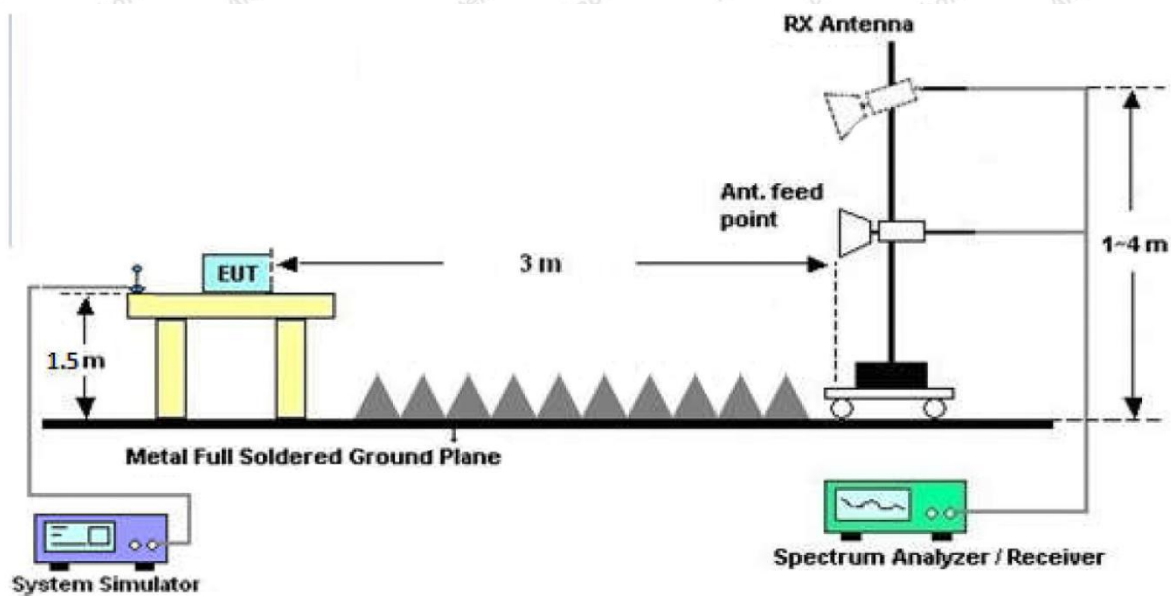

Figure 3. Above 1 GHz

4.3. Test Procedure

For below 1GHz: The EUT is placed on a turntable, which is 0.8m above the ground plane.

For above 1GHz: The EUT is placed on a turntable, which is 1.5m above the ground plane.

The turn table can rotate 360 degrees to determine the position of the maximum emission level. The EUT is set 3 meters away from the receiving antenna which is mounted on a antenna tower. The antenna can be moved up and down from 1 to 4 meters to find out the maximum emission level. Rotated the EUT through three orthogonal axes to determine the maximum emissions, both horizontal and vertical polarization of the antenna are set on test. The EUT is tested in 9*6*6 Chamber. The device is evaluated in xyz orientation.

For the radiated emission test above 1GHz:

Place the measurement antenna away from each area of the EUT determined to be a source of emissions at the specified measurement distance, while keeping the measurement antenna aimed at the source of emissions at each frequency of significant emissions, with polarization oriented for maximum response. The measurement antenna may have to be higher or lower than the EUT, depending on the radiation pattern of the emission and staying aimed at the emission source for receiving the maximum signal. The final measurement antenna elevation shall be that which maximizes the emissions. The measurement antenna elevation for maximum emissions shall be restricted to a range of heights of from 1 m to 4 m above the ground or reference ground plane.

For 9kHz to 150kHz, Set the spectrum analyzer as:

RBW = 200Hz, VBW = 1kHz, Detector= Quasi-Peak, Trace mode= Max hold, Sweep- auto couple.

For 150kHz to 30MHz, Set the spectrum analyzer as:

RBW = 9kHz, VBW = 30kHz, Detector= Quasi-Peak, Trace mode= Max hold, Sweep- auto couple.

For 30MHz to 1000MHz, Set the spectrum analyzer as:

RBW = 100kHz, VBW = 300kHz, Detector= Quasi-Peak, Trace mode= Max hold, Sweep- auto couple.

For above 1GHz, Set the spectrum analyzer as:

RBW = 1MHz, VBW = 1MHz, Detector= Peak, Trace mode= Max hold, Sweep- auto couple.

For average measurement:

-VBW=10Hz, When duty cycle is no less than 98 percent

-VBW $\geq 1/T$, when duty cycle is less than 98 percent where T is the minimum transmission duration over which the transmitter is on and is transmitting at its maximum power control level for the tested mode of operation, so refer to this clause 5.4 duty cycle.

4.4. Test Data

PASS

During the test, pre-scan all the modes, and found the middle channel (TX) which is the worst case, only the worst case is recorded in the report.

The test results of 9kHz-30MHz was attenuated more than 20dB below the permissible limits, so the results don't record in the report.

Test Results (30~1000MHz)

Test Mode: Mode 2
 Power Source: AC 120V, 60Hz for adapter
 Polarization: Horizontal
 Temp.(°C)/Hum.(%RH): 24
 24.3°C/46%RH

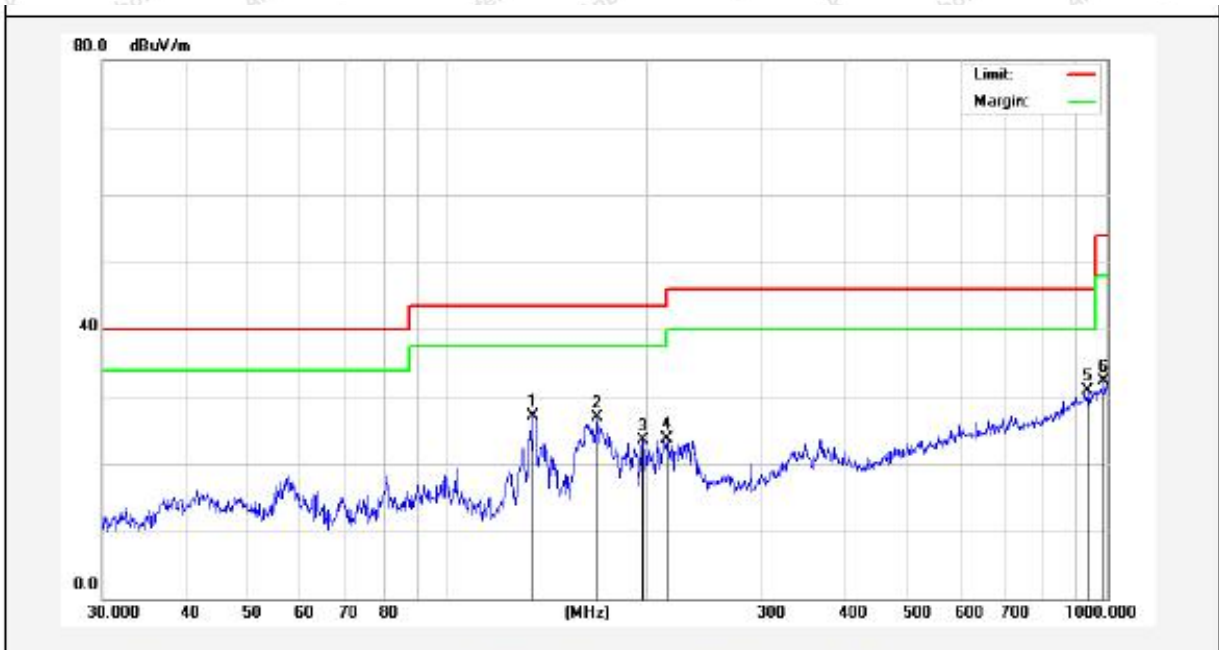

No.	Freq. (MHz)	Reading (dBuV)	Factor (dB/m)	Result (dBuV/m)	Limit (dBuV/m)	Over Limit (dB)	Detector	Height (cm)	degree (deg)	Remark
1	135.0319	47.87	-20.69	27.18	43.50	-16.32	QP	100	0	
2	168.4138	48.20	-21.39	26.81	43.50	-16.69	QP	100	360	
3	197.8928	43.49	-19.97	23.52	43.50	-19.98	QP	100	0	
4	215.2678	43.17	-19.56	23.61	43.50	-19.89	QP	100	360	
5	935.5463	31.90	-1.09	30.81	46.00	-15.19	QP	100	0	
6	989.5355	32.24	0.08	32.32	54.00	-21.68	QP	100	360	

Test Results (30~1000MHz)

Test Mode: Mode 2
 Power Source: AC 120V, 60Hz for adapter
 Polarization: Vertical
 Temp.(°C)/Hum.(%RH): 24.3°C/46%RH

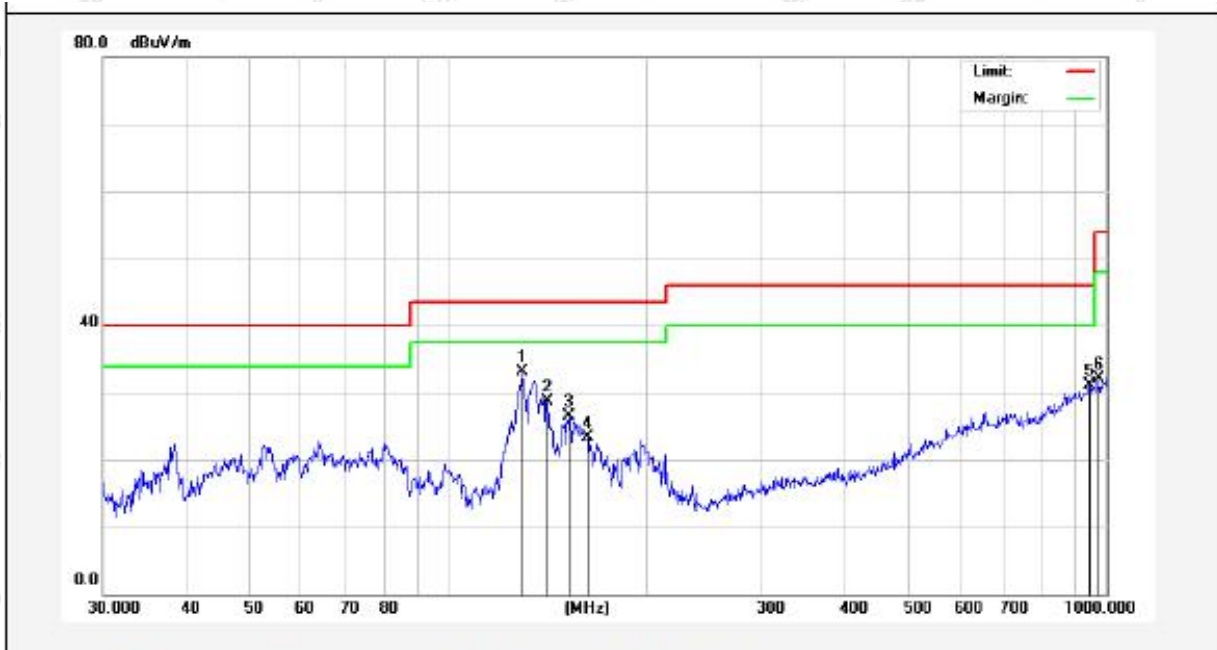

No.	Freq. (MHz)	Reading (dBuV)	Factor (dB/m)	Result (dBuV/m)	Limit (dBuV/m)	Over Limit (dB)	Detector	Height (cm)	degree (deg)	Remark
1	129.9226	52.43	-19.39	33.04	43.50	-10.46	QP	100	0	
2	141.8262	48.78	-20.04	28.74	43.50	-14.76	QP	100	360	
3	152.6641	46.19	-19.78	26.41	43.50	-17.09	QP	100	0	
4	163.1818	42.46	-19.24	23.22	43.50	-20.28	QP	100	360	
5	942.1305	32.01	-0.98	31.03	46.00	-14.97	QP	100	0	
6	975.7529	32.38	-0.24	32.14	54.00	-21.86	QP	100	360	

Test Results (1GHz-25GHz)

Test Mode: CH00					Test channel: Lowest			
Peak Value								
Frequency (MHz)	Read Level (dBuV)	Antenna Factor (dB/m)	Cable Loss (dB)	Preamp Factor (dB)	Level (dBuV/m)	Limit (dBuV/m)	Over Limit (dB)	Pol.
4804.00	38.22	34.04	6.58	34.09	44.75	74.00	-29.25	V
7206.00	32.43	37.11	7.73	34.50	42.77	74.00	-31.23	V
9608.00	32.01	39.31	9.23	34.79	45.76	74.00	-28.24	V
12010.00	*					74.00		V
14412.00	*					74.00		V
4804.00	42.69	34.04	6.58	34.09	49.22	74.00	-24.78	H
7206.00	34.27	37.11	7.73	34.50	44.61	74.00	-29.39	H
9608.00	31.52	39.31	9.23	34.79	45.27	74.00	-28.73	H
12010.00	*					74.00		H
14412.00	*					74.00		H
Average Value								
Frequency (MHz)	Read Level (dBuV)	Antenna Factor (dB/m)	Cable Loss (dB)	Preamp Factor (dB)	Level (dBuV/m)	Limit (dBuV/m)	Over Limit (dB)	Pol.
4804.00	26.86	34.04	6.58	34.09	33.39	54.00	-20.61	V
7206.00	21.02	37.11	7.73	34.50	31.36	54.00	-22.64	V
9608.00	20.04	39.31	9.23	34.79	33.79	54.00	-20.21	V
12010.00	*					54.00		V
14412.00	*					54.00		V
4804.00	31.19	34.04	6.58	34.09	37.72	54.00	-16.28	H
7206.00	23.25	37.11	7.73	34.50	33.59	54.00	-20.41	H
9608.00	19.84	39.31	9.23	34.79	33.59	54.00	-20.41	H
12010.00	*					54.00		H
14412.00	*					54.00		H

Test Results (1GHz-25GHz)

Test Mode: CH19					Test channel: Middle			
Peak Value								
Frequency (MHz)	Read Level (dBuV)	Antenna Factor (dB/m)	Cable Loss (dB)	Preamp Factor (dB)	Level (dBuV/m)	Limit (dBuV/m)	Over Limit (dB)	Pol.
4880.00	36.84	34.38	6.69	34.09	43.82	74.00	-30.18	V
7320.00	31.52	37.22	7.78	34.53	41.99	74.00	-32.01	V
9760.00	31.20	39.46	9.35	34.80	45.21	74.00	-28.79	V
12200.00	*					74.00		V
14640.00	*					74.00		V
4880.00	41.04	34.38	6.69	34.09	48.02	74.00	-25.98	H
7320.00	33.24	37.22	7.78	34.53	43.71	74.00	-30.29	H
9760.00	30.58	39.46	9.35	34.80	44.59	74.00	-29.41	H
12200.00	*					74.00		H
14640.00	*					74.00		H
Average Value								
Frequency (MHz)	Read Level (dBuV)	Antenna Factor (dB/m)	Cable Loss (dB)	Preamp Factor (dB)	Level (dBuV/m)	Limit (dBuV/m)	Over Limit (dB)	Pol.
4880.00	25.76	34.38	6.69	34.09	32.74	54.00	-21.26	V
7320.00	20.27	37.22	7.78	34.53	30.74	54.00	-23.26	V
9760.00	19.38	39.46	9.35	34.80	33.39	54.00	-20.61	V
12200.00	*					54.00		V
14640.00	*					54.00		V
4880.00	29.94	34.38	6.69	34.09	36.92	54.00	-17.08	H
7320.00	22.41	37.22	7.78	34.53	32.88	54.00	-21.12	H
9760.00	19.07	39.46	9.35	34.80	33.08	54.00	-20.92	H
12200.00	*					54.00		H
14640.00	*					54.00		H

Test Results (1GHz-25GHz)

Test Mode: CH39					Test channel: Highest			
Peak Value								
Frequency (MHz)	Read Level (dBuV)	Antenna Factor (dB/m)	Cable Loss (dB)	Preamp Factor (dB)	Level (dBuV/m)	Limit (dBuV/m)	Over Limit (dB)	Pol.
4960.00	36.45	34.72	6.79	34.09	43.87	74.00	-30.13	V
7440.00	31.27	37.34	7.82	34.57	41.86	74.00	-32.14	V
9920.00	30.97	39.62	9.46	34.81	45.24	74.00	-28.76	V
12400.00	*					74.00		V
14880.00	*					74.00		V
4960.00	40.57	34.72	6.79	34.09	47.99	74.00	-26.01	H
7440.00	32.95	37.34	7.82	34.57	43.54	74.00	-30.46	H
9920.00	30.31	39.62	9.46	34.81	44.58	74.00	-29.42	H
12400.00	*					74.00		H
14880.00	*					74.00		H
Average Value								
Frequency (MHz)	Read Level (dBuV)	Antenna Factor (dB/m)	Cable Loss (dB)	Preamp Factor (dB)	Level (dBuV/m)	Limit (dBuV/m)	Over Limit (dB)	Pol.
4960.00	25.49	34.72	6.79	34.09	32.91	54.00	-21.09	V
7440.00	20.09	37.34	7.82	34.57	30.68	54.00	-23.32	V
9920.00	19.22	39.62	9.46	34.81	33.49	54.00	-20.51	V
12400.00	*					54.00		V
14880.00	*					54.00		V
4960.00	29.63	34.72	6.79	34.09	37.05	54.00	-16.95	H
7440.00	22.21	37.34	7.82	34.57	32.80	54.00	-21.20	H
9920.00	18.88	39.62	9.46	34.81	33.15	54.00	-20.85	H
12400.00	*					54.00		H
14880.00	*					54.00		H

Remark:

1. Level =Receiver Read level + Antenna Factor + Cable Loss – Preamplifier Factor
2. “*” means the test results were attenuated more than 20dB below the permissible limits, so the results don't record in the report.

Radiated Band Edge:



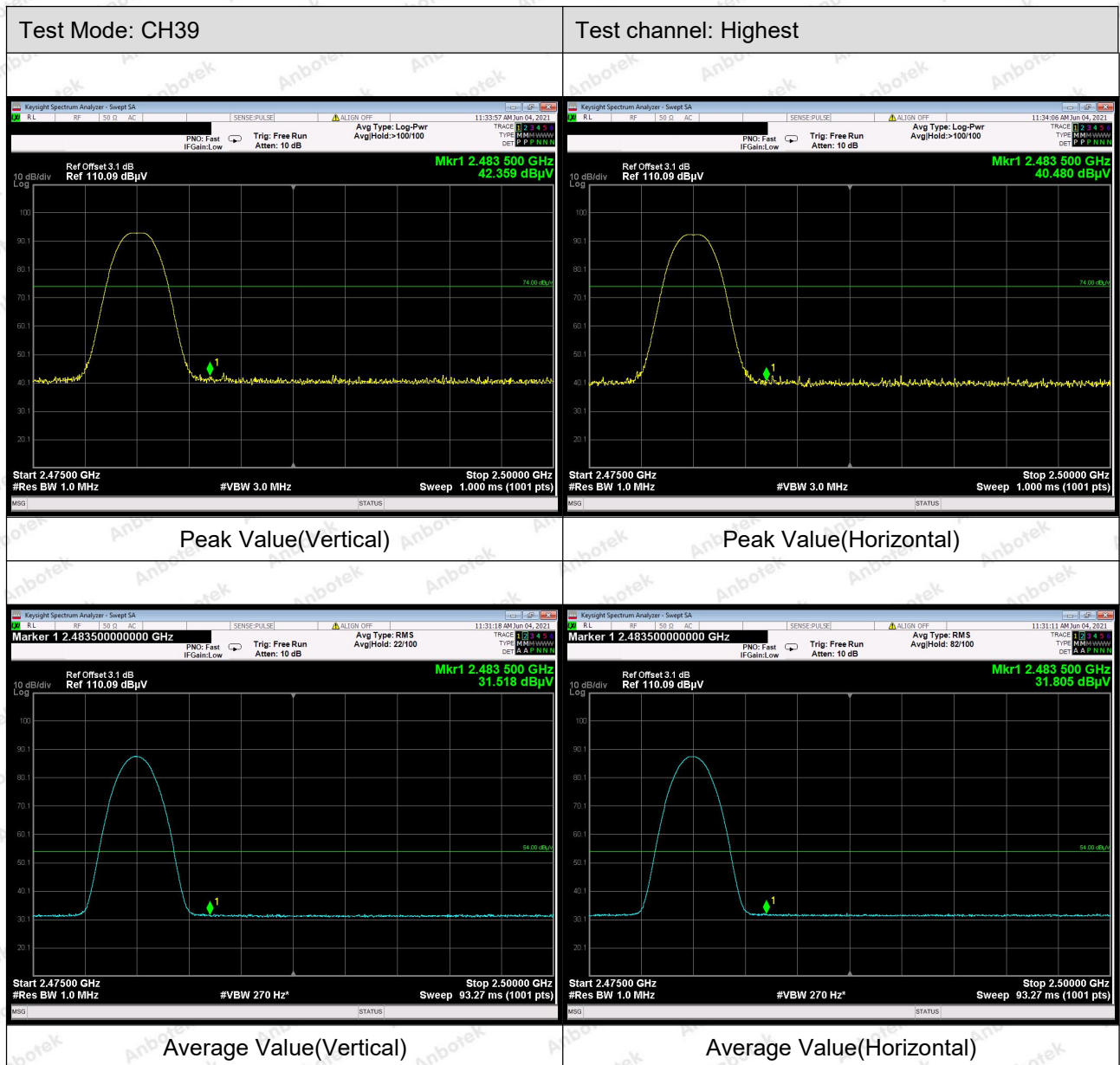

Remark:

- Level = Receiver Read level + Antenna Factor + Cable Loss – Pre-amplifier Factor

5. Maximum Peak Output Power Test

5.1. Test Standard and Limit

Test Standard	FCC Part15 C Section 15.247 (b)(3)
Test Limit	30dBm

5.2. Test Setup

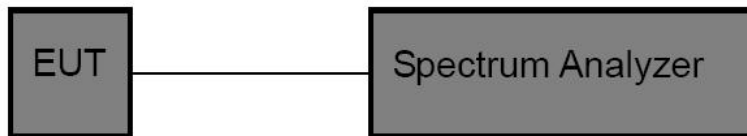

5.3. Test Procedure

This procedure shall be used when the measurement instrument has available a resolution bandwidth that is greater than the DTS bandwidth.

1. Set the RBW \geq DTS bandwidth.
2. Set the VBW $\geq 3 \times$ RBW.
3. Set the span $\geq 3 \times$ RBW.
4. Detector = peak.
5. Sweep time = auto couple.
6. Trace mode = max hold.
7. Allow trace to fully stabilize.
8. Use peak marker function to determine the peak amplitude level.

5.4. Test Data

Pass

Please refer to clause 2 of the Appendix Test Data.

Additional test for dutycycle.

Please refer to clause 4 of the Appendix Test Data.

6. 6DB Occupy Bandwidth Test

6.1. Test Standard and Limit

Test Standard	FCC Part15 C Section 15.247 (a)(2)
Test Limit	>500kHz

6.2. Test Setup

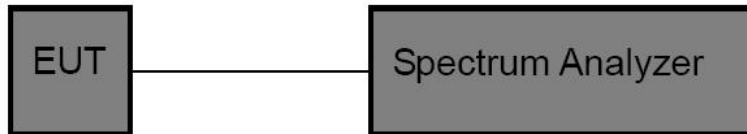

6.3. Test Procedure

1. Place the EUT on the table and set it in the transmitting mode.
2. Remove the antenna from the EUT and then connect a low loss RF cable from the antenna port to the spectrum analyzer.
3. Set the spectrum analyzer as:
 RBW = 100kHz, VBW \geq 3*RBW =300kHz,
 Detector= Peak
 Trace mode= Max hold.
 Sweep- auto couple.
4. Mark the peak frequency and -6dB (upper and lower) frequency.
5. Repeat until all the rest channels are investigated.

6.4. Test Data

Pass

Please refer to clause 1 of the Appendix Test Data.

7. Power Spectral Density Test

7.1. Test Standard and Limit

Test Standard	FCC Part15 C Section 15.247 (e)
Test Limit	8dBm/3KHz

7.2. Test Setup

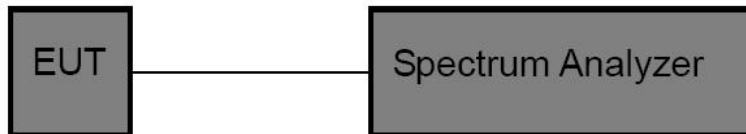

7.3. Test Procedure

1. Place the EUT on the table and set it in transmitting mode. Remove the antenna from the EUT and then connect a low loss RF cable from the antenna port to the spectrum analyzer.
2. Set the spectrum analyzer as RBW = 3kHz, VBW = 10kHz, Span = 1.5xDTSS BW
3. Record the max. reading.
4. Repeat the above procedure until the measurements for all frequencies are completed.

7.4. Test Data

Pass

Please refer to clause 5 of the Appendix Test Data.

8. 100kHz Bandwidth of Frequency Band Edge Requirement

8.1. Test Standard and Limit

Test Standard	FCC Part15 C Section 15.247 (d)
Test Limit	in any 100 kHz bandwidth outside the frequency bands in which the spread spectrum intentional radiator is operating, the radio frequency power that is produced by the intentional radiator shall be at least 20dB below that in the 100kHz bandwidth within the band that contains the highest level of the desired power, In addition, radiated emissions which fall in the restricted bands, as defined in §15.205(a), must also comply with the radiated emission limits specified in15.209(a).

8.2. Test Setup

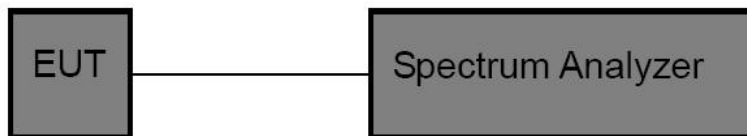

8.3. Test Procedure

Using the following spectrum analyzer setting:

1. Set the RBW = 100KHz.
2. Set the VBW = 300KHz.
3. Sweep time = auto couple.
4. Detector function = peak.
5. Trace mode = max hold.
6. Allow trace to fully stabilize.

8.4. Test Data

Pass

Please refer to clause 3 of the Appendix Test Data.

9. Antenna Requirement

9.1. Test Standard and Requirement

Test Standard	FCC Part15 Section 15.203 /247(c)
Requirement	<p>1) 15.203 requirement: An intentional radiator shall be designed to ensure that no antenna other than that furnished by the responsible party shall be used with the device. The use of a permanently attached antenna or of an antenna that uses a unique coupling to the intentional radiator, the manufacturer may design the unit so that a broken antenna can be replaced by the user, but the use of a standard antenna jack or electrical connector is prohibited.</p> <p>2) 15.247(c) (1)(i) requirement: Systems operating in the 2400-2483.5 MHz band that is used exclusively for fixed. Point-to-point operations may employ transmitting antennas with directional gain greater than 6dBi provided the maximum conducted output power of the intentional radiator is reduced by 1 dB for every 3 dB that the directional gain of the antenna exceeds 6 dBi.</p>

9.2. Antenna Connected Construction

The antenna is a PCB Antenna which permanently attached, and the best case gain of the antenna is 0 dBi . It complies with the standard requirement.

APPENDIX I -- TEST SETUP PHOTOGRAPH

Please refer to the test report 18220WC10097201.

APPENDIX II -- EXTERNAL PHOTOGRAPH

Please refer to the test report 18220WC10097201.

APPENDIX III -- INTERNAL PHOTOGRAPH

Please refer to the test report 18220WC10097201.

APPENDIX IV – Appendix Test Data