

FCC Test Report

Client Name : Autel Intelligent Tech. Corp., Ltd.
Address : 7th-8th, 10th Floor, Bldg. B1, Zhiyuan,Xueyuan Rd. Xili,
Nanshan Shenzhen China
Product Name : MaxiFlash VCI
Date : Jun. xx, 2021



Shenzhen Anbotek Compliance Laboratory Limited

Contents

- 1. General Information.....5
 - 1.1. Client Information..... 5
 - 1.2. Description of Device (EUT)..... 5
 - 1.3. Auxiliary Equipment Used During Test..... 6
 - 1.4. Description of Test Modes..... 7
 - 1.5. List of channels..... 7
 - 1.6. Description Of Test Setup..... 8
 - 1.7. Test Equipment List..... 9
 - 1.8. Measurement Uncertainty..... 10
 - 1.9. Description of Test Facility..... 10
- 2. Summary of Test Results..... 11
- 3. Conducted Emission Test..... 12
 - 3.1. Test Standard and Limit..... 12
 - 3.2. Test Setup..... 12
 - 3.3. Test Procedure..... 12
 - 3.4. Test Data..... 12
- 4. Radiation Spurious Emission and Band Edge..... 17
 - 4.1. Test Standard and Limit..... 17
 - 4.2. Test Setup..... 17
 - 4.3. Test Procedure..... 18
 - 4.4. Test Data..... 19
- 5. Maximum Peak Output Power Test..... 23
 - 5.1. Test Standard and Limit..... 23
 - 5.2. Test Setup..... 23
 - 5.3. Test Procedure..... 23
 - 5.4. Test Data..... 23
- 6. Occupy Bandwidth Test..... 24
 - 6.1. Test Standard..... 24
 - 6.2. Test Setup..... 24
 - 6.3. Test Procedure..... 24
 - 6.4. Test Data..... 24
- 7. Power Spectral Density Test..... 25
 - 7.1. Test Standard and Limit..... 25
 - 7.2. Test Setup..... 25
 - 7.3. Test Procedure..... 25
 - 7.4. Test Data..... 25
- 8. Frequency Stability..... 26
 - 8.1. Test Standard and Limit..... 26
 - 8.2. Test Setup..... 26

8.3. Test Procedure..... 26

8.4. Test Data..... 26

9. Antenna Requirement..... 27

9.1. Test Standard and Requirement..... 27

9.2. Antenna Connected Construction..... 27

APPENDIX I -- TEST SETUP PHOTOGRAPH..... 28

APPENDIX II -- EXTERNAL PHOTOGRAPH..... 30

APPENDIX III -- INTERNAL PHOTOGRAPH..... 30

APPENDIX IV – Appendix Test Data..... 31

TEST REPORT

Applicant : Autel Intelligent Tech. Corp., Ltd.
Manufacturer : Autel Intelligent Tech. Corp., Ltd.
Product Name : MaxiFlash VCI
Model No. : MaxiFlash VCI
Trade Mark : N.A.
Rating(s) : Input: DC 12V, 3A (via adapter input: 100-240V~50/60Hz, 15A; Ouput: DC 12V/3A)

**Test Standard(s) : FCC Part15 Subpart E, Paragraph 15.407
ANSI C63.10: 2020,**

**Test Method(s) : KDB 789033 D02 General UNII Test Procedures New Rules v02r01
KDB 662911 D01 Multiple Transmitter Output v02r01**

The device described above is tested by Shenzhen Anbotek Compliance Laboratory Limited to determine the maximum emission levels emanating from the device and the severe levels of the device can endure and its performance criterion. The measurement results are contained in this test report and Shenzhen Anbotek Compliance Laboratory Limited is assumed full of responsibility for the accuracy and completeness of these measurements. Also, this report shows that the EUT (Equipment Under Test) is technically compliant with the FCC Part 15 Subpart E requirements.

This report applies to above tested sample only and shall not be reproduced in part without written approval of Shenzhen Anbotek Compliance Laboratory Limited.

Date of Receipt

Jun. 04, 2021

Date of Test

Jun. 04~Jun. 10, 2021

Prepared By



(Ella Liang)

Approved & Authorized Signer

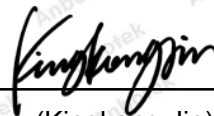

(Kingkong Jin)

1. General Information

1.1. Client Information

Applicant	:	Autel Intelligent Tech. Corp., Ltd.
Address	:	7th-8th, 10th Floor, Bldg. B1, Zhiyuan,Xueyuan Rd. Xili, Nanshan Shenzhen China
Manufacturer	:	Autel Intelligent Tech. Corp., Ltd.
Address	:	7th-8th, 10th Floor, Bldg. B1, Zhiyuan,Xueyuan Rd. Xili, Nanshan Shenzhen China
Factory 1	:	Autel Intelligent Technology Corp., Ltd. Guangming Branch
Address	:	7F&6F, East Wing, Building 2, and 6F of Electronical Building, Yanxiang Industrial Zone, Gaoxin Rd, Dongzhou Community of Guangming New District, Shenzhen
Factory 2	:	AUTEL VIETNAM COMPANY LIMITED
Address	:	4th Floor, Factory#6, Land#CN1, An Duong Industrial Zone, Hong Phong Township, An Duong County, Hai Phong, Viet Nam

1.2. Description of Device (EUT)

Product Name	:	MaxiFlash VCI
Model No.	:	MaxiFlash VCI
Trade Mark	:	N.A.
Test Power Supply	:	AC 120V, 60Hz for adapter / AC 240V, 60Hz for adapter
Test Sample No.	:	1-2-1(Normal Sample), 1-2-2(Engineering Sample)
Product Description	:	Operation Frequency: BDR+EDR: 2402-2480MHz WiFi 2.4G: 802.11b/ g/ n(HT20): 2412-2462MHz WiFi 5.1G: 5180MHz~5240MHz WiFi 5.8G: 5745MHz~5825MHz
		Number of Channel: BDR+EDR: 79 Channels WiFi 2.4G: 13 Channels for 802.11g/ n(HT20) WiFi 5.1G: 4 Channels for 802.11a/n(HT20)/ac(HT20) 2 Channels for 802.11n(HT40)/ac(HT40) 1 Channels for 802.11ac(HT80) WiFi 5.8G: 5 Channels for 802.11a/n(HT20)/ac(HT20) 2 Channels for 802.11n(HT40)/ac(HT40) 1 Channels for 802.11ac(HT80)
		Modulation Type: BDR+EDR: GFSK, $\pi/4$ -DQPSK, 8DPSK WiFi 2.4G: CCK, DQPSK, DBPSK for DSSS

		64QAM, 16QAM, QPSK, BPSK for OFDM WiFi 5G: OFDM with BPSK/QPSK/16QAM/64QAM/256QAM
	Antenna Type:	WiFi:PIFA antenna BT:PIFA antenna
	Antenna Gain(Peak):	BT: 0.5 dBi 2.4G WiFi:1.9 dBi WiFi 5G:2.6 dBi
Remark: 1) For a more detailed features description, please refer to the manufacturer's specifications or the User's Manual. 2) This report is for 5.8G WiFi module.		

1.3. Auxiliary Equipment Used During Test

Adapter	:	Model: GME36A-120300FDS Input: 100-240~, 50-60Hz, 1.2A MAX Output: 12.0V=3.0A
---------	---	-------------------------------------------------------------------------------------



1.4. Description of Test Modes

To investigate the maximum EMI emission characteristics generates from EUT, the test system was pre-scanning tested base on the consideration of following EUT operation mode or test configuration mode which possible have effect on EMI emission level. Each of these EUT operation mode(s) or test configuration mode(s) mentioned above was evaluated respectively.

Mode	Test channel	Frequency (MHz)
OFDM(802.11a/n20/ac20)	CH 149	5745MHz
	CH 157	5785MHz
	CH 165	5825MHz
OFDM(802.11n40/ac40)	CH 151	5755MHz
	CH 159	5795MHz
OFDM(802.11ac80)	CH 155	5775MHz

Note:

1. The measurements are performed at the highest, middle, lowest available channels.
2. The EUT has been tested as an independent unit. And Continual Transmitting in maximum power.
3. For the relevant Conducted Measurement, the temporary antenna connector is used during the measurement. Antenna Connector Impedance: 50Ω, Cable Loss: 1.0 dB
4. The EUT was programmed to be in continuously transmitting mode and the transmit duty cycle is more than 98%

1.5. List of channels

802.11a/n20/ac20

Channel	Freq. (MHz)	Channel	Freq. (MHz)
149	5745	153	5765
157	5785	161	5805
165	5825		

802.11n40/ac40

Channel	Freq. (MHz)	Channel	Freq. (MHz)
151	5755	159	5795

802.11ac80

Channel	Freq. (MHz)
155	5775

1.6. Description Of Test Setup

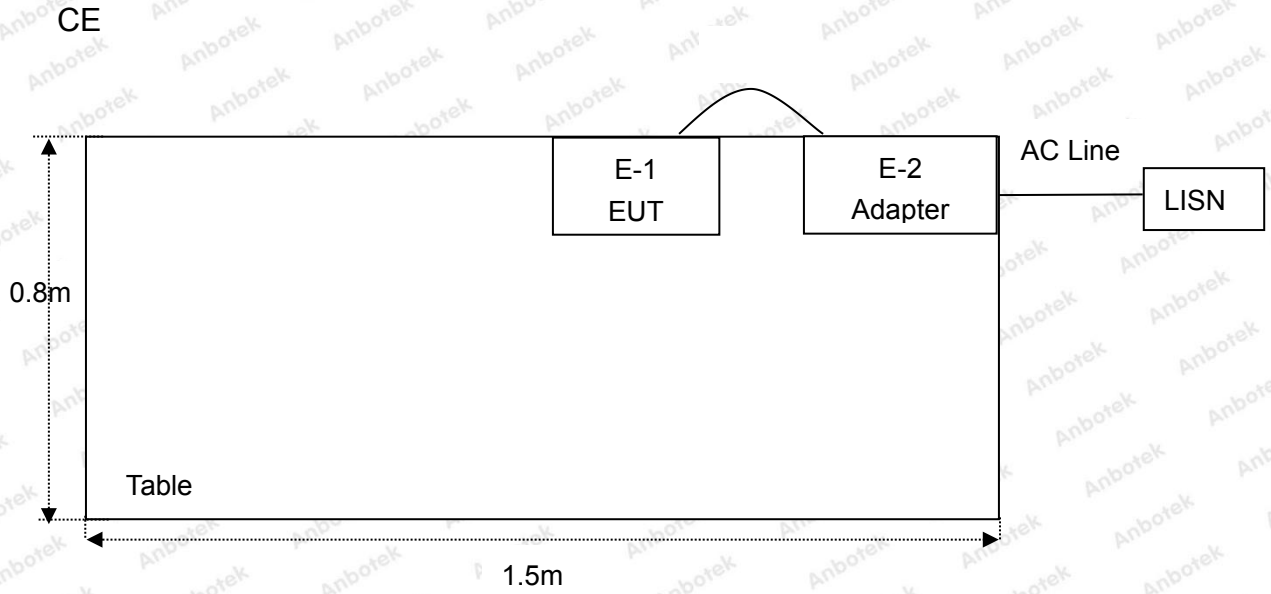

RE

RE

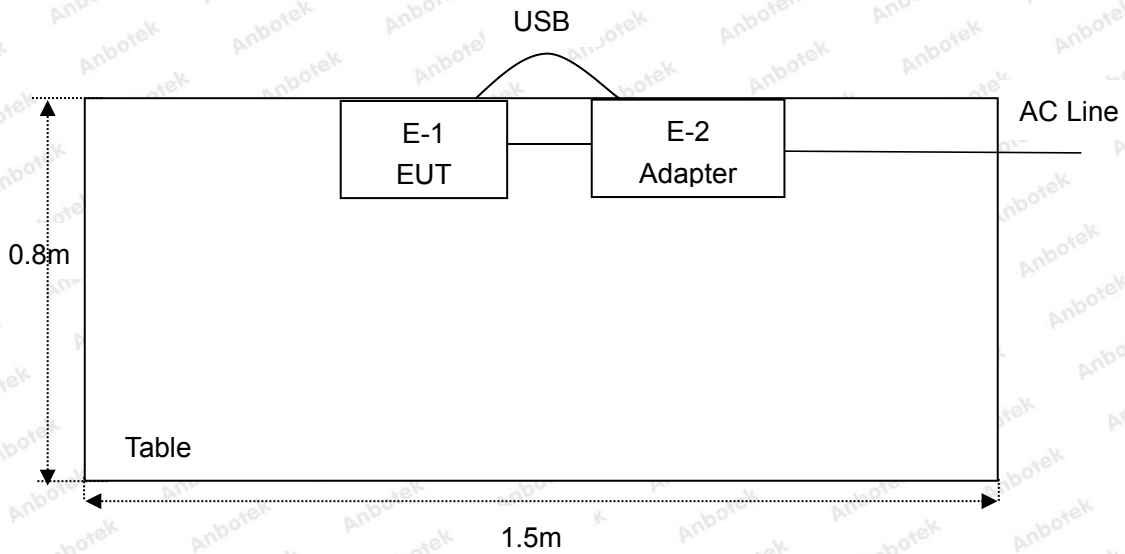

1.7. Test Equipment List

Item	Equipment	Manufacturer	Model No.	Serial No.	Last Cal.	Cal. Interval
1.	L.I.S.N. Artificial Mains Network	Rohde & Schwarz	ENV216	100055	Oct. 26, 2020	1 Year
2.	EMI Test Receiver	Rohde & Schwarz	ESCI	100627	Oct. 26, 2020	1 Year
3.	EMI Test Receiver	Rohde & Schwarz	ESR26	101481	Oct. 26, 2020	1 Year
4.	RF Switching Unit	Compliance Direction	RSU-M2	38303	Oct. 26, 2020	1 Year
5.	MAX Spectrum Analysis	Agilent	N9020A	MY51170037	Oct. 26, 2020	1 Year
6.	Preamplifier	SKET Electronic	BK1G18G30 D	KD17503	Oct. 26, 2020	1 Year
7.	Double Ridged Horn Antenna	Instruments corporation	GTH-0118	351600	Nov. 02, 2020	2 Year
8.	Bilog Broadband Antenna	Schwarzbeck	VULB9163	VULB 9163-289	Nov. 02, 2020	2 Year
9.	Loop Antenna	Schwarzbeck	FMZB1519B	00053	Nov. 02, 2020	2 Year
10.	Horn Antenna	A-INFO	LB-180400- KF	J211060628	Nov. 02, 2020	2 Year
11.	Pre-amplifier	SONOMA	310N	186860	Oct. 26, 2020	1 Year
12.	EMI Test Software EZ-EMC	SHURPLE	N/A	N/A	N/A	N/A
13.	RF Test Control System	YIHENG	YH3000	2017430	Oct. 26, 2020	1 Year
14.	Power Sensor	DAER	RPR3006W	15100041SN045	Oct. 26, 2020	1 Year
15.	Power Sensor	DAER	RPR3006W	15100041SN046	Oct. 26, 2020	1 Year
16.	MXA Spectrum Analysis	Agilent	N9020A	MY51170037	Oct. 26, 2020	1 Year
17.	MXG RF Vector Signal Generator	Agilent	N5182A	MY48180656	Oct. 26, 2020	1 Year
18.	Signal Generator	Agilent	E4421B	MY41000743	Oct. 26, 2020	1 Year
19.	DC Power Supply	IVYTECH	IV3605	1804D360510	Oct. 26, 2020	1 Year
20.	Constant Temperature Humidity Chamber	ZHONGJIAN	ZJ-KHWS80 B	N/A	Oct. 26, 2020	1 Year

1.8. Measurement Uncertainty

Radiation Uncertainty	:	Ur = 3.9 dB (Horizontal)
		Ur = 3.8 dB (Vertical)
Conduction Uncertainty	:	Uc = 3.4 dB

1.9. Description of Test Facility

The test facility is recognized, certified, or accredited by the following organizations:

FCC-Registration No.: 184111

Shenzhen Anbotek Compliance Laboratory Limited, EMC Laboratory has been registered and fully described in a report filed with the (FCC) Federal Communications Commission. The acceptance letter from the FCC is maintained in our files. Registration No. 184111, September 30, 2020.

ISED-Registration No.: 8058A

Shenzhen Anbotek Compliance Laboratory Limited, EMC Laboratory has been registered and fully described in a report filed with the (ISED) Innovation, Science and Economic Development Canada. The acceptance letter from the ISED is maintained in our files. Registration 8058A, September 30, 2020.

Test Location

Shenzhen Anbotek Compliance Laboratory Limited.

1/F, Building D, Sogood Science and Technology Park, Sanwei community, Hangcheng Street, Bao'an District, Shenzhen, Guangdong, China.518102

2. Summary of Test Results

Standard	Test Type	Result
15.207 & 15.407	Conducted Emission	PASS
15.205/15.209	Spurious Emission	PASS
15.407(b)	Band Edge	PASS
15.407(a)(5)&15.407(e)	Occupy Bandwidth	PASS
15.407(a)(3)	Maximum Conducted Output Power	PASS
15.407(a)(1)(3)	Peak Power Spectral Density	PASS
15.203	Antenna Requirement	PASS
15.407(g)	Frequency Stability	PASS

3. Conducted Emission Test

3.1. Test Standard and Limit

Test Standard	FCC Part15 Section 15.207&15.407		
Test Limit	Frequency	Maximum RF Line Voltage (dBuV)	
		Quasi-peak Level	Average Level
	150kHz~500kHz	66 ~ 56 *	56 ~ 46 *
	500kHz~5MHz	56	46
5MHz~30MHz	60	50	

Remark: (1) *Decreasing linearly with logarithm of the frequency.
 (2) The lower limit shall apply at the transition frequency.

3.2. Test Setup

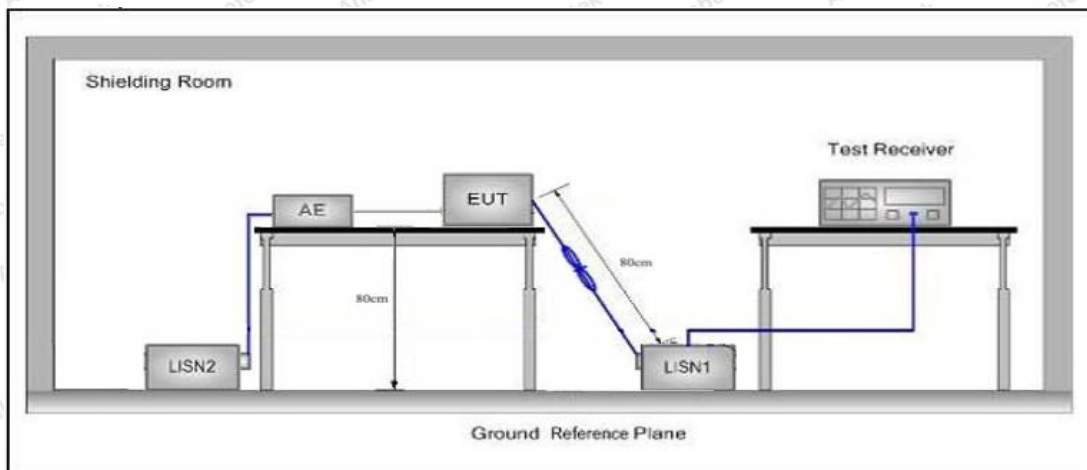

3.3. Test Procedure

The EUT system is connected to the power mains through a line impedance stabilization network (L.I.S.N.). This provides a 50ohm coupling impedance for the EUT system. Please refer the block diagram of the test setup and photographs. Both sides of AC line are checked to find out the maximum conducted emission. In order to find the maximum emission levels, the relative positions of equipment and all of the interface cables shall be changed according to FCC ANSI C63.10-2020 on Conducted Emission Measurement.

The bandwidth of test receiver (ESCI) set at 9kHz.

The frequency range from 150kHz to 30MHz is checked.

3.4. Test Data

During the test, pre-scan all modes, and found the 802.11n (HT40) CH 159 for ANT1+2 which is the worst case, only the worst case is recorded in the report.

Conducted Emission Test Data

Test Site: 1# Shielded Room
 Operating Condition: 802.11n (HT40) CH 151
 Test Specification: AC 120V, 60Hz for adapter
 Comment: Live Line
 Tem.: 24.2°C Hum.: 58%

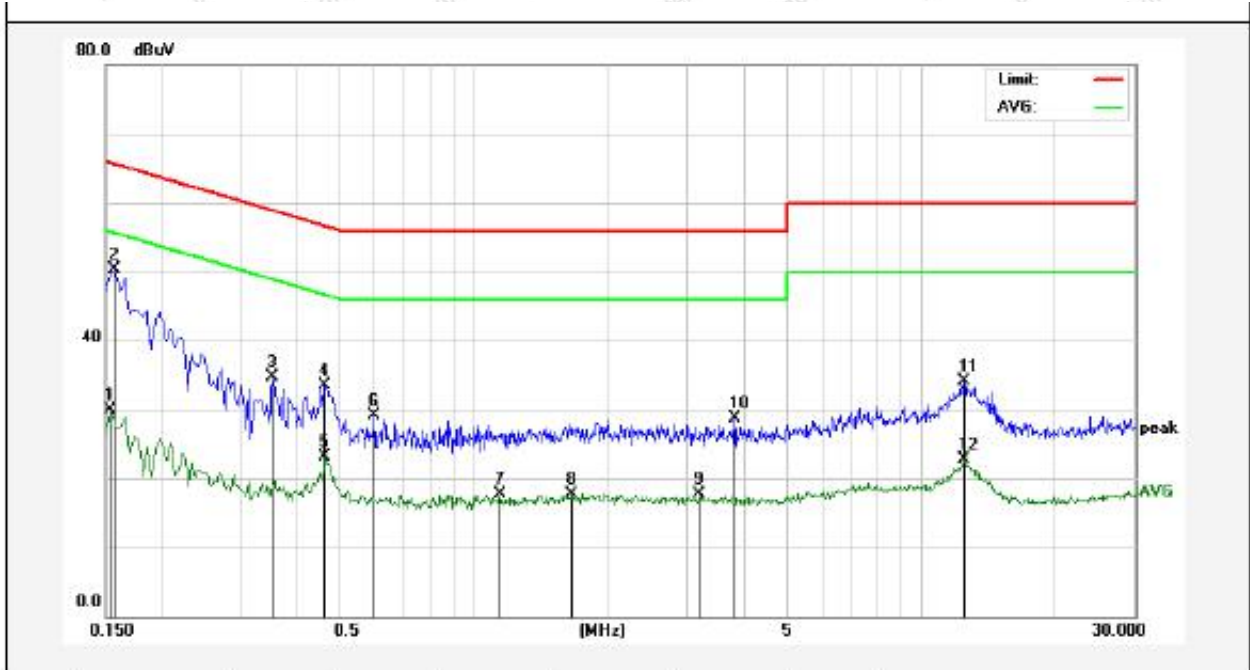

No.	Freq. (MHz)	Reading (dBuV)	Factor (dB)	Result (dBuV)	Limit (dBuV)	Over Limit (dB)	Detector	Remark
1	0.1539	10.09	19.90	29.99	55.78	-25.79	AVG	
2	0.1580	30.38	19.90	50.28	65.56	-15.28	QP	
3	0.3540	14.82	19.91	34.73	58.87	-24.14	QP	
4	0.4660	13.55	19.96	33.51	56.58	-23.07	QP	
5	0.4660	3.16	19.96	23.12	46.58	-23.46	AVG	
6	0.5980	9.11	20.01	29.12	56.00	-26.88	QP	
7	1.1460	-2.47	20.12	17.65	46.00	-28.35	AVG	
8	1.6540	-2.37	20.13	17.76	46.00	-28.24	AVG	
9	3.1900	-2.49	20.16	17.67	46.00	-28.33	AVG	
10	3.8340	8.50	20.18	28.68	56.00	-27.32	QP	
11	12.5060	13.84	20.30	34.14	60.00	-25.86	QP	
12	12.5060	2.48	20.30	22.78	50.00	-27.22	AVG	

Conducted Emission Test Data

Test Site: 1# Shielded Room
 Operating Condition: 802.11n (HT40) CH 151
 Test Specification: AC 120V, 60Hz for adapter
 Comment: Neutral Line
 Tem.: 24.2°C Hum.: 58%

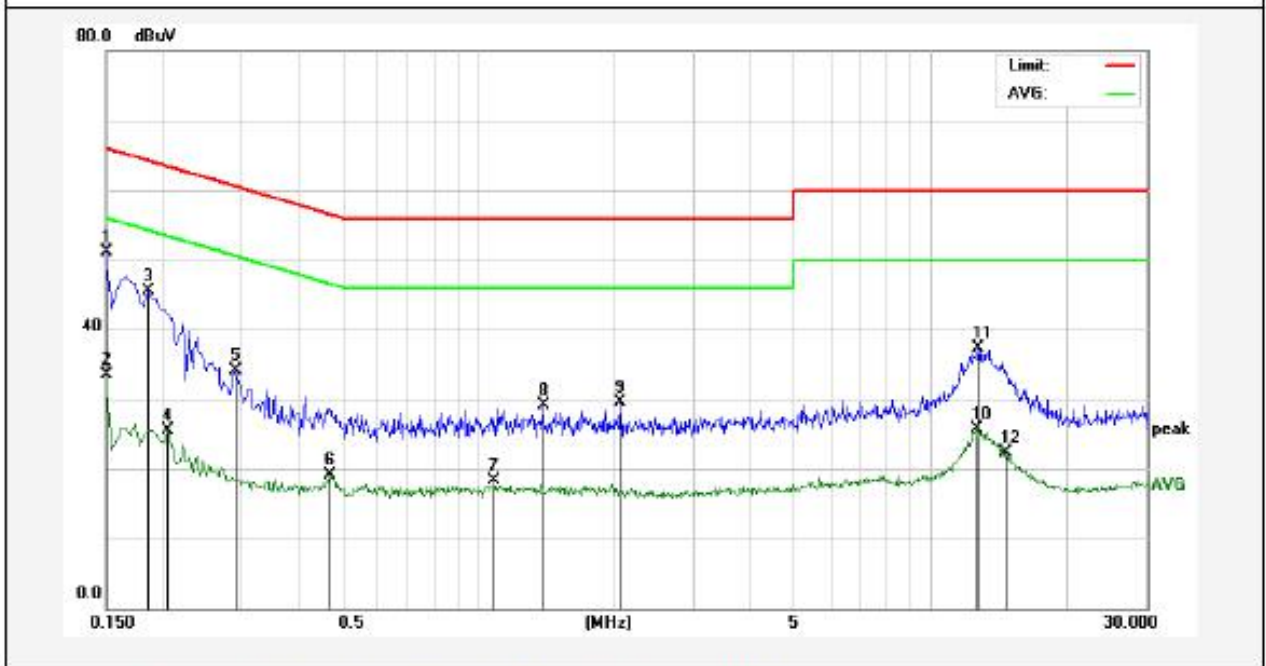

No.	Freq. (MHz)	Reading (dBUV)	Factor (dB)	Result (dBUV)	Limit (dBUV)	Over Limit (dB)	Detector	Remark
1	0.1500	31.24	19.90	51.14	65.99	-14.85	QP	
2	0.1500	13.65	19.90	33.55	55.99	-22.44	AVG	
3	0.1860	25.67	19.90	45.57	64.21	-18.64	QP	
4	0.2060	5.56	19.90	25.46	53.36	-27.90	AVG	
5	0.2900	14.12	19.89	34.01	60.52	-26.51	QP	
6	0.4700	-0.81	19.97	19.16	46.51	-27.35	AVG	
7	1.0859	-1.83	20.12	18.29	46.00	-27.71	AVG	
8	1.3940	9.05	20.13	29.18	56.00	-26.82	QP	
9	2.0579	9.33	20.14	29.47	56.00	-26.53	QP	
10	12.6180	5.35	20.30	25.65	50.00	-24.35	AVG	
11	12.7380	17.08	20.30	37.38	60.00	-22.62	QP	
12	14.6340	2.10	20.27	22.37	50.00	-27.63	AVG	

Conducted Emission Test Data

Test Site: 1# Shielded Room
 Operating Condition: 802.11n (HT40) CH 151
 Test Specification: AC 240V, 60Hz for adapter
 Comment: Live Line
 Tem.: 24.2°C Hum.: 58%

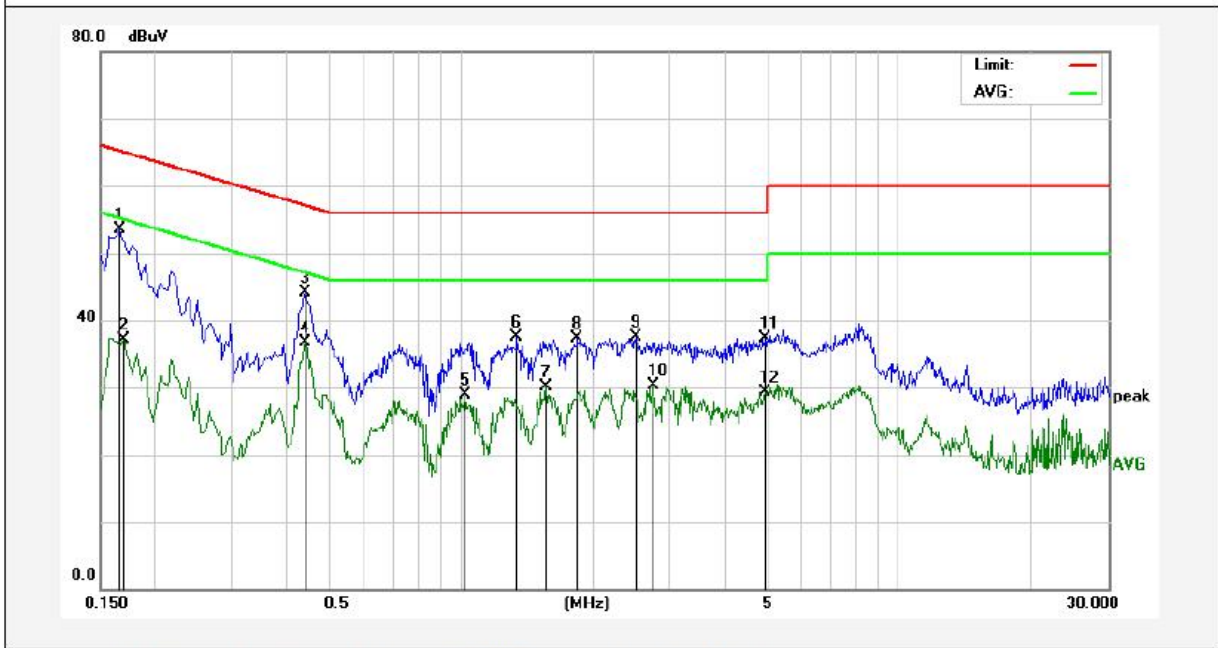

No.	Freq. (MHz)	Reading (dBuV)	Factor (dB)	Result (dBuV)	Limit (dBuV)	Over Limit (dB)	Detector	Remark
1	0.1660	33.63	19.90	53.53	65.15	-11.62	QP	
2	0.1700	17.24	19.90	37.14	54.96	-17.82	AVG	
3	0.4420	24.11	19.95	44.06	57.02	-12.96	QP	
4	0.4420	16.85	19.95	36.80	47.02	-10.22	AVG	
5	1.0260	8.76	20.12	28.88	46.00	-17.12	AVG	
6	1.3380	17.32	20.13	37.45	56.00	-18.55	QP	
7	1.5620	9.89	20.13	30.02	46.00	-15.98	AVG	
8	1.8460	17.14	20.14	37.28	56.00	-18.72	QP	
9	2.5059	17.28	20.15	37.43	56.00	-18.57	QP	
10	2.7500	10.15	20.15	30.30	46.00	-15.70	AVG	
11	4.9460	17.15	20.21	37.36	56.00	-18.64	QP	
12	4.9460	9.12	20.21	29.33	46.00	-16.67	AVG	

Conducted Emission Test Data

Test Site: 1# Shielded Room
 Operating Condition: 802.11n (HT40) CH 151
 Test Specification: AC 240V, 60Hz for adapter
 Comment: Neutral Line
 Tem.: 24.2°C Hum.: 58%

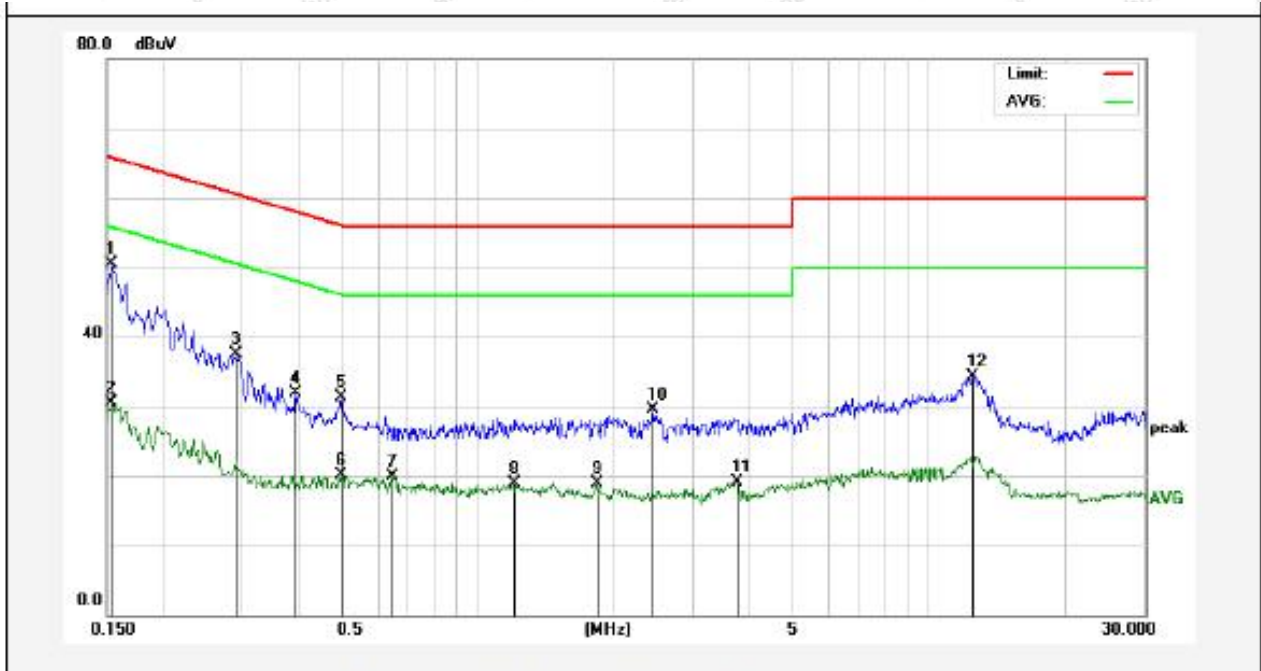

No.	Freq. (MHz)	Reading (dBuV)	Factor (dB)	Result (dBuV)	Limit (dBuV)	Over Limit (dB)	Detector	Remark
1	0.1539	30.53	19.90	50.43	65.78	-15.35	QP	
2	0.1539	10.64	19.90	30.54	55.78	-25.24	AVG	
3	0.2898	17.62	19.89	37.51	60.53	-23.02	QP	
4	0.3940	11.92	19.93	31.85	57.98	-26.13	QP	
5	0.4979	11.38	19.98	31.36	56.03	-24.67	QP	
6	0.4979	0.21	19.98	20.19	46.03	-25.84	AVG	
7	0.6460	-0.12	20.02	19.90	46.00	-26.10	AVG	
8	1.1937	-1.28	20.12	18.84	46.00	-27.16	AVG	
9	1.8300	-1.33	20.14	18.81	46.00	-27.19	AVG	
10	2.4380	9.33	20.15	29.48	56.00	-26.52	QP	
11	3.7458	-1.15	20.17	19.02	46.00	-26.98	AVG	
12	12.4977	14.03	20.30	34.33	60.00	-25.67	QP	

4. Radiation Spurious Emission and Band Edge

4.1. Test Standard and Limit

Test Standard	FCC Part15 C Section 15.209, 15.205 and 15.407				
Test Limit	Frequency (MHz)	Field strength (microvolt/meter)	Limit (dBuV/m)	Remark	Measurement distance (m)
	0.009MHz~0.490MHz	2400/F(kHz)	-	-	300
	0.490MHz-1.705MHz	24000/F(kHz)	-	-	30
	1.705MHz-30MHz	30	-	-	30
	30MHz~88MHz	100	40.0	Quasi-peak	3
	88MHz~216MHz	150	43.5	Quasi-peak	3
	216MHz~960MHz	200	46.0	Quasi-peak	3
	960MHz~1000MHz	500	54.0	Quasi-peak	3
	Above 1000MHz	500	54.0	Average	3
-		68.2	Peak	3	

Remark:

- (1)The lower limit shall apply at the transition frequency.
- (2) 15.35(b), Unless otherwise specified, the limit on peak radio frequency emissions is 20dB above the maximum permitted average emission limit applicable to the equipment under test. This peak limit applies to the total peak emission level radiated by the device.
- (3)Above 1GHz limit: $E[dBuV/m] = EIRP[dBm] + 95.2 = 68.2 \text{ dBuV/m}$, for $EIPR[dBm] = -27 \text{ dBm}$.

4.2. Test Setup

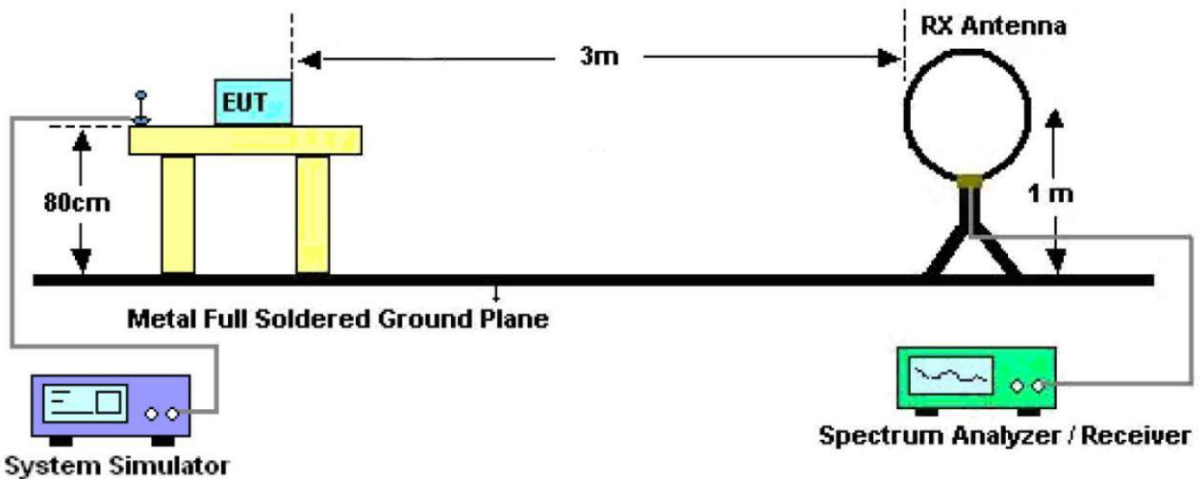

Figure 1. Below 30MHz

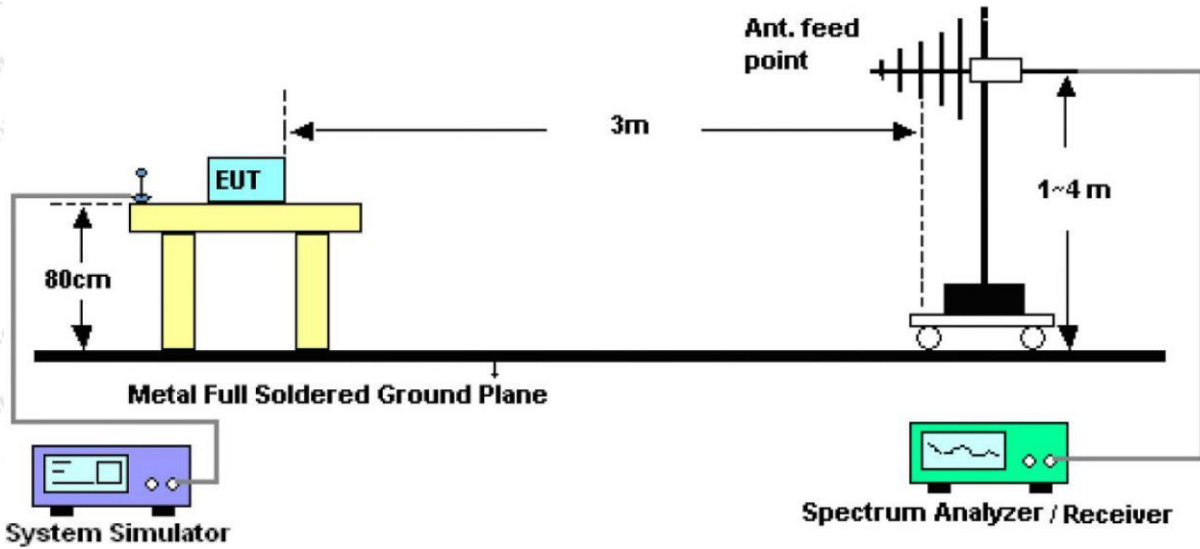

Figure 2. 30MHz to 1GHz

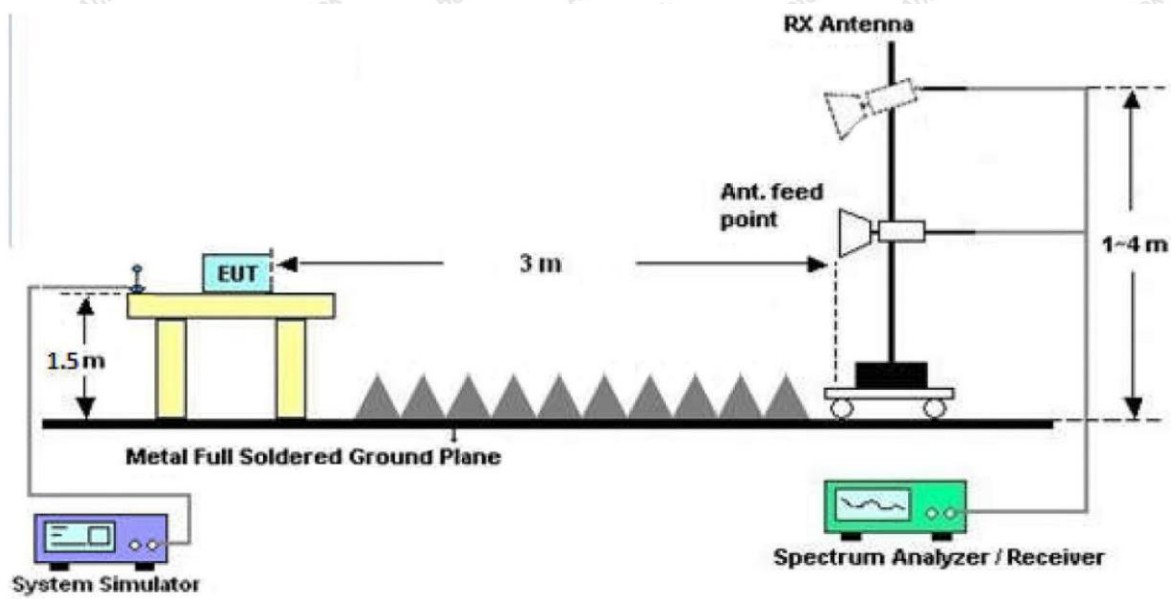

Figure 3. Above 1 GHz

4.3. Test Procedure

For below 1GHz: The EUT is placed on a turntable, which is 0.8m above the ground plane.

For above 1GHz: The EUT is placed on a turntable, which is 1.5m above the ground plane.

The turn table can rotate 360 degrees to determine the position of the maximum emission level. The EUT is set 3 meters away from the receiving antenna which is mounted on a antenna tower. The antenna can be moved up and down from 1 to 4 meters to find out the maximum emission level. Rotated the EUT through three orthogonal axes to determine the maximum emissions, both horizontal and vertical polarization of the antenna are set on test. The EUT is tested in 9*6*6 Chamber. The device is evaluated in xyz orientation.

For the radiated emission test above 1GHz:

Shenzhen Anbotek Compliance Laboratory Limited

Code:AB-RF-05-a

Address: 1/F., Building D, Sogood Science and Technology Park, Sanwei Community, Hangcheng Street, Bao'an District, Shenzhen, Guangdong, China.

Hotline
400-003-0500
www.anbotek.com

Tel:(86) 755-26066440 Fax: (86) 755-26014772 Email: service@anbotek.com

Place the measurement antenna away from each area of the EUT determined to be a source of emissions at the specified measurement distance, while keeping the measurement antenna aimed at the source of emissions at each frequency of significant emissions, with polarization oriented for maximum response. The measurement antenna may have to be higher or lower than the EUT, depending on the radiation pattern of the emission and staying aimed at the emission source for receiving the maximum signal. The final measurement antenna elevation shall be that which maximizes the emissions. The measurement antenna elevation for maximum emissions shall be restricted to a range of heights of from 1 m to 4 m above the ground or reference ground plane.

For 9kHz to 150kHz, Set the spectrum analyzer as:

RBW = 200Hz, VBW = 1kHz, Detector= Quasi-Peak, Trace mode= Max hold, Sweep- auto couple.

For 150kHz to 30MHz, Set the spectrum analyzer as:

RBW = 9kHz, VBW = 30kHz, Detector= Quasi-Peak, Trace mode= Max hold, Sweep- auto couple.

For 30MHz to 1000MHz, Set the spectrum analyzer as:

RBW = 100kHz, VBW = 300kHz, Detector= Quasi-Peak, Trace mode= Max hold, Sweep- auto couple.

For above 1GHz, Set the spectrum analyzer as:

RBW = 1MHz, VBW = 1MHz, Detector= Peak, Trace mode= Max hold, Sweep- auto couple.

RBW = 1MHz, VBW = 10Hz, Detector= Average, Trace mode= Max hold, Sweep- auto couple.

4.4. Test Data

PASS

The test results of 9kHz-30MHz was attenuated more than 20dB below the permissible limits, so the results don't record in the report.

Band Edge please refer to clause 6 of the Appendix Test Data.



Test Results (30~1000MHz)

Test Mode: 802.11n (HT40) CH 151
 Power Source: AC 120V, 60Hz for adapter
 Polarization: Vertical
 Temp.(°C)/Hum.(%RH): 24.3°C/46%RH

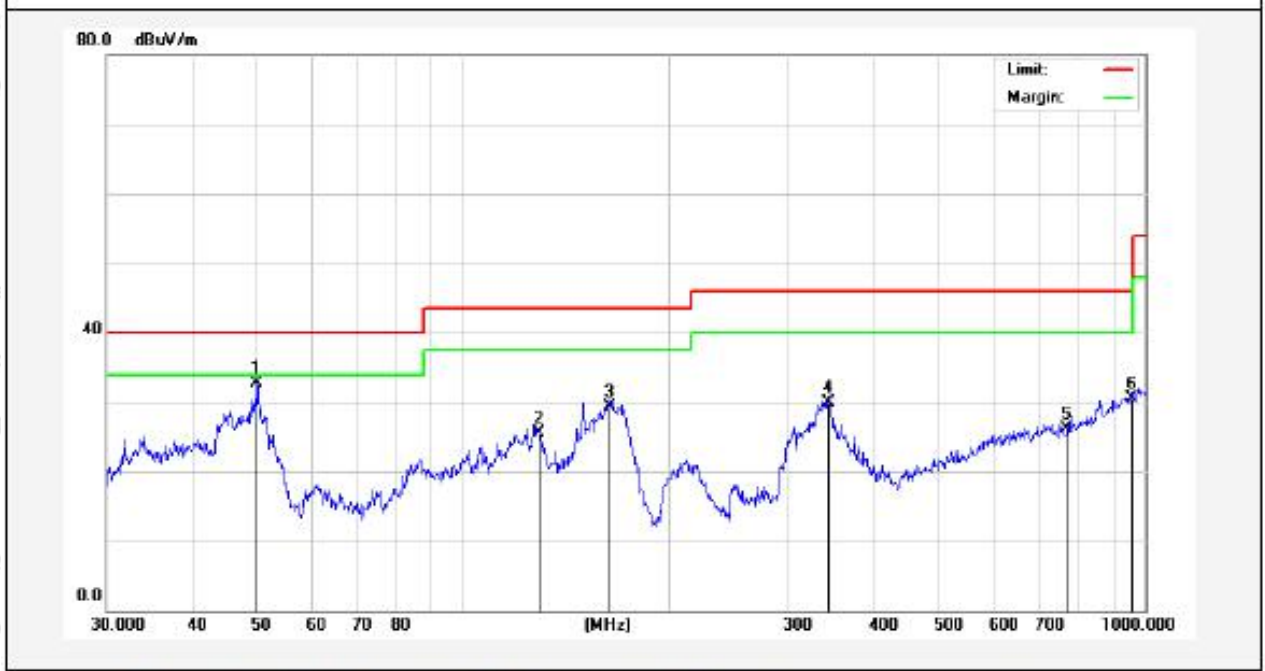

No.	Freq. (MHz)	Reading (dBuV)	Factor (dB/m)	Result (dBuV/m)	Limit (dBuV/m)	Over Limit (dB)	Detector	Height (cm)	degree (deg)	Remark
1	49.8813	47.51	-14.83	32.68	40.00	-7.32	QP	100	360	
2	129.4677	44.73	-19.32	25.41	43.50	-18.09	QP	100	0	
3	164.3300	48.41	-19.16	29.25	43.50	-14.25	QP	100	0	
4	343.1800	42.17	-12.18	29.99	46.00	-16.01	QP	100	360	
5	768.7481	30.89	-4.83	26.06	46.00	-19.94	QP	100	0	
6	955.4379	31.18	-0.72	30.46	46.00	-15.54	QP	100	360	

Test Results (30~1000MHz)

Test Mode: 802.11n (HT40) CH 151
 Power Source: AC 120V, 60Hz for adapter
 Polarization: Horizontal
 Temp.(°C)/Hum.(%RH): 24.3°C/46%RH



No.	Freq. (MHz)	Reading (dBuV)	Factor (dB/m)	Result (dBuV/m)	Limit (dBuV/m)	Over Limit (dB)	Detector	Height (cm)	degree (deg)	Remark
1	238.3102	51.43	-19.07	32.36	46.00	-13.64	QP	100	0	
2	473.8347	42.36	-11.12	31.24	46.00	-14.76	QP	100	360	
3	508.2582	41.36	-9.73	31.63	46.00	-14.37	QP	100	0	
4	691.9867	37.50	-6.13	31.37	46.00	-14.63	QP	100	360	
5	760.7036	36.42	-5.00	31.42	46.00	-14.58	QP	100	0	
6	818.8341	35.88	-3.80	32.08	46.00	-13.92	QP	100	360	

Note: During the test, pre-scan all modes, and found the 802.11n (HT40) CH 151 for which is the worst case, only the worst case is recorded in the report.

Test Results (Above 1000MHz)

Test mode:	IEEE 802.11n (HT40)	Test channel:	Low CH
------------	---------------------	---------------	--------

Peak value:

Frequency (MHz)	Read Level (dBuV)	Antenna Factor (dB/m)	Cable Loss (dB)	Preamp Factor (dB)	Level (dBuV/m)	Limit Line (dBuV/m)	Over Limit (dB)	Pol.
11510.00	41.13	31.98	17.08	33.91	56.28	68.20	-11.92	V
17265.00	39.27	32.65	20.03	34.85	57.10	68.20	-11.10	V
11510.00	39.65	31.98	17.08	33.91	54.80	68.20	-13.40	H
17265.00	41.02	32.65	20.03	34.85	58.85	68.20	-9.35	H

Average value:

Frequency (MHz)	Read Level (dBuV)	Antenna Factor (dB/m)	Cable Loss (dB)	Preamp Factor (dB)	Level (dBuV/m)	Limit Line (dBuV/m)	Over Limit (dB)	Pol.
11510.00	27.69	31.98	17.08	33.91	42.84	54.00	-11.16	V
17265.00	27.52	32.65	20.03	34.85	45.35	54.00	-8.65	V
11510.00	29.12	31.98	17.08	33.91	44.27	54.00	-9.73	H
17265.00	27.33	32.65	20.03	34.85	45.16	54.00	-8.84	H

Test mode:	IEEE 802.11n (HT40)	Test channel:	High CH
------------	---------------------	---------------	---------

Peak value:

Frequency (MHz)	Read Level (dBuV)	Antenna Factor (dB/m)	Cable Loss (dB)	Preamp Factor (dB)	Level (dBuV/m)	Limit Line (dBuV/m)	Over Limit (dB)	Pol.
11590.00	40.64	32.59	18.02	33.92	57.33	68.20	-10.87	V
17385.00	41.02	32.87	20.15	34.88	59.16	68.20	-9.04	V
11590.00	40.75	32.59	18.02	33.92	57.44	68.20	-10.76	H
17385.00	40.20	32.87	20.15	34.88	58.34	68.20	-9.86	H

Average value:

Frequency (MHz)	Read Level (dBuV)	Antenna Factor (dB/m)	Cable Loss (dB)	Preamp Factor (dB)	Level (dBuV/m)	Limit Line (dBuV/m)	Over Limit (dB)	Pol.
11590.00	28.01	32.59	18.02	33.92	44.70	54.00	-9.30	V
17385.00	27.35	32.87	20.15	34.88	45.49	54.00	-8.51	V
11590.00	29.17	32.59	18.02	33.92	45.86	54.00	-8.14	H
17385.00	28.56	32.78	20.12	34.86	46.60	54.00	-7.40	H

Remark:

1. During the test, pre-scan the 802.11a,n(HT20),ac(HT20),n(HT40),ac(HT40),ac(HT80) mode, and found the 802.11ac(HT40) mode is worse case , the report only record this mode.
2. Final Level =Receiver Read level + Antenna Factor + Cable Loss–Preamplifier Factor

5. Maximum Peak Output Power Test

5.1. Test Standard and Limit

Test Standard	FCC Part15 C Section 15.407 (a) (3)
Test Limit	30dBm

5.2. Test Setup

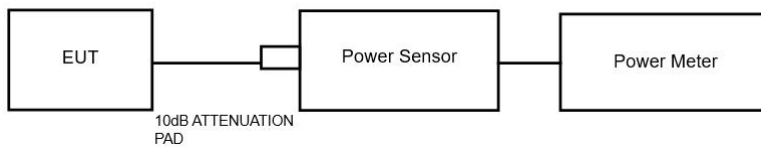

5.3. Test Procedure

1. The Transmitter output (antenna port) was connected to the power meter.
2. Turn on the EUT and power meter and then record the power value.
3. Repeat above procedures on all channels needed to be tested.

Note: The cable loss and attenuator loss were offset into measure device as an amplitude offset.

5.4. Test Data

Pass

Please refer to clause 3 of the Appendix Test Data.

Additional test for duty cycle.

Please refer to clause 1 of the Appendix Test Data.

6. Occupy Bandwidth Test

6.1. Test Standard

Test Standard	FCC Part15 C Section 15.407 (a)(5)&15.407(e)
---------------	----------------------------------------------

6.2. Test Setup

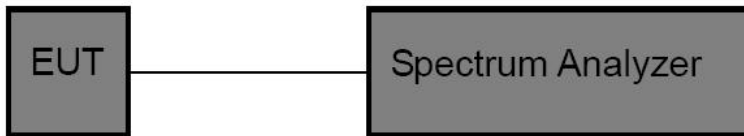

6.3. Test Procedure

1. Place the EUT on the table and set it in the transmitting mode.
2. Remove the antenna from the EUT and then connect a low loss RF cable from the antenna port to the spectrum analyzer.

3. Set the spectrum analyzer as:

26 dB & 99% bandwidth

RBW = approximately 1% of the emission bandwidth;
Set the VBW > RBW;
Detector= Peak
Trace mode= Max hold.
Sweep- auto couple.

6 dB bandwidth

RBW = approximately 1% of the emission bandwidth;
Set the VBW > RBW;
Detector= Peak
Trace mode= Max hold.
Sweep- auto couple.

4. Measure the maximum width of the emission that is 26dB /6dB down from the maximum of the emission. Compare this with the RBW setting of the analyzer.

5. Repeat until all the rest channels are investigated.

6.4. Test Data

Pass

Please refer to clause 2 of the Appendix Test Data.

7. Power Spectral Density Test

7.1. Test Standard and Limit

Test Standard	FCC Part15 C Section 15.407 (a) (3)
Test Limit	30 dBm/500KHz

7.2. Test Setup

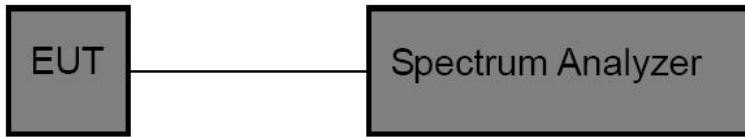

7.3. Test Procedure

For devices operating in the bands 5.15-5.25 GHz, 5.25-5.35 GHz, and 5.47-5.725 GHz, the above procedures make use of 1 MHz RBW to satisfy directly the 1 MHz reference bandwidth specified in § 15.407(a)(5). For devices operating in the band 5.725-5.85 GHz, the rules specify a measurement bandwidth of 500 kHz. Many spectrum analyzers do not have 500 kHz RBW, thus a narrower RBW may need to be used. The rules permit the use of a RBWs less than 1 MHz, or 500 kHz, “provided that the measured power is integrated over the full reference bandwidth” to show the total power over the specified measurement bandwidth (i.e., 1 MHz, or 500 kHz).

1. The EUT is directly connected to the spectrum analyzer;
2. Set RBW =510KHz;
3. Set VBW ≥ 3 RBW=2MHz;
3. Set the span to encompass the entire emissions bandwidth (EBW) of the signal;
5. Detector=RMS;
6. Sweep time= auto couple;
7. Trace mode=max. hold;

7.4. Test Data

Pass

Please refer to clause 4 of the Appendix Test Data.

8. Frequency Stability

8.1. Test Standard and Limit

Test Standard	FCC Part15 Section 15.407(g) &Part2 J Section 2.1055
Test Limit	The frequency tolerance shall be maintained within the band of operation frequency over a temperature variation of 0 degrees to 35 degrees C at normal supply voltage, and for a variation in the primary supply voltage from 85% to 115% of the rated supply voltage at a temperature of 20 degrees C.

8.2. Test Setup

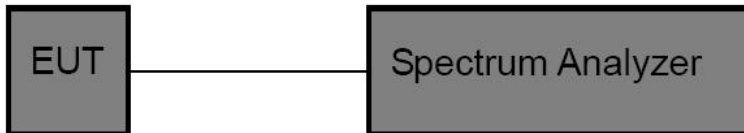

8.3. Test Procedure

The EUT was placed inside the environmental test chamber and powered by nominal AC/DC voltage.

- Turn the EUT on and couple its output to a spectrum analyzer.
- Turn the EUT off and set the chamber to the highest temperature specified.
- Allow sufficient time (approximately 30 min) for the temperature of the chamber to stabilize.
- Repeat step 2 and 3 with the temperature chamber set to the lowest temperature.
- The test chamber was allowed to stabilize at +20 degree C for a minimum of 30 minutes. The supply voltage was then adjusted on the EUT from 85% to 115% and the frequency record.

8.4. Test Data

Pass

Please refer to clause 5 of the Appendix Test Data.

9. Antenna Requirement

9.1. Test Standard and Requirement

Test Standard	FCC Part15 Section 15.203 /15.407
Requirement	<p>1) 15.203 requirement: An intentional radiator shall be designed to ensure that no antenna other than that furnished by the responsible party shall be used with the device. The use of a permanently attached antenna or of an antenna that uses a unique coupling to the intentional radiator, the manufacturer may design the unit so that a broken antenna can be replaced by the user, but the use of a standard antenna jack or electrical connector is prohibited.</p> <p>2) 15.407 requirement: An intentional radiator shall be designed to ensure that no antenna other than that furnished by the responsible party shall be used with the device. The use of a permanently attached antenna or of an antenna that uses a unique coupling to the intentional radiator shall be considered sufficient to comply with the provisions of this section. The manufacturer may design the unit so that a broken antenna can be replaced by the user, but the use of a standard antenna jack or electrical connector is prohibited. This requirement does not apply to carrier current devices or to devices operated under the provisions of §15.211, §15.213, §15.217, §15.219, or §15.221. Further, this requirement does not apply to intentional radiators that must be professionally installed, such as perimeter protection systems and some field disturbance sensors, or to other intentional radiators which, in accordance with §15.31(d), must be measured at the installation site. However, the installer shall be responsible for ensuring that the proper antenna is employed so that the limits in this part are not exceeded.</p>

9.2. Antenna Connected Construction

The antenna is a Ceramic antenna which permanently attached, and the best case gain of the 2.6 dBi. It complies with the standard requirement.

APPENDIX I -- TEST SETUP PHOTOGRAPH

Photo of Power Line Conducted Emission Test



Photo of Radiation Emission Test





APPENDIX II -- EXTERNAL PHOTOGRAPH

Reference to the test report 18220WC10119801.

APPENDIX III -- INTERNAL PHOTOGRAPH

Reference to the test report 18220WC10119801.



APPENDIX IV – Appendix Test Data

