

OTOFIX

Powered by **AUTEL**
 Web: www.otofixtech.com

Quick Reference Guide

OTOFIX D1 Plus D1 Max

Thank you for purchasing this OTOFIX D1 Plus diagnostics tool. This tool is manufactured to a high standard and will provide years of trouble-free performance when used in accordance with these instructions and properly maintained.

OTOFIX D1 Plus

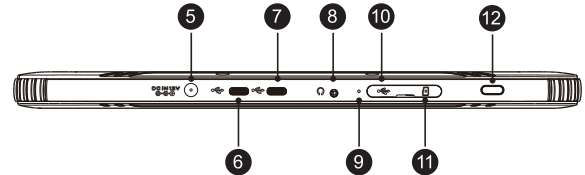
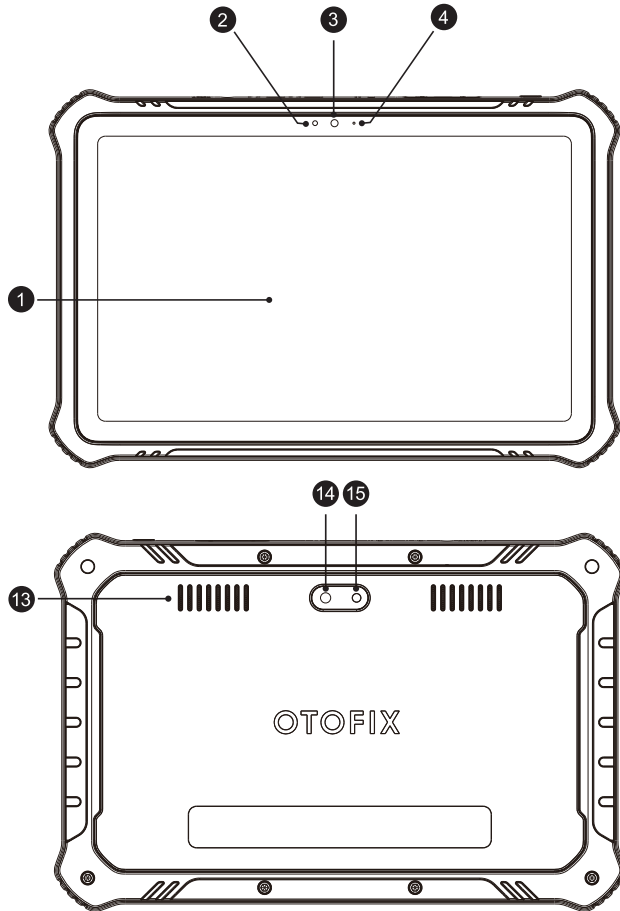

1. 10.4-inch Touchscreen
2. Ambient Light Sensor — detects ambient brightness
3. Front Camera
4. Power LED
5. DC Power Supply Input Port
6. USB Port
7. USB Port
8. Headphone Jack
9. Microphone
10. Mini USB Port
11. SD Card Slot
12. Power/Lock Button — turns the device on & off with long press, or locks the screen with short press
13. Speaker
14. Rear Camera
15. Camera Flash

OTOFIX V1

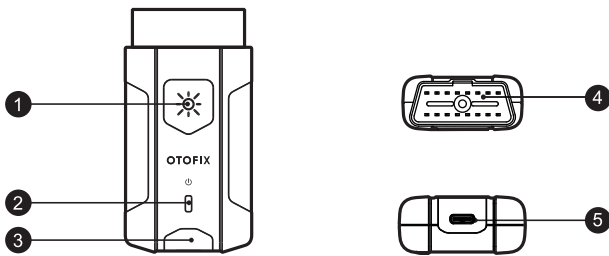

1. Flashlight Button
2. Power LED
3. Vehicle/Connection LED
4. Vehicle Data Connector (16-pin)
5. USB Port

OTOFIX V1 Description

LED	Color	Description
Power LED	Yellow	VCI is powered on and performing self-check.
	Green	VCI is ready for use.
	Flashing Red	Firmware is upgrading.
Vehicle/Connection LED	Green	<ul style="list-style-type: none"> • Solid Green: VCI is connected via USB cable. • Flashing Green: VCI is communicating via USB cable.
	Blue	<ul style="list-style-type: none"> • Solid Blue: VCI is connected via Bluetooth. • Flashing Blue: VCI is communicating via Bluetooth.

Getting Started



IMPORTANT: Before operating or maintaining this unit, please read the Quick Reference Guide carefully, paying extra attention to the safety warnings and precautions. Failure to use this unit correctly may cause damage and/or personal injury and will void the product warranty.

1

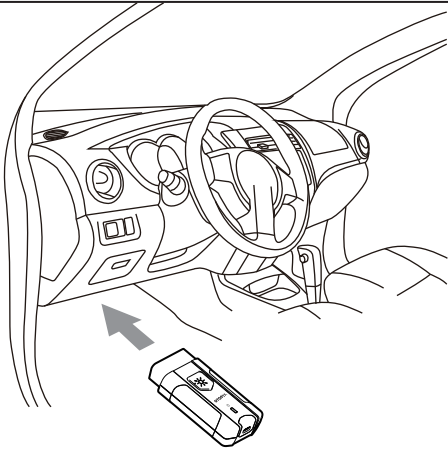

- Insert the V1 into the OBDII port, which is generally located under the vehicle dashboard.

2

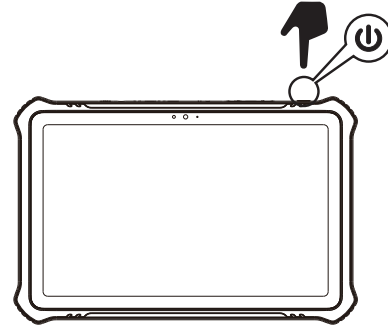

- Long press the **Power/Lock** button to power up the diagnostics tablet. Ensure the tablet has a charged battery or is connected to the supplied DC power supply.

3

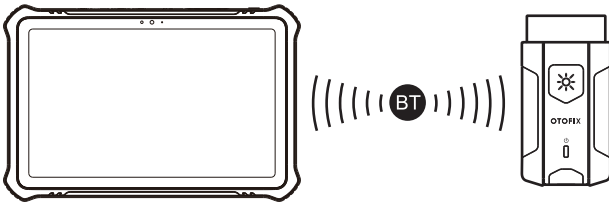

- Pair up the diagnostics tablet with the V1 via Bluetooth to establish a communication link.

NOTE: The diagnostics tablet and the V1 are configured to automatically synchronize with each other on the initial use, therefore, the pairing is not required.

OR

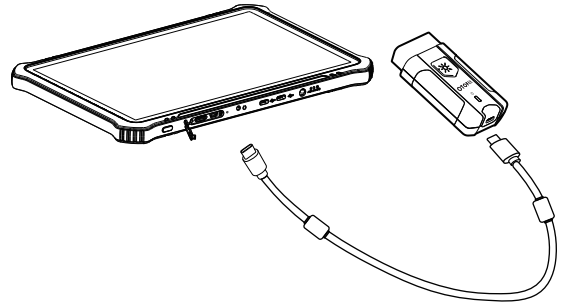

- Pair up the diagnostics tablet with the V1 via USB to establish a communication link.

4

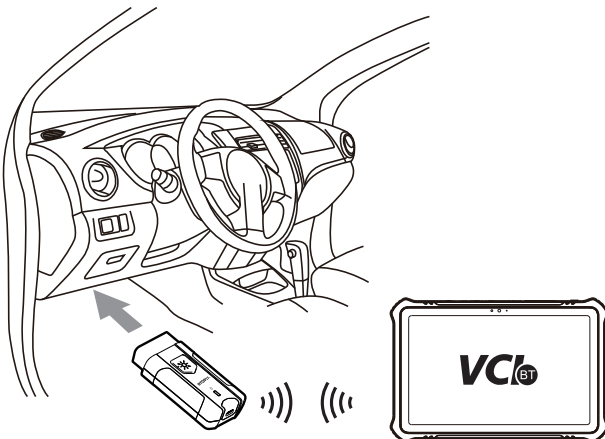

- When the V1 is properly connected to the vehicle and the diagnostics tablet, the VCI status button at the bottom bar on the screen displays a green badge. This indicates your diagnostics tablet is ready to start vehicle diagnosis.

	POSITION	DATE	DESCRIPTION

FCC STATEMENT :

This device complies with Part 15 of the FCC Rules. Operation is subject to the following two conditions:

- (1) This device may not cause harmful interference, and
- (2) This device must accept any interference received, including interference that may cause undesired operation.

Warning: Changes or modifications not expressly approved by the party responsible for compliance could void the user's authority to operate the equipment.

NOTE: This equipment has been tested and found to comply with the limits for a Class B digital device, pursuant to Part 15 of the FCC Rules.

These limits are designed to provide reasonable protection against harmful interference in a residential installation. This equipment generates uses and can radiate radio frequency energy and, if not installed and used in accordance with the instructions, may cause harmful interference to radio communications. However, there is no guarantee that interference will not occur in a particular installation. If this equipment does cause harmful interference to radio or television reception, which can be determined by turning the equipment off and on, the user is encouraged to try to correct the interference by one or more of the following measures:

Reorient or relocate the receiving antenna.

Increase the separation between the equipment and receiver.

Connect the equipment into an outlet on a circuit different from that to which the receiver is connected.

Consult the dealer or an experienced radio/TV technician for help.

RF warning statement:

The device has been evaluated to meet general RF exposure requirement. The device can be used in portable exposure condition without restriction.

IC STATEMENT :

- English: "

This device complies with Industry Canada licence-exempt RSS standard(s). Operation is subject to the following two conditions:

- (1) this device may not cause interference, and
- (2) this device must accept any interference, including interference that may cause undesired operation of the device."

- French:"

Le présent appareil est conforme aux CNR d'Industrie Canada applicables aux appareils radio exempts de licence. L'exploitation est autorisée aux deux conditions suivantes :

- (1) l'appareil n' doit pas produire de brouillage, et
- (2) l'utilisateur de l'appareil doit accepter tout brouillage radioélectrique subi, même si le brouillage est susceptible d'en compromettre le fonctionnement."