

**CV22 Television**  
**Model: CV22**

## WARNINGS

To reduce the risk of electric shock, DO NOT perform any servicing other than what is contained in the operating instructions, unless you are qualified to do so.

This symbol is intended to alert the user of the presence of un-insulated 'dangerous voltage' within the product's enclosure that may be of sufficient magnitude to constitute a risk of electric shock to persons.

This symbol is intended to alert the user of the presence of important operating and maintenance (servicing) instructions in the literature accompanying the appliance.

### NOTE TO CABLE TV INSTALLER

This reminder is provided to call the cable TV system installer's attention to Article 820-40 of the National Electrical Code. The code provides guidelines for proper grounding and, in particular, specifies that the cable ground shall be connected to the grounding system of the building, as close to the point of the cable entry as practical.

## SAFETY INSTRUCTIONS

### INSTRUCTIONS

Be sure to read, follow, and keep these instructions. Heed all the warnings.

### MAINTENANCE AND SERVICING

Servicing is required when the TV has been damaged in any way, such as the power-supply cord or plug is damaged, liquid has been spilled or objects have fallen into the TV, the TV has been exposed to rain or moisture, does not operate normally, or has been dropped.

Never remove the back cover of the TV; this can expose you to high voltage and other hazards. If the TV does not operate properly, unplug it and call an authorized service center.



**CAUTION:** These servicing instructions are for use by qualified service personnel only.

### POWER CORD

Protect the power cord from being walked on or pinched particularly at the plugs, convenience receptacles, and the point where they exit from the apparatus.

To avoid any malfunctions of the unit and unwanted electric shock or fire accidents, please observe the following:

- Hold the plug firmly when connecting or disconnecting the AC power cord to/from an outlet.
- DO NOT connect or disconnect the AC power cord when your hands are wet.
- Keep the AC power cord away from heating appliances.
- Never put any heavy objects on the AC power cord.
- DO NOT attempt to repair or reconstruct the AC power cord in any way under any circumstance.
- Remove dust, dirt, etc. from the plug periodically.
- If the unit has been dropped or otherwise damaged, turn off the power and disconnect the AC power cord from the outlet.
- If smoke, odors or noises are emitting from the unit, disconnect the AC power cord immediately.

### PLACEMENT

Avoid placing the unit in surroundings with:

- Direct sunlight or heat sources, like radiators or ovens.
- High temperature (over 40 C) or high humidity (over 90%).
- Excessive dust.
- Electro-static effect.
- Vibration, impact, or tilted surfaces.

Otherwise the internal parts may be damaged.

### NON-USE PERIODS

- Turn off the power when the unit is not used.
- It should be unplugged from the AC outlet when the unit is idle for a long period of time.

### STACKING

Place the unit in a horizontal place, and DO NOT lay anything heavy on it.

### CONDENSATION

Moisture may condense on the lens if placed in a steamy or very humid room or if moved from a cold environment to a warm one. If moisture appears inside this unit, it may not operate normally. In this case, unplug the power cord and wait for about 1 hour to let it dry.



**CAUTION:** DO NOT defeat the safety of the polarized or grounding-type plug. A polarized plug has two blades with one wider than the other. A grounding-type plug has two plates and a third grounding prong. The wide blade or the third prong is provided for your safety. If the plug does not fit into your outlet, consult an electrician.

Changes or modifications not expressly approved by the party responsible for compliance could void the user's authority to operate the equipment.

## RAIN AND MOISTURE



**WARNING:** To avoid the hazards of fire or electrical shock, DO NOT expose this TV to rain or moisture.

## INSTALLATION

DO NOT block any ventilation openings. DO NOT install near any heat source such as radiators, heat registers, stoves, or other apparatus that produce heat.

## WET LOCATION

The TV SHOULD NOT be exposed to dripping or splashing. Objects filled with liquids, such as vases, SHOULD NOT be placed on the TV.

## OXYGEN ENVIRONMENT



**WARNING:** DO NOT use in an oxygen tent or an oxygen chamber. Such use can cause a fire hazard.

## CLEANING AND DISINFECTION

Clean the exterior of this TV by removing dust with a lint-free cloth.



**CAUTION:** DO NOT use abrasive or chemical cleaning agents. Clean only with a dry cloth.

## PRODUCT MODIFICATION

DO NOT attempt to modify this product in any way without written authorization. Unauthorized modification could void the user's authority to operate this product.

## OVERHEAD FALLING HAZARD



**WARNING:** To prevent injury, this apparatus must be securely attached to the wall in accordance with the installation instructions. TVs can pose a striking hazard when mounted at an elevated position.

## OTHER EQUIPMENT

Use only with the cart, stand, tripod, bracket or table specified by the manufacturer or sold with the TV. Use caution when moving the cart.



**WARNING:** To reduce the chance of fire or electric shock, only utilize the accessories recommended by the manufacturer.

## FCC, Copyright, Disclaimer, and Trademarks

### FCC

This equipment has been tested and found to comply with the limits for a Class B digital device, pursuant to part 15 of the FCC Rules. These limits are designed to provide reasonable protection against harmful interference when the equipment is operated in a residential or commercial installation. If this equipment does cause harmful interference to radio or TV reception, which can be determined by turning the equipment off and on, the user is encouraged to try to correct the interference by one or more of the following measures:

- Reorient or relocate the receiving antenna.
- Increase the separation between the equipment and receiver.
- Connect the equipment into an outlet on a circuit different from that to which the receiver is connected.
- Consult the dealer or an experienced radio/TV technician for help.

### Copyright

Clear View. claims proprietary right to the material disclosed in this user manual. This manual is issued for user information only and may not be used to manufacture anything shown herein. Copyright 2009 by Clear View. All rights reserved.

### Disclaimer

The author and publisher have used their best efforts in preparing this manual. Clear View. makes no representation or warranties with respect to the accuracy or completeness of the contents of this manual and specifically disclaim any implied warranties or merchantability or fitness for any particular purpose and shall in no event be liable for any loss of profit or any other damages. The information contained herein is believed to be accurate, but is not warranted, and is subject to change without notice or obligation.

### Trademarks

Manufactured under license from Dolby Laboratories. Dolby and the double-D symbol are trademarks of Dolby Laboratories. All other brand names and product names used in this manual are trademarks, registered trademarks, or trade names of their respective holder.

# CONTROLS

## Left Side Panel

1. **TV/AV button**  
Selects the video mode.
2. **CC button**  
Set the caption function.
3. **CH ▲/▼ buttons**  
Selects a program or a menu item.
4. **VOL ▲/▼ buttons**  
Adjusts the volume. Adjusts menu settings.
5. **POWER button**  
Switches TV set on or off.

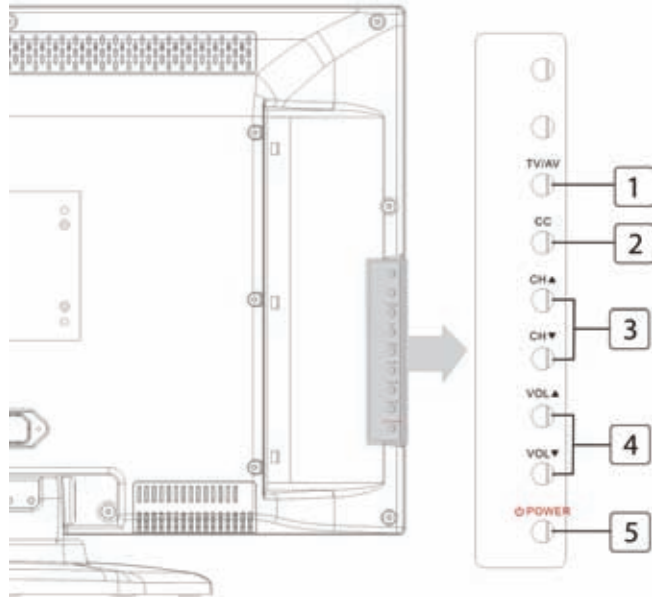

## Front Panel

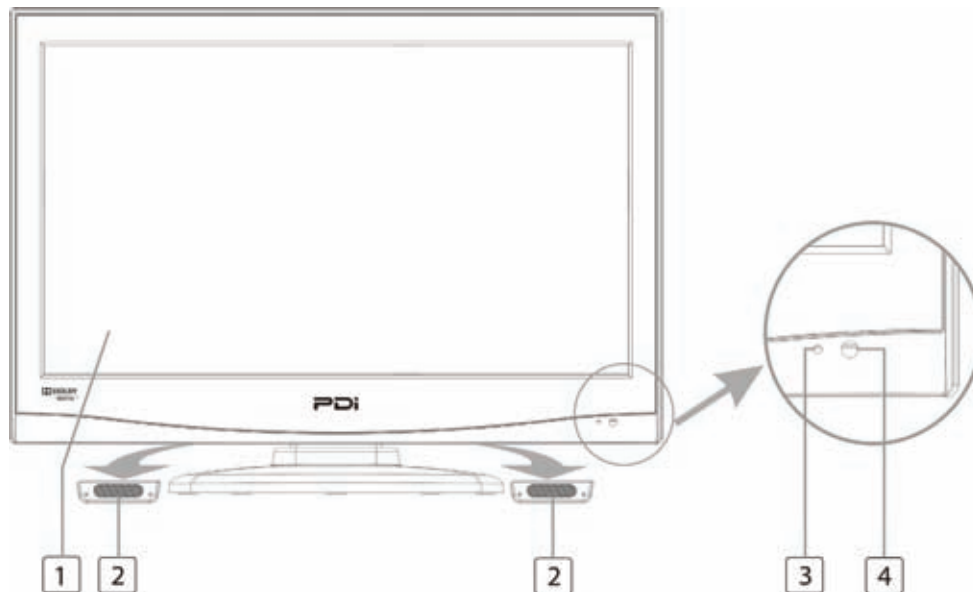

1. **Color TFT screen**
2. **Speakers**
3. **Power Indicator**  
Illuminates in red when the TV is off.  
Illuminates in green when the TV is switched on.
4. **Remote Sensor**  
Accepts the IR signal of remote controller.

## Rear Panel

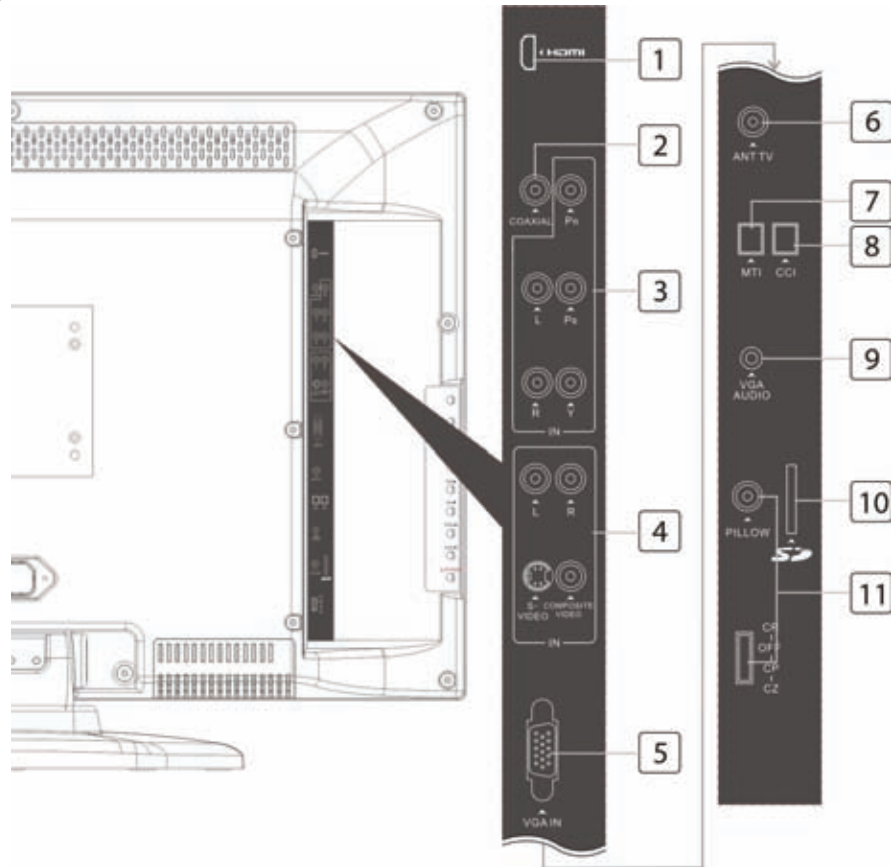

### 1. HDMI Jack

Connection for HDMI device.

### 2. COAXIAL Jack

Provides a digital audio output signal for connection to an external digital audio device.

### 3. COMPONENT IN

Connect the COMPONENT audio/video output sockets of the DVD to the COMPONENT audio/video input sockets of the set.

### 4. COMPOSITE/S-VIDEO IN

Connect the Video/S-VIDEO outputs of external equipment to this input.  
Connect the audio cable from the external equipment or S-VIDEO VCR to the L & R IN of the set.

### 5. VGA IN

Connection to the video output jack on your PC.

### 6. ANT TV Jack

Connection to TV antenna.

### 7. CCI

Communication port.

### 8. MTI

Connect to MTI device.

Note: CCI and MTI can not be connected to the external public network, and can be used by the technician only.

### 9. VGA AUDIO IN

Connect the audio cable from the PC to the AUDIO IN of the set.

### 10. SD Card Slot

Firmware upgrading purpose.

### 11. PILLOW

Pillow speaker port.

Use the switch to select correct voltage.

CZ: Zenith Compatible (+14V)

CP: Philips Compatible (+5V)

CR: RCA Compatible (-5V)

Off: Pillow port disable (0V)

#### NOTES:

Moving this switch changes the voltage supplied to the pillow speaker.

Make sure it is set correctly BEFORE plugging in the pillow speaker jumper cable.

Failure to do so WILL RESULT IN THE PILLOW SPEAKER BEING OVERDRIVEN AND POSSIBLE DAMAGE TO THE PILLOW SPEAKER.

## Wall Mounting With **PD168-005**? Standard Wall Bracket (Not supplied with TV)

1. Refer to Figure 1. Select a location on the wall approximately 5 inches below the ceiling.  
**NOTE:** *DO NOT* locate AC, Across-Room Wiring, and CATV Signal outlets below the Wall Bracket's location as it will cause clearance issues and interfere with the TV's cabinet when mounted to the bracket.  
Position the Wall Bracket and locate two mounting holes. Secure the bracket to the wall (mounting hardware is not included).
2. Refer to Figure 2. The TV can be mounted with 4 mm hardware (not provided) using a compatible mount. Position the Back Mount on the LCD TV cabinet. Attach with four M4 x 6mm screws provided with the mount.
3. Mate the Back Mount to the Wall Bracket making sure the pivot pins are retained in the "U" shaped slot. Using the pilfer security driver packed with the hardware, secure with two 10x32 pilfer screws.
4. Connect the AC power cord, Pillow Speaker Jumper Cable, and CATV Coax Cable.
5. The TV's tilt can be adjusted by loosening both Pilfer Screws, adjusting tilt, and then tightening the screws.

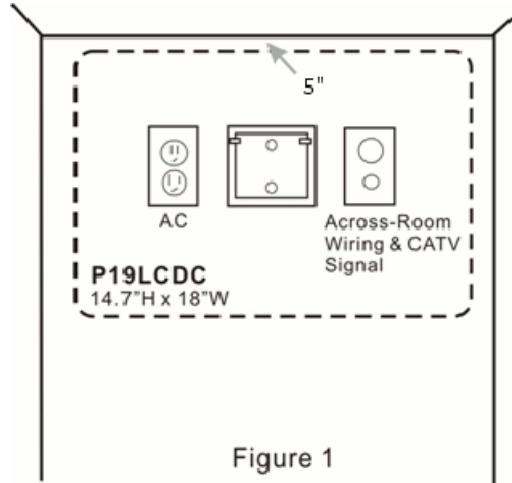

**Comment [d1]:** Remove the P19LCDC Reference

**Figure 2**

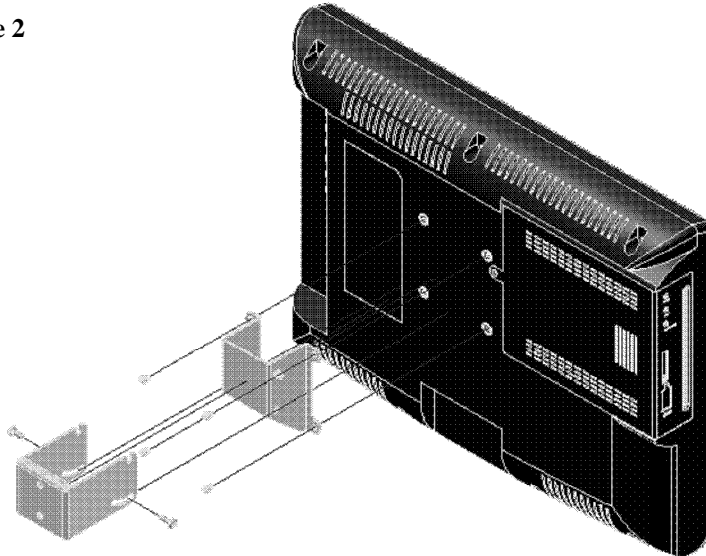

## Across Room Wiring

A 1/4" stereo style pillow speaker (pendant control) jack is located on the TV's connector panel.

This TV is designed to work with either a digital pillow speaker that generates digital-style control codes or a single-button analog (switch-style) pillow speaker. A rear panel mounted switch allows use of different brands of pillow speakers and supports Zenith, Philips, and RCA compatible pillow speakers.

To Wall Plate  
Pillow Speaker Connection

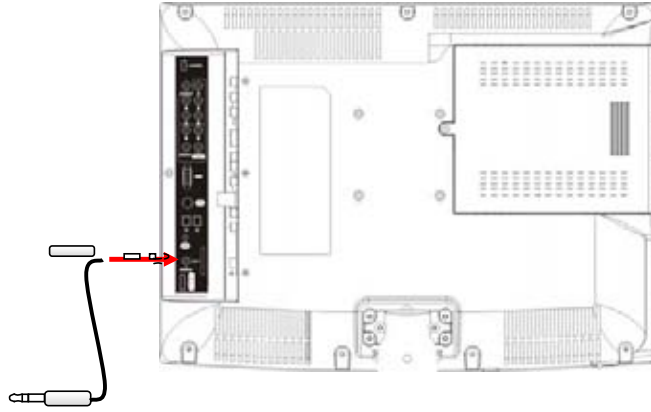

**WARNING:** DO NOT connect the pillow speaker circuit Common to earth ground. Grounding of the Common will defeat the isolation circuitry of the TV and possibly expose the patient to harmful shock currents should a wiring fault occur.

**NOTE:** A Jumper Cable is NOT supplied with the TV and must be ordered separately.

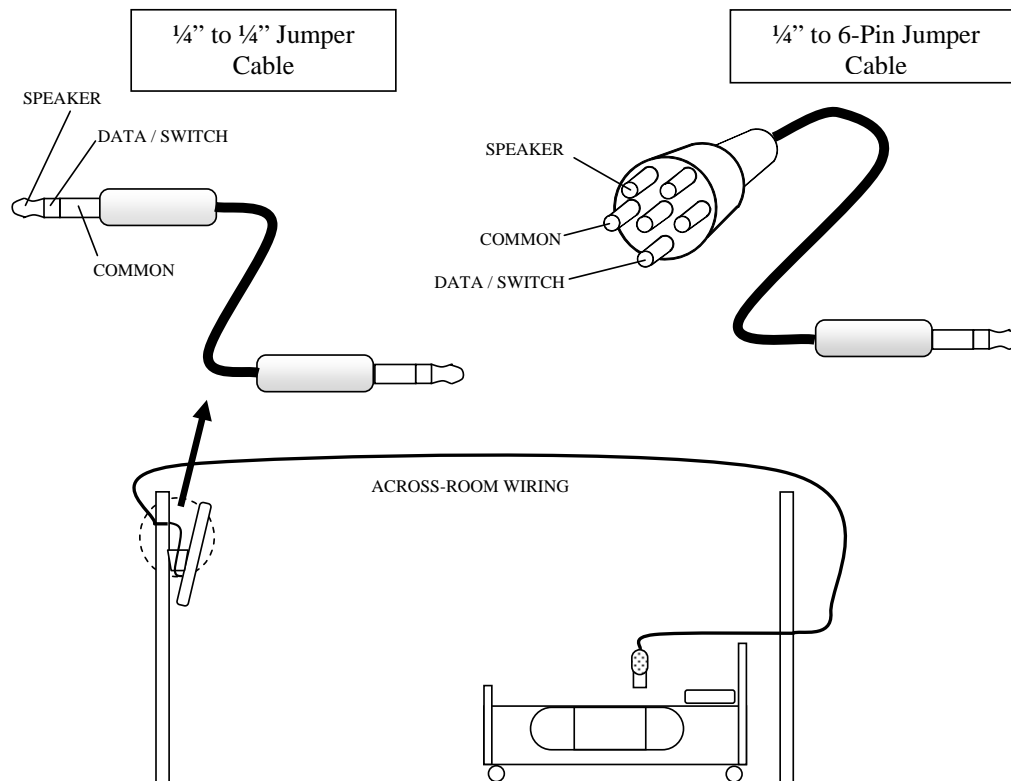

## Antenna “ANT” Connection

An “F” style jack is located on the TV’s connector panel.



**CAUTION:** Some hospital cable systems provide power voltage on the coaxial cable. This TV is **NOT** designed to be powered via a coaxial cable. DO NOT connect to a powered coaxial cable. Damage will result to the TV.

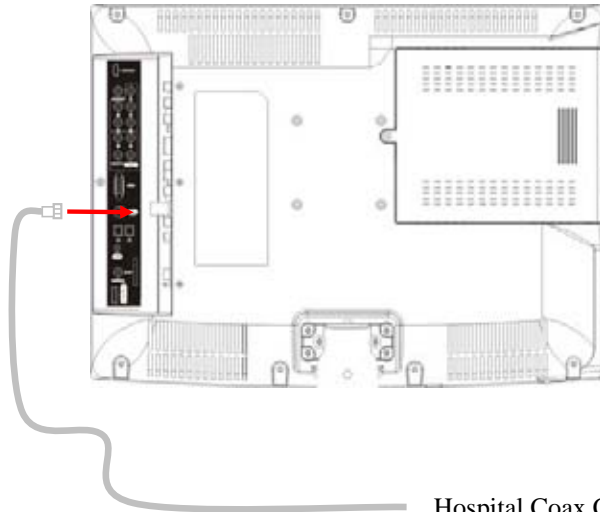

## AC Power

A right-angled AC power cord is attached to each TV.

Connect the AC power cord to a powered outlet.

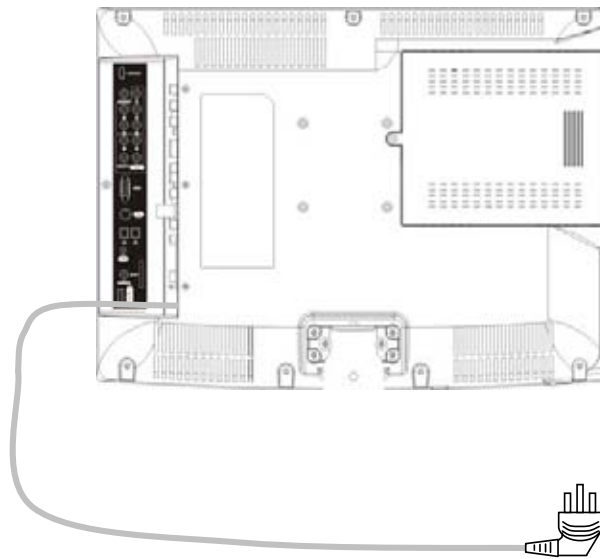



## Product Accessories

(Not Included with TV)

75mm VESA Wall Mount	PD168-005	Patient Remote Control (*For TV's without DVD module)	PD108-421
Programming Remote Control	PD108-420	¼" to 6-Pin Jumper Cable	PD106-416
Patient Remote Control (*Remote comes with DVD module)	PD108-427	¼" to ¼" Jumper Cable	PD106-417

## Programming

The remote control (PD108-420) is used to perform all setup operations for the TV.

**NOTE:** The following instructions assume you have correctly mounted the TV, wired an external pillow speaker, connected an RF coax cable signal, and powered the TV on.

## Channels

The TV offers three different programmable Service Levels (Free, Basic, and Premium). Only one Service Level is available at a time.



1. Press the SETUP button on the remote control.
2. Press ▲ or ▼ to highlight Channels.
3. Press ▶ to enter the Channels sub-menu.

## Signal

Four different tuning types are available depending upon the healthcare facility's signal type. Selection of the correct signal type is required for the TV to recognize all possible channels and before any channel programming can begin.

1. From the Channels menu, press ▲ or ▼ to highlight Signal.
2. Press ◀ or ▶ to select Air, Cable STD, Cable IRC, or Cable HRC.  
**NOTE:** Most hospitals use the Cable STD signal style.
3. Go to Auto Program on the next page.

## Auto Program

The TV automatically scans each available channel for activity. Channels that display activity are memorized into the selected Service Level.

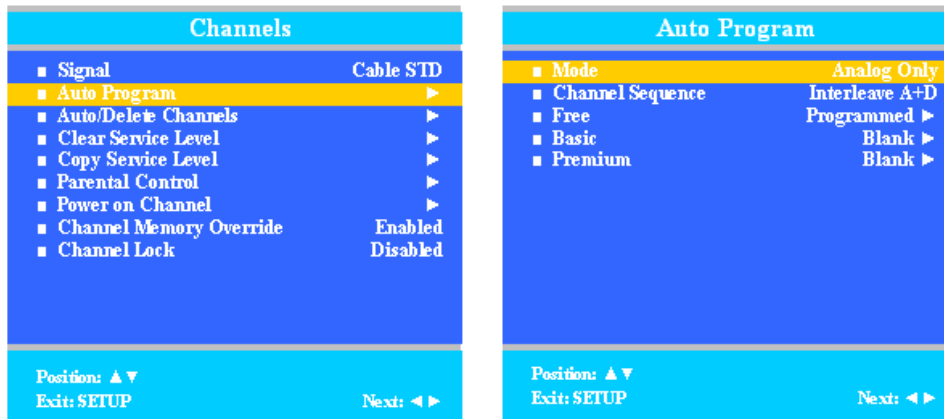

1. After setting Signal, press ▲ or ▼ to highlight Auto Program.
2. Press ▶ to select it.
3. On Mode, press ◀ or ▶ to select the scope of channel scanning.
  - Analog Only: TV searches for analog channels only.
  - Digital Only: TV searches for digital channels only.
  - Analog and Digital: TV searches for both analog and digital channels.
4. Press ▲ or ▼ to highlight Channel Sequence.
5. Press ◀ or ▶ to select the Channel Sequence in which the channels are displayed.
  - Interleave A+D: Channels are displayed in the order of channel number.
  - All A then D: All digital channels are displayed after all analog channels.
6. Press ▲ or ▼ to highlight the Service Level (Free, Basic, or Premium) you wish to program. The menu displays the current programming status of each level as either Programmed or Blank.  
**NOTE:** A programmed Service Level can also be reprogrammed if desired.
7. Press ▶ to start auto programming.
8. A confirmation menu will appear before proceeding. Press ▲ to start auto programming. Press ▼ to cancel the operation. The TV now will search all available channels. Auto programming requires several minutes to complete.  
**NOTE:** Digital channel auto programming may take longer than 10 minutes to complete.
9. Press the SETUP button to return to normal TV viewing.

## Cloning and Firmware

Cloning allows quick programming of a TV. You can also upload to the latest version of firmware. Click on the Firmware and Driver link and follow the on-screen instructions to find your TV model.