

**TABLE OF CONTENTS**

1. INTRODUCTION	3	4.4.19 Jam Detect	13
2. SPECIFICATIONS	3	4.4.20 Latchkey	14
2.1 General Data	3	4.4.21 "Not Active"	14
2.2 RF Section	3	4.4.23 Duress	14
2.3 Electrical Data	3	4.4.24 Piezo Siren	14
2.4 Communication	4	4.4.25 Reset Option	14
2.5 Physical Properties	4	4.4.26 Tamper Option	14
3. INSTALLATION	4	4.4.27 Siren On Line	14
3.1 Unpacking the Equipment	4	4.4.28 Memory Prompt	14
3.2 Supplying Power to the Unit	4	4.4.29 Disarm Option	14
3.3 System Planning & Programming	4	4.4.30 Bell/Rep. Option	14
3.4 Mounting	4	4.4.31 Low-Bat Ack	14
3.5 Wiring	4	4.4.32 Screen Saver	14
3.6 Backup Battery Insertion	6	4.4.33 Confirm Alarm	14
3.7 Optional GSM Module Mounting	7	4.4.34 AC FAIL REP	14
3.8 Power Cable Connection	7	4.4.36 User Permission	15
3.9 Control Panel Final Closure	7	4.4.39 Key Zones Options (Optional)	15
4. PROGRAMMING	8	4.5 DEFINING COMMUNICATION PARAMETERS	17
4.1 INTRODUCTION	8	Preliminary Guidance	17
4.1.1 General Guidance	8	4.5.1 PSTN / GSM (Fig. 4.5 Detail A)	17
4.1.2 Entering an Invalid Installer Code	8	4.5.2 GPRS / BB [Fig. 4.5 Detail B]	17
4.1.3 Installer's Menu	8	4.5.3 C.S. Reporting (Fig. 4.5 Detail C)	18
4.1.4 Setting a New Installer Code	8	4.5.4 Private Report (Fig. 4.5 Detail D)	19
4.1.5 Setting a New Installer Code in PowerMaxExpress that has 2 Installer Codes	8	4.6 GSM Auto Detection	23
4.2 ENROLLING WIRELESS DEVICES AND KEYFOB TRANSMITTERS	9	4.7 BBA Auto Detection	23
4.2.1 General Guidance	9	4.9 DEFINE CUSTOM	24
4.2.2 Enrolling Type	9	4.10 DIAGNOSTIC TEST	24
4.2.3 Enroll/Delete Sensors	9	4.11 USER FUNCTIONS	25
4.2.4 Enroll/Delete Keyfob Transmitters	9	4.12 RETRIEVING FACTORY DEFAULTS	25
4.2.5 Enroll/Delete Wireless Commander	9	4.13 SERIAL NUMBER	25
4.2.6 Enroll/Delete 2-Way Keypad	9	4.14 CALLING UPLOAD/DOWNLOAD SERVER	25
4.2.7 Enroll/Delete Wireless Siren	9	4.15 ENABLING/DISABLING PARTITIONS	26
4.3 DEFINING ZONE TYPES, NAMES, CHIME ZONES & PARTITION	11	4.16 WALK-TEST	26
4.4 DEFINING CONTROL PANEL PARAMETERS	12	5. TESTING PROCEDURES	27
4.4.1 Preliminary Guidance	12	5.1 Preparations	27
4.4.2 Entry Delays 1&2	12	5.2 Diagnostic Test	27
4.4.3 Exit Delay	12	5.3 Keyfob Transmitter Test	27
4.4.4 Bell Time	12	5.4 Emergency Transmitter Test	27
4.4.5 Abort Time	12	6. MAINTENANCE	27
4.4.6 Alarm Cancel	12	6.1 Dismounting the Control Panel	27
4.4.7 Quick Arm	12	6.2 Replacing the Backup Battery	27
4.4.8 Bypass	12	6.3 Fuse Replacement	27
4.4.9 Exit Mode	13	6.4 Replacing/Relocating Detectors	27
4.4.10 Piezo Beeps	13	7. READING THE EVENT LOG	27
4.4.11 Trouble Beeps	13	APPENDIX A. Detector Deployment & Transmitter Assignments	29
4.4.12 Panic Alarm	13	A1. Detector Deployment Plan	29
4.4.13 Swinger Stop	13	A2. Keyfob Transmitter List	29
4.4.14 Cross Zoning	13	A3. Emergency Transmitter List	30
4.4.15 Supervision	13	A4. Non-Alarm Transmitter List	30
4.4.16 NOT READY	13		
4.4.17 AUX Button A	13		
4.4.18 AUX Button B 2-W-KF	13		

APPENDIX B. Event Codes	31	C6. Interior Zone.....	33
Contact ID Event Codes	31	C7. Interior Follower Zones	33
SIA Event Codes.....	31	C8. Non-Alarm Zones.....	33
4/2 Event Codes.....	31	C9. Perimeter Zones.....	33
Understanding the Scancom Reporting Protocol Data Format	32	C10. Perimeter Follower Zones.....	33
		C11. 24-Hour Zones	33
APPENDIX C. Programmable Zone Types	33	APPENDIX D. PowerMaxExpress Compatible Devices	34
C1. Delay Zones.....	33	D1. PowerMaxExpress Compatible Detectors	34
C2. Emergency Zones.....	33	D2. PowerMaxExpress Compatible Transmitters... ..	34
C3. Fire Zones	33	D3. PowerMaxExpress Compatible WL Siren.....	35
C4. Flood Zone	33		
C5. Gas Zone.....	33		

MESSAGE TO THE INSTALLER

The PowerMaxExpress control panel is supplied with 2 instruction manuals:

- **Installer Guide** (this manual - for your exclusive use)
- **User's Guide** (for your use during installation only - Must be handed over to the master user after testing the system).

Appendices A.1 and A.2 will help you prepare an installation plan. Please take time to fill out the forms - your job will become much easier and confusion will be prevented. Filling out the forms will also help you create a list of detectors and transmitters that must be obtained for the particular application. Compatible detectors and transmitters are listed and described briefly in Appendix D.

Remember - it is advisable to power up the control panel temporarily after unpacking and program it on the work bench, in accordance with the installation plan.

The programming flow charts in the programming section show all options available for each parameter. Factory defaults are marked with a dark box to their right, and other options (that can be selected instead) are marked by clear boxes. This method allows you to put a checkmark in the appropriate clear box whenever you deviate from the factory defaults.

Most of the programming section paragraph numbers correlate with the programming menu numbers. For example, paragraph 4.4.19 describes the "Jam detect", that exists in menu 4 (define panel), sub-menu 19 (Jam detect).

Although setting the correct time and date is one of the user tasks, we recommend that you set the time and date in the course of programming. Access to the "User Settings" for the installer is possible through item 10 on the installer's menu or through the user menu (see User's manual section 7).

After programming, proceed to install the system as detailed in the Installation Instructions, from paragraph 3.4 onward.

The installer should verify line seizure. Be aware of other phone line services such as DSL. If DSL service is present on the phone line, you must install a filter. It is suggested to use the DSL alarm filter model Z-A431PJ31X manufactured by Excelsus Technologies, or equivalent. This filter simply plugs into the RJ-31X jack and allows alarm reporting without breaking the internet connection.

1. INTRODUCTION

The PowerMaxExpress is a user and installer-friendly, 29-zone fully-supervised wireless control system.

IMPORTANT NOTE: Partitioning refers only to purchased control panels that support the partitioning feature.

The PowerMaxExpress includes an optional partition feature. Partitioning allows you to have up to four independently controllable areas with different user codes assigned to each partition. A partition can be armed or disarmed regardless of the status of the other partitions within the system. For example, you can define the garage as partition 1, the basement as partition 2, the house as partition 3 and a safe as partition 4. Since each partition is independent of other partitions, you can arm or disarm each partition as desired without altering the states of the other partitions. Therefore, while arming or disarming your home this will not interfere with the safe that you desire to arm most of the time.

2. SPECIFICATIONS

2.1 General Data

Zones Number: 28 wireless zones, 1 hardwired input.

Hardwired Zone Requirements: 2.2 k Ω E.O.L. resistance (max. resistance of wires 220 Ω).

Zone Types: Interior follower, interior, perimeter, perimeter follower, delay 1, delay 2, 24h silent, 24h audible, fire, non-alarm, emergency, gas, flood, temperature and home/delay.

User Codes: 8 codes, 4 digits each (9999 different combinations). Code 0000 is not allowed.

Control Facilities:

- Integral keypad
- PowerCode / Code-Secure™ hand-held transmitters.
- One way / two way keypads.
- SMS commands via optional GSM/GPRS module.
- Remote control by telephone.

Display: Single line, 16-character LCD.

Arming Modes: AWAY, HOME, AWAY-INSTANT, HOME-INSTANT, LATCHKEY, FORCED, BYPASS.

Alarm inhibited during a single arming period (swinger stop) after: 1, 2, 3, alarm/tamper/fault, or not inhibited (programmable / selectable).

Alarm Types: Silent alarm, siren alarm (future option) or sounder (internal) alarm, in accordance with zone attributes.

Siren Signals: Continuous (intrusion / 24 hours / panic); triple pulse - pause - triple pulse... (fire).

Siren (bell) Timeout: Programmable (4 min. by default).

Internal Sounder Output: At least 85 dBA at 10 ft (3 m).

Supervision: Programmable time frame for inactivity alert

Special Functions:

- Chime zones
- Diagnostic test and event log.
- Local and Remote Programming over Telephone, GSM /GPRS connections.
- Calling for help by using an emergency transmitter.
- Tracking inactivity of elderly, physically handicapped and infirm people.

Data Retrieval: Alarm memory, trouble, event log.

The system is designed to function in an appealing way to the user and also offers features that make installers' life easier than ever before:

EASY TO MAINTAIN

- Alarm memory and trouble data are displayed upon request.
- Diagnostic test provides visual and audible indication of the signal level of each detector.
- Remote control from distant telephones.
- Event log stores and displays information.
- Upload / download from distant computer via telephone line or cellular modem.

QUICK PROGRAMMING

- Simple programming logic, fully menu driven.
- Multiple-choice selection of options for each parameter.
- Unequivocal visual prompts.
- Installer access to the user menu.

Real Time Clock (RTC): The control panel keeps and displays time and date. This feature is also used for the log file by providing the date and time of each event.

Compliance with U.S. Standards:

Meets FCC 47 Part 15 and Part 68 requirements.

Compliance with European CE Standards:

EN 50082-1, EN301489-3,7, EN6100-4-6, EN60950, EN300220, EN50130-4, EN50130-5, EN50131-3

The PowerMaxExpress is compatible with the RTTE requirements - Directive 1999/5/EC of the European Parliament and of the Council of 9 March 1999.

According to the European standard EN50131-1, the PowerMaxExpress security grading is 2 - "low to medium risk" and environmental classification is II - "indoor general" and the power supply type is A.

GSM standards:

Europe : Complies with CE standards 3GPP TS 51.010-1, EN 301 511, EN 50361, EN301489-7

USA: FCC 47 Part 22 (GSM850) and Part 24 (GSM 1900).

EMC standard: FCC 47 Part 15.

SAR standards: FCC rule 2.1093, FCC Docket 96-326 & Supplement C to OET Bulletin 65

2.2 RF Section

Operating Frequencies (MHz): 315 (in USA & Canada), 433, 868.95 or other UHF channel per local requirement in the country of use.

Receiver Type: Super-heterodyne, fixed frequency

Receiver Range: 600 ft (180 m) in open space

Antenna Type: Spatial diversity

Coding: PowerCode and/or CodeSecure™

2.3 Electrical Data

External AC/AC adapter:

- **Europe:** 230VAC 50Hz input, 9VAC 700mA output.
- **USA:** 120VAC 60Hz input, 9VAC 1000mA output.

Current Drain: Approx. 70 mA standby, 1600 mA peak at full load.

Minimum battery voltage: 4.8V

Backup Battery Pack: 4.8V 1300 mAh, rechargeable NiMH battery pack, p/n GP130AAM44MX, manufactured by GP – Backup period of 16 hours.

Maximum battery recharge time: 72 hours

Battery Test: Once every 10 seconds.

2.4 Communication

Built-in Modem: 300 baud, Bell 103 protocol

Data Transfer to Local Computer: Via RS232 serial port

Report Destinations: 2 central stations, 4 private telephones.

Reporting Format Options: SIA, Pulse 4/2 1900/1400 Hz, Pulse 4/2 1800/2300 Hz, Contact ID, Scancom.

Pulse Rate: 10, 20, 33 and 40 pps - programmable

Message to Private Phones: Tone

Ring Detection: The unit does not support ring detection without DC voltage present on the telephone lines.

2.5 Physical Properties

Operating Temp. Range: 14°F to 120°F (-10°C to 49°C)

Storage Temp. Range: -4°F to 140°F (-20°C to 60°C)

Humidity: 85% relative humidity, @ 30°C (86°F)

Size: 193 x 178 x 50 mm (7-5/8 x 7 x 2 in.)

Weight: 658g (23 Oz) (with battery)

Color: White

3. INSTALLATION

3.1 Unpacking the Equipment

Open the cardboard packing box and check whether all items have been included. If you find out that an item is missing, contact your vendor or dealer immediately.

3.2 Supplying Power to the Unit

Connect power to the PowerMaxExpress temporarily (see figure 3.7). Alternatively, you may power up from the backup battery, as shown in figure 3.3.

Disregard any “trouble” indications pertaining to lack of battery or lack of telephone line connection.

3.3 System Planning & Programming

It pays to plan ahead - use the tables in appendices A and B at the end of this guide to register the intended location of each detector, the holder and assignment of each transmitter.

Gather up all transmitters and detectors used in the system and mark each one in accordance with your deployment plan.

Program the system now as instructed in the programming section.

3.4 Mounting

Required tool: Philips screwdriver #2.

PowerMaxExpress mounting process is shown in figure 3.1 - 3.8.

3.5 Wiring

Required tools: Cutter and slotted screwdriver - 3 mm blade.

PowerMaxExpress wiring is shown in figure 3.2.

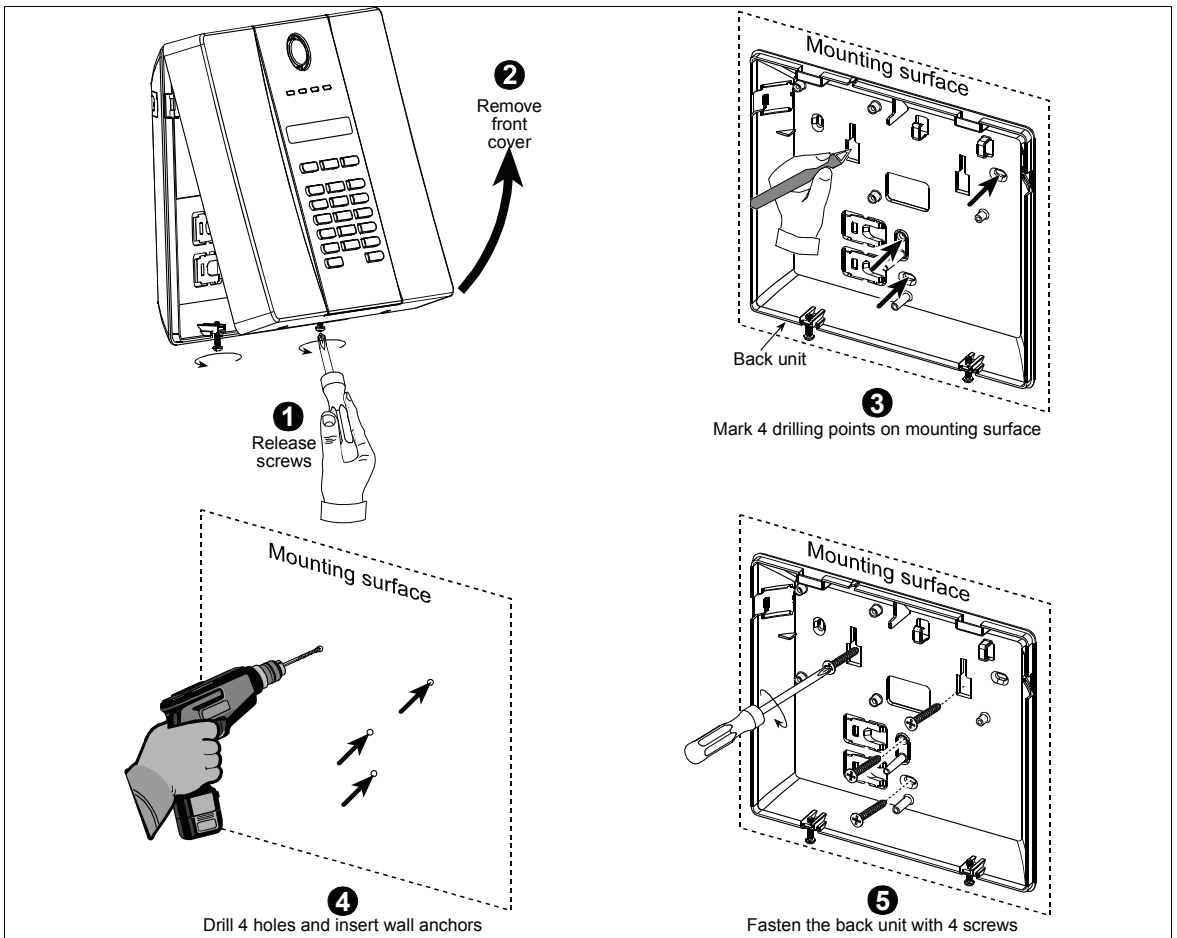
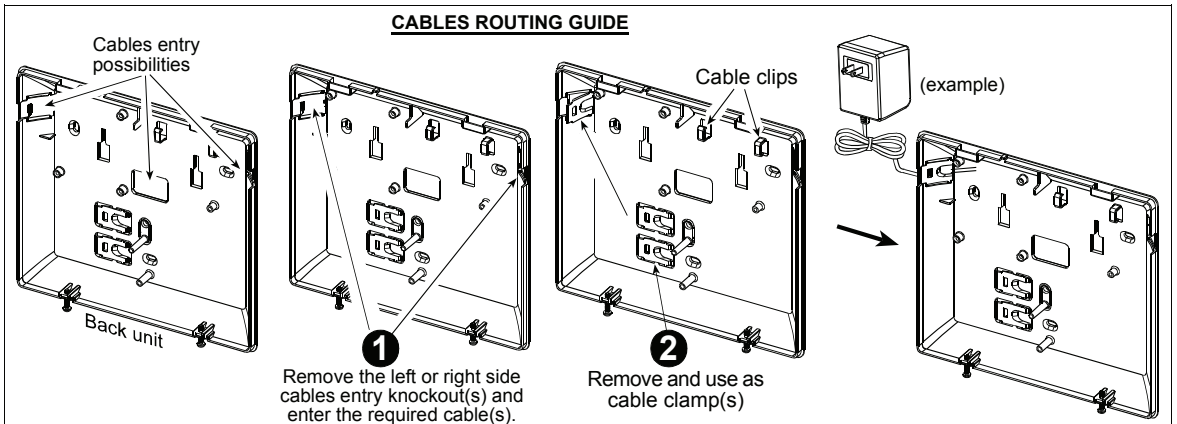
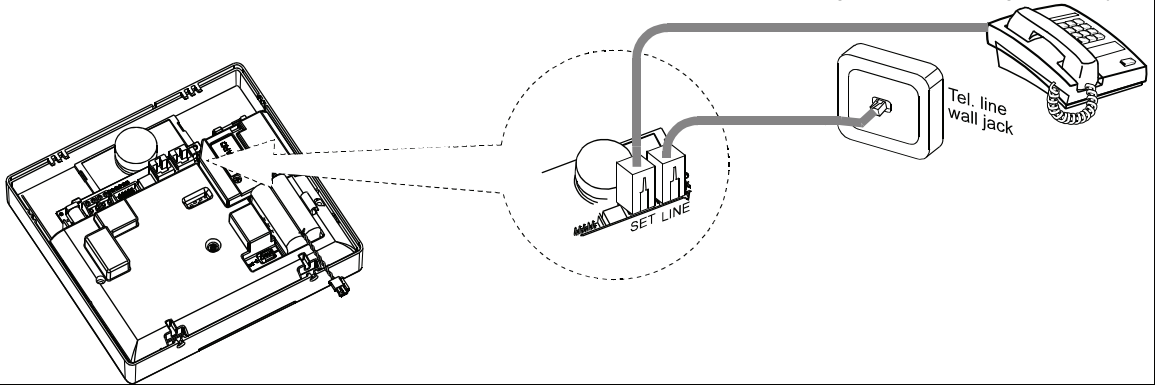

Figure 3.1 – Back Unit Mounting



PHONE WIRING

Connect telephone cable to SET connector and telephone line cable to LINE connector (through the desired wiring cable entry).



PHONE WIRING IN NORTH AMERICA

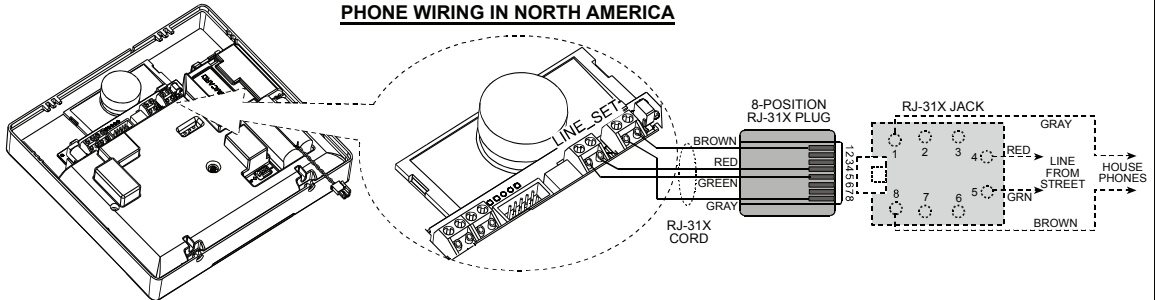

ZONE & EXTERNAL SIREN WIRING

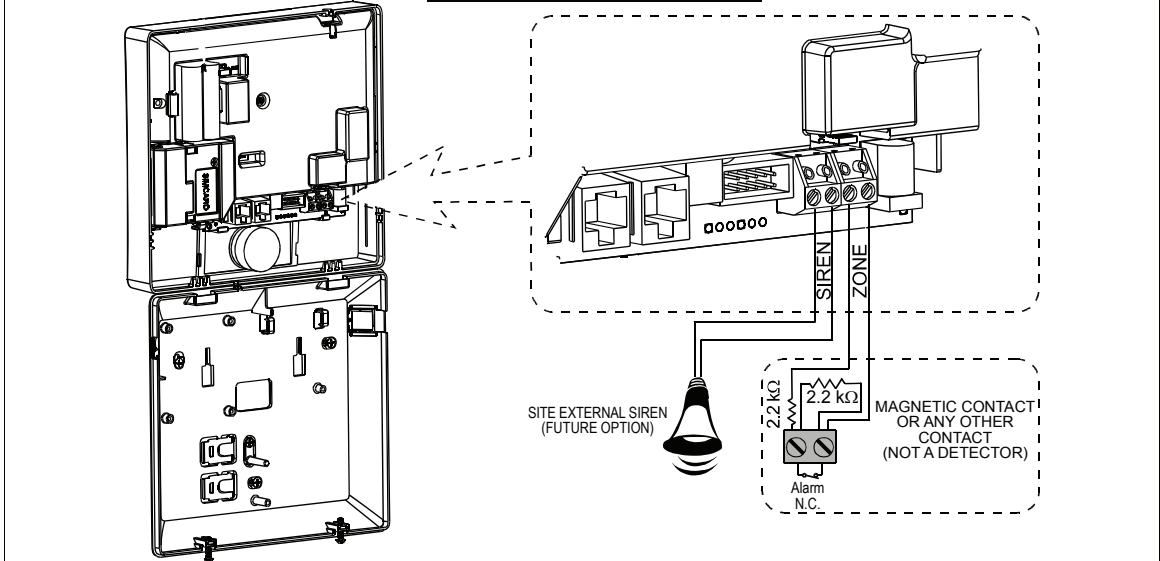

Figure 3.2 - Wiring

WARNING! When plugging SIREN & ZONE terminals back into place, be sure to align them carefully with the pins on the PCB. Misaligned or reverse insertion of terminals may damage internal PowerMaxExpress circuits!

3.6 Backup Battery Insertion

Connect battery pack as shown in the next drawing.

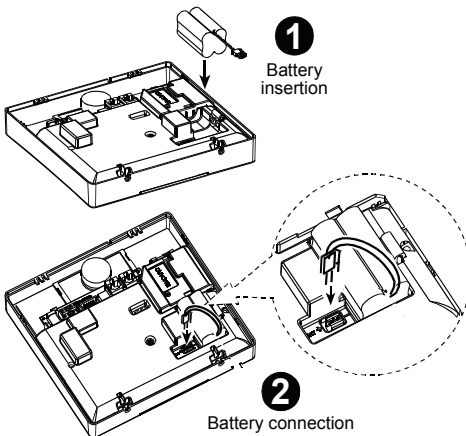

Figure 3.3 - Battery Insertion

3.7 Optional GSM Module Mounting

Note: The GSM module is used with an internal antenna. Optional external antenna can be used.

Caution: Do not install or remove the GSM module when the system is powered by AC power or backup battery.

1. Plug in the GSM Module and fasten it as follows:

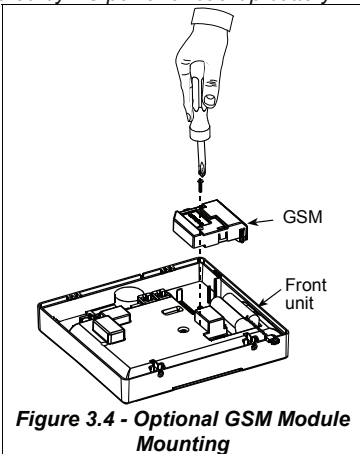

2. Insert the SIM card into the GSM module

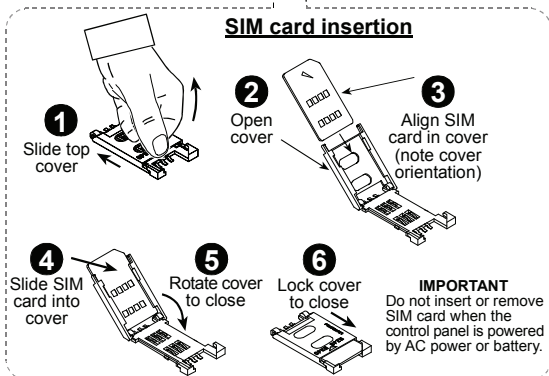
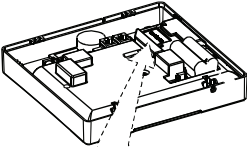

3.8 Power Cable Connection

Connect the power cable and close the control panel as shown below. Electrical socket-outlet shall be installed near the equipment and shall be easily accessible.

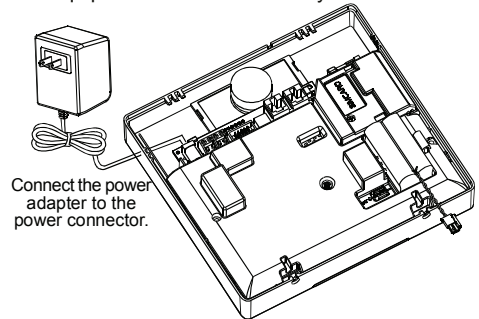

3.9 Control Panel Final Closure

Control panel final closure is shown below.

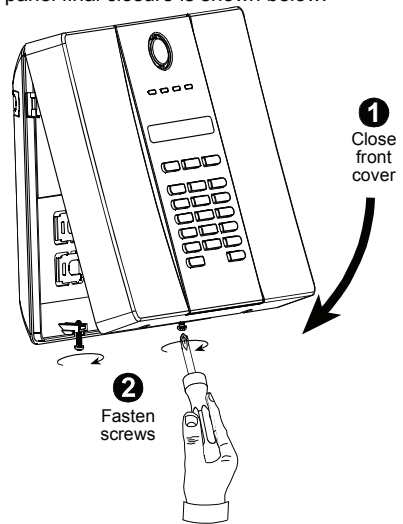

4. PROGRAMMING

4.1 INTRODUCTION

4.1.1 General Guidance

We recommend to program the PowerMaxExpress on the work bench before actual installation. Operating power may be obtained from the backup battery or from the AC power supply.

The installer's menu is accessible only to those who know the installer's 4-digit code, which is **9999** by factory default.

Note: Access to the installer menu, in PowerMaxExpress that has "User Permission" enabled (for example in UK) is accessible only at the end of the user menu. This option can be changed if necessary (see par. 4.4.36).

For PowerMaxExpress that has 2 installer codes (not applicable in UK), the default INSTALLER code is **8888** and the default MASTER INSTALLER code is **9999**.

The following actions can be done only by using the master installer code:

- Changing master installer code.
- Resetting the PowerMaxExpress parameters to the default parameters,
- Defining specific communication parameters, as detailed in a note in figure 4.5C.

Obviously, you are expected to use this code only once for gaining initial access, and replace it with a secret code known only to yourself.

You will mainly use 5 control pushbuttons during the entire programming process:

	- to move one step forward in a menu.
	- to move one step backward in a menu.
	- to enter the relevant menu or confirm data.
	- to move one level up in a menu.
	- to return to the "OK TO EXIT" state.

The sounds you will hear while programming are:

	- Single beep, heard whenever a key is pressed.
	- Double beep, indicates automatic return to the normal operating mode (by timeout).
	- Happy Melody (--- —), indicates successful completion of an operation.
	- Sad Melody (—), indicates a wrong move or rejection.

4.1.2 Entering an Invalid Installer Code

If you enter an invalid installer code 5 times, the keypad will be automatically disabled for 90 seconds and the message WRONG PASSWORD will be displayed.

4.1.3 Installer's Menu

The installer's menu is shown in figure 4.1a. The text in rectangles represents the current PowerMaxExpress display.

4.1.4 Setting a New Installer Code

To set an installer code, perform the actions that are presented in figure 4.1b. When you are instructed to enter code, enter a 4-digit code.

4.1.5 Setting a New Installer Code in PowerMaxExpress that has 2 Installer Codes

For PowerMaxExpress with 2 installer codes, INSTALLER code (default 8888) and MASTER INSTALLER code (default 9999), set new codes as shown in figure 4.1c.

For details regarding the different authorization levels when logging in with installer code and master installer code, refer to the note inside figure 4.5C (DEFINE COMM).

By using the master installer code, the menu enables changing both master installer code and installer code.

By using the installer code, the menu enables changing the installer code only.

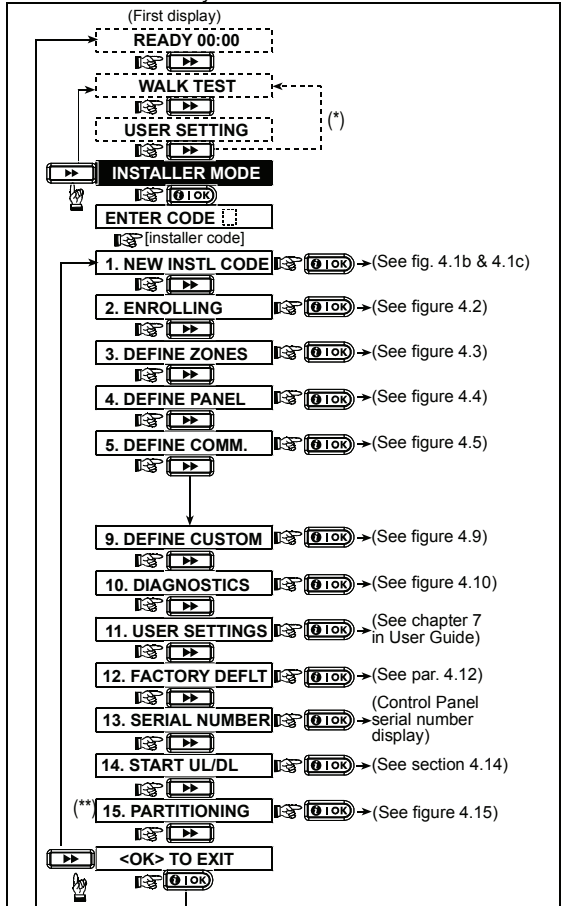

(*) Applicable only when "USER PERMIT" function is enabled (see par. 4.4.36 - USER PERMIT)

(**) Optional feature.

Figure 4.1a - Installer's Menu

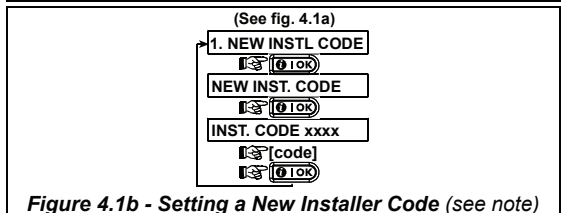
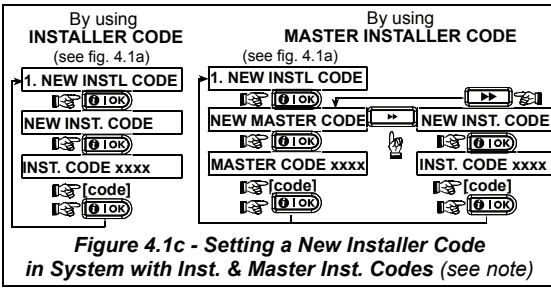

Figure 4.1b - Setting a New Installer Code (see note)



Note: *Installer Code should never be programmed as "0000". Doing so will lock the user out of the installer menu!*

4.2 ENROLLING WIRELESS DEVICES AND KEYFOB TRANSMITTERS

4.2.1 General Guidance

The ENROLLING mode has the following sub-modes:

- ENROLLING TYPE (wireless devices)
- ENROLL SENSORS.
- ENROLL KEYFOB (multi-button CodeSecure transmitters)
- ENROLL WL 1WAY KP (wireless commander MCM-140+)
- ENROLL WL 2WAY KP (wireless 2-way keypad MKP-150/ MKP-151)
- ENROLL WL SIREN (wireless siren)

Before beginning, gather all the devices that you intend to enroll and make sure they all have batteries installed. Your control panel must recognize the unique identification code (ID) of each such device in order to supervise them, receive their signals and respond accordingly.

Attention! *CodeSecure transmitters are mainly used for arming/disarming and can not be enrolled to zones. In order to enroll to zones, use only non-CodeSecure wireless devices.*

4.2.2 Enrolling Type

Here you determine whether to enroll a wireless device by normal transmission or by device Tamper function (opening its cover). Options: **normal**, or **by tamper**.

4.2.3 Enroll/Delete Sensors

Wired detector can be enrolled in zone 29 and wireless detectors can be enrolled in zones 01-28.

 • Before enrolling, the lens at the front of PIR and dual-technology sensors should be masked to prevent inadvertent transmission.

• Make sure that magnetic contact transmitter is together with its magnet, to prevent it from sending alarm transmission.

To enroll / delete wired / wireless sensors, refer to Fig. 4.2.

4.2.4 Enroll/Delete Keyfob Transmitters

Keyfob transmitters are multi-button wireless CodeSecure™ transmitters. Eight system users use them for better, quicker and safer control over various system functions. To enroll / delete 1-way or 2-way keyfob transmitters, refer to figure 4.2.

4.2.5 Enroll/Delete Wireless Commander

The Wireless Commander (MCM-140+) is a remote control unit that enables the user to remotely control the system. To enroll / delete up to 8 wireless commanders, refer to figure 4.2 (Enroll WL 1-way KP).

4.2.6 Enroll/Delete 2-Way Keypad

The 2-way keypad, type MKP-150/MKP-151, enables the user to remotely control the system and also to receive data from the system (alarm and trouble data). To enroll up to two 2-way keypads, refer to figure 4.2.

4.2.7 Enroll/Delete Wireless Siren

The wireless siren is a remote siren that is activated upon predefined events by the PowerMaxExpress system. To enroll / delete up to 2 wireless sirens, refer to figure 4.2.

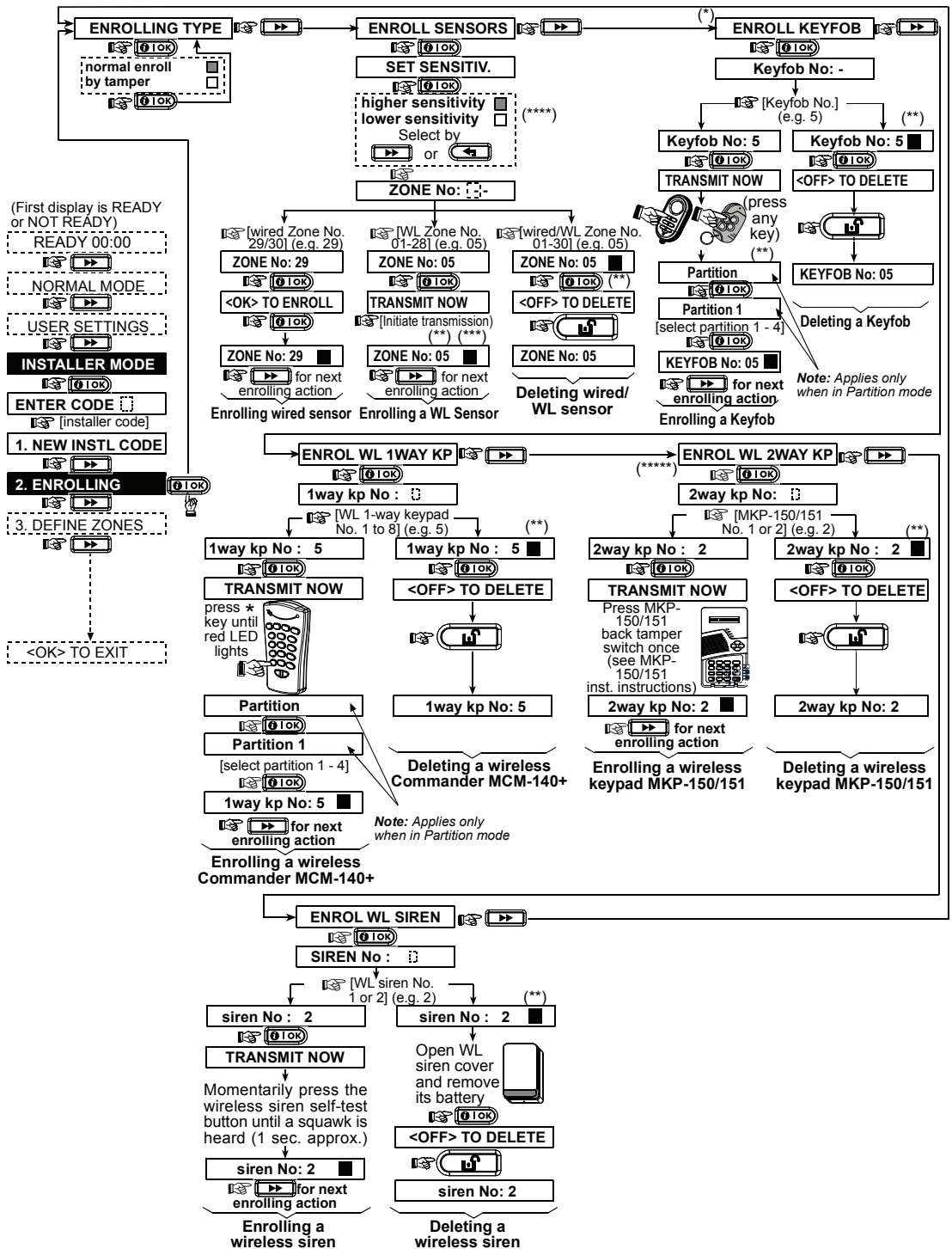

Figure 4.2 - Enrolling / Deleting Wireless Devices / Keyfobs / Wireless Commanders / Wireless Sirens

* Keyfob enrolling can be performed by the installer or by the user (via USER SETTINGS menu).
** A black box in the display means that a device is enrolled (the system has learned its ID). No black box indicates that the device is not enrolled.

*** Initiate either normal transmission or the device tamper function (see ENROLLING TYPE, Par. 4.2.2).
**** Select "higher" sensitivity for far wireless device, "lower" for near devices.
***** MKP-150/151 is not compatible for use when partition is enabled.

4.3 DEFINING ZONE TYPES, NAMES, CHIME ZONES & PARTITION

This mode allows you to assign one of 15 zone types to each of the system's 29 (wireless & wired) zones. In addition, it also allows you to assign a name to each zone and determine whether the zone will operate as a chime zone (only while the system is in the disarmed or Home arming state). When a chime zone is triggered, chime melody or zone name is heard (there are 2 selectable chime modes - Melody chime or Chime Off).

A list of factory defaults is printed in table 1. You may fill out the blank columns even before you start and proceed to program according to your own list.

Remember!

A delay zone is also a perimeter zone by definition. **Zone types are fully explained in Appendix C.**

Refer to Figure 4.1a to gain access to USER SETTINGS menu

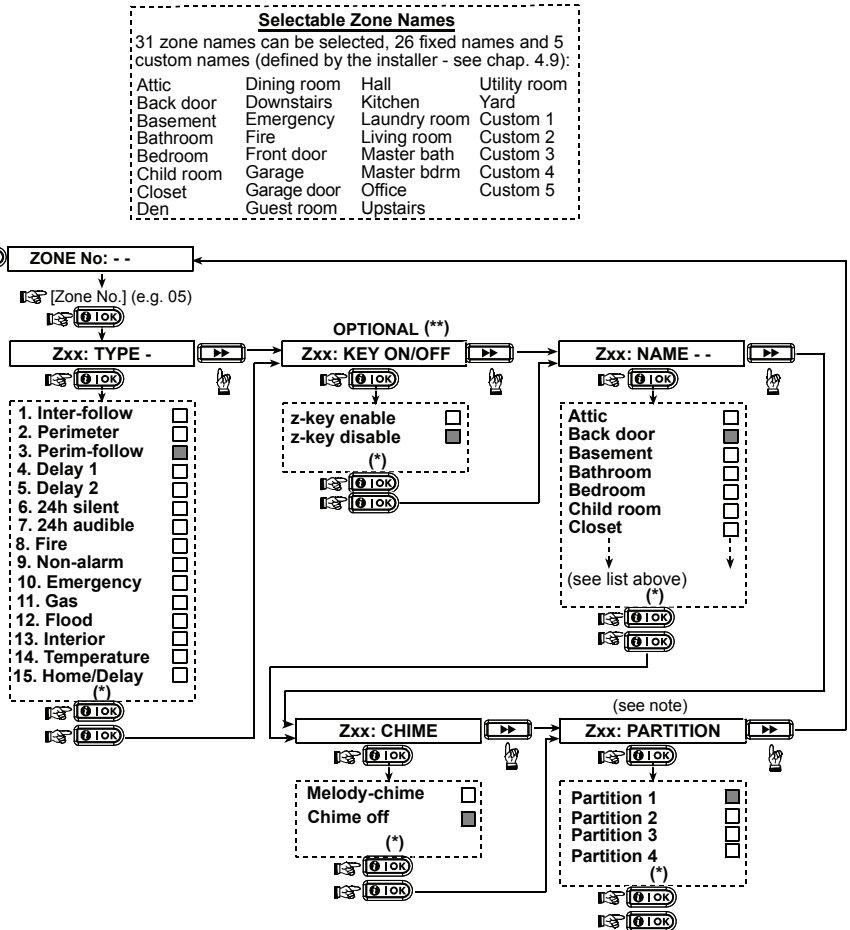
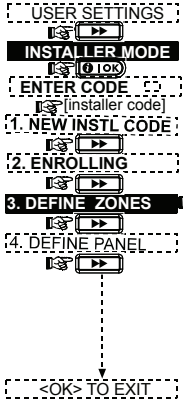

Figure 4.3 - DEFINE ZONES Flow Chart

- * The currently saved option is displayed with a dark box at the right side. To review the options, repeatedly click [RIGHT] or [LEFT] button, until the desired option is displayed, then click [OK] (a dark box will be displayed at the right side).
- ** Clicking the [OK] button in this location brings you to the same zone number that you are dealing with. Press [RIGHT] or [LEFT] to select the next zone.

Table 1 - DEFAULT AND PROGRAMMED ZONE DEFINITIONS



Zone No.	Zone Type		Zone Name		Chime (melody Zone Name or Off) (*)
	Default	Programmed	Default	Programmed	
1	Delay 1		Front Door		
2	Delay 1		Garage		
3	Delay 2		Garage Door		
4	Perimeter		Back Door		
5	Perimeter		Child Room		
6	Interior		Office		
7	Interior		Dining Room		
8	Perimeter		Dining Room		
9	Perimeter		Kitchen		

Zone No.	Zone Type		Zone Name		Chime (melody Zone Name or Off) (*)
	Default	Programmed	Default	Programmed	
10	Perimeter		Living Room		
11	Interior		Living Room		
12	Interior		Bedroom		
13	Perimeter		Bedroom		
14	Perimeter		Guest Room		
15	Interior		Master Bedroom		
16	Perimeter		Master Bedroom		
17	Perimeter		Laundry Room		
18	Perimeter		Master Bathroom		
19	Perimeter		Basement		
20	Fire		Fire		
21	Fire		Fire		
22	Emergency		Emergency		
23	Emergency		Emergency		
24	24 h / silent		Basement		
25	24 h / silent		Office		
26	24 h / audible		Attic		
27	24 h / audible		Den		
28	non-alarm		Yard		
29	non-alarm		Hall		
30	non-alarm		Utility room		

* **Note:** All zones are CHIME OFF by default. Enter your own choice in the last column and program accordingly.

4.4 DEFINING CONTROL PANEL PARAMETERS

4.4.1 Preliminary Guidance

This mode allows you to customize the control panel and adapt its characteristics and behavior to the requirements of the particular user. An illustrated process is shown in Figure 4.4. In this illustration, each selected option is displayed with a dark box at the right side. To review the options, repeatedly click  or  button, until the desired option is displayed, then click SHOW/OK button.

4.4.2 Entry Delays 1&2

(Fig. 4.4, location 01, 02). Two different entry delays allow the user to enter the protected site (while the system is in the armed state) via 2 specific doors and routes without causing an alarm.

Following entry, the user must disarm the control panel before the entry delay expires. Slow-rate warning beeps start sounding once the door is opened, until the last 10 seconds of the delay, during which the beeping rate increases. Locations No. 1 (entry delay 1) and 2 (entry delay 2) allow you to program the length of these delays. Available options for each delay are: **00s, 15s, 30s, 45s, 60s, 3m** and **4m**.

4.4.3 Exit Delay

(Fig. 4.4 location 03). An exit delay allows the user to arm the system and leave the protected site via specific routes and doors without causing an alarm. Slow-rate warning beeps start sounding once the arming command has been given, until the last 10 seconds of the delay, during which the beeping rate increases. Location No. 3 allows programming of the exit delay length. Available options are: **30s, 60s, 90s, 120s, 3m**, and **4m**.

4.4.4 Bell Time

(Fig. 4.4, location 04). Here you select the length of time the bell (or siren) is allowed to function upon alarm. The bell time starts upon activation of the siren. Once the bell time expires, the siren is automatically shut down.

Available options are: **1, 3, 4, 8, 10, 15** and **20** minutes.

Note: Bell Time is defined for the entire alarm system.

However, when disarming any partition (in a PowerMaxExpress Partition system) the siren ceases to sound.

4.4.5 Abort Time

(Fig. 4.4 location 05). Here you select the length of time allowed by the system to abort an alarm (not applicable to alarms from FIRE, 24H SILENT, EMERGENCY, GAS, FLOOD and TEMPERATURE zones). The PowerMaxExpress is programmed to provide an "abort interval" that starts upon detection of an event. During this interval, the buzzer sounds a warning but the siren remains inactive and the alarm is not reported. If the user disarms the system within the allowed abort interval, the alarm is aborted.

Available options are: **00s, 15s, 30s, 45s, 60s, 2m, 3m** and **4m**.

4.4.6 Alarm Cancel

(Fig. 4.4, location 06). Here you determine the "cancel alarm" period that starts upon reporting an alarm to the central station. If the user disarms the system within that time period, a "cancel alarm" message is sent to the central station.

Available options are: **1, 5, 15, 60 minutes, 4 hours** and also **cancel inactive**.

4.4.7 Quick Arm

(Fig. 4.4, location 07). Here you determine whether the user will be allowed to perform quick arming or not. Once quick arming is permitted, the control panel does not request a user code before it arms the system.

The two options are: **quick arm ON** and **quick arm OFF**.

4.4.8 Bypass

(Fig. 4.4, location 08). Here you permit either manual bypassing of individual zones (through the USER SETTINGS menu), or allow the system to "force arm" (perform automatic bypassing) of open zones during the exit delay. If desired, press the arming key again if you want to eliminate the protest tone that sounds during forced arming. If a zone is open and forced arming is not

permitted, "NOT READY" is displayed and the system does not arm (the "Sad Melody" will sound). If "no bypass" is selected, neither manual bypassing nor force arming is allowed.

Options: **manual bypass**, **force arm** and **no bypass**.

4.4.9 Exit Mode

(Fig. 4.4, location 09). Here you determine exit mode options. Three types of exit modes are available:

Restart Exit - Exit delay restarts when the door is reopened during exit delay. The restart occurs once only. Restarting the exit delay is helpful if the user re-enters immediately after going out to retrieve an item that he left behind.

Off by door - When the door is closed, the exit delay is automatically terminated (even if the defined exit delay was not completed).

Normal - The exit delay is exactly as defined, regardless of whether the door is open or closed.

4.4.10 Piezo Beeps

(Fig. 4.4, location 10). Here you determine whether warning beeps will sound or muted during exit and entry delays. An additional option is to mute the warning beeps only when the system is armed "HOME".

Options: **enable beeps**, **off when home** and **disable beeps**.

4.4.11 Trouble Beeps

(Fig. 4.4, location 11). Under trouble conditions, the sounder emits a series of 3 short beeps once per minute. Here you determine whether this special beeping sequence will be active, inactive, or just inactive at night (the range of "night" hours is defined in the factory). The 3 options are: **enable beeps**, **off at night (8 PM through 7 AM)** and **disable beeps**.

4.4.12 Panic Alarm

(Fig. 4.4, location 12). Here you determine whether the user will be allowed to initiate a panic alarm by simultaneous pressing either the two panic buttons (on the keypad / wireless commander) or away + home (on a keyfob transmitter). Audible panic activates the siren and simultaneously transmits a message via telephone. Silent panic only transmits a message via telephone. The options are: **silent panic**, **audible panic** and **disable panic**.

4.4.13 Swinger Stop

(Fig. 4.4, location 13). Here you determine the number of times each zone is allowed to initiate an alarm within a single arming period (including tamper & power failure events of detectors, PowerMaxExpress, wireless siren, etc.). If the alarms number from a specific zone exceeds the programmed number, the control panel automatically bypasses the zone to prevent recurrent siren noise and nuisance reporting to the central station. The zone will be reactivated upon disarming, or 48 hours after having been bypassed (if the system remains armed).

Available options are: **shut after 1**, **shut after 2**, **shut after 3** and **no shutdown**.

Note: *Swinger Stop is defined for the entire alarm system and not per partition (in a PowerMaxExpress Partition system).*

4.4.14 Cross Zoning

(Fig. 4.4, location 14). Here you determine whether cross zoning will be active or inactive. Cross zoning is a method used to counteract false alarms - an alarm will not be initiated unless two adjacent zones are violated within a 30-second time limit.

This feature is active only when arming AWAY and only with zone couples from zone No. 18 to 27 (18 and 19, 20 and 21, etc.). You may use any one of these zone couples to create a "cross-zoned" area.

Note: *If one of two crossed zones is bypassed (see Para. 4.4.8), the remaining zone will function independently.*

Note: *Every 2 crossed zones must be of the allowed zone type (Interior, Perimeter, Perimeter follower).*

The options are: **cross zone ON** and **cross zone OFF**.

Cross zoning is not applicable in Entry/ Exit zones and 24h zones (Fire, Emergency, 24h audible, 24h silent).

4.4.15 Supervision

(Fig. 4.4, location 15). Here you determine the time limit for reception of supervision reports from various supervised wireless devices. If any device does not report at least once within the selected time limit, an "INACTIVITY" alert is initiated.

The options are: **1, 2, 4, 8, 12 hours** and **disable**.

4.4.16 NOT READY

(Fig. 4.4, location 16). Here you determine if the system will be in NOT READY status when there is a supervision failure. In the "in supervision" mode, the system will be in NOT READY status if during the last 20 minutes a supervision message was not received. Options: **normal** and **in supervision**.

Note: *NOT READY operates only per partition (in a PowerMaxExpress Partition system).*

4.4.17 AUX Button A

(Fig. 4.4, location 17). Here you select the function of the AUX button/ button A on keyfob transmitters MCT-234, MCT-237 and wireless commanders MCM-140+. Four options are offered for each AUX button:

Instant: Pressing the AUX button while the exit delay is in progress will cause the system to arm "instant" (the entry delay is canceled).

Skp exit delay: Pressing the AUX button will immediately cause the system to arm immediately.

4.4.18 AUX Button B 2-W-KF

(Fig. 4.4, loc. 18). Applicable only for 2-way keyfob MCT-237. Same as 4.4.17 but for AUX button B.

4.4.19 Jam Detect

(Fig. 4.4, location 19). Here you determine whether jamming (interfering transmissions, on the radio channel used by the system) will be detected and reported or not.

If a jam detection option is selected, the system does not allow arming under the relevant jamming conditions.

Jam Detection Options

Option	Detection and Reporting when
UL (20/20) (USA standard)	There is continuous 20 seconds of jamming
EN (30/60) (Europe standard)	There is an accumulated 30 seconds of jamming within 60 sec.
class 6 (30/60) (British standard)	Like EN (30/60) but the event will be reported only if the jamming duration exceeds 5 minutes.
Disabled	(No jamming detection and reporting).

4.4.20 Latchkey

(Fig. 4.4, location 20). Here you determine whether the system can be armed in the latchkey mode. If the system is armed this way, a "latchkey" message will be sent to specific telephones upon disarming by a "latchkey user" (users 5-8 or keyfob transmitters 5-8). This mode is useful when parents at work want to be informed of a child's return from school. You can record a name for latchkey users. The options are: **Latchkey ON** and **Latchkey OFF**.

4.4.21 "Not Active"

(Fig. 4.4, location 21). Here you determine the time limit for reception of signals from sensors used to monitor the activity of sick, elderly or disabled people. If no sensor detects and reports movement at least once within the defined time limit, a "not-active" alert is initiated.

Options: **3, 6, 12, 24, 48, 72 hours** and **no act disable**.

Note: *The Not Active timer is defined for the entire alarm system for the above hour options and not per partition (in a PowerMaxExpress Partition system). Subsequently, a dedicated timer is assigned to each partition.*

4.4.23 Duress

(Fig. 4.4, loc. 23). A duress alarm (ambush) message can be sent to the central station if the user is forced to disarm the system under violence or menace. To initiate a duress message, the user must disarm the system with the duress code (2580 by default). Here you can change the code digits or enter "0000" to disable the duress feature. **The system does not allow the user to program the duress code saved in this memory location as an existing user code.**

4.4.24 Piezo Siren

(Fig. 4.4, location 24). Here you determine whether the internal siren will sound or remain silent upon alarm (according to the user preference). Options: **piezo siren on**, **piezo siren off**.

4.4.25 Reset Option

(Fig. 4.4, location 25). **(Not applicable in the USA)** Here you determine whether the system can be rearmed (after an event) by the user or only by the installer.

Options: **user reset** or **engineer reset**.

If Engineer Reset is selected, the system can be rearmed only by the installer; by entering and exiting the installer menu, by entering and exiting the event log (see section 7), or by remote telephone. To perform Engineer Reset via the telephone, establish communication with the PowerMaxExpress (see user guide, par. 6.3A, steps 1-5) and continue as follows:

- ☎ [*], [installer code], [#]
- Wait for 2 beeps
- ☎ [*], [1], [#]
- ☎ [*], [99], [#]

Note: *This menu is not available when partition is enabled.*

4.4.26 Tamper Option

(Fig. 4.4, location 26). Here you determine whether zone tamper will be reported or ignored. Available options are: **zone tamper ON** and **zone tamper OFF**.

4.4.27 Siren On Line

(Fig. 4.4, location 27). Here you determine whether the siren will be activated or not when the telephone line fails during system armed state. Available options are: **enable on fail**, **disable on fail**.

4.4.28 Memory Prompt

(Fig. 4.4, location 28). Here you determine whether the user will receive indication that an alarm has been activated. Available options are: **enable** and **disable**.

4.4.29 Disarm Option

(Fig. 4.4, location 29). Here you determine when it is possible to disarm the system:

- Any time.
- In AWAY mode, during entry delay, by using the PowerMaxExpress keypad or wireless sensor (keyfob).
- In AWAY mode, during entry delay, by using a wireless device (keyfob) only (this is set as a default in UK to comply with DD243).
- During entry delay, or by using the PowerMaxExpress keypad in AWAY mode.

Options: **any time**, **on entry all**, **on entry wireless**, or **entry + away kp**.

4.4.30 Bell/Rep. Option

(Fig. 4.4, location 30). Here you determine whether an alarm will be initiated (siren / report) when there is a supervision / jamming failure during AWAY arming state. Available options are: **EN standard** and **other**. When "EN standard" is selected, if there is supervision / jamming failure during AWAY arming, the siren is activated and the events are reported as tamper events. When "Other" is selected, there is no such activity during AWAY arming.

4.4.31 Low-Bat Ack

(Fig. 4.4, location 31). Here you determine whether the user will hear or will not hear low battery sound when he tries to disarm the system with a keyfob whose battery voltage is low. Available options are: **keyfob L-B on** (the user has to acknowledge the keyfob low battery message) or **keyfob L-B off** (the user does not have to acknowledge the keyfob low battery message).

4.4.32 Screen Saver

(Fig. 4.4, location 32). Here you can determine that if no key is pressed during more than 30 seconds, the display will be "PowerMax" (to prevent possible intruder of knowing the system status). You can determine that normal display will return after pressing the 

button followed by entering user code (**Refresh by Code**) or after pressing any key (**Refresh by Key**).

If **Refresh by Key** is selected, the first pressing of any key (except Fire and Emergency) will cause normal display return and the second press will perform the key function. Regarding the Fire and Emergency keys, the first key press will cause normal display return and also will perform the Fire/Emergency function.

Options: **scrn saver OFF**, **refresh by code**, **refresh by key**.

4.4.33 Confirm Alarm

(Fig. 4.4, location 33). Here you determine that if 2 successive alarms will occur during a specific period, the second alarm will be considered as a **confirmed alarm** (for confirmed alarm reporting, (see par. 4.5.3).

Options: **disable 30 min.**, **45 min.**, **60 min.**, or **90 min.**

4.4.34 AC FAIL REP

(Fig. 4.4, location 34). Here you determine the time interval between AC power failure occurrence and the failure reporting. Options: **5 minutes**, **30 minutes**, **60 minutes** or **180 minutes**.

4.4.36 User Permission

(Fig. 4.4, location 36). Here you determine whether the access to the INSTALLER MODE requires user permission. If you select ENABLE, the installer mode will be accessible only through the user menu after entering the user code.

Options: **Enable**, **Disable**.

Note: *This menu is not available when partition is enabled.*

4.4.39 Key Zones Options (Optional)

(Fig. 4.4, location 39). Here you determine whether or not the system can be armed and disarmed by zones 21-18, 29 or 21-29, provided that for these zones "non-alarm type" and "z-key enable" was predefined (see par. 4.3).

Key zones can be wireless or wired zones.

When using wireless key zones, only the MCT-100 and MCT-102 transmitters are used. The left pushbutton on the MCT-102 transmitter or input 1 of the MCT-100 transmitter is used for arming in AWAY mode. The right pushbutton on the MCT-102 transmitter or input 2 of the MCT-100 transmitter is used for disarming.

When using wired key zones, the control panel toggles between AWAY mode and Disarm.

Note: *In "Singapore" versions of the PowerMaxExpress, an open circuit arms the alarm system in AWAY mode and a closed circuit changes the state of the alarm system from AWAY mode to Disarm.*

IMPORTANT! Enrolment of the MCT-100 or MCT-102 transmitter must be performed via the left pushbutton on the MCT-102 transmitter or input 1 of the MCT-100 transmitter.

Caution! Arming the system using a transmitter assigned to zones 21 and 28, or via wired zone 29 compromises security. This function is, therefore, only available in specific PowerMaxExpress versions according to the customer's request.

Options: **disable option**, **z. 21-28 enable**, **z. 29 enable**, or **z. 21-29 enable**.

Refer to Figure 4.1a to gain access to USER SETTINGS menu

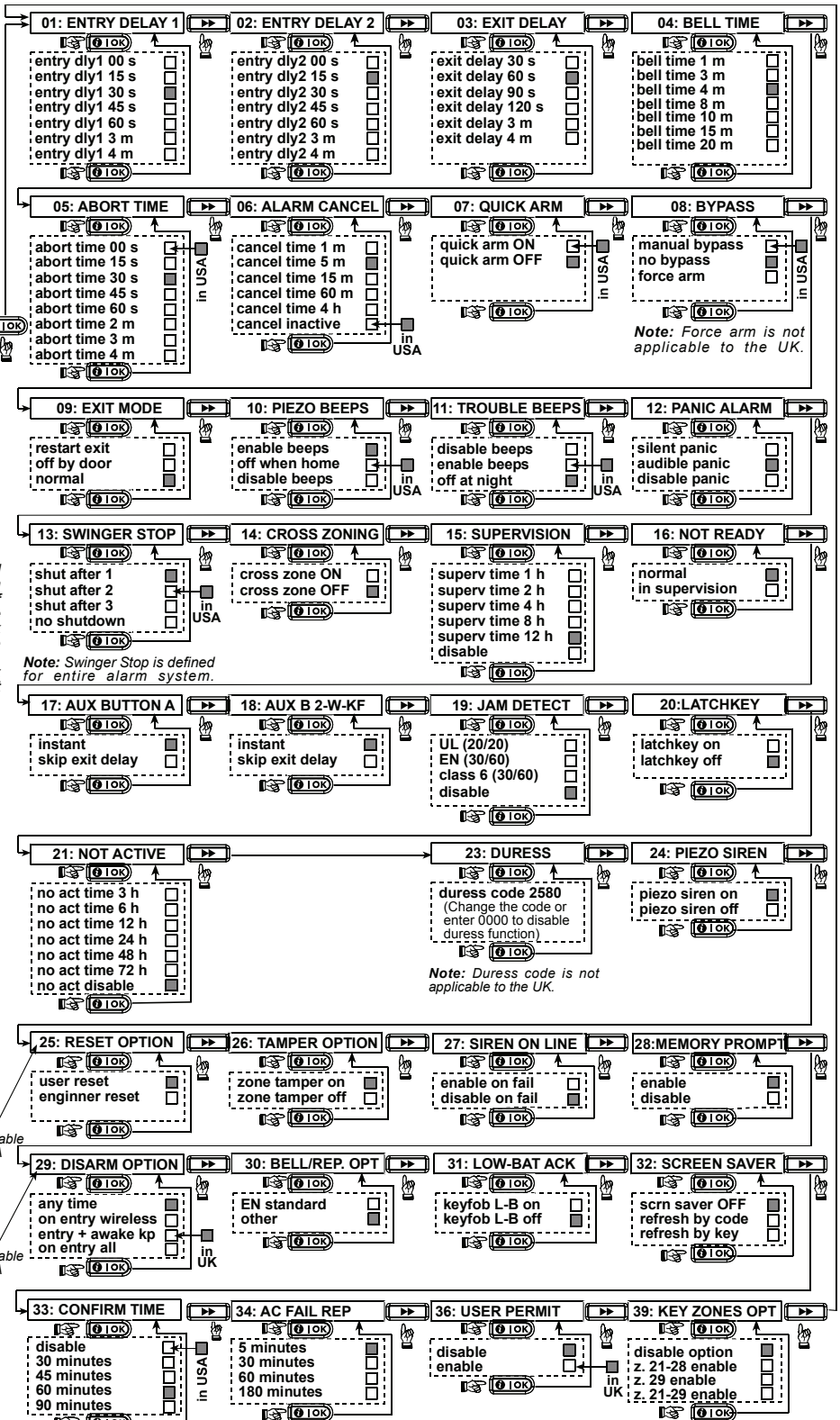
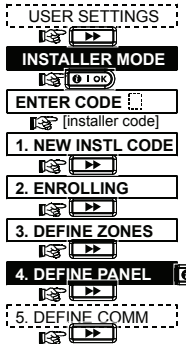

Figure 4.4 - DEFINE PANEL Flow Chart

4.5 DEFINING COMMUNICATION PARAMETERS



Preliminary Guidance



This mode allows you to adapt the telephone communication parameters to the local requirements.

Compatible central station receivers are:
Osborne-Hoffman model 2000, Ademco Model 685, FBI Model CP220, Radionics Model D6500, Sur-Gard Model SG-MLR2-DG and Silent Knight Model 9500.

IMPORTANT: In telephone / pager number locations and account number locations, you may be required to enter hexadecimal digits. In telephone number locations, these digits are used as codes to control the dialer.

Hex. Digit	Keying Sequence	Code Significance
A	<#> ⇒ <0>	Applicable <u>only</u> at the beginning of a number - the dialer waits 10 seconds or waits for dial tone, whichever comes first and then dials.
D	<#> ⇒ <3>	Applicable <u>only</u> at the beginning of a number - the dialer waits 5 seconds for dial tone and goes on hook if none is received.
E	<#> ⇒ <4>	Applicable <u>only</u> in the middle of the number - the dialer waits 5 seconds
F	<#> ⇒ <5>	Not applicable in phone numbers

Note: A "+" can be entered at the beginning of the line by pressing  # and then .

To enter a series of digits, use the following keys:
<Numeric keypad> - to enter the number
 - moves the cursor from left to right
 - moves the cursor from right to left
 - deletes everything after the cursor (to the right)

4.5.1 PSTN / GSM (Fig. 4.5 Detail A)

Area Code [Fig 4.5.1(1)]

Here you enter the system tel. area code (up to 4 digits).

Line Prefix [Fig 4.5.1(2)]

Here you enter the number that is used as a prefix to access an outside telephone line (if exists).

Dial Method [Fig 4.5.1(3)]

Here you determine the dialing method used by the automatic dialer built into the PowerMaxExpress control panel.

The options are: **Pulse and tone (dtmf)**.

GSM Keep Alive [Fig 4.5.1(4)]

Here you prevent the GSM service provider from disconnecting the GSM line if the user has not initiated any outgoing telephone calls during the last 28 days.

The options are: **disable and every 28 days**.

4.5.2 GPRS / BB [Fig. 4.5 Detail B]

The GSM/GPRS module is capable of communicating with the Central Station receiver by GPRS, GSM Voice and SMS channels. Each of the channels can be separately enabled or disabled in order to allow or prohibit the module from using it for the event reporting. If all channels are enabled, the GSM/GPRS module will always try GPRS first. If fails, it will try GSM Voice. If fails, it will try any other possible method (PSTN, Broadband) and only then it will try SMS. This is due to the fact that SMS is the most unreliable option of communication. Disabling any of the GSM Module channels will cause the module to use a different sequence than the one described above.

GPRS Report [Fig 4.5.2(1)]

Here you determine whether the alarm system will report events to the central station via the GPRS channel.

The options are: **disable and enable**.

GSM Report [Fig 4.5.2(2)]

Here you determine whether the alarm system will report events to the central station via the GSM voice channel.

The options are: **disable and enable**.

SMS Report [Fig 4.5.2(3)]

Here you determine whether the alarm system will report events to the central station via the SMS channel.

The options are: **disable and enable**.

GPRS APN [Fig 4.5.2(4)]

Here you enter the name of the APN (Access Point) used for the internet settings for the GPRS (up to 40 digits).











GPRS Username [Fig 4.5.2(5)]

Here you enter the username of the APN used for GPRS communications (up to 30 digits).

GPRS Password [Fig 4.5.2(6)]

Here you enter the password of the APN used for GPRS communications (up to 16 digits).

The following table provides a list of the keys used by the PowerMaxExpress editor for the GPRS APN, GPRS Username, GPRS Password menus and Custom Zone Name option.

Key	Functionality
	Moves the cursor from left to right. Long press for speed.
	Moves the cursor from right to left. Long press for speed.
	Scrolls upward the sequence of inserted digits. Long press for speed.
	Scrolls downward the sequence of inserted digits. Long press for speed.
	Places cursor to extreme right position of edit string and shows the last 16 digits of edit string.
	Reverts to previous or top menu without saving the edit string.
	Reverts to "<OK> TO EXIT" without saving the edit string.
	Saves and reverts to previous menu.
	Clears all digits to the right of cursor.
	Clears one digit by cursor.
	Selects between uppercase or lowercase digits.

PIN Code [Fig 4.5.2(8)]

Enter PIN code of the SIM card installed in the PowerMaxExpress unit (up to 16 digits).

Force Home Network [Fig 4.5.2(9)]

Here you determine whether to force the SIM card to use the home network only and not to select another network in case the home network cannot be found.

The options are: **disable and enable**.

4.5.3 C.S. Reporting (Fig. 4.5 Detail C)

Report Events [Fig 4.5.3(1)] – see note in Fig. 4.5 Detail C

Here you determine which types of event will be reported to central stations. Due to lack of space in the display, abbreviations are used: alarm is "alm", alert is "alrt" and open/close is "o/c". The asterisk (*) is a separator between events reported to **central station 1** and events reported to **central station 2**.

Messages are divided by type into four groups:

No.	Group	Events Reported
1	Alarms	Fire, Burglary, Panic, Tamper
2	Open/close	Arming AWAY, Arming HOME, Disarming
3	Alerts	No-activity, Emergency, Latchkey, Gas, Flood, Temperature
4	Maintenance	Low-battery AC failure

"Alarm" group has the highest priority and "Alert" group has the lowest priority.

The selectable options are as follows:

Plan name	Sent to center 1	Sent to center 2
all -o/c * backup	All but open/close	All but open/close if center 1 doesn't respond
all * all	All	All
all -o/c * all -o/c	All but open/close	All but open/close
all -o/c * o/c	All but open/close	Open/close
all (-alrt) * alrt	All but alerts	Alerts
Alarm * all (-alarm)	Alarms	All but alarms
Disable report	Nothing	Nothing
all * backup	All	All if cent. 1 doesn't respond

Note: "All" means that all 4 groups are reported and also trouble messages - sensor / system low battery, sensor inactivity, power failure, jamming, communication failure etc.

1st Report Method [Fig 4.5.3(2)]

Here you define the 1st priority of method used to report events.

The options are: **disable**, **cellular** and **PSTN**.

2nd Report Method [Fig 4.5.3(3)]

Here you define the 2nd priority of method used to report events. If the method defined to report events in the 1st priority fails, the control panel will attempt to report using the method defined in the 2nd priority (see notes in 1st Report Method).

The options are: **disable**, **cellular** and **PSTN**.

3rd Report Method [Fig 4.5.3(4)]

Here you define the 3rd priority of method used to report events. If the method defined to report events in the 2nd priority fails, the control panel will attempt to report using the method defined in the 3rd priority (see notes in 1st Report Method).

The options are: **disable**, **cellular** and **PSTN**.

Dual Reporting [Fig 4.5.3(5)]

Here you determine whether to report events using PSTN and cellular at the same time instead of waiting for the 1st method to fail before trying the 2nd method.

The options are: **disable** and **PSTN & cellular**.

Receiver 1 Account No. [Fig 4.5.3(6)] - see note in Fig. 4.5 Detail C

Here you enter the number that will identify your specific alarm control system to the 1st central station. The number consists of 6 hexadecimal digits.

Receiver 2 Account No. [Fig 4.5.3(7)] - see note in Fig. 4.5 Detail C

Here you enter the number that will identify your system to the 2nd central station. The account number consists of 6 hexadecimal digits.

PSTN/GSM RCVR1 [Fig 4.5.3(8)] - see note in Fig. 4.5 Detail C

Here you program telephone number of the 1st central station (including area code, 16 digit max) to which the system will report the event groups defined in Report Events.

PSTN/GSM RCVR2 [Fig 4.5.3(9)] - see note in Fig. 4.5 Detail C

Here you program telephone number of the 2nd central station (including area code, 16 digit max) to which the system will report the event groups defined in Report Events.

IP RCVR 1 [Fig 4.5.3(10)]

Here you enter the IP address of the IP receiver that is located in the 1st central station.

IP RCVR 2 [Fig 4.5.3(11)]

Here you enter the IP address of the IP receiver that is located in the 2nd central station.

SMS RCVR 1 [Fig 4.5.3(12)]

Here you enter the telephone number of the SMS receiver that is located in the 1st central station.

SMS RCVR 2 [Fig 4.5.3(13)]

Here you enter the telephone number of the SMS receiver that is located in the 2nd central station.

PSTN Report Format [Fig 4.5.3(14)] - see note in Fig. 4.5 Detail C

Here you select the reporting format used by the control panel to report events to central stations.

The options are: **SIA text** **Contact-ID** **SIA** **4/2 1900/1400** **4/2 1800/2300** **Scancode** (see Appendix B - code lists).

4/2 Pulse Rate [Fig 4.5.3(15)] - see note in Fig. 4.5 Detail C

Here you select the pulse rate at which data will be sent to central stations if any one of the 4/2 formats has been selected in PSTN Report Format.

The options are: **10**, **20**, **33** and **40** pps.

PSTN Report Retry [Fig 4.5.3(16)] - see note in Fig. 4.5 Detail C

Here you determine the number of times the communicator will dial the central station's number via PSTN.

The options are: **2**, **4**, **8**, **12** and **16** attempts.

GSM Report Retry [Fig 4.5.3(17)] - see note in Fig. 4.5 Detail C

Here you determine the number of times the communicator will try to report via a cellular group (GPRS, GSM and SMS) to the central station.

The options are: **2**, **4**, **8**, **12** and **16** attempts.

Auto Test Time [Fig 4.5.3(18)]

Here you determine the time at which the telephone line will be tested and reported to the central station.

Auto Test Cycle [Fig 4.5.3(19)]

Here you determine the time interval between consecutive telephone line test messages sent to the central station. The control panel performs this at regular intervals to verify proper communications.

The options are: **test every 5 hours**, **test every 1, 2, 5, 7, 14, 30 days** and **test OFF**.

Line Fail Report [Fig 4.5.3(20)]

PSTN [Fig 4.5.3(20a)]

Here you determine if the PSTN telephone line disconnection will be reported or not and determine the delay between detection of line disconnection and the failure reporting. If the telephone line is disconnected, the message "tel line fail" will be stored in the event log.

The options are: **don't report**, **immediately**, **5 minutes**, **30 minutes**, **60 minutes** or **180 minutes**.

GSM/GPRS [Fig 4.5.3(20b)]

Here you determine if the GSM/GPRS line disconnection will be reported or not and determine the delay between detection of line disconnection and report failure. If the telephone line is disconnected, the message "GSM line fail" will be stored in the event log.

The options are: **don't report, 2 minutes, 5 minutes, 15 minutes, or 30 minutes.**

PSTN Up / Down [Fig 4.5.3(21)]

Remote Access [Fig 4.5.3(21a)]

Here you give or deny permission to access the system and exercise control from a remote telephone.

The options are: **rem. access ON** and **rem. access OFF.**

Mast. Downl Code [Fig 4.5.3(21b)]

Here you determine the master installer 4-digit password for downloading/uploading data into/from the PowerMaxExpress memory.

Attention! If "0000" is used, it will not enable connection of the PowerMaxExpress to the PC for upload/download purpose.

Inst. Downl Code [Fig 4.5.3(21c)]

Here you determine the installer 4-digit password for downloading data into the PowerMaxExpress memory.

Attention! If "0000" is used, it will not enable connection of the PowerMaxExpress to the PC for upload/download purpose.

Upload Option [Fig 4.5.3(21d)]

Here you determine whether the PowerMaxExpress data can be uploaded into a computer while the system is in disarm state or at any time (in HOME/AWAY arming & disarm state).

The options are: **when system OFF** and **any time**

Up Download Tel# [Fig 4.5.3(21e)]

Here you enter the telephone number (up to 16 digits) of the UL/DL server.

Note: Only for use with control panels monitored by compatible central stations. Leave empty if not used.

GPRS Up / Down [Fig 4.5.3(22)]

My SIM Tel. # [Fig 4.5.3(22a)]

Here you enter the PowerMax SIM card telephone number. The central station dials this number when it needs to connect to the PowerMaxExpress for uploading / downloading data.

1st Caller ID# [Fig 4.5.3(22b)]

Here you determine the 1st VDNS receiver telephone number. When the PowerMaxExpress responds to an incoming call from the telephone number defined here, it creates a connection to the VDNS for uploading / downloading data.

Note: Caller ID#1 / ID#2 should be 6 or more digits for wake-up by VDNS to work.

2nd Caller ID# [Fig 4.5.3(22c)]

Here you determine the 2nd VDNS receiver telephone number. When the PowerMaxExpress responds to an incoming call from the telephone number defined here, it creates a connection to that VDNS for uploading / downloading data.

Report Cnfrm Alarm [Fig 4.5.3(24)] - see note in Fig. 4.5 Detail C

Here you determine whether the system will report whenever 2 or more events (**confirmed alarm**) occur during a specific period (see par. 4.4.33).

Available options are: **enable report, disable report, enable + bypass** (enabling report and bypassing the detector - applicable to PowerMaxExpress that is compatible with DD243 standard).

Report 24H Zones [Fig 4.5.3(25)]

Here you determine whether 24 hour (silent and audible) zones will function as normal 24 hour zones or as panic zones.

The options are: **both original, audible as panic, silent as panic, or both as panic.**

Recent Close [Fig 4.5.3(26)]

Here you enable or disable the "recent closing" report, that is sent to the central station if an alarm occurs within 2 minutes from the expiry of the exit delay.

The options are: **recent close ON** and **recent close OFF.**

Zone restore [Fig 4.5.3(27)]

Here you determine whether a zone restore will be reported or not.

The options are: **report restore** and **don't report.**

System Inactivity Report [Fig 4.5.3(28)]

Here you determine whether the central station will receive a message if the system is inactive (not armed) during a defined period (days).

The options are: **disable, rep. after 7d, rep. after 14d, rep. after 30d, rep. after 90d.**

4.5.4 Private Report (Fig. 4.5 Detail D)

Report To Private [Fig 4.5.4(1)]

Here you determine which event groups will be reported to private telephone subscribers. The options are as follows:

- Alarms + alerts
- Alarms
- Alerts
- Disable report

The following siren signal will be sent to private telephone upon event reporting:

FIRE: ON - ON - ON - pause.... (- - - - -

BURGLAR: ON continuously (—————...)

EMERGENCY: 2-tone siren; like an ambulance.

Voice report [Fig 4.5.4(2)]

1st Private Tel# [Fig 4.5.4(2a)]

Here you program the 1st telephone number (including area code, if required) of the private subscriber to which the system will report the event groups defined in Report To Private.

2nd Private Tel# [Fig 4.5.4(2b)]

Here you program the 2nd telephone number (including area code, if required) of the private subscriber to which the system will report the event groups defined in Report To Private.

3rd Private Tel# [Fig 4.5.4(2c)]

Here you program the 3rd telephone number (including area code, if required) of the private subscriber to which the system will report the event groups defined in Report To Private.

4th Private Tel# [Fig 4.5.4(2d)]

Here you program the 4th telephone number (including area code, if required) of the private subscriber to which the system will report the event groups defined in Report To Private.

Redial Attempts [Fig 4.5.4(2e)]

Here you determine the number of times the communicator will dial the called party's number (private telephone).

The options are: **1, 2, 3** and **4** attempts.

Attention! A maximum of 2 dialing attempts is permitted by the Australian Telecommunication Authority.

Tel. acknowledge [Fig 4.5.4(2g)]

Here you determine whether the system will use the single acknowledge or the all acknowledge mode when reporting to private telephones.

Note: In the single acknowledge mode, receiving an acknowledge signal from a single telephone is sufficient to consider the current event closed and call off the communication session. The remaining telephones serve for backup purposes only. In the all acknowledge mode, an acknowledge signal must be received from each telephone before the current event is considered reported. The options are: **single ack** and **all ack**.

SMS Report Tel# [Fig 4.5.4(3)]

1st SMS Tel# [Fig 4.5.4(3a)]

Here you define the first SMS phone number (including area code, 16 digits maximum) to which pre-selected event types (see par. 4.6.3) will be reported.

2nd SMS Tel# [Fig 4.5.4(3b)]

Here you define the second SMS phone number (including area code, 16 digits maximum) to which pre-selected event types (see par. 4.6.3) will be reported.

3rd SMS Tel# [Fig 4.5.4(3c)]

Here you define the third SMS phone number (including area code, 16 digits maximum) to which pre-selected event types (see par. 4.6.3) will be reported.

4th SMS Tel# [Fig 4.5.4(3d)]

Here you define the fourth SMS phone number (including area code, 16 digits maximum) to which pre-selected event types (see par. 4.6.3) will be reported.

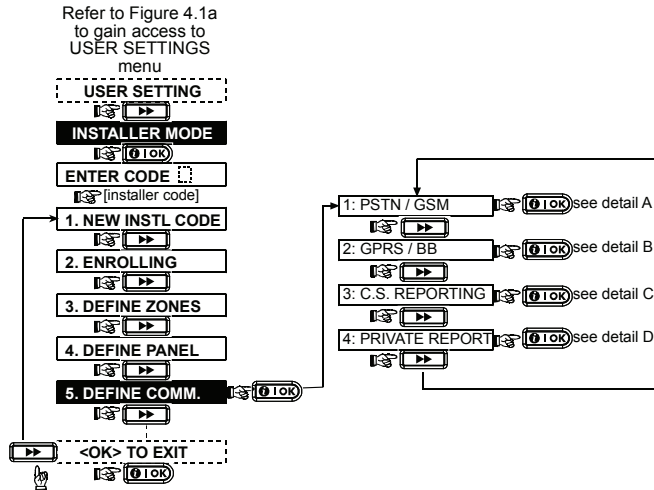

Figure 4.5 – Defining Communications

FIGURE 4.5 - DETAIL A

Note
The currently saved options are displayed with dark box at the right side of the display. To review the options, repeatedly click [right arrow] or [left arrow] until the desired option is displayed, then click OK (a dark box will be displayed at the right side).

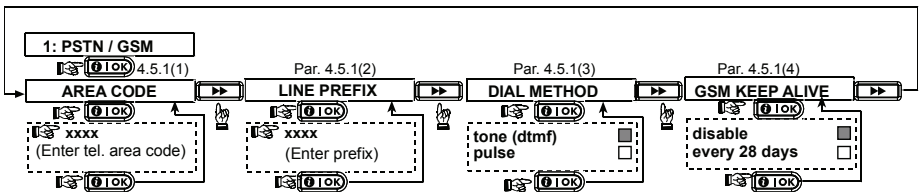

FIGURE 4.5 - DETAIL B

Note
The currently saved options are displayed with dark box at the right side of the display. To review the options, repeatedly click [right arrow] or [left arrow] until the desired option is displayed, then click OK (a dark box will be displayed at the right side).

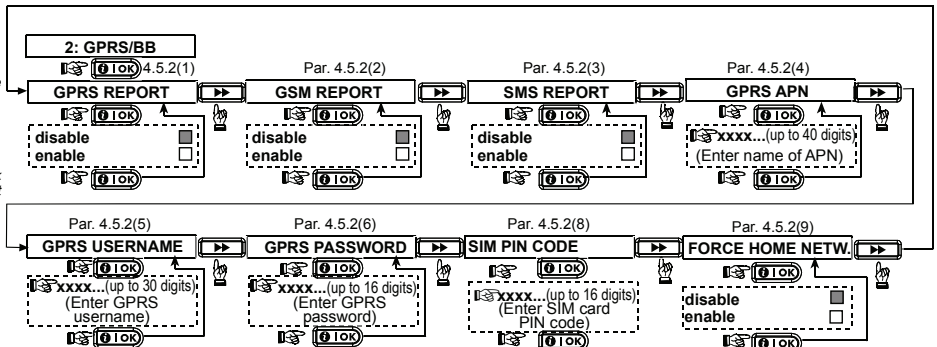
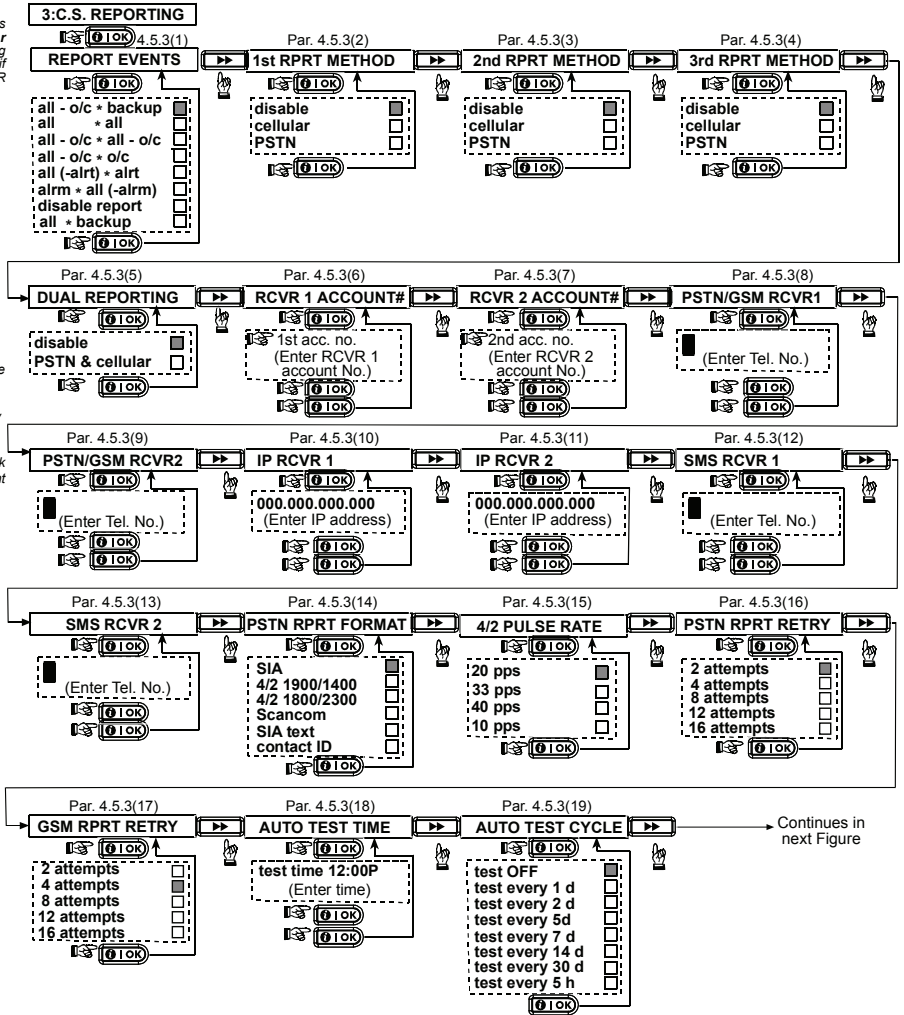

FIGURE 4.5 - DETAIL C

Note
 For Control Panel that has installer code & master installer code, the following functions are available only if the MASTER INSTALLER code is entered:
 PSTN/GSM RCVR1
 RCVR 1 ACCOUNT#
 RCVR 2 ACCOUNT#
 PSTN RPRT FORMAT
 4/2 PLS RATE
 REPORT EVENTS
 GSM RPRT RETRY
 MAST. DL CODE



Note
 The currently saved options are displayed with dark box at the right side of the display. To review the options, repeatedly click [Right Arrow] or [Left Arrow] until the desired option is displayed, then click OK (a dark box will be displayed at the right side).

Continues in next Figure

FIGURE 4.5 - DETAIL C continued

REPORT EVENTS
(see DETAIL C
in previous drawing)

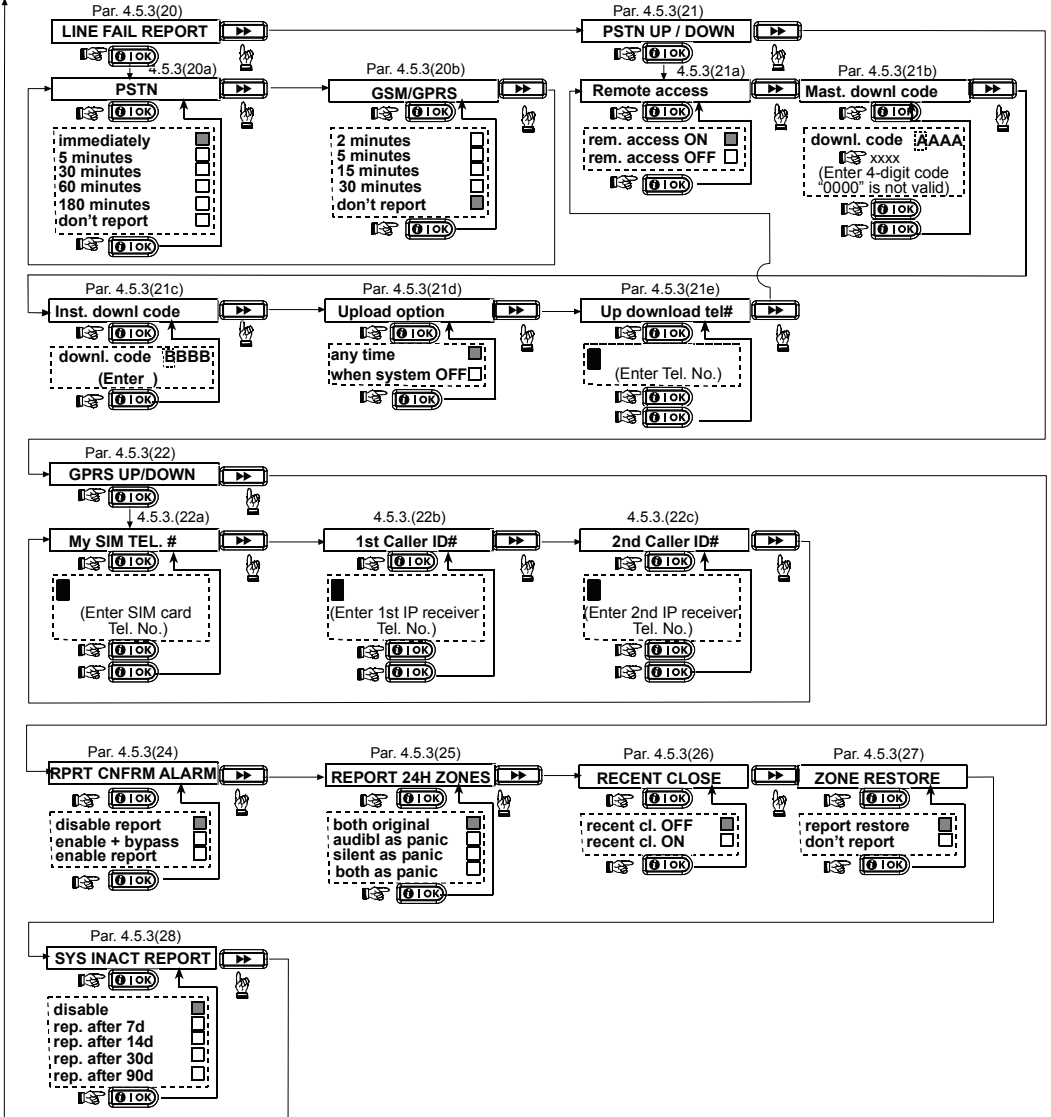
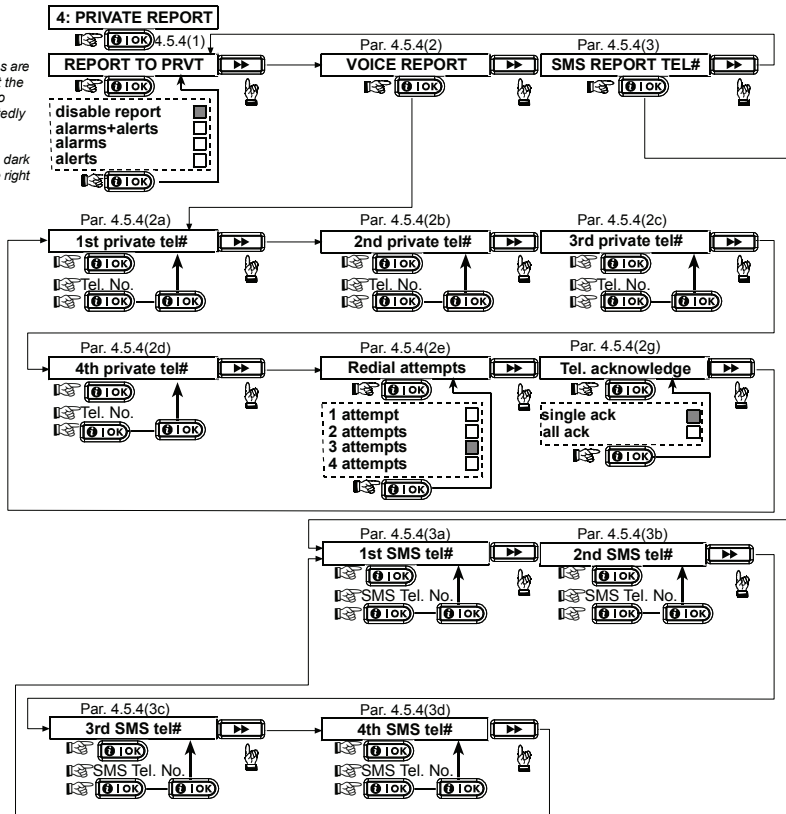

FIGURE 4.5 - DETAIL D

Note
The currently saved options are displayed with dark box at the right side of the display. To review the options, repeatedly click or until the desired option is displayed, then click OK (a dark box will be displayed at the right side).



4.6 GSM Auto Detection

The GSM/BBA modem auto detection feature enables automatic enrollment of the GSM modem into the PowerMaxExpress control panel memory. GSM modem auto detection is activated in one of two ways: after tamper restore and after reset (power-up or after exiting the installer menu). This causes the PowerMaxExpress to automatically scan GSM COM ports for the presence of the GSM modem.

In the event that the GSM modem auto detection fails and the modem was previously enrolled in the PowerMaxExpress control panel, the message "Cel Rmvd Cnfrm" will be displayed. This message will disappear from the display only after the user clicks . The modem is then considered as not enrolled and no GSM trouble message will be displayed.

Note: A message is displayed only when the PowerMaxExpress alarm system is disarmed.

4.7 BBA Auto Detection

The BBA modem auto detection feature enables automatic enrollment of the BBA modem into the PowerMaxExpress control panel memory. BBA modem auto detection is activated in one of two ways: after tamper restore and after reset (power-up or after exiting the installer menu). This causes the PowerMaxExpress to automatically scan BBA COM ports for the presence of the BBA modem.

In the event that the BBA modem auto detection fails and the modem was previously enrolled in the PowerMaxExpress control panel, the message "BBA Remvd Cnfrm" will be displayed. This message will disappear from the display only after the user clicks . The modem is then considered as not enrolled and no BBA trouble message will be displayed.

Note: A message is displayed only when the PowerMaxExpress alarm system is disarmed.

4.9 DEFINE CUSTOM

This mode allows you to define up to 5 zones names (in addition to the zone names that can be defined in the DEFINE ZONES mode - see par. 4.3).

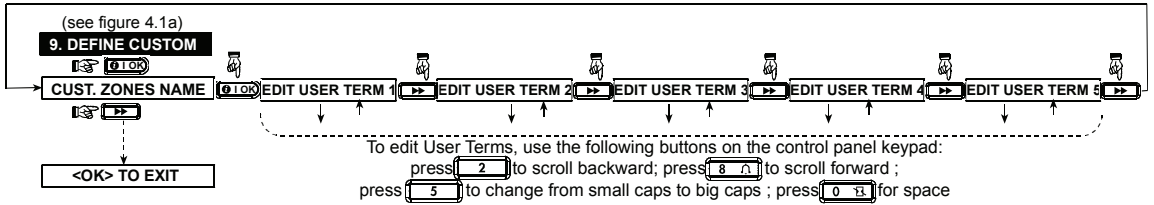

Figure 4.9 – Define Custom

4.10 DIAGNOSTIC TEST

This mode allows you to test the function of all protected area wireless sensors / wireless sirens / wireless keypads and to receive / review information regarding the received signal strength. Three reception levels are sensed and reported:
 Received Signal Strength Indication:

Reception	Buzzer Response
Strong	Happy Tune twice (- - -) (- - -)
Good	Happy Tune (- - -)
Poor	Sad tune (- - -)

The diagnostic test process is shown in figure 4.10.
 The following GSM/ GPRS messages are reported:

Message	Description
Unit is OK	GSM / GPRS functioning properly.
GSM comm. loss	The GSM/GPRS module does not communicate with the Panel
Pin code fail	Missing or wrong PIN code. (Only if SIM card PIN code is enabled.)
GSM net. fail	Unit failed with registration to local GSM network.
SIM card fail	SIM not installed or SIM card failure.
GSM not detected	GSM auto enroll failed to detect GSM/GPRS module.
No GPRS service	The SIM card does not have the GPRS service enabled.
GPRS conn. fail	Local GPRS network is not available or, wrong setting to GPRS APN, user and/or password.
Srvr unavailable	VDNS Receiver cannot be reached – Check the Server IP
IP not defined	Server IP #1 and #2 are not configured.
APN not defined	APN is not configured.
SIM card locked	After entering a wrong PIN code 3 consecutive times the SIM is locked. To unlock it enter a PUK number. The PUK number cannot be entered by the PowerMax Pro.
Denied by server	The VDNS denies the connection request. Check that the Panel is registered on the VDNS Receiver.

When you are instructed to perform "walk test", walk throughout the site to check the detectors / sensors. When a detector/sensor is triggered into alarm, its name, number and the alarm reception level should be indicated (for example, "Bathroom", "Z19 strong") and the buzzer should sound according to the alarm reception level (1 of 3).

IMPORTANT! Reliable reception must be assured. Therefore, a "poor" signal strength is not acceptable. If you get a "poor" signal from a certain detector, re-locate it and re-test until a "good" or "strong" signal strength is received. This principle should be followed during the initial testing and also throughout subsequent system maintenance.

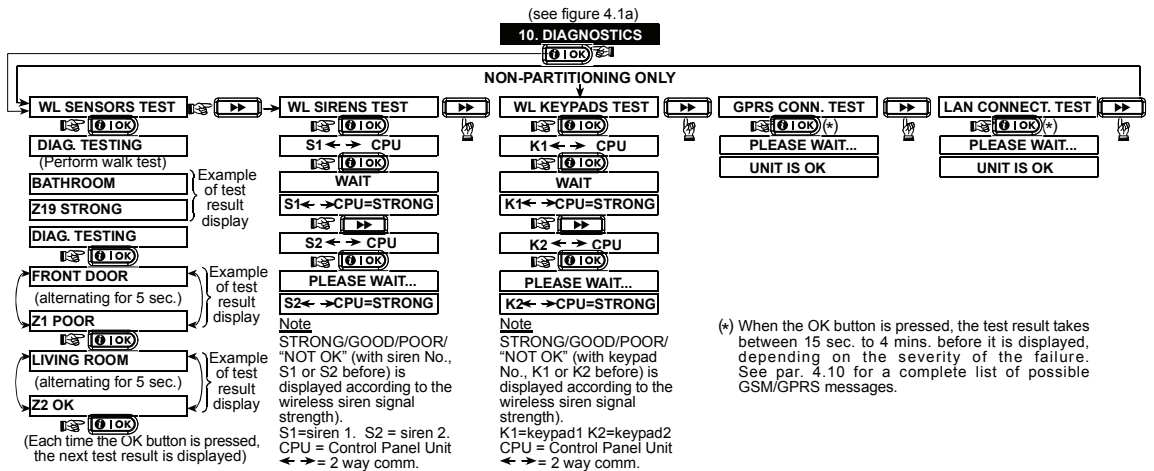

Figure 4.10 - Diagnostic Test Flow Chart

4.11 USER FUNCTIONS

This mode provides you with a gateway to the user functions through the regular user programming menu. You may:

- Program the 4 (private) telephone numbers
- Program user codes
- Enroll keyfobs
- Set the auto arm option
- Set arming time
- Set the squawk option

- Set the system time and time format
- Set the date and date format

Refer to the User Guide for detailed procedures.

Caution! If after having programmed the user codes the system does not recognize your installer code, this indicates you must have programmed a user code that is identical with your installer code. If so, access the user menu and change the code that is identical with your installer code. This will re-validate your installer code.

4.12 RETRIEVING FACTORY DEFAULTS

If you want to reset the PowerMaxExpress parameters to the factory default parameters, you should enter the installer menu and perform the "FACTORY DEFLT" function, as described in the right side illustration. To get the relevant parameters defaults, contact the PowerMaxExpress dealer.

Note: For PowerMaxExpress with 2 installer codes, *INSTALLER* code and *MASTER INSTALLER* code, only the *master installer code* enables to perform factory default function.

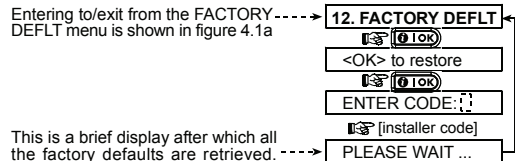

4.13 SERIAL NUMBER

The menu "13. SERIAL NUMBER" enables reading the system serial number and panel ID for support purposes only.

Panel ID is a unique number of the control panel that is used for registering the PowerMaxExpress to VDNS when using GPRS.

4.14 CALLING UPLOAD/DOWNLOAD SERVER

Note:

This option is only used during the installation of panels monitored by compatible central stations.

This option allows the installer to initiate a call to the upload/download server. The server uploads the PowerMaxExpress configuration to its data base and can unload predefined parameters to the PowerMaxExpress .

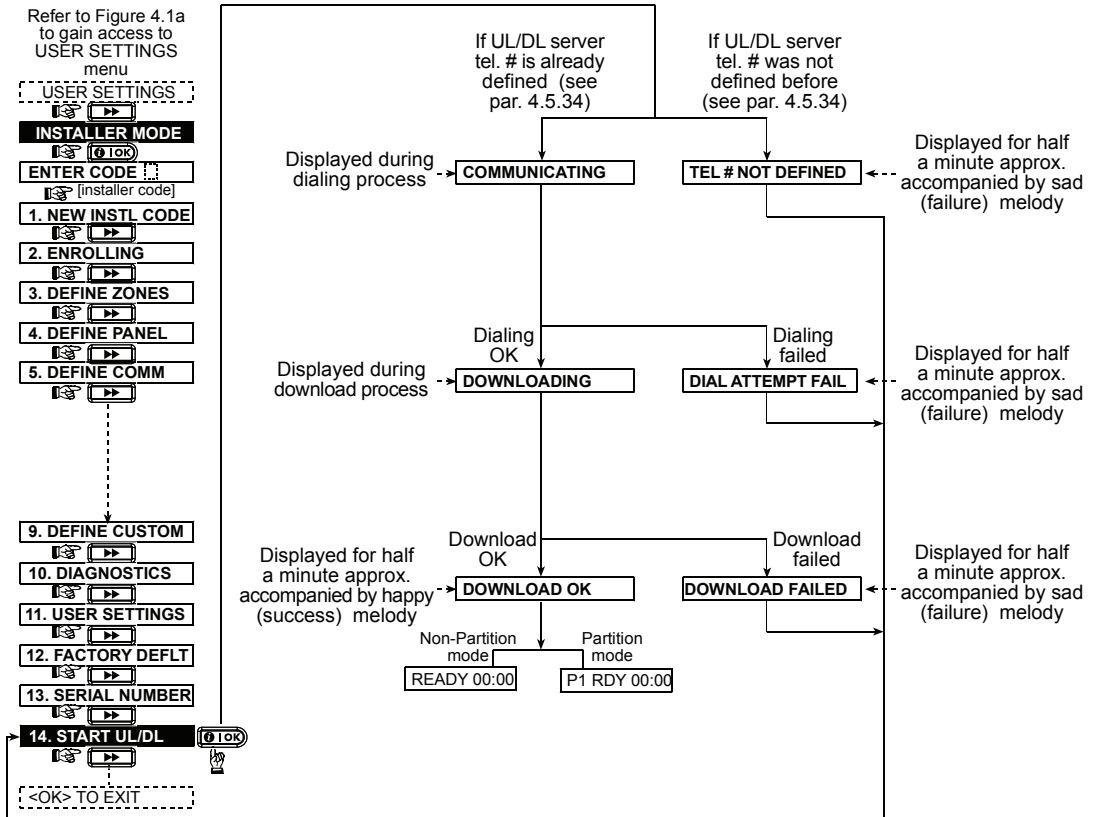
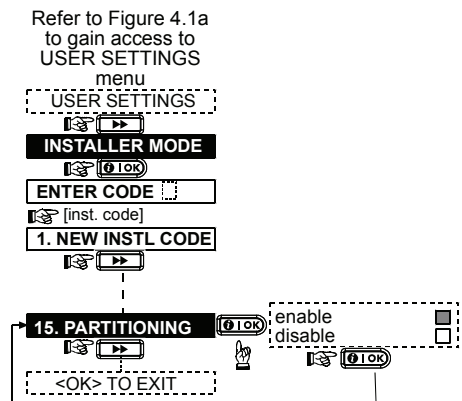

Figure 4.14 – Start UL/DL

4.15 ENABLING/DISABLING PARTITIONS

This mode allows you to enable/disable the partitioning feature (optional). Partitioning allows you to divide the system into a maximum of four independently controllable areas. A different user code is assigned to each partition in order to limit or control access to each area. A partition can also be armed or disarmed regardless of the status of the other partitions within the system.

When the partition feature is disabled, zones, user codes and features will operate the same as in a regular PowerMaxExpress unit. When partition is enabled, menu displays are changed to incorporate the partition feature.



Note: Partitioning is an optional feature

Figure 4.15 – Partitioning

4.16 WALK-TEST

This mode (see Figure 4.1a) provides you with the means to conduct a periodic test, via the walk-test menu, at least once a week and after an alarm event.

5. TESTING PROCEDURES

5.1 Preparations

Make sure all windows and doors are closed. If all zones are secured (undisturbed), the display should read:

READY HH : MM

If the display is "NOT READY", query the control panel by pressing the  button repeatedly. The source(s) of the problem(s) will be displayed and read aloud. Take the necessary measures to eliminate the problem(s) before testing the system (see next paragraph).

5.2 Diagnostic Test

To verify proper function of all detectors in the system, a comprehensive diagnostic test is required. To perform this test, refer to figure 4.10.

5.3 Keyfob Transmitter Test

Initiate transmission from each transmitter enrolled as a keyfob unit (according to the list in Table A2, Appendix A). Use each transmitter to arm the control panel AWAY and immediately disarm it. Upon pressing the keyfob unit's AWAY key, the ARM indicator should light.

The display should respond as follows:

ARMING AWAY
↓
PLEASE EXIT NOW

The exit delay beeps will begin.

Press the keyfob unit's DISARM () key. The ARM indicator should extinguish, the announcement "Disarm, ready to arm" should be heard and the display should revert to:

READY HH : MM

Test the AUX button in each keyfob in accordance with the

information noted in Table A.2, Appendix A. Verify that the AUX button performs its duty as programmed.



- If the AUX (*) button is defined as "INSTANT", press the AWAY button and then the AUX button. The response should be:

ARMING INSTANT

↺ (alternating) ↻

PLEASE EXIT NOW

and the exit delay beeps will start. Press the DISARM () key immediately to disarm.

- If the AUX (*) button is defined as "skip exit delay", press the AWAY button and while you hear the exit beeps press the AUX button – the exit beeps will be stopped immediately and the system will be armed AWAY. Press the DISARM key () immediately to disarm the system.

5.4 Emergency Transmitter Test

Initiate transmission from each transmitter enrolled to an emergency zone (according to the list in Table A3, Appendix A). For example, upon pressing the transmit button of an emergency transmitter enrolled to zone 22, the display should read:

Z 22 EMERGENCY

↺ (alternating) ↻

VIOLATED

It is advisable to let the central station know that you are conducting this test, or just disconnect the telephone line from the PowerMaxExpress during the test, to prevent false alarms.

6. MAINTENANCE

6.1 Dismounting the Control Panel

- Remove the screw that fastens the front unit to the back unit (see figure 3.1H).
- Remove the 3 screws that fasten the back unit to the mounting surface (see figure 3.1A) and remove the control panel.

6.2 Replacing the Backup Battery

Replacement and first-time insertion of battery pack is similar (see figure 3.1C).

With fresh battery pack, correct insertion and tightened battery compartment lid, the TROUBLE indicator should extinguish. However, the "MEMORY" message will now blink in the display (caused by the "tamper" alarm you triggered when opening the battery compartment lid). Clear it by arming the system and immediately disarming.

6.3 Fuse Replacement

The PowerMaxExpress has an internal fuse that has automatic reset. Therefore, there is no need to replace fuse.

When over current condition occurs, the fuse cuts off the circuit current. Upon fault current being removed for several seconds, the fuse is automatically reset and allows current flow through the circuit again.

6.4 Replacing/Relocating Detectors

Whenever maintenance work involves replacement or relocation of detectors, always perform a **full diagnostic test according to par. 4.10**.

Remember! A "poor" signal is not acceptable, as stated at the end of the test procedure.

7. READING THE EVENT LOG

Events are stored in the event log. You can access this log and review the events, one by one. If the event log fills up completely, the oldest event is deleted upon registration of each new event.

The date and time of occurrence are memorized for each event.

When reading the event log, events are shown in chronological order - from the newest to the oldest. Access to the event log is provided by clicking the  key and not through the installer's menu. Reading and erasing process of the event log is shown in the next drawing.

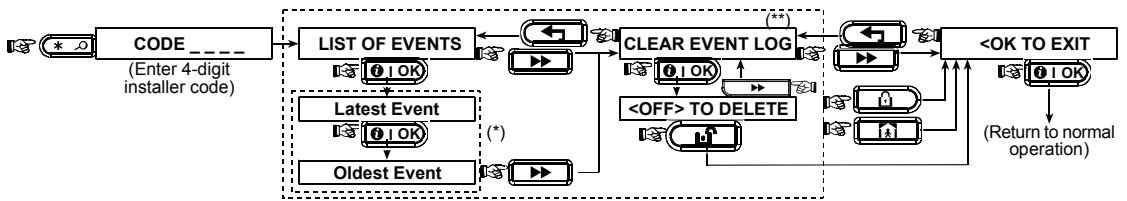

Figure 7 - Reading / Erasing the Event Log

- * While the system is in normal operation mode, click to review the event log.
- ** Event is displayed in 2 parts, for example, "Z13 alarm" then "09/02/00 3:37 P". The two displays will be shown alternately until clicking again to move to the next event or until the end of the event log (4 minutes).
- *** Applicable only if installer code is entered.

APPENDIX A. Detector Deployment & Transmitter Assignments

A1. Detector Deployment Plan

Zone No.	Zone Type	Sensor Location or Transmitter Assignment (in non-alarm or emergency zones)	Chime (Yes / No)
1			
2			
3			
4			
5			
6			
7			
8			
9			
10			
11			
12			
13			
14			
15			
16			
17			
18			
19			
20			
21			
22			
23			
24			
25			
26			
27			
28			
29 (*)			
30 (*)			

Zone Types: 1 = Interior follower * 2 = Perimeter * 3 = Perimeter follower * 4 = Delay 1 * 5 = Delay 2 * 6 = 24 h silent * 7 = 24 h audible * 8 = Fire * 9 = Non-alarm * 10 = Emergency * 11 = Gas * 12 = Flood * 13 = Interior * 14 = Temperature * 15 = Home / delay.

Zone Locations: Note down the intended location for each detector. When programming, you may select one of 26 available zone names (plus 5 custom zone names that you can add - see Figure 4.3 - Define Zones).

* Zones 29 only is hardwired zones.

A2. Keyfob Transmitter List

Transmitter Data			AUX button Assignments
No.	Type	Holder	Skip exit delay or Arming "instant"
1			Indicate the desired function (if any) – see par. 4.4.17 (Aux button).
2			
3			
4			
5			
6			Skip exit delay <input type="checkbox"/>
7			Arming "instant" <input type="checkbox"/>
8			

A3. Emergency Transmitter List

Tx #	Transmitter Type	Enrolled to Zone	Name of holder
1			
2			
3			
4			
5			
6			
7			
8			
9			
10			

A4. Non-Alarm Transmitter List

Tx #	Transmitter Type	Enrolled to Zone	Name of holder	Assignment
1				
2				
3				
4				
5				
6				
7				
8				
9				
10				

APPENDIX B. Event Codes

Contact ID Event Codes

Code	Definition	Code	Definition
101	Emergency	351	Telco fault
110	Fire	373	Fire detector trouble
120	Panic	381	Loss of supervision RF
121	Duress	383	Sensor tamper
122	Silent	384	RF low battery
123	Audible	393	Fire detector clean me
131	Perimeter	401	O/C by user
132	Interior	403	Auto arm
134	Entry/Exit	406	Cancel
137	Tamper/CP	408	Quick arm
139	Burglary verified	426	Door open event
151	Gas alarm	441	Armed home
154	Flood alarm	454	Fail to close
180	Gas trouble	455	Fail to arm
301	AC loss	456	Partial arm
302	Low system battery	459	Recent close event
311	Battery disconnect	570	Bypass
313	Engineer reset	602	Periodic test report
321	Bell	607	Walk test mode
344	RF receiver jam detect	641	Senior watch trouble
350	Communication trouble		

SIA Event Codes

Code	Definition	Code	Definition
AR	AC Restore	GJ	Gas trouble restore
AT	AC Trouble	HA	Holdup Alarm (duress)
BA	Burglary Alarm	LR	Phone Line Restore
BB	Burglary Bypass	LT	Phone Line Trouble
BC	Burglary Cancel	OP	Opening Report
BR	Burglary Restore	OT	Fail to Arm
BT	Burglary Trouble / Jamming	PA	Panic Alarm
BV	Burglary Verified	QA	Emergency Alarm
BZ	Missing Supervision	RN	Engineer Reset
CF	Forced Closing	RP	Automatic Test
CI	Fail to Close	RX	Manual Test
CL	Closing Report	RY	Exit from Manual Test
CP	Auto Arm	TA	Tamper Alarm
CR	Recent Close	TR	Tamper Restore
EA	Door Open	WA	Flood alarm
FA	Fire Alarm	WR	Flood alarm restore
FT	Fire Detector Clean	XR	Sensor Battery Restore
FJ	Fire detector trouble	XT	Sensor Battery Trouble
FR	Fire Restore	YR	System Battery Restore
GA	Gas alarm	YT	System Battery Trouble / Disconnection
GR	Gas alarm restore	YX	Service Required
GT	Gas trouble		

4/2 Event Codes

Note: The report to central station is on the following zones: First wireless siren - zone 31, second wireless siren - zone 32, GSM - zone 33, first 2-way keypad (MKP-150/MKP-151) - zone 35, second 2-way keypad (MKP-150/MKP-151) - zone 36.

Alarms

Zone #	1	2	3	4	5	6	7	8	9	10	11	12	13	14	15	16	17	18	19	20	21	22	23	24	25	26	27	28	29
1 st digit	4	4	4	4	4	4	4	4	4	4	4	4	4	4	4	5	5	5	5	5	5	5	5	5	5	5	5	5	5
2 nd digit	1	2	3	4	5	6	7	8	9	A	B	C	D	E	F	1	2	3	4	5	6	7	8	9	A	B	C	D	E

Restorals

Zone #	1	2	3	4	5	6	7	8	9	10	11	12	13	14	15	16	17	18	19	20	21	22	23	24	25	26	27	28	29
1 st digit	C	C	C	C	C	C	C	C	C	C	C	C	C	C	C	D	D	D	D	D	D	D	D	D	D	D	D	D	D
2 nd digit	1	2	3	4	5	6	7	8	9	A	B	C	D	E	F	1	2	3	4	5	6	7	8	9	A	B	C	D	E

Supervisory trouble

Zone #	1	2	3	4	5	6	7	8	9	10	11	12	13	14	15	16	17	18	19	20	21	22	23	24	25	26	27	28
1 st digit	6	6	6	6	6	6	6	6	6	6	6	6	6	6	6	7	7	7	7	7	7	7	7	7	7	7	7	7
2 nd digit	1	2	3	4	5	6	7	8	9	A	B	C	D	E	F	1	2	3	4	5	6	7	8	9	A	B	C	D

Low Battery

Zone #	1	2	3	4	5	6	7	8	9	10	11	12	13	14	15	16	17	18	19	20	21	22	23	24	25	26	27	28
1 st digit	8	8	8	8	8	8	8	8	8	8	8	8	8	8	8	9	9	9	9	9	9	9	9	9	9	9	9	9
2 nd digit	1	2	3	4	5	6	7	8	9	A	B	C	D	E	F	1	2	3	4	5	6	7	8	9	A	B	C	D

Forced Arming – 8 users

User No.	1	2	3	4	5	6	7	8
1 st digit	A	A	A	A	A	A	A	A
2 nd digit	1	2	3	4	5	6	7	8

Zone Bypass

Zone #	1	2	3	4	5	6	7	8	9	10	11	12	13	14	15	16	17	18	19	20	21	22	23	24	25	26	27	28	29
1 st digit	A	A	A	A	A	A	A	A	A	A	A	A	A	A	A	B	B	B	B	B	B	B	B	B	B	B	B	B	B
2 nd digit	1	2	3	4	5	6	7	8	9	A	B	C	D	E	F	1	2	3	4	5	6	7	8	9	A	B	C	D	E

Panic / 24 Hours - 8 users

User No.	1	2	3	4	5	6	7	8	Panic CP	Duress
1 st digit	2	2	2	2	2	2	2	2	2	2
2 nd digit	1	2	3	4	5	6	7	8	9	A

Arm HOME and AWAY (Closing)

User No.	1	2	3	4	5	6	7	8	Cancel alarm	Recent Close
1 st digit	E	E	E	E	E	E	E	E	E	E
2 nd digit	1	2	3	4	5	6	7	8	9	C

Disarm (Opening)

User No.	1	2	3	4	5	6	7	8
1 st digit	F	F	F	F	F	F	F	F
2 nd digit	1	2	3	4	5	6	7	8

Trouble

Event	Fuse Fail	Fuse Restore	Jamming	Jamming Restore	AC Failure	AC Restore	CPU Low Battery	CPU Low Battery Restore	CP Tamper
1 st digit	2	2	2	2	1	1	1	1	1
2 nd digit	C	D	E	F	1	2	3	4	6

Event	CP Tamper Restore	No Active	COMM. & LINE Restore	Enter Test	Exit Test	Auto Test
1 st digit	1	1	1	1	1	1
2 nd digit	7	8	A	D	E	F

Understanding the Scancom Reporting Protocol Data Format

The SCANCOM data format consists of 13 decimal digits divided into 4 groups, from left to right, as shown at the right side.

Each channel is associated with a specific event as follows:

- 1st "C": Fire
- 2nd "C": Personal attack
- 3rd "C": Intruder
- 4th "C": Open/close
- 5th "C": Alarm cancel
- 6th "C": Emergency
- 7th "C": Second alarm
- 8th "C": Trouble messages

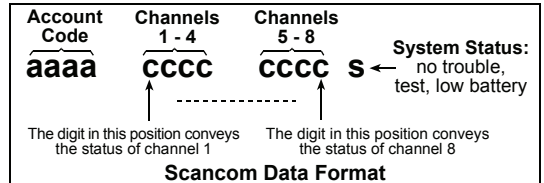

APPENDIX C. Programmable Zone Types

C1. Delay Zones

A delay zone has exit and entry delays set by you in the course of programming the system. Warning beeps will sound throughout these delays, unless you choose to mute them.

- **Exit Delay** - The exit delay begins once the user arms the system. It allows him to leave via interior zones and a doorway before arming actually takes effect. When the exit delay starts, the buzzer beeps slowly and maintains a slow beeping rate until the last 10 seconds, during which it beeps rapidly. The PowerMaxExpress has two types of delay zones, for which different delay times may be set.
- **Entry Delay** - The entry delay begins once the user enters the protected area via a specific doorway (his entry is sensed by a delay zone detector). To avoid an alarm, he must reach the keypad via interior zones (which become "follower zones" during the entry delay) and disarm the system before the delay expires. When the entry delay starts, the buzzer beeps slowly until the last 10 seconds, during which it beeps rapidly.

C2. Emergency Zones

You can provide incapacitated, sick or elderly people with a miniature single-button transmitter to be carried on the neck like a pendant or to be worn on the wrist like a watch. In distress situations, they can press the button on their transmitter, causing the PowerMaxExpress to send an **emergency call** to the central monitoring station or to private telephones designated by the installer.

To make this possible, define the required number of zones as emergency zones and enroll a portable transmitter to each one of these zones. When completed, ask the master user to distribute these transmitters to their potential users.

C3. Fire Zones

A fire zone uses smoke detectors and is permanently active (a fire alarm is triggered regardless of whether the system is armed or disarmed). Upon detection of smoke, a **pulsating siren** sounds immediately and the event is reported via the telephone line.

C4. Flood Zone

A flood zone is permanently active (a flood alarm is triggered regardless of whether the system is armed or disarmed). Upon detection of flood leak, the event is reported via the telephone line.

C5. Gas Zone

A gas zone is permanently active (a gas alarm is triggered regardless of whether the system is armed or disarmed). Upon detection of gas leak, the event is reported via the telephone line.

C6. Interior Zone

Interior zones are zones within the protected premises that have nothing to do with perimeter protection. Their most important feature is that they allow free movement within the protected area without initiating an alarm, provided that the system is armed in the "HOME" mode. People can therefore stay at home and move about freely, as long as they do not disturb a PERIMETER zone.

Once the system is armed in the AWAY mode (all zones are protected), interior zones will initiate an alarm if violated.

C7. Interior Follower Zones

"Interior Follower" zone is a zone that is located between entry/exit zone and the alarm system control panel. This zone is **temporarily** ignored by the alarm system during entry/exit delay periods, to enable you to walk (without causing an alarm) in front of a motion detector that is associated with the Interior Follower zone, after you enter through an entry zone on the way to the control panel, or when leaving the protected premises after system arming.

C8. Non-Alarm Zones

A non-alarm zone does not directly participate in the alarm system. It can be used for chime or for optional KEY ON-OFF feature (when enabled).

You can define the desired number of non-alarm zones and enroll a portable transmitter or a wireless device (detector) to this type of zone.

C9. Perimeter Zones

Perimeter zones rely on detectors designed to protect doors, windows and walls. An immediate alarm is initiated when such a zone is violated by opening the door/window or by trying to break the wall.

C10. Perimeter Follower Zones

A non-entry/exit zone, typically a perimeter zone located on an entry/exit path, that is treated as an entry/exit zone during an entry/exit time.

C11. 24-Hour Zones

24 hour zones are mainly used for PANIC buttons, perimeter detectors and anti-tamper protection. They therefore trigger an alarm in both armed and disarmed states.

- **24 Hour Zone - Silent.** - Upon detection, this zone initiates a silent alarm, meaning that the sirens do not function. Instead the PowerMaxExpress dials telephone numbers and reports the event to central stations and/or to private telephones, as programmed.
- **24 Hour Zone - Audible.** - Upon detection, this zone initiates a siren alarm. The PowerMaxExpress also dials telephone numbers and reports the event to central stations and/or to private telephones, as programmed.

APPENDIX D. PowerMaxExpress Compatible Devices

D1. PowerMaxExpress Compatible Detectors

Each detector compatible with the PowerMaxExpress system is packed with its own installation instructions. Read them carefully and install as indicated.

A. PIR Motion Detectors

The wireless passive infrared (PIR) motion detectors used in the system are of the PowerCode type. The PowerMaxExpress is capable of "learning" each detector's identification code and linking it to a specific zone (see par. 4.3 in this Guide). Some units are shown below:



NEXT®
K9-85 MCW



MCPIR-3000
or **K-940 MCW**

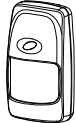

DISCOVERY
K9-80/MCW®

Note: K-940 MCW, Discovery K9-80/MCW and NEXT K9-85 MCW are pet immune units.

In addition to its unique 24-bit identification code, each detector transmits a message, containing status information:

- The detector is in alarm (or not).
- The detector is being tampered with (or not).
- The battery voltage is low (or normal).
- "This is a supervisory message".

If any of these detectors detects motion, it sends out a message to the alarm control panel. If the system is in the armed state, an alarm will be triggered.

B. Magnetic Contact Transmitter

MCT-302 is a PowerCode magnetic-contact transmitter used to detect the opening of a door or a window. The alarm contacts are closed as long as the door or window remains closed.

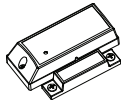

MCT-302

The unit has an extra alarm input that acts as if it were a separate wireless transmitter. It sends (or does not send) a "restored to normal" message to the alarm system, depending on the setting of an on-board "DIP" switch. The "restore" message informs you, through the control panel's display, whether the door or window is open or closed.

C. MCT-100 Wireless Adapter for Wired Detectors

MCT-100 is a PowerCode device used mainly as a wireless adapter for 2 regular magnetic switches installed on 2 windows in the same room. It has two inputs, behaving as separate wireless transmitters with different PowerCode IDs. Each input sends (or does not send) a "restored" message to the alarm system, depending on the setting of an on-board "DIP" switch.

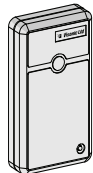

MCT-100

D. Wireless Smoke Detector

MCT-425. A photoelectric smoke detector equipped with a PowerCode-type transmitter. If enrolled to a fire zone, it initiates a fire alarm upon detection of smoke.



MCT-425

E. Glass Break Detector MCT-501

An acoustic detector equipped with a PowerCode-type transmitter. Since it restores automatically after detection, this unit does not send a restore message to the control panel.

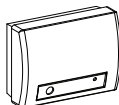

MCT-501

D2. PowerMaxExpress Compatible Transmitters

The PowerMaxExpress system is compatible with multi-button and single button key-ring and hand-held transmitters that use PowerCode and CodeSecure coding methods.

Multi-button PowerCode transmitters transmit the same code each time the same button is pressed. They can be used for emergency signaling. **They can not be used for arming / disarming.**

CodeSecure transmitters are of the rolling code type - they transmit a new code each time the same button is pressed. This provides a higher security level, especially in arming / disarming applications, because the code can not be copied ("grabbed") by unauthorized people.

Following are the basic details of several compatible transmitters. The possible applications for each push-button are indicated in each drawing.

A. MCT-234

'Keyfob' transmitter. You can program the AUX (auxiliary) button to perform various tasks, in accordance with the user's needs.

Pressing AWAY and HOME together for 2 sec. initiates PANIC alarm. Pressing AWAY for 2 sec. initiates Latchkey arming.

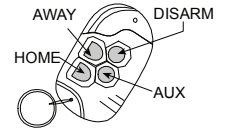

MCT-234

B. MCT-231 / 201*

(N.A. in North America) Single-button pendant units. The MCT-231 (Code-Secure) and the MCT-201 (PowerCode) can be enrolled to perform functions as shown. Both units look alike.

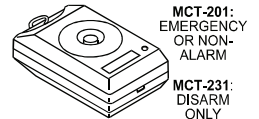

MCT-231 / 201

C. MCT-134 / 104*

(N.A. in North America) 4-button hand-held units. MCT-134 (CodeSecure) can replace the MCT-234 keyfob. MCT-104 (PowerCode) can perform emergency and non-alarm functions. Both units look alike.

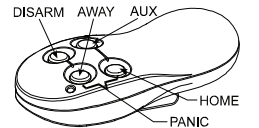

NOTE: BUTTON FUNCTIONS SHOWN ARE TRUE FOR MCT-134 ONLY

MCT-134 / 104

D. MCT-132 / 102*

(N.A. in North America) 2-button units. MCT-132 (CodeSecure) can perform functions as shown. MCT-102 (PowerCode) can perform emergency and non-alarm tasks. Both units look alike.

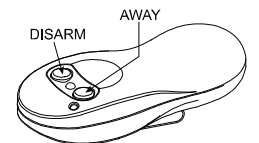

MCT-132 / 102

E. MCT-131 / 101*

(N.A. in North America) Single-button units. The MCT-131 (CodeSecure) and the MCT-101 (PowerCode) can be enrolled to perform functions as shown. Both units look alike.

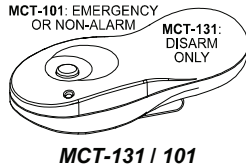

F. MCT-211*

Water-proof, wrist-worn Power-Code transmitter. Can be enrolled to perform emergency or non-alarm functions.



* Not UL listed.

D3. PowerMaxExpress Compatible WL Siren

The MCS-700/710 wireless siren can be integrated with the PowerMaxExpress in areas in which wiring action is difficult or impossible. The MCS-700/710 is a fully supervised, 2-way communication device (it includes a receiver, to receive activation commands from the alarm system, and a transmitter to periodically transmit its status signal to the alarm system).

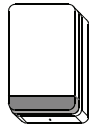

Wireless Siren

When an identifiable activation command is received from the PowerMaxExpress, the siren activates its sounder and the flash light (strobe light every 1.5 seconds).

Industry Canada Declaration

This product meets the applicable Industry Canada technical specifications/Le présent matériel est conforme aux spécifications techniques applicables d'Industrie Canada.

The Ringer Equivalence Number is an indication of the maximum number of devices allowed to be connected to a telephone interface. The termination on an interface may consist of any combination of devices subject only to the requirement that the sum of the RENs of all the devices does not exceed five/L'indice d'équivalence de la sonnerie (IES) sert à indiquer le nombre maximal de terminaux qui peuvent être raccordés à une interface téléphonique. La terminaison d'une interface peut consister en une combinaison quelconque de dispositifs, à la seule condition que la somme d'indices d'équivalence de la sonnerie de tous les dispositifs n'excède pas 5.

The Ringer Equivalence Number (REN) for this terminal equipment is 0.3B.

WARRANTY

Visonic Limited (the "Manufacturer") warrants this product only (the "Product") to the original purchaser only (the "Purchaser") against defective workmanship and materials under normal use of the Product for a period of twelve (12) months from the date of shipment by the Manufacturer.

This Warranty is absolutely conditional upon the Product having been properly installed, maintained and operated under conditions of normal use in accordance with the Manufacturers recommended installation and operation instructions. Products which have become defective for any other reason, according to the Manufacturers discretion, such as improper installation, failure to follow recommended installation and operational instructions, neglect, willful damage, misuse or vandalism, accidental damage, alteration or tampering, or repair by anyone other than the manufacturer, are not covered by this Warranty.

The Manufacturer does not represent that this Product may not be compromised and/or circumvented or that the Product will prevent any death and/or personal injury and/or damage to property resulting from burglary, robbery, fire or otherwise, or that the Product will in all cases provide adequate warning or protection. The Product, properly installed and maintained, only reduces the risk of such events without warning and it is not a guarantee or insurance that such events will not occur.

THIS WARRANTY IS EXCLUSIVE AND EXPRESSLY IN LIEU OF ALL OTHER WARRANTIES, OBLIGATIONS OR LIABILITIES, WHETHER WRITTEN, ORAL, EXPRESS OR IMPLIED, INCLUDING ANY WARRANTY OF MERCHANTABILITY OR FITNESS FOR A PARTICULAR PURPOSE, OR OTHERWISE. IN NO CASE SHALL THE MANUFACTURER BE LIABLE TO ANYONE FOR ANY CONSEQUENTIAL OR INCIDENTAL DAMAGES FOR BREACH OF THIS WARRANTY OR ANY OTHER WARRANTIES WHATSOEVER, AS AFORESAID.

THE MANUFACTURER SHALL IN NO EVENT BE LIABLE FOR ANY SPECIAL, INDIRECT, INCIDENTAL, CONSEQUENTIAL OR PUNITIVE DAMAGES OR FOR LOSS, DAMAGE, OR EXPENSE, INCLUDING LOSS OF USE, PROFITS, REVENUE, OR GOODWILL, DIRECTLY OR INDIRECTLY ARISING FROM PURCHASER'S USE OR INABILITY TO USE THE PRODUCT, OR FOR LOSS OR DESTRUCTION OF OTHER PROPERTY OR FROM ANY OTHER CAUSE, EVEN IF MANUFACTURER HAS BEEN ADVISED OF THE POSSIBILITY OF SUCH DAMAGE.

THE MANUFACTURER SHALL HAVE NO LIABILITY FOR ANY DEATH, PERSONAL AND/OR BODILY INJURY AND/OR DAMAGE TO PROPERTY OR OTHER LOSS WHETHER DIRECT, INDIRECT, INCIDENTAL, CONSEQUENTIAL OR OTHERWISE, BASED ON A CLAIM THAT THE PRODUCT FAILED TO FUNCTION.

However, if the Manufacturer is held liable, whether directly or indirectly, for any loss or damage arising under this limited warranty, **THE MANUFACTURER'S MAXIMUM LIABILITY (IF ANY) SHALL NOT IN ANY CASE EXCEED THE PURCHASE PRICE OF THE PRODUCT**, which shall be fixed as liquidated damages and not as a penalty, and shall be the complete and exclusive remedy against the Manufacturer.

When accepting the delivery of the Product, the Purchaser agrees to the said conditions of sale and warranty and he recognizes having been informed of. Some jurisdictions do not allow the exclusion or limitation of incidental or consequential damages, so these limitations may not apply under certain circumstances.

The Manufacturer shall be under no liability whatsoever arising out of the corruption and/or malfunctioning of any telecommunication or electronic equipment or any programs.

The Manufacturers obligations under this Warranty are limited solely to repair and/or replace at the Manufacturer's discretion any Product or part thereof that may prove defective. Any repair and/or replacement shall not extend the original Warranty period. The Manufacturer shall not be responsible for dismantling and/or reinstallation costs. To exercise this Warranty the Product must be returned to the Manufacturer freight pre-paid and insured. All freight and insurance costs are the responsibility of the Purchaser and are not included in this Warranty.

This warranty shall not be modified, varied or extended, and the Manufacturer does not authorize any person to act on its behalf in the modification, variation or extension of this warranty. This warranty shall apply to the Product only. All products, accessories or attachments of others used in conjunction with the Product, including batteries, shall be covered solely by their own warranty, if any. The Manufacturer shall not be liable for any damage or loss whatsoever, whether directly, indirectly, incidentally, consequentially or otherwise, caused by the malfunction of the Product due to products, accessories, or attachments of others, including batteries, used in conjunction with the Products. This Warranty is exclusive to the original Purchaser and is not assignable.

This Warranty is in addition to and does not affect your legal rights. Any provision in this warranty which is contrary to the Law in the state or country where the Product is supplied shall not apply.

Warning: The user must follow the Manufacturer's installation and operational instructions including testing the Product and its whole system at least once a week and to take all necessary precautions for his/her safety and the protection of his/her property.

1/08



VISONIC LTD. (ISRAEL): P.O.B 22020 TEL-AVIV 61220 ISRAEL. PHONE: (972-3) 645-6789, FAX: (972-3) 645-6788
VISONIC INC. (U.S.A.): 65 WEST DUDLEY TOWN ROAD, BLOOMFIELD CT. 06002-1376. PHONE: (860) 243-0833, (800) 223-0020. FAX: (860) 242-8094
VISONIC LTD. (UK): 7 COPPERHOUSE COURT, CALDECOTTE, MILTON KEYNES, MK7 8NL. PHONE: (0870) 7300800 FAX: (0870) 7300801 PRODUCT SUPPORT (0870) 7300830
VISONIC GMBH (D): KIRCHFELDSTR. 118, D-42015 DÜSSELDORF, GERMANY, FAX (0211) 60069619 Email: info-dach@visonic.com
VISONIC IBERICA: ISLA DE PALMA, 32 NAVE 7, POLÍGONO INDUSTRIAL NORTE, 28700 SAN SEBASTIÁN DE LOS REYES, (MADRID), ESPAÑA.
TEL (34) 91659-3120, FAX (34) 91663-8468. www.visonic-iberica.es

INTERNET: www.visonic.com

©VISONIC LTD. 2009 PowerMaxExpress Installer guide D-302017 (REV. 0, 2/09)

