



Hermon Laboratories Ltd.
Harakevet Industrial Zone, Binyamina 30500,
Israel
Tel. +972-4-6288001
Fax. +972-4-6288277
E-mail: mail@hermonlabs.com

TEST REPORT

ACCORDING TO: FCC 47CFR part 15 subpart C § 15.247 (FHSS) and subpart B,
RSS-247 issue 1, RSS-Gen issue 4, ICES-003 Issue 5:2012

FOR:

Visonic Ltd.
Control Panel
Model:PM-360
FCC ID:WP3PMMASTER360
IC:1467C-PMMASTER360

This report is in conformity with ISO/ IEC 17025. The "A2LA Accredited" symbol endorsement applies only to the tests and calibrations that are listed in the scope of Hermon Laboratories accreditation. The test results relate only to the items tested.
This test report shall not be reproduced in any form except in full with the written approval of Hermon Laboratories Ltd.

Table of contents

1	Applicant information	3
2	Equipment under test attributes	3
3	Manufacturer information	3
4	Test details	3
5	Tests summary	4
6	EUT description	5
6.1	General information	5
6.2	Ports and lines	5
6.3	Test configuration	5
6.4	Changes made in the EUT	5
6.5	EUT test positions	6
6.6	Transmitter characteristics	7
7	Transmitter tests according to 47CFR part 15 subpart C and RSS-247 requirements	8
7.1	20 dB bandwidth	8
7.2	Carrier frequency separation	12
7.3	Number of hopping frequencies	14
7.4	Average time of occupancy	17
7.5	Peak output power	20
7.6	Field strength of spurious emissions	29
7.7	Band edge radiated emissions	57
7.8	Antenna requirements	61
7.9	Conducted emissions	62
8	Unintentional emissions	65
8.1	Conducted emissions	65
8.2	Radiated emission measurements	69
9	APPENDIX A Test equipment and ancillaries used for tests	75
10	APPENDIX B Measurement uncertainties	77
11	APPENDIX C Test laboratory description	78
12	APPENDIX D Specification references	78
13	APPENDIX E Test equipment correction factors	79
14	APPENDIX F Abbreviations and acronyms	93

1 Applicant information

Client name: Visonic Ltd.
Address: 24 Habarzel street, Tel Aviv 69710, Israel
Telephone: +972 3645 6832
Fax: +972 3645 6788
E-mail: zurir@tycoint.com
Contact name: Mr. Zuri Rubin

2 Equipment under test attributes

Product name: Control Panel
Product type: Transceiver
Model(s): PM-360
Serial number: 1215140369
Hardware version: 90-207342
Software release: JS-702974
Receipt date: 12-Apr-15

3 Manufacturer information

Manufacturer name: Visonic Ltd.
Address: 24 Habarzel street, Tel Aviv 69710, Israel
Telephone: +972 3645 6832
Fax: +972 3645 6788
E-Mail: zurir@tycoint.com
Contact name: Mr. Zuri Rubin





4 Test details

Project ID: 26893
Location: Hermon Laboratories Ltd. Harakevet Industrial Zone, Binyamina 30500, Israel
Test started: 12-Apr-15
Test completed: 25-Aug-15
Test specification(s): FCC 47CFR part 15 subpart C § 15.247 (FHSS) and subpart B;
RSS-247 issue 1, RSS-Gen issue 4, ICES-003 issue 5:2012

5 Tests summary

Test	Status
Transmitter characteristics	
FCC section 15.247(a)1/ RSS-247 section 5.1(3), 20 dB bandwidth	Pass
FCC section 15.247(a)1/ RSS-247 section 5.1(2), Frequency separation	Pass
FCC section 15.247(a)1/ RSS-247 section 5.1(3), Number of hopping frequencies	Pass
FCC section 15.247(a)1/ RSS-247 section 5.1(3), Average time of occupancy	Pass
FCC section 15.247(b)/ RSS-247 section 5.4(1), Peak output power	Pass
FCC section 15.247(c)/ RSS-247 section 5.5, Radiated spurious emissions	Pass
FCC section 15.247(c)/ RSS-247 section 5.5, Emissions at band edges	Pass
FCC section 15.247(i)5/ RSS-102 section 2.5, RF exposure	Pass, the exhibit to the application of certification is provided
FCC section 15.203/ RSS-Gen section 8.3, Antenna requirements	Pass
FCC section 15.207(a)/ RSS-Gen section 8.8, Conducted emission	Pass
Unintentional emissions	
FCC section 15.107/ ICES-003, Section 6.1, Class B, Conducted emission at AC power port	Pass
FCC section 15.109/ RSS-Gen section 7.1.2 /ICES-003, Section 6.2, Class B, Radiated emission	Pass

Testing was completed against all relevant requirements of the test standard. The results obtained indicate that the product under test complies in full with the requirements tested. The test results relate only to the items tested. Pass/ fail decision was based on nominal values.

	Name and Title	Date	Signature
Tested by:	Mr. S. Samokha, test engineer Mrs. E. Pitt, test engineer	August 25, 2015	 
Reviewed by:	Mrs. M. Cherniavsky, certification engineer	September 9, 2015	
Approved by:	Mr. M. Nikishin, EMC and Radio group manager	February 11, 2016	

6 EUT description

6.1 General information

The EUT, Control panel PM-360 is wireless control panel powered via external AC/DC adaptor. The panel comprises four Visonic RF boards with below radio modules:

1. PG-2 module- communication within the alarm system in 902- 928 MHz band
2. WiFi module- approved by FCC ID:Z64-WL18SBMOD with Visonic antenna, connected to RF PCB
 - a. 802.11b
 - b. 802.11g
 - c. 802.11n
3. Z-wave module with Visonic antenna connected to RF board
4. Cellular module UE910NAR modular approved with FCC ID:RI7UE910NA, IC: 5131A-UE910NA used for 3G/2G modes with Visonic antenna connected to RF board.

All radios could operate simultaneously.

The present test report involves the test results for certification of 902 – 928 MHz transmitter as a part of a composite application for certification.

6.2 Ports and lines

Port type	Port description	Connected from	Connected to	Qty.	Cable type	Cable length, m
Power	AC power	AC mains	AC/DC adaptor	1	Unshielded	2.0

6.3 Test configuration

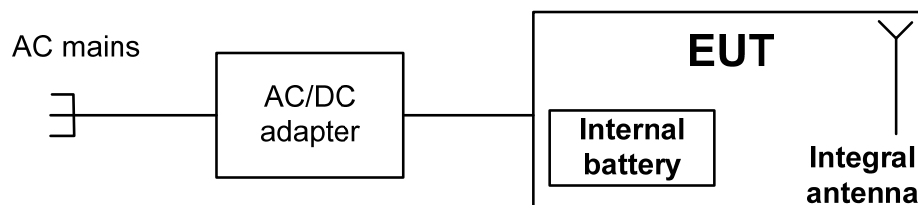

6.4 Changes made in the EUT

No changes were implemented in the EUT during the testing.

6.5 EUT test positions

Photograph 6.5.1 EUT in vertical position

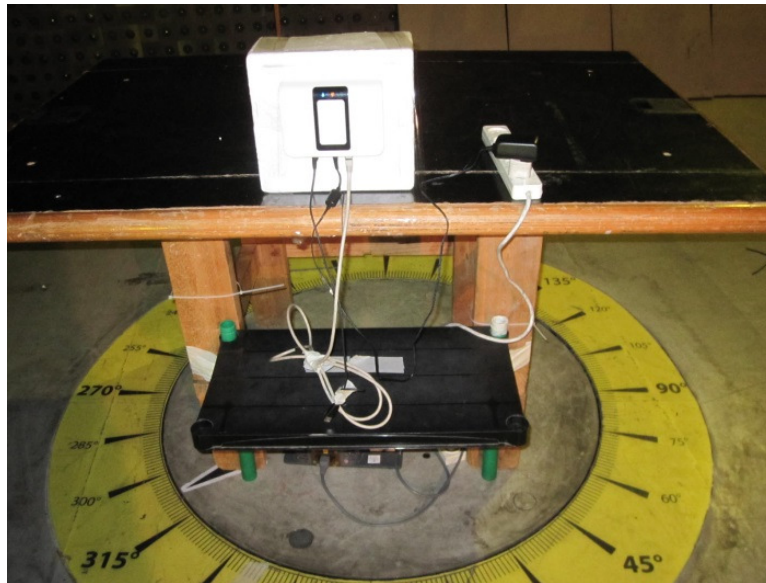

Photograph 6.5.2 EUT in horizontal position

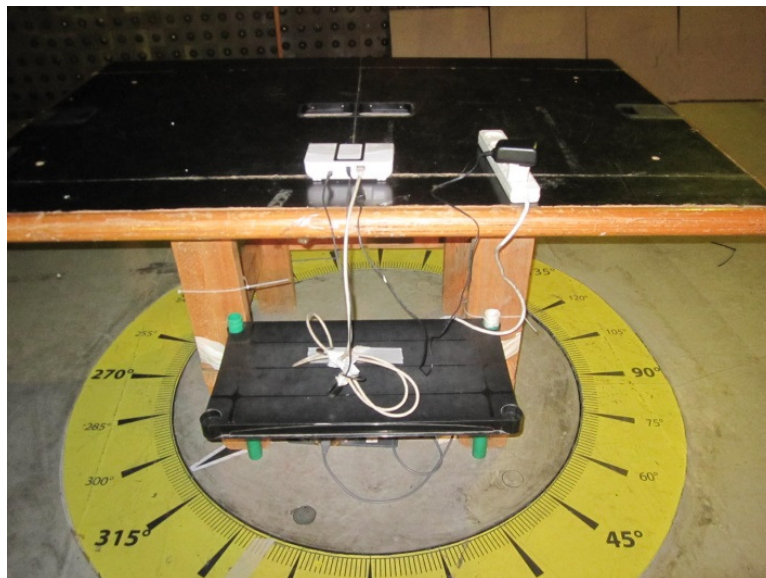



6.6 Transmitter characteristics

Type of equipment			
X	Stand-alone (Equipment with or without its own control provisions)		
	Combined equipment (Equipment where the radio part is fully integrated within another type of equipment)		
	Plug-in card (Equipment intended for a variety of host systems)		
Intended use		Condition of use	
	fixed	Always at a distance more than 2 m from all people	
X	mobile	Always at a distance more than 20 cm from all people	
	portable	May operate at a distance closer than 20 cm to human body	
Assigned frequency ranges		902 – 928 MHz	
Operating frequencies		912.750 – 919.106 MHz	
Maximum rated output power		At transmitter 50 Ω RF output connector	dBm
		Peak output power	21.45 dBm
Is transmitter output power variable?		X	No
			Yes
			continuous variable
			stepped variable with stepsize
	minimum RF power	dBm	
	maximum RF power	dBm	
Antenna connection			
unique coupling	standard connector	X	integral
			with temporary RF connector
			X without temporary RF connector
Antenna/s technical characteristics			
Type	Manufacturer	Model number	Gain
Integral	Visonic	Built-in wire antenna	-2 dBi
Transmitter aggregate data rate/s		50 kbps	
Type of modulation		GFSK	
Modulating test signal (baseband)		PRBS	
Transmitter power source			
	Battery	Nominal rated voltage	Battery type
	DC	Nominal rated voltage	Lithium
X	AC mains	Nominal rated voltage	Frequency
		120 VAC	
Common power source for transmitter and receiver		X	yes
			no
Spread spectrum technique used		X	Frequency hopping (FHSS)
			Digital transmission system (DTS)
			Hybrid
Spread spectrum parameters for transmitters tested per FCC 15.247 only			
FHSS	Total number of hops	50	
	Bandwidth per hop	104.7 kHz	
	Max. separation of hops	130.1 kHz	



Test specification: Section 15.247(a)1, RSS-247 section 5.1(3), 20 dB bandwidth			
Test procedure: Public notice DA 00-705			
Test mode: Compliance	Verdict: PASS		
Date(s): 22-Apr-15			
Temperature: 23 °C	Air Pressure: 1010 hPa	Relative Humidity: 60 %	Power Supply: 120 VAC
Remarks:			

7 Transmitter tests according to 47CFR part 15 subpart C and RSS-247 requirements

7.1 20 dB bandwidth

7.1.1 General

This test was performed to measure the 20 dB bandwidth of the transmitter hopping channel. Specification test limits are given in Table 7.1.1.

Table 7.1.1 The 20 dB bandwidth limits

Assigned frequency, MHz	Maximum bandwidth, kHz	Modulation envelope reference points*, dBc
902.0 – 928.0	250	20
2400.0 – 2483.5	NA	
5725.0 – 5850.0	1000	

* - Modulation envelope reference points provided in terms of attenuation below the peak of modulated carrier.

7.1.2 Test procedure

7.1.2.1 The EUT was set up as shown in Figure 7.1.1, energized and its proper operation was checked.

7.1.2.2 The EUT was set to transmit modulated carrier at maximum data rate.

7.1.2.3 The transmitter bandwidth was measured with spectrum analyzer as frequency delta between reference points on modulation envelope and provided in Table 7.1.2 and associated plot.

7.1.2.4 The test was repeated for each data rate and each modulation format.

Figure 7.1.1 The 20 dB bandwidth test setup





Test specification:	Section 15.247(a)1, RSS-247 section 5.1(3), 20 dB bandwidth		
Test procedure:	Public notice DA 00-705		
Test mode:	Compliance	Verdict: PASS	
Date(s):	22-Apr-15		
Temperature: 23 °C	Air Pressure: 1010 hPa	Relative Humidity: 60 %	Power Supply: 120 VAC
Remarks:			

Table 7.1.2 The 20 dB bandwidth test results

ASSIGNED FREQUENCY BAND: 902.0 – 928.0 MHz
DETECTOR USED: Peak
SWEEP TIME: Auto
VIDEO BANDWIDTH: ≥ RBW
MODULATION ENVELOPE REFERENCE POINTS: 20.0 dBc
FREQUENCY HOPPING: Disabled

Carrier frequency, MHz	Type of modulation	Data rate, kbps	Symbol rate, Msymbols/s	20 dB bandwidth, kHz	Limit, kHz	Margin, kHz	Verdict
912.750	QPSK	50	NA	103.613	250	-146.387	Pass
915.883				103.870	250	-146.130	Pass
919.106				104.685	250	-145.315	Pass

Reference numbers of test equipment used

HL 0337	HL 3818	HL 4136	HL 4273				
---------	---------	---------	---------	--	--	--	--

Full description is given in Appendix A.



Test specification:		Section 15.247(a)1, RSS-247 section 5.1(3), 20 dB bandwidth	
Test procedure:		Public notice DA 00-705	
Test mode:		Compliance	
Date(s):		22-Apr-15	
Temperature: 23 °C	Air Pressure: 1010 hPa	Relative Humidity: 60 %	Power Supply: 120 VAC
Remarks:			
		Verdict: PASS	

Plot 7.1.1 The 20 dB bandwidth test result at low frequency

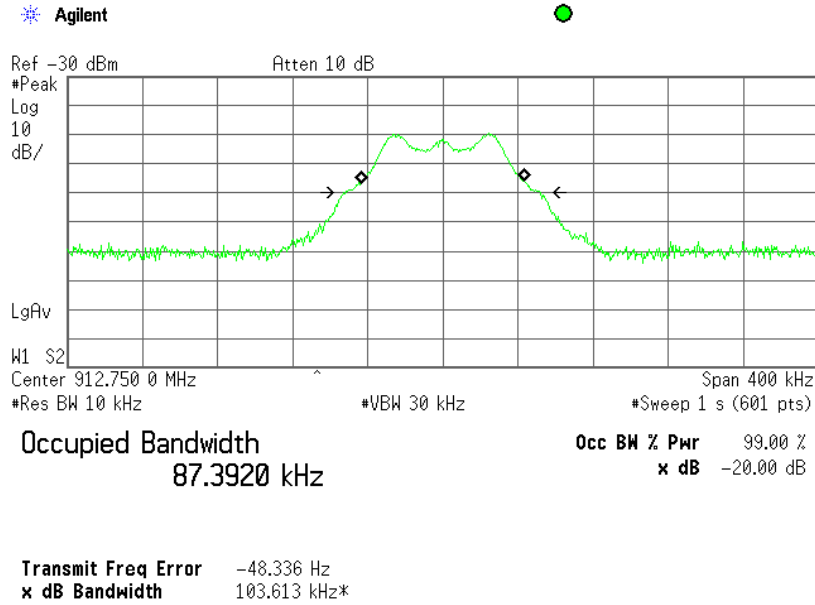

Plot 7.1.2 The 20 dB bandwidth test result at mid frequency

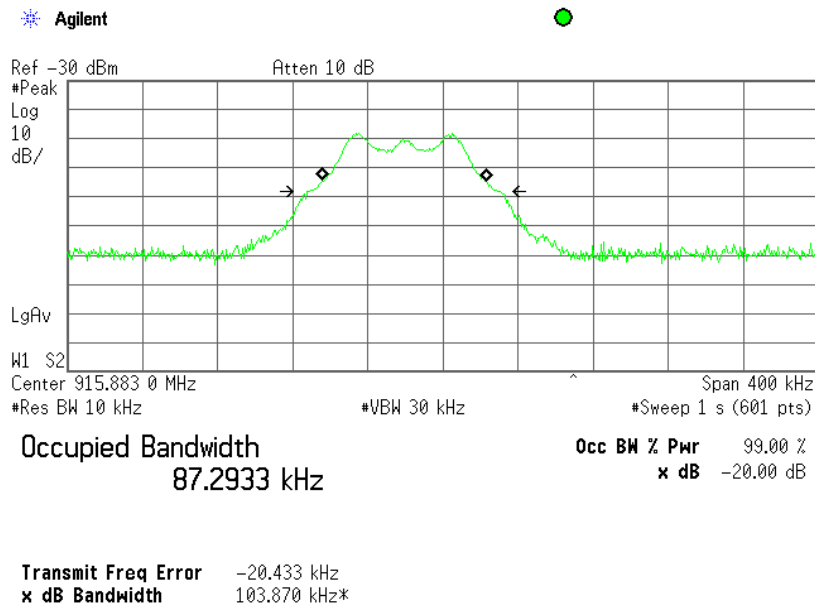



HERMON LABORATORIES

Test specification:	Section 15.247(a)1, RSS-247 section 5.1(3), 20 dB bandwidth		
Test procedure:	Public notice DA 00-705		
Test mode:	Compliance	Verdict:	PASS
Date(s):	22-Apr-15		
Temperature: 23 °C	Air Pressure: 1010 hPa	Relative Humidity: 60 %	Power Supply: 120 VAC
Remarks:			

Plot 7.1.3 The 20 dB bandwidth test result at high frequency

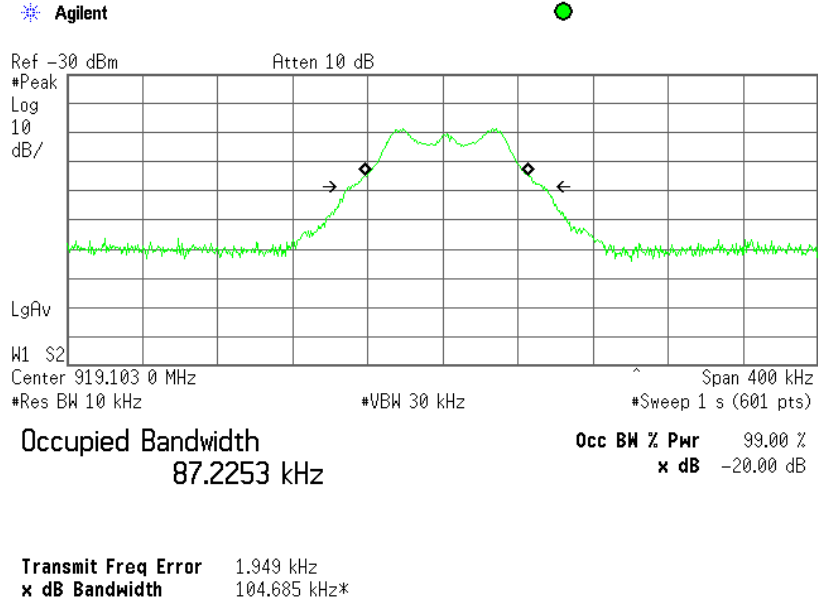



Test specification: Section 15.247(a)1, RSS-247 section 5.1(2), Frequency separation	
Test procedure: Public notice DA 00-705	
Test mode: Compliance	Verdict: PASS
Date(s): 16-Apr-15	
Temperature: 23.2 °C	Air Pressure: 1015 hPa
Relative Humidity: 50 %	
Power Supply: 120 VAC	
Remarks:	

7.2 Carrier frequency separation

7.2.1 General

This test was performed to measure frequency separation between the peaks of adjacent channels. Specification test limits are given in Table 7.2.1.

Table 7.2.1 Carrier frequency separation limits

Assigned frequency range, MHz	Carrier frequency separation	
	Output power 30 dBm	Output power 21 dBm
902.0 – 928.0	25 kHz or 20 dB bandwidth of the hopping channel, whichever is greater	25 kHz or two-thirds of the 20 dB bandwidth of the hopping channel, whichever is greater
2400.0 – 2483.5		
5725.0 – 5850.0		

7.2.2 Test procedure

- 7.2.2.1 The EUT was set up as shown in Figure 7.2.1, energized with frequency hopping function enabled and its proper operation was checked.
- 7.2.2.2 The spectrum analyzer span was set to capture the carrier frequency and both of adjacent channels, the lower and the higher. The resolution bandwidth was set wider than 1 % of the frequency span.
- 7.2.2.3 The spectrum analyzer was set in max hold mode and allowed trace to stabilize.
- 7.2.2.4 The frequency separation between the peaks of adjacent channels was measured as provided in Table 7.2.2 and associated plots.

Figure 7.2.1 Carrier frequency separation test setup





Test specification:	Section 15.247(a)1, RSS-247 section 5.1(2), Frequency separation		
Test procedure:	Public notice DA 00-705		
Test mode:	Compliance	Verdict: PASS	
Date(s):	16-Apr-15		
Temperature: 23.2 °C	Air Pressure: 1015 hPa	Relative Humidity: 50 %	Power Supply: 120 VAC
Remarks:			

Table 7.2.2 Carrier frequency separation test results

ASSIGNED FREQUENCY BAND: 902.0 – 928.0 MHz
 MODULATION: QPSK
 MODULATING SIGNAL: PRBS
 BIT RATE: 50 kbps
 DETECTOR USED: Peak
 RESOLUTION BANDWIDTH: ≥ 1% of the span
 VIDEO BANDWIDTH: ≥ RBW
 FREQUENCY HOPPING: Enabled
 20 dB BANDWIDTH: 104.68 kHz

Carrier frequency separation, kHz	Limit, kHz	Margin*	Verdict
130.1	104.68	25.42	Pass

* - Margin = Carrier frequency separation – specification limit.

Reference numbers of test equipment used

HL 0337	HL 3818	HL 4136	HL 4273			
---------	---------	---------	---------	--	--	--

Full description is given in Appendix A.

Plot 7.2.1 Carrier frequency separation

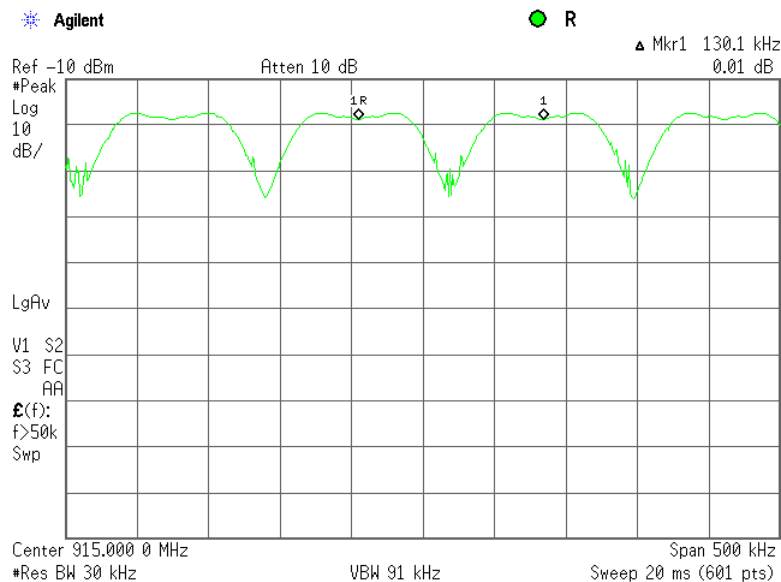



Test specification:	Section 15.247(a)1, RSS-247 section 5.1(3), Number of hopping frequencies		
Test procedure:	Public notice DA 00-705		
Test mode:	Compliance	Verdict:	PASS
Date(s):	16-Apr-15		
Temperature: 23.2 °C	Air Pressure: 1015 hPa	Relative Humidity: 50 %	Power Supply: 120 VAC
Remarks:			

7.3 Number of hopping frequencies

7.3.1 General

This test was performed to calculate the number of hopping frequencies used by the EUT. Specification test limits are given in Table 7.3.1.

Table 7.3.1 Minimum number of hopping frequencies

Assigned frequency range, MHz	Number of hopping frequencies
902.0 – 928.0	50 (if the 20 dB bandwidth is less than 250 kHz) 25 (if the 20 dB bandwidth is 250 kHz or greater)
2400.0 – 2483.5	15
5725.0 – 5850.0	75

7.3.2 Test procedure

7.3.2.1 The EUT was set up as shown in Figure 7.3.1, energized with frequency hopping function enabled and its proper operation was checked.

7.3.2.2 Initially the spectrum analyzer span was set equal to frequency band of operation and the resolution bandwidth was set wider than 1 % of the frequency span. If the separate hopping channels were not clearly resolved the frequency band of operation was broken to sections and the resolution bandwidth was set wider than 1 % of the frequency span of each section.

7.3.2.3 The spectrum analyzer was set in max hold mode and allowed trace to stabilize.

7.3.2.4 The number of frequency hopping channels was calculated as provided in Table 7.3.2 and the associated plots.

Figure 7.3.1 Hopping frequencies test setup





Test specification:	Section 15.247(a)1, RSS-247 section 5.1(3), Number of hopping frequencies		
Test procedure:	Public notice DA 00-705		
Test mode:	Compliance	Verdict:	PASS
Date(s):	16-Apr-15		
Temperature: 23.2 °C	Air Pressure: 1015 hPa	Relative Humidity: 50 %	Power Supply: 120 VAC
Remarks:			

Table 7.3.2 Hopping frequencies test results

ASSIGNED FREQUENCY BAND: 902.0 – 928.0 MHz
 MODULATION: FSK
 MODULATING SIGNAL: PRBS
 BIT RATE: 50 Mbpsk
 DETECTOR USED: Peak
 RESOLUTION BANDWIDTH: ≥ 1% of the span
 VIDEO BANDWIDTH: ≥ RBW
 FREQUENCY HOPPING: Enabled

Number of hopping frequencies	Minimum number of hopping frequencies	Margin*	Verdict
50	50	0	Pass

* - Margin = Number of hopping frequencies – Minimum number of hopping frequencies.

Reference numbers of test equipment used

HL 0337	HL 3818	HL 4136	HL 4273				
---------	---------	---------	---------	--	--	--	--

Full description is given in Appendix A.



HERMON LABORATORIES

Test specification:	Section 15.247(a)1, RSS-247 section 5.1(3), Number of hopping frequencies		
Test procedure:	Public notice DA 00-705		
Test mode:	Compliance	Verdict: PASS	
Date(s):	16-Apr-15		
Temperature: 23.2 °C	Air Pressure: 1015 hPa	Relative Humidity: 50 %	Power Supply: 120 VAC
Remarks:			

Plot 7.3.1 Number of hopping frequencies

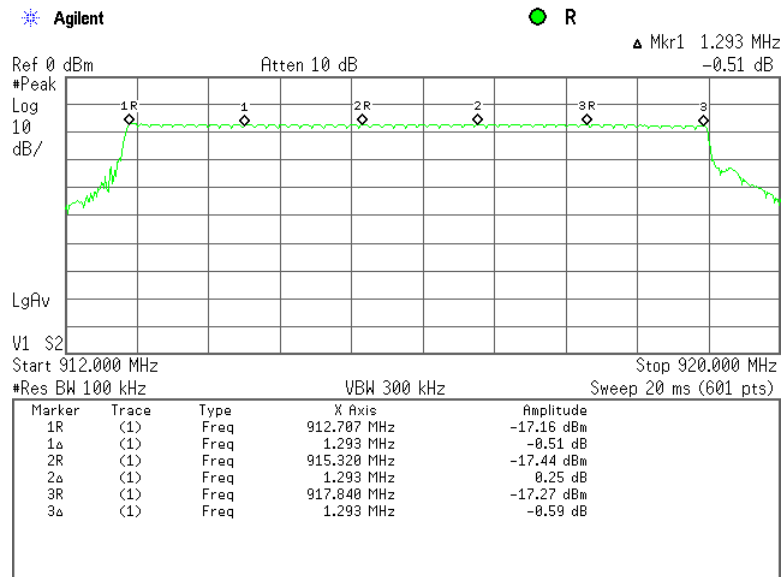

Plot 7.3.2 Full number of hopping frequencies

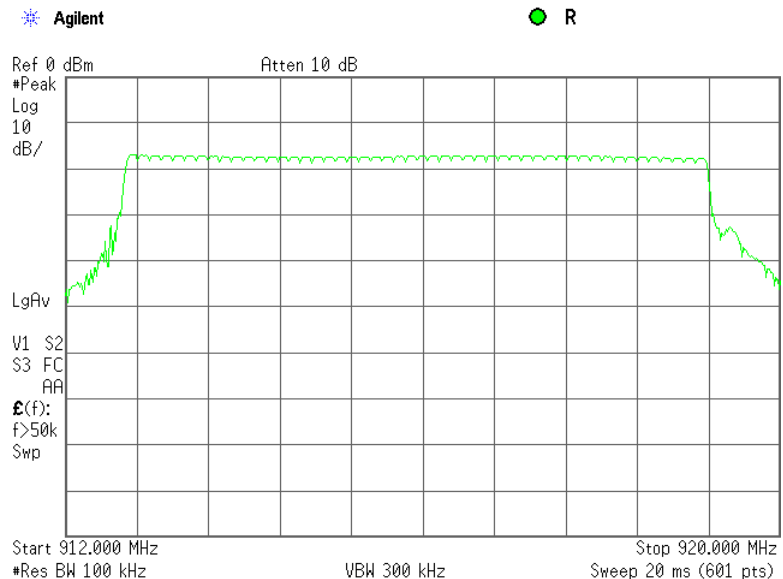



Test specification:		Section 15.247(a)1, RSS-247 section 5.1(3), Average time of occupancy	
Test procedure:		Public notice DA 00-705	
Test mode:		Compliance	
Date(s):		22-Apr-15	
Temperature: 23 °C		Air Pressure: 1010 hPa	
		Relative Humidity: 60 %	
		Power Supply: 120 VAC	
Remarks:			

7.4 Average time of occupancy

7.4.1 General

This test was performed to calculate the average time of occupancy (dwell time) on any frequency channel of the EUT. Specification test limits are given in Table 7.4.1.

Table 7.4.1 Average time of occupancy limits

Assigned frequency range, MHz	Maximum average time of occupancy, s	Investigated period, s	Number of hopping frequencies
902.0 – 928.0	0.4	20.0	≥ 50
902.0 – 928.0	0.4	10.0	< 50
2400.0 – 2483.5	0.4	0.4 × N	N (≥ 15)
5725.0 – 5850.0	0.4	30.0	≥ 75

7.4.2 Test procedure

7.4.2.1 The EUT was set up as shown in Figure 7.4.1, energized with frequency hopping function enabled and its proper operation was checked.

7.4.2.2 The spectrum analyzer span was set to zero centered on a hopping channel.

7.4.2.3 The single transmission duration and period were measured with oscilloscope.

7.4.2.4 The average time of occupancy was calculated as the single transmission time multiplied by the investigated period and divided by the single transmission period.

The test was repeated at each data rate and modulation type as provided in Table 7.4.2 and the associated plots.

Figure 7.4.1 Average time of occupancy test setup

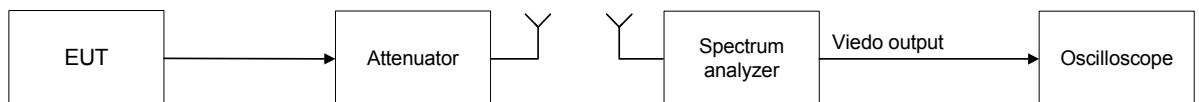



Test specification:		Section 15.247(a)1, RSS-247 section 5.1(3), Average time of occupancy	
Test procedure:		Public notice DA 00-705	
Test mode:		Compliance	
Date(s):		22-Apr-15	
Temperature: 23 °C		Air Pressure: 1010 hPa	
		Relative Humidity: 60 %	
		Power Supply: 120 VAC	
Remarks:			

Table 7.4.2 Average time of occupancy test results

ASSIGNED FREQUENCY BAND: 902-928 MHz
 MODULATION: QPSK
 DETECTOR USED: Peak
 RESOLUTION BANDWIDTH: 30 kHz
 VIDEO BANDWIDTH: 3 MHz
 NUMBER OF HOPPING FREQUENCIES: 50
 INVESTIGATED PERIOD: 20s
 FREQUENCY HOPPING: Enabled

Carrier frequency, MHz	Single transmission duration, ms	Number of transmissions during 20 s	Average time of occupancy*, s	Bit rate, kbps	Symbol rate, Msymbol/s	Limit, s	Margin, s**	Verdict
915.883	4.5	9	0.0405	50	NA	0.4	0.3595	Pass

* - Average time of occupancy = (Single transmission duration × Investigated period) / Single transmission period.

** - Margin = Average time of occupancy – specification limit.

Reference numbers of test equipment used

HL 3818							
---------	--	--	--	--	--	--	--

Full description is given in Appendix A.



Test specification:		Section 15.247(a)1, RSS-247 section 5.1(3), Average time of occupancy	
Test procedure:		Public notice DA 00-705	
Test mode:		Compliance	
Date(s):		22-Apr-15	
Temperature: 23 °C		Air Pressure: 1010 hPa	
		Relative Humidity: 60 %	
		Power Supply: 120 VAC	
Remarks:			
		Verdict: PASS	

Plot 7.4.1 Single transmission duration

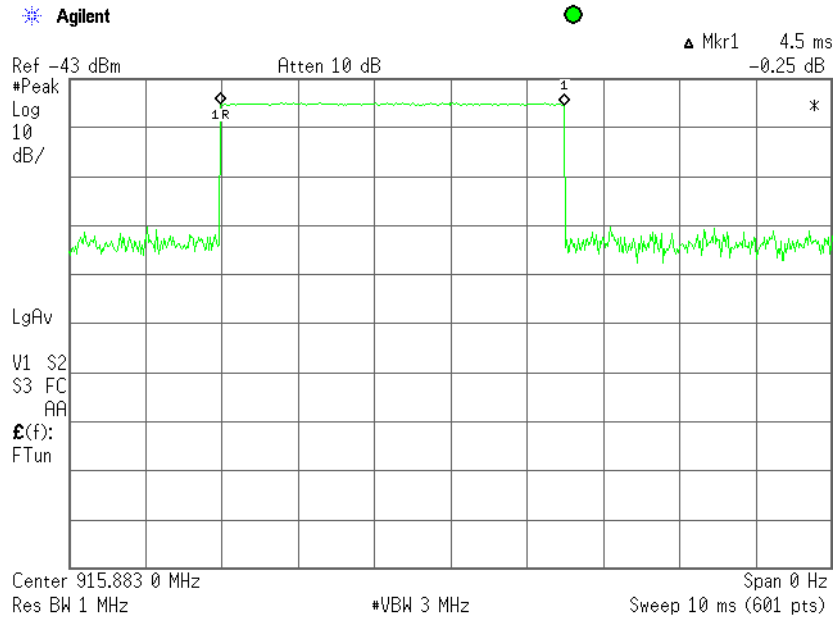

Plot 7.4.2 Number of transmissions

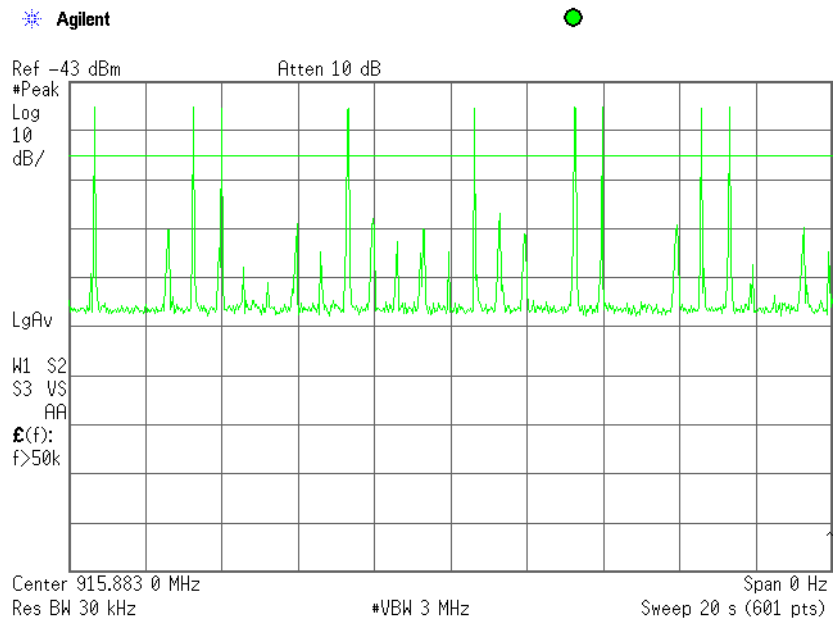



Test specification: Section 15.247(b), RSS-247 section 5.4(1), Peak output power	
Test procedure: Public notice DA 00-705	
Test mode: Compliance	Verdict: PASS
Date(s): 22-Apr-15	
Temperature: 23 °C	Air Pressure: 1010 hPa
Remarks:	

7.5 Peak output power

7.5.1 General

This test was performed to measure the maximum peak output power radiated by transmitter. Specification test limits are given in Table 7.5.1.

Table 7.5.1 Peak output power limits

Assigned frequency range, MHz	Peak output power*		Equivalent field strength limit @ 3m, dB(µV/m)*	Maximum antenna gain, dBi
	W	dBm		
902.0 – 928.0	0.25 (<50 hopping channels)	24.0(<50 hopping channels)	125.2 (<50 hopping channels)	6.0*
	1.0 (≥50 hopping channels)	30.0 (≥50 hopping channels)	131.2 (≥50 hopping channels)	
2400.0 – 2483.5	0.125 (<75 hopping channels)	21.0(<75 hopping channels)	122.2 (<75 hopping channels)	
	1.0 (≥75 hopping channels)	30.0 (≥75 hopping channels)	131.2 (≥75 hopping channels)	
5725.0 – 5850.0	1.0	30.0	131.2	

*- Equivalent field strength limit was calculated from the peak output power as follows: $E = \sqrt{30 \times P \times G} / r$, where P is peak output power in Watts, r is antenna to EUT distance in meters and G is transmitter antenna gain in dBi.

** - The limit is provided in terms of conducted RF power at the antenna connector. If transmitting antennas of directional gain greater than 6 dBi are used, the peak output power limit shall be reduced below the stated value as follows:

- by 1 dB for every 3 dB that the directional gain of antenna exceeds 6 dBi for fixed point-to-point transmitters operate in 2400-2483.5 MHz band;
- without any corresponding reduction for fixed point-to-point transmitters operate in 5725-5850 MHz band;
- by the amount in dB that the directional gain of antenna exceeds 6 dBi for the rest of transmitters.

7.5.2 Test procedure

7.5.2.1 The EUT was set up as shown in Figure 7.5.1, energized and its proper operation was checked.

7.5.2.2 The EUT was adjusted to produce maximum available to end user RF output power.

7.5.2.3 The frequency span of spectrum analyzer was set approximately 5 times wider than 20 dB bandwidth of the EUT and the resolution bandwidth was set wider than 20 dB bandwidth of the EUT. To find maximum radiation the turntable was rotated 360° and the measuring antenna height was swept in both vertical and horizontal polarizations.

7.5.2.4 The maximum field strength of the EUT carrier frequency was measured as provided in Table 7.5.2 and associated plots.

7.5.2.5 The maximum peak output power was calculated from the field strength of carrier as follows:

$$P = (E \times d)^2 / (30 \times G),$$

where P is the peak output power in W, E is the field strength in V/m, d is the test distance and G is the transmitter numeric antenna gain over an isotropic radiator.

The above equation was converted in logarithmic units for 3 m test distance:

$$\text{Peak output power in dBm} = \text{Field strength in dB}(\mu\text{V/m}) - \text{Transmitter antenna gain in dBi} - 95.2 \text{ dB}$$

7.5.2.6 The worst test results (the lowest margins) were recorded in Table 7.5.2.



Test specification:	Section 15.247(b), RSS-247 section 5.4(1), Peak output power		
Test procedure:	Public notice DA 00-705		
Test mode:	Compliance	Verdict:	PASS
Date(s):	22-Apr-15		
Temperature: 23 °C	Air Pressure: 1010 hPa	Relative Humidity: 62 %	Power Supply: 120 VAC
Remarks:			

Figure 7.5.1 Setup for carrier field strength measurements

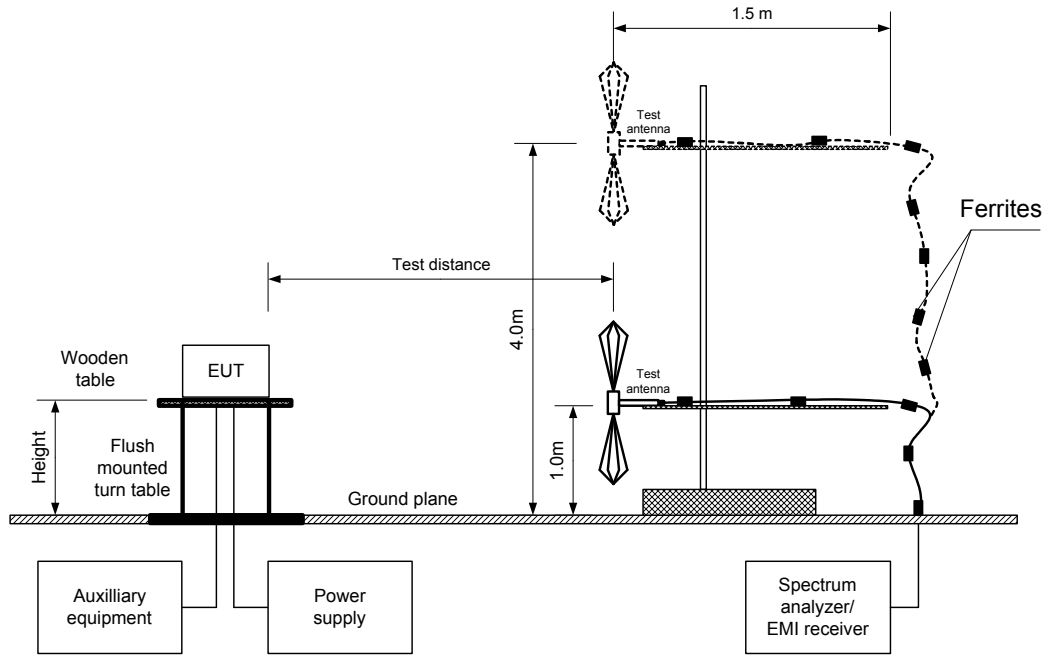



Test specification: Section 15.247(b), RSS-247 section 5.4(1), Peak output power	
Test procedure: Public notice DA 00-705	
Test mode: Compliance	Verdict: PASS
Date(s): 22-Apr-15	
Temperature: 23 °C	Air Pressure: 1010 hPa
Relative Humidity: 62 %	
Power Supply: 120 VAC	
Remarks:	

Table 7.5.2 Peak output power test results

ASSIGNED FREQUENCY BAND: 902-928 MHz
TEST DISTANCE: 3 m
TEST SITE: Semi anechoic chamber
EUT HEIGHT: 0.8 m
DETECTOR USED: Peak
TEST ANTENNA TYPE: Biconilog (30 MHz – 1000 MHz)
MODULATION: QPSK
BIT RATE: 50 kbps
DETECTOR USED: Peak
RESOLUTION BANDWIDTH: 120 kHz
VIDEO BANDWIDTH: 300 kHz
FREQUENCY HOPPING: Disabled

Frequency, MHz	Field strength, dB(μV/m)	Antenna polarization	Antenna height, m	Azimuth, degrees*	EUT antenna gain, dBi	Peak output power, dBm**	Limit, dBm	Margin, dB***	Verdict
912.722	114.65	Horizontal	1.3	10	-2	21.45	30.00	-8.55	Pass
915.836	113.51	Horizontal	1.2	30	-2	20.31	30.00	-9.69	Pass
919.079	112.99	Horizontal	1.4	360	-2	19.79	30.00	-10.21	Pass

*- EUT front panel refer to 0 degrees position of turntable.

** - Peak output power was calculated from the field strength of carrier as follows: $P = (E \times d)^2 / (30 \times G)$, where P is the peak output power in W, E is the field strength in V/m, d is the test distance in meters and G is the transmitter numeric antenna gain over an isotropic radiator. The above equation was converted in logarithmic units for 3 m test distance: Peak output power in dBm = Field strength in dB(μV/m) - Transmitter antenna gain in dBi - 95.2 dB

*** - Margin = Peak output power - specification limit.

Max value was recorded for EUT in vertical position.

Reference numbers of test equipment used

HL 0521	HL 0604	HL 4279	HL 4353				
---------	---------	---------	---------	--	--	--	--

Full description is given in Appendix A.



HERMON LABORATORIES

Test specification:		Section 15.247(b), RSS-247 section 5.4(1), Peak output power	
Test procedure:		Public notice DA 00-705	
Test mode:		Compliance	
Date(s):		22-Apr-15	
Temperature: 23 °C		Air Pressure: 1010 hPa	
		Relative Humidity: 62 %	
		Power Supply: 120 VAC	
Remarks:			
		Verdict: PASS	

Plot 7.5.1 Field strength of carrier at low frequency at vertical antenna polarization

EUT POSITION: Vertical



ACTV DET: PEAK
MEAS DET: PEAK OP AVG
MKR 912.7225 MHz
110.53 dBµV/m

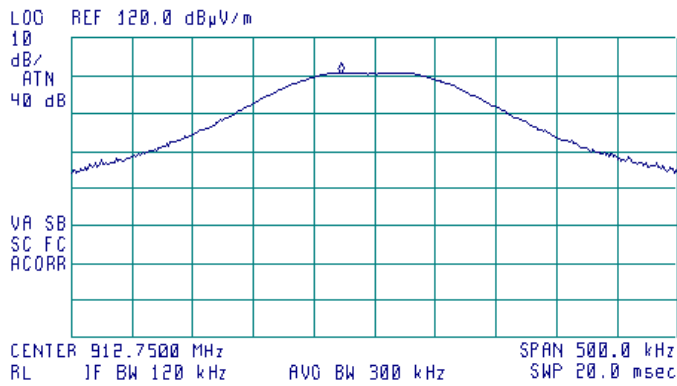

Plot 7.5.2 Field strength of carrier at low frequency at horizontal antenna polarization

EUT POSITION: Vertical



ACTV DET: PEAK
MEAS DET: PEAK OP AVG
MKR 912.7225 MHz
114.65 dBµV/m

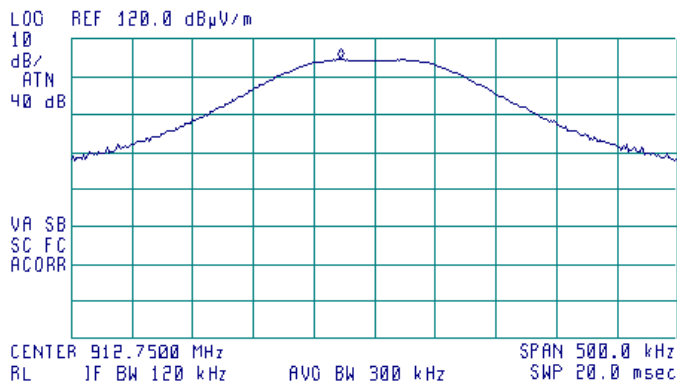



HERMON LABORATORIES

Test specification:		Section 15.247(b), RSS-247 section 5.4(1), Peak output power	
Test procedure:		Public notice DA 00-705	
Test mode:		Compliance	
Date(s):		22-Apr-15	
Temperature: 23 °C		Air Pressure: 1010 hPa	
		Relative Humidity: 62 %	
		Power Supply: 120 VAC	
Remarks:			
		Verdict: PASS	

Plot 7.5.3 Field strength of carrier at low frequency at vertical antenna polarization

EUT POSITION: Horizontal



ACTV DET: PEAK
MEAS DET: PEAK OP AVG
MKR 912.7725 MHz
107.59 dBµV/m

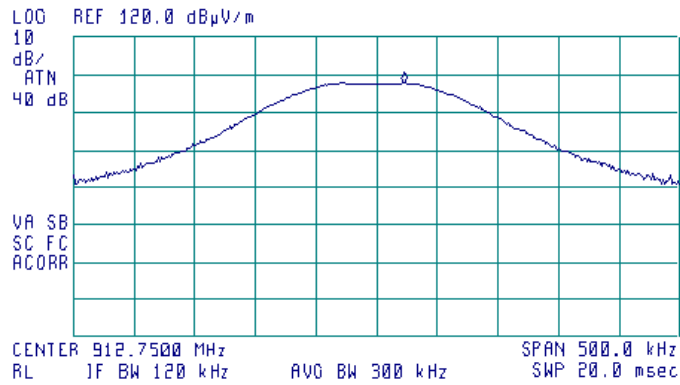

Plot 7.5.4 Field strength of carrier at low frequency at horizontal antenna polarization

EUT POSITION: Horizontal



ACTV DET: PEAK
MEAS DET: PEAK OP AVG
MKR 912.7175 MHz
113.36 dBµV/m

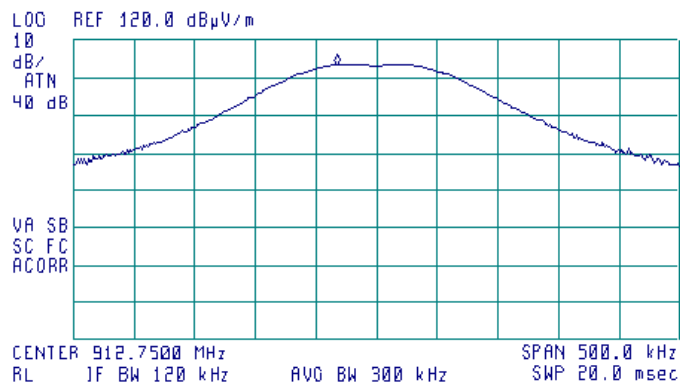



HERMON LABORATORIES

Test specification:		Section 15.247(b), RSS-247 section 5.4(1), Peak output power	
Test procedure:		Public notice DA 00-705	
Test mode:		Compliance	
Date(s):		22-Apr-15	
Temperature: 23 °C		Air Pressure: 1010 hPa	
		Relative Humidity: 62 %	
		Power Supply: 120 VAC	
Remarks:			
		Verdict: PASS	

Plot 7.5.5 Field strength of carrier at mid frequency at vertical antenna polarization

EUT POSITION: Vertical



ACTV DET: PEAK
MEAS DET: PEAK OP AVG
MKR 915.8368 MHz
111.02 dBµV/m

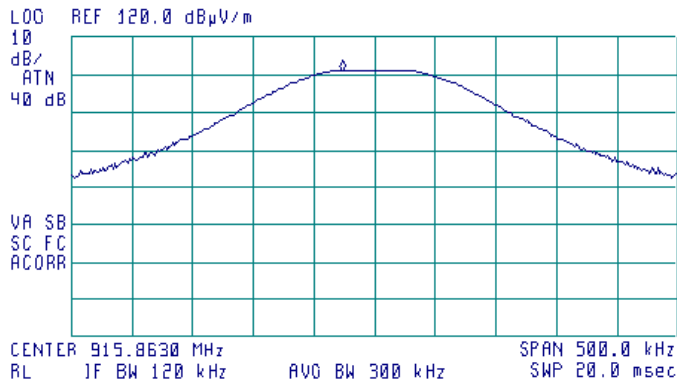

Plot 7.5.6 Field strength of carrier at mid frequency at horizontal antenna polarization

EUT POSITION: Vertical



ACTV DET: PEAK
MEAS DET: PEAK OP AVG
MKR 915.8368 MHz
113.51 dBµV/m

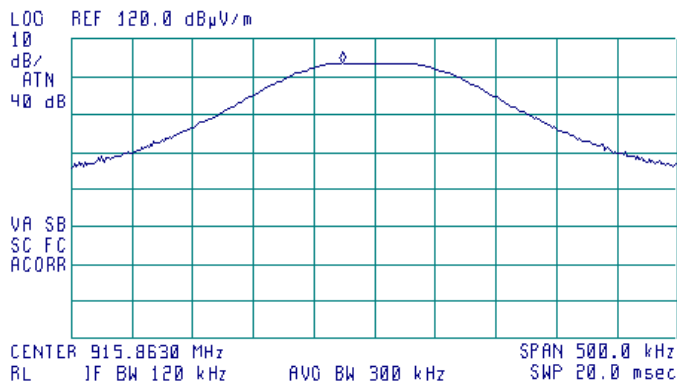



HERMON LABORATORIES

Test specification: Section 15.247(b), RSS-247 section 5.4(1), Peak output power			
Test procedure: Public notice DA 00-705			
Test mode: Compliance	Verdict: PASS		
Date(s): 22-Apr-15			
Temperature: 23 °C	Air Pressure: 1010 hPa	Relative Humidity: 62 %	Power Supply: 120 VAC
Remarks:			

Plot 7.5.7 Field strength of carrier at mid frequency at vertical antenna polarization

EUT POSITION: Horizontal



ACTV DET: PEAK
MEAS DET: PEAK OP AVG
MKR 915.8355 MHz
107.91 dBµV/m

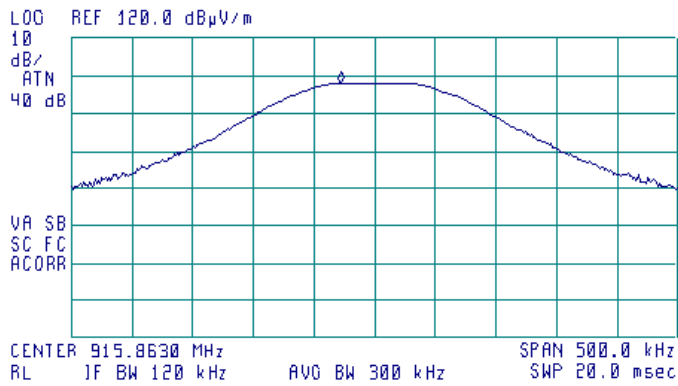

Plot 7.5.8 Field strength of carrier at mid frequency at horizontal antenna polarization

EUT POSITION: Horizontal



ACTV DET: PEAK
MEAS DET: PEAK OP AVG
MKR 915.8343 MHz
113.07 dBµV/m

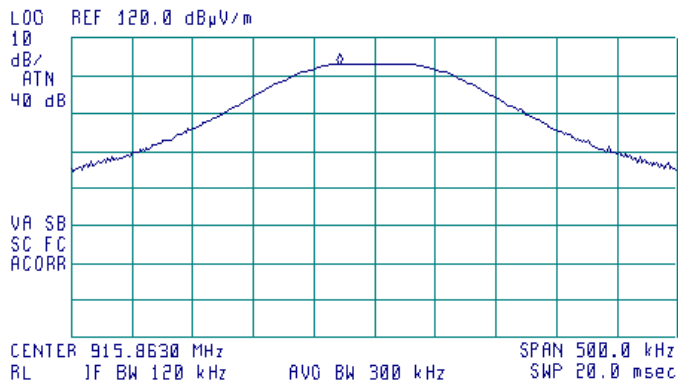



HERMON LABORATORIES

Test specification:		Section 15.247(b), RSS-247 section 5.4(1), Peak output power	
Test procedure:		Public notice DA 00-705	
Test mode:		Compliance	
Date(s):		22-Apr-15	
Temperature: 23 °C		Air Pressure: 1010 hPa	
		Relative Humidity: 62 %	
		Power Supply: 120 VAC	
Remarks:			
		Verdict: PASS	

Plot 7.5.9 Field strength of carrier at high frequency at vertical antenna polarization

EUT POSITION: Vertical



ACTV DET: PEAK
MEAS DET: PEAK OP AVG
MKR 919.0785 MHz
111.50 dBµV/m

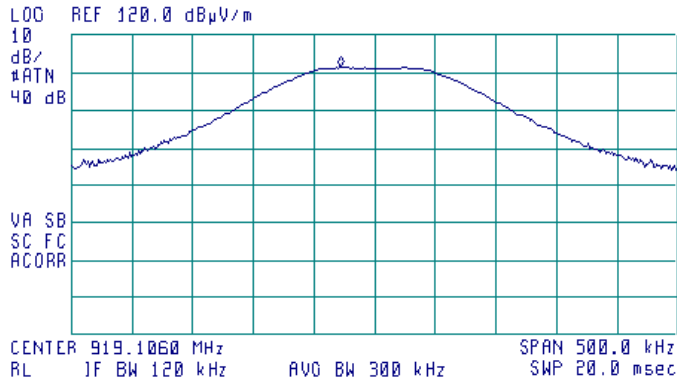

Plot 7.5.10 Field strength of carrier at high frequency at horizontal antenna polarization

EUT POSITION: Vertical



ACTV DET: PEAK
MEAS DET: PEAK OP AVG
MKR 919.0785 MHz
112.99 dBµV/m

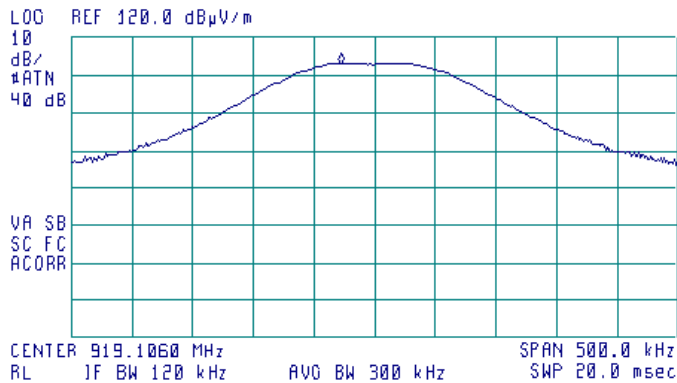



HERMON LABORATORIES

Test specification:		Section 15.247(b), RSS-247 section 5.4(1), Peak output power	
Test procedure:		Public notice DA 00-705	
Test mode:		Compliance	
Date(s):		22-Apr-15	
Temperature: 23 °C		Air Pressure: 1010 hPa	
		Relative Humidity: 62 %	
		Power Supply: 120 VAC	
Remarks:			
		Verdict: PASS	

Plot 7.5.11 Field strength of carrier at high frequency at vertical antenna polarization

EUT POSITION: Horizontal



ACTV DET: PEAK
MEAS DET: PEAK OP AVG
MKR 919.0785 MHz
106.89 dBµV/m

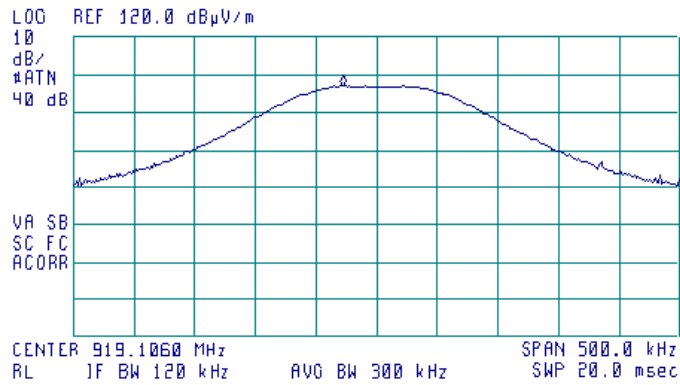

Plot 7.5.12 Field strength of carrier at high frequency at horizontal antenna polarization

EUT POSITION: Horizontal



ACTV DET: PEAK
MEAS DET: PEAK OP AVG
MKR 919.0735 MHz
111.36 dBµV/m

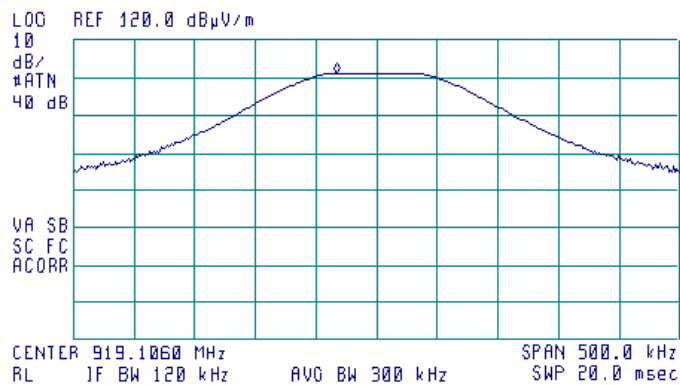



Test specification:	Section 15.247(d), RSS-247 section 5.5, Radiated spurious emissions		
Test procedure:	Public notice DA 00-705/ 47 CFR, Section 15.247(c) / ANSI C63.4, Section 13.1.4		
Test mode:	Compliance	Verdict:	PASS
Date(s):	12-Apr-15 - 25-Aug-15		
Temperature: 24 °C	Air Pressure: 1010 hPa	Relative Humidity: 56 %	Power Supply: 120 VAC
Remarks:			

7.6 Field strength of spurious emissions

7.6.1 General

This test was performed to measure field strength of spurious emissions from the EUT. Specification test limits are given in Table 7.6.1.

Table 7.6.1 Radiated spurious emissions limits

Frequency, MHz	Field strength at 3 m within restricted bands, dB(μV/m)*			Attenuation of field strength of spurious versus carrier outside restricted bands, dBc***
	Peak	Quasi Peak	Average	
0.009 – 0.090	148.5 – 128.5	NA	128.5 – 108.5**	20.0
0.090 – 0.110	NA	108.5 – 106.8**	NA	
0.110 – 0.490	126.8 – 113.8	NA	106.8 – 93.8**	
0.490 – 1.705	NA	73.8 – 63.0**	NA	
1.705 – 30.0*		69.5		
30 – 88		40.0		
88 – 216		43.5		
216 – 960		46.0		
960 - 1000		54.0		
1000 – 10 th harmonic	74.0	NA	54.0	

*- The limit for 3 m test distance was calculated using the inverse square distance extrapolation factor as follows:

$$\text{Lim}_{S_2} = \text{Lim}_{S_1} + 40 \log (S_1/S_2),$$

where S₁ and S₂ – standard defined and test distance respectively in meters.

** - The limit decreases linearly with the logarithm of frequency.

*** - The field strength limits applied from the lowest radio frequency generated in the device, without going below 9 kHz up to the tenth harmonic of the highest fundamental frequency.

7.6.2 Test procedure for spurious emission field strength measurements in 9 kHz to 30 MHz band

7.6.2.1 The EUT was set up as shown in Figure 7.6.1, energized and the performance check was conducted.

7.6.2.2 The specified frequency range was investigated with antenna connected to spectrum analyzer/ EMI receiver. To find maximum radiation the turntable was rotated 360° and the measuring antenna was rotated around its vertical axis.

7.6.2.3 The worst test results (the lowest margins) were recorded and shown in the associated plots.

7.6.3 Test procedure for spurious emission field strength measurements above 30 MHz

7.6.3.1 The EUT was set up as shown in Figure 7.6.2, energized and the performance check was conducted.

7.6.3.2 The specified frequency range was investigated with antenna connected to spectrum analyzer/ EMI receiver. To find maximum radiation the turntable was rotated 360°, the measuring antenna height was changed from 1 to 4 m, its polarization was switched from vertical to horizontal.

7.6.3.3 The worst test results (the lowest margins) were recorded and shown in the associated plots.



Test specification:	Section 15.247(d), RSS-247 section 5.5, Radiated spurious emissions		
Test procedure:	Public notice DA 00-705/ 47 CFR, Section 15.247(c) / ANSI C63.4, Section 13.1.4		
Test mode:	Compliance	Verdict:	PASS
Date(s):	12-Apr-15 - 25-Aug-15		
Temperature: 24 °C	Air Pressure: 1010 hPa	Relative Humidity: 56 %	Power Supply: 120 VAC
Remarks:			

Figure 7.6.1 Setup for spurious emission field strength measurements below 30 MHz

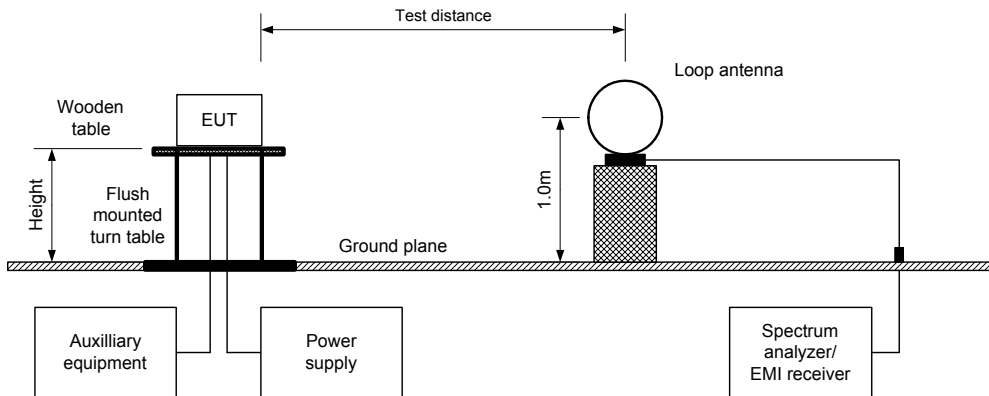
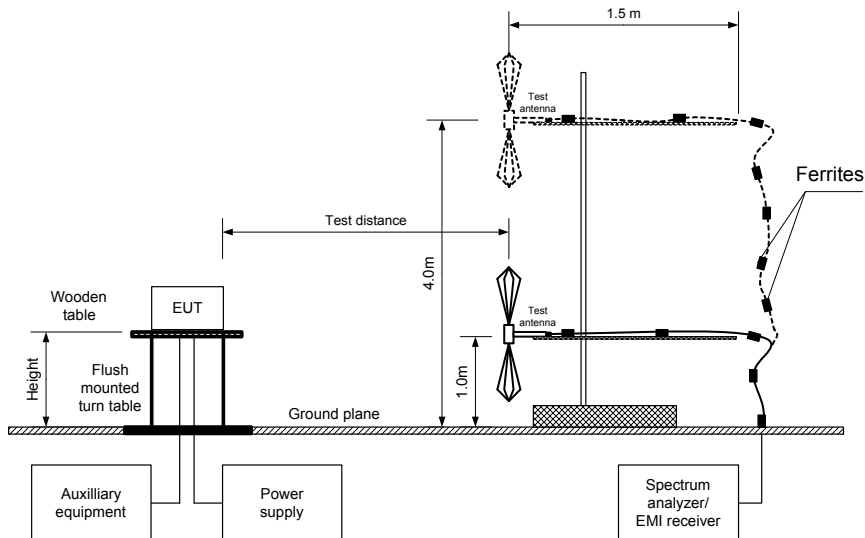

Figure 7.6.2 Setup for spurious emission field strength measurements above 30 MHz





Test specification:		Section 15.247(d), RSS-247 section 5.5, Radiated spurious emissions		
Test procedure:		Public notice DA 00-705/ 47 CFR, Section 15.247(c) / ANSI C63.4, Section 13.1.4		
Test mode:		Compliance		Verdict: PASS
Date(s):		12-Apr-15 - 25-Aug-15		
Temperature: 24 °C	Air Pressure: 1010 hPa	Relative Humidity: 56 %	Power Supply: 120 VAC	
Remarks:				

Table 7.6.2 Field strength of emissions outside restricted bands

ASSIGNED FREQUENCY BAND: 902-928 MHz
 INVESTIGATED FREQUENCY RANGE: 0.009 –9500 MHz
 TEST DISTANCE: 3 m
 MODULATION: GFSK
 BIT RATE: 50 kbps
 DUTY CYCLE: 100 %
 DETECTOR USED: Peak
 RESOLUTION BANDWIDTH: 100 kHz
 VIDEO BANDWIDTH: 300 kHz
 TEST ANTENNA TYPE: Active loop (9 kHz – 30 MHz)
 Biconilog (30 MHz – 1000 MHz)
 Double ridged guide (above 1000 MHz)

Frequency, MHz	Field strength of spurious, dB(µV/m)	Antenna polarization	Antenna height, m	Azimuth, degrees*	Field strength of carrier, dB(µV/m)	Attenuation below carrier, dBc	Limit, dBc	Margin, dB**	Verdict
Low carrier frequency									
1825.553	45.44	Vertical	1.0	30	114.65	69.21	20.0	49.21	Pass
5476.335	50.06	Horizontal	1.1	296		64.59		44.59	
6389.068	47.25	Horizontal	1.1	210		67.40		47.40	
Mid carrier frequency									
1831.774	48.63	Vertical	1.0	30	113.51	64.88	20	44.88	Pass
5495.323	49.87	Horizontal	1.1	287		63.64		43.64	
6411.203	52.38	Horizontal	1.1	195		61.13		41.13	
High carrier frequency									
1838.159	48.01	Vertical	1.0		112.99	64.98	20	44.98	Pass
5514.760	50.09	Horizontal	1.1	290		62.90		42.90	
6433.546	51.83	Horizontal	1.1	196		61.16		41.16	

*- EUT front panel refers to 0 degrees position of turntable.
 **- Margin = Attenuation below carrier – specification limit.



Test specification:	Section 15.247(d), RSS-247 section 5.5, Radiated spurious emissions		
Test procedure:	Public notice DA 00-705/ 47 CFR, Section 15.247(c) / ANSI C63.4, Section 13.1.4		
Test mode:	Compliance	Verdict: PASS	
Date(s):	12-Apr-15 - 25-Aug-15		
Temperature: 24 °C	Air Pressure: 1010 hPa	Relative Humidity: 56 %	Power Supply: 120 VAC
Remarks:			

Table 7.6.3 Field strength of spurious emissions above 1 GHz within restricted bands

ASSIGNED FREQUENCY BAND: 902-928 MHz
 INVESTIGATED FREQUENCY RANGE: 1000 - 9500 MHz
 TEST DISTANCE: 3 m
 MODULATION: GFSK
 BIT RATE: 50kbps
 DUTY CYCLE: 100 %
 DETECTOR USED: Peak
 RESOLUTION BANDWIDTH: 1000 kHz
 TEST ANTENNA TYPE: Double ridged guide

Frequency, MHz	Antenna		Azimuth, degrees*	Peak field strength(VBW=3 MHz)			Average field strength(VBW=10 Hz)				Verdict
	Polarization	Height, m		Measured, dB(μV/m)	Limit, dB(μV/m)	Margin, dB**	Measured, dB(μV/m)	Calculated, dB(μV/m)	Limit, dB(μV/m)	Margin, dB***	
Low carrier frequency											
2738.24	Horizontal	1.3	10	51.81	74	-22.19	50.83	23.83	54	-30.17	Pass
3651.01	Horizontal	1.1	42	42.96	74	-31.04	39.41	12.41	54	-41.59	
4563.73	Vertical	1,1	296	46.66	74	-27.34	44.57	17.57	54	-36.43	
7302.03	Horizontal	1.1	53	49.55	74	-24.45	42.94	15.94	54	-38.06	
8214.75	Horizontal	1.1	342	59.52	74	-14.48	56.99	29.99	54	-24.01	
9127.51	Horizontal	1.1	70	49.60	74	-24.40	40.19	13.19	54	-40.81	
Mid carrier frequency											
2747.58	Vertical	1,1	46	52.81	74	-21.19	52.04	25.04	54	-28.96	Pass
3663.47	Horizontal	1.4	345	54.51	74	-19.49	53.51	26.51	54	-27.49	
4579.30	Horizontal	1.4	25	49.41	74	-24.59	46.46	19.46	54	-34.54	
7326.91	Horizontal	1.0	34	50.10	74	-23.90	44.61	17.61	54	-36.39	
8242.78	Horizontal	1.0	322	62.29	74	-11.71	60.26	33.26	54	-20.74	
9158.64	Horizontal	1.0	175	49.24	74	-24.76	40.92	13.92	54	-40.08	
High carrier frequency											
2757.34	Horizontal	1.4	105	54.46	74	-19.54	53.74	26.74	54	-27.26	Pass
3676.26	Horizontal	1.3	330	43.62	74	-30.38	43.62	16.62	54	-37.38	
4595.56	Horizontal	1.3	350	41.84	74	-32.16	41.84	14.84	54	-39.16	
7352.86	Horizontal	1.1	45	50.65	74	-23.35	44.82	17.82	54	-36.18	
8271.96	Horizontal	1.1	330	65.00	74	-9.00	63.55	36.55	54	-17.45	
9191.07	Horizontal	1.1	60	50.47	74	-23.53	43.38	16.38	54	-37.62	

*- EUT front panel refers to 0 degrees position of turntable.
 **- Margin = Measured field strength - specification limit.
 ***- Margin = Calculated field strength - specification limit,
 where Calculated field strength = Measured field strength + average factor.

Table 7.6.4 Average factor calculation

Transmission pulse		Transmission burst		Transmission train duration, ms	Average factor, dB
Duration, ms	Number pulse during 100ms	Duration, ms	Period, ms		
4.5	1	NA	NA	NA	-27

*- Average factor was calculated as follows
 for pulse train shorter than 100 ms: $Average\ factor = 20 \times \log_{10} \left(\frac{Pulse\ duration}{Pulse\ period} \times \frac{Burst\ duration}{Train\ duration} \times Number\ of\ bursts\ within\ pulse\ train \right)$
 for pulse train longer than 100 ms: $Average\ factor = 20 \times \log_{10} \left(\frac{Pulse\ duration}{Pulse\ period} \times \frac{Burst\ duration}{100\ ms} \times Number\ of\ bursts\ within\ 100\ ms \right)$



Test specification:	Section 15.247(d), RSS-247 section 5.5, Radiated spurious emissions		
Test procedure:	Public notice DA 00-705/ 47 CFR, Section 15.247(c) / ANSI C63.4, Section 13.1.4		
Test mode:	Compliance	Verdict: PASS	
Date(s):	12-Apr-15 - 25-Aug-15		
Temperature: 24 °C	Air Pressure: 1010 hPa	Relative Humidity: 56 %	Power Supply: 120 VAC
Remarks:			

Table 7.6.5 Field strength of spurious emissions below 1 GHz within restricted bands

ASSIGNED FREQUENCY: 902-928 MHz
 INVESTIGATED FREQUENCY RANGE: 0.009 – 1000 MHz
 TEST DISTANCE: 3 m
 MODULATION: GFSK
 BIT RATE: 50kbps
 DUTY CYCLE: 100 %
 TRANSMITTER OUTPUT POWER SETTINGS: Maximum
 RESOLUTION BANDWIDTH: 1.0 kHz (9 kHz – 150 kHz)
 9.0 kHz (150 kHz – 30 MHz)
 120 kHz (30 MHz – 1000 MHz)
 VIDEO BANDWIDTH: > Resolution bandwidth
 TEST ANTENNA TYPE: Active loop (9 kHz – 30 MHz)
 Biconilog (30 MHz – 1000 MHz)

Frequency, MHz	Peak emission, dB(µV/m)	Quasi-peak			Antenna polarization	Antenna height, m	Turn-table position**, degrees	Verdict
		Measured emission, dB(µV/m)	Limit, dB(µV/m)	Margin, dB*				
No emission were found								

Verdict: Pass

*- Margin = Measured emission - specification limit.
**- EUT front panel refer to 0 degrees position of turntable.

Reference numbers of test equipment used

HL 0446	HL 4295	HL 4535	HL 4541	HL 4542	HL 4543	HL 4549	HL 4551
HL 4575	HL 4603	HL 4604					

Full description is given in Appendix A.



HERMON LABORATORIES

Test specification:	Section 15.247(d), RSS-247 section 5.5, Radiated spurious emissions		
Test procedure:	Public notice DA 00-705/ 47 CFR, Section 15.247(c) / ANSI C63.4, Section 13.1.4		
Test mode:	Compliance	Verdict: PASS	
Date(s):	12-Apr-15 - 25-Aug-15		
Temperature: 24 °C	Air Pressure: 1010 hPa	Relative Humidity: 56 %	Power Supply: 120 VAC
Remarks:			

Table 7.6.6 Restricted bands according to FCC section 15.205

MHz	MHz	MHz	MHz	MHz	GHz
0.09 - 0.11	8.37625 - 8.38675	73 - 74.6	399.9 - 410	2690 - 2900	10.6 - 12.7
0.495 - 0.505	8.41425 - 8.41475	74.8 - 75.2	608 - 614	3260 - 3267	13.25 - 13.4
2.1735 - 2.1905	12.29 - 12.293	108 - 121.94	960 - 1240	3332 - 3339	14.47 - 14.5
4.125 - 4.128	12.51975 - 12.52025	123 - 138	1300 - 1427	3345.8 - 3358	15.35 - 16.2
4.17725 - 4.17775	12.57675 - 12.57725	149.9 - 150.05	1435 - 1626.5	3600 - 4400	17.7 - 21.4
4.20725 - 4.20775	13.36 - 13.41	156.52475 - 156.52525	1645.5 - 1646.5	4500 - 5150	22.01 - 23.12
6.215 - 6.218	16.42 - 16.423	156.7 - 156.9	1660 - 1710	5350 - 5460	23.6 - 24
6.26775 - 6.26825	16.69475 - 16.69525	162.0125 - 167.17	1718.8 - 1722.2	7250 - 7750	31.2 - 31.8
6.31175 - 6.31225	16.80425 - 16.80475	167.72 - 173.2	2200 - 2300	8025 - 8500	36.43 - 36.5
8.291 - 8.294	25.5 - 25.67	240 - 285	2310 - 2390	9000 - 9200	Above 38.6
8.362 - 8.366	37.5 - 38.25	322 - 335.4	2483.5 - 2500	9300 - 9500	

Table 7.6.7 Restricted bands according to RSS-Gen

MHz	MHz	MHz	MHz	MHz	GHz
0.09 - 0.11	8.291 - 8.294	16.80425 - 16.80475	399.9 - 410	3260 - 3267	10.6 - 12.7
2.1735 - 2.1905	8.362 - 8.366	25.5 - 25.67	608 - 614	3332 - 3339	13.25 - 13.4
3.020 - 3.026	8.37625 - 8.38675	37.5 - 38.25	960 - 1427	3345.8 - 3358	14.47 - 14.5
4.125 - 4.128	8.41425 - 8.41475	73 - 74.6	1435 - 1626.5	3500 - 4400	15.35 - 16.2
4.17725 - 4.17775	12.29 - 12.293	74.8 - 75.2	1645.5 - 1646.5	4500 - 5150	17.7 - 21.4
4.20725 - 4.20775	12.51975 - 12.52025	108 - 138	1660 - 1710	5350 - 5460	22.01 - 23.12
5.677 - 5.683	12.57675 - 12.57725	156.52475 - 156.52525	1718.8 - 1722.2	7250 - 7750	23.6 - 24
6.215 - 6.218	13.36 - 13.41	156.7 - 156.9	2200 - 2300	8025 - 8500	31.2 - 31.8
6.26775 - 6.26825	16.42 - 16.423	240 - 285	2310 - 2390	9000 - 9200	36.43 - 36.5
6.31175 - 6.31225	16.69475 - 16.69525	322 - 335.4	2655 - 2900	9300 - 9500	Above 38.6



HERMON LABORATORIES

Test specification:	Section 15.247(d), RSS-247 section 5.5, Radiated spurious emissions		
Test procedure:	Public notice DA 00-705/ 47 CFR, Section 15.247(c) / ANSI C63.4, Section 13.1.4		
Test mode:	Compliance	Verdict:	PASS
Date(s):	12-Apr-15 - 25-Aug-15		
Temperature: 24 °C	Air Pressure: 1010 hPa	Relative Humidity: 56 %	Power Supply: 120 VAC
Remarks:			

Plot 7.6.1 Radiated emission measurements at the low carrier frequency

TEST SITE: Semi Anechoic chamber
TEST DISTANCE: 3 m
ANTENNA POLARIZATION: Vertical & Horizontal

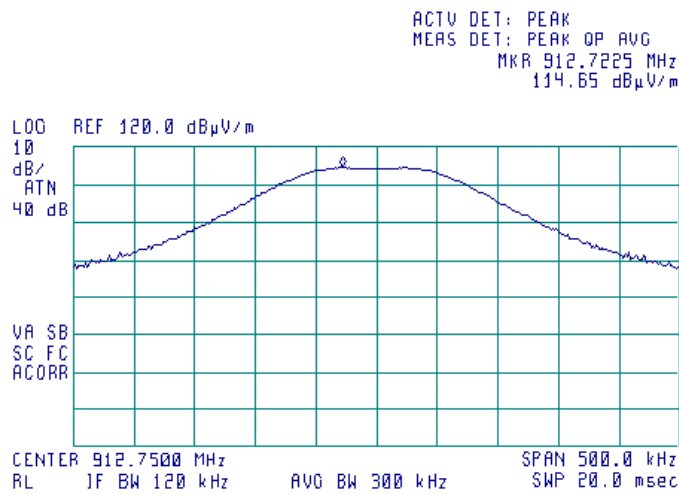

Plot 7.6.2 Radiated emission measurements at the mid carrier frequency

TEST SITE: Semi anechoic chamber
TEST DISTANCE: 3 m
ANTENNA POLARIZATION: Vertical & Horizontal

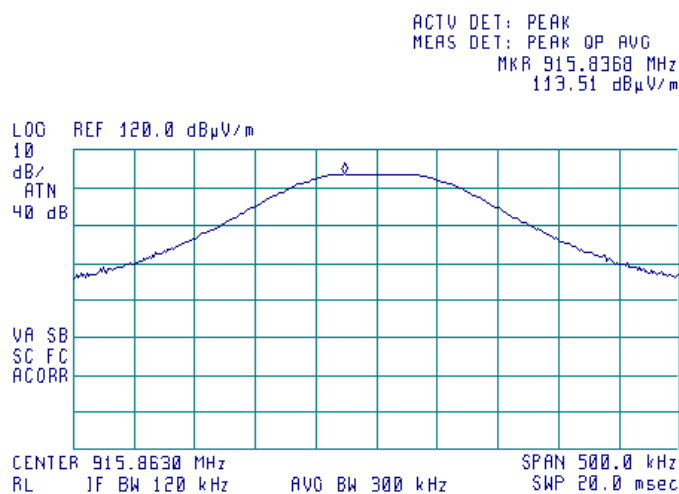



HERMON LABORATORIES

Test specification:	Section 15.247(d), RSS-247 section 5.5, Radiated spurious emissions		
Test procedure:	Public notice DA 00-705/ 47 CFR, Section 15.247(c) / ANSI C63.4, Section 13.1.4		
Test mode:	Compliance	Verdict:	PASS
Date(s):	12-Apr-15 - 25-Aug-15		
Temperature: 24 °C	Air Pressure: 1010 hPa	Relative Humidity: 56 %	Power Supply: 120 VAC
Remarks:			

Plot 7.6.3 Radiated emission measurements at the high carrier frequency

TEST SITE: Semi anechoic chamber
TEST DISTANCE: 3 m
ANTENNA POLARIZATION: Vertical and Horizontal

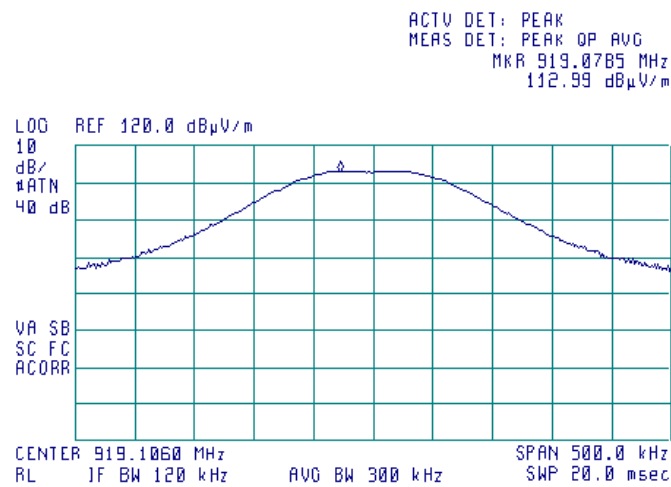

Plot 7.6.4 Radiated emission measurements from 9 to 150 kHz at the low, mid and high carrier frequency

TEST SITE: Semi anechoic chamber
TEST DISTANCE: 3 m
ANTENNA POLARIZATION: Vertical

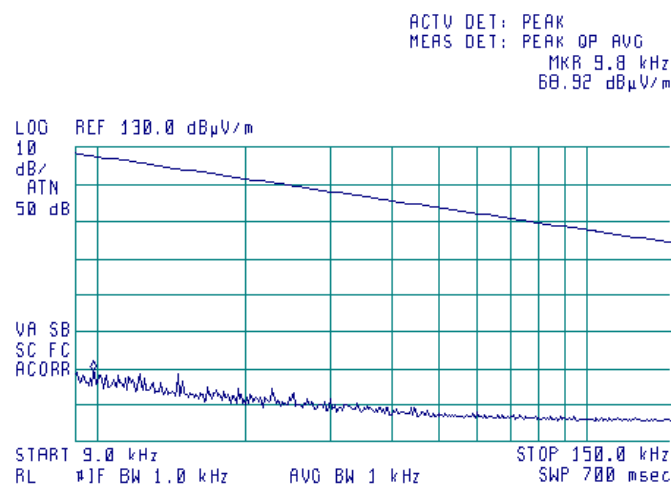



HERMON LABORATORIES

Test specification:	Section 15.247(d), RSS-247 section 5.5, Radiated spurious emissions		
Test procedure:	Public notice DA 00-705/ 47 CFR, Section 15.247(c) / ANSI C63.4, Section 13.1.4		
Test mode:	Compliance	Verdict:	PASS
Date(s):	12-Apr-15 - 25-Aug-15		
Temperature: 24 °C	Air Pressure: 1010 hPa	Relative Humidity: 56 %	Power Supply: 120 VAC
Remarks:			

Plot 7.6.5 Radiated emission measurements from 0.15 to 30 MHz at the low, mid and high carrier frequency

TEST SITE: Semi anechoic chamber
TEST DISTANCE: 3 m
ANTENNA POLARIZATION: Vertical

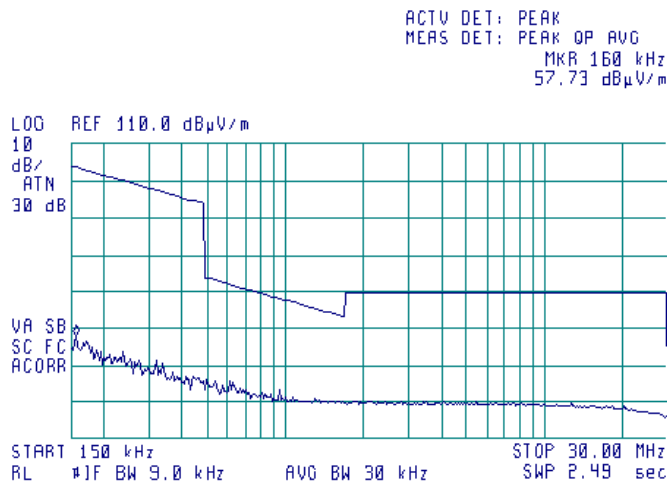

Plot 7.6.6 Radiated emission measurements from 30 to 1000 MHz at the low carrier frequency

TEST SITE: Semi anechoic chamber
TEST DISTANCE: 3 m
ANTENNA POLARIZATION: Vertical and Horizontal

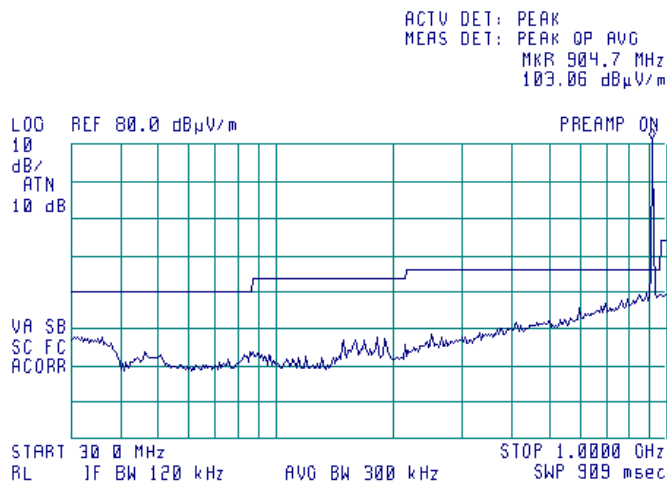



HERMON LABORATORIES

Test specification:	Section 15.247(d), RSS-247 section 5.5, Radiated spurious emissions		
Test procedure:	Public notice DA 00-705/ 47 CFR, Section 15.247(c) / ANSI C63.4, Section 13.1.4		
Test mode:	Compliance	Verdict:	PASS
Date(s):	12-Apr-15 - 25-Aug-15		
Temperature: 24 °C	Air Pressure: 1010 hPa	Relative Humidity: 56 %	Power Supply: 120 VAC
Remarks:			

Plot 7.6.7 Radiated emission measurements from 30 to 1000 MHz at the mid carrier frequency

TEST SITE: Semi anechoic chamber
TEST DISTANCE: 3 m
ANTENNA POLARIZATION: Vertical and Horizontal

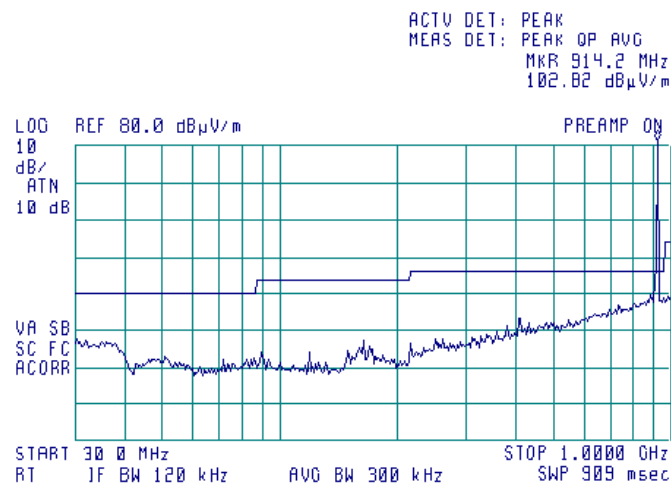

Plot 7.6.8 Radiated emission measurements from 30 to 1000 MHz at the high carrier frequency

TEST SITE: Semi anechoic chamber
TEST DISTANCE: 3 m
ANTENNA POLARIZATION: Vertical and Horizontal

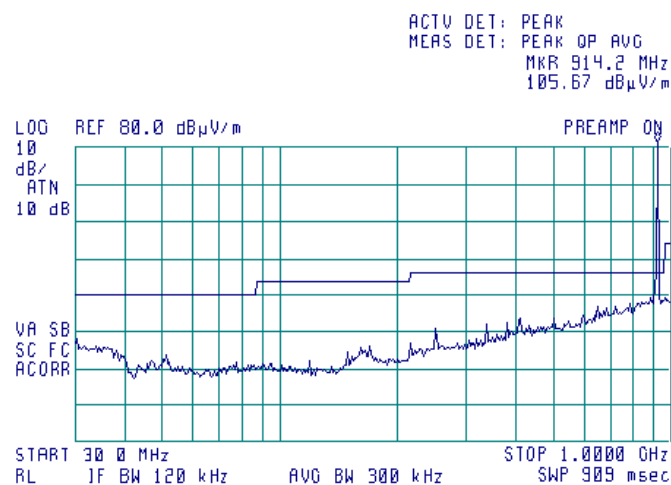



HERMON LABORATORIES

Test specification:	Section 15.247(d), RSS-247 section 5.5, Radiated spurious emissions		
Test procedure:	Public notice DA 00-705/ 47 CFR, Section 15.247(c) / ANSI C63.4, Section 13.1.4		
Test mode:	Compliance	Verdict: PASS	
Date(s):	12-Apr-15 - 25-Aug-15		
Temperature: 24 °C	Air Pressure: 1010 hPa	Relative Humidity: 56 %	Power Supply: 120 VAC
Remarks:			

Plot 7.6.9 Radiated emission measurements from 1000 to 6500 MHz at the low carrier frequency

TEST SITE: Semi anechoic chamber
TEST DISTANCE: 3 m
ANTENNA POLARIZATION: Vertical and Horizontal

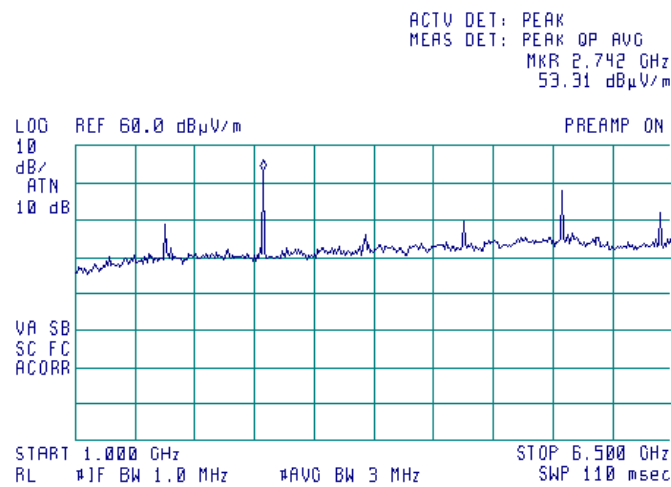

Plot 7.6.10 Radiated emission measurements from 1000 to 6500 MHz at the mid carrier frequency

TEST SITE: Semi anechoic chamber
TEST DISTANCE: 3 m
ANTENNA POLARIZATION: Vertical and Horizontal

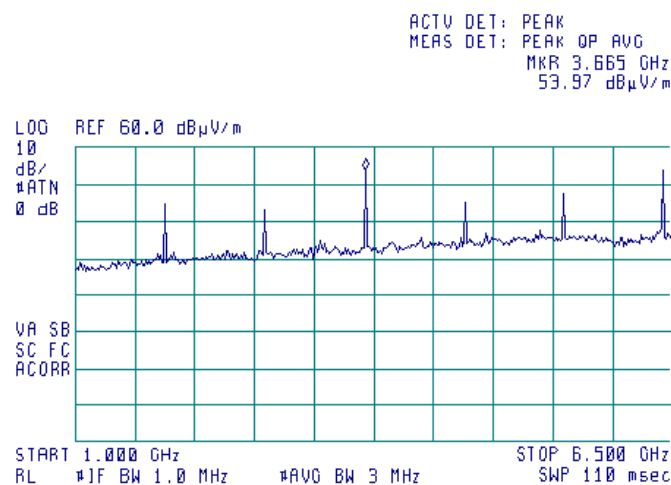



HERMON LABORATORIES

Test specification:	Section 15.247(d), RSS-247 section 5.5, Radiated spurious emissions		
Test procedure:	Public notice DA 00-705/ 47 CFR, Section 15.247(c) / ANSI C63.4, Section 13.1.4		
Test mode:	Compliance	Verdict: PASS	
Date(s):	12-Apr-15 - 25-Aug-15		
Temperature: 24 °C	Air Pressure: 1010 hPa	Relative Humidity: 56 %	Power Supply: 120 VAC
Remarks:			

Plot 7.6.11 Radiated emission measurements from 1000 to 6500 MHz at the high carrier frequency

TEST SITE: Semi anechoic chamber
TEST DISTANCE: 3 m
ANTENNA POLARIZATION: Vertical and Horizontal

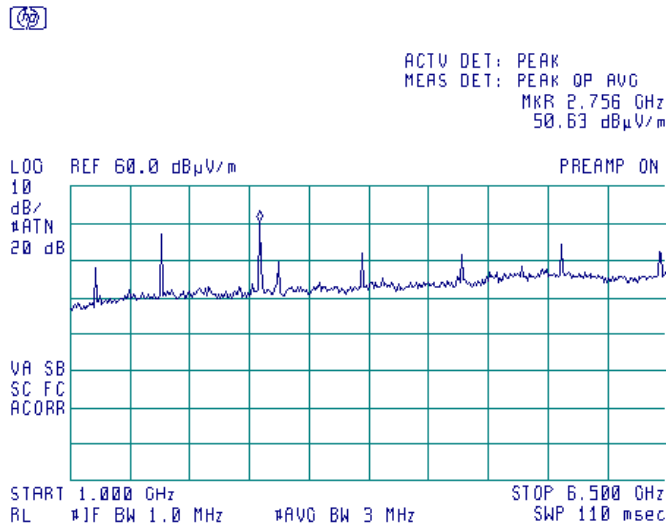

Plot 7.6.12 Radiated emission measurements from 6500 to 9500 MHz at the low carrier frequency

TEST SITE: Semi anechoic chamber
TEST DISTANCE: 3 m
ANTENNA POLARIZATION: Vertical and Horizontal

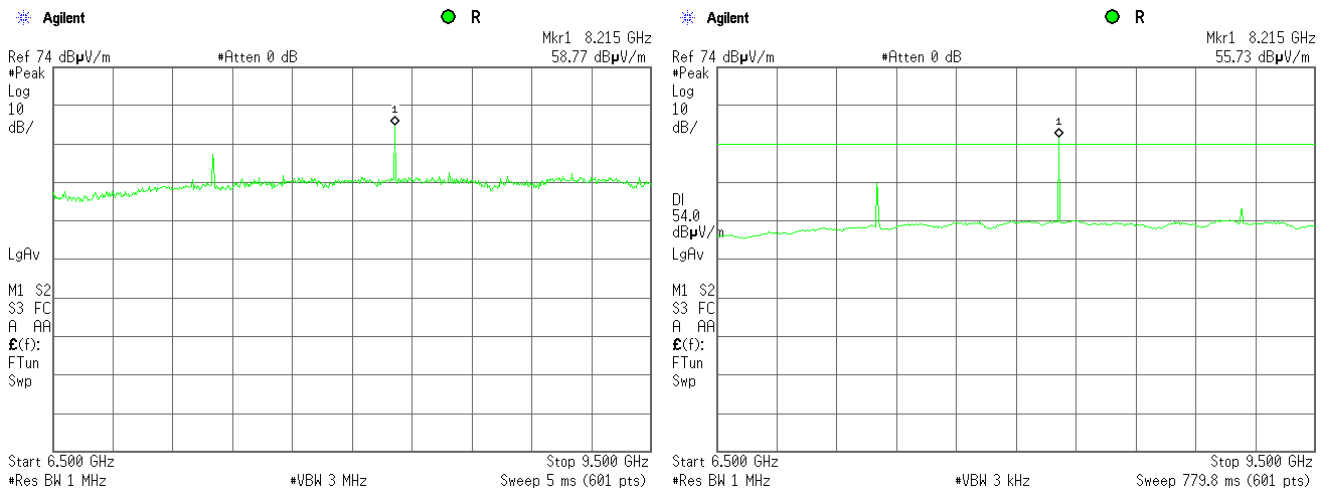



HERMON LABORATORIES

Test specification:	Section 15.247(d), RSS-247 section 5.5, Radiated spurious emissions		
Test procedure:	Public notice DA 00-705/ 47 CFR, Section 15.247(c) / ANSI C63.4, Section 13.1.4		
Test mode:	Compliance	Verdict: PASS	
Date(s):	12-Apr-15 - 25-Aug-15		
Temperature: 24 °C	Air Pressure: 1010 hPa	Relative Humidity: 56 %	Power Supply: 120 VAC
Remarks:			

Plot 7.6.13 Radiated emission measurements from 6500 to 9500 MHz at the mid carrier frequency

TEST SITE: Semi anechoic chamber
TEST DISTANCE: 3 m
ANTENNA POLARIZATION: Vertical and Horizontal

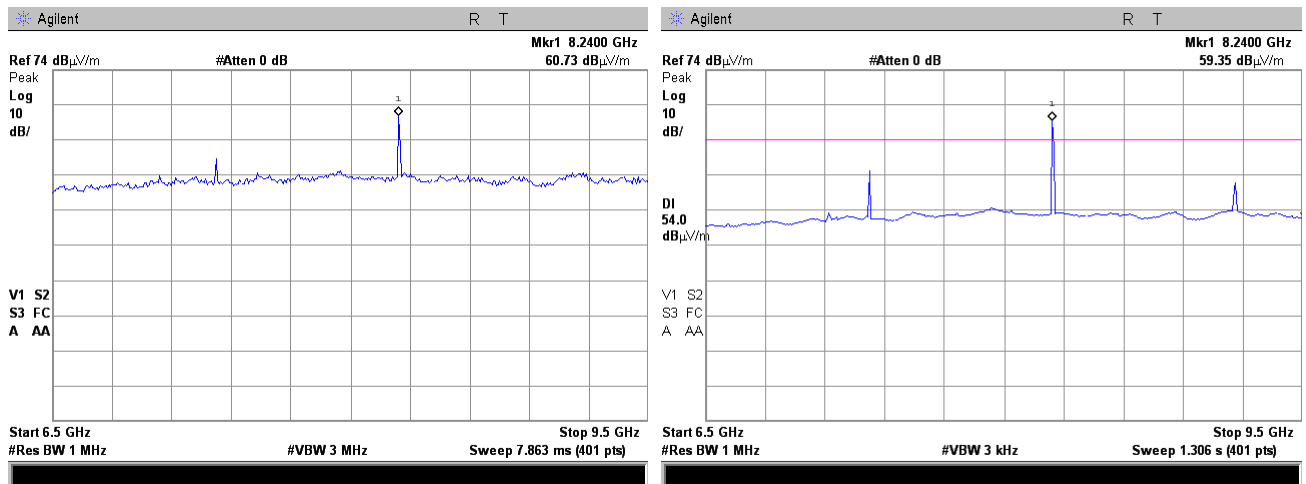

Plot 7.6.14 Radiated emission measurements from 6500 to 9500 MHz at the high carrier frequency

TEST SITE: Semi anechoic chamber
TEST DISTANCE: 3 m
ANTENNA POLARIZATION: Vertical and Horizontal

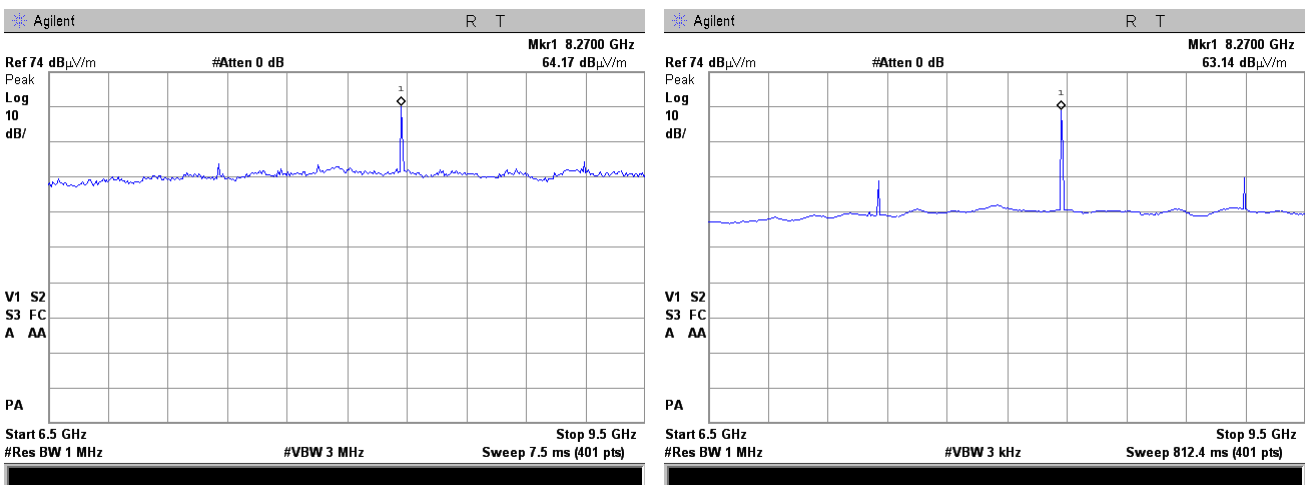



HERMON LABORATORIES

Test specification:		Section 15.247(d), RSS-247 section 5.5, Radiated spurious emissions	
Test procedure:		Public notice DA 00-705/ 47 CFR, Section 15.247(c) / ANSI C63.4, Section 13.1.4	
Test mode:		Compliance	
Date(s):		12-Apr-15 - 25-Aug-15	
Temperature: 24 °C		Air Pressure: 1010 hPa	
Relative Humidity: 56 %		Power Supply: 120 VAC	
Remarks:			
		Verdict: PASS	

Plot 7.6.15 Radiated emission measurements at the second harmonic of low carrier frequency

TEST SITE: Semi anechoic chamber
TEST DISTANCE: 3 m
ANTENNA POLARIZATION: Vertical and Horizontal

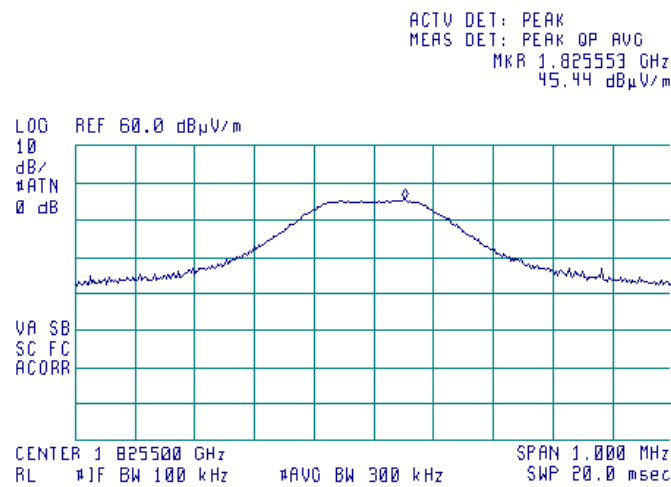

Plot 7.6.16 Radiated emission measurements at the second harmonic of mid carrier frequency

TEST SITE: Semi anechoic chamber
TEST DISTANCE: 3 m
ANTENNA POLARIZATION: Vertical and Horizontal

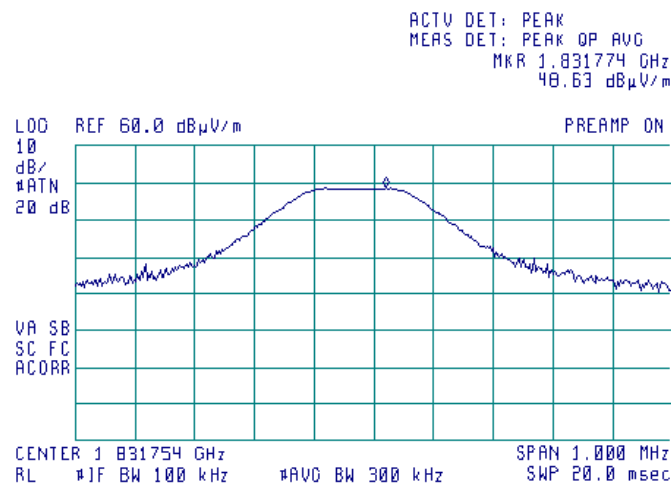



HERMON LABORATORIES

Test specification:	Section 15.247(d), RSS-247 section 5.5, Radiated spurious emissions		
Test procedure:	Public notice DA 00-705/ 47 CFR, Section 15.247(c) / ANSI C63.4, Section 13.1.4		
Test mode:	Compliance	Verdict:	PASS
Date(s):	12-Apr-15 - 25-Aug-15		
Temperature: 24 °C	Air Pressure: 1010 hPa	Relative Humidity: 56 %	Power Supply: 120 VAC
Remarks:			

Plot 7.6.17 Radiated emission measurements at the second harmonic of high carrier frequency

TEST SITE: Semi anechoic chamber
TEST DISTANCE: 3 m
ANTENNA POLARIZATION: Vertical and Horizontal

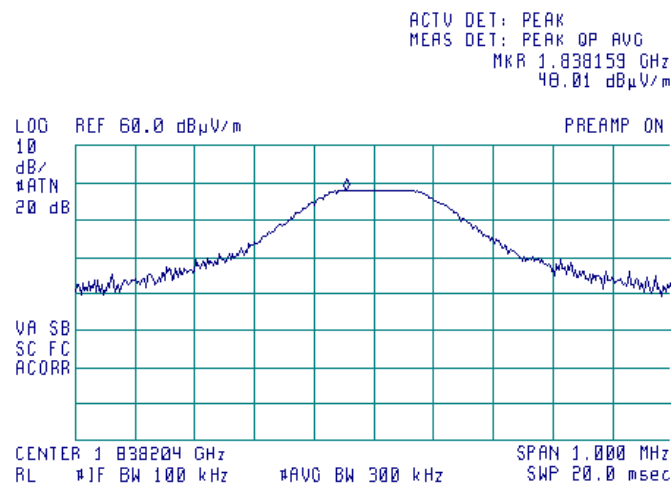

Plot 7.6.18 Radiated emission measurements at the third harmonic of low carrier frequency

TEST SITE: Semi anechoic chamber
TEST DISTANCE: 3 m
ANTENNA POLARIZATION: Vertical and Horizontal

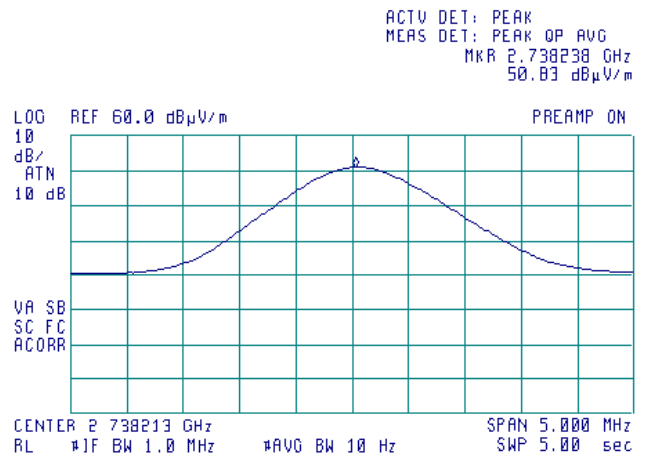
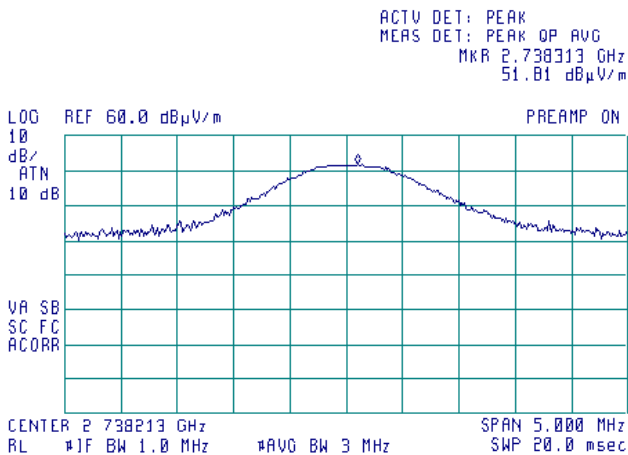



HERMON LABORATORIES

Test specification: Section 15.247(d), RSS-247 section 5.5, Radiated spurious emissions	
Test procedure: Public notice DA 00-705/ 47 CFR, Section 15.247(c) / ANSI C63.4, Section 13.1.4	
Test mode: Compliance	Verdict: PASS
Date(s): 12-Apr-15 - 25-Aug-15	
Temperature: 24 °C	Air Pressure: 1010 hPa
	Relative Humidity: 56 %
	Power Supply: 120 VAC
Remarks:	

Plot 7.6.19 Radiated emission measurements at the third harmonic of mid carrier frequency

TEST SITE: Semi anechoic chamber
TEST DISTANCE: 3 m
ANTENNA POLARIZATION: Vertical and Horizontal

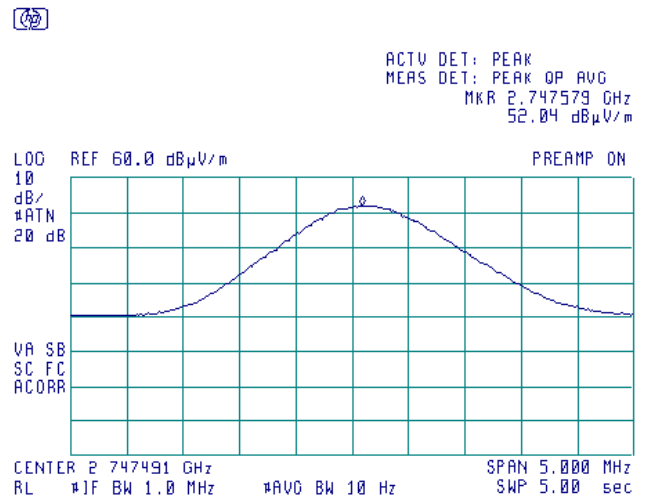
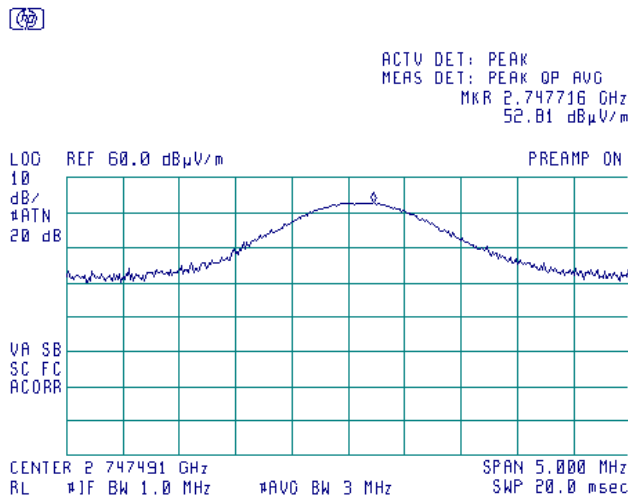

Plot 7.6.20 Radiated emission measurements at the third harmonic of high carrier frequency

TEST SITE: Semi anechoic chamber
TEST DISTANCE: 3 m
ANTENNA POLARIZATION: Vertical and Horizontal

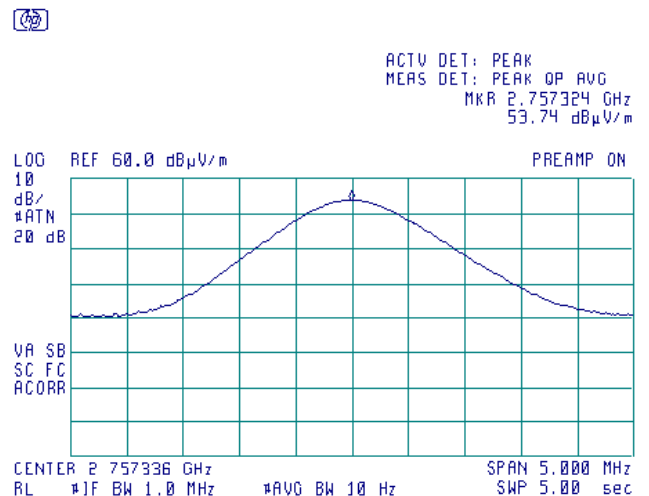
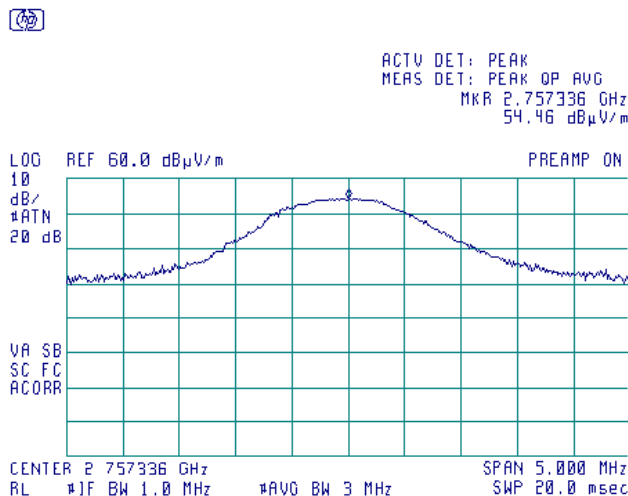



HERMON LABORATORIES

Test specification: Section 15.247(d), RSS-247 section 5.5, Radiated spurious emissions			
Test procedure: Public notice DA 00-705/ 47 CFR, Section 15.247(c) / ANSI C63.4, Section 13.1.4			
Test mode: Compliance	Verdict: PASS		
Date(s): 12-Apr-15 - 25-Aug-15			
Temperature: 24 °C	Air Pressure: 1010 hPa	Relative Humidity: 56 %	Power Supply: 120 VAC
Remarks:			

Plot 7.6.21 Radiated emission measurements at the fourth harmonic of low carrier frequency

TEST SITE: Semi anechoic chamber
TEST DISTANCE: 3 m
ANTENNA POLARIZATION: Vertical and Horizontal

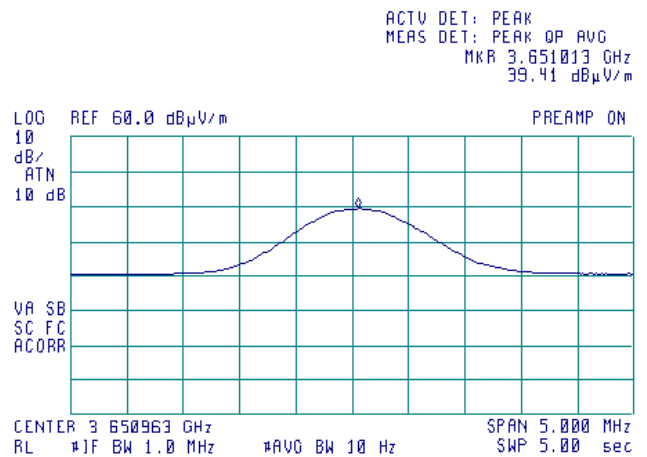
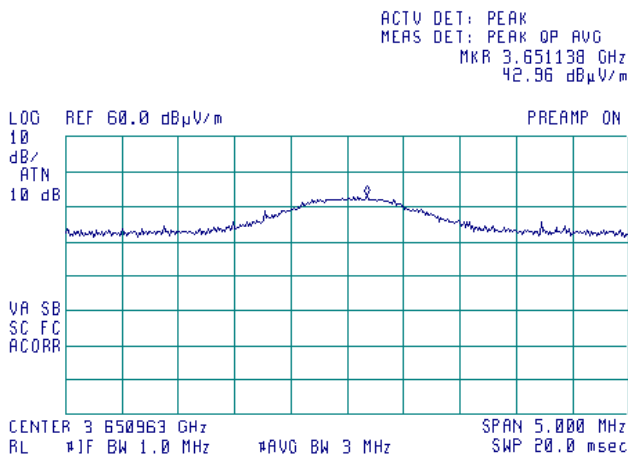

Plot 7.6.22 Radiated emission measurements at the fourth harmonic of mid carrier frequency

TEST SITE: Semi anechoic chamber
TEST DISTANCE: 3 m
ANTENNA POLARIZATION: Vertical and Horizontal

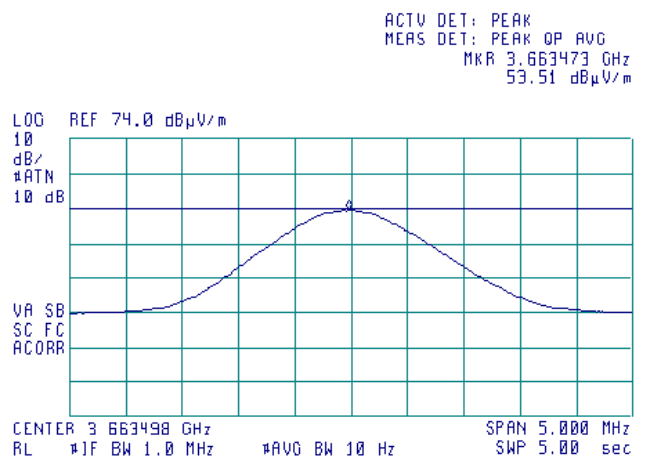
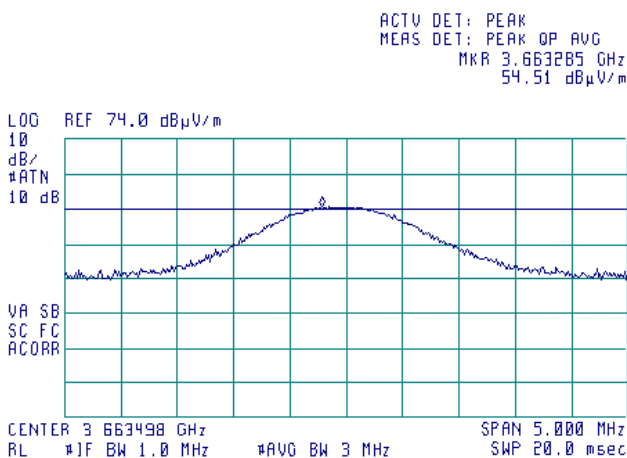



HERMON LABORATORIES

Test specification:	Section 15.247(d), RSS-247 section 5.5, Radiated spurious emissions		
Test procedure:	Public notice DA 00-705/ 47 CFR, Section 15.247(c) / ANSI C63.4, Section 13.1.4		
Test mode:	Compliance	Verdict:	PASS
Date(s):	12-Apr-15 - 25-Aug-15		
Temperature: 24 °C	Air Pressure: 1010 hPa	Relative Humidity: 56 %	Power Supply: 120 VAC
Remarks:			

Plot 7.6.23 Radiated emission measurements at the fourth harmonic of high carrier frequency

TEST SITE: Semi anechoic chamber
TEST DISTANCE: 3 m
ANTENNA POLARIZATION: Vertical and Horizontal

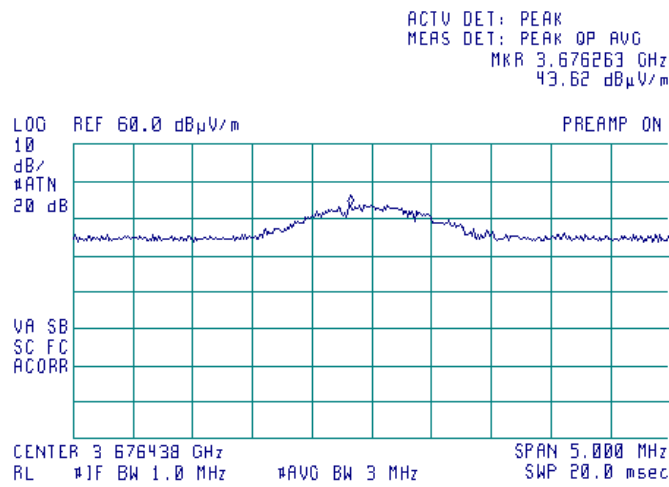

Plot 7.6.24 Radiated emission measurements at the fifth harmonic of low carrier frequency

TEST SITE: Semi anechoic chamber
TEST DISTANCE: 3 m
ANTENNA POLARIZATION: Vertical and Horizontal

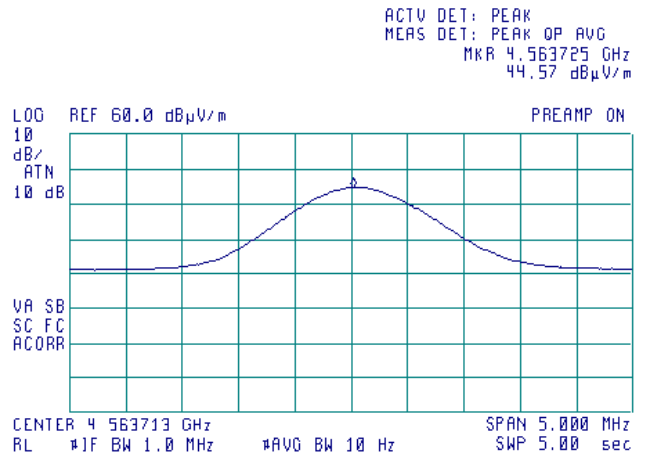
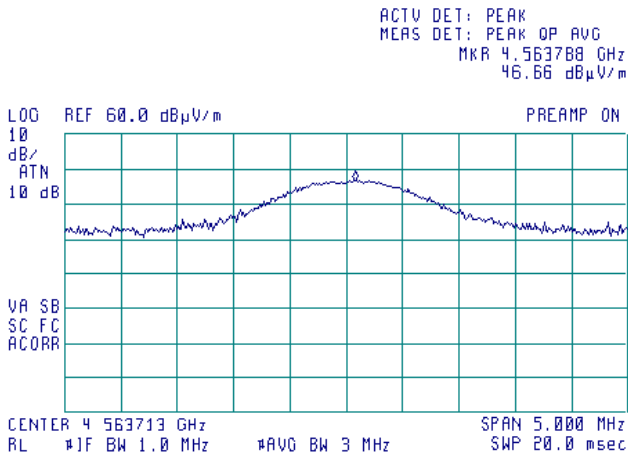



HERMON LABORATORIES

Test specification:		Section 15.247(d), RSS-247 section 5.5, Radiated spurious emissions	
Test procedure:		Public notice DA 00-705/ 47 CFR, Section 15.247(c) / ANSI C63.4, Section 13.1.4	
Test mode:		Compliance	
Date(s):		12-Apr-15 - 25-Aug-15	
Temperature: 24 °C		Air Pressure: 1010 hPa	
Remarks:		Verdict: PASS	
		Relative Humidity: 56 %	
		Power Supply: 120 VAC	

Plot 7.6.25 Radiated emission measurements at the fifth harmonic of mid carrier frequency

TEST SITE: Semi anechoic chamber
TEST DISTANCE: 3 m
ANTENNA POLARIZATION: Vertical and Horizontal

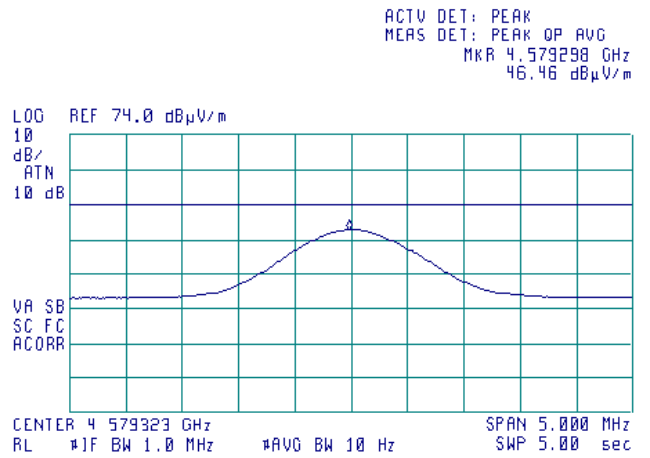
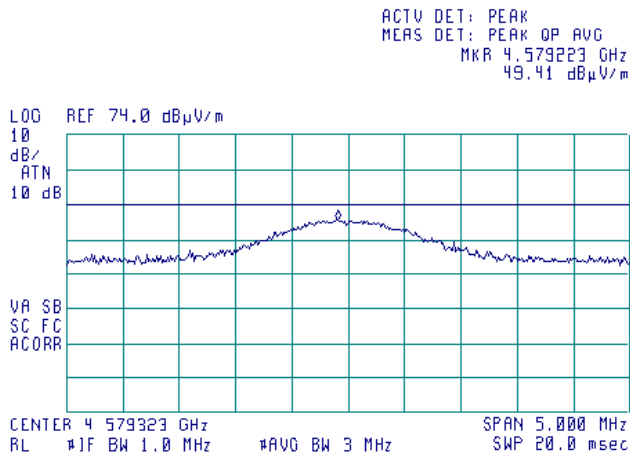

Plot 7.6.26 Radiated emission measurements at the fifth harmonic of high carrier frequency

TEST SITE: Semi anechoic chamber
TEST DISTANCE: 3 m
ANTENNA POLARIZATION: Vertical and Horizontal

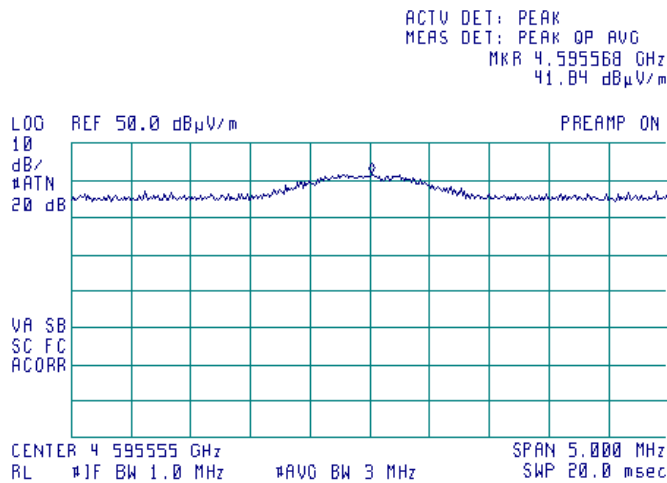



HERMON LABORATORIES

Test specification:		Section 15.247(d), RSS-247 section 5.5, Radiated spurious emissions	
Test procedure:		Public notice DA 00-705/ 47 CFR, Section 15.247(c) / ANSI C63.4, Section 13.1.4	
Test mode:		Verdict: PASS	
Date(s):		12-Apr-15 - 25-Aug-15	
Temperature: 24 °C	Air Pressure: 1010 hPa	Relative Humidity: 56 %	Power Supply: 120 VAC
Remarks:			

Plot 7.6.27 Radiated emission measurements at the sixth harmonic of low carrier frequency

TEST SITE: Semi anechoic chamber
TEST DISTANCE: 3 m
ANTENNA POLARIZATION: Vertical and Horizontal

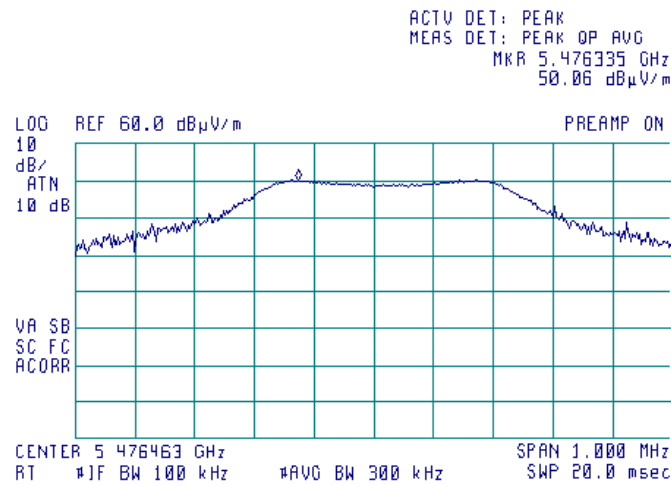

Plot 7.6.28 Radiated emission measurements at the sixth harmonic of mid carrier frequency

TEST SITE: Semi anechoic chamber
TEST DISTANCE: 3 m
ANTENNA POLARIZATION: Vertical and Horizontal

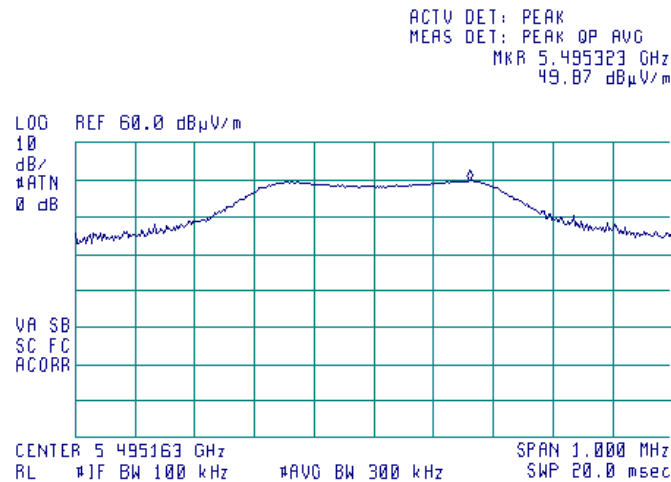



HERMON LABORATORIES

Test specification:		Section 15.247(d), RSS-247 section 5.5, Radiated spurious emissions	
Test procedure:		Public notice DA 00-705/ 47 CFR, Section 15.247(c) / ANSI C63.4, Section 13.1.4	
Test mode:		Compliance	
Date(s):		12-Apr-15 - 25-Aug-15	
Temperature: 24 °C		Air Pressure: 1010 hPa	
		Relative Humidity: 56 %	
		Power Supply: 120 VAC	
Remarks:			

Plot 7.6.29 Radiated emission measurements at the sixth harmonic of high carrier frequency

TEST SITE: Semi anechoic chamber
TEST DISTANCE: 3 m
ANTENNA POLARIZATION: Vertical and Horizontal

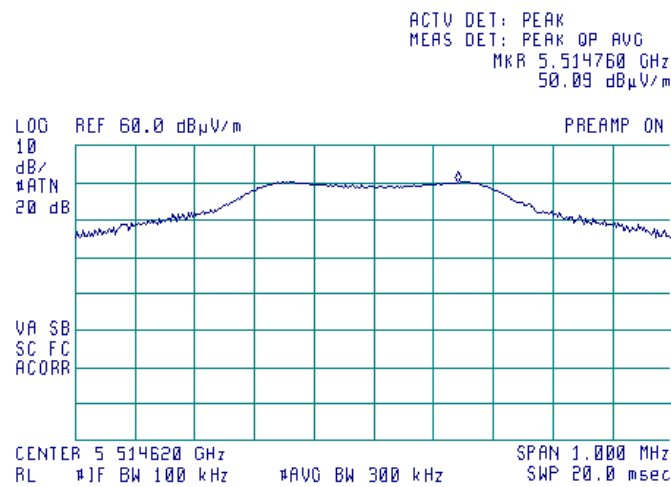

Plot 7.6.30 Radiated emission measurements at the seventh harmonic of low carrier frequency

TEST SITE: Semi anechoic chamber
TEST DISTANCE: 3 m
ANTENNA POLARIZATION: Vertical and Horizontal

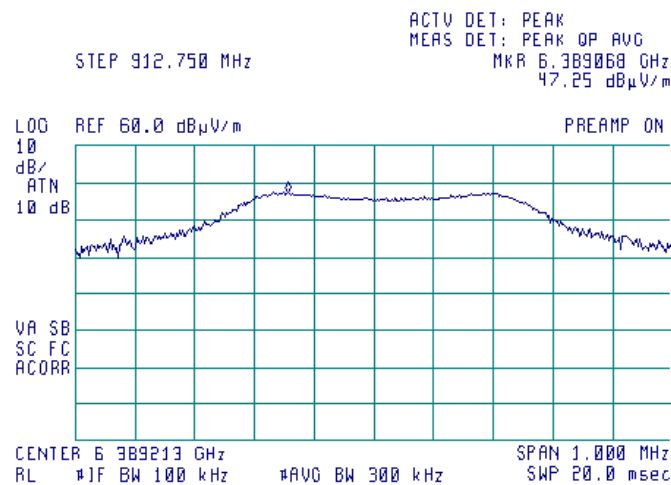



HERMON LABORATORIES

Test specification:		Section 15.247(d), RSS-247 section 5.5, Radiated spurious emissions	
Test procedure:		Public notice DA 00-705/ 47 CFR, Section 15.247(c) / ANSI C63.4, Section 13.1.4	
Test mode:		Compliance	
Date(s):		12-Apr-15 - 25-Aug-15	
Temperature: 24 °C		Air Pressure: 1010 hPa	
Relative Humidity: 56 %		Power Supply: 120 VAC	
Remarks:			
		Verdict: PASS	

Plot 7.6.31 Radiated emission measurements at the seventh harmonic of mid carrier frequency

TEST SITE: Semi anechoic chamber
TEST DISTANCE: 3 m
ANTENNA POLARIZATION: Vertical and Horizontal

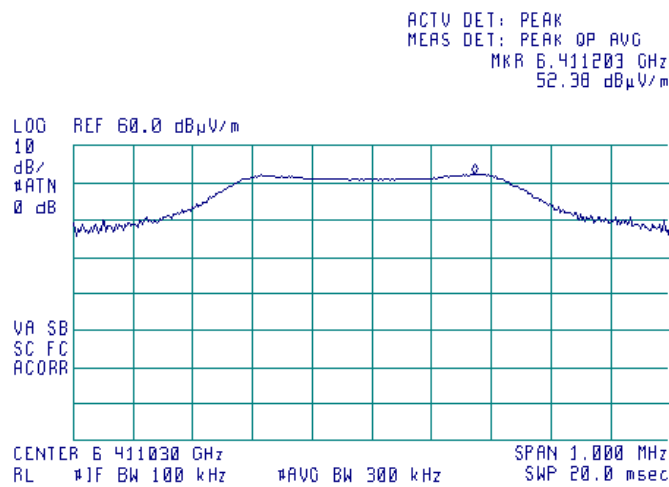

Plot 7.6.32 Radiated emission measurements at the seventh harmonic of high carrier frequency

TEST SITE: Semi anechoic chamber
TEST DISTANCE: 3 m
ANTENNA POLARIZATION: Vertical and Horizontal

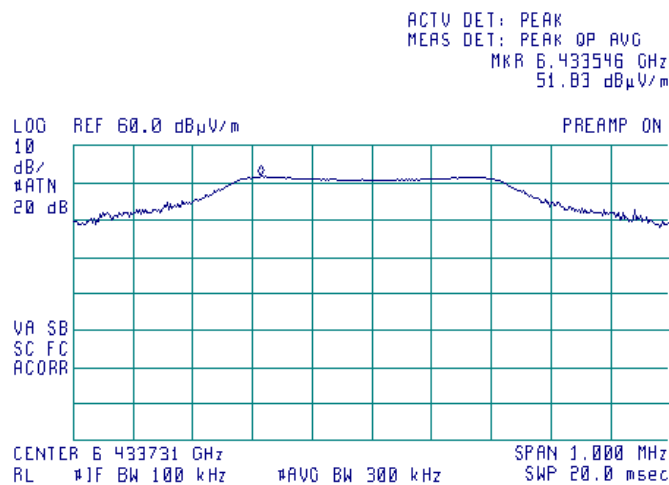



HERMON LABORATORIES

Test specification:	Section 15.247(d), RSS-247 section 5.5, Radiated spurious emissions		
Test procedure:	Public notice DA 00-705/ 47 CFR, Section 15.247(c) / ANSI C63.4, Section 13.1.4		
Test mode:	Compliance	Verdict:	PASS
Date(s):	12-Apr-15 - 25-Aug-15		
Temperature: 24 °C	Air Pressure: 1010 hPa	Relative Humidity: 56 %	Power Supply: 120 VAC
Remarks:			

Plot 7.6.33 Radiated emission measurements at the eighth harmonic of low carrier frequency

TEST SITE: Semi anechoic chamber
TEST DISTANCE: 3 m
ANTENNA POLARIZATION: Vertical and Horizontal

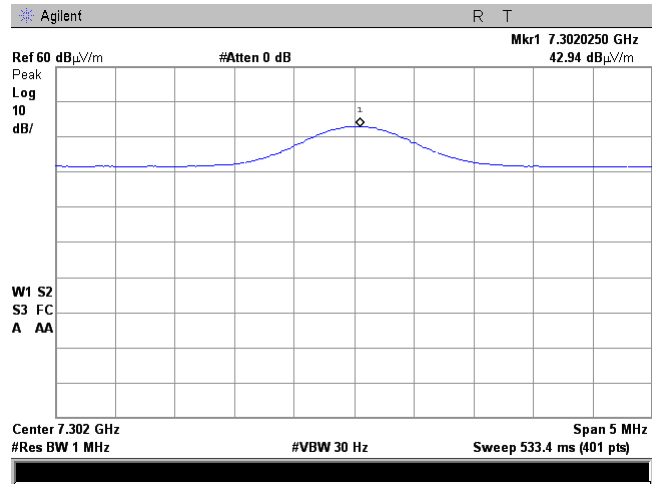
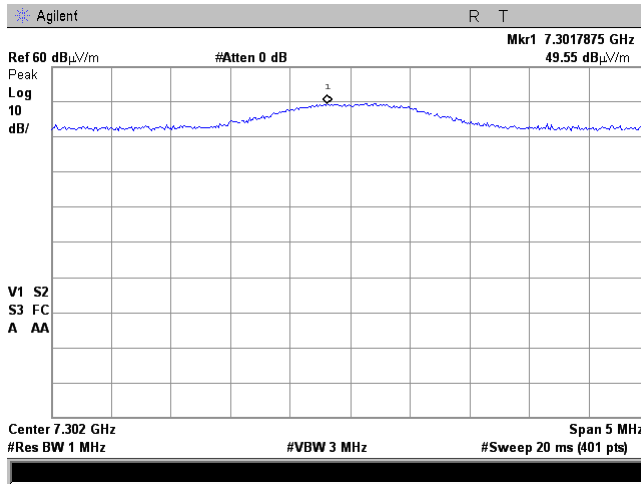

Plot 7.6.34 Radiated emission measurements at the eighth harmonic of mid carrier frequency

TEST SITE: Semi anechoic chamber
TEST DISTANCE: 3 m
ANTENNA POLARIZATION: Vertical and Horizontal

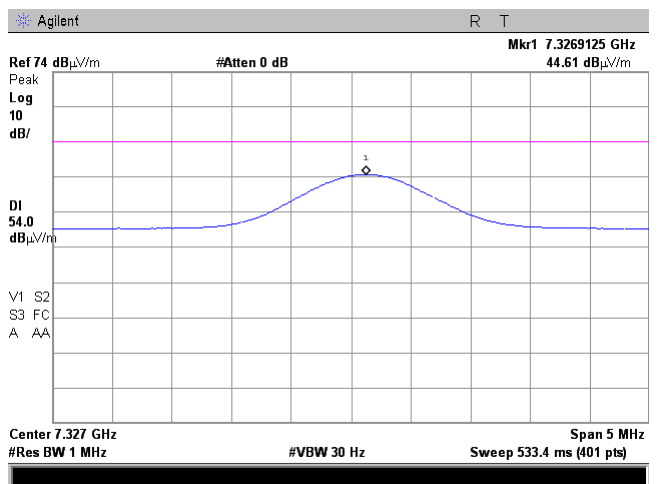
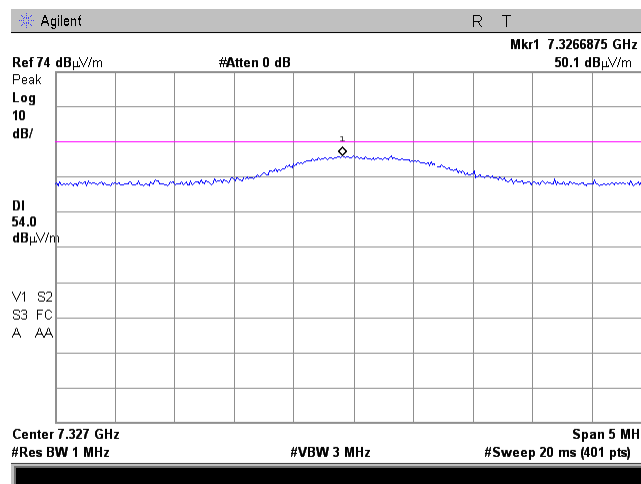



HERMON LABORATORIES

Test specification: Section 15.247(d), RSS-247 section 5.5, Radiated spurious emissions	
Test procedure: Public notice DA 00-705/ 47 CFR, Section 15.247(c) / ANSI C63.4, Section 13.1.4	
Test mode: Compliance	Verdict: PASS
Date(s): 12-Apr-15 - 25-Aug-15	
Temperature: 24 °C	Air Pressure: 1010 hPa
	Relative Humidity: 56 %
	Power Supply: 120 VAC
Remarks:	

Plot 7.6.35 Radiated emission measurements at the eighth harmonic of high carrier frequency

TEST SITE: Semi anechoic chamber
TEST DISTANCE: 3 m
ANTENNA POLARIZATION: Vertical and Horizontal

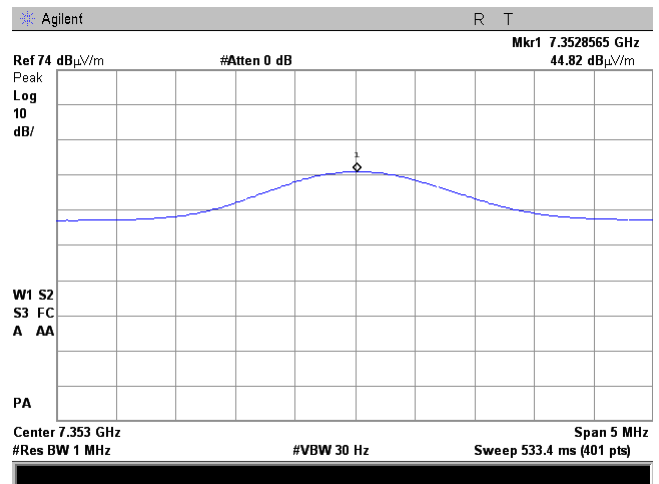
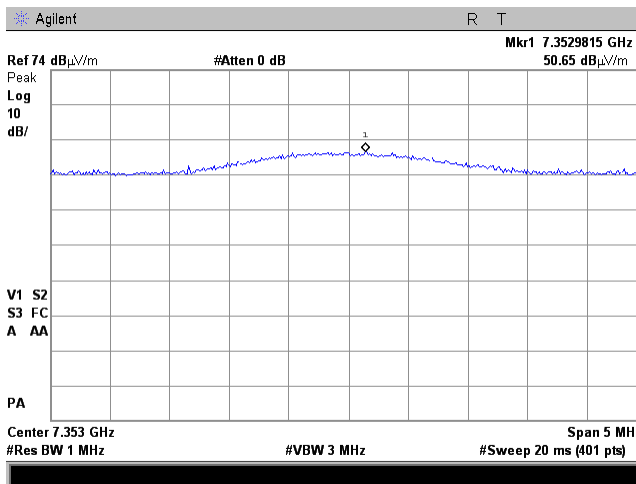

Plot 7.6.36 Radiated emission measurements at the ninth harmonic of low carrier frequency

TEST SITE: Semi anechoic chamber
TEST DISTANCE: 3 m
ANTENNA POLARIZATION: Vertical and Horizontal

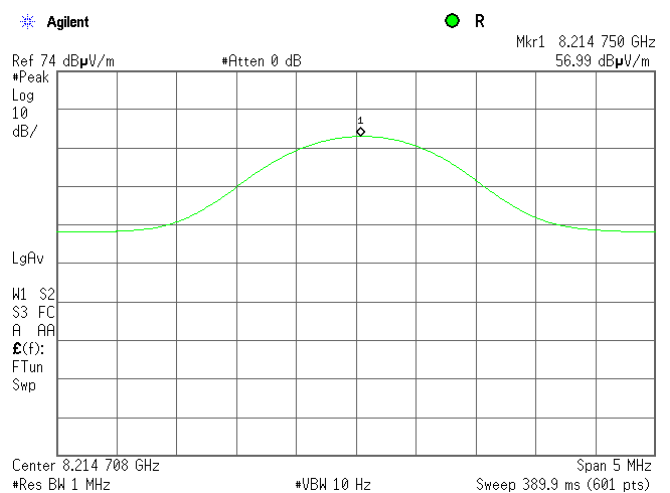
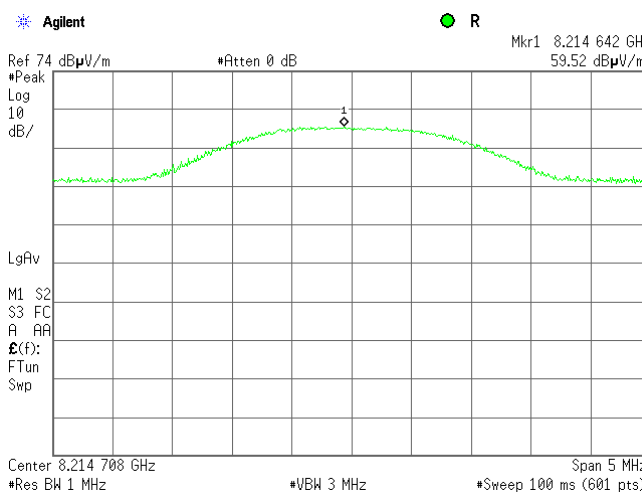



HERMON LABORATORIES

Test specification:	Section 15.247(d), RSS-247 section 5.5, Radiated spurious emissions		
Test procedure:	Public notice DA 00-705/ 47 CFR, Section 15.247(c) / ANSI C63.4, Section 13.1.4		
Test mode:	Compliance	Verdict: PASS	
Date(s):	12-Apr-15 - 25-Aug-15		
Temperature: 24 °C	Air Pressure: 1010 hPa	Relative Humidity: 56 %	Power Supply: 120 VAC
Remarks:			

Plot 7.6.37 Radiated emission measurements at the ninth harmonic of mid carrier frequency

TEST SITE: Semi anechoic chamber
TEST DISTANCE: 3 m
ANTENNA POLARIZATION: Vertical and Horizontal

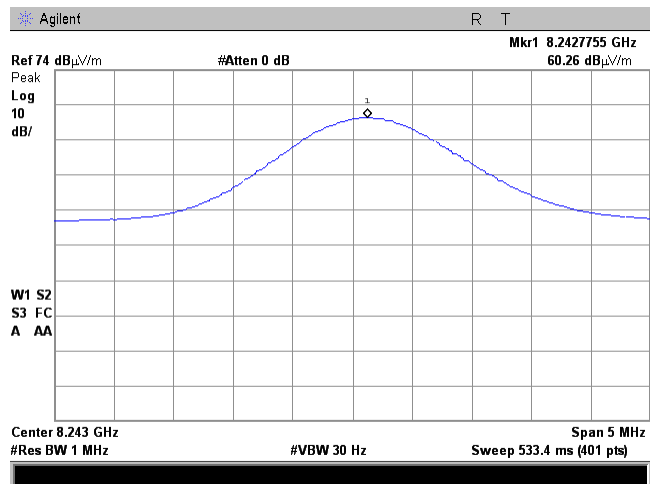
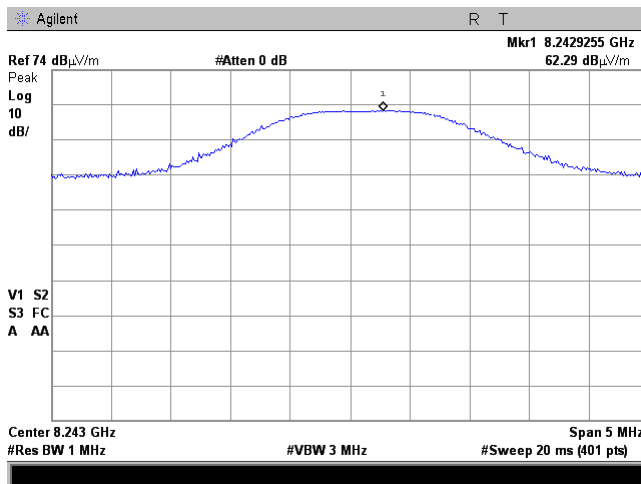

Plot 7.6.38 Radiated emission measurements at the ninth harmonic of high carrier frequency

TEST SITE: Semi anechoic chamber
TEST DISTANCE: 3 m
ANTENNA POLARIZATION: Vertical and Horizontal

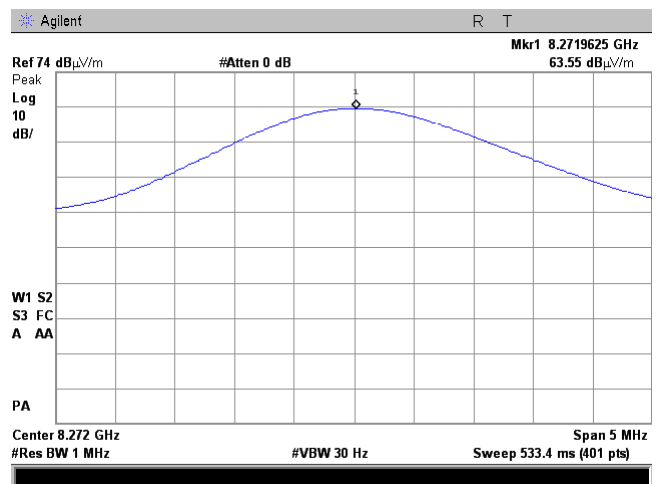
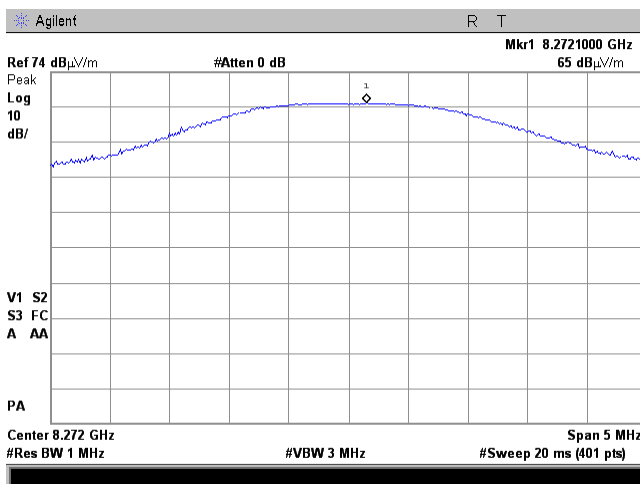



HERMON LABORATORIES

Test specification:	Section 15.247(d), RSS-247 section 5.5, Radiated spurious emissions		
Test procedure:	Public notice DA 00-705/ 47 CFR, Section 15.247(c) / ANSI C63.4, Section 13.1.4		
Test mode:	Compliance	Verdict:	PASS
Date(s):	12-Apr-15 - 25-Aug-15		
Temperature: 24 °C	Air Pressure: 1010 hPa	Relative Humidity: 56 %	Power Supply: 120 VAC
Remarks:			

Plot 7.6.39 Radiated emission measurements at the tenth harmonic of low carrier frequency

TEST SITE: Semi anechoic chamber
TEST DISTANCE: 3 m
ANTENNA POLARIZATION: Vertical and Horizontal

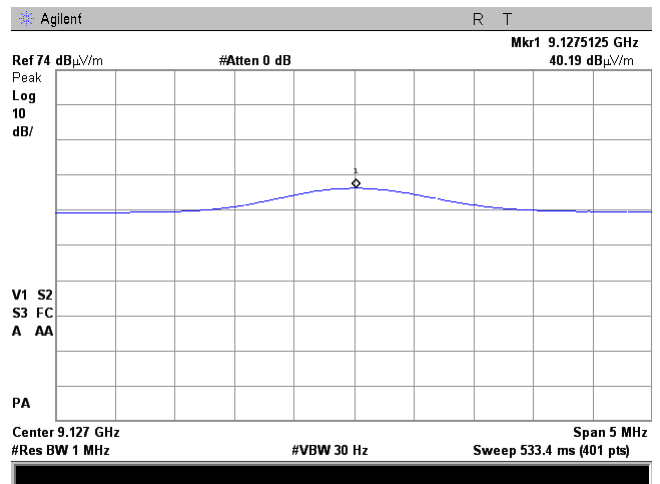
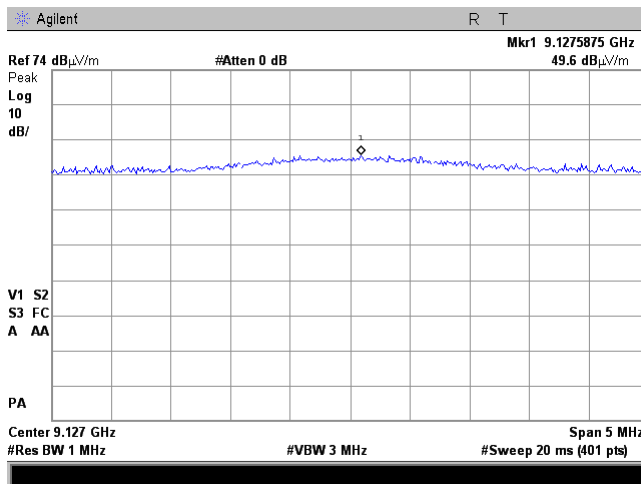

Plot 7.6.40 Radiated emission measurements at the tenth harmonic of mid carrier frequency

TEST SITE: Semi anechoic chamber
TEST DISTANCE: 3 m
ANTENNA POLARIZATION: Vertical and Horizontal

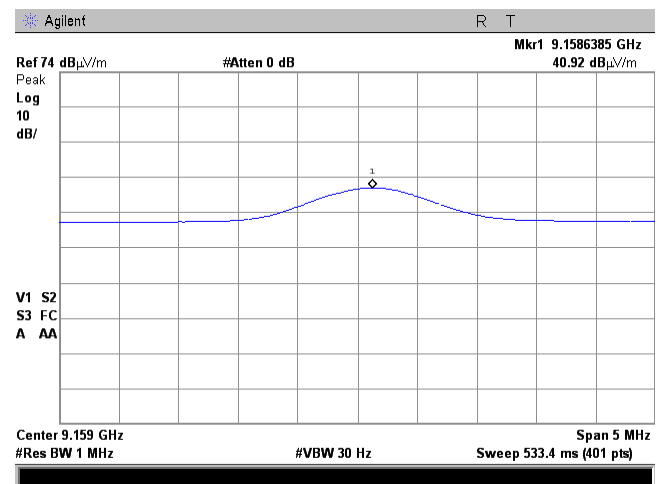
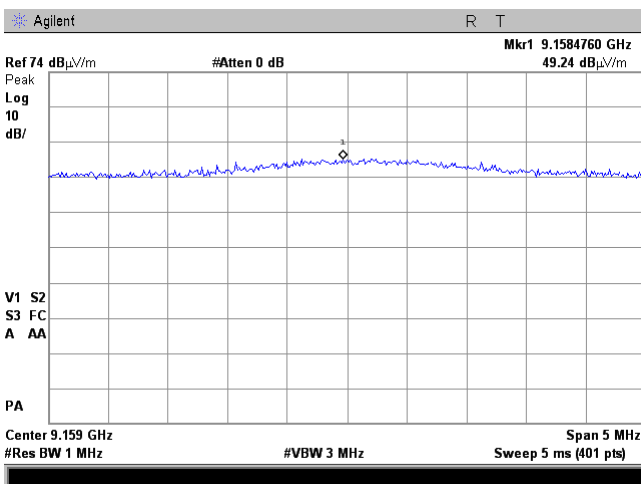



HERMON LABORATORIES

Test specification:	Section 15.247(d), RSS-247 section 5.5, Radiated spurious emissions		
Test procedure:	Public notice DA 00-705/ 47 CFR, Section 15.247(c) / ANSI C63.4, Section 13.1.4		
Test mode:	Compliance	Verdict: PASS	
Date(s):	12-Apr-15 - 25-Aug-15		
Temperature: 24 °C	Air Pressure: 1010 hPa	Relative Humidity: 56 %	Power Supply: 120 VAC
Remarks:			

Plot 7.6.41 Radiated emission measurements at the tenth harmonic of high carrier frequency

TEST SITE: Semi anechoic chamber
TEST DISTANCE: 3 m
ANTENNA POLARIZATION: Vertical and Horizontal

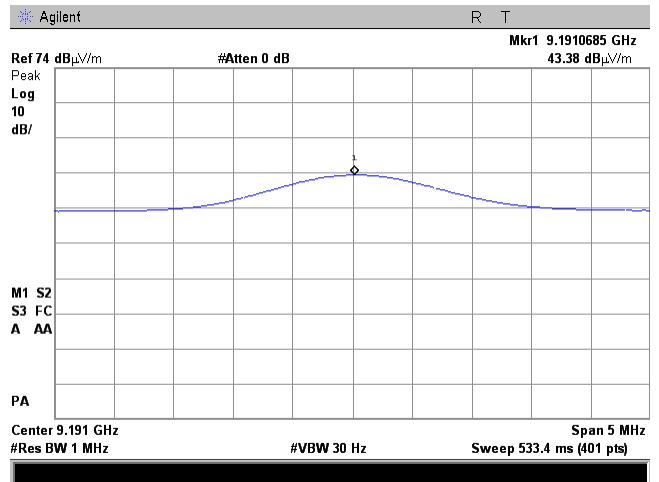
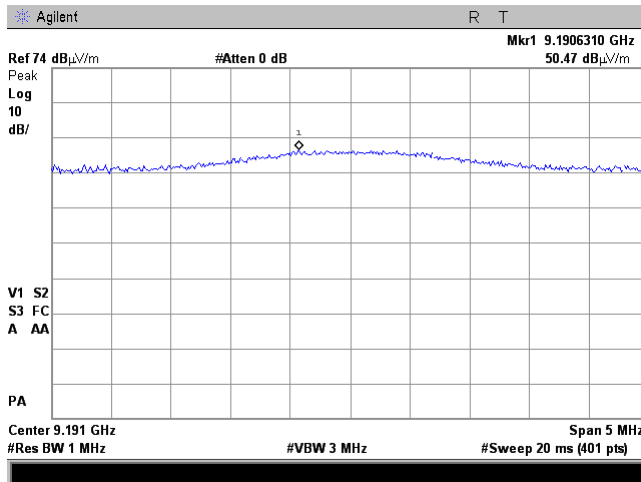



Test specification:	Section 15.247(d), RSS-247 section 5.5, Radiated spurious emissions		
Test procedure:	Public notice DA 00-705/ 47 CFR, Section 15.247(c) / ANSI C63.4, Section 13.1.4		
Test mode:	Compliance	Verdict:	PASS
Date(s):	12-Apr-15 - 25-Aug-15		
Temperature: 24 °C	Air Pressure: 1010 hPa	Relative Humidity: 56 %	Power Supply: 120 VAC
Remarks:			

Plot 7.6.42 Transmission pulse duration

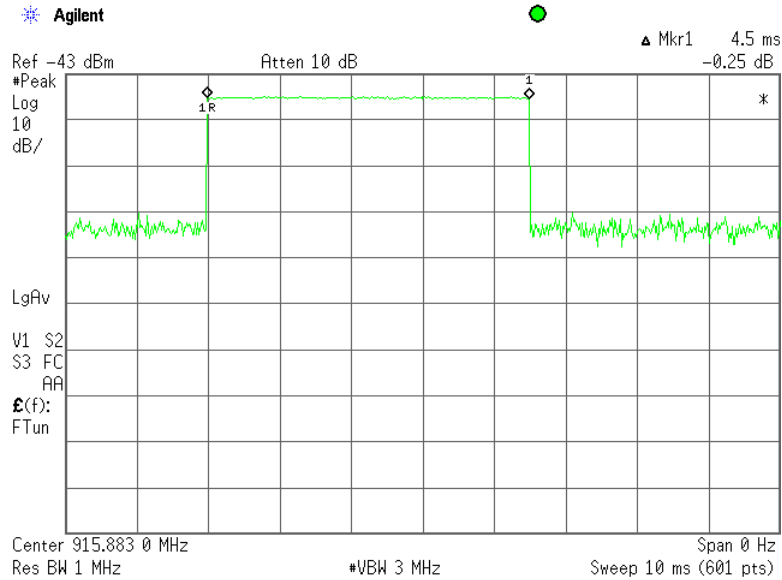

Plot 7.6.43 Single transmission period

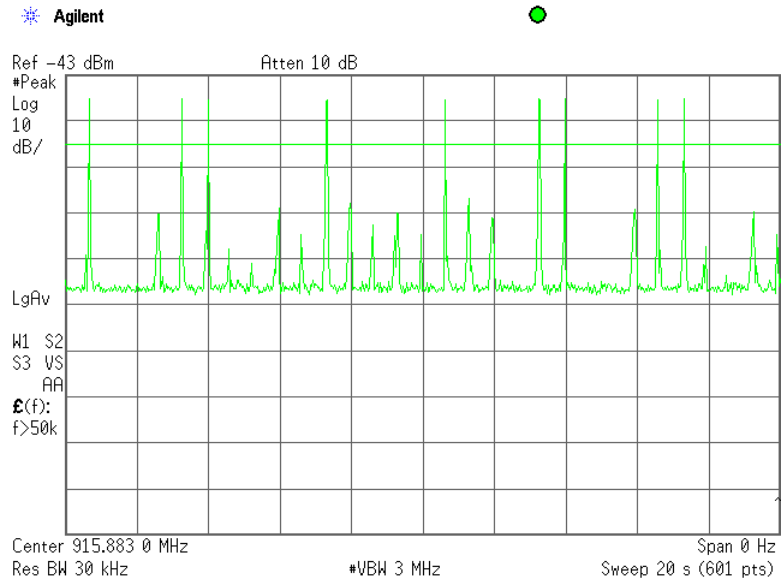



Test specification: Section 15.247(d), RSS-247 section 5.5, Emissions at band edges	
Test procedure:	Public notice DA 00-705
Test mode:	Compliance
Date(s):	22-Apr-15
Temperature: 24 °C	Air Pressure: 1010 hPa
Relative Humidity: 56 %	Power Supply: 120 VAC
Remarks:	
Verdict: PASS	

7.7 Band edge radiated emissions

7.7.1 General

This test was performed to measure emissions, radiated from the EUT at the assigned frequency band edges. Specification test limits are given in Table 7.7.1.

Table 7.7.1 Band edge emission limits

Assigned frequency, MHz	Attenuation below carrier*, dBc	Field strength at 3 m within restricted bands, dB(μV/m)	
		Peak	Average
902.0 – 928.0	20.0	74.0	54.0
2400.0 – 2483.5			
5725.0 – 5850.0			

* - Band edge emission limit is provided in terms of attenuation below the peak of modulated carrier measured with the same resolution bandwidth.

7.7.2 Test procedure

- 7.7.2.1 The EUT was set up as shown in Figure 7.7.1, energized normally modulated at the maximum data rate with its hopping function disabled and its proper operation was checked.
- 7.7.2.2 The EUT was adjusted to produce maximum available to end user RF output power at the lowest carrier frequency.
- 7.7.2.3 The spectrum analyzer span was set to capture the carrier frequency and associated modulation products. The resolution bandwidth was set wider than 1 % of the frequency span.
- 7.7.2.4 The spectrum analyzer was set in max hold mode and allowed trace to stabilize. The highest emission level within the authorized band was measured.
- 7.7.2.5 The maximum band edge emission and modulation product outside of the band were measured as provided in Table 7.7.2 and associated plots and referenced to the highest emission level measured within the authorized band.
- 7.7.2.6 The above procedure was repeated with the EUT adjusted to produce maximum RF output power at the highest carrier frequency.
- 7.7.2.7 The above procedure was repeated with the frequency hopping function enabled.

Figure 7.7.1 Band edge emission test setup





Test specification:		Section 15.247(d), RSS-247 section 5.5, Emissions at band edges	
Test procedure:		Public notice DA 00-705	
Test mode:		Compliance	
Date(s):		22-Apr-15	
Temperature: 24 °C		Air Pressure: 1010 hPa	
		Relative Humidity: 56 %	
		Power Supply: 120 VAC	
Remarks:			

Table 7.7.2 Band edge emission test results

ASSIGNED FREQUENCY BAND: 902-928 MHz
DETECTOR USED: Peak
MODULATION: QPSK
BIT RATE: 50 kbps
RESOLUTION BANDWIDTH: ≥ 1% of the span
VIDEO BANDWIDTH: ≥ RBW

Frequency, MHz	Band edge emission, dBm	Emission at carrier, dBm	Attenuation below carrier, dBc	Limit, dBc	Margin, dB*	Verdict
Frequency hopping disabled						
902	-85.17	-39	46.17	20.0	26.17	Pass
928	-87.33	-40	47.33		27.33	
Frequency hopping enabled						
902	-83.67	-39	44.67	20.0	24.67	Pass
928	-84.00	-39	45.00		25.00	

*- Margin = Attenuation below carrier – specification limit.

Reference numbers of test equipment used

HL 1424						
---------	--	--	--	--	--	--

Full description is given in Appendix A.



HERMON LABORATORIES

Test specification:		Section 15.247(d), RSS-247 section 5.5, Emissions at band edges	
Test procedure:		Public notice DA 00-705	
Test mode:		Verdict: PASS	
Date(s):		22-Apr-15	
Temperature: 24 °C	Air Pressure: 1010 hPa	Relative Humidity: 56 %	Power Supply: 120 VAC
Remarks:			

Plot 7.7.1 The highest band edge emission at low carrier frequency with hopping function disabled

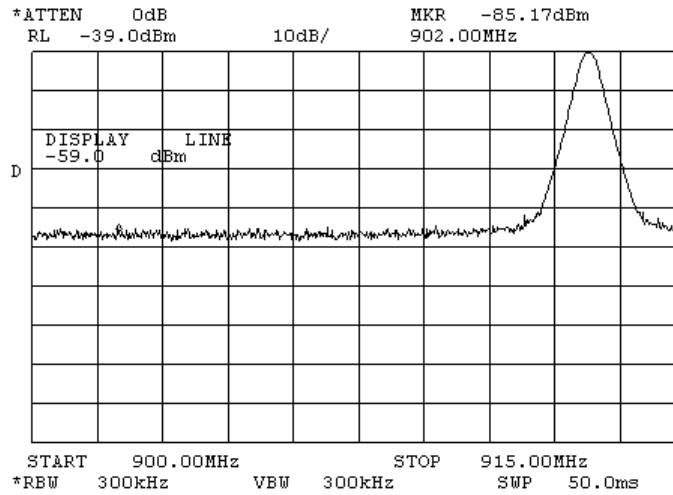

Plot 7.7.2 The highest band edge emission at high carrier frequency with hopping function disabled

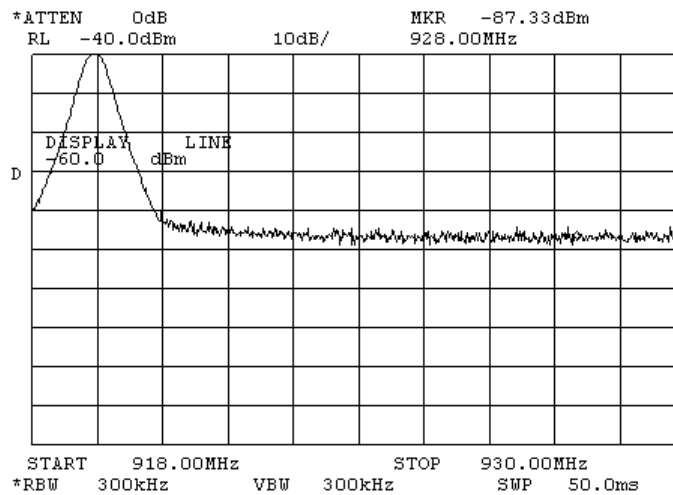



HERMON LABORATORIES

Test specification:		Section 15.247(d), RSS-247 section 5.5, Emissions at band edges	
Test procedure:		Public notice DA 00-705	
Test mode:		Verdict: PASS	
Date(s):		22-Apr-15	
Temperature: 24 °C	Air Pressure: 1010 hPa	Relative Humidity: 56 %	Power Supply: 120 VAC
Remarks:			

Plot 7.7.3 The highest band edge emission at low carrier frequency with hopping function enabled

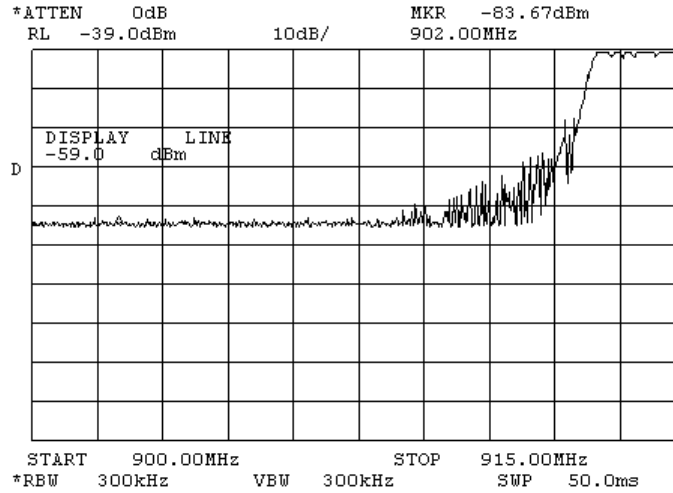

Plot 7.7.4 The highest band edge emission at high carrier frequency with hopping function enabled

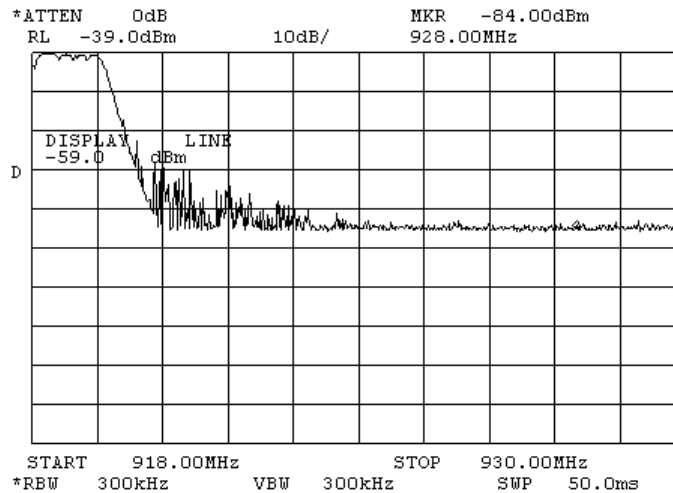



Test specification: Section 15.203, RSS-Gen section 8.3, Antenna requirements			
Test procedure:			
Test mode:	Compliance	Verdict: PASS	
Date(s):	22-Apr-15		
Temperature: 23 °C	Air Pressure: 1010 hPa	Relative Humidity: 60 %	Power Supply: 120 VAC
Remarks:			

7.8 Antenna requirements

The EUT was verified for compliance with antenna requirements. A transmitter shall be designed to ensure that no antenna other than that furnished by the responsible party will be used with the device. It may be either permanently attached or employs a unique antenna connector for every antenna proposed for use with the EUT. This requirement does not apply to professionally installed transmitters. The rationale for compliance with the above requirements was either visual inspection results or supplier declaration. The summary of results is provided in Table 7.8.1.

Table 7.8.1 Antenna requirements

Requirement	Rationale	Verdict
The transmitter antenna is permanently attached	Visual inspection	Comply
The transmitter employs a unique antenna connector	NA	
The transmitter requires professional installation	NA	

Photograph 7.8.1 Antenna assembly





Test specification:	Section 15.207(a), RSS-Gen section 8.8, Conducted emission		
Test procedure:	ANSI C63.4, Section 13.1.3		
Test mode:	Compliance	Verdict:	PASS
Date(s):	27-Apr-15		
Temperature: 22 °C	Air Pressure: 1011 hPa	Relative Humidity: 39 %	Power Supply: 120 VAC
Remarks:			

7.9 Conducted emissions

7.9.1 General

This test was performed to measure common mode conducted emissions at the power port. Specification test limits are given in Table 7.9.1.

Table 7.9.1 Limits for conducted emissions

Frequency, MHz	Class B limit, dB(μV)	
	QP	AVRG
0.15 - 0.5	66 - 56*	56 - 46*
0.5 - 5.0	56	46
5.0 - 30	60	50

* The limit decreases linearly with the logarithm of frequency.

7.9.2 Test procedure

7.9.2.1 The EUT was set up as shown in Figure 7.9.1, energized and the performance check was conducted.

7.9.2.2 The measurements were performed at power terminals with the LISN, connected to a spectrum analyzer in the frequency range referred to in Table 7.9.2. Unused coaxial connector of the LISN was terminated with 50 Ohm. Quasi-peak and average detectors were used throughout the testing.

7.9.2.3 The position of the device cables was varied to determine maximum emission level.

Figure 7.9.1 Setup for conducted emission measurements, table-top equipment

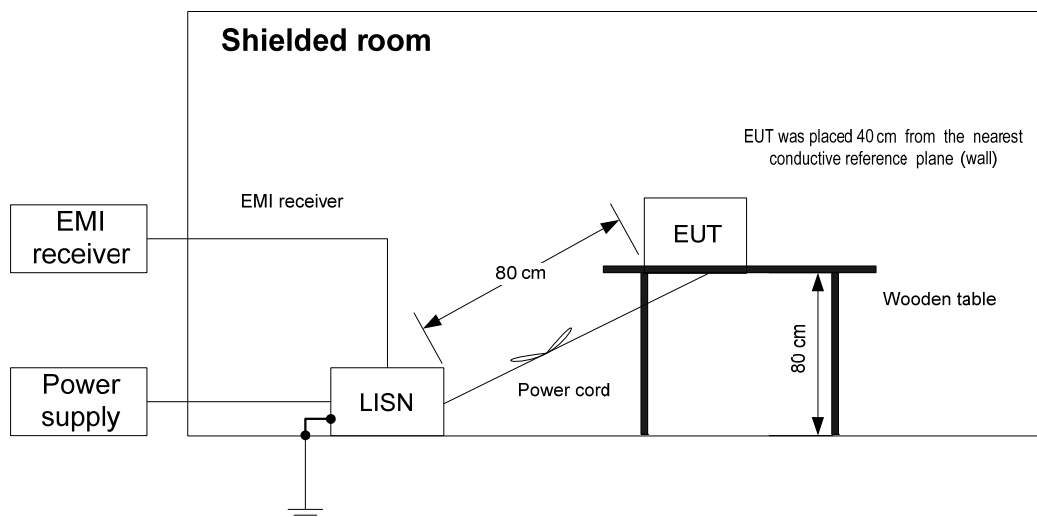



Test specification:		Section 15.207(a), RSS-Gen section 8.8, Conducted emission	
Test procedure:		ANSI C63.4, Section 13.1.3	
Test mode:		Compliance	
Date(s):		27-Apr-15	
Temperature: 22 °C		Air Pressure: 1011 hPa	
		Relative Humidity: 39 %	
		Power Supply: 120 VAC	
Remarks:			

Table 7.9.2 Conducted emission test results

LINE: AC mains
 EUT OPERATING MODE: Transmit
 EUT SET UP: TABLE-TOP
 TEST SITE: SHIELDED ROOM
 DETECTORS USED: PEAK / QUASI-PEAK / AVERAGE
 FREQUENCY RANGE: 150 kHz - 30 MHz
 RESOLUTION BANDWIDTH: 9 kHz

Frequency, MHz	Peak emission, dB(µV)	Quasi-peak			Average			Line ID	Verdict
		Measured emission, dB(µV)	Limit, dB(µV)	Margin, dB*	Measured emission, dB(µV)	Limit, dB(µV)	Margin, dB*		
0.150	53.02	51.09	66.00	-14.91	38.45	56.00	-17.55	L1	Pass
0.160	50.67	43.35	65.48	-22.13	28.74	55.48	-26.74		
0.189	47.92	42.50	64.05	-21.55	26.00	54.05	-28.05		
0.409	37.40	32.88	57.68	-24.80	23.67	47.68	-24.01		
7.805	29.73	25.47	60.00	-34.53	17.33	50.00	-32.67		
0.150	52.73	50.78	65.96	-15.18	35.23	55.96	-20.73	L2	Pass
0.163	52.86	43.57	65.35	-21.78	22.17	55.35	-33.18		
0.194	48.54	45.03	63.88	-18.85	26.95	53.88	-26.93		
0.280	39.65	37.42	60.85	-23.43	18.12	50.85	-32.73		
0.510	28.69	25.27	56.00	-30.73	13.29	46.00	-32.71		
0.597	27.47	21.83	56.00	-34.17	10.33	46.00	-35.67		

*- Margin = Measured emission - specification limit.

Reference numbers of test equipment used

HL 0447	HL 1425	HL 1513	HL 3612	HL 3774	HL 4527		
---------	---------	---------	---------	---------	---------	--	--

Full description is given in Appendix A.



Test specification:		Section 15.207(a), RSS-Gen section 8.8, Conducted emission	
Test procedure:		ANSI C63.4, Section 13.1.3	
Test mode:		Compliance	
Date(s):		27-Apr-15	
Temperature: 22 °C		Air Pressure: 1011 hPa	
		Relative Humidity: 39 %	
		Power Supply: 120 VAC	
Remarks:			
		Verdict: PASS	

Plot 7.9.1 Conducted emission measurements

LINE: L1
 EUT OPERATING MODE: Transmit
 LIMIT: QUASI-PEAK, AVERAGE
 DETECTOR: PEAK

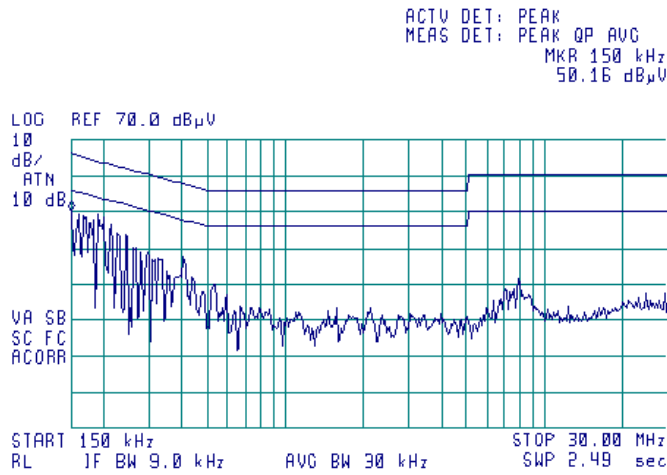

Plot 7.9.2 Conducted emission measurements

LINE: L2
 EUT OPERATING MODE: Transmit
 LIMIT: QUASI-PEAK, AVERAGE
 DETECTOR: PEAK

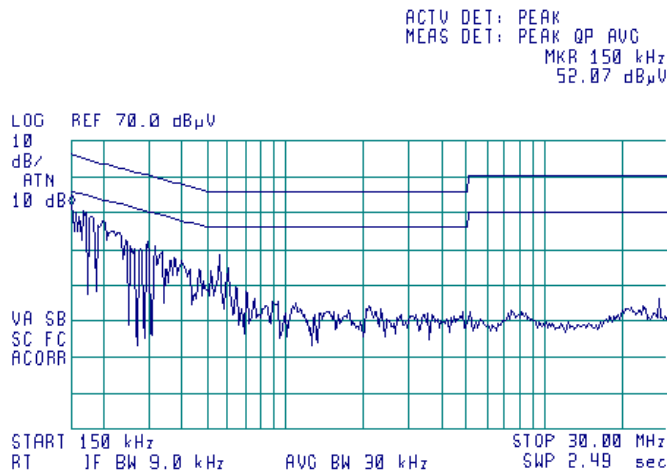



Test specification: Section 15.107, ICES-003 section 6.1, Conducted emission at AC power port	
Test procedure: ANSI C63.4, Sections 11.5 and 12.1.3	
Test mode: Compliance	Verdict: PASS
Date(s): 27-Apr-15	
Temperature: 22 °C	Air Pressure: 1011 hPa
Relative Humidity: 39 %	
Power Supply: 120 VAC	
Remarks:	

8 Unintentional emissions

8.1 Conducted emissions

8.1.1 General

This test was performed to measure common mode conducted emissions at the mains power port. Specification test limits are given in Table 8.1.1.

Table 8.1.1 Limits for conducted emissions

Frequency, MHz	Class B limit, dB(μV)		Class A limit, dB(μV)	
	QP	AVRG	QP	AVRG
0.15 - 0.5	66 - 56*	56 - 46*	79	66
0.5 - 5.0	56	46	73	60
5.0 - 30	60	50	73	60

* The limit decreases linearly with the logarithm of frequency.

8.1.2 Test procedure

8.1.2.1 The EUT was set up as shown in Figure 8.1.1 and associated photograph, energized and the performance check was conducted.

8.1.2.2 The measurements were performed at power terminals with the LISN, connected to a spectrum analyzer in the frequency range referred to in Table 8.1.2. Unused coaxial connector of the LISN was terminated with 50 Ohm. Quasi-peak and average detectors were used throughout the testing.

8.1.2.3 The position of the device cables was varied to determine maximum emission level.



Test specification:	Section 15.107, ICES-003 section 6.1, Conducted emission at AC power port		
Test procedure:	ANSI C63.4, Sections 11.5 and 12.1.3		
Test mode:	Compliance	Verdict:	PASS
Date(s):	27-Apr-15		
Temperature: 22 °C	Air Pressure: 1011 hPa	Relative Humidity: 39 %	Power Supply: 120 VAC
Remarks:			

Figure 8.1.1 Setup for conducted emission measurements, table-top equipment

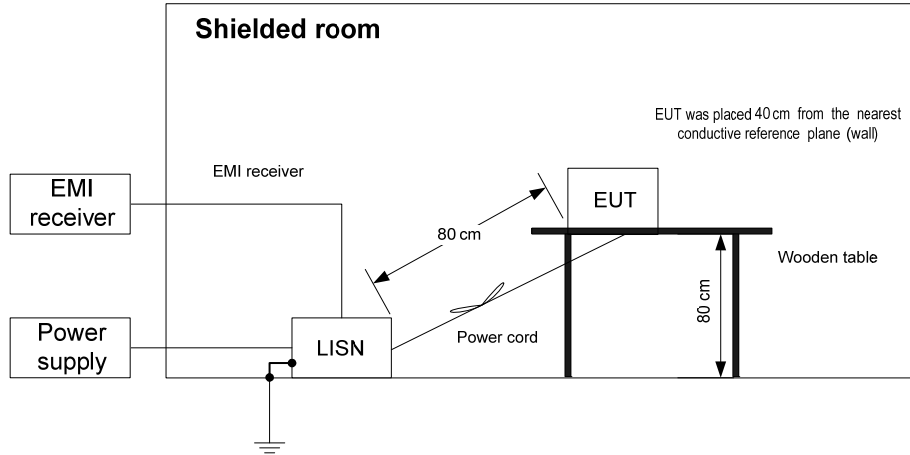

Photograph 8.1.1 Setup for conducted emission measurements





Test specification:	Section 15.107, ICES-003 section 6.1, Conducted emission at AC power port		
Test procedure:	ANSI C63.4, Sections 11.5 and 12.1.3		
Test mode:	Compliance	Verdict:	PASS
Date(s):	27-Apr-15		
Temperature: 22 °C	Air Pressure: 1011 hPa	Relative Humidity: 39 %	Power Supply: 120 VAC
Remarks:			

Table 8.1.2 Conducted emission test results

LINE: AC mains
LIMIT: Class B
EUT OPERATING MODE: Receive / Stand-by
EUT SET UP: TABLE-TOP
TEST SITE: SHIELDED ROOM
DETECTORS USED: PEAK / QUASI-PEAK / AVERAGE
FREQUENCY RANGE: 150 kHz - 30 MHz
RESOLUTION BANDWIDTH: 9 kHz

Frequency, MHz	Peak emission, dB(µV)	Quasi-peak			Average			Line ID	Verdict
		Measured emission, dB(µV)	Limit, dB(µV)	Margin, dB*	Measured emission, dB(µV)	Limit, dB(µV)	Margin, dB*		
0.150	53.02	51.09	66.00	-14.91	38.45	56.00	-17.55	L1	Pass
0.160	50.67	43.35	65.48	-22.13	28.74	55.48	-26.74		
0.189	47.92	42.50	64.05	-21.55	26.00	54.05	-28.05		
0.409	37.40	32.88	57.68	-24.80	23.67	47.68	-24.01		
7.805	29.73	25.47	60.00	-34.53	17.33	50.00	-32.67		
0.150	52.73	50.78	65.96	-15.18	35.23	55.96	-20.73	L2	Pass
0.163	52.86	43.57	65.35	-21.78	22.17	55.35	-33.18		
0.194	48.54	45.03	63.88	-18.85	26.95	53.88	-26.93		
0.280	39.65	37.42	60.85	-23.43	18.12	50.85	-32.73		
0.510	28.69	25.27	56.00	-30.73	13.29	46.00	-32.71		
0.597	27.47	21.83	56.00	-34.17	10.33	46.00	-35.67		

*- Margin = Measured emission - specification limit.

Reference numbers of test equipment used

HL 0447	HL 1425	HL 1513	HL 3612	HL 3774	HL 4527		
---------	---------	---------	---------	---------	---------	--	--

Full description is given in Appendix A.



HERMON LABORATORIES

Test specification:	Section 15.107, ICES-003 section 6.1, Conducted emission at AC power port		
Test procedure:	ANSI C63.4, Sections 11.5 and 12.1.3		
Test mode:	Compliance	Verdict:	PASS
Date(s):	27-Apr-15		
Temperature: 22 °C	Air Pressure: 1011 hPa	Relative Humidity: 39 %	Power Supply: 120 VAC
Remarks:			

Plot 8.1.1 Conducted emission measurements

LINE: L1
 LIMIT: Class B
 EUT OPERATING MODE: Receive / Stand-by
 LIMIT: QUASI-PEAK, AVERAGE
 DETECTOR: PEAK



ACTU DET: PEAK
 MEAS DET: PEAK QP AVG
 MKR 150 kHz
 50.16 dBµV

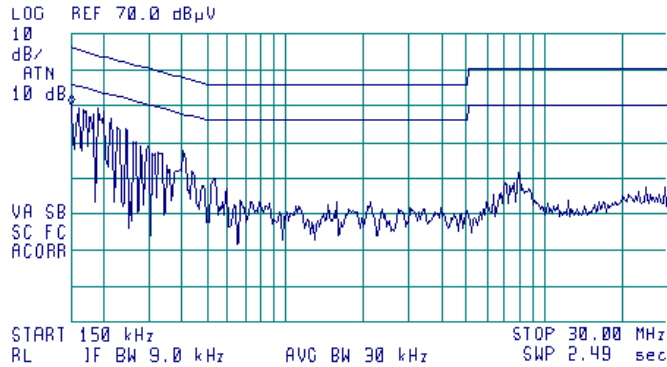

Plot 8.1.2 Conducted emission measurements

LINE: L2
 LIMIT: Class B
 EUT OPERATING MODE: Receive / Stand-by
 LIMIT: QUASI-PEAK, AVERAGE
 DETECTOR: PEAK



ACTU DET: PEAK
 MEAS DET: PEAK QP AVG
 MKR 150 kHz
 52.07 dBµV

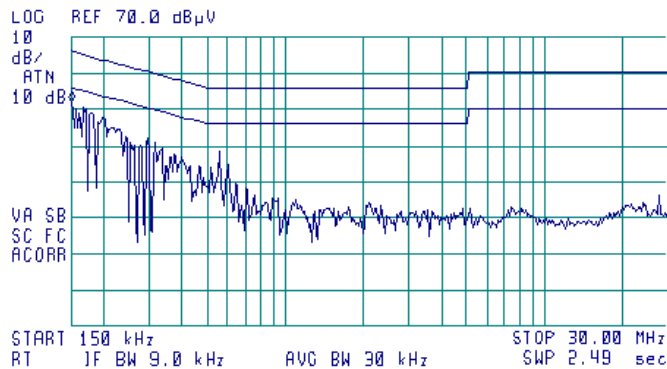



Test specification:	Section 15.109, RSS-Gen section 7.1.2, ICES-003 Section 6.2, Radiated emission		
Test procedure:	ANSI C63.4, Sections 11.6 and 12.1.4		
Test mode:	Compliance	Verdict:	PASS
Date(s):	16-Apr-15		
Temperature: 22 °C	Air Pressure: 1015 hPa	Relative Humidity: 44 %	Power Supply: 120 VAC
Remarks:			

8.2 Radiated emission measurements

8.2.1 General

This test was performed to measure radiated emissions from the EUT enclosure. Specification test limits are given in Table 8.2.1, Table 8.2.2.

Table 8.2.1 Radiated emission test limits

Frequency, MHz	Class B limit, dB(μV/m)		Class A limit, dB(μV/m)	
	10 m distance	3 m distance	10 m distance	3 m distance
30 - 88	29.5*	40.0	39.0	49.5*
88 - 216	33.0*	43.5	43.5	54.0*
216 - 960	35.5*	46.0	46.4	56.9*
960 - 5 th harmonic**	43.5*	54.0	49.5	60.0*

* - The limit for test distance other than specified was calculated using the inverse linear distance extrapolation factor as follows: $Lim_{S_2} = Lim_{S_1} + 20 \log(S_1/S_2)$, where S_1 and S_2 – standard defined and test distance respectively in meters.

Table 8.2.2 Radiated emission limits according to RSS-Gen, Section 7.1.2

Frequency, MHz	Field strength limit at 3 m test distance, dB(μV/m)
30 - 88	40.0
88 - 216	43.5
216 - 960	46.0
960 - 5 th harmonic**	54.0

** - harmonic of the highest frequency the EUT generates, uses, operates or tunes to.

8.2.2 Test procedure

8.2.2.1 The EUT was set up as shown in Figure 8.2.1 and associated photograph/s, energized and the performance check was conducted.

8.2.2.2 The specified frequency range was investigated with biconilog antenna connected to EMI receiver. To find maximum radiation the turntable was rotated 360°, the measuring antenna height was changed from 1 to 4 m, its polarization was switched from vertical to horizontal and the EUT cables position was varied.

8.2.2.3 The worst test results (the lowest margins) were recorded in Table 8.2.3 and shown in the associated plots.



Test specification:	Section 15.109, RSS-Gen section 7.1.2, ICES-003 Section 6.2, Radiated emission		
Test procedure:	ANSI C63.4, Sections 11.6 and 12.1.4		
Test mode:	Compliance	Verdict:	PASS
Date(s):	16-Apr-15		
Temperature: 22 °C	Air Pressure: 1015 hPa	Relative Humidity: 44 %	Power Supply: 120 VAC
Remarks:			

Figure 8.2.1 Setup for radiated emission measurements in anechoic chamber, table-top equipment

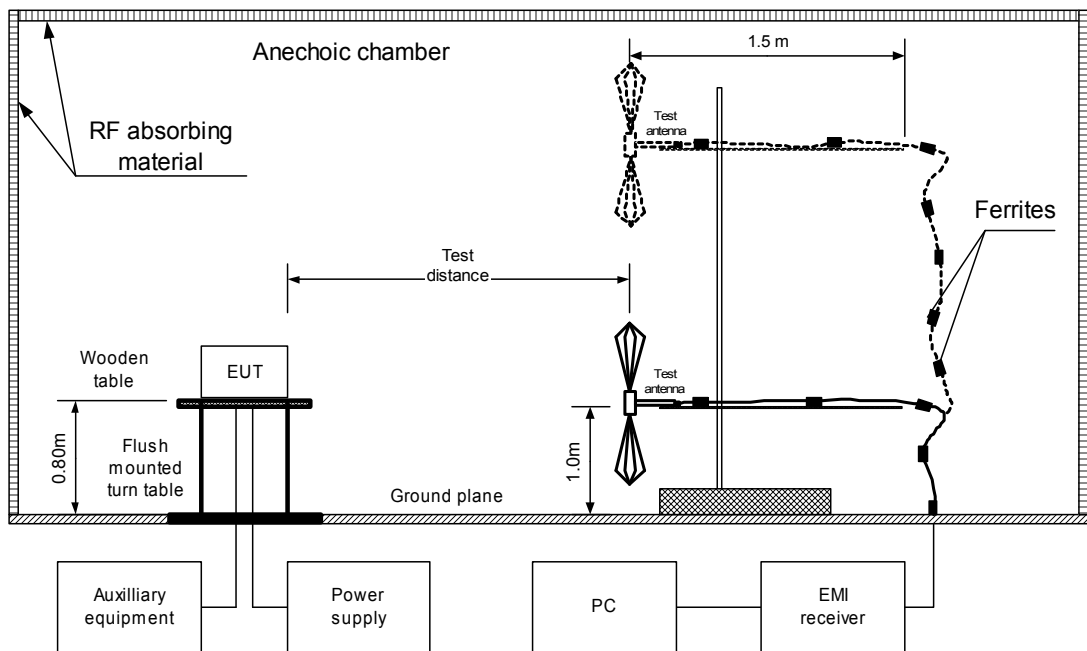



Test specification:	Section 15.109, RSS-Gen section 7.1.2, ICES-003 Section 6.2, Radiated emission		
Test procedure:	ANSI C63.4, Sections 11.6 and 12.1.4		
Test mode:	Compliance	Verdict:	PASS
Date(s):	16-Apr-15		
Temperature: 22 °C	Air Pressure: 1015 hPa	Relative Humidity: 44 %	Power Supply: 120 VAC
Remarks:			

Photograph 8.2.1 Setup for radiated emission measurements



Photograph 8.2.2 Setup for radiated emission measurements, EUT cabling

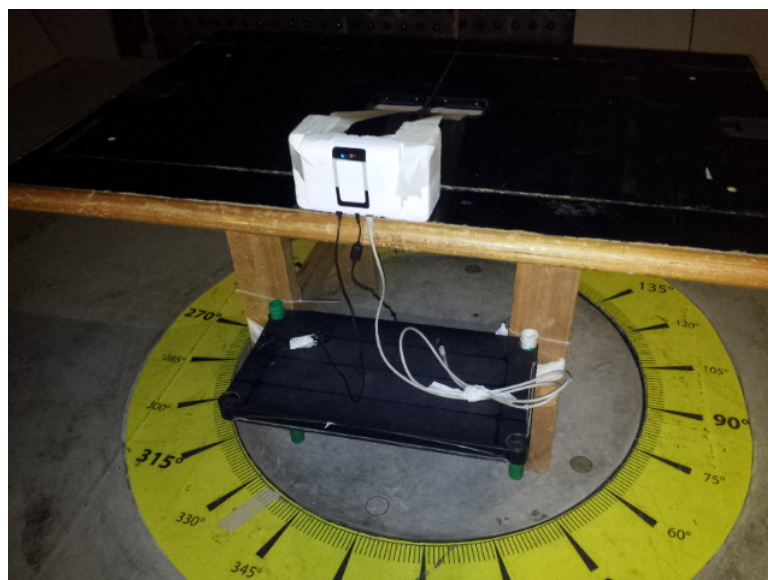



Test specification:	Section 15.109, RSS-Gen section 7.1.2, ICES-003 Section 6.2, Radiated emission		
Test procedure:	ANSI C63.4, Sections 11.6 and 12.1.4		
Test mode:	Compliance	Verdict: PASS	
Date(s):	16-Apr-15		
Temperature: 22 °C	Air Pressure: 1015 hPa	Relative Humidity: 44 %	Power Supply: 120 VAC
Remarks:			

Table 8.2.3 Radiated emission test results

EUT SET UP: TABLE-TOP
 LIMIT: Class B
 EUT OPERATING MODE: Receive / Stand-by
 TEST SITE: SEMI ANECHOIC CHAMBER
 TEST DISTANCE: 3 m
 DETECTORS USED: PEAK / QUASI-PEAK
 FREQUENCY RANGE: 30 MHz – 1000 MHz
 RESOLUTION BANDWIDTH: 120 kHz

Frequency, MHz	Peak emission, dB(µV/m)	Quasi-peak			Antenna polarization	Antenna height, m	Turn-table position**, degrees	Verdict
		Measured emission, dB(µV/m)	Limit, dB(µV/m)	Margin, dB*				
No emission were found								Pass

TEST SITE: SEMI ANECHOIC CHAMBER
 TEST DISTANCE: 3 m
 DETECTORS USED: PEAK / AVERAGE
 FREQUENCY RANGE: 1000 MHz – 9500 MHz
 RESOLUTION BANDWIDTH: 1000 kHz

Frequency, MHz	Peak			Average			Antenna polarization	Antenna height, m	Turn-table position**, degrees	Verdict
	Measured emission, dB(µV/m)	Limit, dB(µV/m)	Margin, dB*	Measured emission, dB(µV/m)	Limit, dB(µV/m)	Margin, dB*				
No emission were found										Pass

*- Margin = Measured emission - specification limit.
 **- EUT front panel refer to 0 degrees position of turntable.

Reference numbers of test equipment used

HL 0521	HL 0604	HL 1984	HL 2781	HL 4353			
---------	---------	---------	---------	---------	--	--	--

Full description is given in Appendix A.



Test specification:	Section 15.109, RSS-Gen section 7.1.2, ICES-003 Section 6.2, Radiated emission		
Test procedure:	ANSI C63.4, Sections 11.6 and 12.1.4		
Test mode:	Compliance	Verdict:	PASS
Date(s):	16-Apr-15		
Temperature: 22 °C	Air Pressure: 1015 hPa	Relative Humidity: 44 %	Power Supply: 120 VAC
Remarks:			

Plot 8.2.1 Radiated emission measurements in 30 - 1000 MHz range, vertical antenna polarization

TEST SITE: Semi anechoic chamber
LIMIT: Class B
TEST DISTANCE: 3 m
EUT OPERATING MODE: Receive / Stand-by

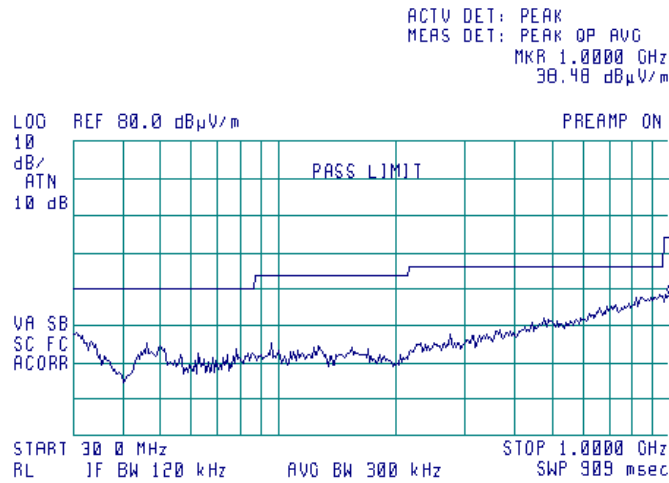

Plot 8.2.2 Radiated emission measurements in 30 - 1000 MHz range, horizontal antenna polarization

TEST SITE: Semi anechoic chamber
LIMIT: Class B
TEST DISTANCE: 3 m
EUT OPERATING MODE: Receive / Stand-by

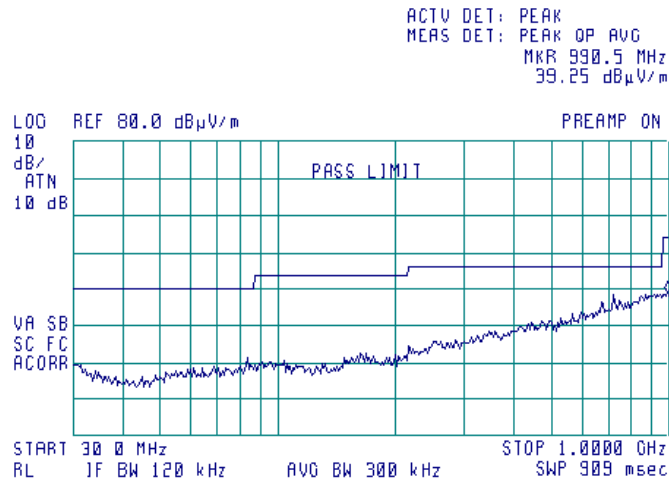



Test specification:		Section 15.109, RSS-Gen section 7.1.2, ICES-003 Section 6.2, Radiated emission	
Test procedure:		ANSI C63.4, Sections 11.6 and 12.1.4	
Test mode:	Compliance	Verdict:	PASS
Date(s):	16-Apr-15		
Temperature: 22 °C	Air Pressure: 1015 hPa	Relative Humidity: 44 %	Power Supply: 120 VAC
Remarks:			

Plot 8.2.3 Radiated emission measurements in 1.0-6.5GHz range, vertical and horizontal antenna polarization

TEST SITE: Semi anechoic chamber
LIMIT: Class B
TEST DISTANCE: 3 m
EUT OPERATING MODE: Receive / Stand-by

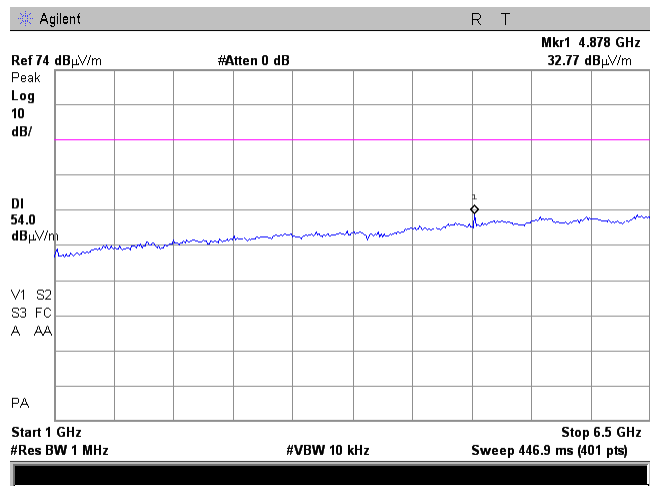
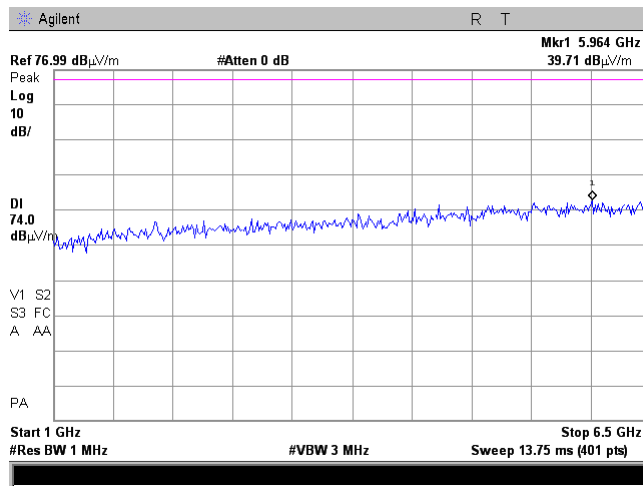

Plot 8.2.4 Radiated emission measurements in 6.5-9.5 GHz range, vertical and horizontal antenna polarization

TEST SITE: Semi anechoic chamber
LIMIT: Class B
TEST DISTANCE: 3 m
EUT OPERATING MODE: Receive / Stand-by

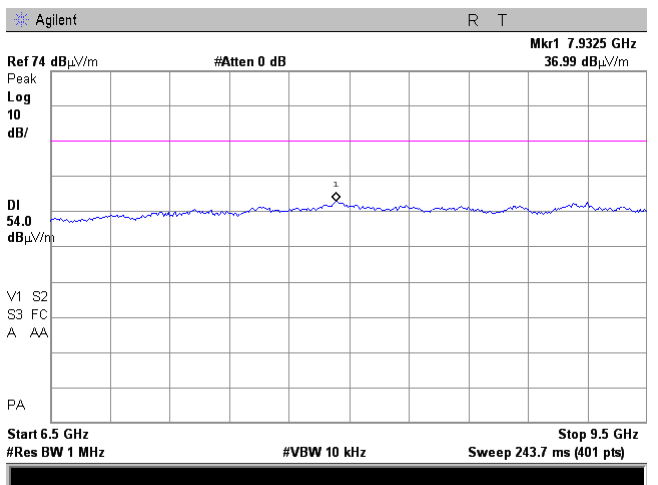
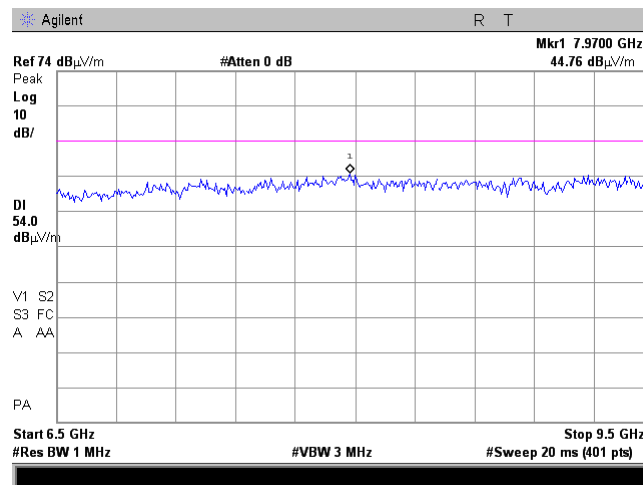



9 APPENDIX A Test equipment and ancillaries used for tests

HL No	Description	Manufacturer	Model	Ser. No.	Last Cal./ Check	Due Cal./ Check
0337	Probe Set, Hand held, 5 probes	Electro-Metrics	EHFP-30	238	14-Jun-15	14-Jun-16
0446	Antenna, Loop, Active, 10 kHz - 30 MHz	EMCO	6502	2857	13-Jan-15	13-Jan-16
0447	LISN, 16/2, 300V RMS, 50 Ohm/50 uH + 5 Ohm, STD CISPR 16-1	Hermon Laboratories	LISN 16 - 1	066	23-Oct-14	23-Oct-15
0521	EMI Receiver (Spectrum Analyzer) with RF filter section 9 kHz-6.5 GHz	Hewlett Packard	8546A	3617A 00319, 3448A002 53	22-Oct-14	22-Oct-15
0604	Antenna BiconiLog Log-Periodic/T Bow-TIE, 26 - 2000 MHz	EMCO	3141	9611-1011	15-May-15	15-May-16
1424	Spectrum Analyzer, 30 Hz- 40 GHz	Agilent Technologies	8564EC	3946A002 19	12-Apr-15	12-Apr-16
1425	EMI Receiver, 9 kHz - 2.9 GHz, System: HL1426, HL1427	Agilent Technologies	8542E	3710A002 22, 3705A002 04	24-Dec-14	24-Dec-15
1513	Cable RF, 8 m, BNC/BNC	Belden	M17/167 MIL-C-17	1513	08-Sep-15	08-Sep-16
1984	Antenna, Double-Ridged Waveguide Horn, 1 to 18 GHz, 300 W	EMC Test Systems	3115	9911-5964	17-Apr-15	17-Apr-16
2780	EMC analyzer, 100 Hz to 26.5 GHz	Agilent Technologies	E7405A	MY451024 62	02-Sep-14	02-Oct-15
3612	Cable RF, 17.5 m, N type-N type	Teldor	RG-214/U	NA	07-Dec-14	07-Dec-15
3774	Attenuator, N-type, 10 dB, DC to 18 GHz, 5 W	Mini-Circuits	BW-N10W5+	NA	01-Jan-15	01-Jan-16
3818	PSA Series Spectrum Analyzer, 3 Hz- 44 GHz	Agilent Technologies	E4446A	MY482502 88	29-Apr-15	29-Apr-16
4136	Shield Box	TESCOM CO., LTD	TC-5916A	5916A000 137	08-Apr-15	08-Apr-16
4273	Test Cable , DC-18 GHz, 1.8 m, SMA/M - N/M	Mini-Circuits	CBL-6FT-SMNM+	70045	28-May-15	28-May-16
4279	Test Cable , DC-18 GHz, 4.6 m, N/M - N/M	Mini-Circuits	APC-15FT-NMNM+	0757A	20-Nov-14	20-Nov-15
4295	Microwave Cable Assembly, 18.0 GHz, 3.4 m, SMA/SMA	Huber-Suhner	Sucoflex P103	NA	04-Dec-14	04-Dec-15
4353	Low Loss Armored Test Cable, DC - 18 GHz, 6.2 m, N type-M/N type-M	MegaPhase	NC29-N1N1-244	12025101 003	15-Mar-15	15-Mar-16
4527	DC block , 50 Ohm, 10 MHz to 6 GHz	Mini-Circuits	BLK-6-N+	NA	13-Jan-15	13-Jan-17
4535	Microwave Cable Assembly, 6.5 GHz, 5.0 m, N/M type-N/M type	Suhner Switzerland	214-U	NA	15-May-15	15-May-16
4541	Microwave Cable Assembly, 4.0 GHz, 1.0 m, N/M type-N/M type	Suhner Switzerland	214-U	NA	26-Aug-15	26-Aug-16
4542	Amplifier, 9 kHz to 1 GHz, 32 dB gain	Sonoma Instrument	310	0002A056 39	26-Mar-15	26-Mar-16



HL No	Description	Manufacturer	Model	Ser. No.	Last Cal./ Check	Due Cal./ Check
4543	Broadband preamplifier, 0.5 to 18 GHz, 35 dB gain	Schwarzbeck mess-elektronik	BBV 9718	9718-134	05-Mar-15	05-Mar-16
4549	Cable RF, 6.8 m, N/N - type, up to 3 GHz	Suhner Switzerland	NA	07262	05-Mar-15	05-Mar-16
4551	Cable RF, 6.6 m, N/N - type, up to 18 GHz	Suhner Switzerland	Sucoflex 104E	22200/4E	05-Mar-15	05-Mar-16
4575	EXA Signal Analyzer, 9 kHz - 26.5 GHz	Agilent Technologies	N9010A	MY480301 10	05-Feb-15	05-Feb-16
4603	Horn Antenna, 1 - 18 GHz	Schwarzbeck mess-elektronik	BBHA 9120 D	9120D-611	18-Jun-15	18-Jul-16
4604	Biconilog Antenna, 26 - 2000 MHz	EMCO	3142B	9909-1421	15-May-15	15-May-16
4933	Active Horn Antenna, 1 GHz to 18 GHz	Com-Power Corporation	AHA-118	701046	04-Sep-15	04-Sep-16



10 APPENDIX B Measurement uncertainties

Expanded uncertainty at 95% confidence in Hermon Labs EMC measurements

Test description	Expanded uncertainty
Conducted carrier power at RF antenna connector	Below 12.4 GHz: ± 1.7 dB 12.4 GHz to 40 GHz: ± 2.3 dB
Conducted emissions at RF antenna connector	9 kHz to 2.9 GHz: ± 2.6 dB 2.9 GHz to 6.46 GHz: ± 3.5 dB 6.46 GHz to 13.2 GHz: ± 4.3 dB 13.2 GHz to 22.0 GHz: ± 5.0 dB 22.0 GHz to 26.8 GHz: ± 5.5 dB 26.8 GHz to 40.0 GHz: ± 4.8 dB
Occupied bandwidth	± 8.0 %
Duty cycle, timing (Tx ON / OFF) and average factor measurements	± 1.0 %
Conducted emissions with LISN	9 kHz to 150 kHz: ± 3.9 dB 150 kHz to 30 MHz: ± 3.8 dB
Radiated emissions at 3 m measuring distance Horizontal polarization	Biconilog antenna: ± 5.3 dB Biconical antenna: ± 5.0 dB Log periodic antenna: ± 5.3 dB
Vertical polarization	Double ridged horn antenna: ± 5.3 dB Biconilog antenna: ± 6.0 dB Biconical antenna: ± 5.7 dB Log periodic antenna: ± 6.0 dB Double ridged horn antenna: ± 6.0 dB

Hermon Laboratories is accredited by A2LA for calibration according to present requirements of ISO/IEC 17025 and NCSL Z540-1. The accreditation is granted to perform calibration of parameters that are listed in the Scope of Hermon Laboratories Accreditation.

Hermon Laboratories calibrates its reference and transfer standards by calibration laboratories accredited to ISO/IEC 17025 by a mutually recognized Accreditation Body or by a recognized national metrology institute. All reference and transfer standards used in the calibration system are traceable to national or international standards.

In-house calibration of all test and measurement equipment is performed on a regular basis according to Hermon Laboratories calibration procedures, manufacturer calibration/verification procedures or procedures defined in the relevant standards. The Hermon Laboratories test and measurement equipment is calibrated within the tolerances specified by the manufacturers and/or by the relevant standards.

11 APPENDIX C Test laboratory description

Tests were performed at Hermon Laboratories Ltd., which is a fully independent, private, EMC, safety, environmental and telecommunication testing facility.

Hermon Laboratories is listed by the Federal Communications Commission (USA) for all parts of Code of Federal Regulations 47 (CFR 47), Registration Numbers 90624 for OATS and 90623 for the anechoic chamber; by Industry Canada for electromagnetic emissions (file number IC 2186A-1 for OATS), certified by VCCI, Japan (the registration numbers are R-808 for OATS, R-1082 for anechoic chamber, C-845 for conducted emissions site, T-1606 for conducted emissions at telecommunication ports), has a status of a Telefication - Listed Testing Laboratory, Certificate No. L138/00. The laboratory is accredited by American Association for Laboratory Accreditation (USA) according to ISO/IEC 17025 for electromagnetic compatibility, product safety, telecommunications testing and environmental simulation (for exact scope please refer to Certificate No. 839.01). The FCC Designation Number is IL1001.

Address: P.O. Box 23, Binyamina 30500, Israel.
Telephone: +972 4628 8001
Fax: +972 4628 8277
e-mail: mail@hermonlabs.com
website: www.hermonlabs.com

Person for contact: Mr. Alex Usoskin, CEO.

12 APPENDIX D Specification references

RSS-247 Issue 1: 2015	Digital Transmission Systems (DTSs), Frequency Hopping Systems (FHSs) and Licence- Exempt Local Area Network (LE-LAN) Devices
RSS-Gen Issue 4: 2014	General Requirements for Compliance of Radio Apparatus
FCC 47CFR part 15: 2014	Radio Frequency Devices
Public notice DA 00- 705: 2000	Filing and measurement guidelines for frequency hopping spread spectrum systems.
ANSI C63.2: 1996	American National Standard for Instrumentation-Electromagnetic Noise and Field Strength, 10 kHz to 40 GHz-Specifications
ANSI C63.4: 2009	American National Standard for Methods of Measurement of Radio-Noise Emissions from Low-Voltage Electrical and Electronic Equipment in the Range of 9 kHz to 40 GHz
ICES-003 issue 5:2012	Information Technology Equipment (ITE) – Limits and methods of measurement



13 APPENDIX E Test equipment correction factors

**Antenna factor
Active loop antenna
Model 6502, S/N 2857, HL 0446**

Frequency, MHz	Magnetic antenna factor, dB	Electric antenna factor, dB
0.009	-32.8	18.7
0.010	-33.8	17.7
0.020	-38.3	13.2
0.050	-41.1	10.4
0.075	-41.3	10.2
0.100	-41.6	9.9
0.150	-41.7	9.8
0.250	-41.6	9.9
0.500	-41.8	9.8
0.750	-41.9	9.7
1.000	-41.4	10.1
2.000	-41.5	10.0
3.000	-41.4	10.2
4.000	-41.4	10.1
5.000	-41.5	10.1
10.000	-41.9	9.6
15.000	-41.9	9.6
20.000	-42.2	9.3
25.000	-42.8	8.7
30.000	-44.0	7.5

Antenna factor in dB(1/m) is to be added to receiver meter reading in dB(μ V) to convert it into field strength in dB(μ V/m).



Antenna factor
Biconilog antenna EMCO Model 3141
Ser.No.1011, HL 0604

Frequency, MHz	Antenna factor, dB(1/m)	Frequency, MHz	Antenna factor, dB(1/m)	Frequency, MHz	Antenna factor, dB(1/m)
26	7.8	580	20.6	1320	27.8
28	7.8	600	21.3	1340	28.3
30	7.8	620	21.5	1360	28.2
40	7.2	640	21.2	1380	27.9
60	7.1	660	21.4	1400	27.9
70	8.5	680	21.9	1420	27.9
80	9.4	700	22.2	1440	27.8
90	9.8	720	22.2	1460	27.8
100	9.7	740	22.1	1480	28.0
110	9.3	760	22.3	1500	28.5
120	8.8	780	22.6	1520	28.9
130	8.7	800	22.7	1540	29.6
140	9.2	820	22.9	1560	29.8
150	9.8	840	23.1	1580	29.6
160	10.2	860	23.4	1600	29.5
170	10.4	880	23.8	1620	29.3
180	10.4	900	24.1	1640	29.2
190	10.3	920	24.1	1660	29.4
200	10.6	940	24.0	1680	29.6
220	11.6	960	24.1	1700	29.8
240	12.4	980	24.5	1720	30.3
260	12.8	1000	24.9	1740	30.8
280	13.7	1020	25.0	1760	31.1
300	14.7	1040	25.2	1780	31.0
320	15.2	1060	25.4	1800	30.9
340	15.4	1080	25.6	1820	30.7
360	16.1	1100	25.7	1840	30.6
380	16.4	1120	26.0	1860	30.6
400	16.6	1140	26.4	1880	30.6
420	16.7	1160	27.0	1900	30.6
440	17.0	1180	27.0	1920	30.7
460	17.7	1200	26.7	1940	30.9
480	18.1	1220	26.5	1960	31.2
500	18.5	1240	26.5	1980	31.6
520	19.1	1260	26.5	2000	32.0
540	19.5	1280	26.6		
560	19.8	1300	27.0		

Antenna factor in dB(1/m) is to be added to receiver meter reading in dB(μV) to convert it into field strength in dB(μV/m).



Antenna factor
Double-ridged wave guide horn antenna
Model 3115, S/N 9911-5964, HL1984

Frequency, MHz	Antenna factor, dB(1/m)
1000.0	24.7
1500.0	25.7
2000.0	27.6
2500.0	28.9
3000.0	31.2
3500.0	32.0
4000.0	32.5
4500.0	32.7
5000.0	33.6
5500.0	35.1
6000.0	35.4
6500.0	34.9
7000.0	36.1
7500.0	37.8
8000.0	38.0
8500.0	38.1
9000.0	39.1
9500.0	38.3
10000.0	38.6
10500.0	38.2
11000.0	38.7
11500.0	39.5
12000.0	40.0
12500.0	40.4
13000.0	40.5
13500.0	41.1
14000.0	41.6
14500.0	41.7
15000.0	38.7
15500.0	38.2
16000.0	38.8
16500.0	40.5
17000.0	42.5
17500.0	45.9
18000.0	49.4

Antenna factor in dB(1/m) is to be added to receiver meter reading in dB(μ V) to convert it into field strength in dB(μ V/m).



Antenna factor
Horn antenna
Schwarzbeck mess-elektronik, Model BBHA 9120 D, serial number: 9120D-611, HL 4603

Frequency, MHz	Measured antenna factor, dB/m
1000	25.2
1500	25.7
2000	26.1
2500	27.5
3000	28.3
3500	29.0
4000	30.0
4500	30.8
5000	31.9
5500	32.2
6000	33.1
6500	34.6
7000	35.9
7500	36.6
8000	37.2
8500	36.6
9000	36.9
9500	37.5
10000	38.4
10500	39.5
11000	40.3
11500	40.0
12000	39.2
12500	38.7
13000	39.6
13500	40.8
14000	41.6
14500	42.1
15000	41.2
15500	39.1
16000	38.5
16500	39.9
17000	41.0
17500	44.1
18000	55.6

The antenna factor shall be added to receiver reading in dB μ V to obtain field strength in dB μ V/m.



Antenna factor
Biconilog Antenna, 26 - 2000 MHz
EMCO, Model 3142B, serial number: 9909-1421, HL 4604

Frequency, MHz	Measured, dB/m
30	17.9
35	14.8
40	12.1
45	10.0
50	8.7
60	8.1
70	7.3
80	6.6
90	7.6
100	7.9
120	7.0
140	7.7
160	9.6
180	10.0
200	10.2
250	12.7
300	13.4
400	16.7
500	18.2
600	20.2
700	22.0
800	22.7
900	24.1
1000	25.0

The antenna factor shall be added to receiver reading in dB μ V to obtain field strength in dB μ V/m



Antenna factor, HL 4933



Active Horn Antenna Calibration

1 GHz to 18 GHz

Equipment:	ACTIVE HORN ANTENNA
Model:	AHA-118
Serial Number:	701046
Calibration Distance:	3 Meter
Polarization:	Horizontal
Calibration Date:	11/12/2014

Frequency (GHz)	Preamplifier Gain (dB)	Antenna Factor with pre-amp (dB/m)	Frequency (GHz)	Preamplifier Gain (dB)	Antenna Factor with pre-amp (dB/m)
1	40.96	-16.47	10	40.94	-1.97
1.5	41.21	-14.53	10.5	40.63	-1.06
2	41.44	-13.30	11	40.74	-1.50
2.5	41.71	-12.87	11.5	40.65	-0.52
3	41.96	-12.26	12	40.76	-0.15
3.5	42.14	-11.77	12.5	41.03	-0.85
4	42.13	-10.91	13	41.37	-0.81
4.5	41.79	-9.41	13.5	41.18	0.05
5	41.44	-7.54	14	40.98	0.36
5.5	40.91	-6.47	14.5	40.81	1.26
6	40.69	-5.48	15	40.65	0.25
6.5	40.64	-5.53	15.5	40.93	-1.05
7	40.76	-4.12	16	41.31	-1.44
7.5	40.94	-3.12	16.5	40.96	-0.80
8	40.68	-1.69	17	40.64	-0.02
8.5	40.08	-1.71	17.5	40.57	1.81
9	40.41	-1.86	18	40.08	3.63
9.5	41.21	-2.73			

Calibration according to ARP 958

Antenna Factor to be added to receiver reading:

Meter Reading (dBuV) + Antenna Factor (dB/m) = Corrected Reading (dBuV/m)

Correction factor
Line impedance stabilization network
Model LISN 16 - 1
Hermon Laboratories, HL 0447

Frequency, kHz	Correction factor, dB
10	4.9
15	2.86
20	1.83
25	1.25
30	0.91
35	0.69
40	0.53
50	0.35
60	0.25
70	0.18
80	0.14
90	0.11
100	0.09
125	0.06
150	0.04

The correction factor in dB is to be added to meter readings of an interference analyzer or a spectrum analyzer.



Cable loss
Cable coaxial, RG-214/U, N type-N type, 17 m
Teldor, HL 3612

Frequency, MHz	Cable loss, dB
0.1	0.05
0.5	0.07
1	0.10
3	0.22
5	0.29
10	0.39
30	0.68
50	0.90
100	1.27
150	1.58
200	1.80
250	2.12
300	2.36
350	2.60
400	2.82
450	2.99
500	3.23
550	3.40
600	3.56
650	3.71
700	3.90
750	4.04
800	4.23
850	4.39
900	4.55
950	4.65
1000	4.79



Cable loss
Test cable, Mini-Circuits, S/N 70045, 18 GHz, 1.8 m, SMA/M - N/M
CBL-6FT-SMNM+, HL 4273

Frequency, MHz	Cable loss, dB	Frequency, MHz	Cable loss, dB	Frequency, MHz	Cable loss, dB	Frequency, MHz	Cable loss, dB
10	0.09	4800	1.76	9800	2.70	14800	3.59
30	0.11	4900	1.78	9900	2.71	14900	3.59
50	0.14	5000	1.81	10000	2.73	15000	3.60
100	0.20	5100	1.82	10100	2.75	15100	3.63
200	0.30	5200	1.86	10200	2.76	15200	3.67
300	0.38	5300	1.89	10300	2.79	15300	3.70
400	0.45	5400	1.92	10400	2.81	15400	3.68
500	0.50	5500	1.96	10500	2.82	15500	3.70
600	0.55	5600	2.00	10600	2.83	15600	3.71
700	0.60	5700	2.03	10700	2.87	15700	3.77
800	0.65	5800	2.04	10800	2.87	15800	3.75
900	0.69	5900	2.07	10900	2.88	15900	3.77
1000	0.73	6000	2.10	11000	2.89	16000	3.79
1100	0.77	6100	2.10	11100	2.91	16100	3.85
1200	0.80	6200	2.11	11200	2.92	16200	3.82
1300	0.84	6300	2.11	11300	2.94	16300	3.83
1400	0.88	6400	2.14	11400	2.95	16400	3.88
1500	0.92	6500	2.15	11500	2.98	16500	3.89
1600	0.95	6600	2.15	11600	3.00	16600	3.92
1700	0.98	6700	2.16	11700	3.02	16700	3.88
1800	1.01	6800	2.19	11800	3.04	16800	3.95
1900	1.04	6900	2.22	11900	3.08	16900	3.91
2000	1.07	7000	2.24	12000	3.09	17000	3.97
2100	1.09	7100	2.26	12100	3.12	17100	3.92
2200	1.13	7200	2.29	12200	3.13	17200	3.94
2300	1.15	7300	2.32	12300	3.16	17300	3.94
2400	1.18	7400	2.36	12400	3.17	17400	3.98
2500	1.21	7500	2.39	12500	3.19	17500	3.93
2600	1.24	7600	2.41	12600	3.20	17600	3.95
2700	1.27	7700	2.43	12700	3.21	17700	3.96
2800	1.30	7800	2.46	12800	3.21	17800	3.97
2900	1.34	7900	2.49	12900	3.22	17900	3.96
3000	1.36	8000	2.52	13000	3.22	18000	3.97
3100	1.38	8100	2.52	13100	3.24		
3200	1.41	8200	2.54	13200	3.24		
3300	1.45	8300	2.59	13300	3.27		
3400	1.46	8400	2.61	13400	3.28		
3500	1.49	8500	2.60	13500	3.31		
3600	1.51	8600	2.63	13600	3.31		
3700	1.55	8700	2.65	13700	3.35		
3800	1.34	8800	2.65	13800	3.37		
3900	1.36	8900	2.65	13900	3.40		
4000	1.38	9000	2.66	14000	3.43		
4100	1.41	9100	2.66	14100	3.45		
4200	1.45	9200	2.67	14200	3.46		
4300	1.46	9300	2.67	14300	3.46		
4400	1.49	9400	2.67	14400	3.49		
4500	1.51	9500	2.68	14500	3.50		
4600	1.55	9600	2.69	14600	3.50		
4700	1.34	9700	2.69	14700	3.52		



Cable loss
Test cable, Mini-Circuits, S/N 0757A, 18 GHz, 4.6 m, N/M - N/M
APC-15FT-NMNM+, HL 4279

Frequency, MHz	Cable loss, dB	Frequency, MHz	Cable loss, dB	Frequency, MHz	Cable loss, dB	Frequency, MHz	Cable loss, dB
10	0.26	5000	4.23	10200	6.47	15400	8.46
30	0.26	5100	4.28	10300	6.53	15500	8.49
50	0.34	5200	4.32	10400	6.57	15600	8.50
100	0.50	5300	4.37	10500	6.59	15700	8.53
200	0.72	5400	4.41	10600	6.62	15800	8.56
300	0.90	5500	4.46	10700	6.64	15900	8.60
400	1.05	5600	4.51	10800	6.66	16000	8.62
500	1.20	5700	4.57	10900	6.69	16100	8.65
600	1.31	5800	4.61	11000	6.69	16200	8.68
700	1.44	5900	4.64	11100	6.70	16300	8.70
800	1.53	6000	4.70	11200	6.72	16400	8.72
900	1.63	6100	4.75	11300	6.74	16500	8.76
1000	1.74	6200	4.76	11400	6.79	16600	8.77
1100	1.83	6300	4.82	11500	6.83	16700	8.78
1200	1.92	6400	4.83	11600	6.85	16800	8.82
1300	2.01	6500	4.88	11700	6.89	16900	8.85
1400	2.09	6600	4.90	11800	6.94	17000	8.91
1500	2.17	6700	4.95	11900	7.00	17100	8.94
1600	2.25	6800	5.01	12000	7.04	17200	8.98
1700	2.33	6900	4.98	12100	7.10	17300	9.03
1800	2.39	7000	5.03	12200	7.18	17400	9.05
1900	2.47	7100	5.11	12300	7.23	17500	9.08
2000	2.53	7200	5.13	12400	7.29	17600	9.10
2100	2.60	7300	5.20	12500	7.34	17700	9.12
2200	2.67	7400	5.28	12600	7.39	17800	9.14
2300	2.74	7500	5.33	12700	7.45	17900	9.17
2400	2.80	7600	5.37	12800	7.49	18000	9.21
2500	2.87	7700	5.44	12900	7.53		
2600	2.92	7800	5.52	13000	7.58		
2700	3.00	7900	5.56	13100	7.62		
2800	3.06	8000	5.63	13200	7.67		
2900	3.12	8100	5.67	13300	7.71		
3000	3.18	8200	5.71	13400	7.74		
3100	3.24	8300	5.76	13500	7.79		
3200	3.30	8400	5.79	13600	7.82		
3300	3.35	8500	5.85	13700	7.84		
3400	3.41	8600	5.88	13800	7.87		
3500	3.46	8700	5.92	13900	7.90		
3600	3.51	8800	5.96	14000	7.94		
3700	3.56	8900	6.02	14100	7.98		
3800	3.61	9000	6.05	14200	8.01		
3900	3.66	9100	6.08	14300	8.05		
4000	3.71	9200	6.15	14400	8.10		
4100	3.77	9300	6.18	14500	8.12		
4200	3.83	9400	6.20	14600	8.16		
4300	3.89	9500	6.25	14700	8.22		
4400	3.94	9600	6.28	14800	8.26		
4500	3.99	9700	6.31	14900	8.29		
4600	4.05	9800	6.35	15000	8.33		
4700	4.09	9900	6.37	15100	8.39		
4800	4.15	10000	6.40	15200	8.41		
4900	4.19	10100	6.45	15300	8.44		



Cable loss
Microwave Cable Assembly, 18.0 GHz, 3.4 m, SMA/SMA, Huber-Suhner, S/N 4295, Sucoflex P103, HL 4295

Frequency, MHz	Cable loss, dB	Frequency, MHz	Cable loss, dB	Frequency, MHz	Cable loss, dB	Frequency, MHz	Cable loss, dB
10	0.11	5000	2.09	10200	2.97	15400	3.63
30	0.18	5100	2.12	10300	3.01	15500	3.65
50	0.23	5200	2.13	10400	3.00	15600	3.63
100	0.31	5300	2.16	10500	3.05	15700	3.64
200	0.38	5400	2.19	10600	3.09	15800	3.64
300	0.43	5500	2.21	10700	3.05	15900	3.66
400	0.52	5600	2.21	10800	3.09	16000	3.71
500	0.60	5700	2.24	10900	3.10	16100	3.67
600	0.67	5800	2.24	11000	3.08	16200	3.71
700	0.72	5900	2.25	11100	3.11	16300	3.70
800	0.78	6000	2.27	11200	3.12	16400	3.71
900	0.83	6100	2.25	11300	3.12	16500	3.72
1000	0.89	6200	2.29	11400	3.20	16600	3.84
1100	0.94	6300	2.34	11500	3.16	16700	3.78
1200	0.98	6400	2.37	11600	3.16	16800	3.85
1300	1.03	6500	2.33	11700	3.20	16900	3.88
1400	1.06	6600	2.34	11800	3.19	17000	3.85
1500	1.11	6700	2.39	11900	3.21	17100	3.88
1600	1.14	6800	2.46	12000	3.28	17200	3.92
1700	1.19	6900	2.45	12100	3.23	17300	3.90
1800	1.22	7000	2.44	12200	3.26	17400	4.00
1900	1.26	7100	2.43	12300	3.30	17500	4.02
2000	1.30	7200	2.44	12400	3.25	17600	4.00
2100	1.34	7300	2.51	12500	3.26	17700	3.96
2200	1.37	7400	2.54	12600	3.30	17800	4.01
2300	1.40	7500	2.49	12700	3.26	17900	4.02
2400	1.44	7600	2.52	12800	3.34	18000	4.08
2500	1.47	7700	2.59	12900	3.37		
2600	1.50	7800	2.57	13000	3.30		
2700	1.55	7900	2.55	13100	3.35		
2800	1.58	8000	2.57	13200	3.31		
2900	1.60	8100	2.58	13300	3.33		
3000	1.63	8200	2.64	13400	3.42		
3100	1.64	8300	2.70	13500	3.43		
3200	1.67	8400	2.65	13600	3.40		
3300	1.69	8500	2.66	13700	3.47		
3400	1.73	8600	2.68	13800	3.45		
3500	1.74	8700	2.70	13900	3.43		
3600	1.76	8800	2.74	14000	3.52		
3700	1.79	8900	2.74	14100	3.51		
3800	1.82	9000	2.76	14200	3.54		
3900	1.85	9100	2.82	14300	3.55		
4000	1.87	9200	2.79	14400	3.52		
4100	1.90	9300	2.82	14500	3.52		
4200	1.92	9400	2.83	14600	3.56		
4300	1.93	9500	2.83	14700	3.55		
4400	1.94	9600	2.86	14800	3.55		
4500	1.97	9700	2.93	14900	3.59		
4600	1.99	9800	2.89	15000	3.56		
4700	2.01	9900	2.91	15100	3.59		
4800	2.02	10000	2.94	15200	3.59		
4900	2.04	10100	2.94	15300	3.59		



Cable loss
Low Loss Armored Test Cable, MegaPhase, 18 GHz, 6.2 m, N type-M/N type-M,
NC29-N1N1-244S/N 12025101 003,
HL 4353

Frequency, MHz	Cable loss, dB	Frequency, MHz	Cable loss, dB
50	0.20	9000	2.71
100	0.27	9500	2.81
300	0.47	10000	2.90
500	0.61	10500	2.97
1000	0.87	11000	3.06
1500	1.07	11500	3.13
2000	1.24	12000	3.20
2500	1.39	12500	3.26
3000	1.53	13000	3.34
3500	1.65	13500	3.39
4000	1.77	14000	3.47
4500	1.89	14500	3.54
5000	1.99	15000	3.62
5500	2.07	15500	3.69
6000	2.20	16000	3.76
6500	2.30	16500	3.83
7000	2.39	17000	3.86
7500	2.51	17500	3.94
8000	2.58	18000	4.02
8500	2.65		



Cable loss
Microwave Cable Assembly, 6.5 GHz, 5.0 m, N/M type-N/M type
Suhner Switzerland, HL 4535

Frequency, MHz	Cable loss, dB	Frequency, MHz	Cable loss, dB	Frequency, MHz	Cable loss, dB
10	0.10	1700	1.79	4400	3.53
15	0.13	1800	1.86	4500	3.60
20	0.15	1900	1.93	4600	3.72
30	0.18	2000	2.00	4700	3.80
40	0.21	2100	2.06	4800	3.87
50	0.24	2200	2.13	4900	3.94
60	0.26	2300	2.19	5000	3.99
70	0.29	2400	2.25	5100	4.06
80	0.31	2500	2.32	5200	4.12
90	0.33	2600	2.38	5300	4.17
100	0.35	2700	2.45	5400	4.25
150	0.43	2800	2.51	5500	4.31
200	0.50	2900	2.57	5600	4.40
300	0.63	3000	2.64	5700	4.47
400	0.74	3100	2.73	5800	4.54
500	0.85	3200	2.79	5900	4.64
600	0.94	3300	2.86	6000	4.73
700	1.03	3400	2.91	6100	4.79
800	1.12	3500	2.97	6200	4.89
900	1.20	3600	3.02	6300	5.00
1000	1.28	3700	3.07	6400	5.06
1100	1.35	3800	3.14	6500	5.13
1200	1.43	3900	3.20		
1300	1.50	4000	3.25		
1400	1.58	4100	3.32		
1500	1.65	4200	3.38		
1600	1.72	4300	3.46		



Cable loss
Microwave Cable Assembly, 4.0 GHz, 1.0 m, N/M type-N/M type
Suhner Switzerland, HL 4541

Frequency, MHz	Cable loss, dB	Frequency, MHz	Cable loss, dB
10	0.02	1700	0.45
15	0.03	1800	0.46
20	0.03	1900	0.48
30	0.04	2000	0.49
40	0.04	2100	0.52
50	0.05	2200	0.54
60	0.06	2300	0.55
70	0.06	2400	0.56
80	0.07	2500	0.58
90	0.07	2600	0.59
100	0.08	2700	0.61
150	0.10	2800	0.63
200	0.12	2900	0.64
300	0.15	3000	0.67
400	0.18	3100	0.70
500	0.20	3200	0.74
600	0.23	3300	0.77
700	0.25	3400	0.80
800	0.28	3500	0.82
900	0.30	3600	0.86
1000	0.31	3700	0.88
1100	0.33	3800	0.94
1200	0.35	3900	0.95
1300	0.37	4000	0.99
1400	0.39		
1500	0.41		
1600	0.43		



14 APPENDIX F Abbreviations and acronyms

A	ampere
AC	alternating current
AM	amplitude modulation
AVRG	average (detector)
cm	centimeter
dB	decibel
dBm	decibel referred to one milliwatt
dB(μ V)	decibel referred to one microvolt
dB(μ V/m)	decibel referred to one microvolt per meter
dB(μ A)	decibel referred to one microampere
DC	direct current
EIRP	equivalent isotropically radiated power
ERP	effective radiated power
EUT	equipment under test
F	frequency
GHz	gigahertz
GND	ground
H	height
HL	Hermon laboratories
Hz	hertz
k	kilo
kHz	kilohertz
LO	local oscillator
m	meter
MHz	megahertz
min	minute
mm	millimeter
ms	millisecond
μ s	microsecond
NA	not applicable
NB	narrow band
OATS	open area test site
Ω	Ohm
PM	pulse modulation
PS	power supply
ppm	part per million (10^{-6})
QP	quasi-peak
RE	radiated emission
RF	radio frequency
rms	root mean square
Rx	receive
s	second
T	temperature
Tx	transmit
V	volt
WB	wideband

END OF DOCUMENT