



Hermon Laboratories Ltd.  
Harakevet Industrial Zone, Binyamina 30500,  
Israel  
Tel. +972-4-6288001  
Fax. +972-4-6288277  
E-mail: mail@hermonlabs.com

# TEST REPORT

ACCORDING TO: FCC CFR 47 Part 15 subpart C, section 15.231

FOR:  
**Visonic Ltd.**  
**Control Panel**  
**Model:PM-360(433) ADT**  
**FCC ID:WP3PM360433**

This report is in conformity with ISO/ IEC 17025. The "A2LA Accredited" symbol endorsement applies only to the tests and calibrations that are listed in the scope of Hermon Laboratories accreditation. The test results relate only to the items tested. This test report shall not be reproduced in any form except in full with the written approval of Hermon Laboratories Ltd.

## Table of contents

1	Applicant information.....	3
2	Equipment under test attributes .....	3
3	Manufacturer information .....	3
4	Test details.....	3
5	Tests summary.....	4
6	EUT description.....	5
6.1	General information.....	5
6.2	Ports and lines .....	5
6.3	Test configuration.....	5
6.4	Changes made in the EUT .....	5
6.5	Transmitter characteristics .....	6
7	Transmitter tests according to 47CFR part 15 subpart C requirements .....	7
7.1	Periodic operation requirements .....	7
7.2	Field strength of emissions.....	11
7.3	Occupied bandwidth test.....	37
7.4	Conducted emissions .....	41
7.5	Antenna requirements .....	44
8	APPENDIX A Test equipment and ancillaries used for tests.....	45
9	APPENDIX B Measurement uncertainties.....	46
10	APPENDIX C Test laboratory description .....	47
11	APPENDIX D Specification references .....	47
12	APPENDIX E Test equipment correction factors.....	48
13	APPENDIX F Abbreviations and acronyms.....	59

## 1 Applicant information

**Client name:** Visonic Ltd.  
**Address:** 24 Habarzel street, Tel Aviv 69710, Israel  
**Telephone:** +972 3645 6832  
**Fax:** +972 3645 6788  
**E-mail:** zurir@tycoint.com  
**Contact name:** Mr. Zuri Rubin

## 2 Equipment under test attributes

**Product name:** Control Panel  
**Product type:** Transceiver  
**Model(s):** PM-360 (433) ADT  
**Serial number:** 1916150170  
**Hardware version:** 90-208059  
**Software release:** JS-702955  
**Receipt date:** 07-Jul-16

## 3 Manufacturer information

**Manufacturer name:** Visonic Ltd.  
**Address:** 24 Habarzel street, Tel Aviv 69710, Israel  
**Telephone:** +972 3645 6832  
**Fax:** +972 3645 6788  
**E-Mail:** zurir@tycoint.com  
**Contact name:** Mr. Zuri Rubin



## 4 Test details

**Project ID:** 28637  
**Location:** Hermon Laboratories Ltd. Harakevet Industrial Zone, Binyamina 30500, Israel  
**Test started:** 07-Jul-16  
**Test completed:** 8-Aug-16  
**Test specification(s):** FCC 47CFR part 15, subpart C, §15.231

## 5 Tests summary

Test	Status
<b>Transmitter characteristics</b>	
Section 15.231(a), Periodic operation requirements	Pass
Section 15.231(b), Field strength of emissions	Pass
Section 15.231(c), Occupied bandwidth	Pass
Section 15.207(a), Conducted emission	Pass
Section 15.203, Antenna requirement	Pass

Testing was completed against all relevant requirements of the test standard. The results obtained indicate that the product under test complies in full with the requirements tested.  
The test results relate only to the items tested. Pass/ fail decision was based on nominal values.

	Name and Title	Date	Signature
<b>Tested by:</b>	Mr. S. Samokha, test engineer	August 8, 2016	
<b>Reviewed by:</b>	Mrs. M. Cherniavsky, certification engineer	August 9, 2016	
<b>Approved by:</b>	Mr. M. Nikishin, EMC and radio group manager	August 18, 2016	

## 6 EUT description

### 6.1 General information

The EUT, Control panel PM-360 (433) ADT is wireless control panel powered via external AC/DC adaptor. The panel comprises four Visonic RF boards with below radio modules:

1. PG-2 module- communication within the alarm system in 433 MHz band
2. WiFi module with Visonic antenna, connected to RF PCB
  - a. 802.11b
  - b. 802.11g
  - c. 802.11n
3. Z-wave module with Visonic antenna connected to RF board
4. Cellular module UE910NAR modular approved with FCC ID:R17UE910NA, IC: 5131A-UE910NA used for 3G/2G modes with Visonic antenna connected to RF board.

All radios could operate simultaneously.

The present test report involves the test results for certification of 433 MHz transmitter as a part of a composite application for certification.

### 6.2 Ports and lines

Port type	Port description	Connected from	Connected to	Qty.	Cable type	Cable length, m
Power	AC power	AC mains	AC/DC adaptor	1	Unshielded	2.0

### 6.3 Test configuration

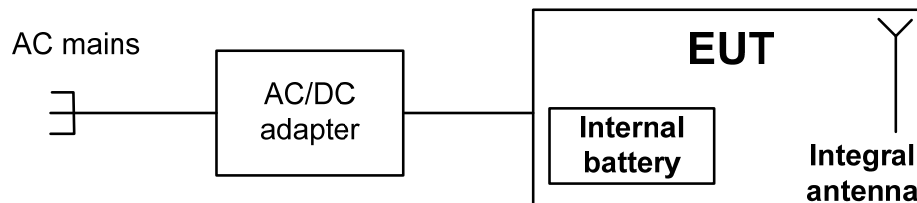

### 6.4 Changes made in the EUT

No changes were implemented in the EUT during the testing.



### 6.5 Transmitter characteristics

<b>Type of equipment</b>						
X	Stand-alone (Equipment with or without its own control provisions)					
	Combined equipment (Equipment where the radio part is fully integrated within another type of equipment)					
	Plug-in card (Equipment intended for a variety of host systems)					
<b>Intended use</b>		<b>Condition of use</b>				
	fixed	Always at a distance more than 2 m from all people				
X	mobile	Always at a distance more than 20 cm from all people				
	portable	May operate at a distance closer than 20 cm to human body				
<b>Assigned frequency ranges</b>		433.05 – 434.79 MHz				
<b>Operating frequencies</b>		433.22 – 434.62 MHz				
<b>Maximum rated output power</b>		At transmitter 50 Ω RF output connector		dBm		
		Field strength at 3 m distance		100.49 dB(μV/m) -peak 73.16 dB(μV/m)-average		
<b>Is transmitter output power variable?</b>		X	No			
			Yes			
			continuous variable			
			stepped variable with stepsize			
		minimum RF power		dBm		
		maximum RF power		dBm		
<b>Antenna connection</b>						
unique coupling		standard connector		X	integral	
				X	with temporary RF connector	
				X	without temporary RF connector	
<b>Antenna/s technical characteristics</b>						
Type	Manufacturer		Model number		Gain	
Integral	Visonic		Built-in wire antenna		-8 dBi	
<b>Transmitter aggregate data rate/s</b>			50 kbps			
<b>Type of modulation</b>			GFSK			
<b>Modulating test signal (baseband)</b>			PRBS			
<b>Transmitter power source</b>						
	Battery	<b>Nominal rated voltage</b>		Battery type	Lithium	
	DC	<b>Nominal rated voltage</b>				
X	AC mains	<b>Nominal rated voltage</b>		120 VAC	Frequency	
<b>Common power source for transmitter and receiver</b>				X	yes	
					no	



<b>Test specification: Section 15.231(a), Periodic operation requirements</b>			
<b>Test procedure:</b> Supplier declaration			
<b>Test mode:</b> Compliance		<b>Verdict:</b> PASS	
<b>Date(s):</b> 24-Jul-16			
<b>Temperature:</b> 23.7 °C	<b>Relative Humidity:</b> 48 %	<b>Air Pressure:</b> 1005 hPa	<b>Power:</b> 120 VAC
<b>Remarks:</b>			

## 7 Transmitter tests according to 47CFR part 15 subpart C requirements

### 7.1 Periodic operation requirements

#### 7.1.1 General

The EUT was verified for compliance with periodic operation requirements listed below:

- Continuous transmissions such as voice, video and the radio control of toys are not permitted;
- A manually operated transmitter shall employ switch that will automatically deactivate the transmitter within not more than 5 seconds of being released;
- A transmitter activated automatically shall cease transmission within 5 seconds after activation;
- Periodic transmissions, excluding polling or supervision transmissions, at regular predetermined intervals are not permitted;
- Total duration of polling or supervision transmissions, including data, to determine system integrity in security or safety applications shall not exceed 2 seconds per hour;
- Transmission of set-up information for security systems may exceed the transmission duration limits of 5 seconds, provided such transmissions are under the control of a professional installer and do not exceed ten seconds after a manually operated switch is released or a transmitter is activated automatically. Such set-up information may include data.

The rationale for compliance with the above requirements was either test results or supplier declaration. The summary of results is provided in Table 7.1.1.

#### 7.1.2 Test procedure for transmitter shut down test

7.1.2.1 The EUT was set up as shown in Figure 7.1.1.

7.1.2.2 The spectrum analyzer center frequency was adjusted to the EUT carrier, span set to zero and video triggered for transmission.

7.1.2.3 The transmitter was activated either manually or automatically. Once manually operated transmitter was activated, the switch was immediately released.

7.1.2.4 The transmission time was captured and shown in Plot 7.1.1.

#### 7.1.3 Test procedure for measurements of polling / supervision transmission duration

7.1.3.1 The EUT was set up as shown in Figure 7.1.1.

7.1.3.2 The spectrum analyzer center frequency was adjusted to the EUT carrier, span set to zero and video triggered for transmission.

7.1.3.3 The transmission time was captured and shown in Plot 7.1.2.

Figure 7.1.1 Setup for transmitter shut down test





<b>Test specification: Section 15.231(a), Periodic operation requirements</b>			
<b>Test procedure:</b> Supplier declaration			
<b>Test mode:</b> Compliance		<b>Verdict: PASS</b>	
<b>Date(s):</b> 24-Jul-16			
<b>Temperature:</b> 23.7 °C	<b>Relative Humidity:</b> 48 %	<b>Air Pressure:</b> 1005 hPa	<b>Power:</b> 120 VAC
<b>Remarks:</b>			

Table 7.1.1 Periodic operation requirements

Requirement	Rationale	Verdict
Continuous transmissions are not permitted	Supplier declaration	Comply
A manually operated transmitter shall be deactivated within not more than 5 seconds of switch being released	NA	NA
Transmitter activated automatically shall cease transmission within 5 seconds	Plot 7.1.1	Comply
Periodic transmissions at regular predetermined intervals are not permitted	Supplier declaration	Comply
Total duration of polling or supervision transmissions shall not exceed 2 seconds per hour	Plot 7.1.2	Comply
Transmission of set-up information for security systems may exceed the transmission duration limits of 5 seconds, provided such transmissions are under the control of a professional installer and do not exceed ten seconds after a manually operated switch is released or a transmitter is activated automatically. Such set-up information may include data.	NA	NA





<b>Test specification:</b> Section 15.231(a), Periodic operation requirements			
<b>Test procedure:</b> Supplier declaration			
<b>Test mode:</b> Compliance		<b>Verdict:</b> PASS	
<b>Date(s):</b> 24-Jul-16			
<b>Temperature:</b> 23.7 °C	<b>Relative Humidity:</b> 48 %	<b>Air Pressure:</b> 1005 hPa	<b>Power:</b> 120 VAC
<b>Remarks:</b>			

Plot 7.1.1 Transmitter shut down test result

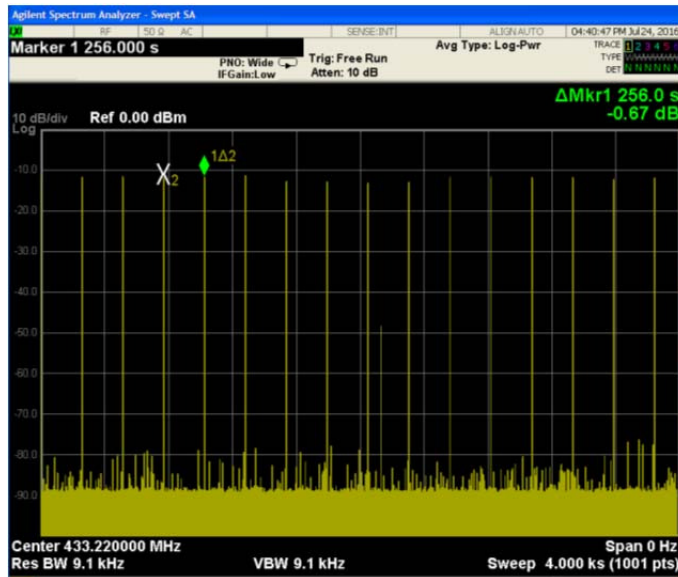

Plot 7.1.2 Polling / supervision transmission duration

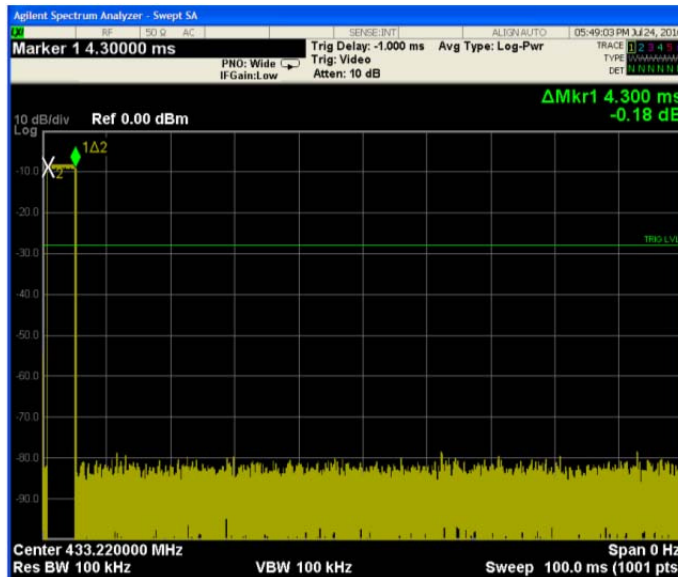



<b>Test specification:</b> Section 15.231(a), Periodic operation requirements			
<b>Test procedure:</b> Supplier declaration			
<b>Test mode:</b> Compliance		<b>Verdict:</b> PASS	
<b>Date(s):</b> 24-Jul-16			
<b>Temperature:</b> 23.7 °C	<b>Relative Humidity:</b> 48 %	<b>Air Pressure:</b> 1005 hPa	<b>Power:</b> 120 VAC
<b>Remarks:</b>			

Table 7.1.2 Total duration of polling / supervision transmissions

Duration, ms	Repetition period, s	Maximum number of transmissions within 1 hour	Total duration within 1 hour, ms
4.3	256	15	64.5

Reference numbers of test equipment used

HL 2909	HL 3830	HL 4274					
---------	---------	---------	--	--	--	--	--

Full description is given in Appendix A.



<b>Test specification: Section 15.231(b), Field strength of emissions</b>			
<b>Test procedure:</b> ANSI C63.10 sections 6.5, 6.6			
<b>Test mode:</b> Compliance		<b>Verdict:</b> PASS	
<b>Date(s):</b> 07-Jul-16 - 24-Aug-16			
<b>Temperature:</b> 24.5 °C	<b>Relative Humidity:</b> 48 %	<b>Air Pressure:</b> 1005 hPa	<b>Power:</b> 120 VAC
<b>Remarks:</b>			

## 7.2 Field strength of emissions

### 7.2.1 General

This test was performed to measure field strength of fundamental and spurious emissions from the EUT. Specification test limits are given in Table 7.2.1 and Table 7.2.2.

Table 7.2.1 Radiated fundamental emission limits

Fundamental frequency, MHz	Field strength at 3 m, dB(μV/m)	
	Peak	Average
433.05 – 434.79	100.8	80.8

Table 7.2.2 Radiated spurious emissions limits

Frequency, MHz	Field strength at 3 m, dB(μV/m)				
	Within restricted bands			Outside restricted bands	
	Peak	Quasi Peak	Average	Peak	Average
0.009 – 0.090	148.5 – 128.5	NA	128.5 – 108.5**	80.8	60.8
0.090 – 0.110	NA	108.5 – 106.8**	NA		
0.110 – 0.490	126.8 – 113.8	NA	106.8 – 93.8**		
0.490 – 1.705	NA	73.8 – 63.0**	NA		
1.705 – 30.0*		69.5			
30 – 88		40.0			
88 – 216		43.5			
216 – 960		46.0			
960 - 1000		54.0			
Above 1000	74.0	NA	54.0		

\*- The limit for 3 m test distance was calculated using the inverse square distance extrapolation factor as follows:

$$Lim_{S_2} = Lim_{S_1} + 40 \log(S_1/S_2),$$

where  $S_1$  and  $S_2$  – standard defined and test distance respectively in meters.

\*\*- The limit decreases linearly with the logarithm of frequency.

Note 1: The fundamental emission limit in dB(μV/m) was calculated as follows:

$$Lim_{AVR} = 20 \times \log(56.81818 \times F - 6136.3636) \text{ - within } 130 - 174 \text{ MHz band;}$$

$$Lim_{AVR} = 20 \times \log(41.6667 \times F - 7083.3333) \text{ - within } 260 - 470 \text{ MHz band,}$$

where F is the carrier frequency in MHz.

The limit for spurious emissions was 20 dB lower than fundamental emission limit.

The above limits provided in terms of average values, peak limit was 20 dB above the average limit.

Note 2: The above field strength limits applied from the lowest radio frequency generated in the device, without going below 9 kHz up to the tenth harmonic of the highest fundamental frequency.



<b>Test specification: Section 15.231(b), Field strength of emissions</b>			
<b>Test procedure:</b> ANSI C63.10 sections 6.5, 6.6			
<b>Test mode:</b> Compliance		<b>Verdict:</b> PASS	
<b>Date(s):</b> 07-Jul-16 - 24-Aug-16			
<b>Temperature:</b> 24.5 °C	<b>Relative Humidity:</b> 48 %	<b>Air Pressure:</b> 1005 hPa	<b>Power:</b> 120 VAC
<b>Remarks:</b>			

**7.2.2 Test procedure for spurious emission field strength measurements in 9 kHz to 30 MHz band**

7.2.2.1 The EUT was set up as shown in Figure 7.2.1, energized and the performance check was conducted.

7.2.2.2 The measurements were performed in EUT Typical (Vertical) position.

7.2.2.3 The specified frequency range was investigated with antenna connected to spectrum analyzer/ EMI receiver. To find maximum radiation the turntable was rotated 360° and the measuring antenna was rotated around its vertical axis.

7.2.2.4 The worst test results (the lowest margins) were recorded in Table 7.2.3, Table 7.2.5 and shown in the associated plots.

**7.2.3 Test procedure for spurious emission field strength measurements above 30 MHz**

7.2.3.1 The EUT was set up as shown in Figure 7.2.2, energized and the performance check was conducted.

7.2.3.2 The measurements were performed in EUT Typical (Vertical) position.

7.2.3.3 The specified frequency range was investigated with antenna connected to spectrum analyzer/ EMI receiver. To find maximum radiation the turntable was rotated 360°, the measuring antenna height was changed from 1 to 4 m, its polarization was switched from vertical to horizontal.

7.2.3.4 The worst test results (the lowest margins) were recorded in Table 7.2.3, Table 7.2.5 and shown in the associated plots.

**Figure 7.2.1 Setup for spurious emission field strength measurements below 30 MHz**

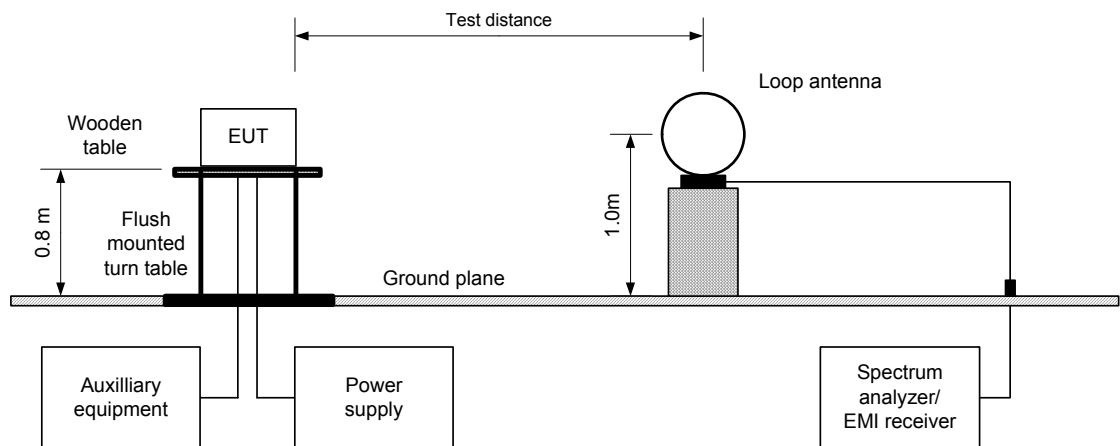



<b>Test specification: Section 15.231(b), Field strength of emissions</b>			
<b>Test procedure:</b> ANSI C63.10 sections 6.5, 6.6			
<b>Test mode:</b> Compliance		<b>Verdict:</b> PASS	
<b>Date(s):</b> 07-Jul-16 - 24-Aug-16			
<b>Temperature:</b> 24.5 °C	<b>Relative Humidity:</b> 48 %	<b>Air Pressure:</b> 1005 hPa	<b>Power:</b> 120 VAC
<b>Remarks:</b>			

Figure 7.2.2 Setup for spurious emission field strength measurements above 30 MHz

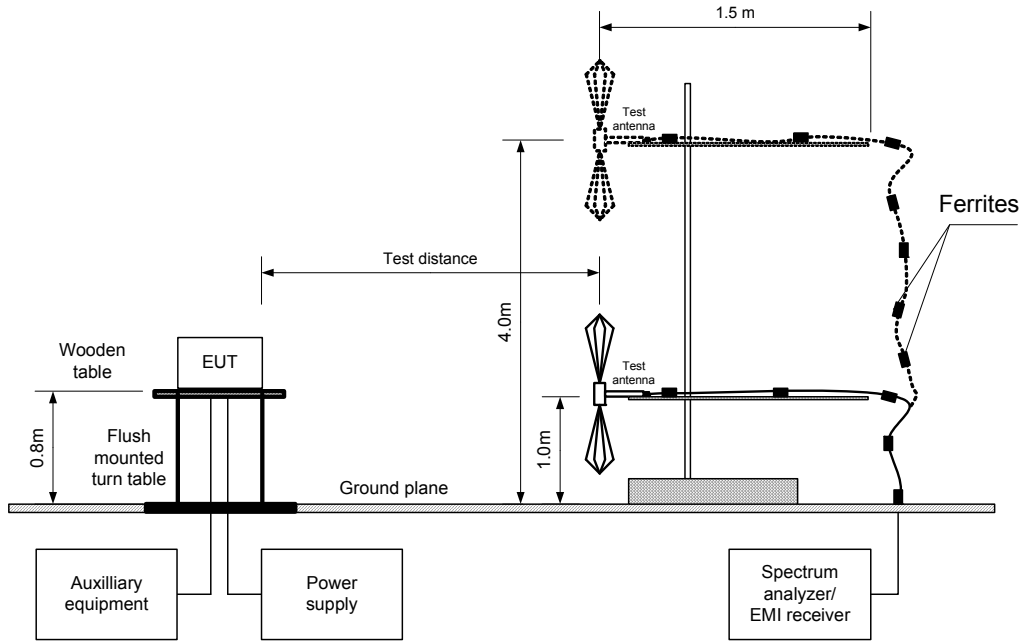



<b>Test specification: Section 15.231(b), Field strength of emissions</b>			
<b>Test procedure:</b> ANSI C63.10 sections 6.5, 6.6			
<b>Test mode:</b> Compliance		<b>Verdict: PASS</b>	
<b>Date(s):</b> 07-Jul-16 - 24-Aug-16			
<b>Temperature:</b> 24.5 °C	<b>Relative Humidity:</b> 48 %	<b>Air Pressure:</b> 1005 hPa	<b>Power:</b> 120 VAC
<b>Remarks:</b>			

**Table 7.2.3 Field strength of fundamental emission, spurious emissions outside restricted bands and within restricted bands at frequencies above 1 GHz**

TEST DISTANCE: 3 m  
 EUT POSITION: Typical (Vertical)  
 MODULATION: GFSK  
 BIT RATE: 50 kbps  
 TRANSMITTER OUTPUT POWER SETTINGS: Maximum  
 INVESTIGATED FREQUENCY RANGE: 0.009 - 4500 MHz  
 DETECTOR USED: Peak  
 RESOLUTION BANDWIDTH: 1.0 kHz (9 kHz – 150 kHz)  
 9.0 kHz (150 kHz – 30 MHz)  
 120 kHz (30 MHz – 1000 MHz)  
 1.0 MHz (above 1000 MHz)  
 VIDEO BANDWIDTH: ≥ Resolution bandwidth  
 TEST ANTENNA TYPE: Active loop (9 kHz – 30 MHz)  
 Double ridged guide (above 1000 MHz)

F, MHz	Antenna		Azimuth, degrees*	Peak field strength			Average field strength				Verdict
	Pol.	Height, m		Measured, dB(μV/m)	Limit, dB(μV/m)	Margin, dB**	Measured, dB(μV/m)	Calculated, dB(μV/m)	Limit, dB(μV/m)	Margin, dB**	
<b>Fundamental emission***</b>											
433.198	Vert	1.1	150	100.24	100.8	-0.56	100.24	72.91	80.8	-7.89	Pass
433.795	Vert	1.1	150	99.88	100.8	-0.92	99.88	72.55	80.8	-8.25	Pass
434.595	Vert	1.1	150	100.49	100.8	-0.31	100.49	73.16	80.8	-7.64	Pass
<b>Spurious emissions</b>											
<b>Low carrier frequency</b>											
866.393	Vert	1.0	350	42.11	80.8	-38.69	42.11	14.78	60.8	-46.02	Pass
2165.963	Hor	1.1	50	43.95	80.8	-36.85	43.95	16.62	60.8	-44.18	
3899.330	Hor	1.5	350	44.90	74.0	-29.10	44.90	17.57	54.0	-36.43	
<b>Mid carrier frequency</b>											
867.588	Vert	1.2	340	41.58	80.8	-39.22	41.58	14.25	60.8	-46.55	Pass
2169.000	Vert	1.0	350	49.37	80.8	-31.43	49.37	22.04	60.8	-38.76	
3904.255	Hor	1.5	350	45.43	74.0	-28.57	45.43	18.1	54.0	-35.90	
<b>High carrier frequency</b>											
869.288	Vert	1.0	150	44.01	80.8	-36.79	44.01	16.68	60.8	-44.12	Pass
2172.950	Vert	1.0	350	49.75	80.8	-31.05	49.75	22.42	60.8	-38.38	
3477.160	Hor	1.5	350	41.99	80.8	-38.81	41.99	14.66	60.8	-46.14	
3911.205	Hor	1.5	350	42.59	74.0	-31.41	42.59	15.26	54.0	-38.74	

\*- EUT front panel refers to 0 degrees position of turntable.

\*\* - Margin, dB = Measured (calculated) value, dB(μV/m) - Limit, dB(μV/m)

\*\*\* Max value was obtained in X-axis orthogonal position (typical, vertical) and at Unom input power voltage.



<b>Test specification: Section 15.231(b), Field strength of emissions</b>			
<b>Test procedure:</b> ANSI C63.10 sections 6.5, 6.6			
<b>Test mode:</b> Compliance		<b>Verdict: PASS</b>	
<b>Date(s):</b> 07-Jul-16 - 24-Aug-16			
<b>Temperature:</b> 24.5 °C	<b>Relative Humidity:</b> 48 %	<b>Air Pressure:</b> 1005 hPa	<b>Power:</b> 120 VAC
<b>Remarks:</b>			

Table 7.2.4 Average factor calculation

Transmission pulse		Transmission burst		Transmission train duration, ms	Average factor, dB
Duration, ms	Period, ms	Duration, ms	Period, ms		
4.3	100	NA	NA	NA	-27.33

\*- Average factor was calculated as follows

for pulse train shorter than 100 ms:

$$Average\ factor = 20 \times \log_{10} \left( \frac{Pulse\ duration}{Pulse\ period} \times \frac{Burst\ duration}{Train\ duration} \times Number\ of\ bursts\ within\ pulse\ train \right)$$

for pulse train longer than 100 ms:

$$Average\ factor = 20 \times \log_{10} \left( \frac{Pulse\ duration}{Pulse\ period} \times \frac{Burst\ duration}{100\ ms} \times Number\ of\ bursts\ within\ 100\ ms \right)$$

**Reference numbers of test equipment used**

HL 0415	HL 0446	HL 0521	HL 0604	HL 1984	HL 2909	HL 3901	HL 4114
HL 4279	HL 4294	HL 4353	HL 4932				

Full description is given in Appendix A.



<b>Test specification: Section 15.231(b), Field strength of emissions</b>			
<b>Test procedure:</b> ANSI C63.10 sections 6.5, 6.6			
<b>Test mode:</b> Compliance		<b>Verdict: PASS</b>	
<b>Date(s):</b> 07-Jul-16 - 24-Aug-16			
<b>Temperature:</b> 24.5 °C	<b>Relative Humidity:</b> 48 %	<b>Air Pressure:</b> 1005 hPa	<b>Power:</b> 120 VAC
<b>Remarks:</b>			

**Table 7.2.5 Field strength of emissions below 1 GHz within restricted bands**

TEST DISTANCE: 3 m  
 EUT POSITION: Typical (Vertical)  
 MODULATION: GFSK  
 MODULATING SIGNAL: ID code  
 BIT RATE: 50 kbps  
 TRANSMITTER OUTPUT POWER SETTINGS: Maximum  
 INVESTIGATED FREQUENCY RANGE: 0.009 – 1000 MHz  
 DETECTOR USED: Peak  
 RESOLUTION BANDWIDTH: 1.0 kHz (9 kHz – 150 kHz)  
 9.0 kHz (150 kHz – 30 MHz)  
 120 kHz (30 MHz – 1000 MHz)  
 VIDEO BANDWIDTH: ≥ Resolution bandwidth  
 TEST ANTENNA TYPE: Active loop (9 kHz – 30 MHz)  
 Biconical (30 MHz – 200 MHz)  
 Log periodic (200 MHz – 1000 MHz)  
 Biconilog (30 MHz – 1000 MHz)

Frequency, MHz	Peak emission, dB(µV/m)	Quasi-peak			Antenna polarization	Antenna height, m	Turn-table position**, degrees	Verdict
		Measured emission, dB(µV/m)	Limit, dB(µV/m)	Margin, dB*				
<b>Low carrier frequency</b>								
No emissions were found								Pass
<b>Low carrier frequency</b>								
No emissions were found								Pass
<b>Low carrier frequency</b>								
No emissions were found								Pass

\*- Margin = Measured emission - specification limit.  
 \*\*- EUT front panel refer to 0 degrees position of turntable.

**Reference numbers of test equipment used**

HL 0446	HL 0521	HL 0604	HL 4279	HL 4353			
---------	---------	---------	---------	---------	--	--	--

Full description is given in Appendix A.

**Table 7.2.6 Restricted bands**

MHz	MHz	MHz	MHz	MHz	GHz
0.09 - 0.11	8.37625 - 8.38675	73 - 74.6	399.9 - 410	2690 - 2900	10.6 - 12.7
0.495 - 0.505	8.41425 - 8.41475	74.8 - 75.2	608 - 614	3260 - 3267	13.25 - 13.4
2.1735 - 2.1905	12.29 - 12.293	108 - 121.94	960 - 1240	3332 - 3339	14.47 - 14.5
4.125 - 4.128	12.51975 - 12.52025	123 - 138	1300 - 1427	3345.8 - 3358	15.35 - 16.2
4.17725 - 4.17775	12.57675 - 12.57725	149.9 - 150.05	1435 - 1626.5	3600 - 4400	17.7 - 21.4
4.20725 - 4.20775	13.36 - 13.41	156.52475 - 156.52525	1645.5 - 1646.5	4500 - 5150	22.01 - 23.12
6.215 - 6.218	16.42 - 16.423	156.7 - 156.9	1660 - 1710	5350 - 5460	23.6 - 24
6.26775 - 6.26825	16.69475 - 16.69525	162.0125 - 167.17	1718.8 - 1722.2	7250 - 7750	31.2 - 31.8
6.31175 - 6.31225	16.80425 - 16.80475	167.72 - 173.2	2200 - 2300	8025 - 8500	36.43 - 36.5
8.291 - 8.294	25.5 - 25.67	240 - 285	2310 - 2390	9000 - 9200	Above 38.6
8.362 - 8.366	37.5 - 38.25	322 - 335.4	2483.5 - 2500	9300 - 9500	





HERMON LABORATORIES

<b>Test specification: Section 15.231(b), Field strength of emissions</b>			
<b>Test procedure:</b> ANSI C63.10 sections 6.5, 6.6			
<b>Test mode:</b> Compliance		<b>Verdict:</b> PASS	
<b>Date(s):</b> 07-Jul-16 - 24-Aug-16			
<b>Temperature:</b> 24.5 °C	<b>Relative Humidity:</b> 48 %	<b>Air Pressure:</b> 1005 hPa	<b>Power:</b> 120 VAC
<b>Remarks:</b>			

**Plot 7.2.1 Radiated emission measurements at the low frequency**

TEST SITE: Semi anechoic chamber  
TEST DISTANCE: 3 m  
ANTENNA POLARIZATION: Vertical  
EUT POSITION: Typical (Vertical/)  
INPUT VOLTAGE: Unom

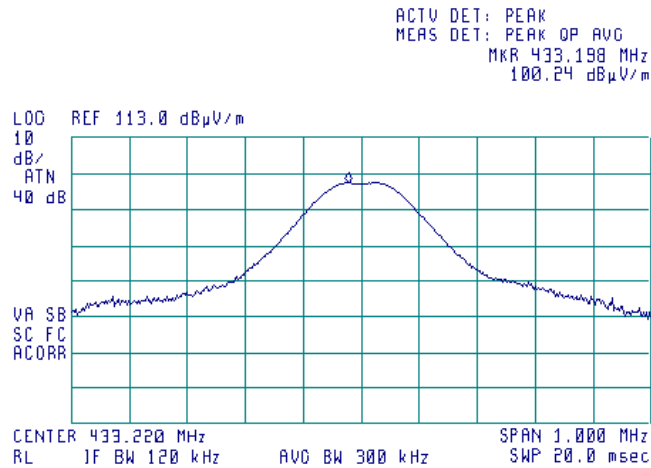

**Plot 7.2.2 Radiated emission measurements at the low frequency**

TEST SITE: Semi anechoic chamber  
TEST DISTANCE: 3 m  
ANTENNA POLARIZATION: Horizontal  
EUT POSITION: Typical (Vertical/)  
INPUT VOLTAGE: Unom

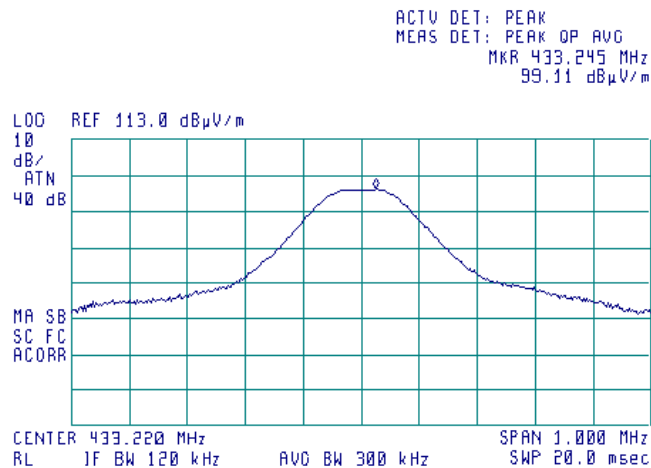



HERMON LABORATORIES

<b>Test specification: Section 15.231(b), Field strength of emissions</b>			
<b>Test procedure:</b> ANSI C63.10 sections 6.5, 6.6			
<b>Test mode:</b> Compliance		<b>Verdict:</b> PASS	
<b>Date(s):</b> 07-Jul-16 - 24-Aug-16			
<b>Temperature:</b> 24.5 °C	<b>Relative Humidity:</b> 48 %	<b>Air Pressure:</b> 1005 hPa	<b>Power:</b> 120 VAC
<b>Remarks:</b>			

**Plot 7.2.3 Radiated emission measurements at the low frequency**

TEST SITE: Semi anechoic chamber  
TEST DISTANCE: 3 m  
ANTENNA POLARIZATION: Vertical  
EUT POSITION: Typical (Vertical/)  
INPUT VOLTAGE: 115%Unom

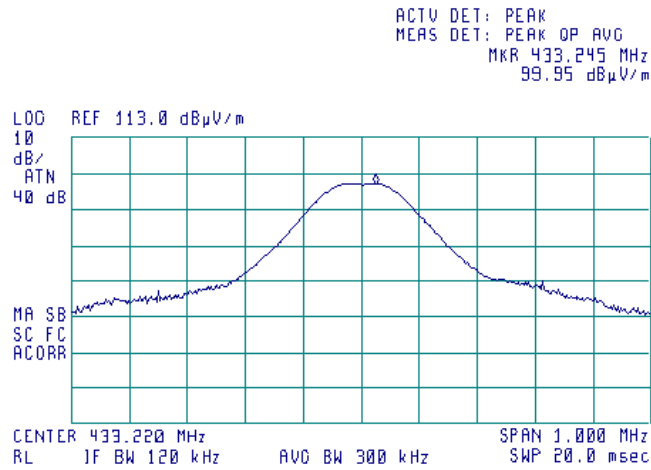

**Plot 7.2.4 Radiated emission measurements at the low frequency**

TEST SITE: Semi anechoic chamber  
TEST DISTANCE: 3 m  
ANTENNA POLARIZATION: Horizontal  
EUT POSITION: Typical (Vertical/)  
INPUT VOLTAGE: 115%Unom

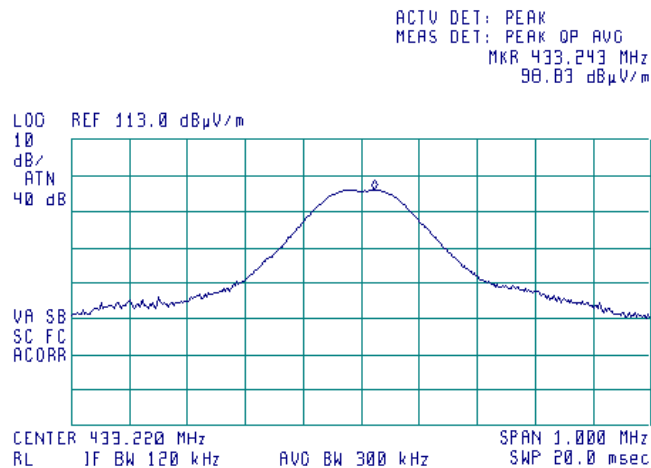



HERMON LABORATORIES

<b>Test specification: Section 15.231(b), Field strength of emissions</b>			
<b>Test procedure:</b> ANSI C63.10 sections 6.5, 6.6			
<b>Test mode:</b> Compliance		<b>Verdict:</b> PASS	
<b>Date(s):</b> 07-Jul-16 - 24-Aug-16			
<b>Temperature:</b> 24.5 °C	<b>Relative Humidity:</b> 48 %	<b>Air Pressure:</b> 1005 hPa	<b>Power:</b> 120 VAC
<b>Remarks:</b>			

**Plot 7.2.5 Radiated emission measurements at the low frequency**

TEST SITE: Semi anechoic chamber  
TEST DISTANCE: 3 m  
ANTENNA POLARIZATION: Vertical  
EUT POSITION: Typical (Vertical/)  
INPUT VOLTAGE: 85%Unom

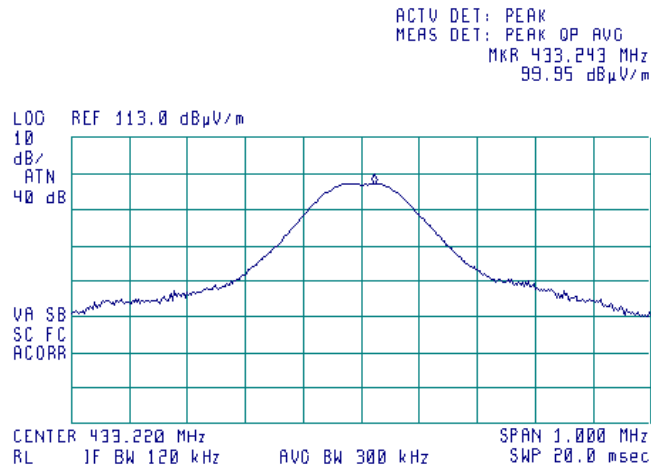

**Plot 7.2.6 Radiated emission measurements at the low frequency**

TEST SITE: Semi anechoic chamber  
TEST DISTANCE: 3 m  
ANTENNA POLARIZATION: Horizontal  
EUT POSITION: Typical (Vertical/)  
INPUT VOLTAGE: 85%Unom

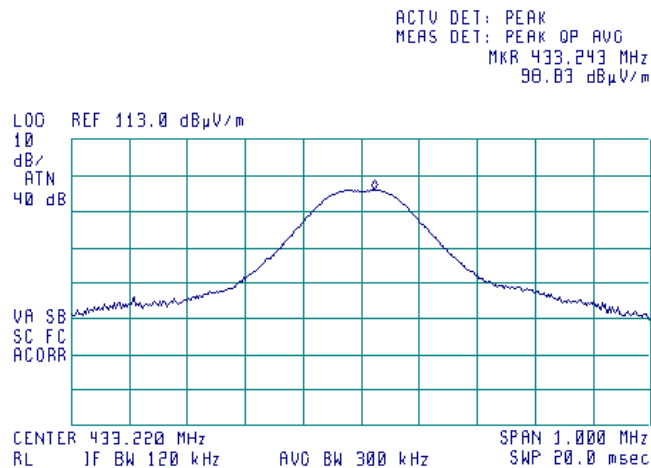



HERMON LABORATORIES

<b>Test specification: Section 15.231(b), Field strength of emissions</b>			
<b>Test procedure:</b> ANSI C63.10 sections 6.5, 6.6			
<b>Test mode:</b> Compliance		<b>Verdict:</b> PASS	
<b>Date(s):</b> 07-Jul-16 - 24-Aug-16			
<b>Temperature:</b> 24.5 °C	<b>Relative Humidity:</b> 48 %	<b>Air Pressure:</b> 1005 hPa	<b>Power:</b> 120 VAC
<b>Remarks:</b>			

**Plot 7.2.7 Radiated emission measurements at the mid frequency**

TEST SITE: Semi anechoic chamber  
 TEST DISTANCE: 3 m  
 ANTENNA POLARIZATION: Vertical  
 EUT POSITION: Typical (Vertical/)  
 INPUT VOLTAGE: Unom

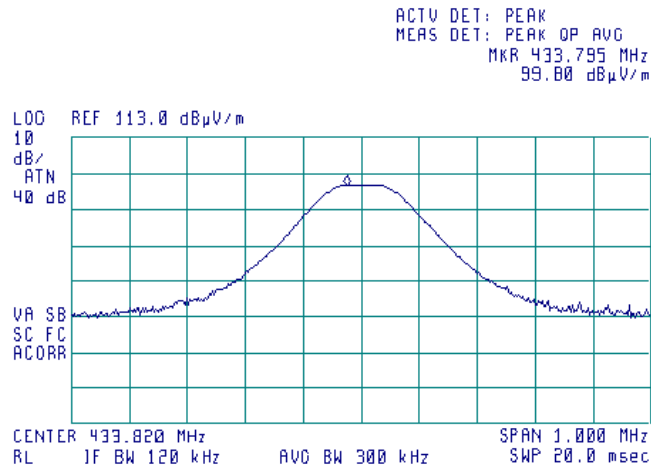

**Plot 7.2.8 Radiated emission measurements at the mid frequency**

TEST SITE: Semi anechoic chamber  
 TEST DISTANCE: 3 m  
 ANTENNA POLARIZATION: Horizontal  
 EUT POSITION: Typical (Vertical/)  
 INPUT VOLTAGE: Unom

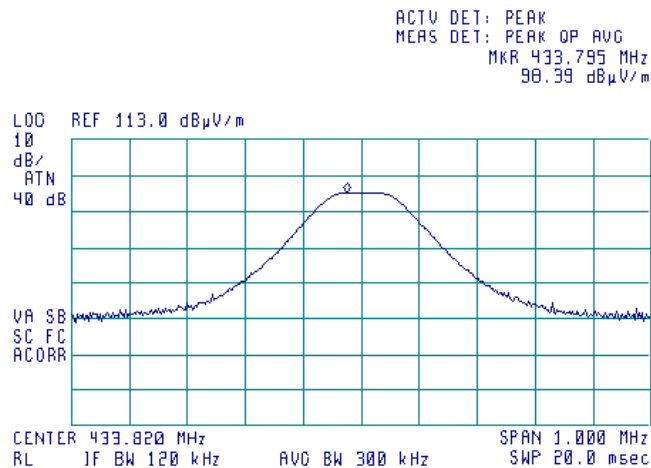



HERMON LABORATORIES

<b>Test specification: Section 15.231(b), Field strength of emissions</b>			
<b>Test procedure:</b> ANSI C63.10 sections 6.5, 6.6			
<b>Test mode:</b> Compliance		<b>Verdict:</b> PASS	
<b>Date(s):</b> 07-Jul-16 - 24-Aug-16			
<b>Temperature:</b> 24.5 °C	<b>Relative Humidity:</b> 48 %	<b>Air Pressure:</b> 1005 hPa	<b>Power:</b> 120 VAC
<b>Remarks:</b>			

**Plot 7.2.9 Radiated emission measurements at the high frequency**

TEST SITE: Semi anechoic chamber  
TEST DISTANCE: 3 m  
ANTENNA POLARIZATION: Vertical  
EUT POSITION: Typical (Vertical/)  
INPUT VOLTAGE: Unom

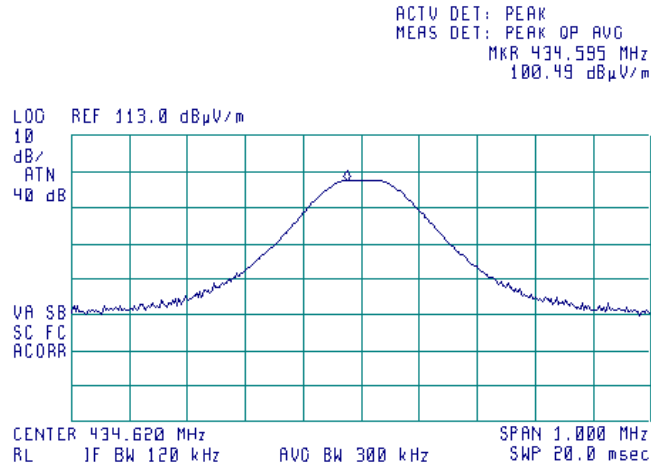

**Plot 7.2.10 Radiated emission measurements at the high frequency**

TEST SITE: Semi anechoic chamber  
TEST DISTANCE: 3 m  
ANTENNA POLARIZATION: Horizontal  
EUT POSITION: Typical (Vertical/)  
INPUT VOLTAGE: Unom

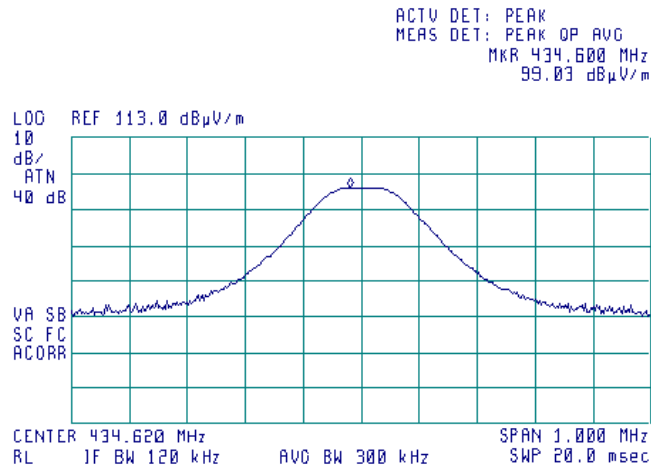



HERMON LABORATORIES

<b>Test specification: Section 15.231(b), Field strength of emissions</b>			
<b>Test procedure:</b> ANSI C63.10 sections 6.5, 6.6			
<b>Test mode:</b> Compliance		<b>Verdict: PASS</b>	
<b>Date(s):</b> 07-Jul-16 - 24-Aug-16			
<b>Temperature:</b> 24.5 °C	<b>Relative Humidity:</b> 48 %	<b>Air Pressure:</b> 1005 hPa	<b>Power:</b> 120 VAC
<b>Remarks:</b>			

**Plot 7.2.11 Radiated emission measurements from 9 to 150 kHz**

TEST SITE: Semi anechoic chamber  
TEST DISTANCE: 3 m  
ANTENNA POLARIZATION: Vertical  
EUT POSITION: Typical (Vertical/)

Low frequency 433.22 MHz

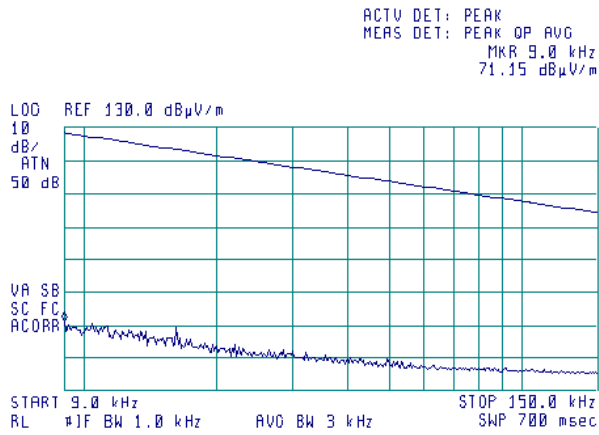

Mid frequency 433.82 MHz

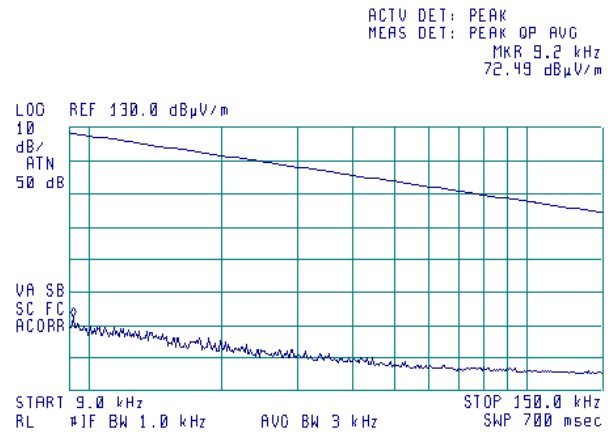

High frequency 434.62 MHz

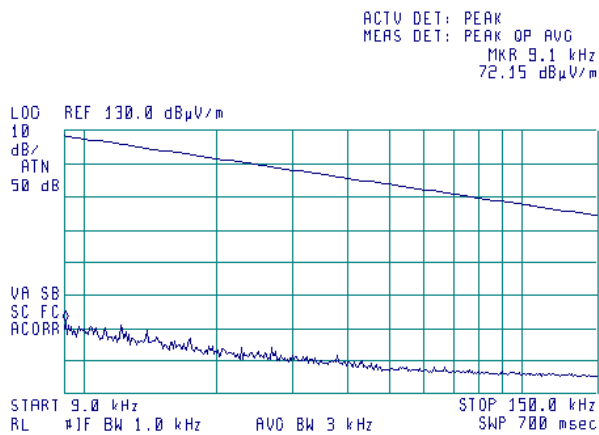



HERMON LABORATORIES

<b>Test specification: Section 15.231(b), Field strength of emissions</b>			
<b>Test procedure:</b> ANSI C63.10 sections 6.5, 6.6			
<b>Test mode:</b> Compliance		<b>Verdict: PASS</b>	
<b>Date(s):</b> 07-Jul-16 - 24-Aug-16			
<b>Temperature:</b> 24.5 °C	<b>Relative Humidity:</b> 48 %	<b>Air Pressure:</b> 1005 hPa	<b>Power:</b> 120 VAC
<b>Remarks:</b>			

**Plot 7.2.12 Radiated emission measurements from 0.15 to 30 MHz**

TEST SITE: Semi anechoic chamber  
 TEST DISTANCE: 3 m  
 ANTENNA POLARIZATION: Vertical  
 EUT POSITION: Typical (Vertical/)

Low frequency 433.22 MHz

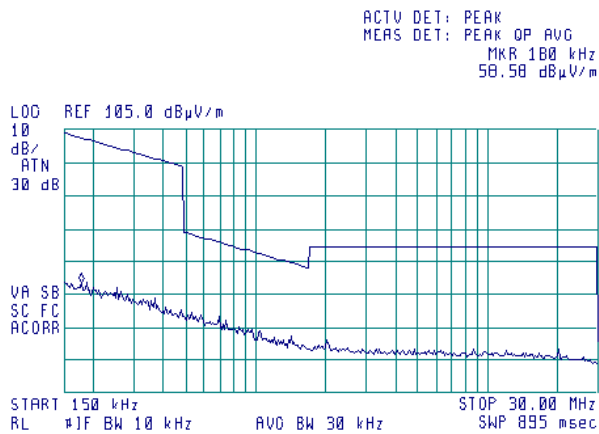

Mid frequency 433.82 MHz

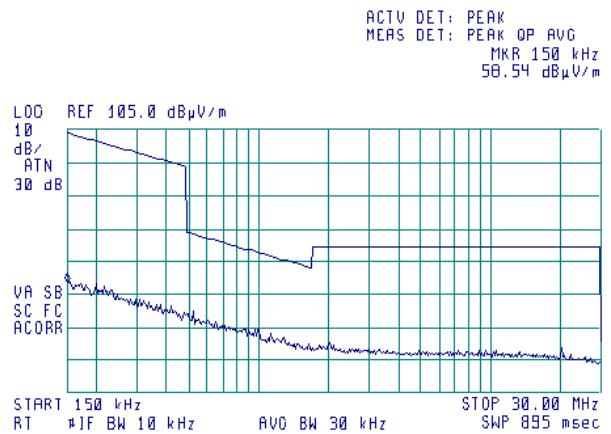

High frequency 434.62 MHz

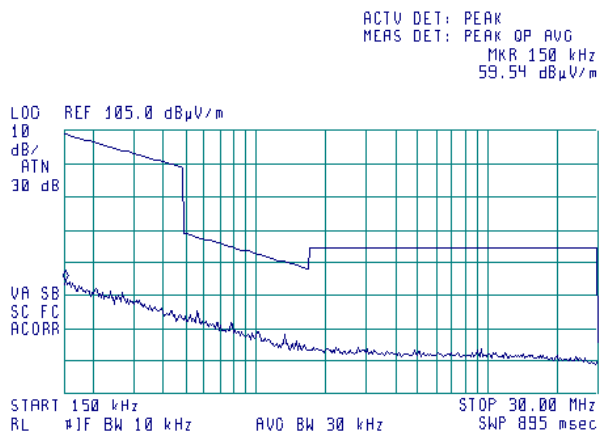



HERMON LABORATORIES

<b>Test specification: Section 15.231(b), Field strength of emissions</b>			
<b>Test procedure:</b> ANSI C63.10 sections 6.5, 6.6			
<b>Test mode:</b> Compliance		<b>Verdict:</b> PASS	
<b>Date(s):</b> 07-Jul-16 - 24-Aug-16			
<b>Temperature:</b> 24.5 °C	<b>Relative Humidity:</b> 48 %	<b>Air Pressure:</b> 1005 hPa	<b>Power:</b> 120 VAC
<b>Remarks:</b>			

Plot 7.2.13 Radiated emission measurements from 30 to 1000 MHz

TEST SITE: Semi anechoic chamber  
 TEST DISTANCE: 3 m  
 ANTENNA POLARIZATION: Vertical and Horizontal  
 EUT POSITION: Typical (Vertical/)

Low frequency: 433.22 MHz

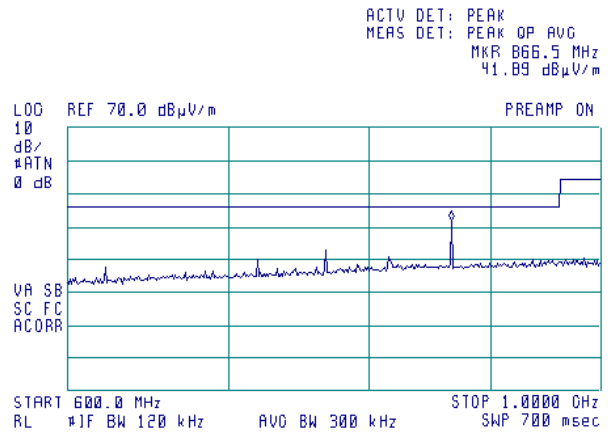
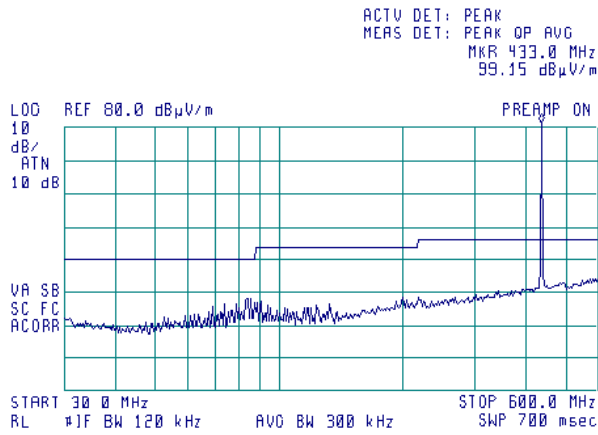

Plot 7.2.14 Radiated emission measurements from 30 to 1000 MHz

TEST SITE: Semi anechoic chamber  
 TEST DISTANCE: 3 m  
 ANTENNA POLARIZATION: Vertical and Horizontal  
 EUT POSITION: Typical (Vertical/)

Mid frequency: 433.82 MHz

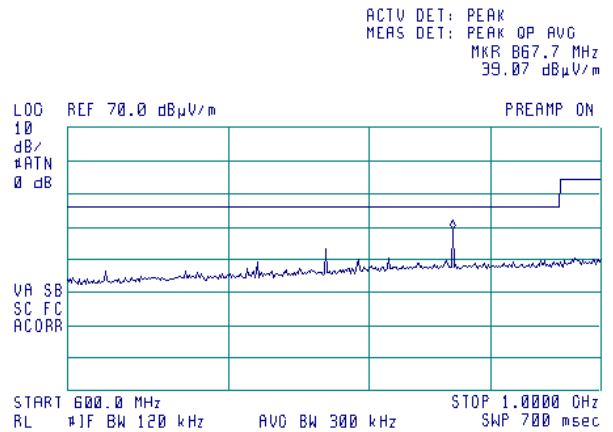
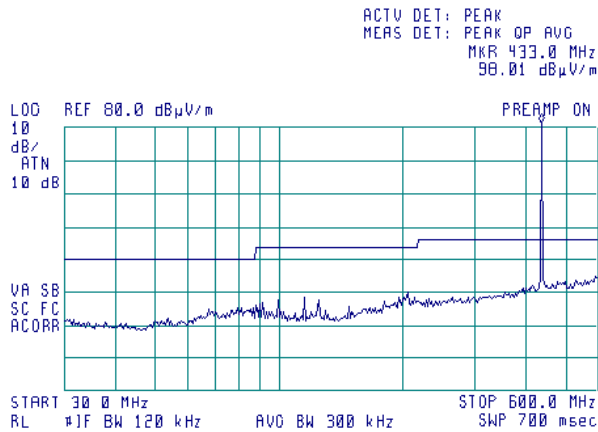





HERMON LABORATORIES

<b>Test specification: Section 15.231(b), Field strength of emissions</b>			
<b>Test procedure:</b> ANSI C63.10 sections 6.5, 6.6			
<b>Test mode:</b> Compliance		<b>Verdict: PASS</b>	
<b>Date(s):</b> 07-Jul-16 - 24-Aug-16			
<b>Temperature:</b> 24.5 °C	<b>Relative Humidity:</b> 48 %	<b>Air Pressure:</b> 1005 hPa	<b>Power:</b> 120 VAC
<b>Remarks:</b>			

**Plot 7.2.15 Radiated emission measurements from 30 to 1000 MHz**

TEST SITE: Semi anechoic chamber  
 TEST DISTANCE: 3 m  
 ANTENNA POLARIZATION: Vertical and Horizontal  
 EUT POSITION: Typical (Vertical/)

High frequency: 434.62 MHz

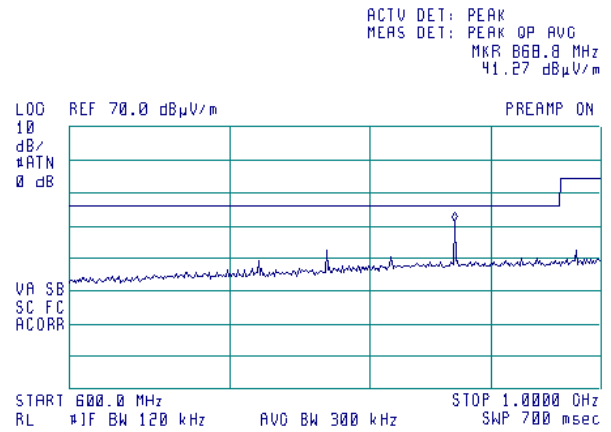
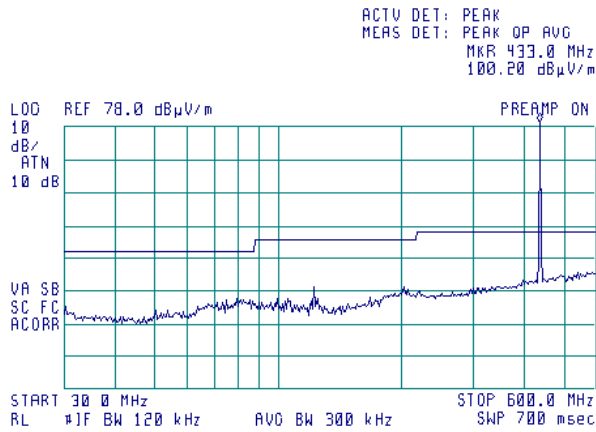



HERMON LABORATORIES

<b>Test specification: Section 15.231(b), Field strength of emissions</b>			
<b>Test procedure:</b> ANSI C63.10 sections 6.5, 6.6			
<b>Test mode:</b> Compliance		<b>Verdict: PASS</b>	
<b>Date(s):</b> 07-Jul-16 - 24-Aug-16			
<b>Temperature:</b> 24.5 °C	<b>Relative Humidity:</b> 48 %	<b>Air Pressure:</b> 1005 hPa	<b>Power:</b> 120 VAC
<b>Remarks:</b>			

Plot 7.2.16 Radiated emission measurements from 1000 to 4500 MHz at low frequency

TEST SITE: Semi anechoic chamber  
 TEST DISTANCE: 3 m  
 ANTENNA POLARIZATION: Vertical and Horizontal  
 EUT POSITION: Typical (Vertical/)

DETECTOR: Peak

DETECTOR: Average

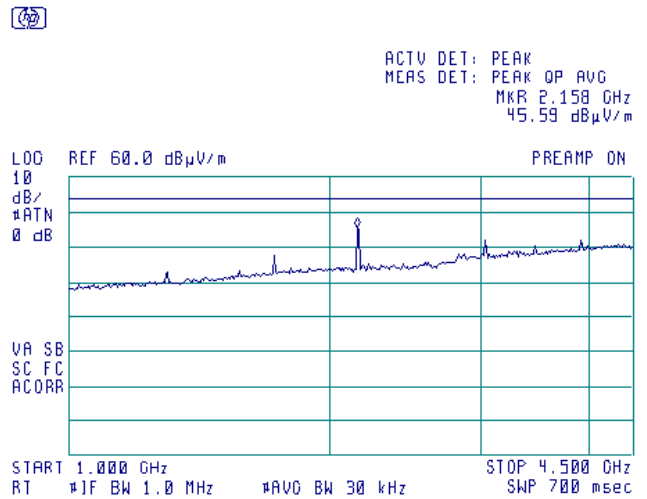
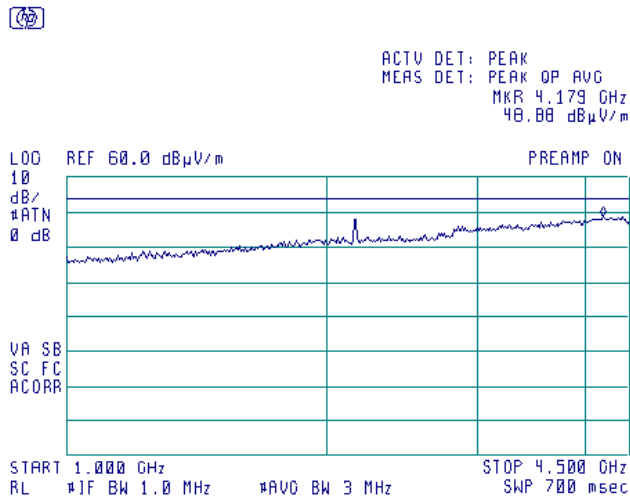

Plot 7.2.17 Radiated emission measurements from 1000 to 4500 MHz at mid frequency

TEST SITE: Semi anechoic chamber  
 TEST DISTANCE: 3 m  
 ANTENNA POLARIZATION: Vertical and Horizontal  
 EUT POSITION: Typical (Vertical/)

DETECTOR: Peak

DETECTOR: Average

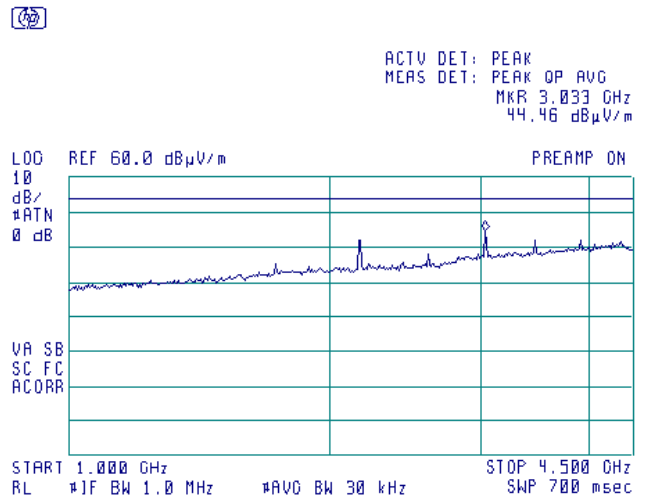
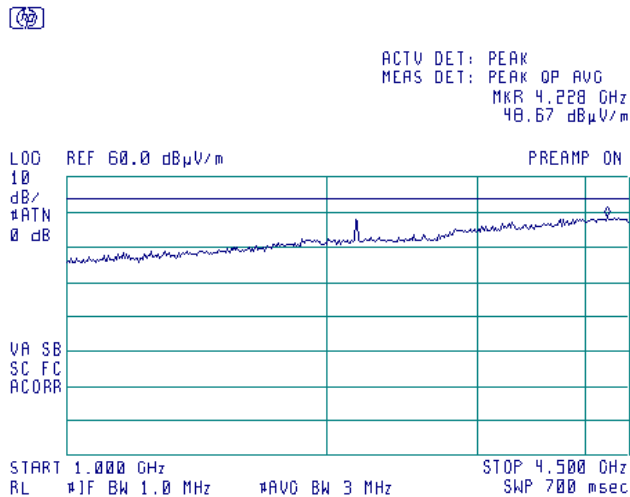



HERMON LABORATORIES

<b>Test specification: Section 15.231(b), Field strength of emissions</b>			
<b>Test procedure:</b> ANSI C63.10 sections 6.5, 6.6			
<b>Test mode:</b> Compliance		<b>Verdict: PASS</b>	
<b>Date(s):</b> 07-Jul-16 - 24-Aug-16			
<b>Temperature:</b> 24.5 °C	<b>Relative Humidity:</b> 48 %	<b>Air Pressure:</b> 1005 hPa	<b>Power:</b> 120 VAC
<b>Remarks:</b>			

**Plot 7.2.18 Radiated emission measurements from 1000 to 4500 MHz at high frequency**

TEST SITE: Semi anechoic chamber  
 TEST DISTANCE: 3 m  
 ANTENNA POLARIZATION: Vertical and Horizontal  
 EUT POSITION: Typical (Vertical/)

DETECTOR: Peak

DETECTOR: Average

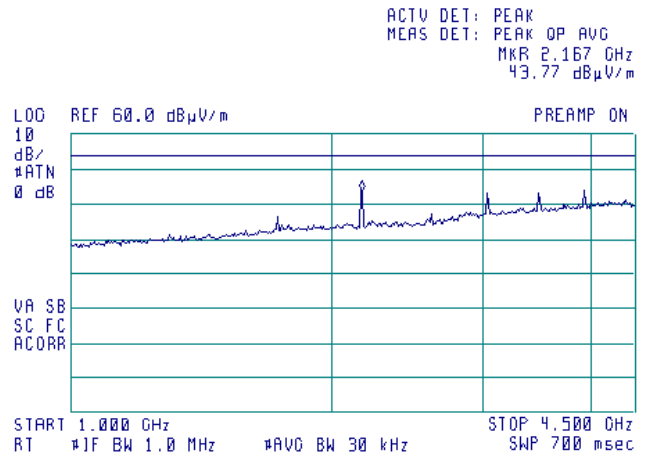
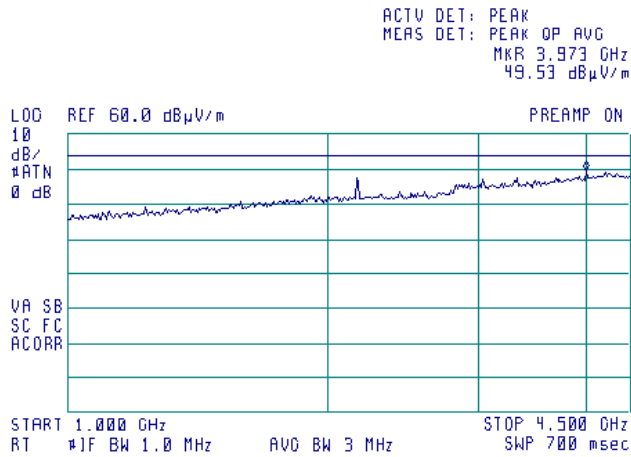



HERMON LABORATORIES

<b>Test specification: Section 15.231(b), Field strength of emissions</b>			
Test procedure: ANSI C63.10 sections 6.5, 6.6			
Test mode: Compliance		Verdict: PASS	
Date(s): 07-Jul-16 - 24-Aug-16			
Temperature: 24.5 °C	Relative Humidity: 48 %	Air Pressure: 1005 hPa	Power: 120 VAC
Remarks:			

**Plot 7.2.19 Radiated emission measurements at the second harmonic frequency**

TEST SITE: Semi anechoic chamber  
TEST DISTANCE: 3 m  
ANTENNA POLARIZATION: Vertical  
EUT POSITION: Typical (Vertical/)

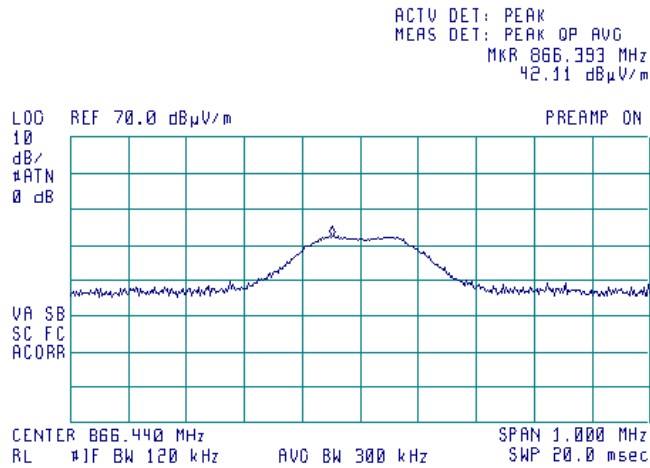

**Plot 7.2.20 Radiated emission measurements at the second harmonic frequency**

TEST SITE: Semi anechoic chamber  
TEST DISTANCE: 3 m  
ANTENNA POLARIZATION: Horizontal  
EUT POSITION: Typical (Vertical/)

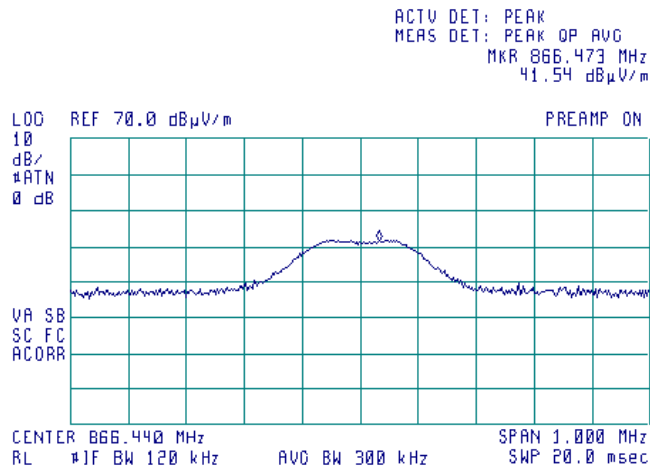



HERMON LABORATORIES

<b>Test specification: Section 15.231(b), Field strength of emissions</b>			
<b>Test procedure:</b> ANSI C63.10 sections 6.5, 6.6			
<b>Test mode:</b> Compliance		<b>Verdict:</b> PASS	
<b>Date(s):</b> 07-Jul-16 - 24-Aug-16			
<b>Temperature:</b> 24.5 °C	<b>Relative Humidity:</b> 48 %	<b>Air Pressure:</b> 1005 hPa	<b>Power:</b> 120 VAC
<b>Remarks:</b>			

**Plot 7.2.21 Radiated emission measurements at the second harmonic frequency**

TEST SITE: Semi anechoic chamber  
TEST DISTANCE: 3 m  
ANTENNA POLARIZATION: Vertical  
EUT POSITION: Typical (Vertical/)

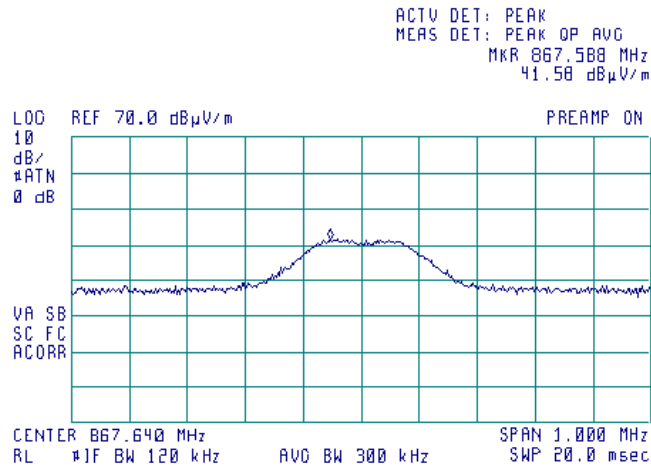

**Plot 7.2.22 Radiated emission measurements at the second harmonic frequency**

TEST SITE: Semi anechoic chamber  
TEST DISTANCE: 3 m  
ANTENNA POLARIZATION: Horizontal  
EUT POSITION: Typical (Vertical/)

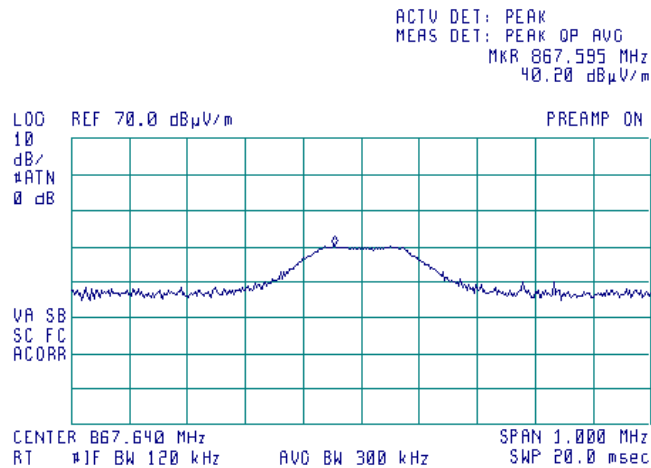



HERMON LABORATORIES

<b>Test specification: Section 15.231(b), Field strength of emissions</b>			
<b>Test procedure:</b> ANSI C63.10 sections 6.5, 6.6			
<b>Test mode:</b> Compliance		<b>Verdict:</b> PASS	
<b>Date(s):</b> 07-Jul-16 - 24-Aug-16			
<b>Temperature:</b> 24.5 °C	<b>Relative Humidity:</b> 48 %	<b>Air Pressure:</b> 1005 hPa	<b>Power:</b> 120 VAC
<b>Remarks:</b>			

**Plot 7.2.23 Radiated emission measurements at the second harmonic frequency**

TEST SITE: Semi anechoic chamber  
 TEST DISTANCE: 3 m  
 ANTENNA POLARIZATION: Vertical  
 EUT POSITION: Typical (Vertical/)

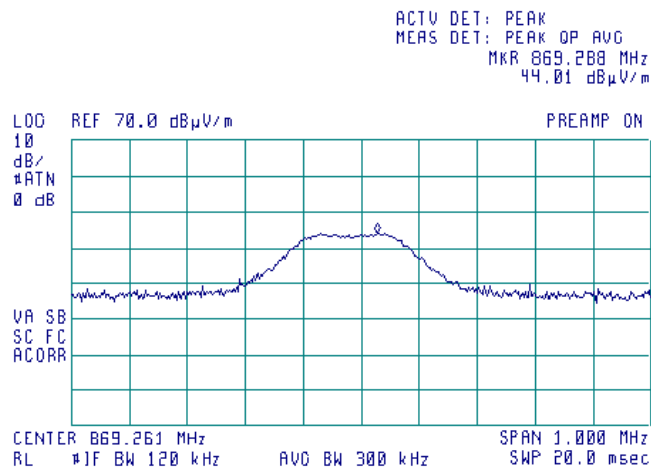

**Plot 7.2.24 Radiated emission measurements at the second harmonic frequency**

TEST SITE: Semi anechoic chamber  
 TEST DISTANCE: 3 m  
 ANTENNA POLARIZATION: Horizontal  
 EUT POSITION: Typical (Vertical/)

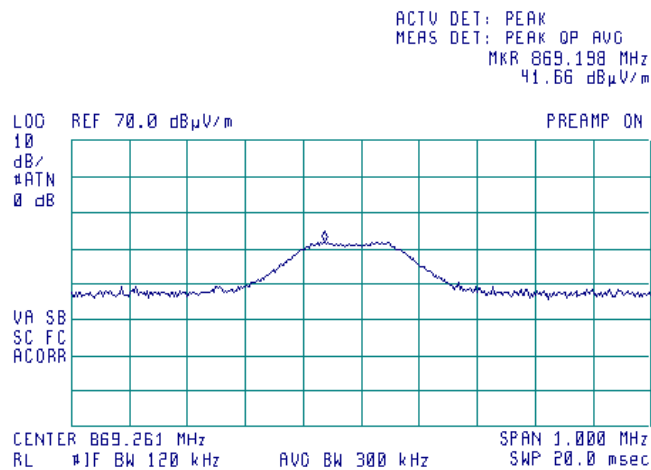



HERMON LABORATORIES

<b>Test specification: Section 15.231(b), Field strength of emissions</b>			
Test procedure: ANSI C63.10 sections 6.5, 6.6			
Test mode: Compliance		Verdict: PASS	
Date(s): 07-Jul-16 - 24-Aug-16			
Temperature: 24.5 °C	Relative Humidity: 48 %	Air Pressure: 1005 hPa	Power: 120 VAC
Remarks:			

**Plot 7.2.25 Radiated emission measurements at the fifth harmonic frequency**

TEST SITE: OATS  
TEST DISTANCE: 3 m  
ANTENNA POLARIZATION: Vertical  
EUT POSITION: Typical (Vertical/)

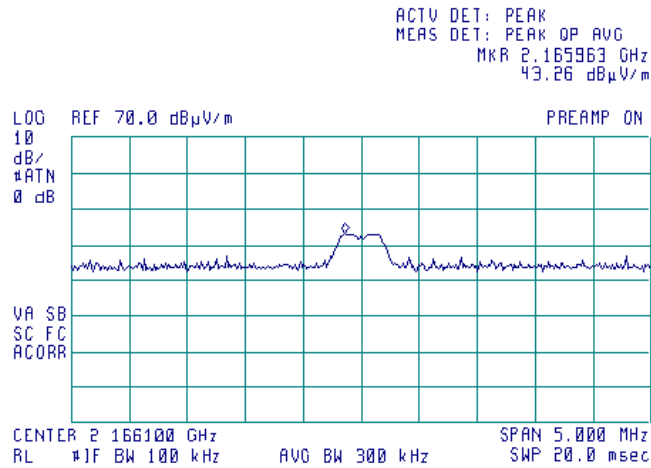

**Plot 7.2.26 Radiated emission measurements at the fifth harmonic frequency**

TEST SITE: OATS  
TEST DISTANCE: 3 m  
ANTENNA POLARIZATION: Horizontal  
EUT POSITION: Typical (Vertical/)

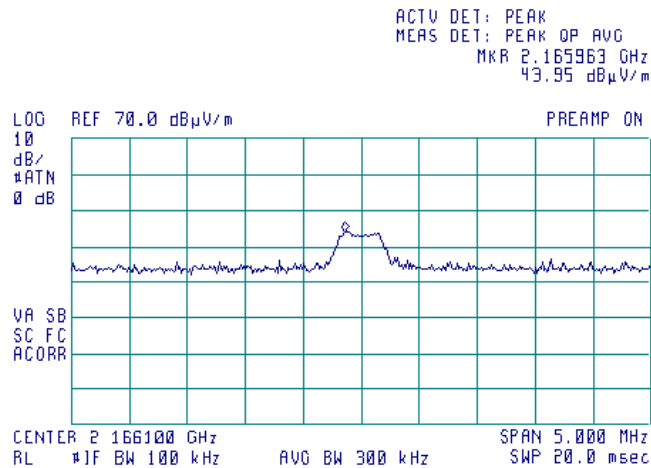



HERMON LABORATORIES

<b>Test specification: Section 15.231(b), Field strength of emissions</b>			
<b>Test procedure:</b> ANSI C63.10 sections 6.5, 6.6			
<b>Test mode:</b> Compliance		<b>Verdict: PASS</b>	
<b>Date(s):</b> 07-Jul-16 - 24-Aug-16			
<b>Temperature:</b> 24.5 °C	<b>Relative Humidity:</b> 48 %	<b>Air Pressure:</b> 1005 hPa	<b>Power:</b> 120 VAC
<b>Remarks:</b>			

**Plot 7.2.27 Radiated emission measurements at the fifth harmonic frequency**

TEST SITE: OATS  
 TEST DISTANCE: 3 m  
 ANTENNA POLARIZATION: Vertical and Horizontal  
 EUT POSITION: Typical (Vertical/)

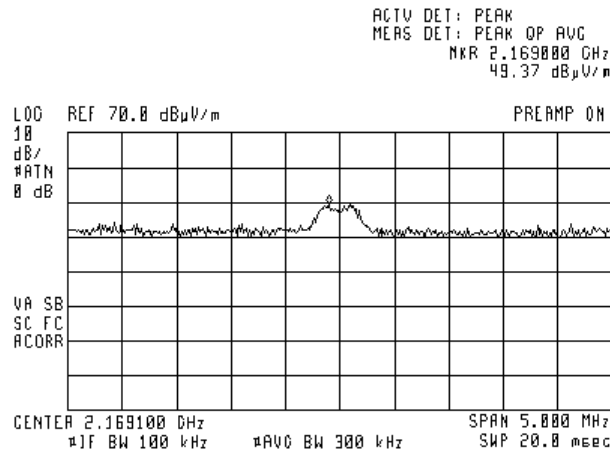

**Plot 7.2.28 Radiated emission measurements at the fifth harmonic frequency**

TEST SITE: OATS  
 TEST DISTANCE: 3 m  
 ANTENNA POLARIZATION: Vertical and Horizontal  
 EUT POSITION: Typical (Vertical/)

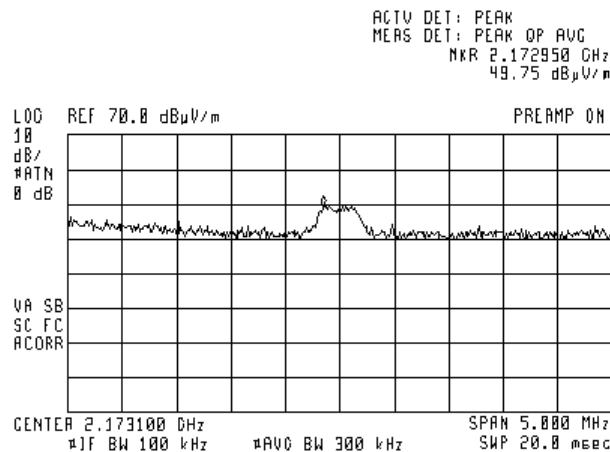





<b>Test specification: Section 15.231(b), Field strength of emissions</b>			
Test procedure: ANSI C63.10 sections 6.5, 6.6			
Test mode: Compliance		Verdict: PASS	
Date(s): 07-Jul-16 - 24-Aug-16			
Temperature: 24.5 °C	Relative Humidity: 48 %	Air Pressure: 1005 hPa	Power: 120 VAC
Remarks:			

**Plot 7.2.29 Radiated emission measurements at the eighth harmonic frequency**

TEST SITE: OATS  
TEST DISTANCE: 3 m  
ANTENNA POLARIZATION: Vertical  
EUT POSITION: Typical (Vertical)

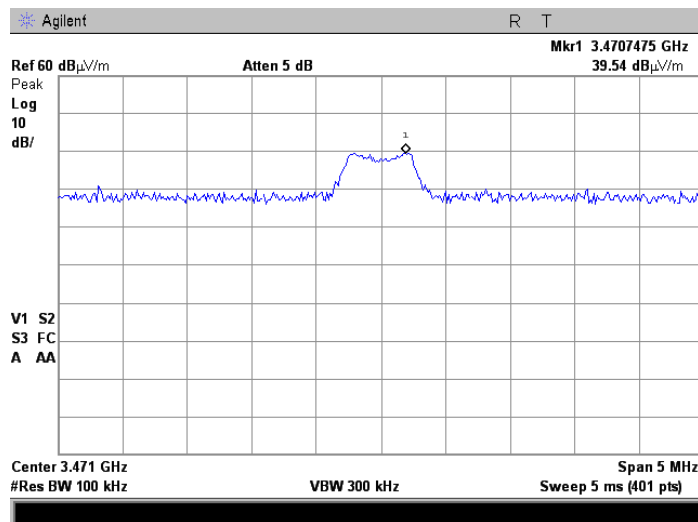

**Plot 7.2.30 Radiated emission measurements at the eighth harmonic frequency**

TEST SITE: OATS  
TEST DISTANCE: 3 m  
ANTENNA POLARIZATION: Horizontal  
EUT POSITION: Typical (Vertical)

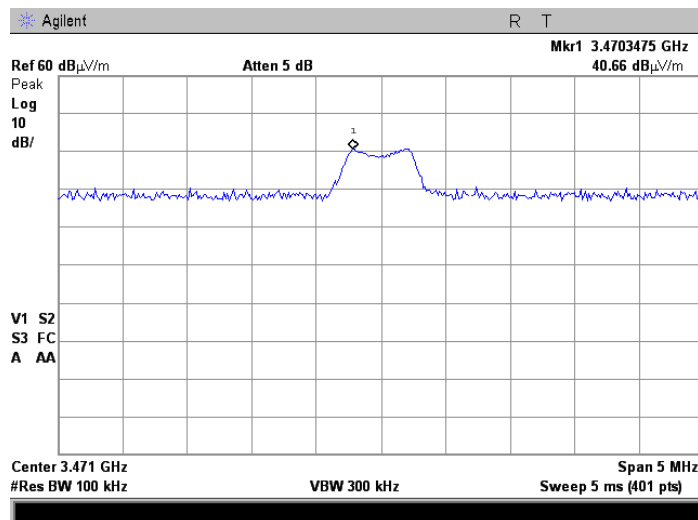



<b>Test specification: Section 15.231(b), Field strength of emissions</b>			
Test procedure: ANSI C63.10 sections 6.5, 6.6			
Test mode: Compliance		Verdict: PASS	
Date(s): 07-Jul-16 - 24-Aug-16			
Temperature: 24.5 °C	Relative Humidity: 48 %	Air Pressure: 1005 hPa	Power: 120 VAC
Remarks:			

**Plot 7.2.31 Radiated emission measurements at the eighth harmonic frequency**

TEST SITE: OATS  
TEST DISTANCE: 3 m  
ANTENNA POLARIZATION: Vertical  
EUT POSITION: Typical (Vertical)

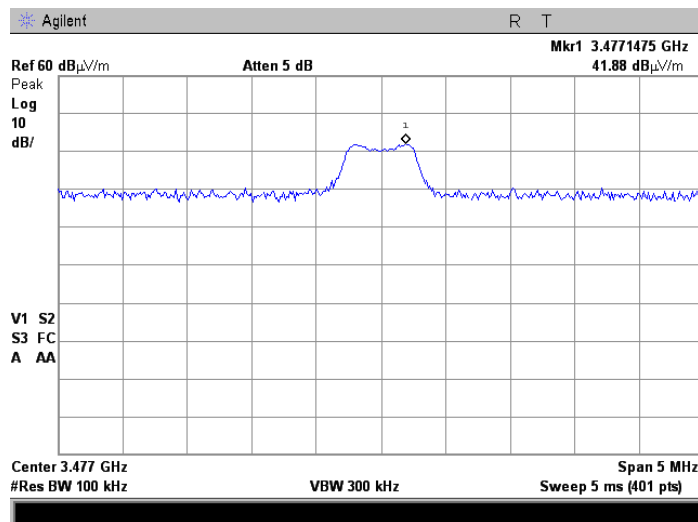

**Plot 7.2.32 Radiated emission measurements at the eighth harmonic frequency**

TEST SITE: OATS  
TEST DISTANCE: 3 m  
ANTENNA POLARIZATION: Horizontal  
EUT POSITION: Typical (Vertical)

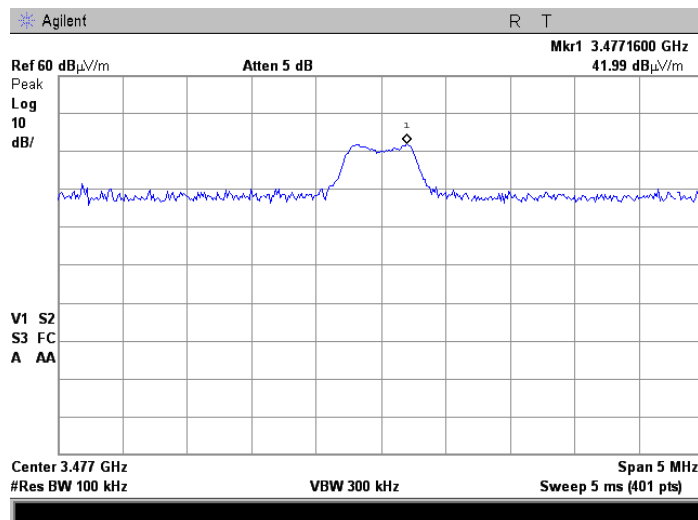



<b>Test specification: Section 15.231(b), Field strength of emissions</b>			
<b>Test procedure:</b> ANSI C63.10 sections 6.5, 6.6			
<b>Test mode:</b> Compliance		<b>Verdict:</b> PASS	
<b>Date(s):</b> 07-Jul-16 - 24-Aug-16			
<b>Temperature:</b> 24.5 °C	<b>Relative Humidity:</b> 48 %	<b>Air Pressure:</b> 1005 hPa	<b>Power:</b> 120 VAC
<b>Remarks:</b>			

**Plot 7.2.33 Radiated emission measurements at the ninth harmonic frequency**

TEST SITE: OATS  
TEST DISTANCE: 3 m  
ANTENNA POLARIZATION: Vertical and Horizontal  
EUT POSITION: Typical (Vertical)

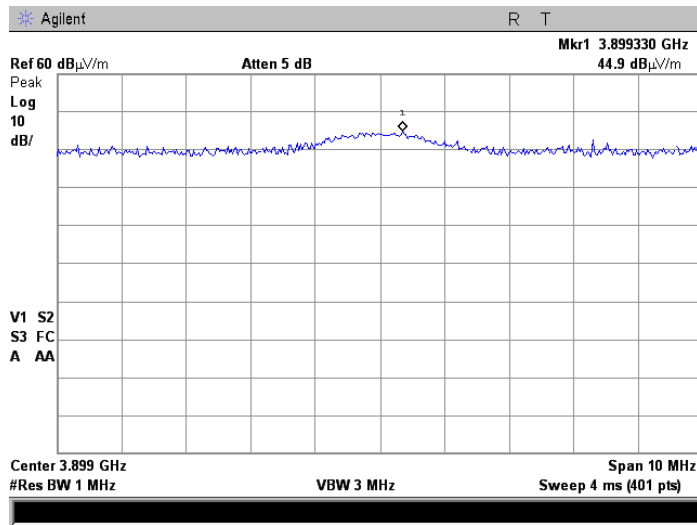

**Plot 7.2.34 Radiated emission measurements at the ninth harmonic frequency**

TEST SITE: OATS  
TEST DISTANCE: 3 m  
ANTENNA POLARIZATION: Vertical and Horizontal  
EUT POSITION: Typical (Vertical)

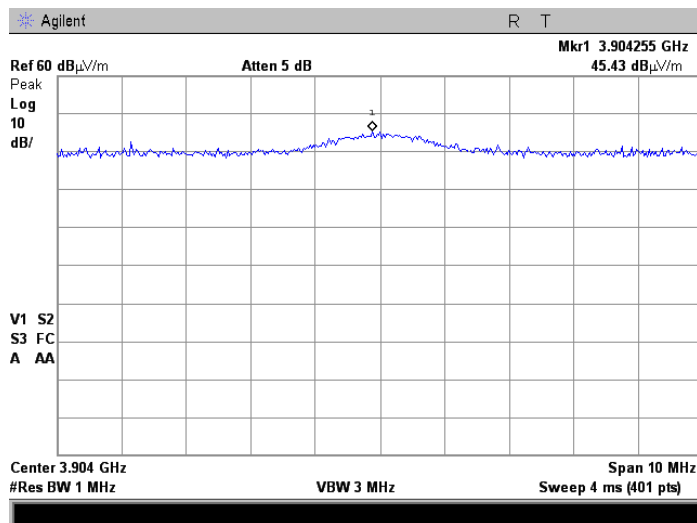



HERMON LABORATORIES

<b>Test specification: Section 15.231(b), Field strength of emissions</b>			
Test procedure: ANSI C63.10 sections 6.5, 6.6			
Test mode: Compliance		Verdict: PASS	
Date(s): 07-Jul-16 - 24-Aug-16			
Temperature: 24.5 °C	Relative Humidity: 48 %	Air Pressure: 1005 hPa	Power: 120 VAC
Remarks:			

**Plot 7.2.35 Radiated emission measurements at the ninth harmonic frequency**

TEST SITE: OATS  
TEST DISTANCE: 3 m  
ANTENNA POLARIZATION: Vertical  
EUT POSITION: Typical (Vertical)

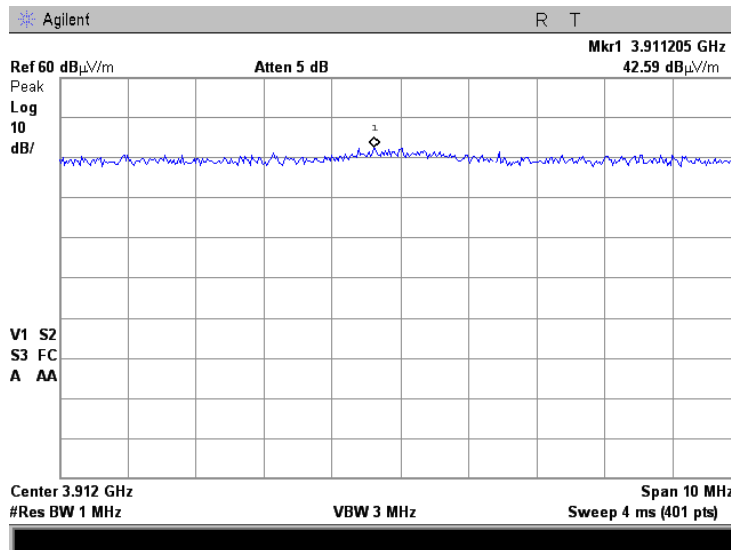



<b>Test specification: Section 15.231(c), Occupied bandwidth</b>			
<b>Test procedure:</b> ANSI C63.10 section 6.9.2			
<b>Test mode:</b> Compliance		<b>Verdict: PASS</b>	
<b>Date(s):</b> 25-Jul-16			
<b>Temperature:</b> 25.9 °C	<b>Relative Humidity:</b> 39 %	<b>Air Pressure:</b> 1004 hPa	<b>Power:</b> 120 VAC
<b>Remarks:</b>			

### 7.3 Occupied bandwidth test

#### 7.3.1 General

This test was performed to measure transmitter occupied bandwidth. Specification test limits are given in Table 7.3.1.

Table 7.3.1 Occupied bandwidth limits

Assigned frequency, MHz	Modulation envelope reference points*, dBc	Maximum allowed bandwidth, % of the carrier frequency
70 - 900	20.0	0.25
Above 900		0.50

\*- Modulation envelope reference points provided in terms of attenuation below modulated carrier.

#### 7.3.2 Test procedure

7.3.2.1 The EUT was set up as shown in Figure 7.3.1, energized and its proper operation was checked.

7.3.2.2 The EUT was set to transmit modulated carrier.

7.3.2.3 The transmitter occupied bandwidth was measured with spectrum analyzer as frequency delta between reference points on modulation envelope and provided in Table 7.3.2 and the associated plots.

Figure 7.3.1 Occupied bandwidth test setup





<b>Test specification: Section 15.231(c), Occupied bandwidth</b>			
<b>Test procedure:</b> ANSI C63.10 section 6.9.2			
<b>Test mode:</b> Compliance		<b>Verdict: PASS</b>	
<b>Date(s):</b> 25-Jul-16			
<b>Temperature:</b> 25.9 °C	<b>Relative Humidity:</b> 39 %	<b>Air Pressure:</b> 1004 hPa	<b>Power:</b> 120 VAC
<b>Remarks:</b>			

Table 7.3.2 Occupied bandwidth test results

DETECTOR USED: Peak hold  
 RESOLUTION BANDWIDTH: 10 kHz  
 VIDEO BANDWIDTH: 30 kHz  
 MODULATION ENVELOPE REFERENCE POINTS: 20 dBc  
 MODULATION: GFSK  
 MODULATING SIGNAL: ID code  
 BIT RATE: 50 kbps

Carrier frequency, MHz	Occupied bandwidth, kHz	Limit		Margin, kHz	Verdict
		% of the carrier frequency	kHz		
433.22	108.75	0.25	1082.5	973.75	Pass
433.82	107.50	0.25	1082.5	975.00	Pass
434.62	110.00	0.25	1082.5	972.50	Pass

Reference numbers of test equipment used

HL 2909	HL 3810	HL 4274					
---------	---------	---------	--	--	--	--	--

Full description is given in Appendix A.



HERMON LABORATORIES

<b>Test specification:</b> Section 15.231(c), Occupied bandwidth			
<b>Test procedure:</b> ANSI C63.10 section 6.9.2			
<b>Test mode:</b> Compliance		<b>Verdict:</b>	<b>PASS</b>
<b>Date(s):</b> 25-Jul-16			
<b>Temperature:</b> 25.9 °C	<b>Relative Humidity:</b> 39 %	<b>Air Pressure:</b> 1004 hPa	<b>Power:</b> 120 VAC
<b>Remarks:</b>			

Plot 7.3.1 Occupied bandwidth test result at low frequency

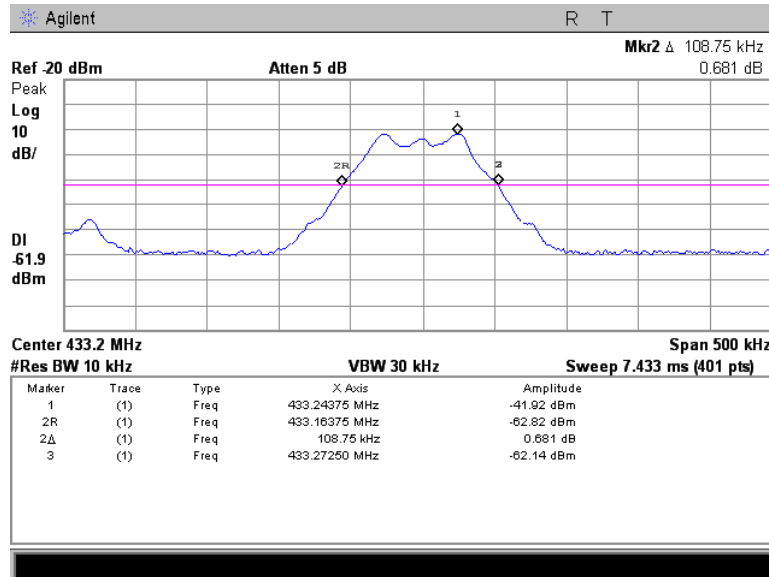

Plot 7.3.2 Occupied bandwidth test result at mid frequency

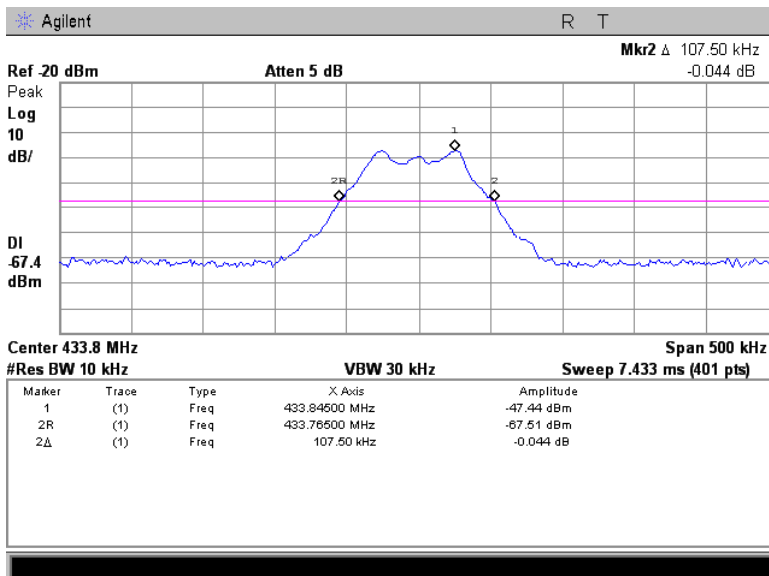



HERMON LABORATORIES

<b>Test specification: Section 15.231(c), Occupied bandwidth</b>			
<b>Test procedure:</b> ANSI C63.10 section 6.9.2			
<b>Test mode:</b> Compliance		<b>Verdict:</b> PASS	
<b>Date(s):</b> 25-Jul-16			
<b>Temperature:</b> 25.9 °C	<b>Relative Humidity:</b> 39 %	<b>Air Pressure:</b> 1004 hPa	<b>Power:</b> 120 VAC
<b>Remarks:</b>			

Plot 7.3.3 Occupied bandwidth test result at high frequency

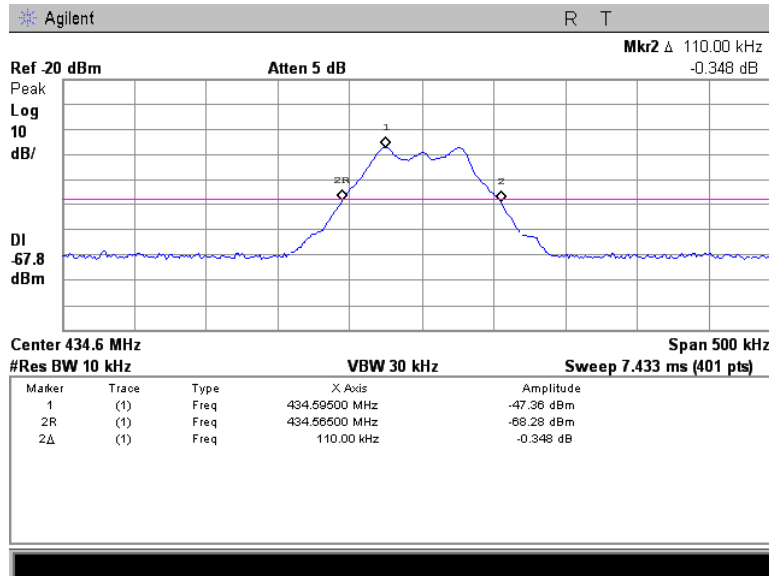





<b>Test specification: Section 15.207(a), Conducted emission</b>			
<b>Test procedure:</b> ANSI C63.10 section 6.2			
<b>Test mode:</b> Compliance		<b>Verdict:</b> PASS	
<b>Date(s):</b> 24-Jul-16			
<b>Temperature:</b> 23.7 °C	<b>Relative Humidity:</b> 48 %	<b>Air Pressure:</b> 1005 hPa	<b>Power:</b> 120 VAC
<b>Remarks:</b>			

## 7.4 Conducted emissions

### 7.4.1 General

This test was performed to measure common mode conducted emissions at the power port. Specification test limits are given in Table 7.4.1.

Table 7.4.1 Limits for conducted emissions

Frequency, MHz	Class B limit, dB(μV)	
	QP	AVRG
0.15 - 0.5	66 - 56*	56 - 46*
0.5 - 5.0	56	46
5.0 - 30	60	50

\* The limit decreases linearly with the logarithm of frequency.

### 7.4.2 Test procedure

7.4.2.1 The EUT was set up as shown in Figure 7.4.1 and associated photographs, energized and the performance check was conducted.

7.4.2.2 The measurements were performed at power terminals with the LISN, connected to a spectrum analyzer in the frequency range referred to in Table 7.4.2. Unused coaxial connector of the LISN was terminated with 50 Ohm. Quasi-peak and average detectors were used throughout the testing.

7.4.2.3 The position of the device cables was varied to determine maximum emission level.

7.4.2.4 The worst test results (the lowest margins) were recorded in Table 7.4.2 and shown in the associated plots.

Figure 7.4.1 Setup for conducted emission measurements, table-top equipment

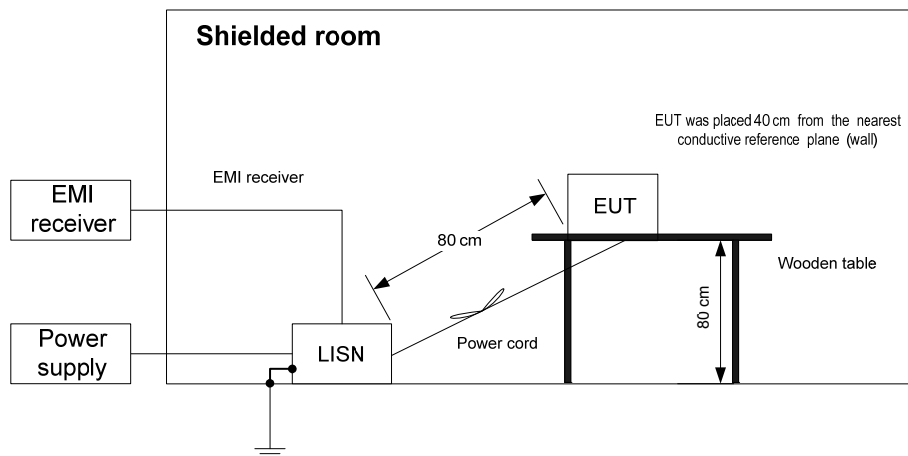



<b>Test specification: Section 15.207(a), Conducted emission</b>			
<b>Test procedure:</b> ANSI C63.10 section 6.2			
<b>Test mode:</b> Compliance		<b>Verdict: PASS</b>	
<b>Date(s):</b> 24-Jul-16			
<b>Temperature:</b> 23.7 °C	<b>Relative Humidity:</b> 48 %	<b>Air Pressure:</b> 1005 hPa	<b>Power:</b> 120 VAC
<b>Remarks:</b>			

Table 7.4.2 Conducted emission test results

LINE: AC mains  
 EUT OPERATING MODE: Transmit  
 EUT SET UP: TABLE-TOP  
 TEST SITE: SHIELDED ROOM  
 DETECTORS USED: PEAK / QUASI-PEAK / AVERAGE  
 FREQUENCY RANGE: 150 kHz - 30 MHz  
 RESOLUTION BANDWIDTH: 9 kHz

Frequency, MHz	Peak emission, dB(µV)	Quasi-peak			Average			Line ID	Verdict
		Measured emission, dB(µV)	Limit, dB(µV)	Margin, dB*	Measured emission, dB(µV)	Limit, dB(µV)	Margin, dB*		
0.1521	52.5	48.0	65.88	-17.88	33.1	55.88	-22.78	L1	Pass
0.2217	48.3	42.6	62.75	-20.15	24.8	52.75	-27.95		
0.3131	44.5	39.6	59.89	-20.29	24.5	49.89	-25.39		
0.57285	45.7	40.5	56.00	-15.50	27.2	46.00	-18.80		
0.62415	46.0	40.2	56.00	-15.80	29.8	46.00	-16.20		
0.1548	52.5	46.9	65.74	-18.84	36.4	55.74	-19.34	L2	Pass
0.2441	52.0	47.4	61.96	-14.56	39.5	51.96	-12.46		
0.4372	45.1	42.4	57.11	-14.71	26.8	47.11	-20.31		
0.5961	50.9	48.4	56.00	-7.60	36.8	46.00	-9.20		
0.91605	39.1	28.3	56.00	-27.70	22.5	46.00	-23.50		

\*- Margin = Measured emission - specification limit.

Reference numbers of test equipment used

HL 0447	HL 1513	HL 3612	HL 4778				
---------	---------	---------	---------	--	--	--	--

Full description is given in Appendix A.



HERMON LABORATORIES

<b>Test specification: Section 15.207(a), Conducted emission</b>			
<b>Test procedure:</b> ANSI C63.10 section 6.2			
<b>Test mode:</b> Compliance		<b>Verdict:</b> PASS	
<b>Date(s):</b> 24-Jul-16			
<b>Temperature:</b> 23.7 °C	<b>Relative Humidity:</b> 48 %	<b>Air Pressure:</b> 1005 hPa	<b>Power:</b> 120 VAC
<b>Remarks:</b>			

**Plot 7.4.1 Conducted emission measurements**

LINE: L1  
 EUT OPERATING MODE: Transmit  
 LIMIT: QUASI-PEAK, AVERAGE  
 DETECTOR: PEAK



ACTV DET: PEAK  
 MEAS DET: PEAK QP AVG  
 MKR 150 kHz  
 48.00 dBµV

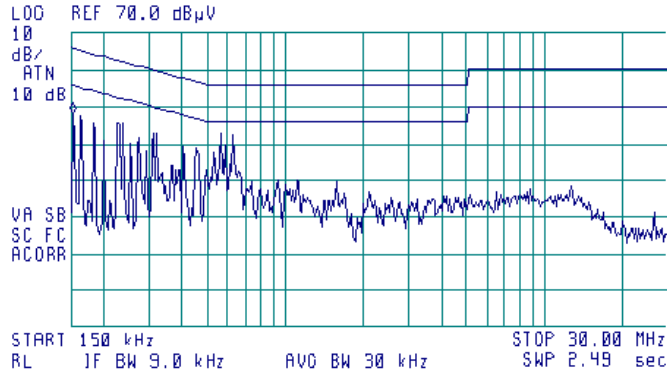

**Plot 7.4.2 Conducted emission measurements**

LINE: L2  
 EUT OPERATING MODE: Transmit  
 LIMIT: QUASI-PEAK, AVERAGE  
 DETECTOR: PEAK



ACTV DET: PEAK  
 MEAS DET: PEAK QP AVG  
 MKR 150 kHz  
 51.50 dBµV

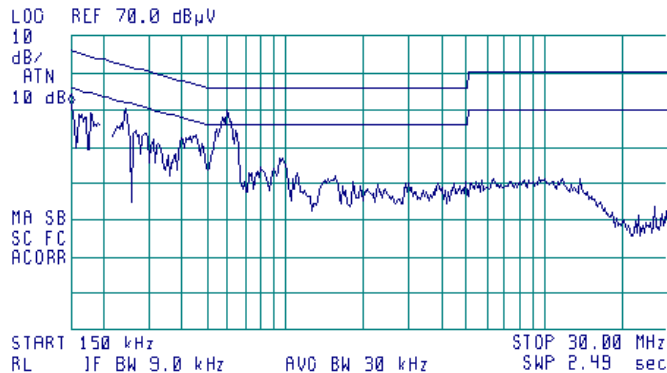



<b>Test specification:</b> Section 15.203, Antenna requirement			
<b>Test procedure:</b> Visual inspection / supplier declaration			
<b>Test mode:</b> Compliance		<b>Verdict:</b> PASS	
<b>Date(s):</b> 25-Jul-16			
<b>Temperature:</b> 23.2 °C	<b>Relative Humidity:</b> 48 %	<b>Air Pressure:</b> 1004 hPa	<b>Power:</b> 120 VAC
<b>Remarks:</b>			

### 7.5 Antenna requirements

The EUT was verified for compliance with antenna requirements. A transmitter shall be designed to ensure that no antenna other than that furnished by the responsible party will be used with the device. It may be either permanently attached or employs a unique antenna connector for every antenna proposed for use with the EUT. This requirement does not apply to professionally installed transmitters. The rationale for compliance with the above requirements was either visual inspection results or supplier declaration. The summary of results is provided in Table 7.5.1.

Table 7.5.1 Antenna requirements

Requirement	Rationale	Verdict
The transmitter antenna is permanently attached	Visual inspection	Comply
The transmitter employs a unique antenna connector	NA	
The transmitter requires professional installation	NA	

Photograph 7.5.1 Antenna assembly

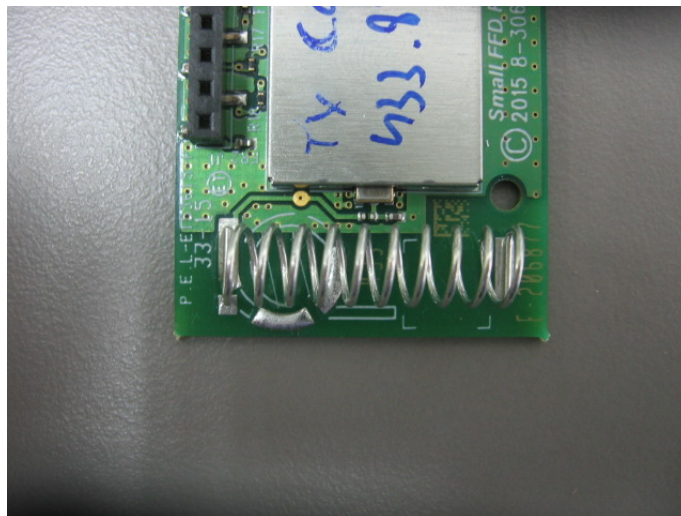



**8 APPENDIX A Test equipment and ancillaries used for tests**

HL No	Description	Manufacturer	Model	Ser. No.	Last Cal./ Check	Due Cal./ Check
0415	Cable, Coax, RF, RG-214, 12.3 m	Hermon Laboratories	CC-3	056	07-Dec-15	07-Dec-16
0446	Antenna, Loop, Active, 10 kHz - 30 MHz	EMCO	6502	2857	18-Jan-16	18-Jan-17
0447	LISN, 16/2, 300V RMS, 50 Ohm/50 uH + 5 Ohm, STD CISPR 16-1	Hermon Laboratories	LISN 16 - 1	066	13-Oct-15	13-Oct-16
0521	EMI Receiver (Spectrum Analyzer) with RF filter section 9 kHz-6.5 GHz	Hewlett Packard	8546A	3617A 00319, 3448A002 53	27-Oct-15	27-Oct-16
0604	Antenna BiconiLog Log-Periodic/T Bow-TIE, 26 - 2000 MHz	EMCO	3141	9611-1011	10-May-16	10-May-17
1513	Cable RF, 8 m, BNC/BNC	Belden	M17/167 MIL-C-17	1513	08-Sep-15	08-Sep-16
1984	Antenna, Double-Ridged Waveguide Horn, 1 to 18 GHz, 300 W	EMC Test Systems	3115	9911-5964	28-Mar-16	28-Mar-17
2909	Spectrum analyzer, ESA-E, 100 Hz to 26.5 GHz	Agilent Technologies	E4407B	MY414447 62	21-Feb-16	21-Feb-17
3612	Cable RF, 17.5 m, N type-N type	Teldor	RG-214/U	NA	07-Dec-15	07-Dec-16
3810	Near-Field Probe Set, Hand held, 6 probes	EMC Test Systems	7405	9706-3927	30-Dec-15	30-Dec-16
3830	Cable RF, BNC-BNC, 3 m	Hermon Laboratories	RG 58 A/U	NA	30-Dec-15	30-Dec-16
3901	Microwave Cable Assembly, 40.0 GHz, 3.5 m, SMA/SMA	Huber-Suhner	SUCOFLE X 102A	1225/2A	15-Feb-16	15-Feb-17
4114	Antenna, Double-Ridged Waveguide Horn, 1 to 18 GHz	ETS Lindgren	3117	00123515	24-Dec-15	24-Dec-16
4274	Test Cable , DC-18 GHz, 1.8 m, SMA/M - N/M	Mini-Circuits	CBL-6FT- SMNM+	70047	30-May-16	30-May-17
4279	Test Cable , DC-18 GHz, 4.6 m, N/M - N/M	Mini-Circuits	APC- 15FT- NMNM+	0757A	22-Nov-15	22-Nov-16
4294	Microwave Cable Assembly, 18.0 GHz, 3.4 m, SMA/SMA	Huber-Suhner	Sucoflex P103	NA	07-Dec-15	07-Dec-16
4353	Low Loss Armored Test Cable, DC - 18 GHz, 6.2 m, N type-M/N type-M	MegaPhase	NC29- N1N1-244	12025101 003	15-Mar-16	15-Mar-17
4778	EMI Receiver, 9 kHz - 2.9 GHz, System: HL1431, HL4777	Hewlett Packard	8542E	30807A00 262, 3427A001 23	05-Nov-15	05-Nov-16
4932	Microwave preamplifier, 500 MHz to 18 GHz, 40 dB Gain	Com-Power Corporation	PAM- 118A	551029	19-Nov-15	19-Nov-16

**9 APPENDIX B Measurement uncertainties****Expanded uncertainty at 95% confidence in Hermon Labs EMC measurements**

Test description	Expanded uncertainty
Conducted emissions with LISN	9 kHz to 150 kHz: $\pm 3.9$ dB 150 kHz to 30 MHz: $\pm 3.8$ dB
Radiated emissions at 10 m measuring distance Horizontal polarization  Vertical polarization	Biconilog antenna: $\pm 5.0$ dB Biconical antenna: $\pm 5.0$ dB Log periodic antenna: $\pm 5.1$ dB Double ridged horn antenna: $\pm 5.3$ dB Biconilog antenna: $\pm 5.5$ dB Biconical antenna: $\pm 5.5$ dB Log periodic antenna: $\pm 5.6$ dB Double ridged horn antenna: $\pm 5.8$ dB
Radiated emissions at 3 m measuring distance Horizontal polarization  Vertical polarization	Biconilog antenna: $\pm 5.3$ dB Biconical antenna: $\pm 5.0$ dB Log periodic antenna: $\pm 5.3$ dB Double ridged horn antenna: $\pm 5.3$ dB Biconilog antenna: $\pm 6.0$ dB Biconical antenna: $\pm 5.7$ dB Log periodic antenna: $\pm 6.0$ dB Double ridged horn antenna: $\pm 6.0$ dB
Conducted emissions at RF antenna connector	9 kHz to 2.9 GHz: $\pm 2.6$ dB 2.9 GHz to 6.46 GHz: $\pm 3.5$ dB 6.46 GHz to 13.2 GHz: $\pm 4.3$ dB 13.2 GHz to 22.0 GHz: $\pm 5.0$ dB 22.0 GHz to 26.8 GHz: $\pm 5.5$ dB 26.8 GHz to 40.0 GHz: $\pm 4.8$ dB
Duty cycle, timing (Tx ON / OFF) and average factor measurements	$\pm 1.0$ %
Occupied bandwidth	$\pm 8.0$ %

Hermon Laboratories is accredited by A2LA for calibration according to present requirements of ISO/IEC 17025 and NCSL Z540-1. The accreditation is granted to perform calibration of parameters that are listed in the Scope of Hermon Laboratories Accreditation.

Hermon Laboratories calibrates its reference and transfer standards by calibration laboratories accredited to ISO/IEC 17025 by a mutually recognized Accreditation Body or by a recognized national metrology institute. All reference and transfer standards used in the calibration system are traceable to national or international standards.

In-house calibration of all test and measurement equipment is performed on a regular basis according to Hermon Laboratories calibration procedures, manufacturer calibration/verification procedures or procedures defined in the relevant standards. The Hermon Laboratories test and measurement equipment is calibrated within the tolerances specified by the manufacturers and/or by the relevant standards.



## 10 APPENDIX C Test laboratory description

Tests were performed at Hermon Laboratories Ltd., which is a fully independent, private, EMC, safety, environmental and telecommunication testing facility.

Hermon Laboratories is listed by the Federal Communications Commission (USA) for all parts of Code of Federal Regulations 47 (CFR 47), Registration Numbers 90624 for OATS and 90623 for the anechoic chamber; by Industry Canada for electromagnetic emissions, file number IC 2186A-1 for OATS, certified by VCCI, Japan (the registration numbers are R-808 for OATS, R-1082 for anechoic chamber, C-845 for conducted emissions site, T-1606 for conducted emissions at telecommunication ports), has a status of a Telefication - Listed Testing Laboratory, Certificate No. L138/00. The laboratory is accredited by American Association for Laboratory Accreditation (USA) according to ISO/IEC 17025 for electromagnetic compatibility, product safety, telecommunications testing and environmental simulation (for exact scope please refer to Certificate No. 839.01). The FCC Designation Number is IL1001.

Address: P.O. Box 23, Binyamina 30500, Israel.  
Telephone: +972 4628 8001  
Fax: +972 4628 8277  
e-mail: mail@hermonlabs.com  
website: www.hermonlabs.com

Person for contact: Mr. Alex Usoskin, CEO.

## 11 APPENDIX D Specification references

47CFR part 15: 2015	Radio Frequency Devices.
ANSI C63.10: 2013	American National Standard of Procedures for Compliance Testing of Unlicensed Wireless Devices
ANSI C63.2: 1996	American National Standard for Instrumentation-Electromagnetic Noise and Field Strength, 10 kHz to 40 GHz-Specifications.



## 12 APPENDIX E Test equipment correction factors

Correction factor  
Line impedance stabilization network  
Model LISN 16 - 1  
Hermon Laboratories, HL 0447

Frequency, kHz	Correction factor, dB
10	4.9
15	2.86
20	1.83
25	1.25
30	0.91
35	0.69
40	0.53
50	0.35
60	0.25
70	0.18
80	0.14
90	0.11
100	0.09
125	0.06
150	0.04

The correction factor in dB is to be added to meter readings of an interference analyzer or a spectrum analyzer.





**Antenna factor**  
**Active loop antenna**  
**Model 6502, S/N 2857, HL 0446**

Frequency, MHz	Magnetic antenna factor, dB	Electric antenna factor, dB
0.009	-32.8	18.7
0.010	-33.8	17.7
0.020	-38.3	13.2
0.050	-41.1	10.4
0.075	-41.3	10.2
0.100	-41.6	9.9
0.150	-41.7	9.8
0.250	-41.6	9.9
0.500	-41.8	9.8
0.750	-41.9	9.7
1.000	-41.4	10.1
2.000	-41.5	10.0
3.000	-41.4	10.2
4.000	-41.4	10.1
5.000	-41.5	10.1
10.000	-41.9	9.6
15.000	-41.9	9.6
20.000	-42.2	9.3
25.000	-42.8	8.7
30.000	-44.0	7.5

Antenna factor in dB(1/m) is to be added to receiver meter reading in dB( $\mu$ V) to convert it into field intensity in dB( $\mu$ V/m).



**Antenna factor**  
**Biconilog antenna EMCO Model 3141**  
**Ser.No.1011, HL 0604**

Frequency, MHz	Antenna factor, dB(1/m)	Frequency, MHz	Antenna factor, dB(1/m)	Frequency, MHz	Antenna factor, dB(1/m)
26	7.8	580	20.6	1320	27.8
28	7.8	600	21.3	1340	28.3
30	7.8	620	21.5	1360	28.2
40	7.2	640	21.2	1380	27.9
60	7.1	660	21.4	1400	27.9
70	8.5	680	21.9	1420	27.9
80	9.4	700	22.2	1440	27.8
90	9.8	720	22.2	1460	27.8
100	9.7	740	22.1	1480	28.0
110	9.3	760	22.3	1500	28.5
120	8.8	780	22.6	1520	28.9
130	8.7	800	22.7	1540	29.6
140	9.2	820	22.9	1560	29.8
150	9.8	840	23.1	1580	29.6
160	10.2	860	23.4	1600	29.5
170	10.4	880	23.8	1620	29.3
180	10.4	900	24.1	1640	29.2
190	10.3	920	24.1	1660	29.4
200	10.6	940	24.0	1680	29.6
220	11.6	960	24.1	1700	29.8
240	12.4	980	24.5	1720	30.3
260	12.8	1000	24.9	1740	30.8
280	13.7	1020	25.0	1760	31.1
300	14.7	1040	25.2	1780	31.0
320	15.2	1060	25.4	1800	30.9
340	15.4	1080	25.6	1820	30.7
360	16.1	1100	25.7	1840	30.6
380	16.4	1120	26.0	1860	30.6
400	16.6	1140	26.4	1880	30.6
420	16.7	1160	27.0	1900	30.6
440	17.0	1180	27.0	1920	30.7
460	17.7	1200	26.7	1940	30.9
480	18.1	1220	26.5	1960	31.2
500	18.5	1240	26.5	1980	31.6
520	19.1	1260	26.5	2000	32.0
540	19.5	1280	26.6		
560	19.8	1300	27.0		

Antenna factor in dB(1/m) is to be added to receiver meter reading in dB( $\mu$ V) to convert it into field strength in dB( $\mu$ V/m).



**Antenna factor**  
**Double-ridged wave guide horn antenna**  
**Model 3115, S/N 9911-5964, HL1984**

Frequency, MHz	Antenna factor, dB(1/m)
1000.0	24.7
1500.0	25.7
2000.0	27.6
2500.0	28.9
3000.0	31.2
3500.0	32.0
4000.0	32.5
4500.0	32.7
5000.0	33.6
5500.0	35.1
6000.0	35.4
6500.0	34.9
7000.0	36.1
7500.0	37.8
8000.0	38.0
8500.0	38.1
9000.0	39.1
9500.0	38.3
10000.0	38.6
10500.0	38.2
11000.0	38.7
11500.0	39.5
12000.0	40.0
12500.0	40.4
13000.0	40.5
13500.0	41.1
14000.0	41.6
14500.0	41.7
15000.0	38.7
15500.0	38.2
16000.0	38.8
16500.0	40.5
17000.0	42.5
17500.0	45.9
18000.0	49.4

Antenna factor in dB(1/m) is to be added to receiver meter reading in dB( $\mu$ V) to convert it into field strength in dB( $\mu$ V/m).



**Antenna factor**  
**Double-ridged waveguide horn antenna**  
**ETS Lindgren, Model 3117, serial number: 00123515, HL 4114**

Frequency, MHz	Antenna factor, dB/m		
	Measured	Manufacturer	Deviation
1000	28.0	28.4	-0.4
1500	28.0	27.4	0.6
2000	31.2	30.9	0.3
2500	32.5	33.4	-0.9
3000	32.9	32.6	0.3
3500	32.7	32.8	-0.1
4000	33.1	33.4	-0.3
4500	33.8	33.9	-0.1
5000	33.8	34.1	-0.3
5500	34.4	34.5	-0.1
6000	35.0	35.2	-0.2
6500	35.4	35.5	-0.1
7000	35.7	35.7	0.0
7500	35.9	35.7	0.2
8000	35.8	35.8	0.0
8500	35.9	35.8	0.1
9000	36.3	36.2	0.1
9500	36.6	36.6	0.0
10000	37.1	37.1	0.0
10500	37.6	37.5	0.1
11000	37.9	37.7	0.2
11500	38.5	38.1	0.4
12000	39.2	38.7	0.5
12500	39.0	38.9	0.1
13000	39.1	39.1	0.0
13500	38.9	38.8	0.1
14000	39.0	38.8	0.2
14500	39.6	39.9	-0.3
15000	39.9	39.7	0.2
15500	39.9	40.1	-0.2
16000	40.7	40.8	-0.1
16500	41.3	41.8	-0.5
17000	42.5	42.1	0.4
17500	41.3	41.2	0.1
18000	41.4	40.9	0.5

Antenna factor is to be added to receiver meter reading in dB( $\mu$ V) to convert to field strength in dB( $\mu$ V/meter)



**Cable loss**  
**Cable coaxial, RG-214/U, N type-N type, 17 m**  
**Teldor, HL 3612**

Frequency, MHz	Cable loss, dB
0.1	0.05
0.5	0.07
1	0.10
3	0.22
5	0.29
10	0.39
30	0.68
50	0.90
100	1.27
150	1.58
200	1.80
250	2.12
300	2.36
350	2.60
400	2.82
450	2.99
500	3.23
550	3.40
600	3.56
650	3.71
700	3.90
750	4.04
800	4.23
850	4.39
900	4.55
950	4.65
1000	4.79



**Cable loss**  
**Microwave Cable Assembly, Huber-Suhner, 40 GHz, 3.5 m, SMA-SMA, S/N 1225/2A**  
**HL 3901**

Frequency, MHz	Cable loss, dB	Frequency, MHz	Cable loss, dB	Frequency, MHz	Cable loss, dB
10	0.09	9500	4.29	21000	6.67
100	0.41	10000	4.40	22000	6.92
500	0.93	10500	4.52	23000	7.00
1000	1.33	11000	4.64	24000	7.18
1500	1.63	11500	4.76	25000	7.29
2000	1.90	12000	4.87	26000	7.55
2500	2.12	12500	4.99	27000	7.70
3000	2.33	13000	5.11	28000	7.88
3500	2.50	13500	5.20	29000	8.02
4000	2.67	14000	5.31	30000	8.15
4500	2.82	14500	5.42	31000	8.35
5000	2.99	15000	5.51	32000	8.40
5500	3.16	15500	5.58	33000	8.62
6000	3.32	16000	5.68	34000	8.73
6500	3.51	16500	5.78	35000	8.78
7000	3.65	17000	5.91	36000	8.94
7500	3.79	17500	5.99	37000	9.21
8000	3.92	18000	6.07	38000	9.37
8500	4.04	19000	6.36	39000	9.45
9000	4.18	20000	6.49	40000	9.52



**Cable loss**  
**Test cable, Mini-Circuits, S/N 70047, 18 GHz, 1.8 m, SMA/M - N/M**  
**CBL-6FT-SMNM+, HL 4274**

Frequency, MHz	Cable loss, dB	Frequency, MHz	Cable loss, dB	Frequency, MHz	Cable loss, dB	Frequency, MHz	Cable loss, dB
10	0.07	4800	1.69	9800	2.62	14800	3.42
30	0.11	4900	1.70	9900	2.63	14900	3.39
50	0.14	5000	1.72	10000	2.64	15000	3.38
100	0.21	5100	1.75	10100	2.64	15100	3.40
200	0.26	5200	1.76	10200	2.66	15200	3.41
300	0.30	5300	1.77	10300	2.67	15300	3.40
400	0.37	5400	1.79	10400	2.68	15400	3.39
500	0.44	5500	1.82	10500	2.68	15500	3.41
600	0.49	5600	1.85	10600	2.70	15600	3.44
700	0.54	5700	1.86	10700	2.71	15700	3.46
800	0.58	5800	1.87	10800	2.73	15800	3.45
900	0.63	5900	1.91	10900	2.74	15900	3.47
1000	0.67	6000	1.94	11000	2.76	16000	3.51
1100	0.71	6100	1.97	11100	2.77	16100	3.56
1200	0.75	6200	1.98	11200	2.78	16200	3.55
1300	0.78	6300	1.99	11300	2.79	16300	3.54
1400	0.81	6400	2.02	11400	2.80	16400	3.57
1500	0.85	6500	2.05	11500	2.82	16500	3.62
1600	0.88	6600	2.06	11600	2.83	16600	3.61
1700	0.91	6700	2.06	11700	2.84	16700	3.60
1800	0.94	6800	2.08	11800	2.85	16800	3.62
1900	0.97	6900	2.10	11900	2.87	16900	3.68
2000	1.00	7000	2.12	12000	2.88	17000	3.70
2100	1.03	7100	2.12	12100	2.89	17100	3.68
2200	1.06	7200	2.13	12200	2.90	17200	3.70
2300	1.08	7300	2.16	12300	2.92	17300	3.80
2400	1.11	7400	2.19	12400	2.94	17400	3.84
2500	1.14	7500	2.22	12500	2.95	17500	3.83
2600	1.16	7600	2.23	12600	2.96	17600	3.83
2700	1.19	7700	2.26	12700	2.98	17700	3.86
2800	1.21	7800	2.30	12800	3.00	17800	3.86
2900	1.27	7900	2.33	12900	3.02	17900	3.80
3000	1.29	8000	2.35	13000	3.03	18000	3.79
3100	1.32	8100	2.37	13100	3.06		
3200	1.35	8200	2.41	13200	3.08		
3300	1.37	8300	2.44	13300	3.09		
3400	1.38	8400	2.47	13400	3.10		
3500	1.41	8500	2.48	13500	3.13		
3600	1.43	8600	2.51	13600	3.17		
3700	1.46	8700	2.53	13700	3.17		
3800	1.47	8800	2.55	13800	3.18		
3900	1.49	8900	2.56	13900	3.22		
4000	1.52	9000	2.57	14000	3.26		
4100	1.55	9100	2.58	14100	3.28		
4200	1.56	9200	2.59	14200	3.30		
4300	1.58	9300	2.59	14300	3.35		
4400	1.60	9400	2.60	14400	3.39		
4500	1.63	9500	2.60	14500	3.39		
4600	1.65	9600	2.61	14600	3.39		
4700	1.67	9700	2.61	14700	3.41		



**Cable loss**  
**Test cable, Mini-Circuits, S/N 0757A, 18 GHz, 4.6 m, N/M - N/M**  
**APC-15FT-NMNM+, HL 4279**

Frequency, MHz	Cable loss, dB	Frequency, MHz	Cable loss, dB	Frequency, MHz	Cable loss, dB	Frequency, MHz	Cable loss, dB
10	0.26	5000	4.23	10200	6.47	15400	8.46
30	0.26	5100	4.28	10300	6.53	15500	8.49
50	0.34	5200	4.32	10400	6.57	15600	8.50
100	0.50	5300	4.37	10500	6.59	15700	8.53
200	0.72	5400	4.41	10600	6.62	15800	8.56
300	0.90	5500	4.46	10700	6.64	15900	8.60
400	1.05	5600	4.51	10800	6.66	16000	8.62
500	1.20	5700	4.57	10900	6.69	16100	8.65
600	1.31	5800	4.61	11000	6.69	16200	8.68
700	1.44	5900	4.64	11100	6.70	16300	8.70
800	1.53	6000	4.70	11200	6.72	16400	8.72
900	1.63	6100	4.75	11300	6.74	16500	8.76
1000	1.74	6200	4.76	11400	6.79	16600	8.77
1100	1.83	6300	4.82	11500	6.83	16700	8.78
1200	1.92	6400	4.83	11600	6.85	16800	8.82
1300	2.01	6500	4.88	11700	6.89	16900	8.85
1400	2.09	6600	4.90	11800	6.94	17000	8.91
1500	2.17	6700	4.95	11900	7.00	17100	8.94
1600	2.25	6800	5.01	12000	7.04	17200	8.98
1700	2.33	6900	4.98	12100	7.10	17300	9.03
1800	2.39	7000	5.03	12200	7.18	17400	9.05
1900	2.47	7100	5.11	12300	7.23	17500	9.08
2000	2.53	7200	5.13	12400	7.29	17600	9.10
2100	2.60	7300	5.20	12500	7.34	17700	9.12
2200	2.67	7400	5.28	12600	7.39	17800	9.14
2300	2.74	7500	5.33	12700	7.45	17900	9.17
2400	2.80	7600	5.37	12800	7.49	18000	9.21
2500	2.87	7700	5.44	12900	7.53		
2600	2.92	7800	5.52	13000	7.58		
2700	3.00	7900	5.56	13100	7.62		
2800	3.06	8000	5.63	13200	7.67		
2900	3.12	8100	5.67	13300	7.71		
3000	3.18	8200	5.71	13400	7.74		
3100	3.24	8300	5.76	13500	7.79		
3200	3.30	8400	5.79	13600	7.82		
3300	3.35	8500	5.85	13700	7.84		
3400	3.41	8600	5.88	13800	7.87		
3500	3.46	8700	5.92	13900	7.90		
3600	3.51	8800	5.96	14000	7.94		
3700	3.56	8900	6.02	14100	7.98		
3800	3.61	9000	6.05	14200	8.01		
3900	3.66	9100	6.08	14300	8.05		
4000	3.71	9200	6.15	14400	8.10		
4100	3.77	9300	6.18	14500	8.12		
4200	3.83	9400	6.20	14600	8.16		
4300	3.89	9500	6.25	14700	8.22		
4400	3.94	9600	6.28	14800	8.26		
4500	3.99	9700	6.31	14900	8.29		
4600	4.05	9800	6.35	15000	8.33		
4700	4.09	9900	6.37	15100	8.39		
4800	4.15	10000	6.40	15200	8.41		
4900	4.19	10100	6.45	15300	8.44		





**Cable loss**  
**Microwave Cable Assembly, 18.0 GHz, 3.4 m, SMA/SMA, Huber-Suhner,**  
**Sucoflex P103, HL 4294**

Frequency, MHz	Cable loss, dB	Frequency, MHz	Cable loss, dB	Frequency, MHz	Cable loss, dB	Frequency, MHz	Cable loss, dB
10	0.11	4900	2.09	10000	2.90	15100	3.61
30	0.17	5000	2.10	10100	2.92	15200	3.67
50	0.22	5100	2.14	10200	2.95	15300	3.63
100	0.30	5200	2.16	10300	2.96	15400	3.64
200	0.42	5300	2.17	10400	2.99	15500	3.68
300	0.51	5400	2.19	10500	2.99	15600	3.71
400	0.59	5500	2.19	10600	3.03	15700	3.74
500	0.66	5600	2.22	10700	3.03	15800	3.71
600	0.72	5700	2.24	10800	3.04	15900	3.74
700	0.77	5800	2.23	10900	3.05	16000	3.71
800	0.82	5900	2.26	11000	3.09	16100	3.73
900	0.88	6000	2.27	11100	3.07	16200	3.76
1000	0.93	6100	2.26	11200	3.08	16300	3.82
1100	0.98	6200	2.29	11300	3.11	16400	3.90
1200	1.02	6300	2.30	11400	3.12	16500	3.81
1300	1.06	6400	2.34	11500	3.11	16600	3.88
1400	1.10	6500	2.34	11600	3.15	16700	3.87
1500	1.14	6600	2.36	11700	3.16	16800	3.89
1600	1.19	6700	2.36	11800	3.18	16900	3.95
1700	1.23	6800	2.39	11900	3.19	17000	4.02
1800	1.27	6900	2.39	12000	3.23	17100	4.04
1900	1.30	7000	2.44	12100	3.25	17200	3.99
2000	1.35	7100	2.46	12200	3.22	17300	4.03
2100	1.38	7200	2.44	12300	3.25	17400	4.03
2200	1.42	7300	2.48	12400	3.25	17500	4.06
2300	1.45	7400	2.47	12500	3.28	17600	4.05
2400	1.48	7500	2.48	12600	3.27	17700	4.12
2500	1.51	7600	2.50	12700	3.27	17800	4.14
2600	1.55	7700	2.53	12800	3.30	17900	4.18
2700	1.59	7800	2.56	12900	3.30	18000	4.14
2800	1.62	7900	2.55	13000	3.27		
2900	1.65	8000	2.56	13100	3.32		
3000	1.66	8100	2.56	13200	3.32		
3100	1.69	8200	2.57	13300	3.32		
3200	1.71	8300	2.59	13400	3.35		
3300	1.74	8400	2.62	13500	3.38		
3400	1.76	8500	2.67	13600	3.39		
3500	1.78	8600	2.65	13700	3.42		
3600	1.80	8700	2.68	13800	3.47		
3700	1.85	8800	2.68	13900	3.45		
3800	1.88	8900	2.68	14000	3.49		
3900	1.90	9000	2.74	14100	3.50		
4000	1.91	9100	2.74	14200	3.55		
4100	1.93	9200	2.76	14300	3.59		
4200	1.96	9300	2.78	14400	3.58		
4300	1.97	9400	2.79	14500	3.56		
4400	1.99	9500	2.80	14600	3.57		
4500	2.02	9600	2.83	14700	3.57		
4600	2.02	9700	2.84	14800	3.57		
4700	2.04	9800	2.86	14900	3.64		
4800	2.05	9900	2.92	15000	3.64		



**Cable loss**  
**Low Loss Armored Test Cable, MegaPhase, 18 GHz, 6.2 m, N type-M/N type-M,**  
**NC29-N1N1-244S/N 12025101 003,**  
**HL 4353**

Frequency, MHz	Cable loss, dB	Frequency, MHz	Cable loss, dB
50	0.20	9000	2.71
100	0.27	9500	2.81
300	0.47	10000	2.90
500	0.61	10500	2.97
1000	0.87	11000	3.06
1500	1.07	11500	3.13
2000	1.24	12000	3.20
2500	1.39	12500	3.26
3000	1.53	13000	3.34
3500	1.65	13500	3.39
4000	1.77	14000	3.47
4500	1.89	14500	3.54
5000	1.99	15000	3.62
5500	2.07	15500	3.69
6000	2.20	16000	3.76
6500	2.30	16500	3.83
7000	2.39	17000	3.86
7500	2.51	17500	3.94
8000	2.58	18000	4.02
8500	2.65		



## 13 APPENDIX F Abbreviations and acronyms

A	ampere
AC	alternating current
A/m	ampere per meter
AVRG	average (detector)
cm	centimeter
dB	decibel
dBm	decibel referred to one milliwatt
dB( $\mu$ V)	decibel referred to one microvolt
dB( $\mu$ V/m)	decibel referred to one microvolt per meter
dB( $\mu$ A)	decibel referred to one microampere
DC	direct current
EIRP	equivalent isotropically radiated power
ERP	effective radiated power
EUT	equipment under test
F	frequency
GHz	gigahertz
GND	ground
H	height
HL	Hermon laboratories
Hz	hertz
k	kilo
kHz	kilohertz
LO	local oscillator
m	meter
MHz	megahertz
min	minute
mm	millimeter
ms	millisecond
$\mu$ s	microsecond
NA	not applicable
OATS	open area test site
$\Omega$	Ohm
PS	power supply
ppm	part per million ( $10^{-6}$ )
QP	quasi-peak
RE	radiated emission
RF	radio frequency
rms	root mean square
Rx	receive
s	second
T	temperature
Tx	transmit
V	volt

END OF DOCUMENT