

# Test Report of FCC Part 15 C for FCC Certificate

On Behalf of

## Shenzhen SQT Electronics CO.,Ltd.

**FCC ID:** WOXSMT-78507GLMN  
**Product Description:** 2.4GHz Wireless Laser Mouse  
**Model No.:** SM-507AGL  
**Supplementary Model No.:** SM-503AGL,SMK-78507AGK,SMK-99507AGL,SMK-99503AGL,SMK-78503AGL

**Prepared for:** **Shenzhen SQT Electronics CO.,Ltd.**  
ZhengChengFeng TechnologyZone Xinsha Road,ShaYi Village, Sha jing Town, Baoan Area, Shenzhen, China

**Prepared by:** **Bontek Compliance Testing Laboratory Co., Ltd.**  
1/F, Block East H-3, OCT Eastern Ind. Zone, Qiaocheng East Road, Nanshan, Shenzhen, China  
Tel: 86-755-86337020  
Fax: 86-755-86337028

**Report No.:** BCT12LR407E

**Issue Date:** February 20, 2013

**Test Date:** December 29,2012~ January 27, 2013

**Tested by:**

*Lion Cai*

Lion Cai

**Reviewed by:**

*Kendy Wang*

Kendy Wang

**Approved by:**

*Tony Wu*

Tony Wu

**TABLE OF CONTENTS**

- 1. GENERAL INFORMATION ..... 3**
  - 1.1 Client Information.....3
  - 1.2 Related Submittal(s) / Grant (s).....3
  - 1.3 Test Methodology .....3
  - 1.4 Test Facility.....4
- 2. SYSTEM TEST CONFIGURATION..... 5**
  - 2.1 EUT Configuration .....5
  - 2.2 EUT Exercise .....5
  - 2.3 General Test Procedures .....5
  - 2.4 List of Measuring Equipments .....6
- 3. SUMMARY OF TEST RESULTS..... 8**
- 4. TEST OF CONDUCTED EMISSION ..... 9**
  - 4.1 Applicable Standard.....9
  - 4.2 Test Setup Diagram.....9
- 5. BAND EDGES MEASUREMENT ..... 10**
  - 5.1 Limit of Band Edges Measurement .....10
  - 5.2 Radiate EUT Setup .....10
  - 5.3 Test Procedure .....11
  - 5.4 Test Result.....11
- 6. SPURIOUS EMISSIONS..... 14**
  - 6.1 Limit of Spurious Emissions .....14
  - 6.2 EUT Setup .....15
  - 6.3 Test Procedure .....16
  - 6.4 Spurious Emissions Test Result.....17
- 7. ANTENNA REQUIREMENT ..... 27**
  - 7.1 Standard Applicable.....27
  - 7.2 Antenna Connected Construction .....27

# 1. GENERAL INFORMATION

## 1.1 Client Information

Applicant: **Shenzhen SQT Electronics CO.,Ltd.**  
Address of applicant: ZhengChengFeng TechnologyZone Xinsha Road,ShaYi Village, Sha jing Town, Baoan Area, Shenzhen, China  
Manufacturer: **Shenzhen SQT Electronics CO.,Ltd.**  
Address of manufacturer: ZhengChengFeng TechnologyZone Xinsha Road,ShaYi Village, Sha jing Town, Baoan Area, Shenzhen, China

## General Description of E.U.T

Items	Description
EUT Description:	2.4GHz Wireless Laser Mouse
Trade Name:	N/A
Model No.:	SM-507AGL
Supplementary Model No.:	SM-503AGL,SMK-78507AGK,SMK-99507AGL, SMK-99503AGL,SMK-78503AGL
Frequency Band:	2408 MHz ~ 2474 MHz
Number of Channels:	34
Channel Bandwidth:	2 MHz
Antenna Type:	Built-in Antenna
Rated Voltage:	1.5 V DC from battery

*Remark\* The test data gathered are from the production sample provided by the manufacturer.  
Supplementary models have the same circuit, but with different appearance*

## 1.2 Related Submittal(s) / Grant (s)

This submittal(s) is a test report based on the Electromagnetic Interference (EMI) tests performed on the EUT. The EMI measurements were performed according to the measurement procedure described in ANSI C63.4 - 2003.

The tests were performed in order to determine compliance with Section 15.107 and 15.109 under the FCC Rules Part 15 Subpart B and Section 15.207, 15.209,15.249 under the FCC Rules Part 15 Subpart C.

## 1.3 Test Methodology

Both conducted and radiated testing were performed according to the procedures in ANSI C63.4 - 2003, American National Standard for Methods of Measurement of Radio-Noise Emissions from Low-Voltage Electrical and Electronic Equipment in the range of 9 kHz to 40 GHz. Radiated testing was performed at an antenna to EUT distance 3 meters.

## 1.4 Test Facility

All measurement required was performed at laboratory of Bontek Compliance Testing Laboratory Co., Ltd at 1/F, Block East H-3, OCT Eastern Ind. Zone, Qiaocheng East Road, Nanshan, Shenzhen, China.

The test facility is recognized, certified, or accredited by the following organizations:

### **FCC – Registration No.: 338263**

Shenzhen Bontek Compliance Testing Laboratory Co., Ltd. EMC Laboratory has been registered and fully described in a report filed with the (FCC) Federal Communications Commission. The acceptance letter from the FCC is maintained in our files. Registration 338263, March, 2011

### **IC Registration No.: 7631A**

The 3m alternate test site of Shenzhen Bontek Compliance Testing Laboratory Co., Ltd. EMC Laboratory has been registered by Certification and Engineer Bureau of Industry Canada for the performance of with Registration NO.: 7631A on January, 2011. The facility also complies with the radiated and AC line conducted test site criteria set forth in ANSI C63.4-2003.

### **CNAS – Registration No.: L3923**

Shenzhen Bontek Compliance Testing Laboratory Co., Ltd. To ISO/IEC 17025:25 General Requirements for the Competence of Testing and Calibration Laboratories(CNAS-CL01 Accreditation Criteria for the Competence of Testing and Calibration Laboratories) for the competence in the field of testing. The acceptance letter from the CNAS is maintained in our files: Registration: L3923, March, 2012.

### **TUV – Registration No.: 50242657-0001**

Shenzhen Bontek Compliance Testing Laboratory Co., Ltd. An assessment of the laboratory was conducted according to the "Procedures and Conditions for EMC Test Laboratories" with reference to EN ISO/IEC 17025 by a TUV Rheinland auditor. Audit Report NO. 17010783-003

## **2. SYSTEM TEST CONFIGURATION**

The tests documented in this report were performed in accordance with ANSI C63.4-2003 and FCC CFR 47 Part 15 Subpart C.

### **2.1 EUT Configuration**

The EUT configuration for testing is installed on RF field strength measurement to meet the Commissions requirement and operating in a manner that intends to maximize its emission characteristics in a continuous transmitting application.

### **2.2 EUT Exercise**

The calibrated antennas used to sample the radiated field strength are mounted on a non-conductive, motorized antenna mast 3 or 10 meters from the leading edge of the turntable.

### **2.3 General Test Procedures**

**Conducted Emissions** The EUT is placed on the turntable, which is 0.8 m above ground plane. According to the requirements in Section 7.1 of ANSI C63.4-2003. Conducted emissions from the EUT measured in the frequency range between 0.15 MHz and 30MHz using CISPR Quasi-Peak detector mode. But the EUT is powered by DC 1.5V of battery, this test is not applicable.

**Radiated Emissions** The EUT is a placed on as turntable, which is 0.8 m above ground plane. The turntable shall rotate 360 degrees to determine the position of maximum emission level. EUT is set 3m away from the receiving antenna, which varied from 1m to 4m to find out the highest emission. And also, each emission was to be maximized by changing the polarization of receiving antenna both horizontal and vertical. In order to find out the maximum emissions, exploratory radiated emission measurements were made according to the requirements in Section 13.1.4.1 of ANSI C63.4-2003.

## 2.4 List of Measuring Equipments

No.	Instrument no.	Equipment	Manufacturer	Model No.	S/N	Last Calculator	Due Calculator
1	BCT-EMC001	EMI Test Receiver	R&S	ESCI	100687	2012-4-17	2013-4-16
2	BCT-EMC002	EMI Test Receiver	R&S	ESPI	100097	2012-11-1	2013-10-31
3	BCT-EMC003	Amplifier	HP	8447D	1937A02492	2012-4-20	2013-4-19
4	BCT-EMC004	Single Power Conductor Module	R&S	NNBM 8124	242	2012-4-20	2013-4-19
5	BCT-EMC005	Single Power Conductor Module	R&S	NNBM 8124	243	2012-4-20	2013-4-19
6	BCT-EMC006	Power Clamp	SCHWARZBECK	MDS-21	3812	2012-11-5	2013-11-4
7	BCT-EMC007	Positioning Controller	C&C	CC-C-1F	MF7802113	N/A	N/A
8	BCT-EMC008	Electrostatic Discharge Simulator	TESEQ	NSG437	125	2012-11-2	2013-11-1
9	BCT-EMC009	Fast Transient Burst Generator	SCHAFFNER	MODULA6150	34572	2012-4-17	2013-4-16
10	BCT-EMC010	Fast Transient Noise Simulator	Noiseken	FNS-105AX	10501	2012-6-26	2013-6-25
11	BCT-EMC011	Color TV Pattern Generator	PHILIPS	PM5418	TM209947	N/A	N/A
12	BCT-EMC012	Power Frequency Magnetic Field Generator	EVERFINE	EMS61000-8K	608002	2012-4-17	2013-4-16
14	BCT-EMC014	Capacitive Coupling Clamp	TESEQ	CDN8014	25096	2012-4-17	2013-4-16
15	BCT-EMC015	High Field Biconical Antenna	ELECTRO-METRICS	EM-6913	166	2011-11-28	2013-11-27
16	BCT-EMC016	Log Periodic Antenna	ELECTRO-METRICS	EM-6950	811	2011-11-28	2013-11-27
17	BCT-EMC017	Remote Active Vertical Antenna	ELECTRO-METRICS	EM-6892	304	2011-11-28	2013-11-27
18	BCT-EMC018	TRILOG Broadband Test-Antenna	SCHWARZBECK	VULB9163	9163-324	2012-5-19	2014-5-18
19	BCT-EMC019	Horn Antenna	SCHWARZBECK	BBHA9120A	0499	2011-11-28	2013-11-27
20	BCT-EMC020	Teo Line Single Phase Module	SCHWARZBECK	NSLK8128	8128247	2012-11-1	2013-10-31
21	BCT-EMC021	Triple-Loop Antenna	EVERFINE	LLA-2	711002	2012-11-15	2013-11-14
22	BCT-EMC022	Electric bridge	Jhai	JK2812C	803024	N/A	N/A
23	BCT-EMC026	RF POWER AMPLIFIER	FRANKONIA	FLL-75	1020A1109	2012-4-17	2013-4-16

24	BCT-EMC027	CDN	FRANKONIA	CDN M2+M3	A3027019	2012-4-17	2013-4-16
25	BCT-EMC029	6DB Attenuator	FRANKONIA	N/A	1001698	2012-4-17	2013-4-16
26	BCT-EMC030	EM Injection clamp	FCC	F-203I-23mm	091536	2012-4-17	2013-4-16
27	BCT-EMC031	9kHz-2.4GHz signal generator 2024	MARCONI	10S/6625-99-457-8730	112260/042	2012-4-17	2013-4-16
28	BCT-EMC032	10dB attenuator	ELECTRO-METRICS	EM-7600	836	2012-4-17	2013-4-16
29	BCT-EMC033	ISN	TESEQ	ISN-T800	30301	2012-11-15	2013-11-14
30	BCT-EMC034	10KV surge generator	SANKI	SKS-0510M	048110003E321	2012-11-01	2013-10-31
31	BCT-EMC035	HRMONICS&FLICKRE ANALYSER	VOLTECH	PM6000	200006700433	2012-11-20	2013-11-19
32	BCT-EMC036	Spectrum Analyzer	R&S	FSP	100397	2012-11-1	2013-10-31
33	BCT-EMC037	Broadband preamplifier	SCHWARZBECK	BBV9718	9718-182	2012-4-20	2013-4-19
34	BCT-EMC038	Horn Antenna	SCHWARZBECK	BBHA9170	0483	2012-4-6	2013-4-5

### 3. SUMMARY OF TEST RESULTS

EUT Fundamental Frequency	FCC Rules	Description of Test	Result
2.408~2.474 GHz	15.207	Disturbance Voltage at The Mains Terminals	N/A , without AC main
	15.249	Band Edges Measurement	Pass
	15.249	Spurious Emission	Pass
	15.203	Antenna Requirement	Pass



## 4. TEST OF CONDUCTED EMISSION

### 4.1 Applicable Standard

Section 15.207: For a Low-power Radio-frequency Device is designed to be connected to the AC power line, the radio frequency voltage that is conducted back onto the AC power line on any frequency or frequencies within the band 150 kHz to 30 MHz shall not exceed below limits table.

Frequency Range (MHz)	Limits ( dBuV)	
	Quasi-Peak	Average
0.150~0.500	66~56	56~46
0.500~5.000	56	46
5.000~30.00	60	50

### 4.2 Test Setup Diagram

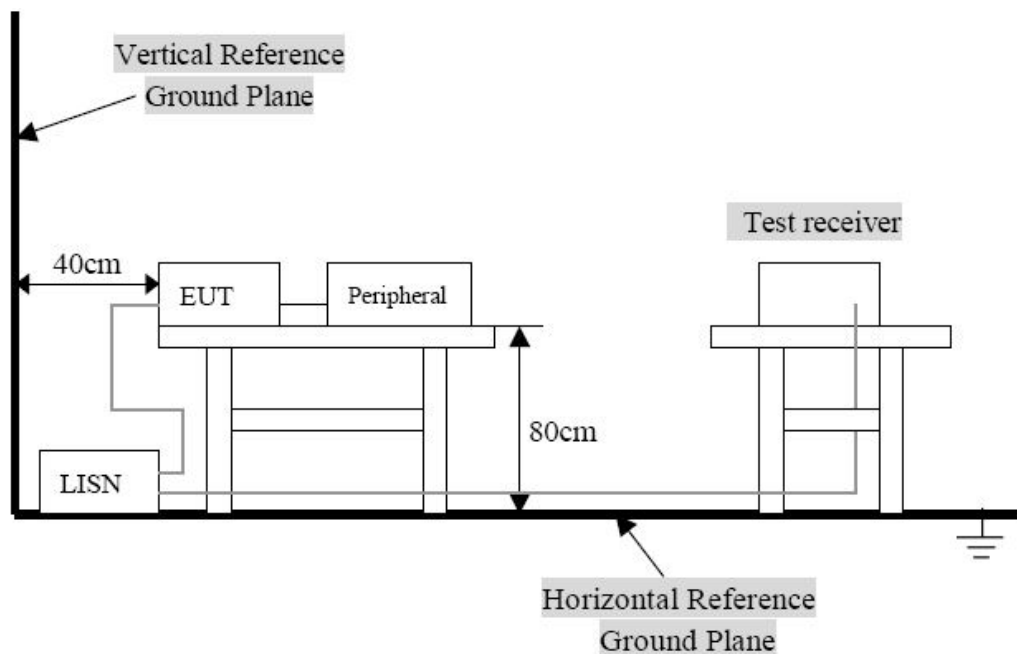

Remark: 1. The setup of EUT is according with per ANSI C63.4-2003 measurement procedure. The specification used was with the FCC 15.207 limits.

2. The EUT was charged on the base, and the base was connected to a 120 VAC/ 60Hz power source.

**Notes:** The EUT is powered by DC 1.5V from battery without AC mains, this test is unapplicable.

## 5. BAND EDGES MEASUREMENT

### 5.1 Limit of Band Edges Measurement

1. In the above emission table, the tighter limit applies at the band edges.
2. As shown in Section 15.35(b), for frequencies above 1000 MHz, the above field strength limits in paragraphs (a) and (b) of this section are based on average limits. However, the peak field strength of any emission shall not exceed the maximum permitted average limits specified above by more than 20 dB under any condition of modulation. For point-to-point operation under paragraph (b) of this section, the peak field strength shall not exceed 2500 millivolts/meter at 3 meters along the antenna azimuth.

Frequency (MHz)	Field Strength ( $\mu\text{V}/\text{m}$ at 3-meter)	Field Strength ( $\text{dB}\mu\text{V}/\text{m}$ at 3-meter)
30-88	100	40
88-216	150	43.5
216-960	200	46
Above 960	500	54

Note: (1) The tighter limit shall apply at the edge between two frequency bands.

- (2) The emission limits shown in the above table are based on measurement employing a CISPR quasi-peak detector and above 1000MHz are based on measurements employing an average detector.

### 5.2 Radiate EUT Setup

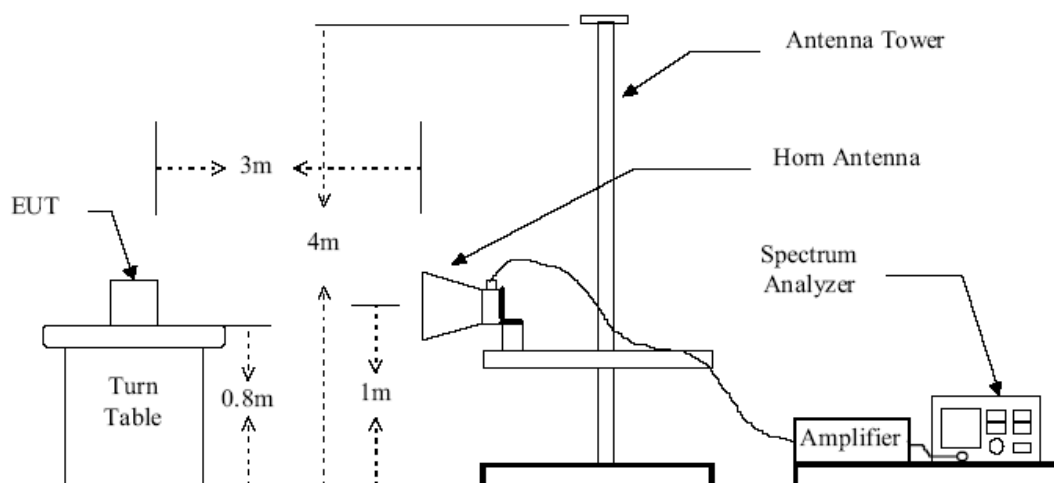

Figure 2 : Frequencies measured above 1 GHz configuration

### 5.3 Test Procedure

Maximizing procedure was performed on the highest emissions to ensure that the EUT complied with all installation combinations.

- 1). Configure the EUT according to ANSI C63.4:2003.
- 2). The EUT was placed on the top of the turntable 0.8 meter above ground.
- 3). The receiving antenna was placed 3 meters far away from the turntable.
- 4). The turntable was rotated by 360 degrees to determine the position of the highest radiation.
- 5). The height of the broadband receiving antenna was varied between one meter and four meters above ground to find the maximum emission field strength of both horizontal and vertical polarization. For each suspected emission, the antenna tower was scanned (from 1 M to 4 M) and then the turntable was rotated (from 0 degree to 360 degrees) to find the maximum reading.

### 5.4 Test Result

Temperature ( °C ) : 22~23	EUT: 2.4GHz Wireless Laser Mouse
Humidity (%RH) : 50~54	M/N: SM-507AGL
Barometric Pressure ( mbar ) : 950~1000	Operation Condition: Continuous transmitting

Frequency (MHz)	Antenna Polarization	Emission Read Value (dBµV/m)	Limits (dBµV/m)
2338.15	H	32.55	54
2491.30	H	32.67	54

Frequency (MHz)	Antenna Polarization	Emission Read Value (dBµV/m)	Limits (dBµV/m)
2338.15	V	32.12	54
2491.30	V	32.45	54

### CH Low (2408-Peak)

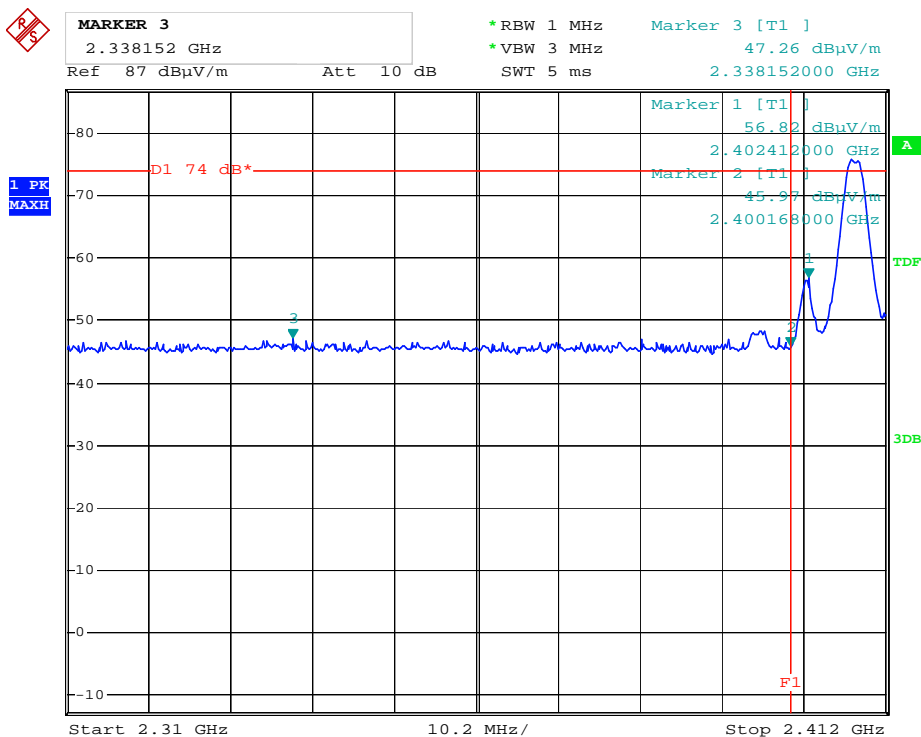

### CH Low (2408- Average)

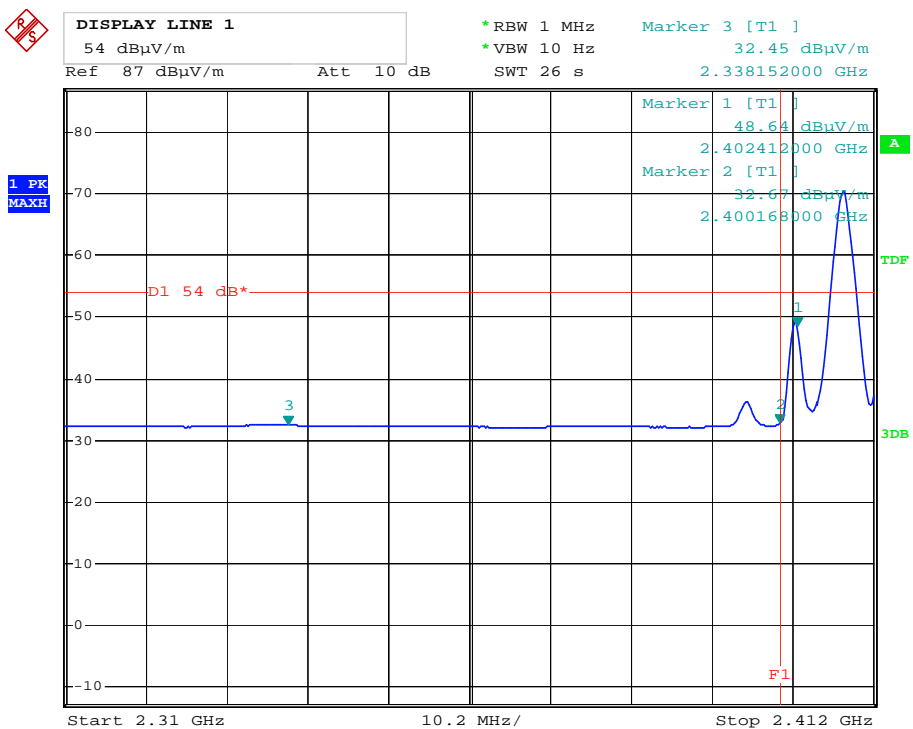

### CH High (2474-Peak)

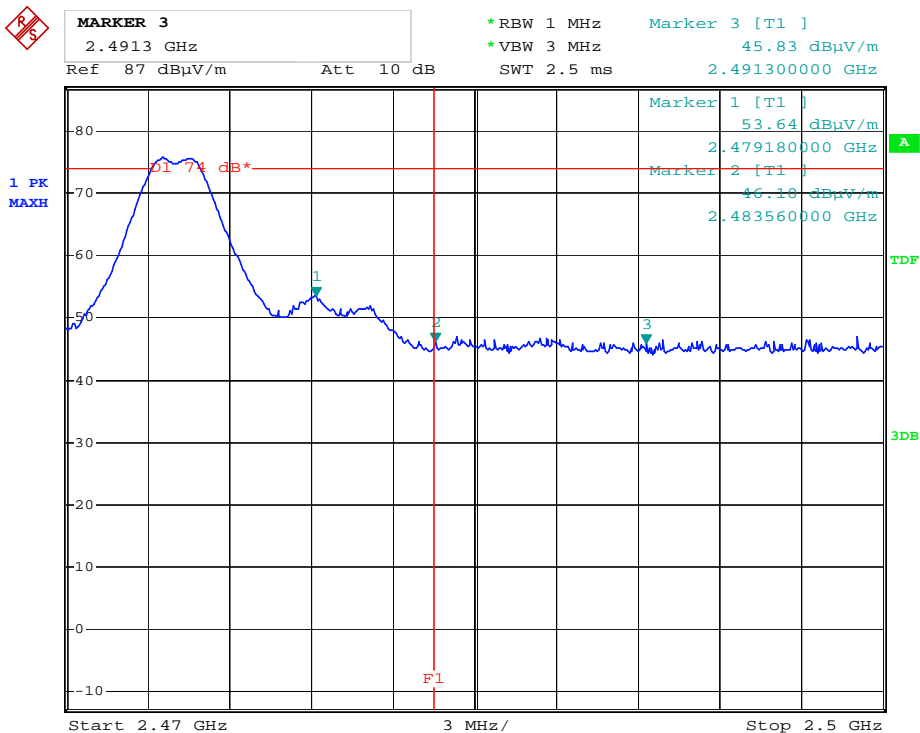

### CH High (2474- Average)

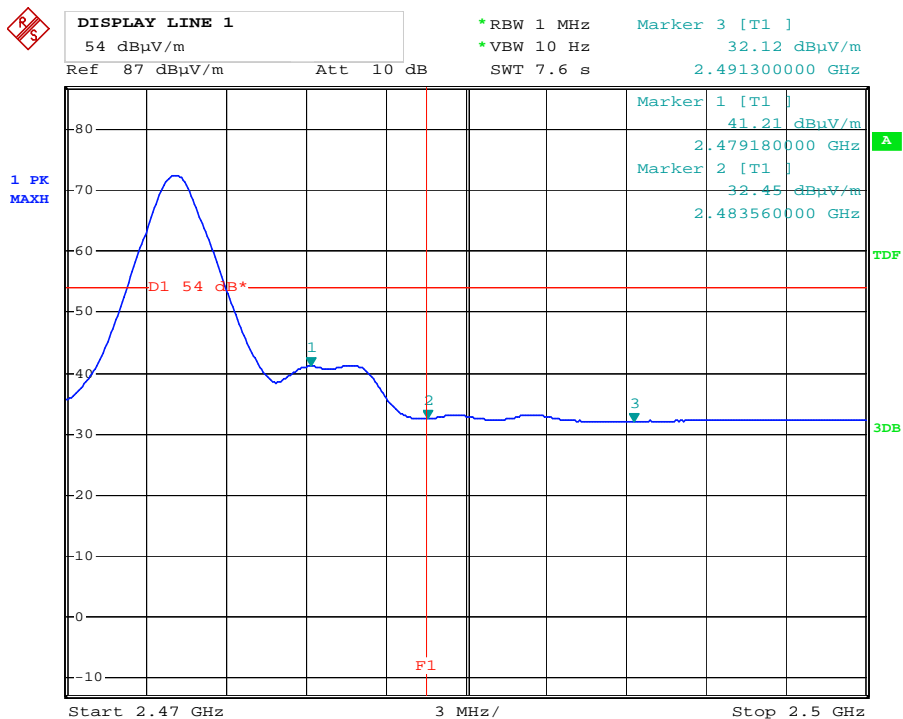

## 6. SPURIOUS EMISSIONS

### 6.1 Limit of Spurious Emissions

1. In the section 15.249(a): Except as provided in paragraph (b) of this section, the field strength of emissions from intentional radiators operated within these frequency bands shall comply with the following:
2. Except as provided elsewhere in this Subpart, the emissions from an intentional radiator shall not exceed the field strength levels specified in the following table:

Fundamental Frequency (MHz)	Field Strength of Fundamental Field Strength (mV/m)	Field Strength of Harmonics ( $\mu\text{V/m}$ )
902-928 MHz	50	500
2400 - 2483.5 MHz	50	500
5725 - 5875 MHz	50	500
24.0 - 24.25 GHz	250	2500

Frequency (MHz)	Field Strength ( $\mu\text{V/m}$ )	Measurement Distance (m)
30-88	100*	3
88-216	150*	3
216-960	200*	3
Above 960	500	3

Remark: Except as provided in paragraph (g), fundamental emissions from intentional radiators operating under this Section shall not be located in the frequency bands 54-72 MHz, 76-88 MHz, 174-216 MHz or 470-806 MHz. However, operation within these frequency bands is permitted under other sections of this Part, e.g., Sections 15.231 and 15.241.

3. In the above emission table, the tighter limit applies at the band edges.

Frequency (MHz)	Field Strength ( $\mu\text{V/m}$ at 3-meter)	Field Strength (dB $\mu\text{V/m}$ at 3-meter)
30-88	100	40
88-216	150	43.5
216-960	200	46
Above 960	500	54

## 6.2 EUT Setup

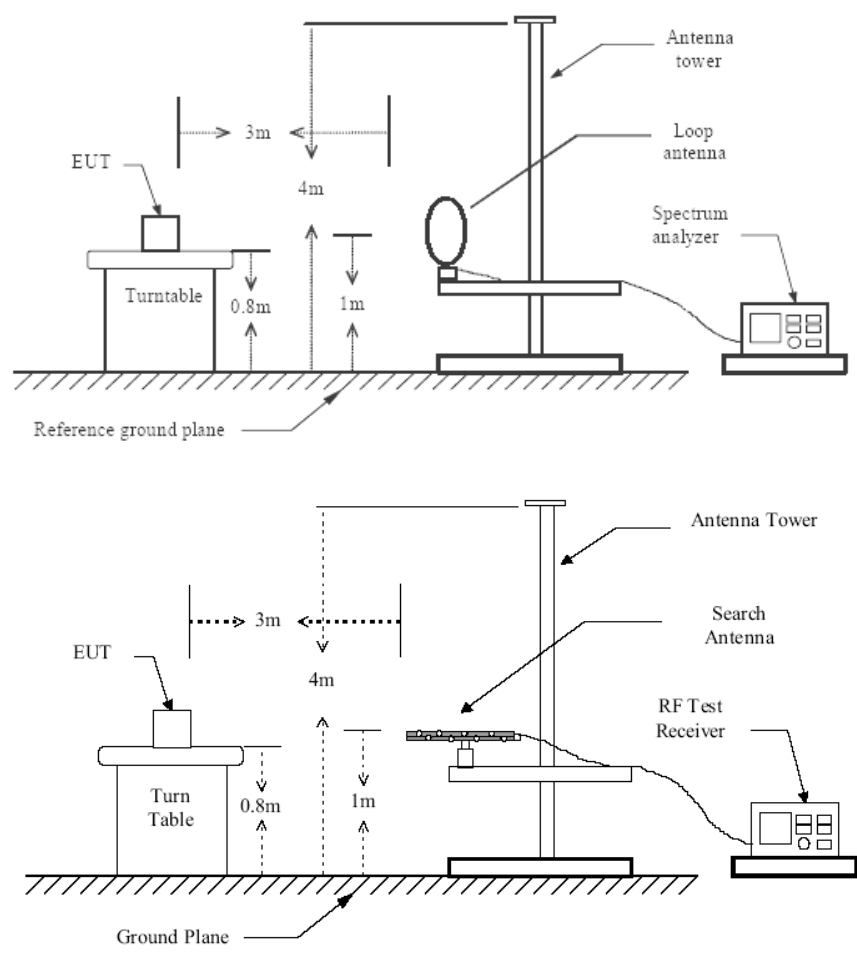

Figure 1 : Frequencies measured below 1 GHz configuration

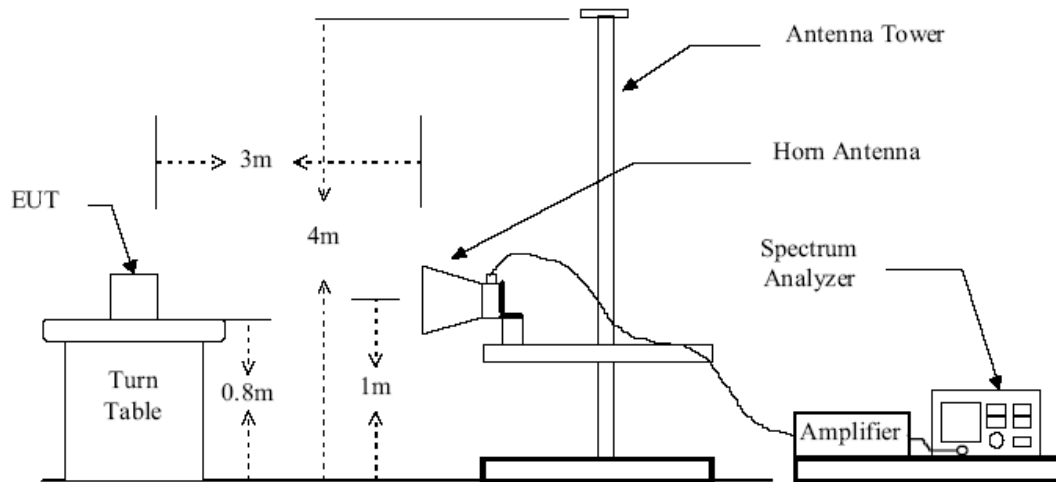

Figure 2 : Frequencies measured above 1 GHz configuration

### 6.3 Test Procedure

Maximizing procedure was performed on the highest emissions to ensure that the EUT complied with all installation combinations.

- 1). Configure the EUT according to ANSI C63.4:2003.
- 2). The EUT was placed on the top of the turntable 0.8 meter above ground.
- 3). The receiving antenna was placed 3 meters far away from the turntable.
- 4). The turntable was rotated by 360 degrees to determine the position of the highest radiation.
- 5). The height of the broadband receiving antenna was varied between one meter and four meters above ground to find the maximum emission field strength of both horizontal and vertical polarization. For each suspected emission, the antenna tower was scanned (from 1 M to 4 M) and then the turntable was rotated (from 0 degree to 360 degrees) to find the maximum reading.



## 6.4 Spurious Emissions Test Result

Temperature ( °C ) : 22~23	EUT: 2.4GHz Wireless Laser Mouse
Humidity (%RH) : 50~54	M/N: SK-078AG
Barometric Pressure ( mbar ) : 950~1000	Operation Condition: Continuous transmitting

Note: In this testing, the EUT was respectively tested in three different orientations. That is:

1. EUT was lie vertically, and then its Antenna oriented upward
2. EUT was lie vertically, and then its Antenna oriented downward
3. EUT was lie flatwise, and then its Antenna oriented to the receiving antenna

The worst test data see following pages

When the EUT was lie flatwise, and its Antenna oriented to the receiving antenna, the worst test data was got as following table.

### WORST-CASE RADIATED EMISSION BELOW 30 MHz

Normal operating Mode:

Frequency	Meter Reading	Antenna Factor	Cable Loss	Emission Levels	Limits	Margin	Detector Mode
(MHz)	(dB $\mu$ V)	(dB/M)	(dB)	(dB $\mu$ V/M)	(dB $\mu$ V/M)	(dB)	PK/QP
0.43	21.05	8.25	1.01	30.31	67	36.69	QP
17.16	21.33	7.57	1.2	30.1	49.5	19.4	QP
21.52	22.28	8.64	1.05	31.97	49.5	17.53	QP
26.72	22.51	7.22	1.69	31.42	49.5	18.08	QP

**The worst Spurious Emission Data Below 1GHz Channel Low:**

EUT: 2.4GHz Wireless Laser Mouse  
M/N: SM-507AGL  
Operating Condition: Continuous transmitting  
Test Site: 3m CHAMBER  
Operator: Chen  
Test Specification: DC 1.5V  
Comment: Polarization: Horizontal  
Tem:25°C Hum:50%

**SWEEP TABLE: "test (30M-1G)"**

Short Description:		Field Strength			
Start	Stop	Detector	Meas. Time	IF Bandw.	Transducer
Frequency	Frequency				
30.0 MHz	1.0 GHz	MaxPeak	Coupled	100 kHz	VULB9163 NEW

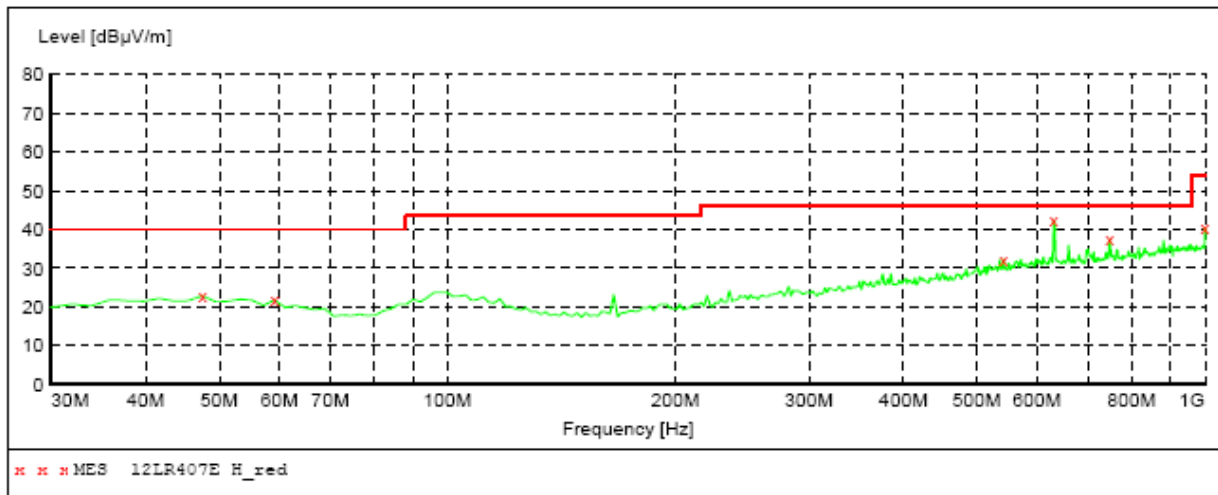

**MEASUREMENT RESULT: "12LR407E H\_red"**

1/12/2013 9:24PM

Frequency MHz	Level dBµV/m	Transd dB	Limit dBµV/m	Margin dB	Det.	Height cm	Azimuth deg	Polarization
47.460000	22.90	15.8	40.0	17.1	QP	100.0	0.00	HORIZONTAL
59.100000	21.80	14.6	40.0	18.2	QP	100.0	0.00	HORIZONTAL
542.160000	32.30	24.8	46.0	13.7	QP	100.0	0.00	HORIZONTAL
631.400000	42.30	26.1	46.0	3.7	QP	100.0	0.00	HORIZONTAL
747.800000	37.50	27.2	46.0	8.5	QP	100.0	0.00	HORIZONTAL
1000.000000	40.50	30.0	54.0	13.5	QP	100.0	0.00	HORIZONTAL

**The worst Spurious Emission Data Below 1GHz Channel Low:**

EUT: 2.4GHz Wireless Laser Mouse  
M/N: SM-507AGL  
Operating Condition: Continuous transmitting  
Test Site: 3m CHAMBER  
Operator: Chen  
Test Specification: DC 1.5V  
Comment: Polarization: Vertical  
Tem:25°C Hum:50%

**SWEEP TABLE: "test (30M-1G)"**

Short Description:		Field Strength			
Start	Stop	Detector	Meas. Time	IF Bandw.	Transducer
Frequency	Frequency				
30.0 MHz	1.0 GHz	MaxPeak	Coupled	100 kHz	VULB9163 NEW

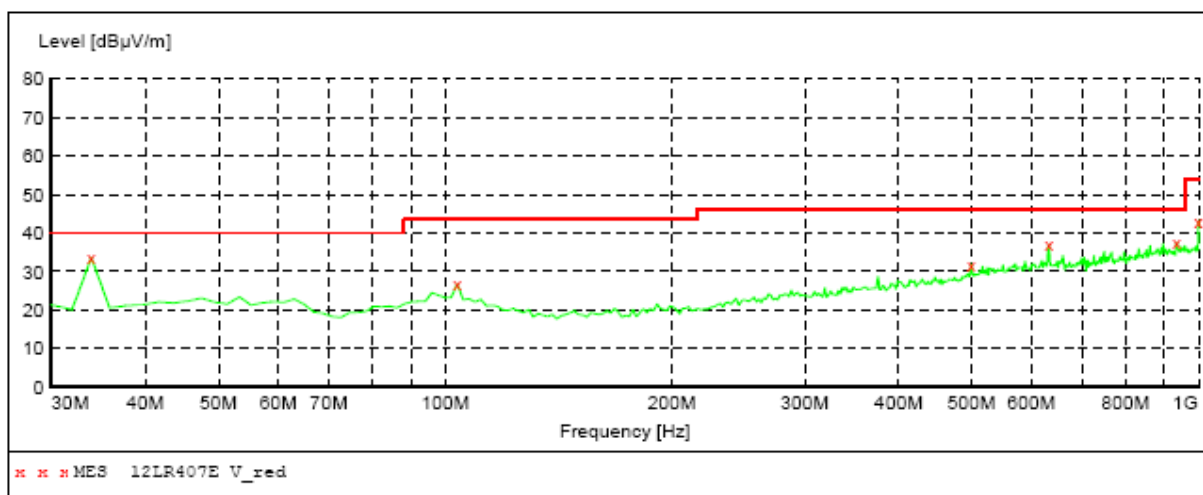

**MEASUREMENT RESULT: "12LR407E V\_red"**

1/12/2013

Frequency MHz	Level dBµV/m	Transd dB	Limit dBµV/m	Margin dB	Det.	Height cm	Azimuth deg	Polarization
33.880000	33.70	14.4	40.0	6.3	QP	100.0	0.00	VERTICAL
103.720000	26.70	17.1	43.5	16.8	QP	100.0	0.00	VERTICAL
499.480000	31.80	23.8	46.0	14.2	QP	100.0	0.00	VERTICAL
633.340000	37.00	26.1	46.0	9.0	QP	100.0	0.00	VERTICAL
935.980000	37.50	29.5	46.0	8.5	QP	100.0	0.00	VERTICAL
1000.000000	43.10	30.0	54.0	10.9	QP	100.0	0.00	VERTICAL

**The worst Spurious Emission Data Below 1GHz Channel Middle:**

EUT: 2.4GHz Wireless Laser Mouse  
M/N: SM-507AGL  
Operating Condition: Continuous transmitting  
Test Site: 3m CHAMBER  
Operator: Chen  
Test Specification: DC 1.5V  
Comment: Polarization: Horizontal  
Tem:25°C Hum:50%

**SWEEP TABLE: "test (30M-1G)"**

Short Description:		Field Strength			
Start	Stop	Detector	Meas. Time	IF Bandw.	Transducer
Frequency	Frequency				
30.0 MHz	1.0 GHz	MaxPeak	Coupled	100 kHz	VULB9163 NEW

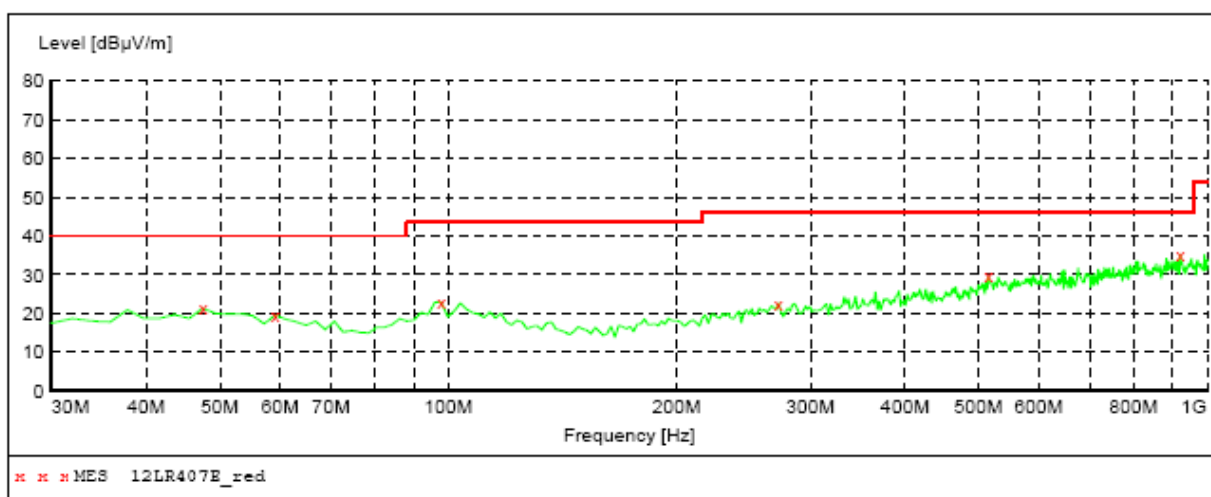

**MEASUREMENT RESULT: "12LR407E\_red"**

1/12/2013

Frequency MHz	Level dBuV/m	Transd dB	Limit dBuV/m	Margin dB	Det.	Height cm	Azimuth deg	Polarization
47.460000	21.30	15.8	40.0	18.7	QP	100.0	0.00	HORIZONTAL
59.100000	19.50	14.6	40.0	20.5	QP	100.0	0.00	HORIZONTAL
97.900000	22.80	17.4	43.5	20.7	QP	100.0	0.00	HORIZONTAL
272.500000	22.60	17.9	46.0	23.4	QP	100.0	0.00	HORIZONTAL
515.000000	29.50	24.2	46.0	16.5	QP	100.0	0.00	HORIZONTAL
922.400000	35.20	29.4	46.0	10.8	QP	100.0	0.00	HORIZONTAL

**The worst Spurious Emission Data Below 1GHz Channel Middle:**

EUT: 2.4GHz Wireless Laser Mouse  
M/N: SM-507AGL  
Operating Condition: Continuous transmitting  
Test Site: 3m CHAMBER  
Operator: Chen  
Test Specification: DC 1.5V  
Comment: Polarization: Vertical  
Tem:25°C Hum:50%

**SWEEP TABLE: "test (30M-1G)"**

Short Description:		Field Strength			
Start	Stop	Detector	Meas. Time	IF Bandw.	Transducer
Frequency	Frequency	MaxPeak	Coupled	100 kHz	VULB9163 NEW
30.0 MHz	1.0 GHz				

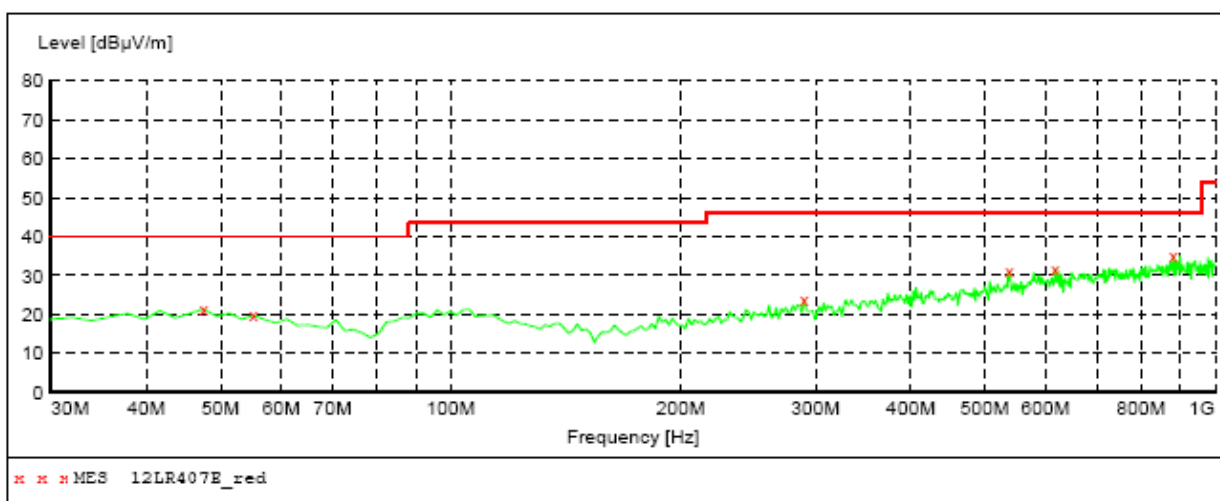

**MEASUREMENT RESULT: "12KR407E\_red"**

1/12/2013

Frequency MHz	Level dBµV/m	Transd dB	Limit dBµV/m	Margin dB	Det.	Height cm	Azimuth deg	Polarization
47.460000	21.40	15.8	40.0	18.6	QP	100.0	0.00	VERTICAL
55.220000	19.80	15.6	40.0	20.2	QP	100.0	0.00	VERTICAL
289.960000	23.90	18.4	46.0	22.1	QP	100.0	0.00	VERTICAL
538.280000	31.10	24.7	46.0	14.9	QP	100.0	0.00	VERTICAL
617.820000	31.70	26.0	46.0	14.3	QP	100.0	0.00	VERTICAL
881.660000	35.30	29.0	46.0	10.7	QP	100.0	0.00	VERTICAL

**The worst Spurious Emission Data Below 1GHz Channel High:**

EUT: 2.4GHz Wireless Laser Mouse  
M/N: SM-507AGL  
Operating Condition: Continuous transmitting  
Test Site: 3m CHAMBER  
Operator: Chen  
Test Specification: DC 1.5V  
Comment: Polarization: Horizontal  
Tem:25°C Hum:50%

**SWEEP TABLE: "test (30M-1G)"**

Short Description:		Field Strength			
Start	Stop	Detector	Meas. Time	IF Bandw.	Transducer
Frequency	Frequency	MaxPeak	Coupled	100 kHz	VULB9163 NEW
30.0 MHz	1.0 GHz				

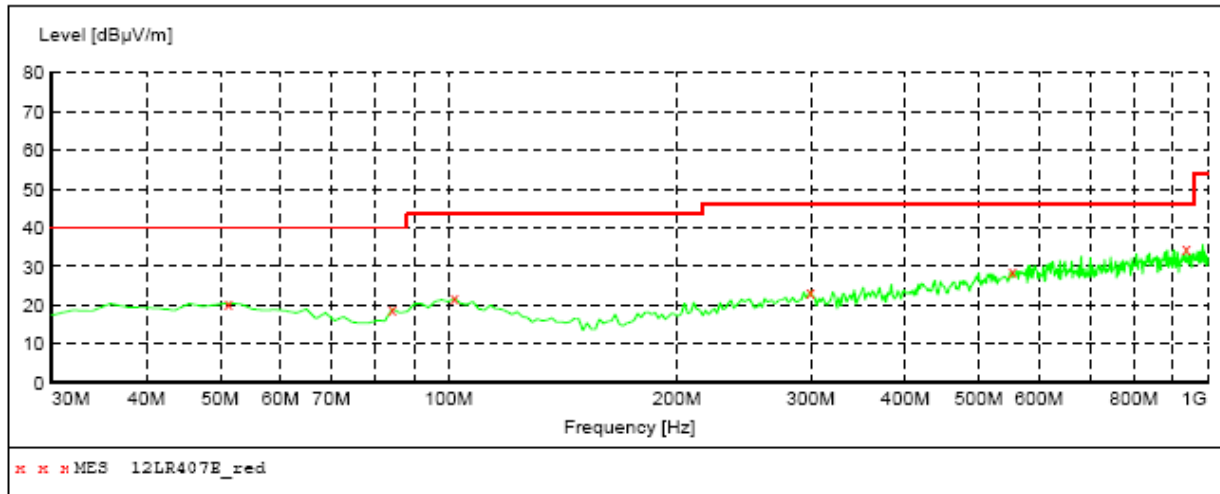

**MEASUREMENT RESULT: "12LR407E\_red"**

1/12/2013

Frequency MHz	Level dBµV/m	Transd dB	Limit dBµV/m	Margin dB	Det.	Height cm	Azimuth deg	Polarization
51.340000	20.60	15.7	40.0	19.4	QP	100.0	0.00	HORIZONTAL
84.320000	19.10	14.1	40.0	20.9	QP	100.0	0.00	HORIZONTAL
101.780000	21.70	17.3	43.5	21.8	QP	100.0	0.00	HORIZONTAL
299.660000	23.60	18.7	46.0	22.4	QP	100.0	0.00	HORIZONTAL
553.800000	28.60	25.1	46.0	17.4	QP	100.0	0.00	HORIZONTAL
937.920000	34.50	29.5	46.0	11.5	QP	100.0	0.00	HORIZONTAL

**The worst Spurious Emission Data Below 1GHz Channel High:**

EUT: 2.4GHz Wireless Laser Mouse  
M/N: SM-507AGL  
Operating Condition: Continuous transmitting  
Test Site: 3m CHAMBER  
Operator: Chen  
Test Specification: DC 1.5V  
Comment: Polarization: Vertical  
Tem:25°C Hum:50%

**SWEEP TABLE: "test (30M-1G)"**

Short Description:		Field Strength			
Start	Stop	Detector	Meas. Time	IF Bandw.	Transducer
Frequency	Frequency	MaxPeak	Coupled	100 kHz	VULB9163 NEW
30.0 MHz	1.0 GHz				

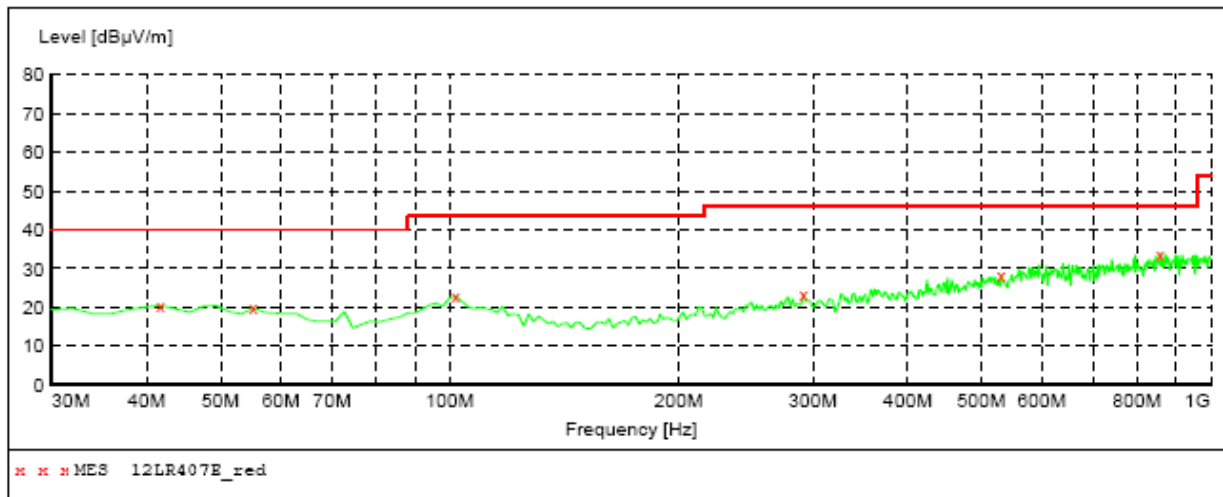

**MEASUREMENT RESULT: "12LR407E\_red"**

1/12/2013

Frequency MHz	Level dBµV/m	Transd dB	Limit dBµV/m	Margin dB	Det.	Height cm	Azimuth deg	Polarization
41.640000	20.50	15.9	40.0	19.5	QP	100.0	0.00	VERTICAL
55.220000	19.80	15.6	40.0	20.2	QP	100.0	0.00	VERTICAL
101.780000	23.00	17.3	43.5	20.5	QP	100.0	0.00	VERTICAL
291.900000	23.50	18.5	46.0	22.5	QP	100.0	0.00	VERTICAL
530.520000	28.50	24.6	46.0	17.5	QP	100.0	0.00	VERTICAL
858.380000	33.90	28.7	46.0	12.1	QP	100.0	0.00	VERTICAL

**The worst Spurious Emission Data above 1GHz Channel Low**

Channel Low (2408MHz)								
Maximum Frequency (MHz)	Polarity and Level					Limit (dBµV/m)	Margin (dBµV/m)	Mark (P/Q/A)
	Polarity	Height (m)	Reading dBµV	Transd	Result dBµV/m			
2408	H	1	98.85	-6.5	92.35	114	-21.65	P
			85.08	-6.49	78.59	94	-15.41	A
2408	V	1	93.54	-6.5	87.04	114	-26.96	P
			86.21	-7.22	78.99	94	-15.01	A
2680	H	1	49.08	-5.52	43.56	74	-30.44	P
			39.15	-7.06	32.09	54	-21.91	A
2995	V	1	47.36	-4.26	43.1	74	-30.9	P
			38.25	-7.34	30.91	54	-23.09	A
3340	H	1	47.29	-4.03	43.26	74	-30.74	P
			38.85	2.45	41.3	54	-12.7	A
3655	V	1	46.46	-2.87	43.59	74	-30.41	P
			37.62	2.33	39.95	54	-14.05	A
3850	H	1	46.43	-2.5	43.93	74	-30.07	P
			37.54	2.06	39.6	54	-14.4	A
4135	V	1	46.12	-1.89	44.23	74	-29.77	P
			37.43	3.06	40.49	54	-13.51	A
5065	H	1	46.01	1.39	47.4	74	-26.6	P
			37.15	5.72	42.87	54	-11.13	A
4885	V	1	46.5	0.8	47.3	74	-26.7	P
			37.88	5.45	43.33	54	-10.67	A
5815	H	1	44.76	2.8	47.56	74	-26.44	P
			36.52	7.06	43.58	54	-10.42	A
7225	V	1	45.36	2.83	48.19	74	-25.81	P
			36.02	7.34	43.36	54	-10.64	A
15247.28	----	----	----	----	----	----	----	----
25355.34	----	----	----	----	----	----	----	----

Remark: 1. Transd.=Antenna Factor+Cable Loss-Pre-amplifier  
 Margin = Level-Limit  
 Mark: P means Peak Value, Q means Quasi Peak Value, A means Average Value

2. Data of measurement within this frequency range shown “-” in the table above means the reading of emissions are attenuated more than 20dB below the permissible limits or the field strength is too small to be measured.

3. Spectrum analyzer setting P(Peak): RBW=1MHz, VBW=1MHz, A(Average): RBW=1MHz, VBW=10Hz.

4. The test limit distance is 3m limit



**The worst Spurious Emission Data above 1GHz Channel Middle**

Channel Middle (2440MHz)								
Maximum Frequency (MHz)	Polarity and Level					Limit (dBµV/m)	Margin (dBµV/m)	Mark (P/Q/A)
	Polarity	Height (m)	Reading dBµV	Transd	Result dBµV/m			
2440	H	1	97.3	-6.39	90.91	114	-23.09	P
			88.21	-6.63	81.58	94	-12.42	A
2440	V	1	93.06	-6.39	86.67	114	-27.33	P
			89.54	-7.88	81.66	94	-12.34	A
3580	H	1	46.45	-3.11	43.34	74	-30.66	P
			38.62	-7.54	31.08	54	-22.92	A
3235	V	1	47.42	-4.07	43.35	74	-30.65	P
			39.03	-7.49	31.54	54	-22.46	A
4255	H	1	45.89	-1.37	44.52	74	-29.48	P
			37.42	2.58	40	54	-14	A
4180	V	1	46.57	-1.67	44.9	74	-29.1	P
			38.28	2.05	40.33	54	-13.67	A
4705	H	1	46.4	0	46.4	74	-27.6	P
			38.83	2.42	41.25	54	-12.75	A
4750	V	1	45.81	0.19	46	74	-28	P
			37.57	3.44	41.01	54	-12.99	A
5170	H	1	45.52	1.52	47.04	74	-26.96	P
			37.33	5.06	42.39	54	-11.61	A
5500	V	1	45.33	1.73	47.06	74	-26.94	P
			37.76	6.19	43.95	54	-10.05	A
5755	H	1	45.95	2.59	48.54	74	-25.46	P
			37.41	6.28	43.69	54	-10.31	A
6340	V	1	45.47	4.09	49.56	74	-24.44	P
			37.43	6.24	43.67	54	-10.33	A
15250.08	----	----	----	----	----	----	----	----
25358.28	----	----	----	----	----	----	----	----

Remark: 1. Transd.=Antenna Factor+Cable Loss-Pre-amplifier  
 Margin = Level-Limit  
 Mark: P means Peak Value, Q means Quasi Peak Value, A means Average Value

2. Data of measurement within this frequency range shown “-” in the table above means the reading of emissions are attenuated more than 20dB below the permissible limits or the field strength is too small to be measured.

3. Spectrum analyzer setting P(Peak): RBW=1MHz, VBW=1MHz, A(Average): RBW=1MHz, VBW=10Hz.

4. The test limit distance is 3m limit

### The worst Spurious Emission Data above 1GHz Channel High

Channel High (2474MHz)								
Maximum Frequency (MHz)	Polarity and Level					Limit (dB $\mu$ V/m)	Margin (dB $\mu$ V/m)	Mark (P/Q/A)
	Polarity	Height (m)	Reading dB $\mu$ V	Transd	Result dB $\mu$ V/m			
2474	H	1	96.28	-6.29	89.99	114	-24.01	P
			88.45	-6.07	82.38	94	-11.62	A
2474	V	1	93.5	-6.29	87.21	114	-26.79	P
			89.25	-7.06	82.19	94	-11.81	A
2950	H	1	48.66	-4.44	44.22	74	-29.78	P
			39.39	-7.29	32.1	54	-21.9	A
3715	V	1	46.6	-2.71	43.89	74	-30.11	P
			37.21	-7.05	30.16	54	-23.84	A
3610	H	1	47.22	-2.98	44.24	74	-29.76	P
			38.39	2.37	40.76	54	-13.24	A
4270	V	1	45.99	-1.31	44.68	74	-29.32	P
			36.09	2.14	38.23	54	-15.77	A
4390	H	1	46.35	-0.86	45.49	74	-28.51	P
			37.63	2.36	39.99	54	-14.01	A
4885	V	1	46.05	0.8	46.85	74	-27.15	P
			37.28	4.08	41.36	54	-12.64	A
5050	H	1	45.9	1.38	47.28	74	-26.72	P
			36.09	5.24	41.33	54	-12.67	A
5245	V	1	45.67	1.54	47.21	74	-26.79	P
			36.28	6.03	42.31	54	-11.69	A
6070	H	1	45.22	3.3	48.52	74	-25.48	P
			36.03	7.44	43.47	54	-10.53	A
6040	V	1	46.03	3.21	49.24	74	-24.76	P
			36.21	7.03	43.24	54	-10.76	A
15252.74	----	----	----	----	----	----	----	----
25360.17	----	----	----	----	----	----	----	----

Remark: 1. Transd.=Antenna Factor+Cable Loss-Pre-amplifier  
 Margin = Level-Limit  
 Mark: P means Peak Value, Q means Quasi Peak Value, A means Average Value

2. Data of measurement within this frequency range shown “-” in the table above means the reading of emissions are attenuated more than 20dB below the permissible limits or the field strength is too small to be measured.

3. Spectrum analyzer setting P(Peak): RBW=1MHz, VBW=1MHz, A(Average): RBW=1MHz, VBW=10Hz.

4. The test limit distance is 3m limit

## **7. ANTENNA REQUIREMENT**

### **7.1 Standard Applicable**

Section 15.203:

An intentional radiator shall be designed to ensure that no antenna other than that furnished by the responsible party shall be used with the device. The use of a permanently attached antenna or of an antenna that uses a unique coupling to the intentional radiator shall be considered sufficient to comply with the provisions of this Section. The manufacturer may design the unit so that a broken antenna can be replaced by the user, but the use of a standard antenna jack or electrical connector is prohibited.

### **7.2 Antenna Connected Construction**

The antenna connector is designed with permanent attachment and no consideration of replacement.