

neatron

2.4G Wireless Microphone



NR205



NT205



NR206



NT206

NEATRON CORP.

1. Parts and Functions

Table Stand Receiver - NR205

- Front -

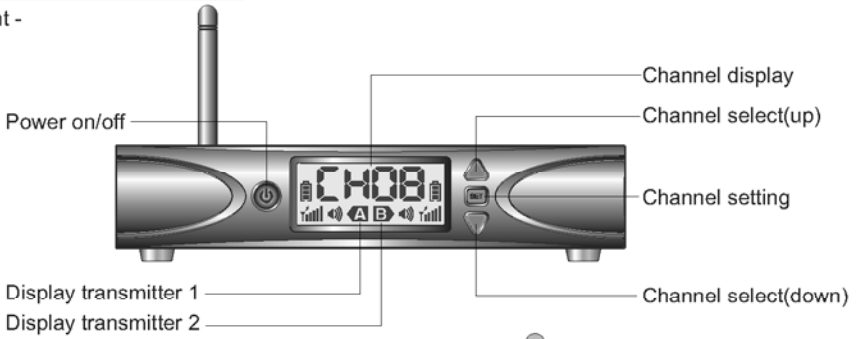

- Rear -

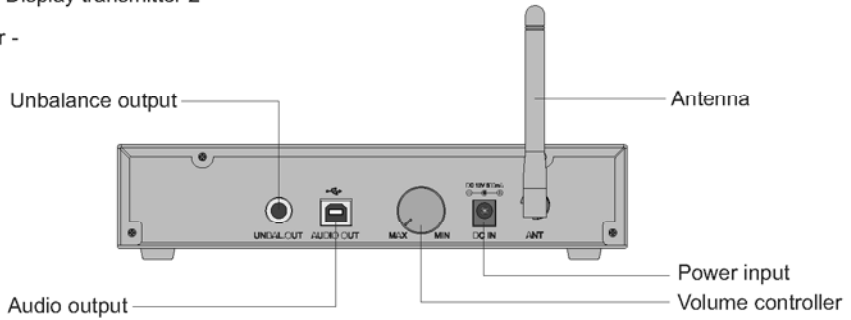

Portable Mini Receiver - NR206

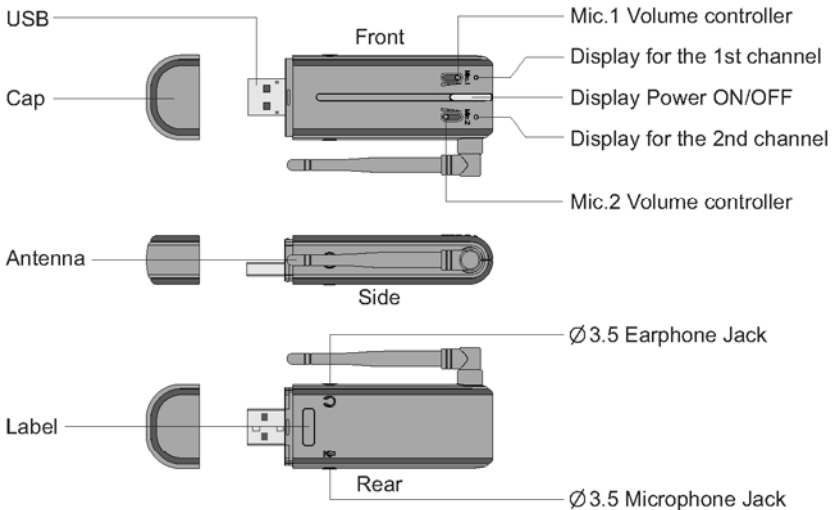

Transmitter - NT205

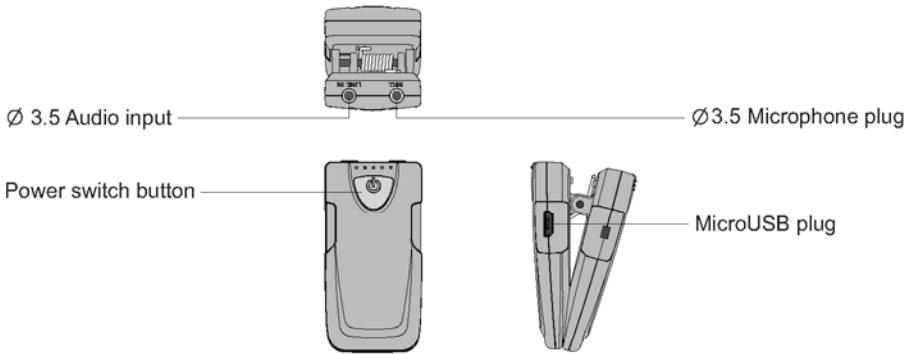

Microphone - NPA413



Transmitter with MIC. / LINE IN

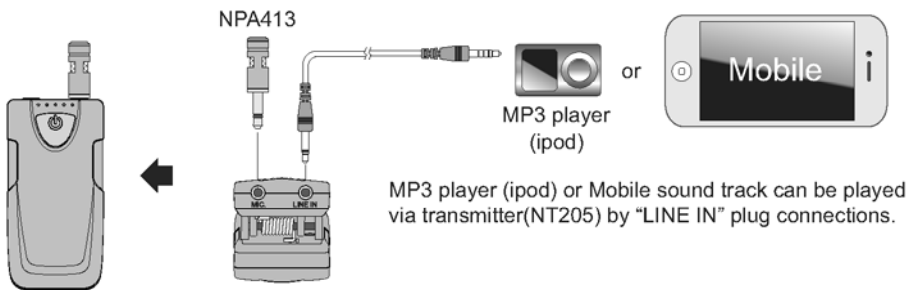

Transmitter - NT205

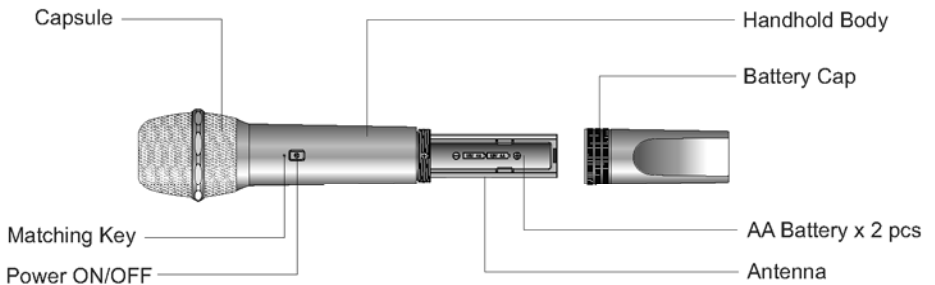

Steps for assembling the Receiver (NR205) device

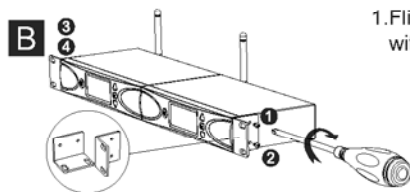
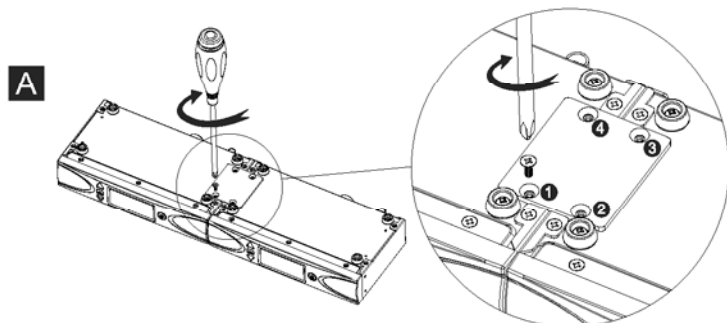

1. Flip over 2pcs of receivers and link together with 4 screws as graphic (A).

2. Screw up both sides and back of the unit to the rack. Fix both sides of iron plates with screws as graphic (B).

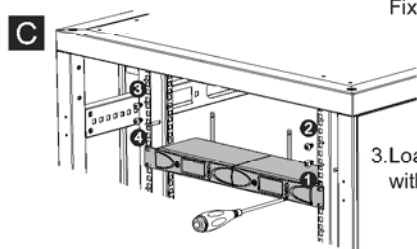

3. Load the whole device into cabinet and fix with screws as graphic (C).

Set up the Receiver(NR205) device

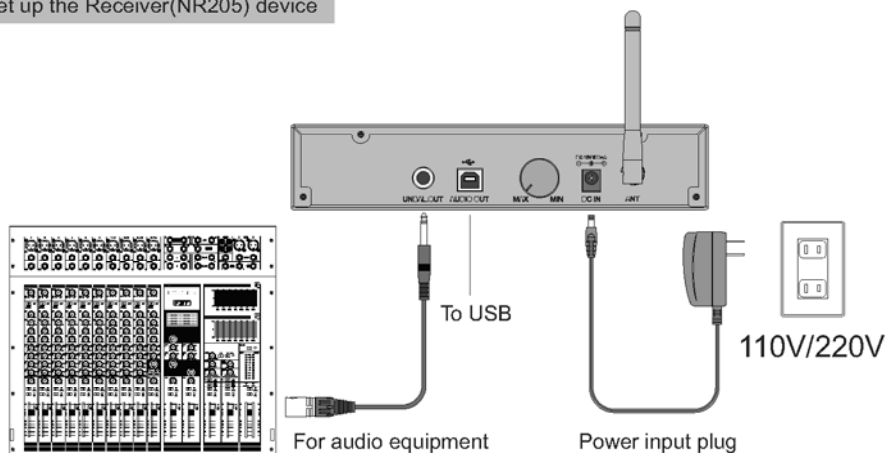

For audio equipment

Power input plug

ON/OFF Functions

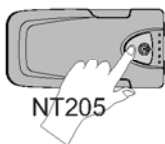

ON : Press power ON/OFF button for 3 seconds, see the red light blinks N times (means : the remaining battery for N hours) then wait until green light blinks (channels matching status).

OFF : Press power ON/OFF button for 3 seconds till the green light turn off.

MUTE : Continuously click power ON/OFF button twice, click twice again can regain the sound.

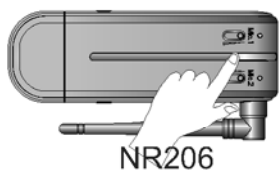

ON : Press power ON/OFF button for 3 seconds, see the red light blinks N times (means : the remaining battery for N hours) then wait until blue light blinks (channels matching status).

OFF : Press power ON/OFF button for 3 seconds till the green light turn off.

Lithium Battery Charging

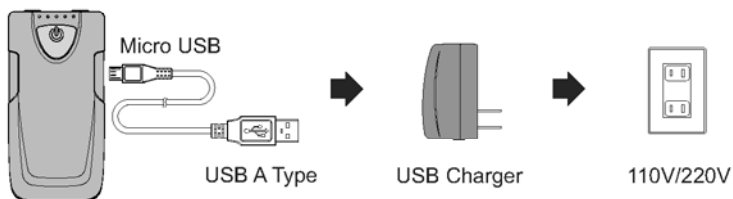

In charging : Red light is on.

Complete charging : Green light is on.

Running out power : Blue light is blinking.

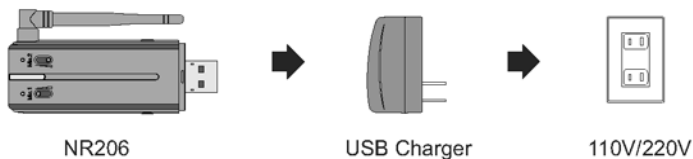

In charging : Blue light is on.

Complete charging : Green light is on.

Running out power : Blue light is blinking.

AA Battery Change

NT206



Turn counterclockwise to take off the battery cap.



NT206



Load 2 pcs of new AA batteries.

Signal connection

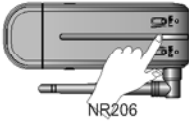

NR206

Press Receiver (NR206) power ON/OFF button for 3 seconds, see the red light blinks N times (means : the remaining battery for N hours) then wait until blue light blinks (channels matching status).



NT205

Press Transmitter (NT205/NT206) power ON/OFF button for 3 seconds, see the red light blinks N times(means : the remaining battery for N hours) then wait until green light blinks (channels matching status).



NT206

One Receiver can match with 2 Transmitters at the same time, GREEN light on Receiver shows the status when Receiver match channel with Transmitters completely.

Mic. 1 Blue lights on (channel to the 1st Transmitter)

Mic. 2 Blue lights on (channel to the 2nd Transmitter)

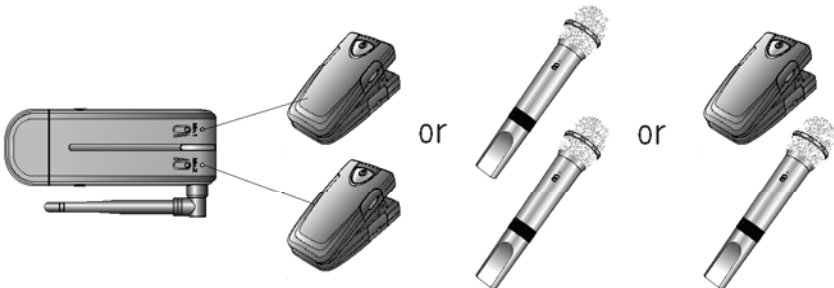

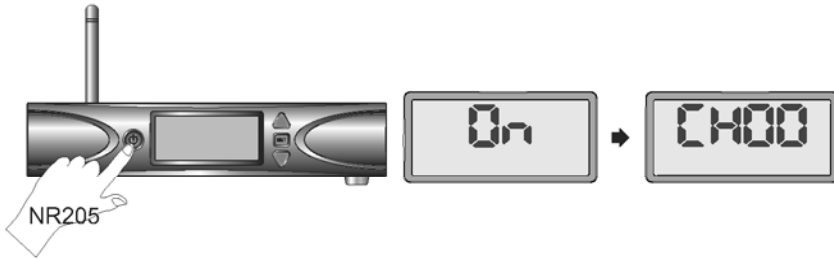

Signal connection

1. Press power ON/OFF button for a few seconds until LCD monitor display from "On" turn to "CH00".

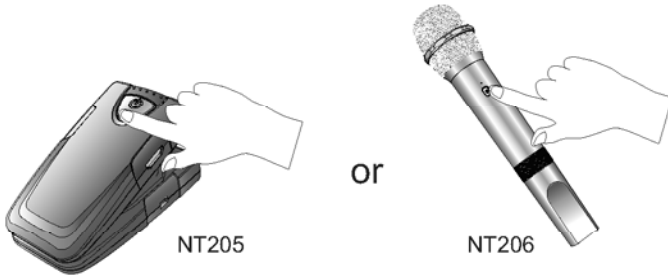

2. Press power ON/OFF button for 3 seconds, see the red light blinks N times (means : the remaining battery for N hours) then wait until green light blinks(channels matching status).

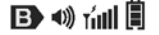

3. Load the 1st Transmitter close to Receiver device within 2M distance, when red light turn to be off means channel searching has succeeded .LCD display will show  , then take the 2nd Transmitter repeat the same action to get  .



4. Push the ON/OFF switch button for at least 3 seconds till the LCD lighting display is off.

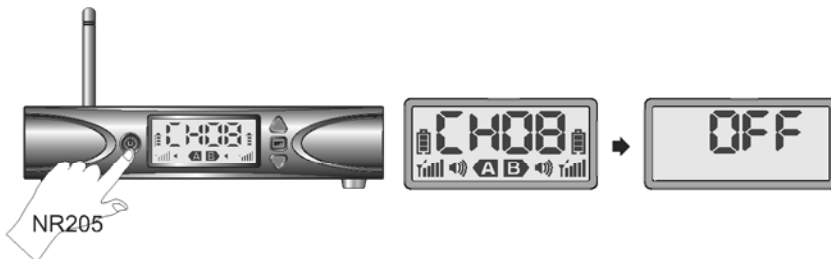

Receiver+Transmitter+Active Speaker(Amplifier is bundled inside)

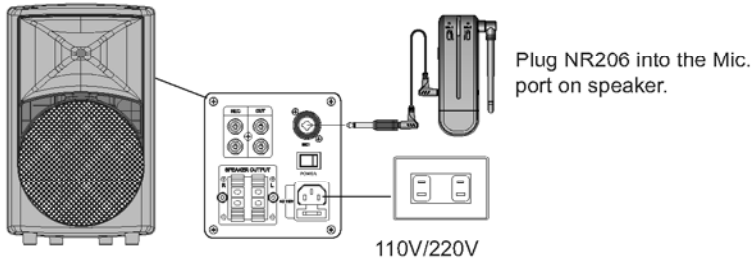

※ Follow the steps for Receiver/Transmitter channels matching in page 5.

Recording Function - Receiver+Transmitter+Mobile phone

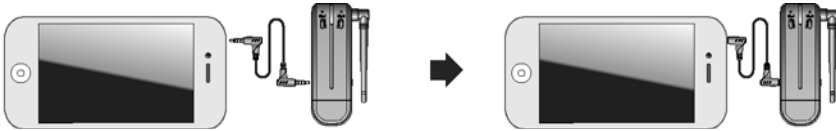

- (1) Plug NR206 into mobile earphone port
- (2) Follow the steps for Receiver/Transmitter channels matching in page 5.
- (3) Active the recording function in mobile phone.

Recording Function - Receiver+Transmitter+PC



- (1) Plug NR206 into USB port on PC.
- (2) Follow the steps in Remark (page 8) for program setting up.
- (3) Proceed channels matching in page 5 and check the microphone function okay.
- (4) Active the recording function in PC.

Remark :



Federal Communications Commission (FCC) Statement

(if the product is smaller than palm size, it could be listed in user manual for instead.)

This device complies with Part 15 of the FCC Rules.

Operation is subject to the following two conditions:

- 1) this device may not cause harmful interference and
- 2) this device must accept any interference received, including interference that may cause undesired operation of the device.

15.21

You are cautioned that changes or modifications not expressly approved by the part responsible for compliance could void the user's authority to operate the equipment.

15.105(b)

This equipment has been tested and found to comply with the limits for a Class B digital device, pursuant to part 15 of the FCC rules. These limits are designed to provide reasonable protection against harmful interference in a residential installation. This equipment generates, uses and can radiate radio frequency energy and, if not installed and used in accordance with the instructions, may cause harmful interference to radio communications. However, there is no guarantee that interference will not occur in a particular installation. If this equipment does cause harmful interference to radio or television reception, which can be determined by turning the equipment off and on, the user is encouraged to try to correct the interference by one or more of the following measures:

- Reorient or relocate the receiving antenna.
- Increase the separation between the equipment and receiver.
- Connect the equipment into an outlet on a circuit different from that to which the receiver is connected.
- Consult the dealer or an experienced radio/TV technician for help.

This device complies with Part 15 of the FCC Rules. Operation is subject to the following two conditions:

- 1) this device may not cause harmful interference and
- 2) this device must accept any interference received, including interference that may cause undesired operation of the device.



neatron Neatron Corp.

5F., No.515, Sec.3, Mingzhi Rd.,
Taishan Dist., New Taipei City 243, Taiwan

Tel : +886 2 2209-5686

Fax : +886 2 2902-9568

Web : www.neatron.com.tw

E-mail : neatron@neatron.com.tw