



**FCC 47 CFR PART 15 SUBPART C/Oct. 2012 AND ANSI 63.4:2003  
TEST REPORT**

**For**

**Wireless IP CAM**

**Model : F3107**

**Trade Name : ZAVIO**

**Issued for**

**ZAVIO Inc.**

**2F, No.13, R&D Rd.II, Science Based Industrial Park,  
Hsinchu, Taiwan**

**Issued by**

**Compliance Certification Services Inc.  
Hsinchu Lab.**

**NO. 989-1 Wen Shan Rd., Shang Shan Village,  
Qionglin Shiang Hsinchu County 30741, Taiwan, R.O.C**

**TEL: +886-3-5921698**

**FAX: +886-3-5921108**

**<http://www.ccsrf.com>**

**E-Mail : [service@ccsrf.com](mailto:service@ccsrf.com)**

**Issued Date: September 06, 2013**



**Note:** This report shall not be reproduced except in full, without the written approval of Compliance Certification Services Inc. This document may be altered or revised by Compliance Certification Services Inc. personnel only, and shall be noted in the revision section of the document. The client should not use it to claim product endorsement by TAF or any government agencies. The test results of this report relate only to the tested sample identified in this report.



### Revision History

Rev.	Issue Date	Revisions	Effect Page	Revised By
00	10/01/2012	Initial Issue	All Page 91	Victoria Liu
01	09/06/2013	Revised FCC STANDARD , MEASUREMENT UNCERTAINTY, TEST SETUP, POWER SPECTRAL DENSITY Data	P1, P4, P7, P10, P27-P37	Victoria Liu



**TABLE OF CONTENTS**

<b>TITLE</b>	<b>PAGE NO.</b>
<b>1. TEST REPORT CERTIFICATION .....</b>	<b>4</b>
<b>2. EUT DESCRIPTION .....</b>	<b>5-6</b>
<b>3. DESCRIPTION OF TEST MODES .....</b>	<b>7-8</b>
<b>4. TEST METHODOLOGY .....</b>	<b>9</b>
<b>5. FACILITIES AND ACCREDITATION .....</b>	<b>9</b>
5.1 FACILITIES .....	9
5.2 ACCREDITATIONS.....	9
5.3 MEASUREMENT UNCERTAINTY .....	10
<b>6. SETUP OF EQUIPMENT UNDER TEST.....</b>	<b>11-13</b>
<b>7. FCC PART 15.247 REQUIREMENTS .....</b>	<b>14</b>
7.1 6dB BANDWIDTH .....	14-23
7.2 MAXIMUM PEAK OUTPUT POWER .....	24-26
7.3 POWER SPECTRAL DENSITY .....	27-37
7.4 CONDUCTED SPURIOUS EMISSION .....	38-50
7.5 RADIATED EMISSION.....	51-84
7.6 CONDUCTED EMISSION.....	85-91



# 1. TEST REPORT CERTIFICATION

**Applicant** : ZAVIO Inc..  
**Address** : 2F, No.13, R&D Rd.II, Science Based Industrial Park,  
Hsinchu, Taiwan  
**Equipment Under Test** : Wireless IP CAM  
**Model** : F3107  
**Trade Name** : ZAVIO  
**Tested Date** : August 20 ~ September 05, 2012 ; September 05, 2013

APPLICABLE STANDARD	
Standard	Test Result
FCC Part 15 Subpart C/Oct. 2012 AND ANSI C63.4:2003	PASS

WE HEREBY CERTIFY THAT: The above equipment has been tested by Compliance Certification Services Inc., and found compliance with the requirements set forth in the technical standards mentioned above. The results of testing in this report apply only to the product/system, which was tested. Other similar equipment will not necessarily produce the same results due to production tolerance and measurement uncertainties.

**Approved by:**

Sb Lu  
Sr. Engineer

**Reviewed by:**

Gundam Lin  
Sr. Engineer



## 2. EUT DESCRIPTION

<b>Product Name</b>	Wireless IP CAM
<b>Model Number</b>	F3107
<b>Identify Number</b>	T120820S04
<b>Received Date</b>	August 20, 2012
<b>Frequency Range</b>	IEEE 802.11b/g, 802.11n HT20 : 2412MHz ~ 2462MHz IEEE 802.11n HT40 : 2422MHz ~ 2452MHz
<b>Transmit Power</b>	IEEE 802.11b mode: 11.75 dBm (0.0150W) IEEE 802.11g mode: 21.90 dBm (0.1549W) IEEE 802.11n HT 20 MHz mode: 21.35 dBm (0.1365W) IEEE 802.11n HT 40 MHz mode: 21.36 dBm (0.1368W)
<b>Channel Spacing</b>	IEEE 802.11b/g, 802.11n HT20/HT40 : 5MHz
<b>Channel Number</b>	IEEE 802.11b/g, 802.11n HT20: 11 Channels IEEE 802.11n HT40 : 7 Channels
<b>Transmit Data Rate</b>	IEEE 802.11b : 11, 5.5, 2, 1 Mbps IEEE 802.11g : 54, 48, 36, 24, 18, 12, 9, 6 Mbps IEEE 802.11n HT20 : 65, 58.5, 52, 39, 26, 19.5, 13, 6.5 Mbps IEEE 802.11n HT40 : 135, 121.5, 108, 81, 54, 40.5, 27, 13.5Mbps
<b>Type of Modulation</b>	IEEE 802.11b : DSSS (CCK, DQPSK, DBPSK) IEEE 802.11g : OFDM (64QAM, 16QAM, QPSK, BPSK) IEEE 802.11n HT20/40 : OFDM (64QAM, 16QAM, QPSK, BPSK)
<b>Antenna Type</b>	Dipole Antenna, Antenna Gain 2dBi
<b>DC Power Cable Type</b>	Non-shielded cable 1.5m × 2 (Non-detachable)
<b>Power Rating</b>	5Vdc
<b>Test Voltage</b>	120Vac, 60Hz
<b>I/O Port</b>	RJ-45 Port × 1, Power Port × 1, Micro SD Port × 1, DI/DO Port × 1



**Power Adapter :**

No.	Manufacturer	Model No.	Power Input	Power Output
1	AMIGO	AMS47-0501000FU	100-240Vac, 50/60Hz, 0.2A	5Vdc, 1.0A
2	DVE	DSA-12CA-05 050150	100-240Vac, 50/60Hz, 0.3A	5Vdc, 1.5A

**Remark :**

1. *The sample selected for test was engineering sample that approximated to production product and was provided by manufacturer.*
2. *For more details, please refer to the User's manual of the EUT.*
3. *This submittal(s) (test report) is intended for FCC ID: WOR-7013F filing to comply with Section 15.207, 15.209 and 15.247 of the FCC Part 15, Subpart C Rules.*
4. *The model F3107 was considered the main model for testing.*



### 3. DESCRIPTION OF TEST MODES

The EUT is an 802.11n transceiver in Wireless IP CAM form factor.

WiFi : Chain 1 (MAIN) transmits.

#### Conducted Emission / Radiated Emission Test (Below 1 GHz)

1. The following test modes were scanned during the preliminary test:

No.	Pre-Test Mode
1	Normal Operating / Power Adapter AMIGO
2	Normal Operating / Power Adapter DVE
3	TX Mode

2. After the preliminary scan, the following test mode was found to produce the highest emission level.

Final Test Mode		
Emission	Radiated Emission	Normal Operating / Power Adapter AMIGO
		Normal Operating / Power Adapter DVE
	Conducted Emission	Normal Operating / Power Adapter AMIGO
		Normal Operating / Power Adapter DVE

*Remark : Then, the above highest emission mode of the configuration of the EUT and cable was chosen for all final test items.*

#### Conducted / Radiated Emission Test (Above 1 GHz)

##### IEEE 802.11b, 802.11g, 802.11n HT20 mode

The EUT had been tested under operating condition.

There are three channels have been tested as following :

Channel	Frequency (MHz)
Low	2412
Middle	2437
High	2462

IEEE 802.11b mode : 1Mbps data rate (worst case) were chosen for full testing.

IEEE 802.11g mode : 6Mbps data rate (worst case) were chosen for full testing.

IEEE 802.11n HT20 mode : 6.5 Mbps data rate (worst case) were chosen for full testing.



**IEEE 802.11n HT40 mode**

The EUT had been tested under operating condition.

There are three channels have been tested as following :

<b>Channel</b>	<b>Frequency (MHz)</b>
Low	2422
Middle	2437
High	2452

IEEE 802.11n HT40 mode : 13.5Mbps data rate (worst case) were chosen for full testing.





## 4. TEST METHODOLOGY

The tests documented in this report were performed in accordance with ANSI C63.4: 2003 and FCC CFR 47, 15.207, 15.209, 15.247 and KDB558074.

## 5. FACILITIES AND ACCREDITATION

### 5.1 FACILITIES

All measurement facilities used to collect the measurement data are located at

NO. 989-1 Wen Shan Rd., Shang Shan Village,  
Qionglin Shiang Hsinchu County 30741, Taiwan, R.O.C

The sites are constructed in conformance with the requirements of ANSI C63.4:2003 and CISPR 22. All receiving equipment conforms to CISPR 16-1-1, CISPR 16-1-2, CISPR 16-1-3, CISPR 16-1-4, CISPR 16-1-5.

### 5.2 ACCREDITATIONS

Our laboratories are accredited and approved by the following approval agencies according to ISO/IEC 17025.

<b>Taiwan</b>	TAF
---------------	-----

The measuring facility of laboratories has been authorized or registered by the following approval agencies.

<b>Canada</b>	INDUSTRY CANADA
<b>Japan</b>	VCCI
<b>Taiwan</b>	BSMI
<b>USA</b>	FCC MRA

Copies of granted accreditation certificates are available for downloading from our web site, <http://www.ccsrf.com>

**Remark:** 1. FCC filing number is TW1027.  
2. IC filing number is 2324 K-1/-2/-3.



### 5.3 MEASUREMENT UNCERTAINTY

The following table is for the measurement uncertainty, which is calculated as per the document CISPR 16-4-2.

PARAMETER	UNCERTAINTY
Semi Anechoic Chamber (966 Chamber_B) / Radiated Emission, 0.009 to 30 MHz	+/- 3.1252
Semi Anechoic Chamber (966 Chamber_B) / Radiated Emission, 30 to 1000 MHz	+/- 3.97
Semi Anechoic Chamber (966 Chamber_B) / Radiated Emission, 1 to 18GHz	+/- 3.58
Semi Anechoic Chamber (966 Chamber_B) / Radiated Emission, 18 to 26 GHz	+/- 3.59
Semi Anechoic Chamber (966 Chamber_B) / Radiated Emission, 26 to 40 GHz	+/- 3.81
Conducted Emission (Mains Terminals), 9kHz to 30MHz	+/- 2.48

This uncertainty represents an expanded uncertainty expressed at approximately the 95% confidence level using a coverage factor of  $k=2$ .

Consistent with industry standard (e.g. CISPR 22, clause 11, Measurement Uncertainty) determining compliance with the limits shall be base on the results of the compliance measurement. Consequently the measure emissions being less than the maximum allowed emission result in this be a compliant test or passing test.

The acceptable measurement uncertainty value without requiring revision of the compliance statement is base on conducted and radiated emissions being less than  $U_{CISPR}$  which is 3.6dB and 5.2dB respectively. CCS values (called  $U_{Lab}$  in CISPR 16-4-2) is less than  $U_{CISPR}$  as shown in the table above. Therefore, MU need not be considered for compliance.



## 6. SETUP OF EQUIPMENT UNDER TEST

### SUPPORT EQUIPMENT

No.	Product	Manufacturer	Model No.	Serial No.	FCC ID
1	Notebook PC	DELL	Latitude D610	CN-0C4708-48643-62 5-5565	DoC
2	Notebook PC	HP	ProBook 4421s	CNF03242PJ	DoC
3	Wireless Gigabit Router	SMC	SMCWGBR14 S-N	U193600496	---
4	Micro SD Card	SanDisk	2G	---	---

No.	Signal cable description
1	Non-shielded RJ-45 cable, 12m × 1

### SETUP DIAGRAM FOR TESTS

EUT & peripherals setup diagram is shown in appendix setup photos.



**EUT OPERATING CONDITION**

**RF Mode:**

1. Set up whole system for test as shown on diagram.
2. Pc a fixed ip, into the Network Neighborhood to confirm EUT obtained ip
3. On internet website key in:  
http://192.168.1.90/cgi-bin/admin/param?action=update&telnetd=23
4. Run Putty software→IP address 192.168.1.90
5. Account: root  
. key in : mp8192c  
->emi
6. Run the test command
7. Set up all computers like the setup diagram

(1) TX Mode:

- ⇒ cctx 1 ; start tx
- ⇒ cctx 0 ; stop tx
- ⇒ chan 1 ; (Channel 1~14)
- ⇒ bw ; bandwidth (0=20M , 1=40M)
- ⇒ txpower 30 ; (00~3f)
- ⇒ rate 0 ; 0~3: CCK 1M~11M  
4~11: OFDM 6M~54M  
12~19: MCS0~MCS7  
20~27: MCS8~MCS15
- ⇒ cctx 1 ; Continuous TX
- ⇒ Power control
  - IEEE 802.11b Channel Low (2412MHz) TX Power=21
  - IEEE 802.11b Channel Mid (2437MHz) TX Power=21
  - IEEE 802.11b Channel High (2462MHz) TX Power=21
  - IEEE 802.11g Channel Low (2412MHz) TX Power=30
  - IEEE 802.11g Channel Mid (2437MHz) TX Power=2f
  - IEEE 802.11g Channel High (2462MHz) TX Power=2f
  - IEEE 802.11n HT20 Channel Low (2412MHz) TX Power=30
  - IEEE 802.11n HT20 Channel Mid (2437MHz) TX Power=30
  - IEEE 802.11n HT20 Channel High (2462MHz) TX Power=30
  - IEEE 802.11n HT40 Channel Low (2422MHz) TX Power=30
  - IEEE 802.11n HT40 Channel Mid (2437MHz) TX Power=30
  - IEEE 802.11n HT40 Channel High (2452MHz) TX Power=30



8. All of the functions are under run.
9. Start test.

**Normal Mode:**

1. EUT & peripherals setup diagram is shown in appendix setup photos.
2. Wireless Router to provide IP to the EUT.
3. Notebook PC (1) ping to EUT.
4. Notebook PC (2) ping to EUT.
5. All of the functions are under run (web display video).
6. Start test.



## 7. FCC PART 15.247 REQUIREMENTS

### 7.1 6dB BANDWIDTH

#### LIMITS

§ 15.247(a) (2) For direct sequence systems, the minimum 6dB bandwidth shall be at least 500kHz.

#### TEST EQUIPMENT

Name of Equipment	Manufacturer	Model	Serial Number	Calibration Due
Spectrum Analyzer	AGILENT	E4446A	MY43360132	06/14/2013

*Remark: Each piece of equipment is scheduled for calibration once a year.*

#### TEST SETUP

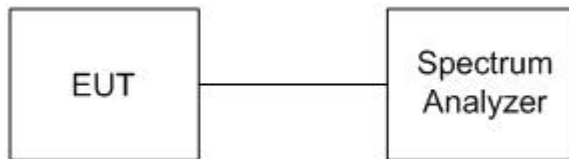

#### TEST PROCEDURE

The transmitter output was connected to a spectrum analyzer. The bandwidth of the fundamental frequency was measured by spectrum analyzer with 100 KHz RBW and 300 KHz VBW. The 6dB bandwidth is defined as the total spectrum the power of which is higher than peak power minus 6dB.



**TEST RESULTS**

**IEEE 802.11b Mode**

Channel	Channel Frequency (MHz)	6dB Bandwidth (MHz)	Minimum Limit (kHz)	Pass / Fail
Low	2412	10.33	500	PASS
Middle	2437	10.33	500	PASS
High	2462	10.33	500	PASS

**IEEE 802.11g Mode**

Channel	Channel Frequency (MHz)	6dB Bandwidth (MHz)	Minimum Limit (kHz)	Pass / Fail
Low	2412	16.50	500	PASS
Middle	2437	16.50	500	PASS
High	2462	16.50	500	PASS

**IEEE 802.11n HT20 mode**

Channel	Channel Frequency (MHz)	6dB Bandwidth (MHz)	Minimum Limit (kHz)	Pass / Fail
Low	2412	17.75	500	PASS
Middle	2437	17.75	500	PASS
High	2462	17.67	500	PASS

**IEEE 802.11n HT40 mode**

Channel	Channel Frequency (MHz)	6dB Bandwidth (MHz)	Minimum Limit (kHz)	Pass / Fail
Low	2422	36.33	500	PASS
Middle	2437	36.33	500	PASS
High	2452	36.33	500	PASS



6dB BANDWIDTH

IEEE 802.11b Mode / CH Low

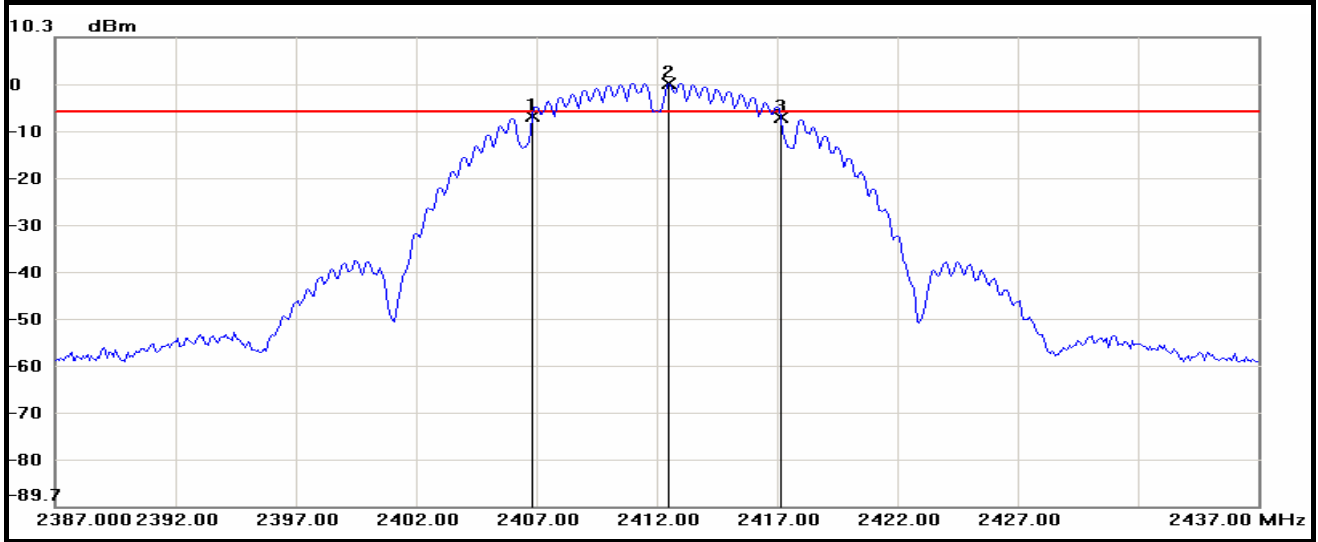

No.	Frequency(MHz)	Result(dBm)
1	2406.8333	-6.58
2	2412.5000	0.49
3	2417.1667	-6.74

IEEE 802.11b Mode / CH Middle

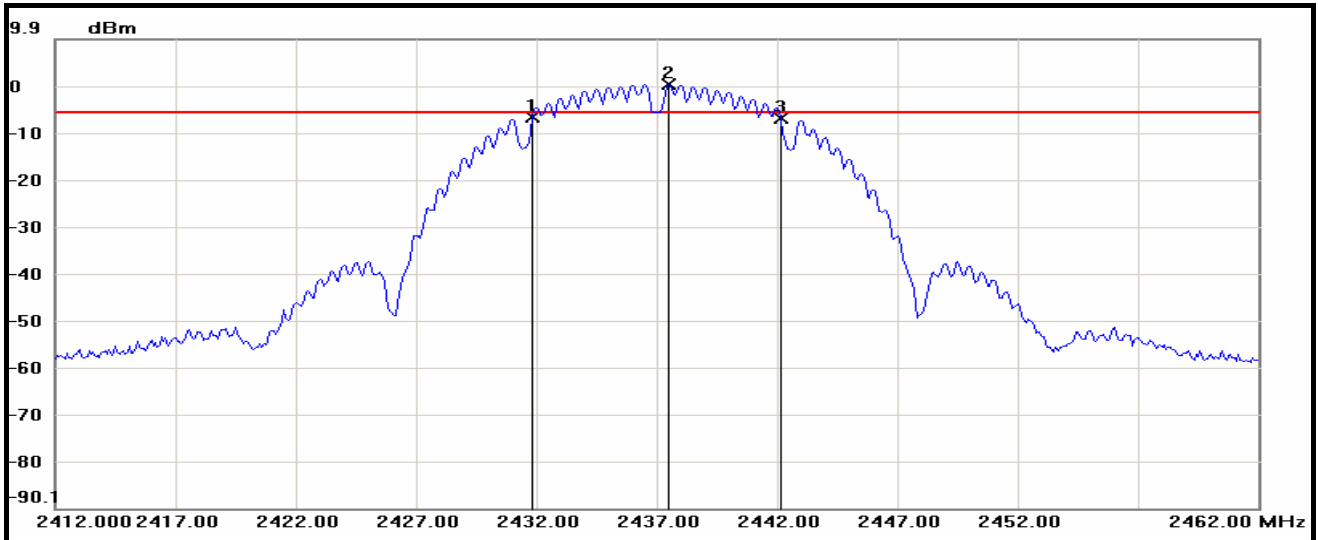

No.	Frequency(MHz)	Result(dBm)
1	2431.8333	-6.74
2	2437.5000	0.26
3	2442.1667	-7.03





IEEE 802.11b Mode / CH High

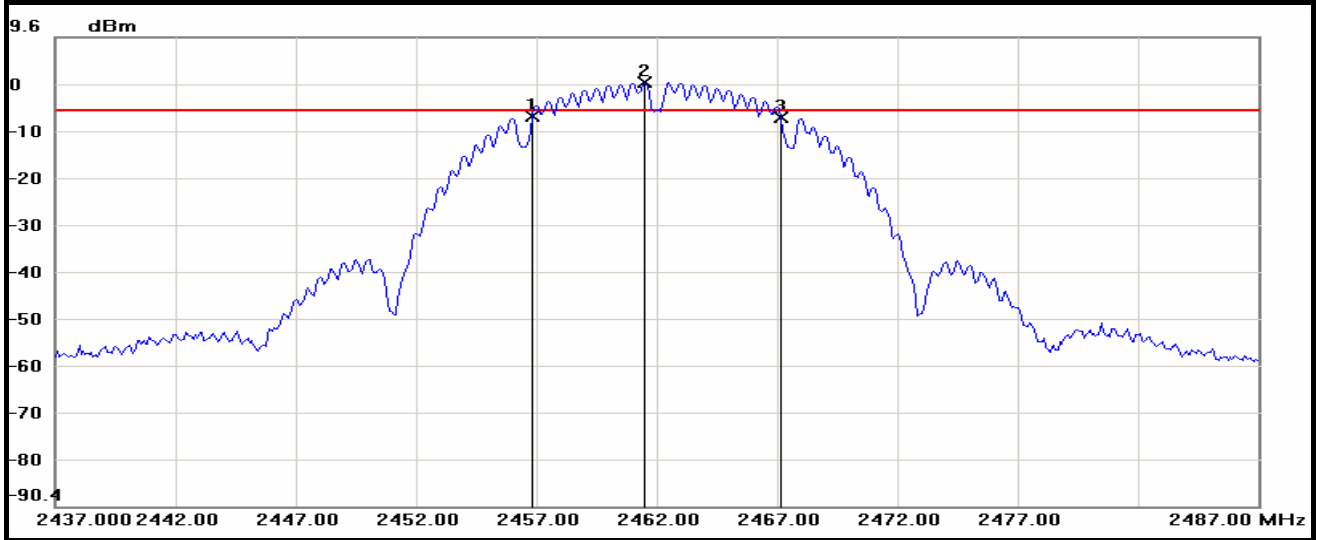

No.	Frequency(MHz)	Result(dBm)
1	2456.8333	-7.20
2	2461.5000	-0.12
3	2467.1667	-7.44



IEEE 802.11g Mode / CH Low

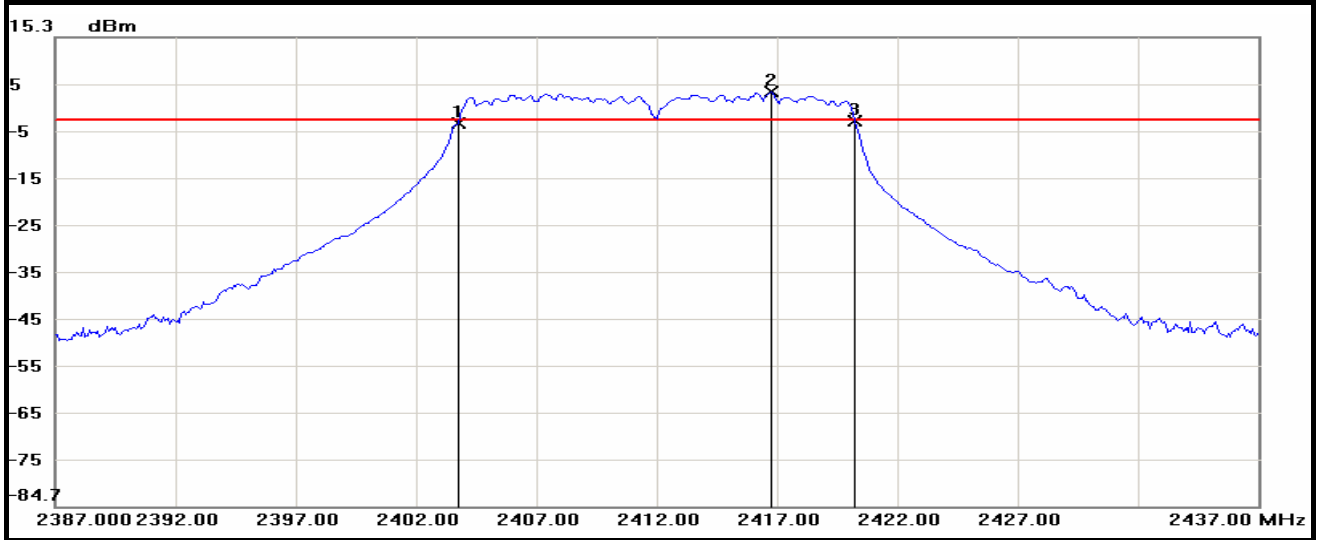

No.	Frequency(MHz)	Result(dBm)
1	2403.7500	-2.98
2	2416.7500	3.59
3	2420.2500	-2.52

IEEE 802.11g Mode / CH Middle

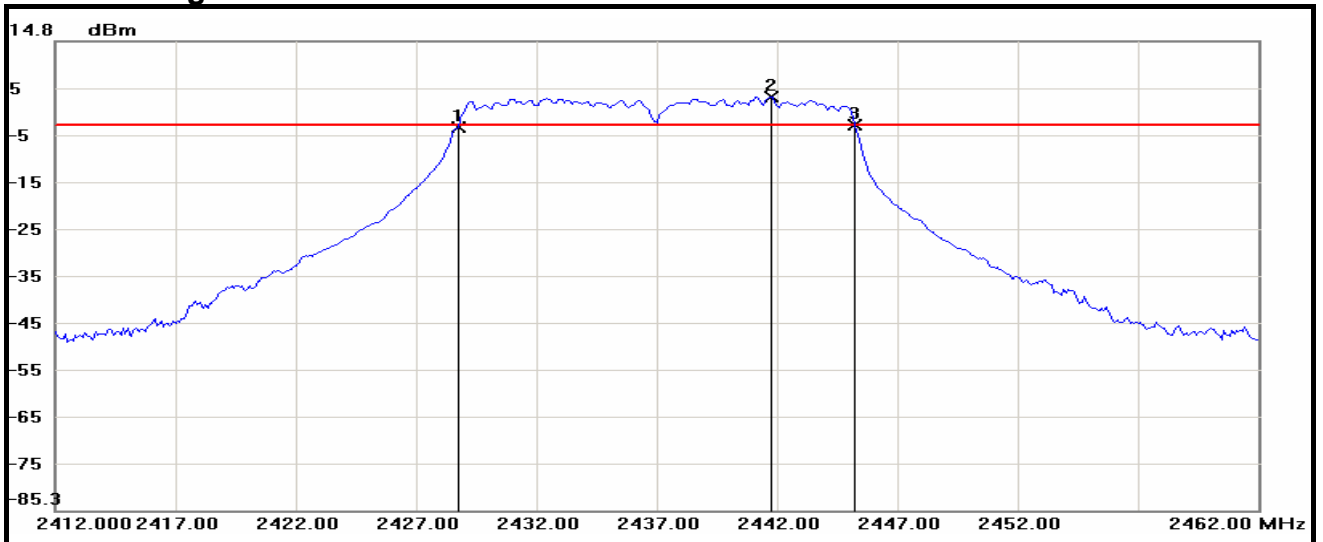

No.	Frequency(MHz)	Result(dBm)
1	2428.7500	-3.69
2	2441.7500	2.94
3	2445.2500	-3.08



IEEE 802.11g Mode / CH High

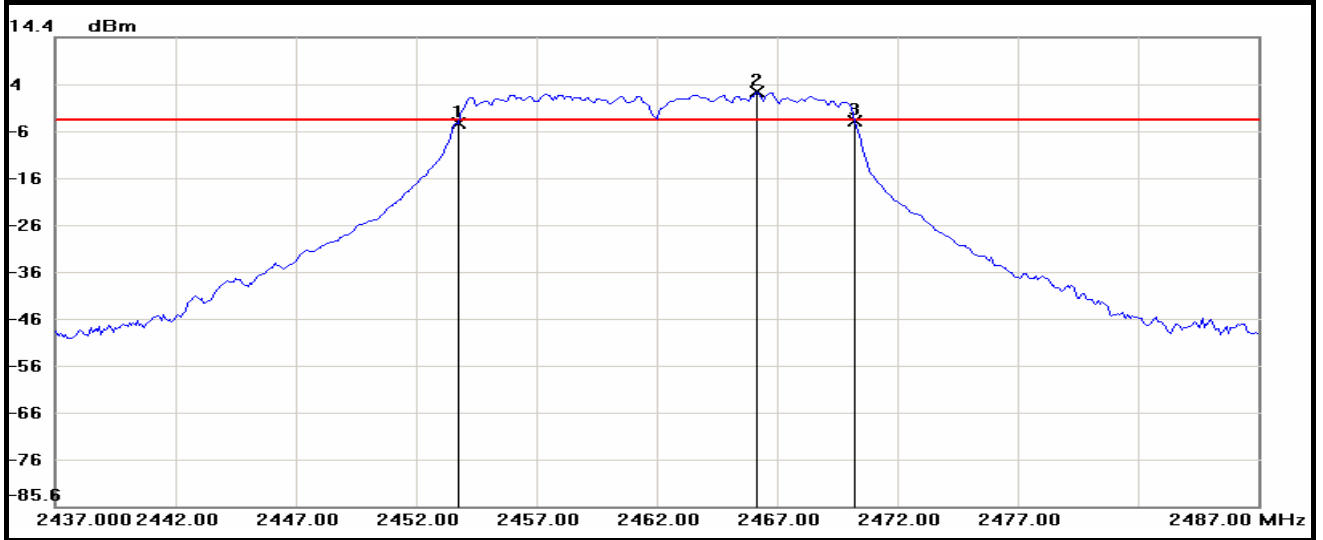

No.	Frequency(MHz)	Result(dBm)
1	2453.7500	-4.00
2	2466.1667	2.70
3	2470.2500	-3.35



IEEE 802.11n HT20 Mode / CH Low

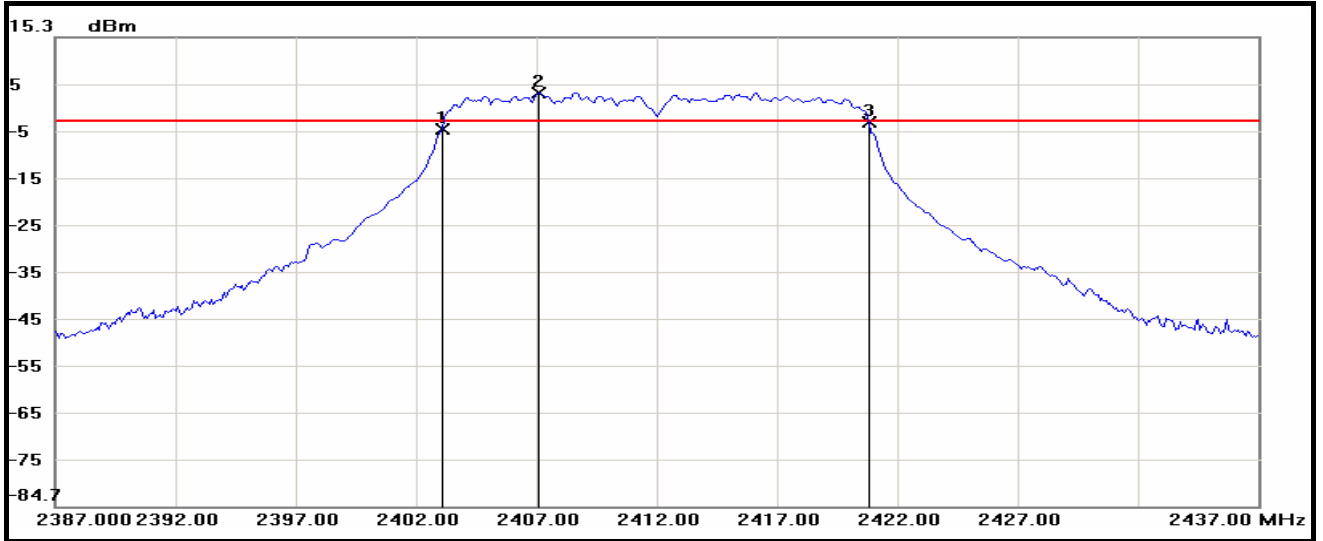

No.	Frequency(MHz)	Result(dBm)
1	2403.0833	-4.37
2	2407.0833	3.47
3	2420.8333	-2.75

IEEE 802.11n HT20 Mode / CH Middle

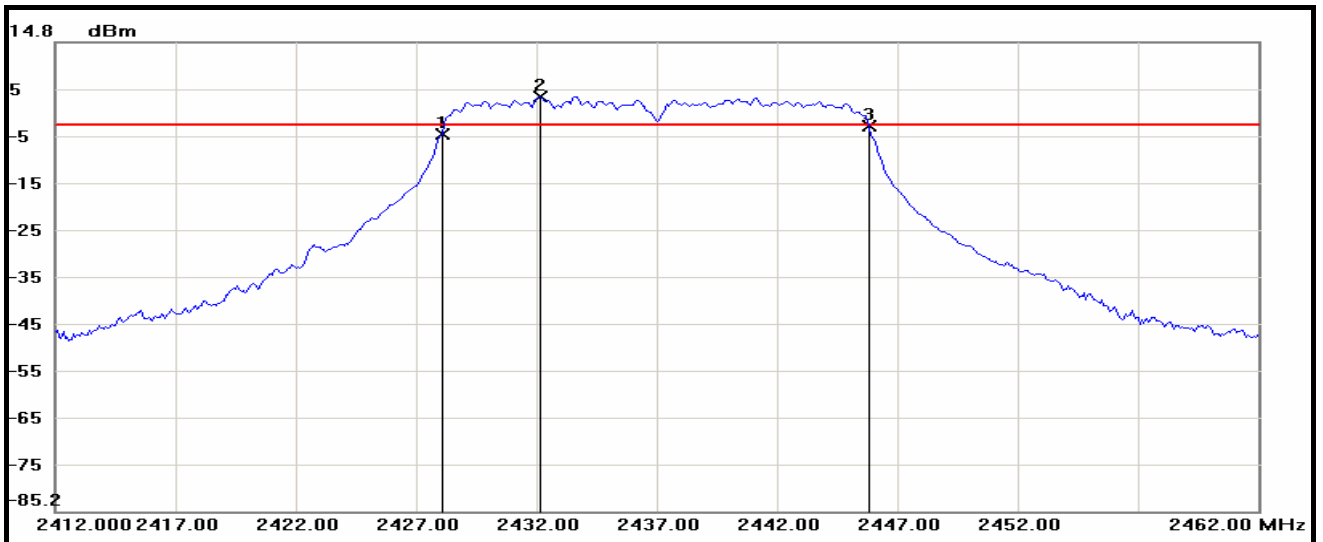

No.	Frequency(MHz)	Result(dBm)
1	2428.0833	-4.90
2	2432.1667	3.19
3	2445.8333	-3.15



IEEE 802.11n HT20 Mode / CH High

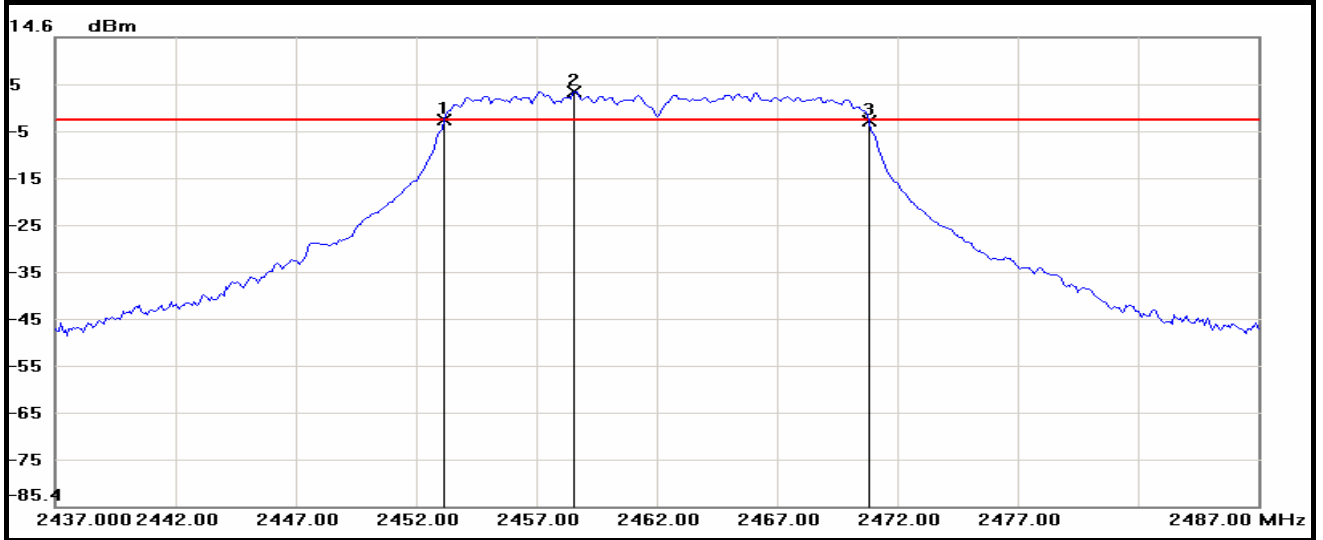

No.	Frequency(MHz)	Result(dBm)
1	2453.1667	-3.14
2	2458.5833	2.93
3	2470.8333	-3.18



IEEE 802.11n HT40 Mode / CH Low

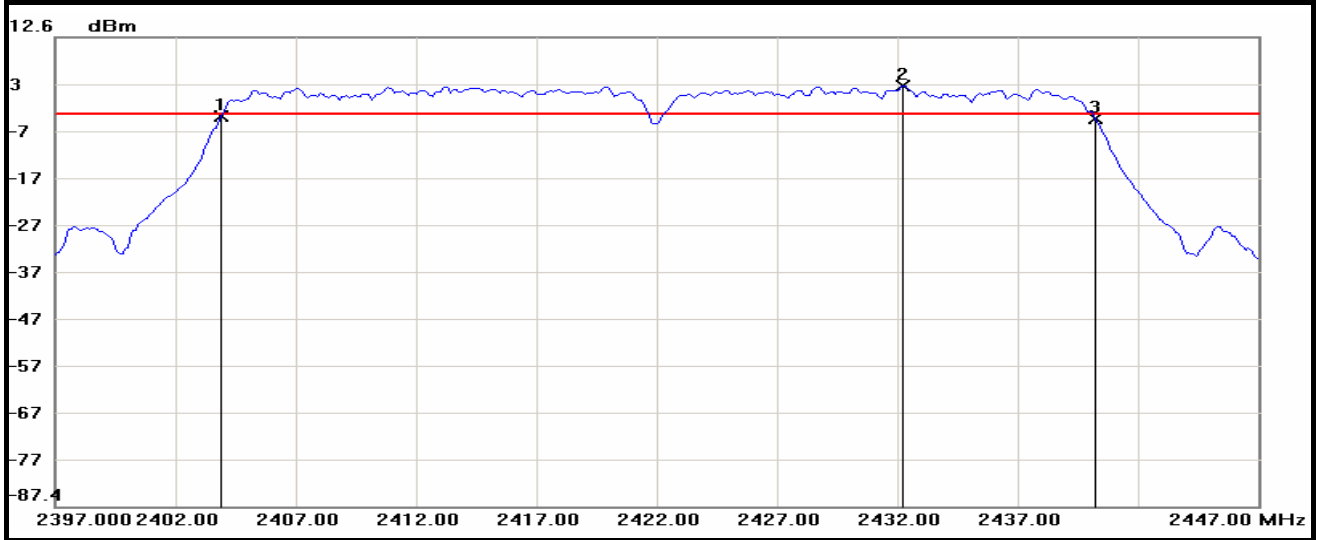

No.	Frequency(MHz)	Result(dBm)
1	2403.9167	-4.20
2	2432.2500	2.12
3	2440.2500	-4.75

IEEE 802.11n HT40 Mode / CH Middle

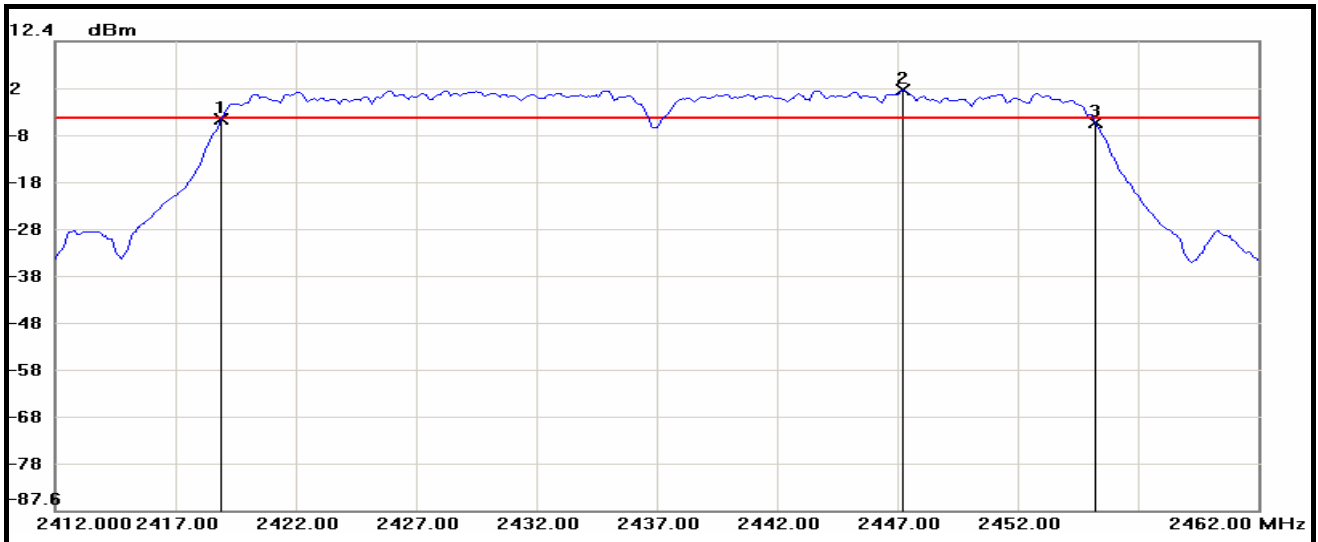

No.	Frequency(MHz)	Result(dBm)
1	2418.9167	-4.29
2	2447.2500	1.95
3	2455.2500	-4.88



IEEE 802.11n HT40 Mode / CH High

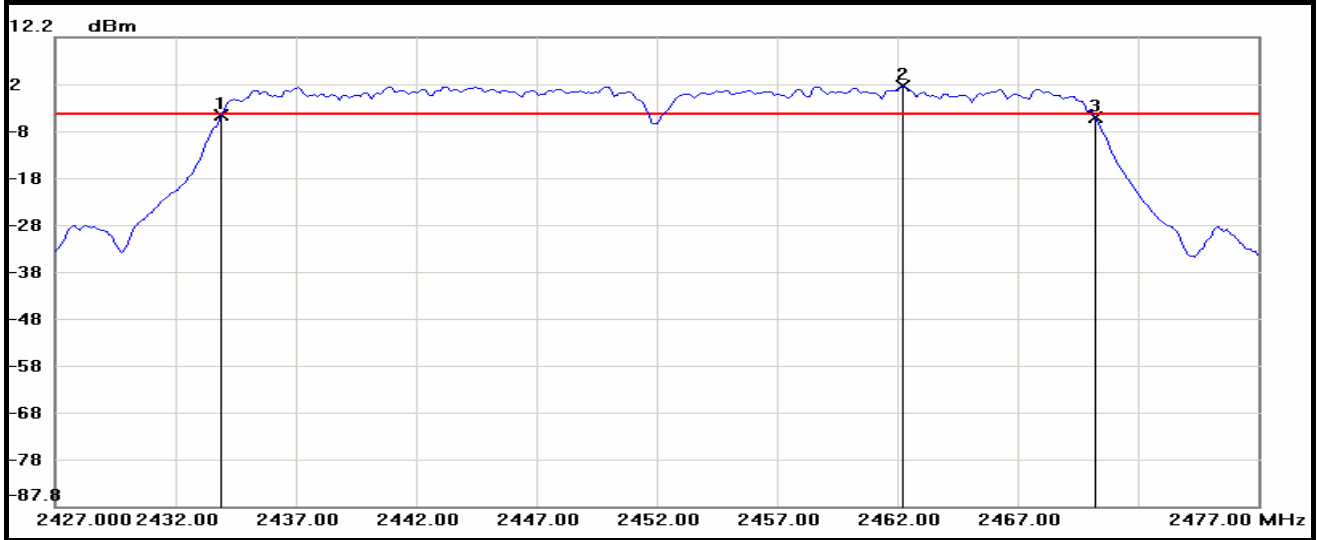

No.	Frequency(MHz)	Result(dBm)
1	2433.9167	-4.27
2	2462.2500	1.81
3	2470.2500	-4.96



## 7.2 MAXIMUM PEAK OUTPUT POWER

### LIMITS

§ 15.247(b) The maximum peak output power of the intentional radiator shall not exceed the following :

§ 15.247(b) (3) For systems using digital modulation in the 902-928 MHz, 2400-2483.5 MHz, and 5725-5850 MHz bands : 1 watt.

§ 15.247(b) (4) Except as shown in paragraphs (c) of this section, if transmitting antennas of directional gain greater than 6 dBi are used the peak output power from the intentional radiator shall be reduced below the stated values in paragraphs (b)(1) or (b)(2), and (b)(3) of this section, as appropriate, by the amount in dB that the directional gain of the antenna exceeds 6 dBi.

### TEST EQUIPMENT

Name of Equipment	Manufacturer	Model	Serial Number	Calibration Due
Power Meter	ANRITSU	ML2495A	1149001	12/07/2012
Power Sensor	ANRITSU	MA2411B	1126148	12/14/2012

*Remark: Each piece of equipment is scheduled for calibration once a year.*

### TEST SETUP



### TEST PROCEDURE

The transmitter output is connected to the Power Meter. The Power Meter is set to the peak power detection.





**TEST RESULTS**

**IEEE 802.11b Mode**

Channel	Channel Frequency (MHz)	Peak Power		Peak Power Limit		Pass / Fail
		(dBm)	(W)	(dBm)	(W)	
Low	2412	11.75	0.0150	30	1	PASS
Middle	2437	11.49	0.0141	30	1	PASS
High	2462	11.20	0.0132	30	1	PASS

**Remark:**

1. At final test to get the worst-case emission at 1Mbps.
2. The cable assembly insertion loss of 11.5dB (including 10 dB pad and 1.5 dB cable) was Entered as an offset in the Power Meter to allow for direct reading of power.

**IEEE 802.11g Mode**

Channel	Channel Frequency (MHz)	Peak Power		Peak Power Limit		Pass / Fail
		(dBm)	(W)	(dBm)	(W)	
Low	2412	21.90	0.1549	30	1	PASS
Middle	2437	21.35	0.1365	30	1	PASS
High	2462	21.20	0.1318	30	1	PASS

**Remark:**

1. At final test to get the worst-case emission at 6Mbps.
2. The cable assembly insertion loss of 11.5dB (including 10 dB pad and 1.5 dB cable) was Entered as an offset in the Power Meter to allow for direct reading of power.



IEEE 802.11n HT20 mode

Channel	Channel Frequency (MHz)	Peak Power		Peak Power Limit		Pass / Fail
		(dBm)	(W)	(dBm)	(W)	
Low	2412	21.35	0.1365	30	1	PASS
Middle	2437	21.27	0.1340	30	1	PASS
High	2462	21.08	0.1282	30	1	PASS

Remark:

1. At final test to get the worst-case emission at 6.5Mbps.
2. The cable assembly insertion loss of 11.5dB (including 10 dB pad and 1.5 dB cable) was Entered as an offset in the Power Meter to allow for direct reading of power.

IEEE 802.11n HT40 mode

Channel	Channel Frequency (MHz)	Peak Power		Peak Power Limit		Pass / Fail
		(dBm)	(W)	(dBm)	(W)	
Low	2422	21.36	0.1368	30	1	PASS
Middle	2437	21.30	0.1349	30	1	PASS
High	2452	21.22	0.1324	30	1	PASS

Remark:

1. At final test to get the worst-case emission at 13.5Mbps.
2. The cable assembly insertion loss of 11.5dB (including 10 dB pad and 1.5 dB cable) was Entered as an offset in the Power Meter to allow for direct reading of power.



### 7.3 POWER SPECTRAL DENSITY

#### LIMITS

§ 15.247(e) For digitally modulated systems, the power spectral density conducted from the intentional radiator to the antenna shall not greater than 8 dBm in any 3 kHz band during any time interval of continuous transmission.

#### TEST EQUIPMENT

Name of Equipment	Manufacturer	Model	Serial Number	Calibration Due
Spectrum Analyzer	AGILENT	E4446A	MY43360132	06/10/2014

*Remark: Each piece of equipment is scheduled for calibration once a year.*

#### TEST SETUP



#### TEST PROCEDURE

1. The transmitter output was connected to the spectrum analyzer.
2. Set analyzer center frequency to DTS channel center frequency.
3. Set the span to 1.5 times the DTS channel bandwidth.
4. Set the RBW to:  $3 \text{ kHz} \leq \text{RBW} \leq 100 \text{ kHz}$ .
5. Set the VBW  $\geq 3 \times \text{RBW}$ .
6. Detector = peak.
7. Sweep time = auto couple.
8. Trace mode = max hold.
9. Allow trace to fully stabilize.
10. Use the peak marker function to determine the maximum amplitude level within the RBW.
11. If measured value exceeds limit, reduce RBW (no less than 3 kHz) and repeat.



**TEST RESULTS**

**IEEE 802.11b Mode**

Channel	Channel Frequency (MHz)	Final RF Power Level in 3KHz BW (dBm)	Minimum Limit (dBm)	Pass / Fail
Low	2412	-19.04	8	PASS
Middle	2437	-20.04	8	PASS
High	2462	-20.46	8	PASS

**Remark:**

1. At final test to get the worst-case emission at 1Mbps.
2. The cable assembly insertion loss of 11.5dB (including 10 dB pad and 1.5 dB cable) was Entered as an offset in the Spectrum Analyzer to allow for direct reading of power.

**IEEE 802.11g Mode**

Channel	Channel Frequency (MHz)	Final RF Power Level in 3KHz BW (dBm)	Minimum Limit (dBm)	Pass / Fail
Low	2412	-15.80	8	PASS
Middle	2437	-16.39	8	PASS
High	2462	-16.78	8	PASS

**Remark:**

1. At final test to get the worst-case emission at 6Mbps.
2. The cable assembly insertion loss of 11.5dB (including 10 dB pad and 1.5 dB cable) was Entered as an offset in the Spectrum Analyzer to allow for direct reading of power.



**IEEE 802.11n HT20 mode**

Channel	Channel Frequency (MHz)	Final RF Power Level in 3KHz BW (dBm)	Minimum Limit (dBm)	Pass / Fail
Low	2412	-15.46	8	PASS
Middle	2437	-15.28	8	PASS
High	2462	-16.10	8	PASS

**Remark:**

1. At final test to get the worst-case emission at 6.5Mbps.
2. The cable assembly insertion loss of 11.5dB (including 10 dB pad and 1.5 dB cable) was Entered as an offset in the Spectrum Analyzer to allow for direct reading of power.

**IEEE 802.11n HT40 mode**

Channel	Channel Frequency (MHz)	Final RF Power Level in 3KHz BW (dBm)	Minimum Limit (dBm)	Pass / Fail
Low	2422	-15.96	8	PASS
Middle	2437	-16.68	8	PASS
High	2452	-16.49	8	PASS

**Remark:**

1. At final test to get the worst-case emission at 13.5Mbps.
2. The cable assembly insertion loss of 11.5dB (including 10 dB pad and 1.5 dB cable) was Entered as an offset in the Spectrum Analyzer to allow for direct reading of power.



**POWER SPECTRAL DENSITY**

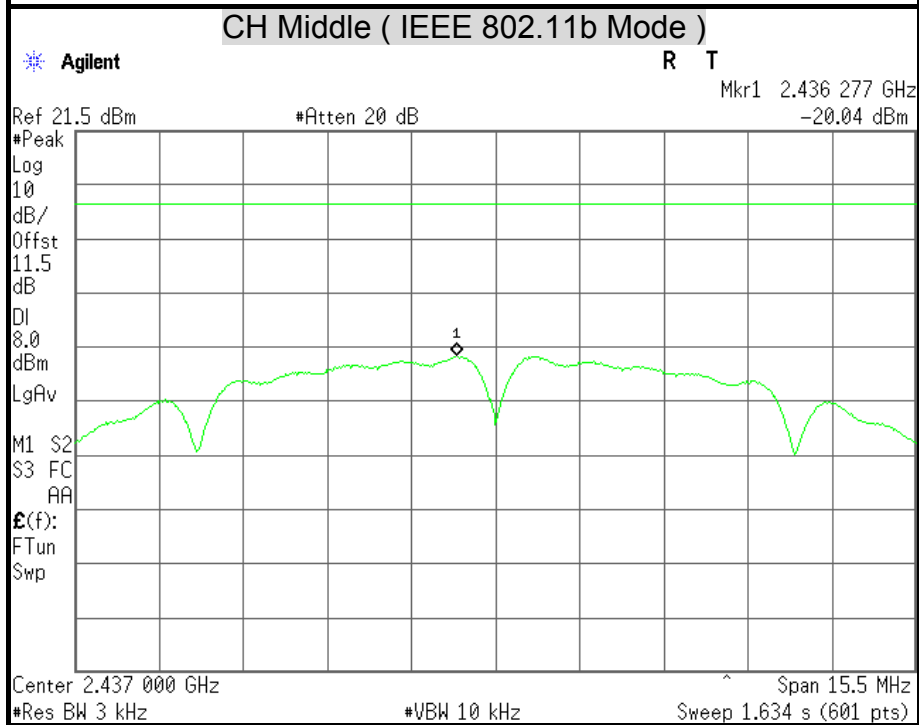
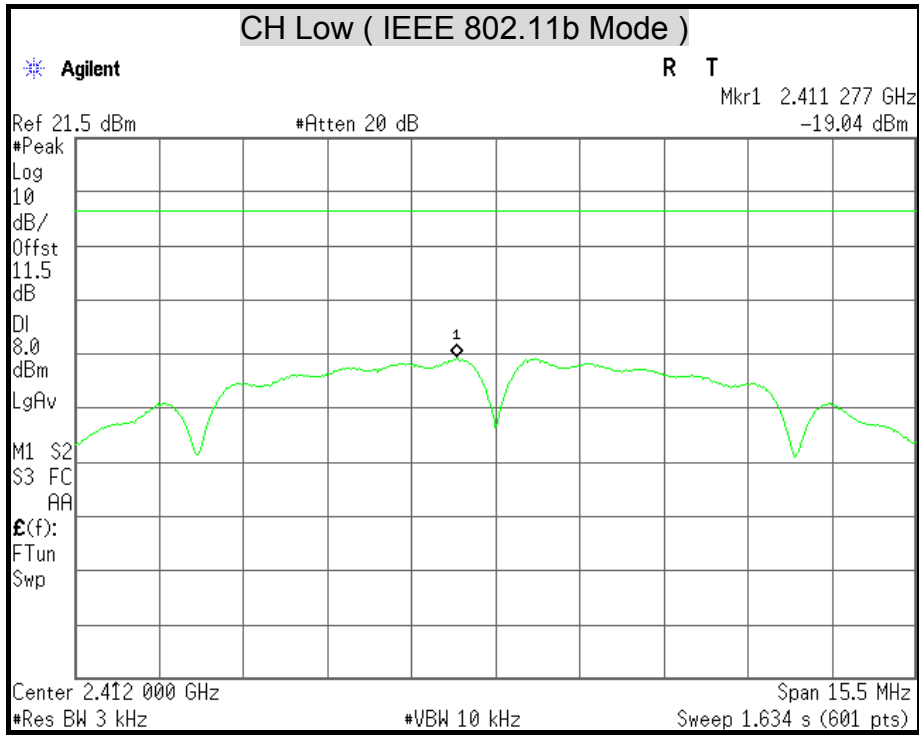

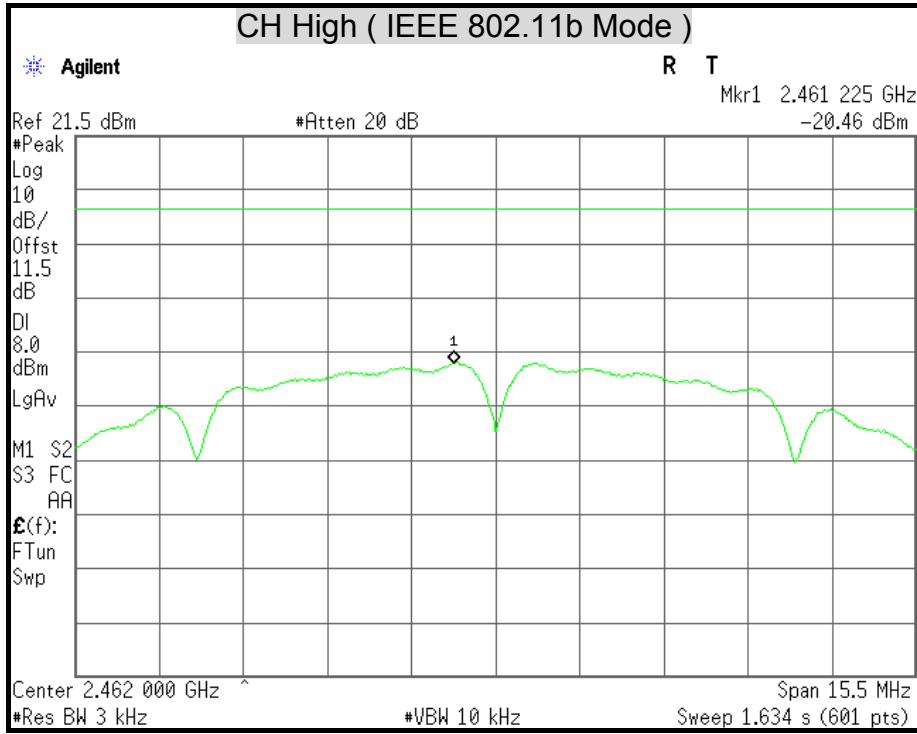

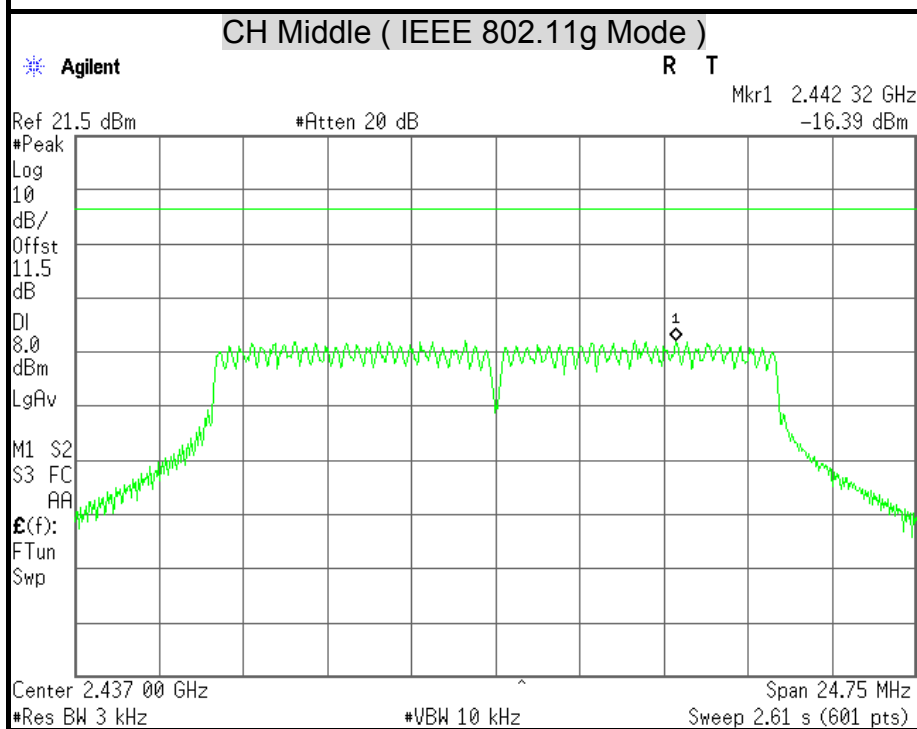
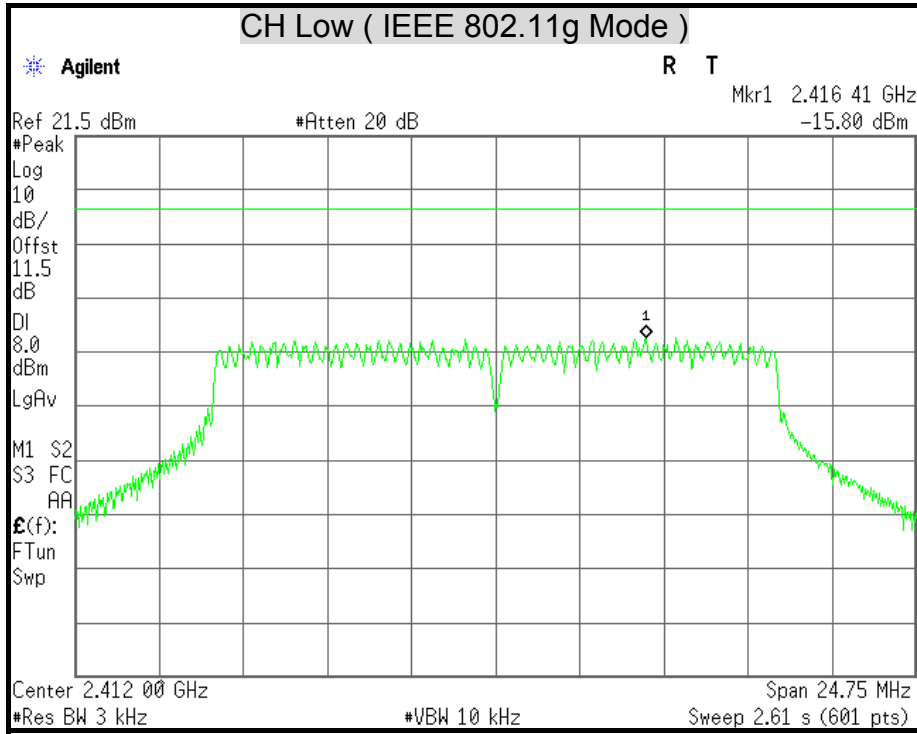



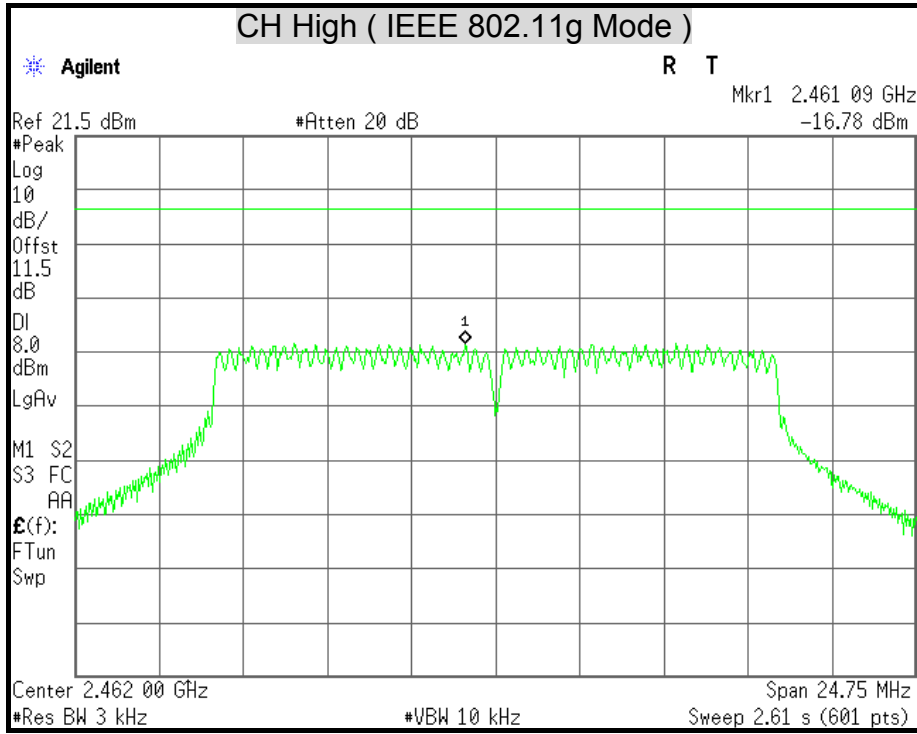

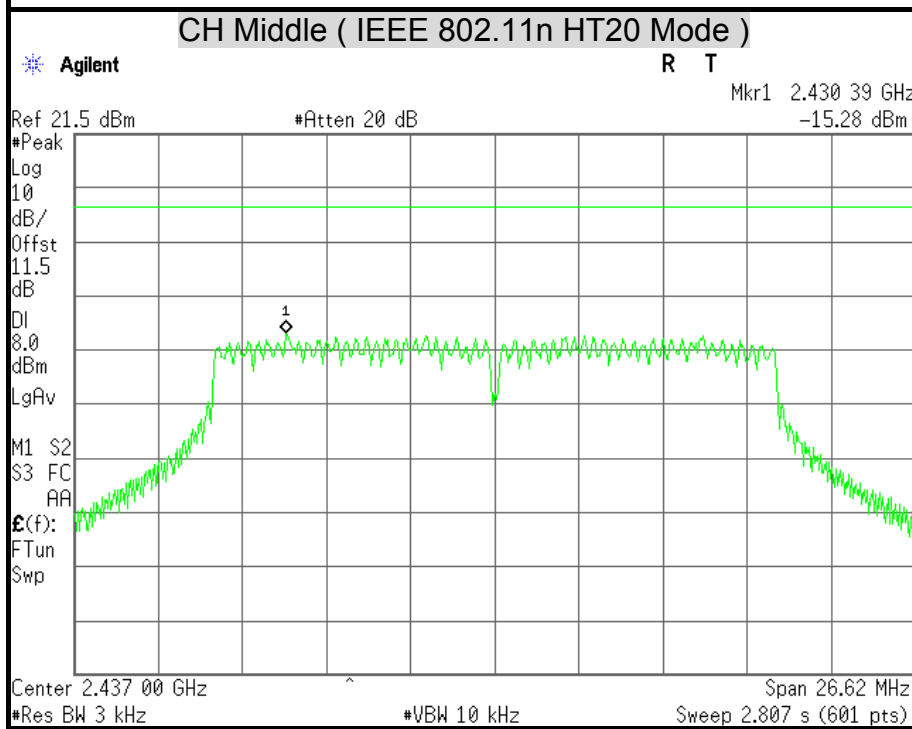
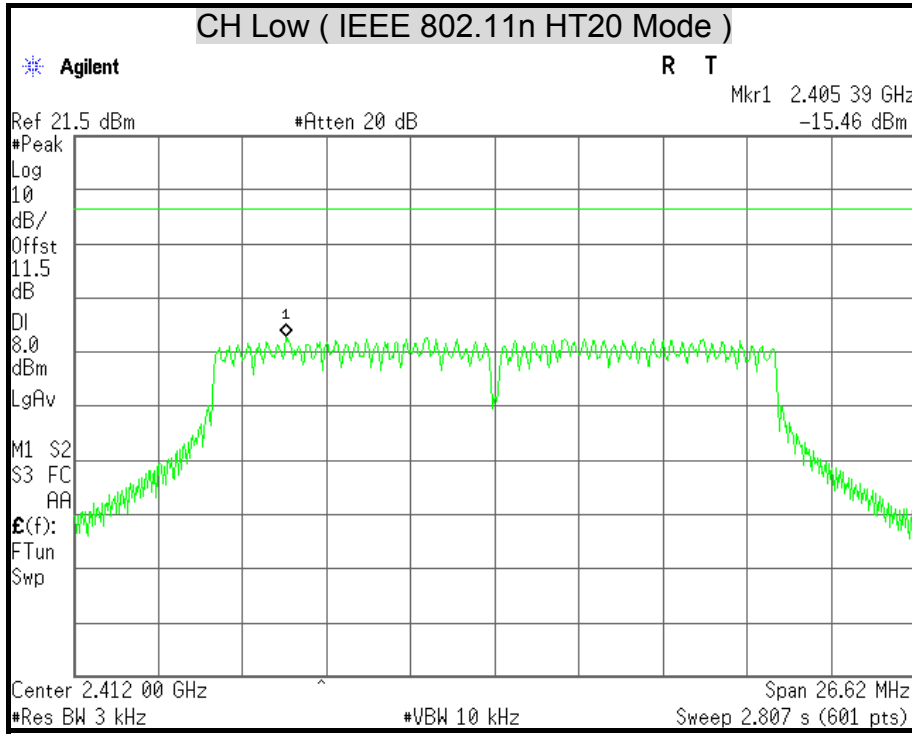

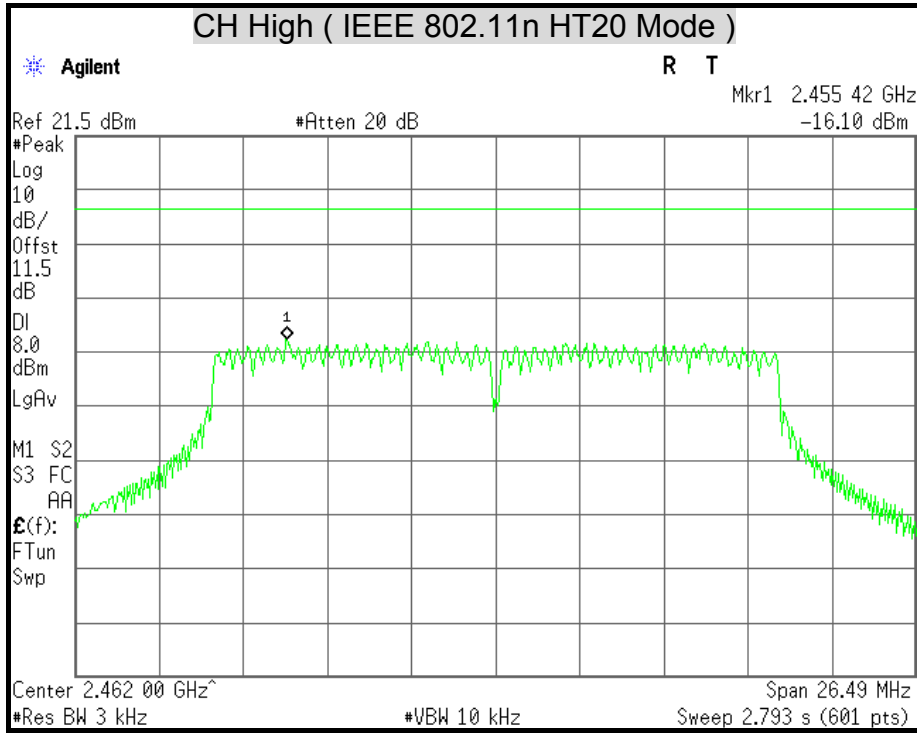

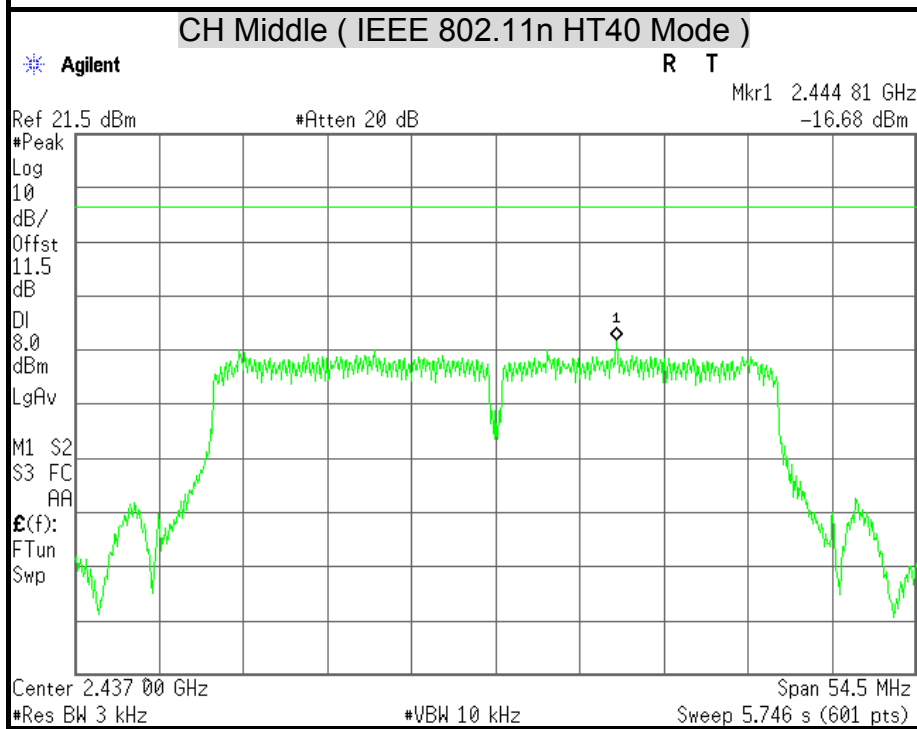
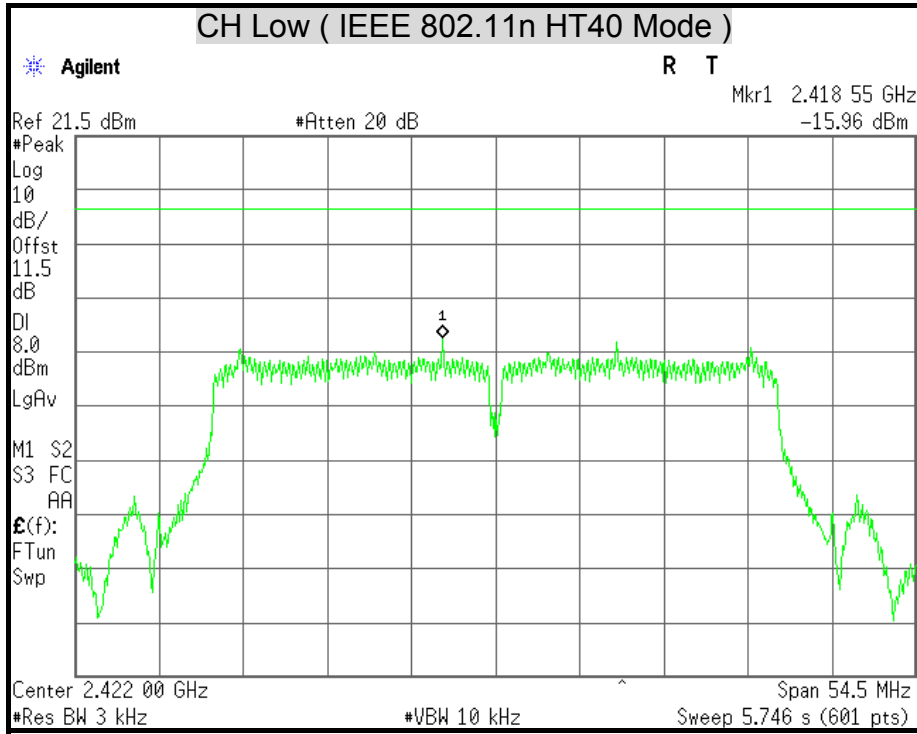

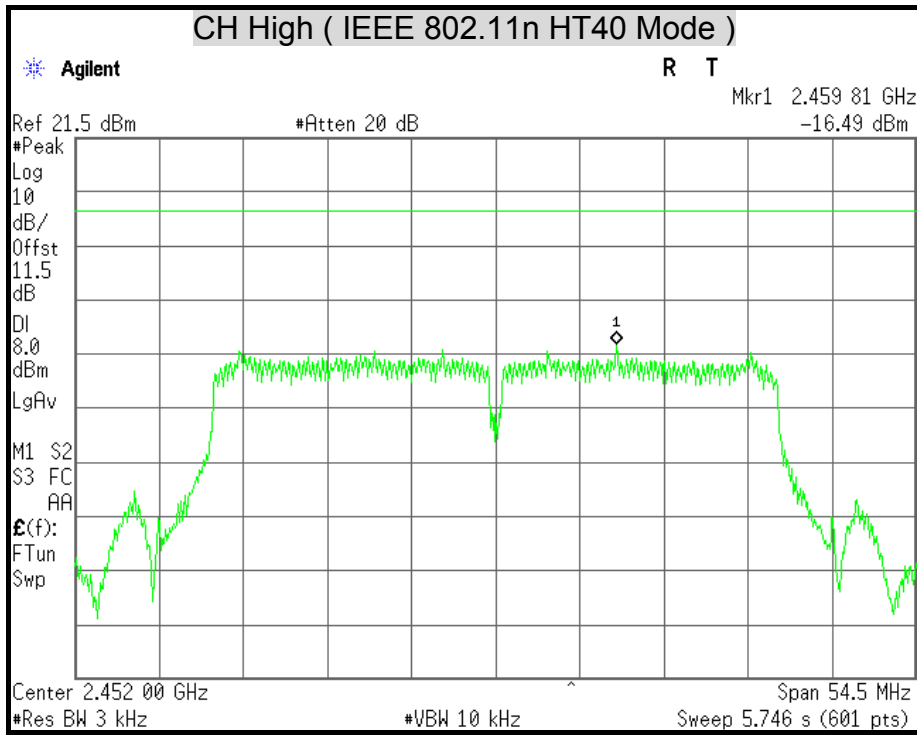



## 7.4 CONDUCTED SPURIOUS EMISSION

### LIMITS

§ 15.247(d) In any 100 kHz bandwidth outside the frequency band in which the spread spectrum intentional radiator is operating, the radio frequency power that is produced by the intentional radiator shall be at least 20 dB below that in the 100 kHz bandwidth within the band that contains the highest level of the desired power, based on either an RF conducted or a radiated measurement. Attenuation below the general limits specified in § 15.209(a) is not required. In addition, radiated emissions which fall in the restricted bands, as defined in § 15.205(a), must also comply with the radiated emission limits specified in § 15.209(a) (see § 15.205(c)).

### TEST EQUIPMENT

Name of Equipment	Manufacturer	Model	Serial Number	Calibration Due
Spectrum Analyzer	AGILENT	E4446A	MY43360132	06/14/2013

*Remark: Each piece of equipment is scheduled for calibration once a year.*

### TEST SETUP



### TEST PROCEDURE

The transmitter output is connected to a spectrum analyzer. The resolution bandwidth is set to 100 kHz. The video bandwidth is set to 300 kHz.

The spectrum from 30 MHz to 25 GHz is investigated with the transmitter set to the lowest, middle, and highest channels in the 2.4 GHz band.



**TEST RESULTS**

**OUT-OF-BAND SPURIOUS EMISSIONS-CONDUCTED MEASUREMENT**

**IEEE 802.11b Mode / CH Low / 2.38GHz ~ 2.5GHz**

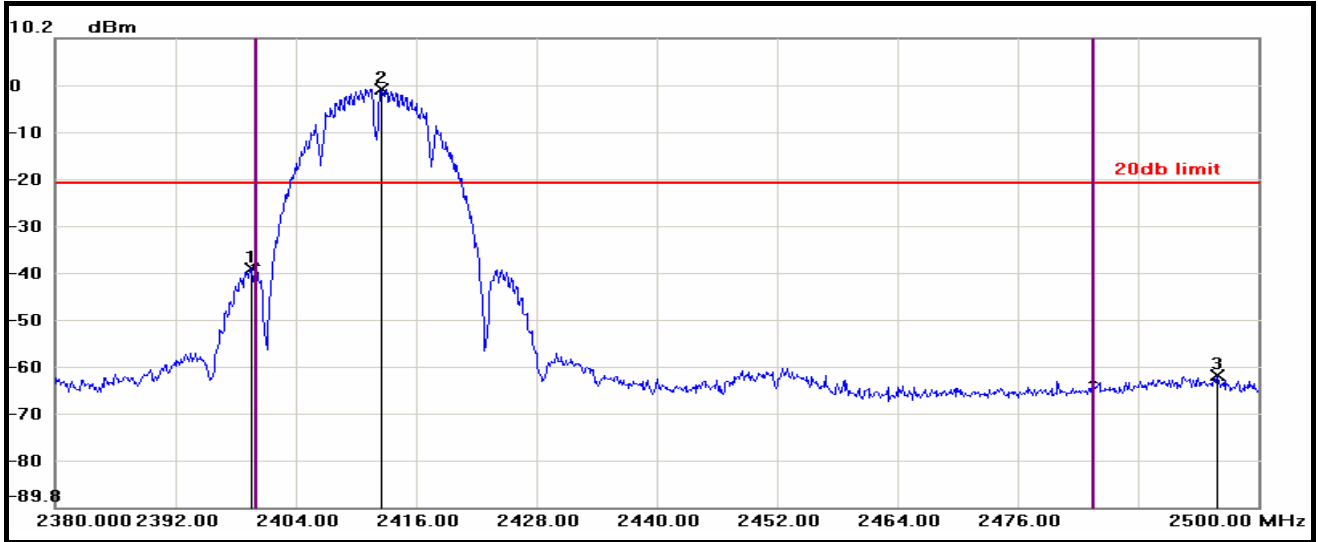

No.	Frequency(MHz)	Result(dBm)	Limit(dBm)	Margin(dBm)
1	2399.5600	-38.87	-20.73	-18.14
2	2412.5200	-0.73	-20.73	20.00
3	2495.9200	-61.72	-20.73	-40.99

**IEEE 802.11b Mode / CH Low / Full band**

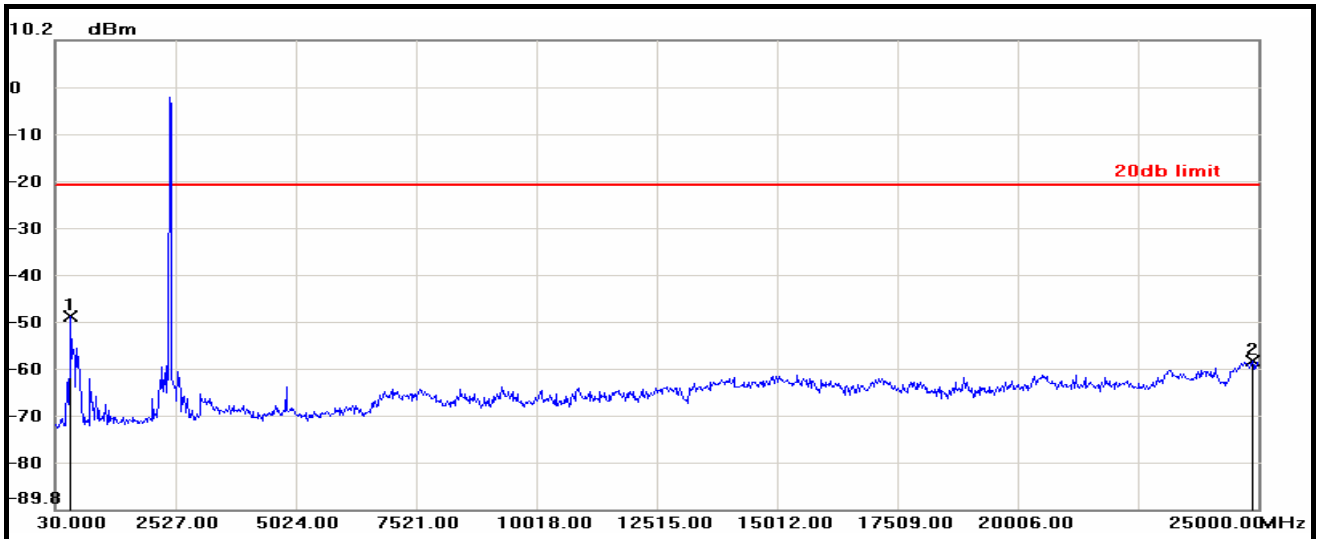

No.	Frequency(MHz)	Result(dBm)	Limit(dBm)	Margin(dBm)
1	354.6100	-48.64	-20.73	-27.91
2	24875.1500	-58.18	-20.73	-37.45



IEEE 802.11b Mode / CH Middle / 2.38GHz ~ 2.5GHz

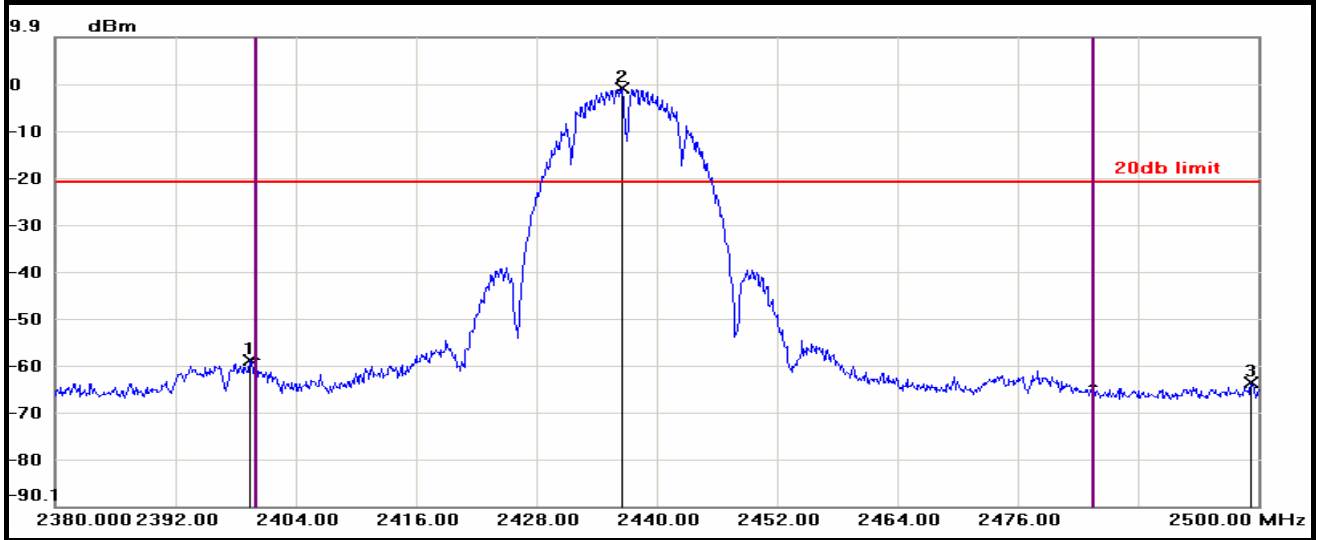

No.	Frequency(MHz)	Result(dBm)	Limit(dBm)	Margin(dBm)
1	2399.4400	-59.05	-20.99	-38.06
2	2436.5200	-0.99	-20.99	20.00
3	2499.2800	-63.80	-20.99	-42.81

IEEE 802.11b Mode / CH Middle / Full band

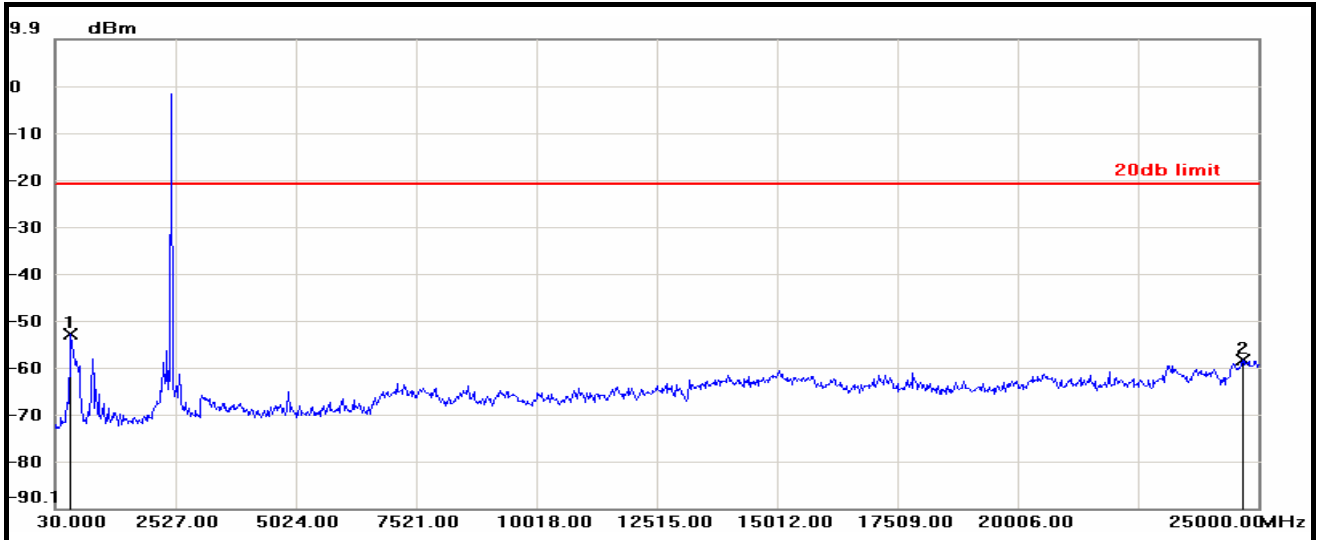

No.	Frequency(MHz)	Result(dBm)	Limit(dBm)	Margin(dBm)
1	354.6100	-52.90	-20.99	-31.91
2	24675.3900	-58.45	-20.99	-37.46





IEEE 802.11b Mode / CH High / 2.38GHz ~ 2.5GHz

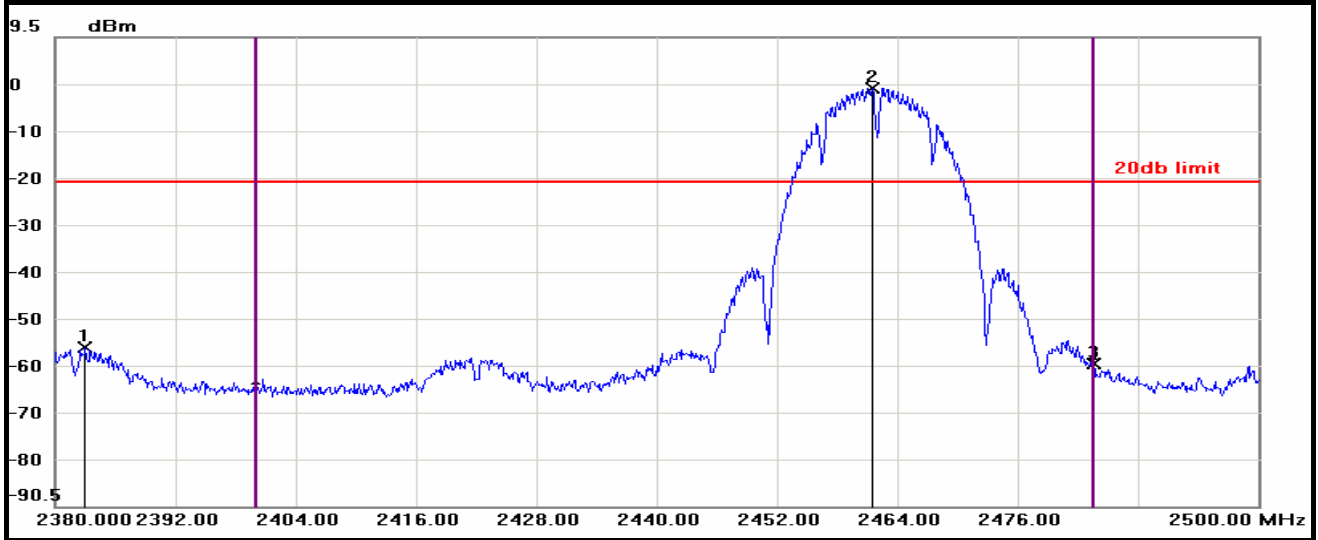

No.	Frequency(MHz)	Result(dBm)	Limit(dBm)	Margin(dBm)
1	2383.0000	-56.53	-21.32	-35.21
2	2461.4800	-1.32	-21.32	20.00
3	2483.5600	-60.15	-21.32	-38.83

IEEE 802.11b Mode / CH High / Full band

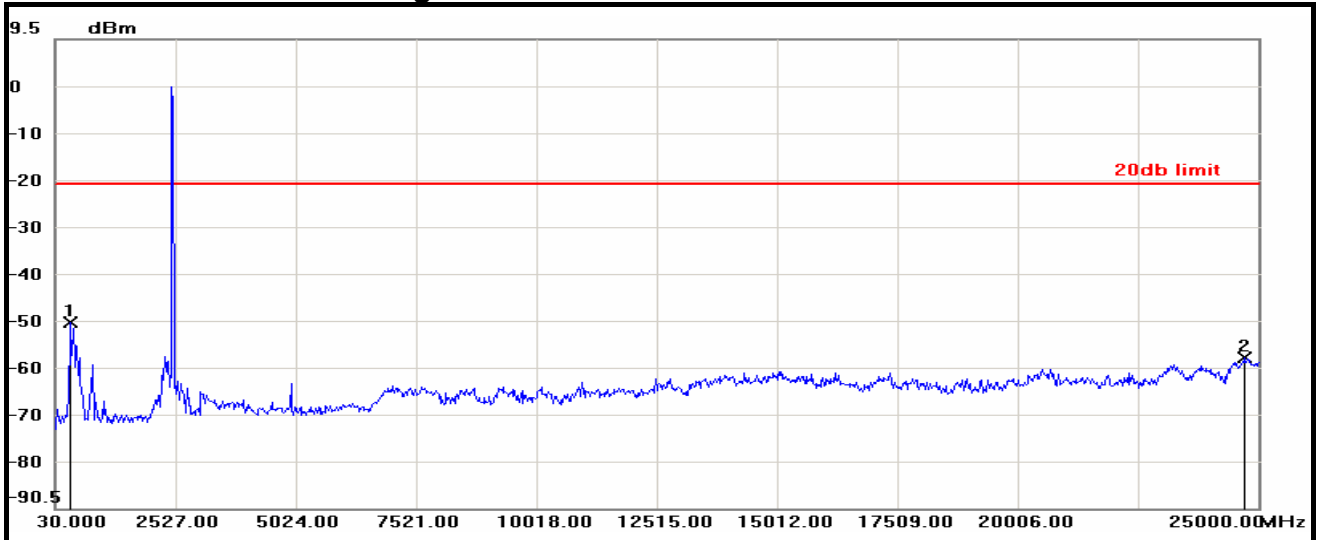

No.	Frequency(MHz)	Result(dBm)	Limit(dBm)	Margin(dBm)
1	354.6100	-50.96	-21.32	-29.64
2	24725.3300	-58.38	-21.32	-37.06



IEEE 802.11g Mode / CH Low / 2.38GHz ~ 2.5GHz

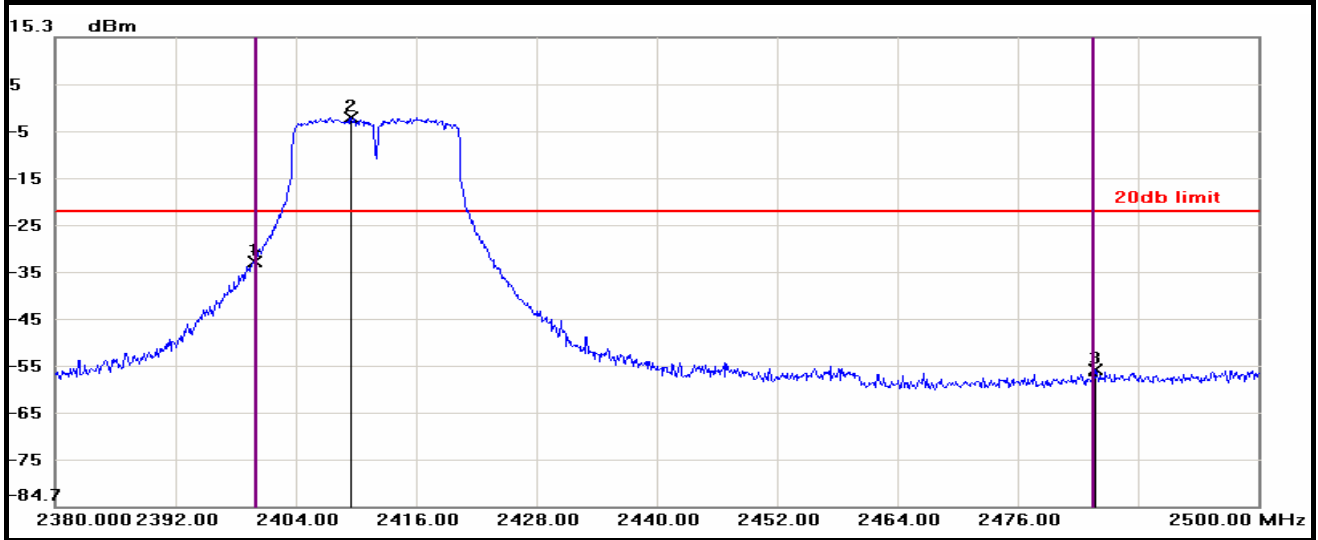

No.	Frequency(MHz)	Result(dBm)	Limit(dBm)	Margin(dBm)
1	2399.9200	-32.53	-21.75	-10.78
2	2409.5200	-1.75	-21.75	20.00
3	2483.8000	-55.62	-21.75	-33.87

IEEE 802.11g Mode / CH Low / Full band

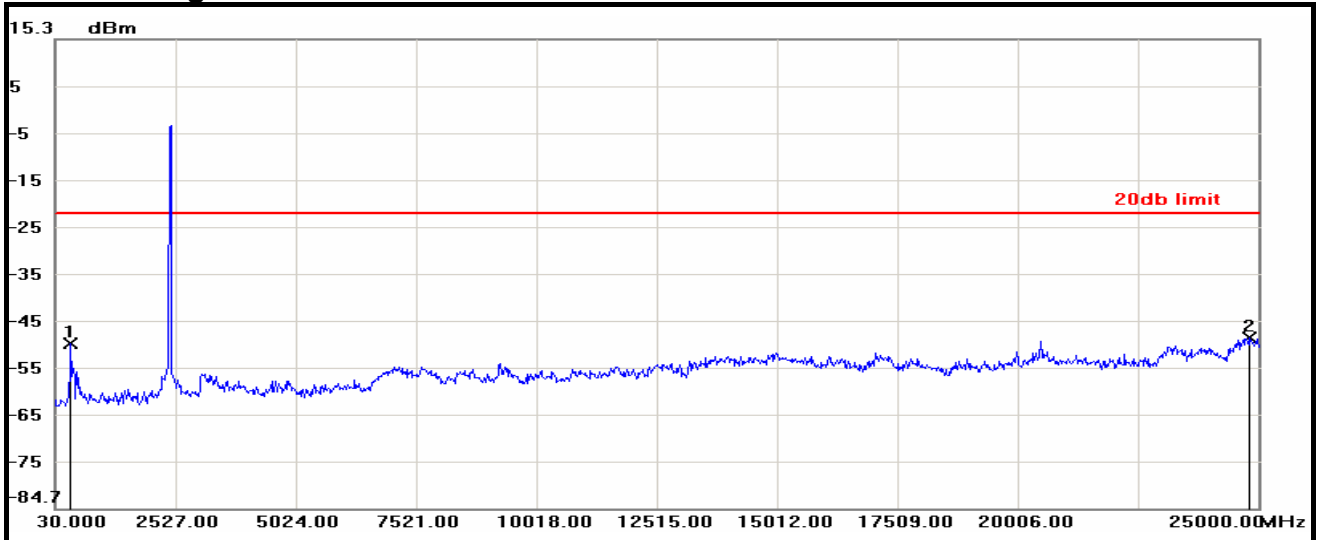

No.	Frequency(MHz)	Result(dBm)	Limit(dBm)	Margin(dBm)
1	354.6100	-49.60	-21.75	-27.85
2	24825.2100	-48.27	-21.75	-26.52



IEEE 802.11g Mode / CH Middle / 2.38GHz ~ 2.5GHz

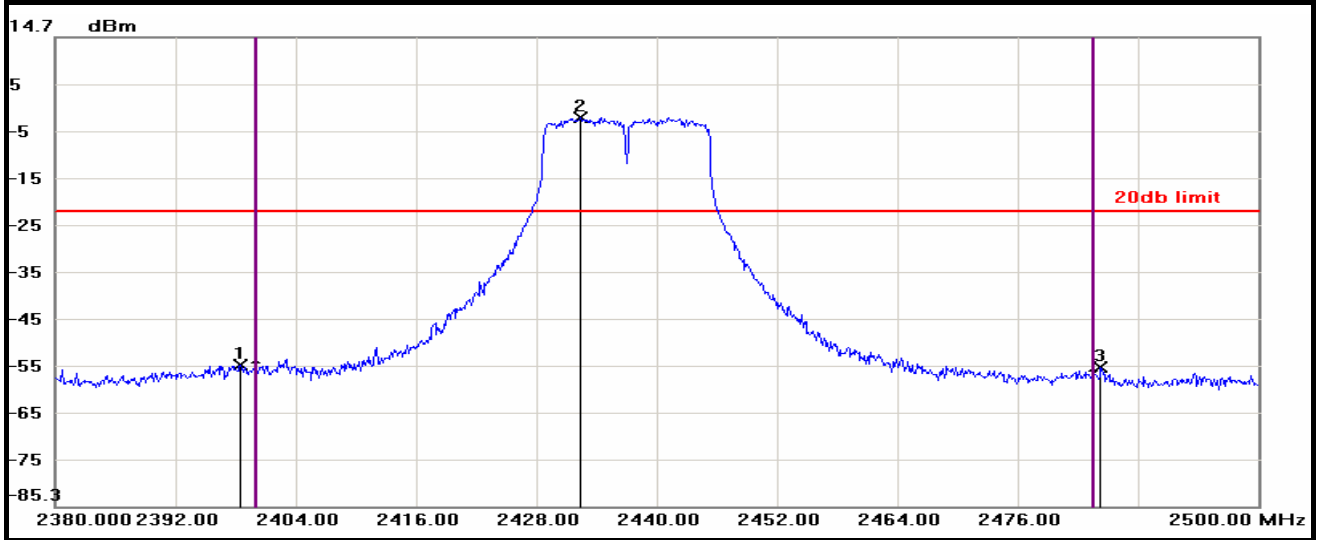

No.	Frequency(MHz)	Result(dBm)	Limit(dBm)	Margin(dBm)
1	2398.4800	-55.09	-22.40	-32.69
2	2432.4400	-2.40	-22.40	20.00
3	2484.2800	-55.53	-22.40	-33.13

IEEE 802.11g Mode / CH Middle / Full band

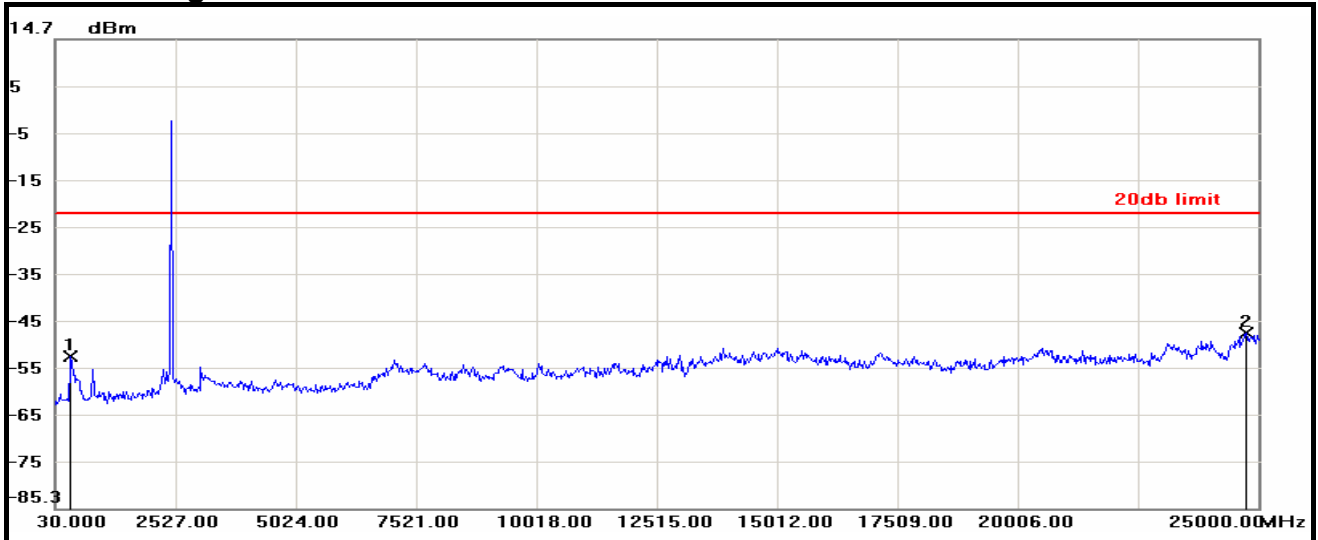

No.	Frequency(MHz)	Result(dBm)	Limit(dBm)	Margin(dBm)
1	354.6100	-52.95	-22.40	-30.55
2	24750.3000	-47.98	-22.40	-25.58



IEEE 802.11g Mode / CH High / 2.38GHz ~ 2.5GHz

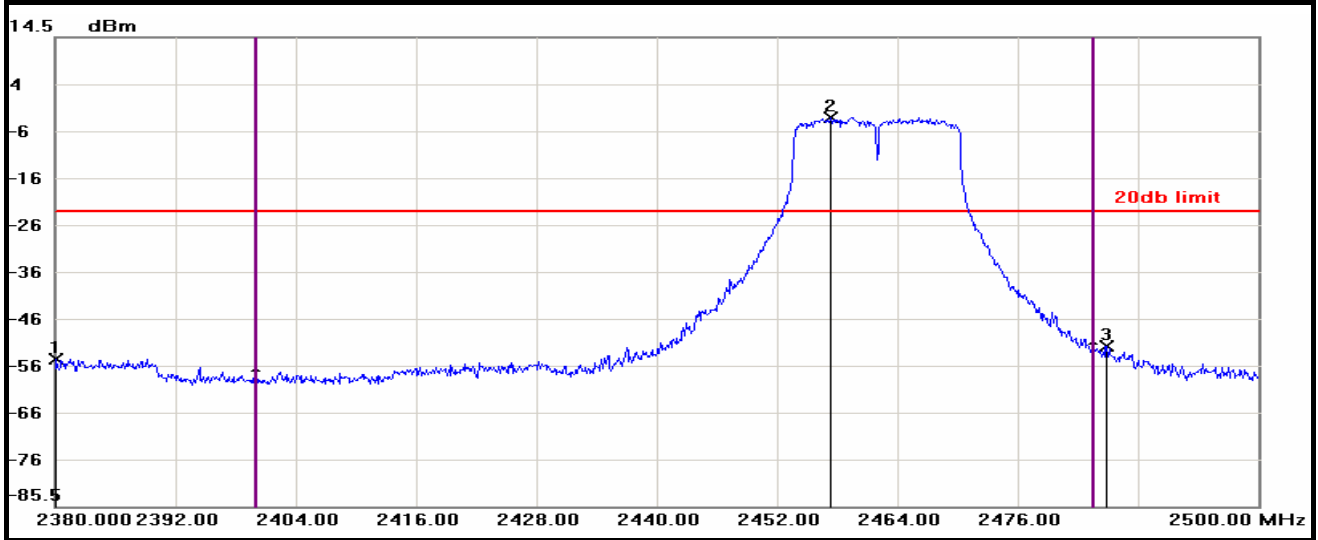

No.	Frequency(MHz)	Result(dBm)	Limit(dBm)	Margin(dBm)
1	2380.1200	-54.08	-22.69	-31.39
2	2457.4000	-2.69	-22.69	20.00
3	2484.8800	-51.42	-22.69	-28.73

IEEE 802.11g Mode / CH High / Full band

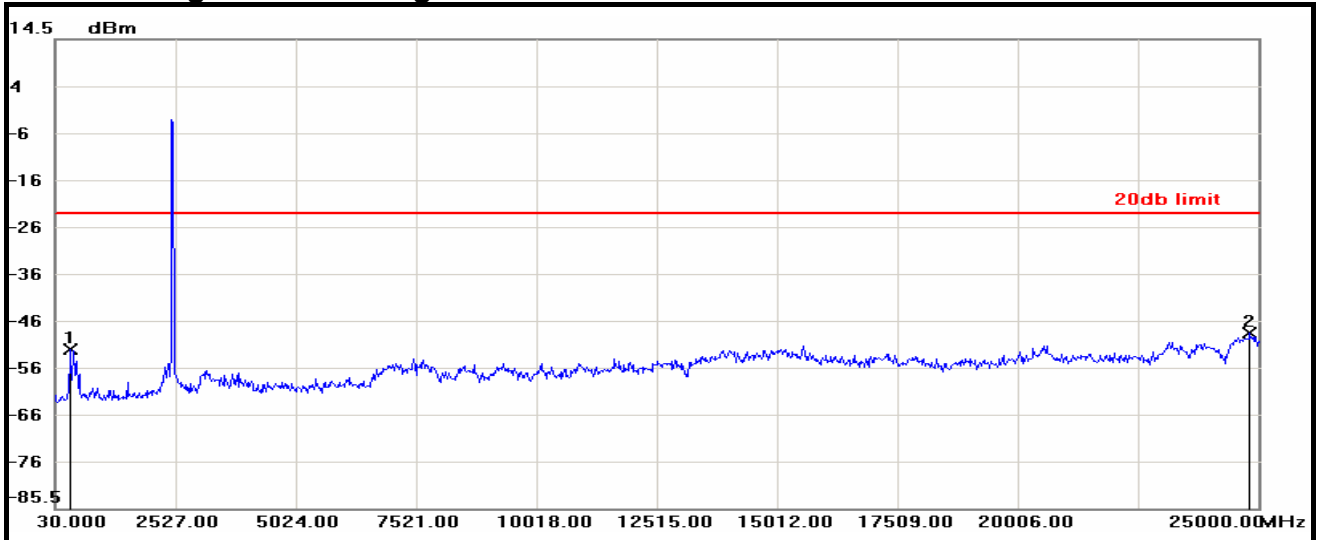

No.	Frequency(MHz)	Result(dBm)	Limit(dBm)	Margin(dBm)
1	354.6100	-51.55	-22.69	-28.86
2	24825.2100	-48.22	-22.69	-25.53



IEEE 802.11n HT20 Mode / CH Low / 2.38GHz ~ 2.5GHz

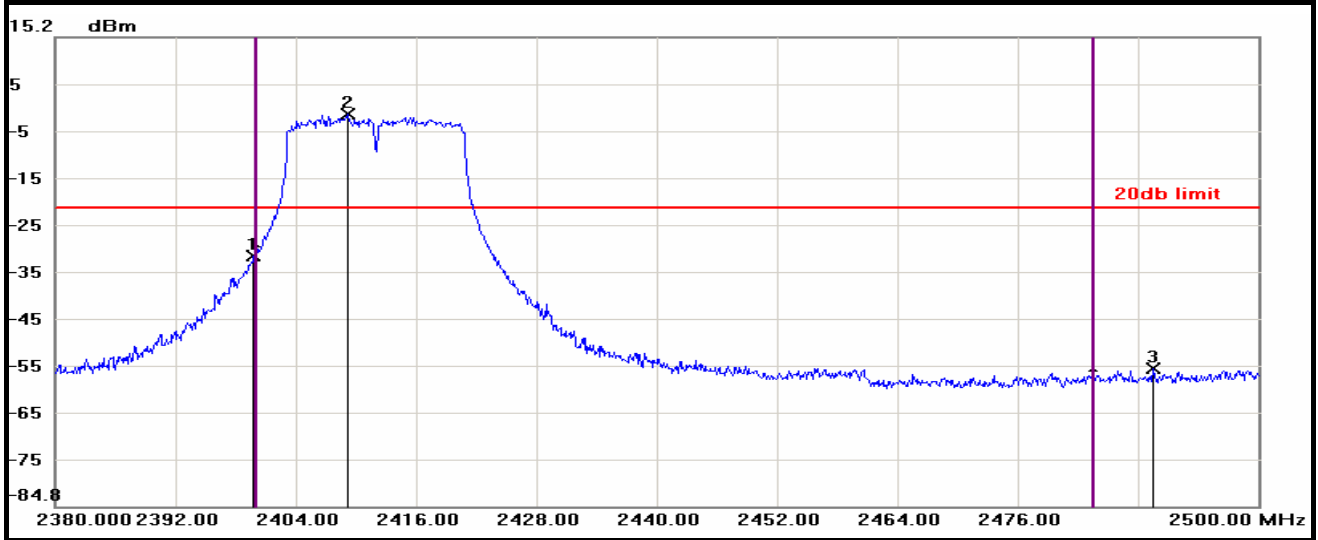

No.	Frequency(MHz)	Result(dBm)	Limit(dBm)	Margin(dBm)
1	2399.8000	-31.40	-21.28	-10.12
2	2409.1600	-1.28	-21.28	20.00
3	2489.5600	-55.51	-21.28	-34.23

IEEE 802.11n HT20 Mode / CH Low / Full band

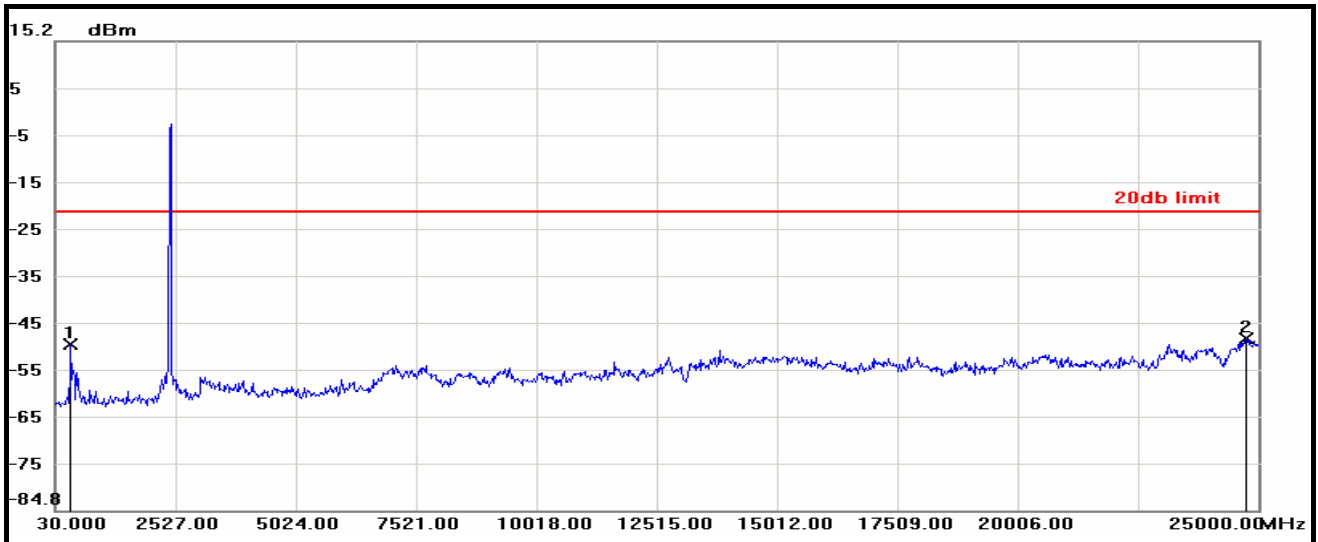

No.	Frequency(MHz)	Result(dBm)	Limit(dBm)	Margin(dBm)
1	354.6100	-49.40	-21.28	-28.12
2	24750.3000	-48.28	-21.28	-27.00



IEEE 802.11n HT20 Mode / CH Middle / 2.38GHz ~ 2.5GHz

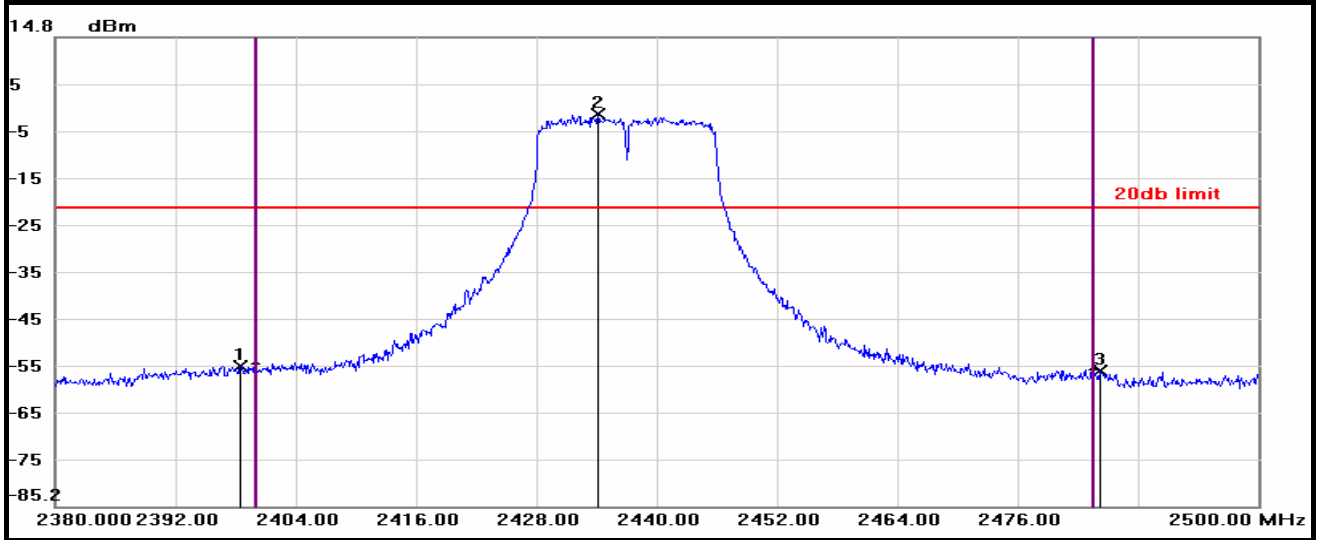

No.	Frequency(MHz)	Result(dBm)	Limit(dBm)	Margin(dBm)
1	2398.4800	-55.24	-21.65	-33.59
2	2434.1200	-1.65	-21.65	20.00
3	2484.1600	-56.40	-21.65	-34.75

IEEE 802.11n HT20 Mode / CH Middle / Full band

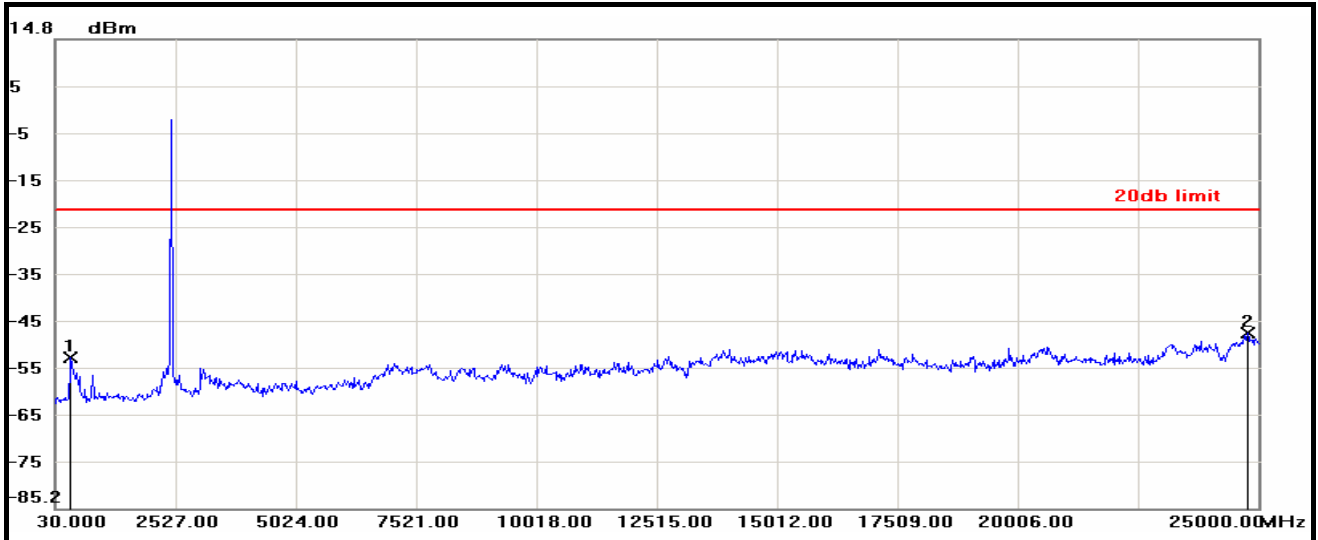

No.	Frequency(MHz)	Result(dBm)	Limit(dBm)	Margin(dBm)
1	354.6100	-53.05	-21.65	-31.40
2	24775.2700	-47.86	-21.65	-26.21



IEEE 802.11n HT20 Mode / CH High / 2.38GHz ~ 2.5GHz

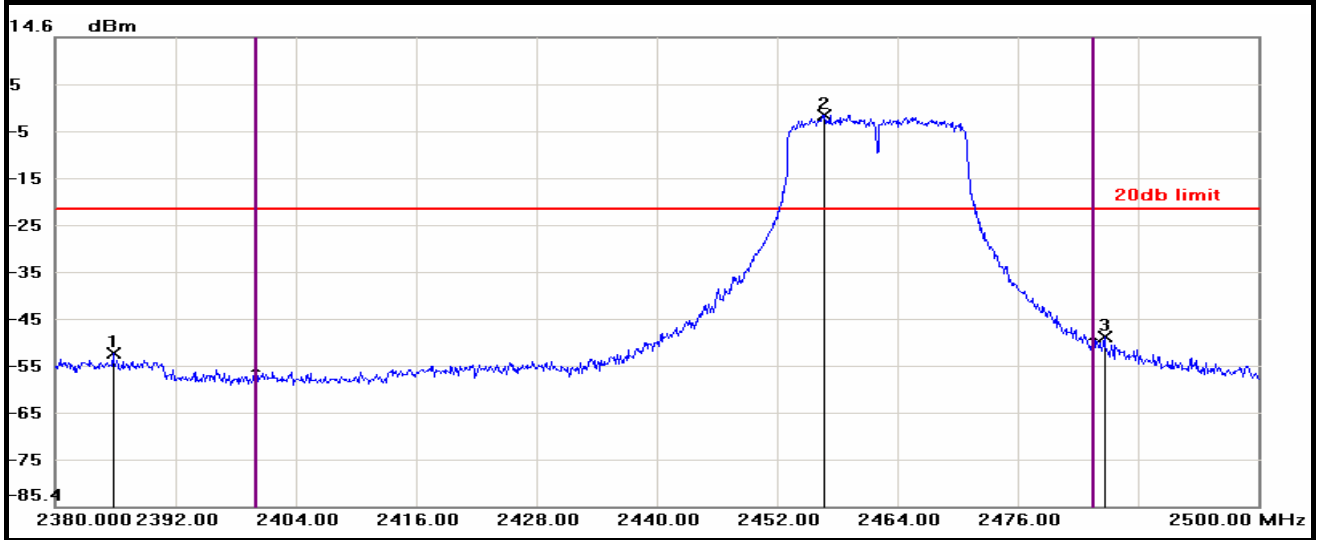

No.	Frequency(MHz)	Result(dBm)	Limit(dBm)	Margin(dBm)
1	2385.7600	-52.69	-22.01	-30.68
2	2456.6800	-2.01	-22.01	20.00
3	2484.6400	-49.42	-22.01	-27.41

IEEE 802.11n HT20 Mode / CH High / Full band

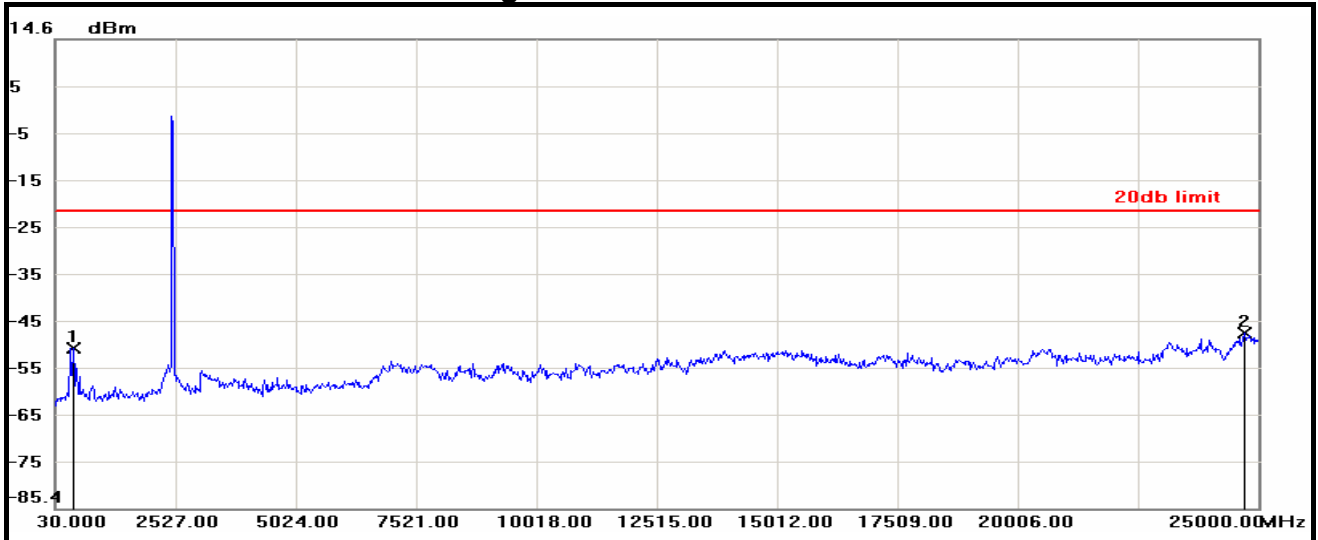

No.	Frequency(MHz)	Result(dBm)	Limit(dBm)	Margin(dBm)
1	404.5500	-51.35	-22.01	-29.34
2	24700.3600	-47.95	-22.01	-25.94



IEEE 802.11n HT40 Mode / CH Low / 2.38GHz ~ 2.5GHz

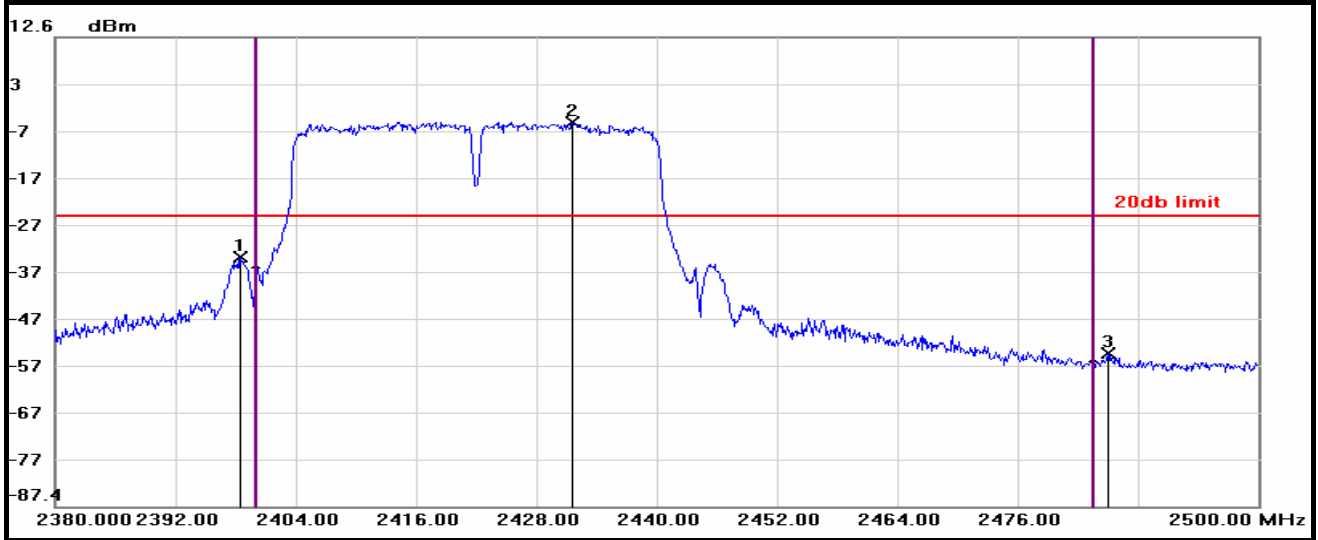

No.	Frequency(MHz)	Result(dBm)	Limit(dBm)	Margin(dBm)
1	2398.4800	-34.31	-25.47	-8.84
2	2431.6000	-5.47	-25.47	20.00
3	2485.0000	-54.87	-25.47	-29.40

IEEE 802.11n HT40 Mode / CH Low / Full band

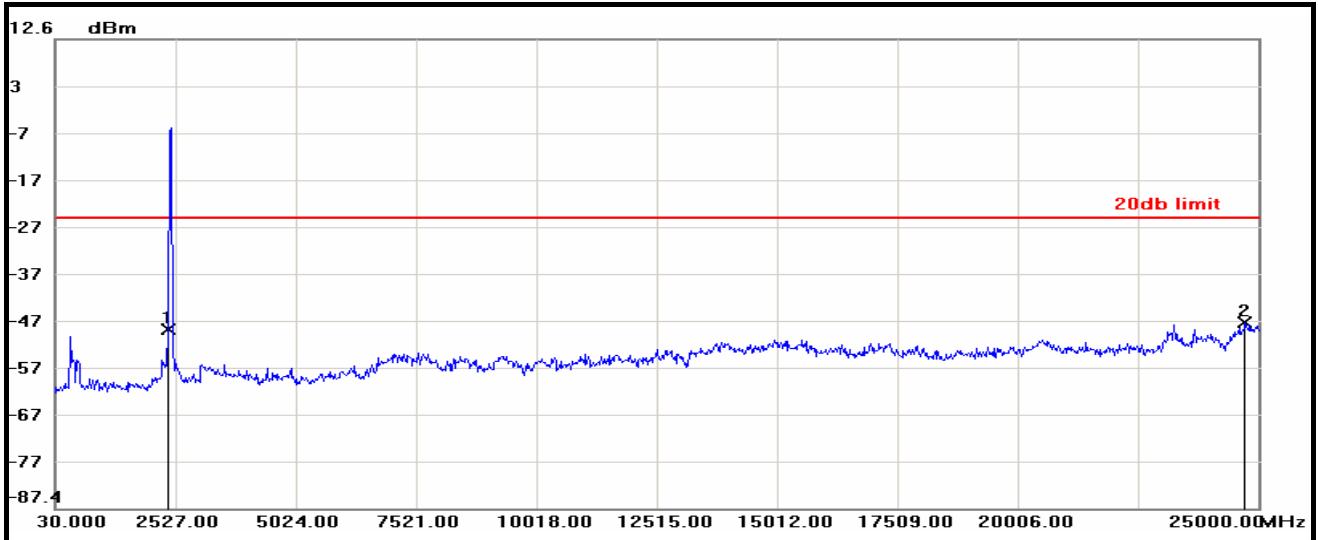

No.	Frequency(MHz)	Result(dBm)	Limit(dBm)	Margin(dBm)
1	2377.1800	-49.17	-25.47	-23.70
2	24725.3300	-47.82	-25.47	-22.35





IEEE 802.11n HT40 Mode / CH Middle / 2.38GHz ~ 2.5GHz

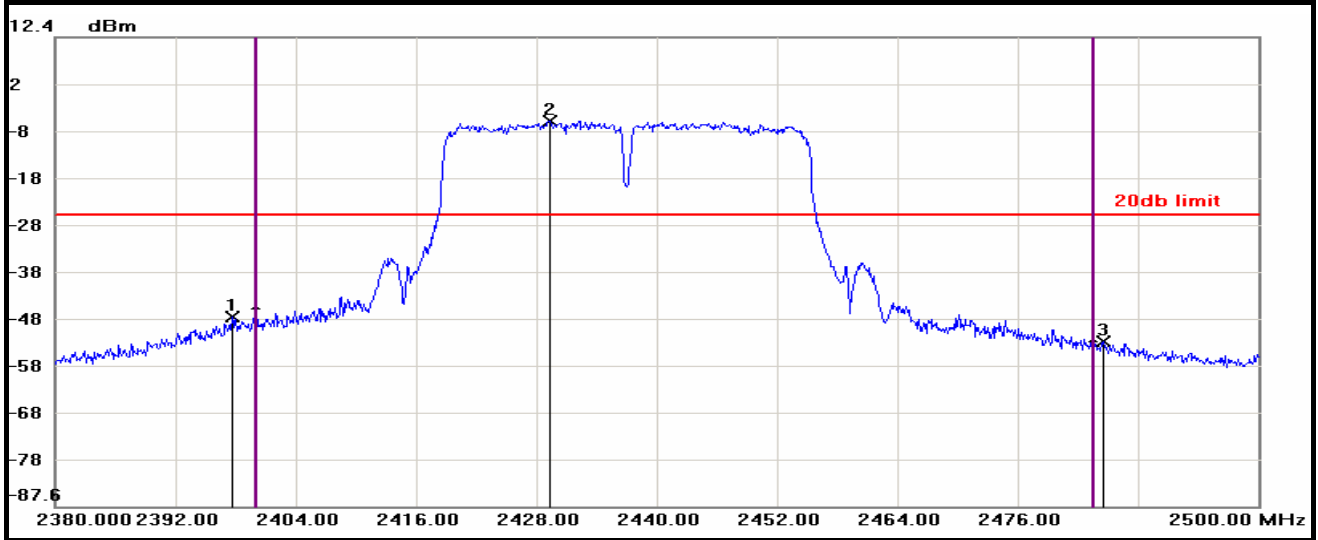

No.	Frequency(MHz)	Result(dBm)	Limit(dBm)	Margin(dBm)
1	2397.6400	-47.30	-25.43	-21.87
2	2429.3200	-5.43	-25.43	20.00
3	2484.5200	-52.35	-25.43	-26.92

IEEE 802.11n HT40 Mode / CH Middle / Full band

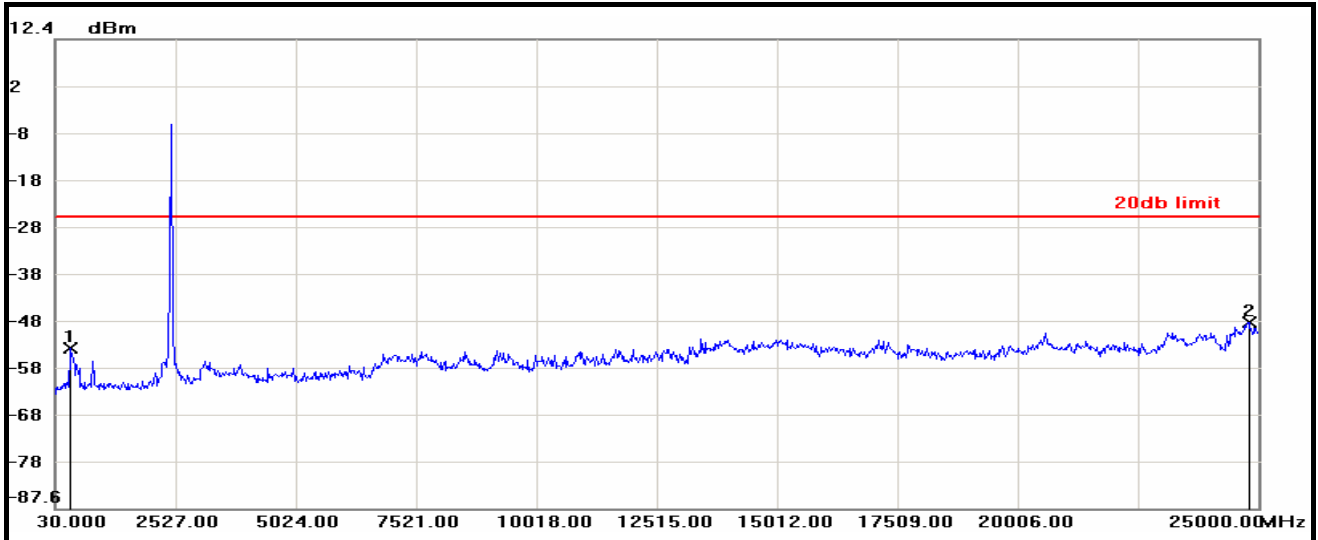

No.	Frequency(MHz)	Result(dBm)	Limit(dBm)	Margin(dBm)
1	354.6100	-53.41	-25.43	-27.98
2	24800.2400	-47.85	-25.43	-22.42



IEEE 802.11n HT40 Mode / CH High / 2.38GHz ~ 2.5GHz

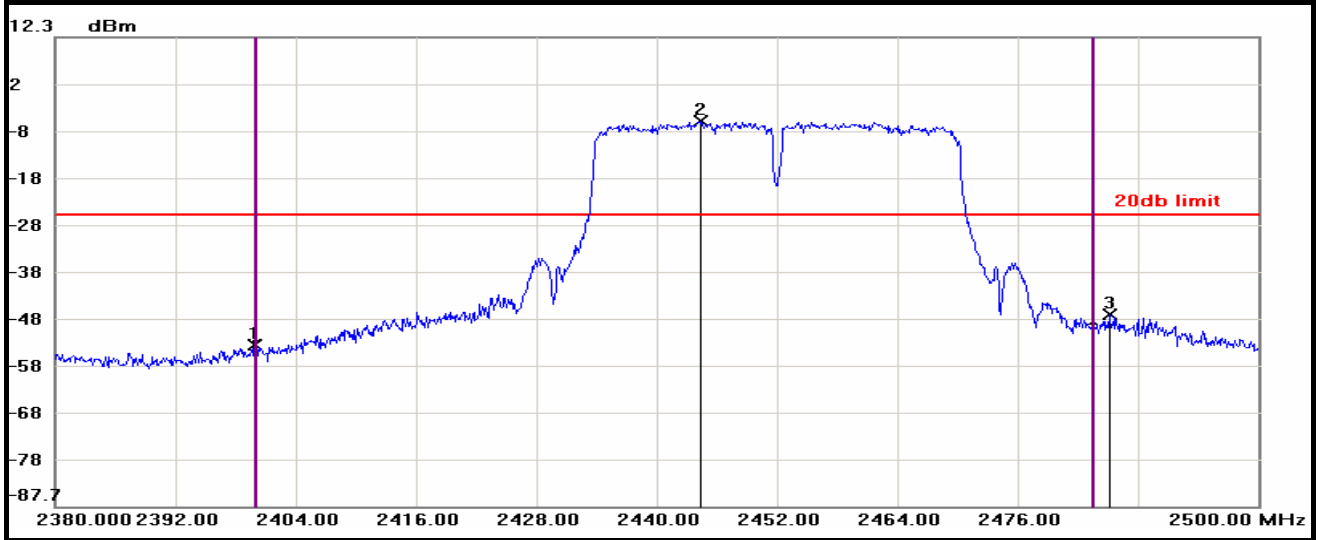

No.	Frequency(MHz)	Result(dBm)	Limit(dBm)	Margin(dBm)
1	2399.9200	-53.46	-25.71	-27.75
2	2444.3200	-5.71	-25.71	20.00
3	2485.1200	-46.92	-25.71	-21.21

IEEE 802.11n HT40 Mode / CH High / Full band

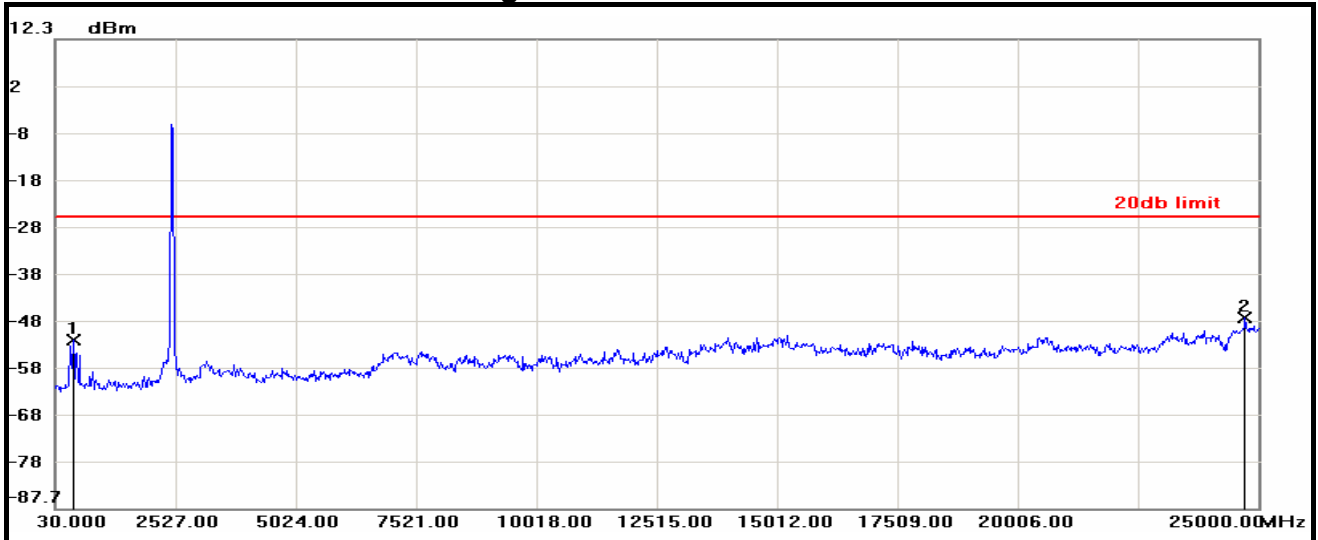

No.	Frequency(MHz)	Result(dBm)	Limit(dBm)	Margin(dBm)
1	404.5500	-51.96	-25.71	-26.25
2	24725.3300	-47.08	-25.71	-21.37



### 7.5 RADIATED EMISSION

#### LIMITS

(1) According to § 15.205 (a) Except as shown in paragraph (d) of this section, only spurious emissions are permitted in any of the frequency bands listed below:

MHz	MHz	MHz	GHz
0.090 - 0.110	16.42 - 16.423	399.9 - 410	4.5 - 5.15
<sup>1</sup> 0.495 - 0.505	16.69475 - 16.69525	608 - 614	5.35 - 5.46
2.1735 - 2.1905	16.80425 - 16.80475	960 - 1240	7.25 - 7.75
4.125 - 4.128	25.5 - 25.67	1300 - 1427	8.025 - 8.5
4.17725 - 4.17775	37.5 - 38.25	1435 - 1626.5	9.0 - 9.2
4.20725 - 4.20775	73 - 74.6	1645.5 - 1646.5	9.3 - 9.5
6.215 - 6.218	74.8 - 75.2	1660 - 1710	10.6 - 12.7
6.26775 - 6.26825	108 - 121.94	1718.8 - 1722.2	13.25 - 13.4
6.31175 - 6.31225	123 - 138	2200 - 2300	14.47 - 14.5
8.291 - 8.294	149.9 - 150.05	2310 - 2390	15.35 - 16.2
8.362 - 8.366	156.52475 - 156.52525	2483.5 - 2500	17.7 - 21.4
8.37625 - 8.38675	156.7 - 156.9	2655 - 2900	22.01 - 23.12
8.41425 - 8.41475	162.0125 - 167.17	3260 - 3267	23.6 - 24.0
12.29 - 12.293	167.72 - 173.2	3332 - 3339	31.2 - 31.8
12.51975 - 12.52025	240 - 285	3345.8 - 3338	36.43 - 36.5
12.57675 - 12.57725	322 - 335.4	3600 - 4400	( <sup>2</sup> )
13.36 - 13.41			

**Remark:**

- 1. <sup>1</sup> Until February 1, 1999, this restricted band shall be 0.490-0.510 MHz.
- 2. <sup>2</sup> Above 38.6

(2) According to § 15.205 (b) Except as provided in paragraphs (d) and (e), the field strength of emissions appearing within these frequency bands shall not exceed the limits shown in Section 15.209. At frequencies equal to or less than 1000 MHz, compliance with the limits in Section 15.209 shall be demonstrated using measurement instrumentation employing a CISPR quasi-peak detector. Above 1000 MHz, compliance with the emission limits in Section 15.209 shall be demonstrated based on the average value of the measured emissions. The provisions in Section 15.35 apply to these measurements.



(3) According to § 15.209 (a) Except as provided elsewhere in this Subpart, the emissions from an intentional radiator shall not exceed the field strength levels specified in the following table :

Frequency (MHz)	Field Strength (microvolts/meter)	Measurement Distance (meters)
0.009 – 0.490	2400/F(KHz)	300
0.490 – 1.705	24000/F(KHz)	30
1.705 – 30.0	30	30
30 - 88	100 **	3
88 - 216	150 **	3
216 - 960	200 **	3
Above 960	500	3

**Remark:** \*\*Except as provided in paragraph (g), fundamental emissions from intentional radiators operating under this Section shall not be located in the frequency bands 54-72 MHz, 76-88 MHz, 174-216 MHz or 470-806 MHz. However, operation within these frequency bands is permitted under other sections of this Part, e.g., Sections 15.231 and 15.241.

(4) According to § 15.209 (b) In the emission table above, the tighter limit applies at the band edges.

**TEST EQUIPMENT**

**Radiated Emission / 966Chamber\_B**

Name of Equipment	Manufacture	Model	Serial Number	Calibration Due
Spectrum Analyzer	Agilent	E4446A	MY46180323	04/22/2013
EMI Receiver	ROHDE & SCHWARZ	ESCS 30	826547/004	10/27/2012
Broadband Hybrid Bi-Log Antenna	Sunol Sciences	JB1	A100209-4	10/05/2012
Double-Ridged Waveguide Horn	ETS-LINDGREN	3117	00078733	12/06/2012
Horn Antenna	COM-POWER	AH-840	03077	12/06/2012
Pre-Amplifier	Agilent	8447D	2944A10052	07/17/2013
Pre-Amplifier	Agilent	8449B	3008A01916	07/17/2013
LOOP Antenna	EMCO	6502	8905-2356	06/10/2013
Notch Filters Band Reject	Micro-Tronics	BRM05702-01	026	N.C.R

**Remark:** 1. Each piece of equipment is scheduled for calibration once a year.  
2. N.C.R = No Calibration Request.



**TEST SETUP**

The diagram below shows the test setup that is utilized to make the measurements for emission from below 1GHz.

**9kHz ~ 30MHz**

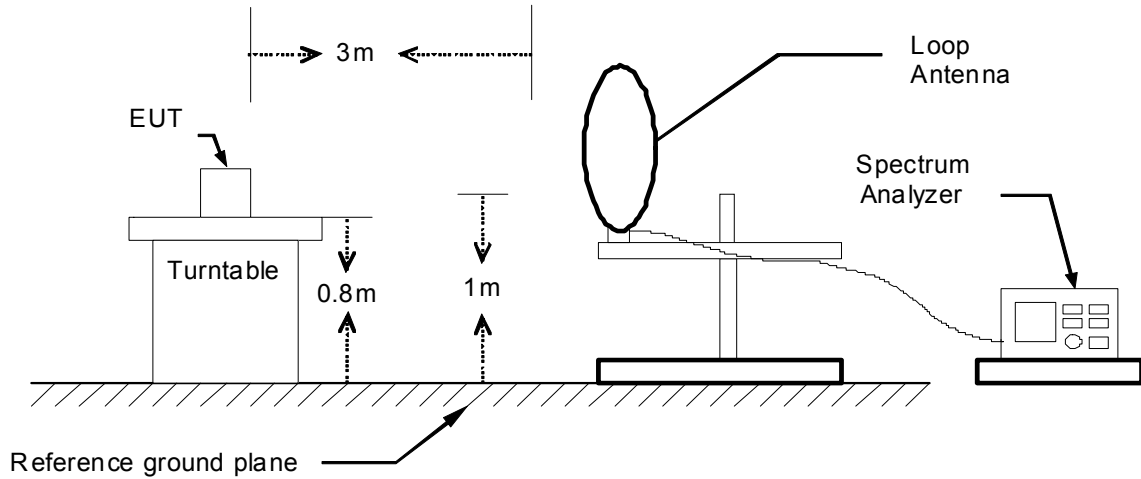

**30MHz ~ 1GHz**

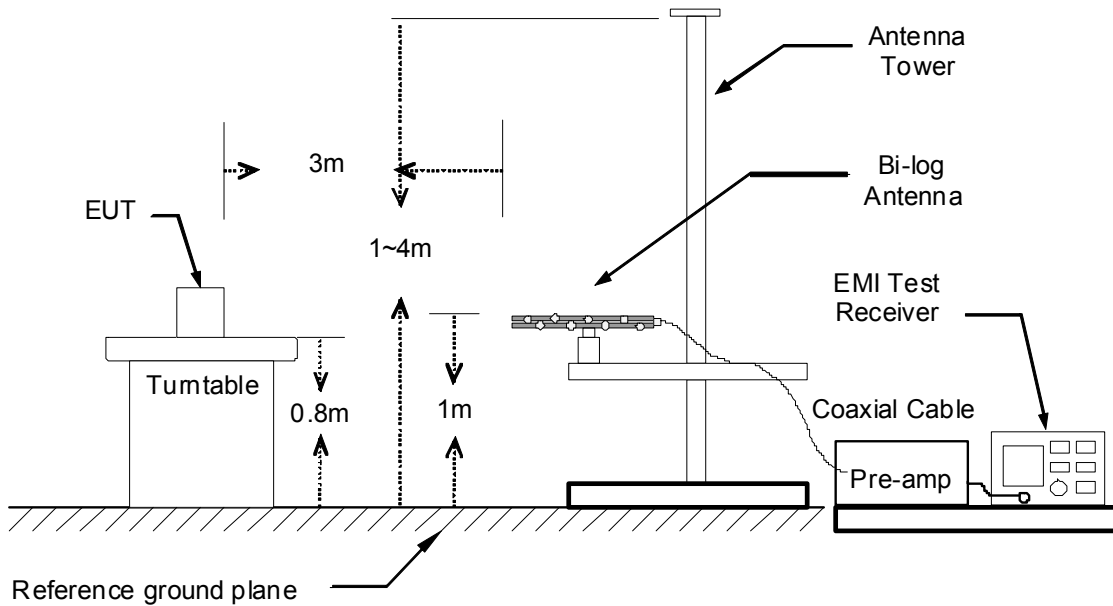



The diagram below shows the test setup that is utilized to make the measurements for emission above 1GHz.

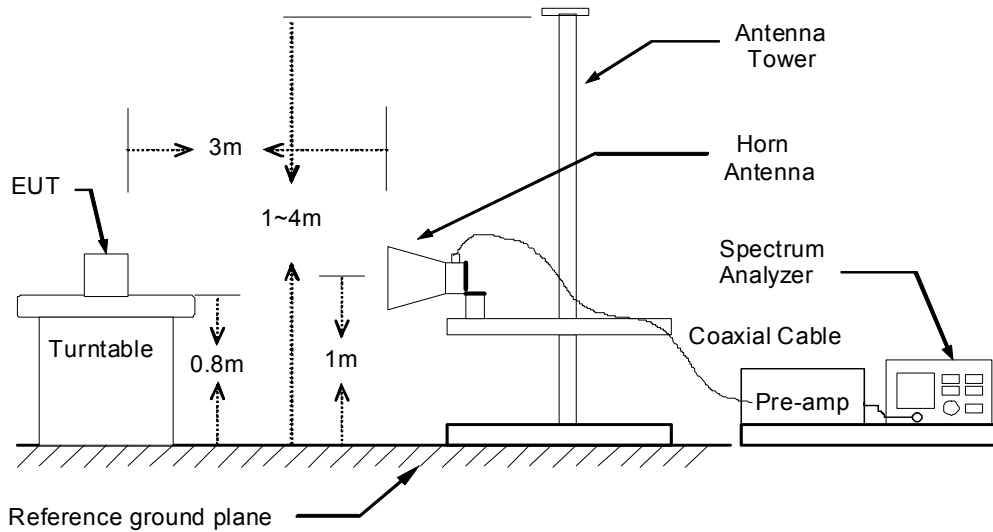

### **TEST PROCEDURE**

1. The EUT was placed on the top of a rotating table 0.8 meters above the ground. The table was rotated 360 degrees to determine the position of the highest radiation.
2. While measuring the radiated emission below 1GHz, the EUT was set 3 meters away from the interference-receiving antenna, which was mounted on the top of a variable-height antenna tower. While measuring the radiated emission above 1GHz, the EUT was set 3 meters away from the interference-receiving antenna.
3. The antenna is a broadband antenna, and its height is varied from one meter to four meters above the ground to determine the maximum value of the field strength. Both horizontal and vertical polarization of the antenna are set to make the measurement.
4. For each suspected emission, the EUT was arranged to its worst case and then the antenna was tuned to heights from 1 meter to 4 meters and the table was turned from 0 degrees to 360 degrees to find the maximum reading.
5. The test-receiver system was set to Peak Detect Function and Specified Bandwidth with Maximum Hold Mode.
6. If the emission level of the EUT in peak mode was 10 dB lower than the limit specified, then testing could be stopped and the peak values of the EUT would be reported. Otherwise the emissions that did not have 10 dB margin would be re-tested one by one using peak, quasi-peak or average method as specified and then reported in a data sheet.

#### **Remark :**

1. The resolution bandwidth and video bandwidth of test receiver/spectrum analyzer is 120 KHz for Peak detection (PK) and Quasi-peak detection (QP) at frequency below 1GHz.
2. The resolution bandwidth and video bandwidth of test receiver/spectrum analyzer is 1 MHz for Peak detection and frequency above 1GHz.
3. The resolution bandwidth of test receiver/spectrum analyzer is 1 MHz and the video bandwidth is 10 Hz for Average detection (AV) at frequency above 1GHz.



**TEST RESULTS**

**Below 1 GHz (9kHz ~ 30MHz)**

No emission found between lowest internal used/generated frequency to 30MHz.

**Below 1 GHz (30MHz ~ 1GHz)**

<b>Product Name</b>	Wireless IP CAM	<b>Test By</b>	Waternil Guan
<b>Test Model</b>	F3107	<b>Test Date</b>	2012/09/03
<b>Test Mode</b>	Normal Operating / Power Adapter AMIGO	<b>Temp. &amp; Humidity</b>	23 °C, 55%

966 Chamber_B at 3Meter / Horizontal						
Frequency (MHz)	Reading (dBµV)	Correction Factor (dB/m)	Result (dBµV/m)	Limit (dBµV/m)	Margin (dB)	Remark
250.19	47.09	-13.24	33.85	46.00	-12.15	Peak
399.57	53.70	-9.58	44.12	46.00	-1.88	QP
624.61	45.75	-5.88	39.88	46.00	-6.12	Peak
675.05	47.20	-5.15	42.05	46.00	-3.95	Peak
724.52	46.62	-4.37	42.25	46.00	-3.75	Peak
774.96	46.10	-3.46	42.64	46.00	-3.36	Peak
825.40	45.03	-2.64	42.39	46.00	-3.61	Peak
874.87	40.46	-1.88	38.58	46.00	-7.42	Peak

966 Chamber_B at 3Meter / Vertical						
Frequency (MHz)	Reading (dBµV)	Correction Factor (dB/m)	Result (dBµV/m)	Limit (dBµV/m)	Margin (dB)	Remark
43.58	53.10	-15.48	37.62	40.00	-2.38	QP
139.61	50.78	-13.18	37.60	43.50	-5.90	Peak
399.57	54.40	-9.58	44.82	46.00	-1.18	QP
624.61	50.00	-5.88	44.12	46.00	-1.88	QP
675.05	48.00	-5.15	42.85	46.00	-3.15	QP
725.49	48.20	-4.35	43.85	46.00	-2.15	QP
774.96	45.74	-3.46	42.28	46.00	-3.72	Peak
825.40	45.80	-2.64	43.16	46.00	-2.84	QP
874.87	42.27	-1.88	40.39	46.00	-5.61	Peak
925.31	43.62	-1.23	42.39	46.00	-3.61	Peak

**Remark:**

1. Quasi-peak test would be performed if the peak result were greater than the quasi-peak limit.
2. Data of measurement within this frequency range shown " --- " in the table above means the reading of emissions are attenuated more than 20dB below the permissible limits or the field strength is too small to be measured.
3. Correction Factor (dB/m) = Antenna Factor (dB/m) + Cable Loss (dB) – PreAmp.Gain (dB)
4. Result (dBuV/m) = Reading (dBuV) + Correction Factor (dB/m)
5. Margin (dB) = Remark result (dBuV/m) - Quasi-peak limit (dBuV/m).



<b>Product Name</b>	Wireless IP CAM	<b>Test By</b>	Waternil Guan
<b>Test Model</b>	F3107	<b>Test Date</b>	2012/09/03
<b>Test Mode</b>	Normal Operating / Power Adapter DVE	<b>Temp. &amp; Humidity</b>	23°C, 55%

966 Chamber_B at 3Meter / Horizontal						
Frequency (MHz)	Reading (dBµV)	Correction Factor (dB/m)	Result (dBµV/m)	Limit (dBµV/m)	Margin (dB)	Remark
250.19	57.10	-13.24	43.86	46.00	-2.14	QP
359.80	49.03	-10.29	38.74	46.00	-7.26	Peak
399.57	54.50	-9.58	44.92	46.00	-1.08	QP
675.05	47.58	-5.15	42.42	46.00	-3.58	Peak
724.52	45.19	-4.37	40.82	46.00	-5.18	Peak
774.96	43.99	-3.46	40.53	46.00	-5.47	Peak
874.87	41.39	-1.88	39.51	46.00	-6.49	Peak
925.31	42.01	-1.23	40.79	46.00	-5.21	Peak

966 Chamber_B at 3Meter / Vertical						
Frequency (MHz)	Reading (dBµV)	Correction Factor (dB/m)	Result (dBµV/m)	Limit (dBµV/m)	Margin (dB)	Remark
43.58	50.50	-15.48	35.02	40.00	-4.98	QP
250.19	54.68	-13.24	41.43	46.00	-4.57	Peak
399.57	53.70	-9.58	44.12	46.00	-1.88	QP
575.14	48.17	-6.73	41.44	46.00	-4.56	Peak
624.61	50.00	-5.88	44.12	46.00	-1.88	QP
675.05	47.06	-5.15	41.90	46.00	-4.10	Peak
874.87	44.05	-1.88	42.17	46.00	-3.83	Peak
925.31	46.10	-1.23	44.87	46.00	-1.13	QP

**Remark:**

1. Quasi-peak test would be performed if the peak result were greater than the quasi-peak limit.
2. Data of measurement within this frequency range shown " --- " in the table above means the reading of emissions are attenuated more than 20dB below the permissible limits or the field strength is too small to be measured.
3. Correction Factor (dB/m) = Antenna Factor (dB/m) + Cable Loss (dB) – PreAmp.Gain (dB)
4. Result (dBuV/m) = Reading (dBuV) + Correction Factor (dB/m)
5. Margin (dB) = Remark result (dBuV/m) - Quasi-peak limit (dBuV/m).





Above 1 GHz

<b>Product Name</b>	Wireless IP CAM	<b>Test By</b>	Waternil Guan
<b>Test Model</b>	F3107	<b>Test Date</b>	2012/09/04
<b>Test Mode</b>	IEEE 802.11b TX / CH Low	<b>Temp. &amp; Humidity</b>	25°C, 54%

966 Chamber_B at 3Meter / Horizontal									
Frequency (MHz)	Reading-PK (dBuV)	Reading-AV (dBuV)	Correction Factor (dB/m)	Result-PK (dBuV/m)	Result-AV (dBuV/m)	Limit-PK (dBuV/m)	Limit-AV (dBuV/m)	Margin (dB)	Remark
1140.00	49.40	---	-3.51	45.89	---	74.00	54.00	-8.11	Peak
1600.00	48.80	---	-1.35	47.45	---	74.00	54.00	-6.55	Peak
2000.00	45.71	---	2.25	47.96	---	74.00	54.00	-6.04	Peak
3195.00	41.36	---	5.40	46.76	---	74.00	54.00	-7.24	Peak
4830.00	41.89	---	9.24	51.13	---	74.00	54.00	-2.87	Peak

966 Chamber_B at 3Meter / Vertical									
Frequency (MHz)	Reading-PK (dBuV)	Reading-AV (dBuV)	Correction Factor (dB/m)	Result-PK (dBuV/m)	Result-AV (dBuV/m)	Limit-PK (dBuV/m)	Limit-AV (dBuV/m)	Margin (dB)	Remark
1140.00	51.72	---	-3.51	48.21	---	74.00	54.00	-5.79	Peak
1600.00	49.90	---	-1.35	48.55	---	74.00	54.00	-5.45	Peak
2530.00	53.09	44.16	4.01	57.10	48.17	74.00	54.00	-5.83	AVG
3420.00	40.54	---	5.86	46.40	---	74.00	54.00	-7.60	Peak
4830.00	41.49	---	9.24	50.73	---	74.00	54.00	-3.27	Peak

Remark:

1. Measuring frequencies from 1 GHz to the 10th harmonic of highest fundamental frequency.
2. Average test would be performed if the peak result were greater than the average limit.
3. Data of measurement within this frequency range shown " --- " in the table above means the reading of emissions are attenuated more than 20dB below the permissible limits or the field strength is too small to be measured.
4. Measurements above show only up to 6 maximum emissions noted, or would be lesser, with " N/A " remark, if no specific emissions from the EUT are recorded (ie: margin>20dB from the applicable limit) and considered that's already beyond the background noise floor.
5. Result = Reading + Correction Factor  
 Margin = Result - Limit  
 Remark Peak = Result(PK) - Limit(AV)  
 Remark AVG = Result(AV) - Limit(AV)



<b>Product Name</b>	Wireless IP CAM	<b>Test By</b>	Waternil Guan
<b>Test Model</b>	F3107	<b>Test Date</b>	2012/09/04
<b>Test Mode</b>	IEEE 802.11b TX / CH Middle	<b>Temp. &amp; Humidity</b>	25°C, 54%

966 Chamber_B at 3Meter / Horizontal									
Frequency (MHz)	Reading-PK (dBuV)	Reading-AV (dBuV)	Correction Factor (dB/m)	Result-PK (dBuV/m)	Result-AV (dBuV/m)	Limit-PK (dBuV/m)	Limit-AV (dBuV/m)	Margin (dB)	Remark
1110.00	49.00	---	-3.62	45.39	---	74.00	54.00	-8.61	Peak
1600.00	48.97	---	-1.35	47.62	---	74.00	54.00	-6.38	Peak
2000.00	46.65	---	2.25	48.90	---	74.00	54.00	-5.10	Peak
3225.00	41.35	---	5.46	46.81	---	74.00	54.00	-7.19	Peak
4875.00	40.03	---	9.36	49.39	---	74.00	54.00	-4.61	Peak
7305.00	46.57	38.12	13.33	59.90	51.45	74.00	54.00	-2.55	AVG

966 Chamber_B at 3Meter / Vertical									
Frequency (MHz)	Reading-PK (dBuV)	Reading-AV (dBuV)	Correction Factor (dB/m)	Result-PK (dBuV/m)	Result-AV (dBuV/m)	Limit-PK (dBuV/m)	Limit-AV (dBuV/m)	Margin (dB)	Remark
1140.00	51.50	---	-3.51	47.99	---	74.00	54.00	-6.01	Peak
1600.00	49.03	---	-1.35	47.68	---	74.00	54.00	-6.32	Peak
2000.00	44.24	---	2.25	46.49	---	74.00	54.00	-7.51	Peak
3270.00	41.28	---	5.55	46.84	---	74.00	54.00	-7.16	Peak
4860.00	40.15	---	9.32	49.47	---	74.00	54.00	-4.53	Peak
7305.00	38.46	---	13.33	51.78	---	74.00	54.00	-2.22	Peak

**Remark:**

1. Measuring frequencies from 1 GHz to the 10th harmonic of highest fundamental frequency.
2. Average test would be performed if the peak result were greater than the average limit.
3. Data of measurement within this frequency range shown " --- " in the table above means the reading of emissions are attenuated more than 20dB below the permissible limits or the field strength is too small to be measured.
4. Measurements above show only up to 6 maximum emissions noted, or would be lesser, with " N/A " remark, if no specific emissions from the EUT are recorded (ie: margin>20dB from the applicable limit) and considered that's already beyond the background noise floor.
5. Result = Reading + Correction Factor  
Margin = Result - Limit  
Remark Peak = Result(PK) - Limit(AV)  
Remark AVG = Result(AV) - Limit(AV)



<b>Product Name</b>	Wireless IP CAM	<b>Test By</b>	Waternil Guan
<b>Test Model</b>	F3107	<b>Test Date</b>	2012/09/04
<b>Test Mode</b>	IEEE 802.11b TX / CH High	<b>Temp. &amp; Humidity</b>	25°C, 54%

966 Chamber_B at 3Meter / Horizontal									
Frequency (MHz)	Reading-PK (dBuV)	Reading-AV (dBuV)	Correction Factor (dB/m)	Result-PK (dBuV/m)	Result-AV (dBuV/m)	Limit-PK (dBuV/m)	Limit-AV (dBuV/m)	Margin (dB)	Remark
1136.00	48.51	---	-3.52	44.99	---	74.00	54.00	-9.01	Peak
1600.00	48.92	---	-1.35	47.57	---	74.00	54.00	-6.43	Peak
2000.00	45.70	---	2.25	47.95	---	74.00	54.00	-6.05	Peak
3855.00	41.00	---	6.84	47.84	---	74.00	54.00	-6.16	Peak
4920.00	39.61	---	9.48	49.09	---	74.00	54.00	-4.91	Peak
7380.00	45.14	37.11	13.38	58.52	50.49	74.00	54.00	-3.51	AVG

966 Chamber_B at 3Meter / Vertical									
Frequency (MHz)	Reading-PK (dBuV)	Reading-AV (dBuV)	Correction Factor (dB/m)	Result-PK (dBuV/m)	Result-AV (dBuV/m)	Limit-PK (dBuV/m)	Limit-AV (dBuV/m)	Margin (dB)	Remark
1140.00	51.60	---	-3.51	48.09	---	74.00	54.00	-5.91	Peak
1600.00	49.17	---	-1.35	47.82	---	74.00	54.00	-6.18	Peak
2000.00	44.04	---	2.25	46.29	---	74.00	54.00	-7.71	Peak
3330.00	40.91	---	5.67	46.59	---	74.00	54.00	-7.41	Peak
4020.00	40.49	---	7.23	47.72	---	74.00	54.00	-6.28	Peak
4920.00	39.15	---	9.48	48.63	---	74.00	54.00	-5.37	Peak

**Remark:**

1. Measuring frequencies from 1 GHz to the 10th harmonic of highest fundamental frequency.
2. Average test would be performed if the peak result were greater than the average limit.
3. Data of measurement within this frequency range shown " --- " in the table above means the reading of emissions are attenuated more than 20dB below the permissible limits or the field strength is too small to be measured.
4. Measurements above show only up to 6 maximum emissions noted, or would be lesser, with " N/A " remark, if no specific emissions from the EUT are recorded (ie: margin>20dB from the applicable limit) and considered that's already beyond the background noise floor.
5. Result = Reading + Correction Factor  
Margin = Result - Limit  
Remark Peak = Result(PK) - Limit(AV)  
Remark AVG = Result(AV) - Limit(AV)



<b>Product Name</b>	Wireless IP CAM	<b>Test By</b>	Waternil Guan
<b>Test Model</b>	F3107	<b>Test Date</b>	2012/09/04
<b>Test Mode</b>	IEEE 802.11g TX / CH Low	<b>Temp. &amp; Humidity</b>	25°C, 54%

966 Chamber_B at 3Meter / Horizontal									
Frequency (MHz)	Reading-PK (dBuV)	Reading-AV (dBuV)	Correction Factor (dB/m)	Result-PK (dBuV/m)	Result-AV (dBuV/m)	Limit-PK (dBuV/m)	Limit-AV (dBuV/m)	Margin (dB)	Remark
1138.00	48.35	---	-3.52	44.83	---	74.00	54.00	-9.17	Peak
1600.00	47.08	---	-1.35	45.73	---	74.00	54.00	-8.27	Peak
2000.00	45.69	---	2.25	47.94	---	74.00	54.00	-6.06	Peak
3300.00	41.00	---	5.61	46.61	---	74.00	54.00	-7.39	Peak
4830.00	39.98	---	9.24	49.22	---	74.00	54.00	-4.78	Peak
7230.00	51.60	38.76	13.28	64.88	52.04	74.00	54.00	-1.96	AVG

966 Chamber_B at 3Meter / Vertical									
Frequency (MHz)	Reading-PK (dBuV)	Reading-AV (dBuV)	Correction Factor (dB/m)	Result-PK (dBuV/m)	Result-AV (dBuV/m)	Limit-PK (dBuV/m)	Limit-AV (dBuV/m)	Margin (dB)	Remark
1064.00	52.44	---	-3.78	48.66	---	74.00	54.00	-5.34	Peak
1600.00	49.83	---	-1.35	48.48	---	74.00	54.00	-5.52	Peak
2000.00	44.77	---	2.25	47.02	---	74.00	54.00	-6.98	Peak
3330.00	41.85	---	5.67	47.52	---	74.00	54.00	-6.48	Peak
4140.00	39.97	---	7.51	47.48	---	74.00	54.00	-6.52	Peak
7245.00	44.32	32.44	13.29	57.61	45.73	74.00	54.00	-8.27	AVG

**Remark:**

1. Measuring frequencies from 1 GHz to the 10th harmonic of highest fundamental frequency.
2. Average test would be performed if the peak result were greater than the average limit.
3. Data of measurement within this frequency range shown " --- " in the table above means the reading of emissions are attenuated more than 20dB below the permissible limits or the field strength is too small to be measured.
4. Measurements above show only up to 6 maximum emissions noted, or would be lesser, with " N/A " remark, if no specific emissions from the EUT are recorded (ie: margin>20dB from the applicable limit) and considered that's already beyond the background noise floor.
5. Result = Reading + Correction Factor  
Margin = Result - Limit  
Remark Peak = Result(PK) - Limit(AV)  
Remark AVG = Result(AV) - Limit(AV)



<b>Product Name</b>	Wireless IP CAM	<b>Test By</b>	Waternil Guan
<b>Test Model</b>	F3107	<b>Test Date</b>	2012/09/04
<b>Test Mode</b>	IEEE 802.11g TX / CH Middle	<b>Temp. &amp; Humidity</b>	25°C, 54%

966 Chamber_B at 3Meter / Horizontal									
Frequency (MHz)	Reading-PK (dBuV)	Reading-AV (dBuV)	Correction Factor (dB/m)	Result-PK (dBuV/m)	Result-AV (dBuV/m)	Limit-PK (dBuV/m)	Limit-AV (dBuV/m)	Margin (dB)	Remark
1078.00	51.68	---	-3.73	47.95	---	74.00	54.00	-6.05	Peak
1600.00	49.52	---	-1.35	48.17	---	74.00	54.00	-5.83	Peak
2000.00	44.89	---	2.25	47.14	---	74.00	54.00	-6.86	Peak
3195.00	42.16	---	5.40	47.56	---	74.00	54.00	-6.44	Peak
4875.00	39.10	---	9.36	48.46	---	74.00	54.00	-5.54	Peak
7320.00	53.09	39.18	13.34	66.43	52.52	74.00	54.00	-1.48	AVG

966 Chamber_B at 3Meter / Vertical									
Frequency (MHz)	Reading-PK (dBuV)	Reading-AV (dBuV)	Correction Factor (dB/m)	Result-PK (dBuV/m)	Result-AV (dBuV/m)	Limit-PK (dBuV/m)	Limit-AV (dBuV/m)	Margin (dB)	Remark
1080.00	51.94	---	-3.72	48.22	---	74.00	54.00	-5.78	Peak
1600.00	49.81	---	-1.35	48.46	---	74.00	54.00	-5.54	Peak
2000.00	44.75	---	2.25	47.00	---	74.00	54.00	-7.00	Peak
3240.00	41.03	---	5.49	46.52	---	74.00	54.00	-7.48	Peak
4875.00	38.87	---	9.36	48.23	---	74.00	54.00	-5.77	Peak
7305.00	45.52	34.14	13.33	58.85	47.47	74.00	54.00	-6.53	AVG

**Remark:**

1. Measuring frequencies from 1 GHz to the 10th harmonic of highest fundamental frequency.
2. Average test would be performed if the peak result were greater than the average limit.
3. Data of measurement within this frequency range shown " --- " in the table above means the reading of emissions are attenuated more than 20dB below the permissible limits or the field strength is too small to be measured.
4. Measurements above show only up to 6 maximum emissions noted, or would be lesser, with " N/A " remark, if no specific emissions from the EUT are recorded (ie: margin>20dB from the applicable limit) and considered that's already beyond the background noise floor.
5. Result = Reading + Correction Factor  
Margin = Result - Limit  
Remark Peak = Result(PK) - Limit(AV)  
Remark AVG = Result(AV) - Limit(AV)



<b>Product Name</b>	Wireless IP CAM	<b>Test By</b>	Waternil Guan
<b>Test Model</b>	F3107	<b>Test Date</b>	2012/09/04
<b>Test Mode</b>	IEEE 802.11g TX / CH High	<b>Temp. &amp; Humidity</b>	25°C, 54%

966 Chamber_B at 3Meter / Horizontal									
Frequency (MHz)	Reading-PK (dBuV)	Reading-AV (dBuV)	Correction Factor (dB/m)	Result-PK (dBuV/m)	Result-AV (dBuV/m)	Limit-PK (dBuV/m)	Limit-AV (dBuV/m)	Margin (dB)	Remark
1140.00	55.58	---	-3.51	52.07	---	74.00	54.00	-1.93	Peak
1600.00	49.04	---	-1.35	47.69	---	74.00	54.00	-6.31	Peak
2000.00	45.61	---	2.25	47.86	---	74.00	54.00	-6.14	Peak
4275.00	40.05	---	7.83	47.89	---	74.00	54.00	-6.11	Peak
4965.00	39.39	---	9.60	48.99	---	74.00	54.00	-5.01	Peak
7380.00	54.56	39.46	13.38	67.94	52.84	74.00	54.00	-1.16	AVG

966 Chamber_B at 3Meter / Vertical									
Frequency (MHz)	Reading-PK (dBuV)	Reading-AV (dBuV)	Correction Factor (dB/m)	Result-PK (dBuV/m)	Result-AV (dBuV/m)	Limit-PK (dBuV/m)	Limit-AV (dBuV/m)	Margin (dB)	Remark
1140.00	52.06	---	-3.51	48.55	---	74.00	54.00	-5.45	Peak
1600.00	49.20	---	-1.35	47.85	---	74.00	54.00	-6.15	Peak
2000.00	45.57	---	2.25	47.82	---	74.00	54.00	-6.18	Peak
3750.00	40.51	---	6.60	47.11	---	74.00	54.00	-6.89	Peak
4920.00	39.31	---	9.48	48.79	---	74.00	54.00	-5.21	Peak
7380.00	46.76	35.43	13.38	60.14	48.81	74.00	54.00	-5.19	AVG

**Remark:**

1. Measuring frequencies from 1 GHz to the 10th harmonic of highest fundamental frequency.
2. Average test would be performed if the peak result were greater than the average limit.
3. Data of measurement within this frequency range shown " --- " in the table above means the reading of emissions are attenuated more than 20dB below the permissible limits or the field strength is too small to be measured.
4. Measurements above show only up to 6 maximum emissions noted, or would be lesser, with " N/A " remark, if no specific emissions from the EUT are recorded (ie: margin>20dB from the applicable limit) and considered that's already beyond the background noise floor.
5. Result = Reading + Correction Factor  
Margin = Result - Limit  
Remark Peak = Result(PK) - Limit(AV)  
Remark AVG = Result(AV) - Limit(AV)



<b>Product Name</b>	Wireless IP CAM	<b>Test By</b>	Waternil Guan
<b>Test Model</b>	F3107	<b>Test Date</b>	2012/09/04
<b>Test Mode</b>	IEEE 802.11n HT20 TX / CH Low	<b>Temp. &amp; Humidity</b>	25°C, 54%

966 Chamber_B at 3Meter / Horizontal									
Frequency (MHz)	Reading-PK (dBuV)	Reading-AV (dBuV)	Correction Factor (dB/m)	Result-PK (dBuV/m)	Result-AV (dBuV/m)	Limit-PK (dBuV/m)	Limit-AV (dBuV/m)	Margin (dB)	Remark
1080.00	49.86	---	-3.72	46.14	---	74.00	54.00	-7.86	Peak
1600.00	50.30	---	-1.35	48.95	---	74.00	54.00	-5.05	Peak
2000.00	45.85	---	2.25	48.10	---	74.00	54.00	-5.90	Peak
3390.00	41.12	---	5.80	46.92	---	74.00	54.00	-7.08	Peak
4815.00	39.45	---	9.20	48.65	---	74.00	54.00	-5.35	Peak
7230.00	50.29	37.91	13.28	63.57	51.19	74.00	54.00	-2.81	AVG

966 Chamber_B at 3Meter / Vertical									
Frequency (MHz)	Reading-PK (dBuV)	Reading-AV (dBuV)	Correction Factor (dB/m)	Result-PK (dBuV/m)	Result-AV (dBuV/m)	Limit-PK (dBuV/m)	Limit-AV (dBuV/m)	Margin (dB)	Remark
1064.00	50.91	---	-3.78	47.13	---	74.00	54.00	-6.87	Peak
1140.00	52.98	---	-3.51	49.47	---	74.00	54.00	-4.53	Peak
1600.00	50.74	---	-1.35	49.39	---	74.00	54.00	-4.61	Peak
3285.00	41.14	---	5.58	46.72	---	74.00	54.00	-7.28	Peak
4905.00	40.77	---	9.44	50.21	---	74.00	54.00	-3.79	Peak
7245.00	43.48	30.63	13.29	56.77	43.92	74.00	54.00	-10.08	AVG

**Remark:**

1. Measuring frequencies from 1 GHz to the 10th harmonic of highest fundamental frequency.
2. Average test would be performed if the peak result were greater than the average limit.
3. Data of measurement within this frequency range shown " --- " in the table above means the reading of emissions are attenuated more than 20dB below the permissible limits or the field strength is too small to be measured.
4. Measurements above show only up to 6 maximum emissions noted, or would be lesser, with " N/A " remark, if no specific emissions from the EUT are recorded (ie: margin>20dB from the applicable limit) and considered that's already beyond the background noise floor.
5. Result = Reading + Correction Factor  
Margin = Result - Limit  
Remark Peak = Result(PK) - Limit(AV)  
Remark AVG = Result(AV) - Limit(AV)



<b>Product Name</b>	Wireless IP CAM	<b>Test By</b>	Waternil Guan
<b>Test Model</b>	F3107	<b>Test Date</b>	2012/09/04
<b>Test Mode</b>	IEEE 802.11n HT20 TX / CH Middle	<b>Temp. &amp; Humidity</b>	25°C, 54%

966 Chamber_B at 3Meter / Horizontal									
Frequency (MHz)	Reading-PK (dBuV)	Reading-AV (dBuV)	Correction Factor (dB/m)	Result-PK (dBuV/m)	Result-AV (dBuV/m)	Limit-PK (dBuV/m)	Limit-AV (dBuV/m)	Margin (dB)	Remark
1128.00	49.69	---	-3.55	46.14	---	74.00	54.00	-7.86	Peak
1600.00	49.15	---	-1.35	47.80	---	74.00	54.00	-6.20	Peak
2000.00	45.38	---	2.25	47.63	---	74.00	54.00	-6.37	Peak
3360.00	41.68	---	5.73	47.41	---	74.00	54.00	-6.59	Peak
5010.00	39.29	---	9.70	48.99	---	74.00	54.00	-5.01	Peak
7320.00	55.02	39.55	13.34	68.36	52.89	74.00	54.00	-1.11	AVG

966 Chamber_B at 3Meter / Vertical									
Frequency (MHz)	Reading-PK (dBuV)	Reading-AV (dBuV)	Correction Factor (dB/m)	Result-PK (dBuV/m)	Result-AV (dBuV/m)	Limit-PK (dBuV/m)	Limit-AV (dBuV/m)	Margin (dB)	Remark
1080.00	53.01	---	-3.72	49.29	---	74.00	54.00	-4.71	Peak
1140.00	51.81	---	-3.51	48.30	---	74.00	54.00	-5.70	Peak
1600.00	49.53	---	-1.35	48.18	---	74.00	54.00	-5.82	Peak
3195.00	41.43	---	5.40	46.83	---	74.00	54.00	-7.17	Peak
4860.00	39.47	---	9.32	48.79	---	74.00	54.00	-5.21	Peak
7290.00	43.37	32.42	13.32	56.69	45.74	74.00	54.00	-8.26	AVG

**Remark:**

1. Measuring frequencies from 1 GHz to the 10th harmonic of highest fundamental frequency.
2. Average test would be performed if the peak result were greater than the average limit.
3. Data of measurement within this frequency range shown " --- " in the table above means the reading of emissions are attenuated more than 20dB below the permissible limits or the field strength is too small to be measured.
4. Measurements above show only up to 6 maximum emissions noted, or would be lesser, with " N/A " remark, if no specific emissions from the EUT are recorded (ie: margin>20dB from the applicable limit) and considered that's already beyond the background noise floor.
5. Result = Reading + Correction Factor  
Margin = Result - Limit  
Remark Peak = Result(PK) - Limit(AV)  
Remark AVG = Result(AV) - Limit(AV)





<b>Product Name</b>	Wireless IP CAM	<b>Test By</b>	Waternil Guan
<b>Test Model</b>	F3107	<b>Test Date</b>	2012/09/04
<b>Test Mode</b>	IEEE 802.11 n HT20 TX / CH High	<b>Temp. &amp; Humidity</b>	25°C, 54%

966 Chamber_B at 3Meter / Horizontal									
Frequency (MHz)	Reading-PK (dBuV)	Reading-AV (dBuV)	Correction Factor (dB/m)	Result-PK (dBuV/m)	Result-AV (dBuV/m)	Limit-PK (dBuV/m)	Limit-AV (dBuV/m)	Margin (dB)	Remark
1080.00	50.44	---	-3.72	46.72	---	74.00	54.00	-7.28	Peak
1600.00	48.82	---	-1.35	47.47	---	74.00	54.00	-6.53	Peak
2000.00	45.89	---	2.25	48.14	---	74.00	54.00	-5.86	Peak
3285.00	41.59	---	5.58	47.17	---	74.00	54.00	-6.83	Peak
4905.00	39.27	---	9.44	48.71	---	74.00	54.00	-5.29	Peak
7380.00	52.26	39.52	13.38	65.64	52.90	74.00	54.00	-1.10	AVG

966 Chamber_B at 3Meter / Vertical									
Frequency (MHz)	Reading-PK (dBuV)	Reading-AV (dBuV)	Correction Factor (dB/m)	Result-PK (dBuV/m)	Result-AV (dBuV/m)	Limit-PK (dBuV/m)	Limit-AV (dBuV/m)	Margin (dB)	Remark
1080.00	53.90	---	-3.72	50.18	---	74.00	54.00	-3.82	Peak
1140.00	53.64	---	-3.51	50.13	---	74.00	54.00	-3.87	Peak
1600.00	48.62	---	-1.35	47.27	---	74.00	54.00	-6.73	Peak
4110.00	40.44	---	7.44	47.88	---	74.00	54.00	-6.12	Peak
4935.00	39.26	---	9.52	48.78	---	74.00	54.00	-5.22	Peak
7380.00	45.33	33.73	13.38	58.71	47.11	74.00	54.00	-6.89	AVG

**Remark:**

1. Measuring frequencies from 1 GHz to the 10th harmonic of highest fundamental frequency.
2. Average test would be performed if the peak result were greater than the average limit.
3. Data of measurement within this frequency range shown " --- " in the table above means the reading of emissions are attenuated more than 20dB below the permissible limits or the field strength is too small to be measured.
4. Measurements above show only up to 6 maximum emissions noted, or would be lesser, with " N/A " remark, if no specific emissions from the EUT are recorded (ie: margin>20dB from the applicable limit) and considered that's already beyond the background noise floor.
5. Result = Reading + Correction Factor  
Margin = Result - Limit  
Remark Peak = Result(PK) - Limit(AV)  
Remark AVG = Result(AV) - Limit(AV)



<b>Product Name</b>	Wireless IP CAM	<b>Test By</b>	Waternil Guan
<b>Test Model</b>	F3107	<b>Test Date</b>	2012/09/04
<b>Test Mode</b>	IEEE 802.11n HT40 TX / CH Low	<b>Temp. &amp; Humidity</b>	25°C, 54%

966 Chamber_B at 3Meter / Horizontal									
Frequency (MHz)	Reading-PK (dBuV)	Reading-AV (dBuV)	Correction Factor (dB/m)	Result-PK (dBuV/m)	Result-AV (dBuV/m)	Limit-PK (dBuV/m)	Limit-AV (dBuV/m)	Margin (dB)	Remark
1140.00	50.27	---	-3.51	46.76	---	74.00	54.00	-7.24	Peak
1600.00	50.30	---	-1.35	48.95	---	74.00	54.00	-5.05	Peak
2000.00	44.57	---	2.25	46.82	---	74.00	54.00	-7.18	Peak
3915.00	40.84	---	6.98	47.82	---	74.00	54.00	-6.18	Peak
4935.00	40.02	---	9.52	49.54	---	74.00	54.00	-4.46	Peak
7260.00	46.80	34.50	13.30	60.10	47.80	74.00	54.00	-6.20	AVG

966 Chamber_B at 3Meter / Vertical									
Frequency (MHz)	Reading-PK (dBuV)	Reading-AV (dBuV)	Correction Factor (dB/m)	Result-PK (dBuV/m)	Result-AV (dBuV/m)	Limit-PK (dBuV/m)	Limit-AV (dBuV/m)	Margin (dB)	Remark
1066.00	52.03	---	-3.77	48.26	---	74.00	54.00	-5.74	Peak
1600.00	48.46	---	-1.35	47.11	---	74.00	54.00	-6.89	Peak
2000.00	44.31	---	2.25	46.56	---	74.00	54.00	-7.44	Peak
3180.00	41.63	---	5.37	46.99	---	74.00	54.00	-7.01	Peak
3930.00	40.27	---	7.02	47.29	---	74.00	54.00	-6.71	Peak
4470.00	39.95	---	8.30	48.25	---	74.00	54.00	-5.75	Peak

**Remark:**

1. Measuring frequencies from 1 GHz to the 10th harmonic of highest fundamental frequency.
2. Average test would be performed if the peak result were greater than the average limit.
3. Data of measurement within this frequency range shown " --- " in the table above means the reading of emissions are attenuated more than 20dB below the permissible limits or the field strength is too small to be measured.
4. Measurements above show only up to 6 maximum emissions noted, or would be lesser, with " N/A " remark, if no specific emissions from the EUT are recorded (ie: margin>20dB from the applicable limit) and considered that's already beyond the background noise floor.
5. Result = Reading + Correction Factor  
Margin = Result - Limit  
Remark Peak = Result(PK) - Limit(AV)  
Remark AVG = Result(AV) - Limit(AV)



<b>Product Name</b>	Wireless IP CAM	<b>Test By</b>	Waternil Guan
<b>Test Model</b>	F3107	<b>Test Date</b>	2012/09/04
<b>Test Mode</b>	IEEE 802.11n HT40 TX / CH Middle	<b>Temp. &amp; Humidity</b>	25°C, 54%

966 Chamber_B at 3Meter / Horizontal									
Frequency (MHz)	Reading-PK (dBuV)	Reading-AV (dBuV)	Correction Factor (dB/m)	Result-PK (dBuV/m)	Result-AV (dBuV/m)	Limit-PK (dBuV/m)	Limit-AV (dBuV/m)	Margin (dB)	Remark
1140.00	49.58	---	-3.51	46.07	---	74.00	54.00	-7.93	Peak
1600.00	48.83	---	-1.35	47.48	---	74.00	54.00	-6.52	Peak
2000.00	45.66	---	2.25	47.91	---	74.00	54.00	-6.09	Peak
3825.00	40.06	---	6.77	46.83	---	74.00	54.00	-7.17	Peak
4875.00	38.98	---	9.36	48.34	---	74.00	54.00	-5.66	Peak
7305.00	48.43	38.06	13.33	61.76	51.39	74.00	54.00	-2.61	AVG

966 Chamber_B at 3Meter / Vertical									
Frequency (MHz)	Reading-PK (dBuV)	Reading-AV (dBuV)	Correction Factor (dB/m)	Result-PK (dBuV/m)	Result-AV (dBuV/m)	Limit-PK (dBuV/m)	Limit-AV (dBuV/m)	Margin (dB)	Remark
1064.00	50.80	---	-3.78	47.03	---	74.00	54.00	-6.97	Peak
1138.00	50.92	---	-3.52	47.40	---	74.00	54.00	-6.60	Peak
1600.00	48.93	---	-1.35	47.58	---	74.00	54.00	-6.42	Peak
3705.00	40.46	---	6.50	46.96	---	74.00	54.00	-7.04	Peak
4935.00	39.87	---	9.52	49.39	---	74.00	54.00	-4.61	Peak
7320.00	42.46	32.60	13.34	55.80	45.94	74.00	54.00	-8.06	AVG

**Remark:**

1. Measuring frequencies from 1 GHz to the 10th harmonic of highest fundamental frequency.
2. Average test would be performed if the peak result were greater than the average limit.
3. Data of measurement within this frequency range shown " --- " in the table above means the reading of emissions are attenuated more than 20dB below the permissible limits or the field strength is too small to be measured.
4. Measurements above show only up to 6 maximum emissions noted, or would be lesser, with " N/A " remark, if no specific emissions from the EUT are recorded (ie: margin>20dB from the applicable limit) and considered that's already beyond the background noise floor.
5. Result = Reading + Correction Factor  
Margin = Result - Limit  
Remark Peak = Result(PK) - Limit(AV)  
Remark AVG = Result(AV) - Limit(AV)



<b>Product Name</b>	Wireless IP CAM	<b>Test By</b>	Waternil Guan
<b>Test Model</b>	F3107	<b>Test Date</b>	2012/09/04
<b>Test Mode</b>	IEEE 802.11 n HT40 TX / CH High	<b>Temp. &amp; Humidity</b>	25°C, 54%

966 Chamber_B at 3Meter / Horizontal									
Frequency (MHz)	Reading-PK (dBuV)	Reading-AV (dBuV)	Correction Factor (dB/m)	Result-PK (dBuV/m)	Result-AV (dBuV/m)	Limit-PK (dBuV/m)	Limit-AV (dBuV/m)	Margin (dB)	Remark
1140.00	49.49	---	-3.51	45.98	---	74.00	54.00	-8.02	Peak
1600.00	49.33	---	-1.35	47.98	---	74.00	54.00	-6.02	Peak
2000.00	47.29	---	2.25	49.54	---	74.00	54.00	-4.46	Peak
3285.00	41.37	---	5.58	46.95	---	74.00	54.00	-7.05	Peak
5025.00	39.26	---	9.72	48.99	---	74.00	54.00	-5.01	Peak
7350.00	50.34	37.84	13.36	63.70	51.20	74.00	54.00	-2.80	AVG

966 Chamber_B at 3Meter / Vertical									
Frequency (MHz)	Reading-PK (dBuV)	Reading-AV (dBuV)	Correction Factor (dB/m)	Result-PK (dBuV/m)	Result-AV (dBuV/m)	Limit-PK (dBuV/m)	Limit-AV (dBuV/m)	Margin (dB)	Remark
1078.00	51.52	---	-3.73	47.80	---	74.00	54.00	-6.20	Peak
1140.00	51.92	---	-3.51	48.41	---	74.00	54.00	-5.59	Peak
1600.00	50.04	---	-1.35	48.69	---	74.00	54.00	-5.31	Peak
3255.00	40.86	---	5.52	46.38	---	74.00	54.00	-7.62	Peak
4770.00	39.41	---	9.08	48.50	---	74.00	54.00	-5.50	Peak
7350.00	42.35	31.94	13.36	55.71	45.30	74.00	54.00	-8.70	AVG

**Remark:**

1. Measuring frequencies from 1 GHz to the 10th harmonic of highest fundamental frequency.
2. Average test would be performed if the peak result were greater than the average limit.
3. Data of measurement within this frequency range shown " --- " in the table above means the reading of emissions are attenuated more than 20dB below the permissible limits or the field strength is too small to be measured.
4. Measurements above show only up to 6 maximum emissions noted, or would be lesser, with " N/A " remark, if no specific emissions from the EUT are recorded (ie: margin>20dB from the applicable limit) and considered that's already beyond the background noise floor.
5. Result = Reading + Correction Factor  
Margin = Result - Limit  
Remark Peak = Result(PK) - Limit(AV)  
Remark AVG = Result(AV) - Limit(AV)



Restricted Band Edges

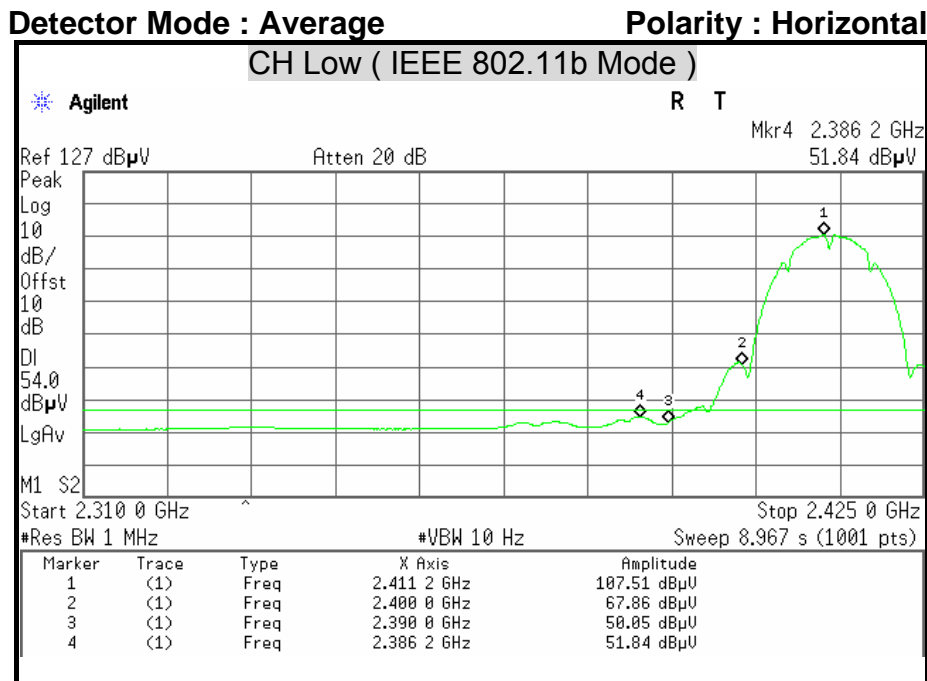
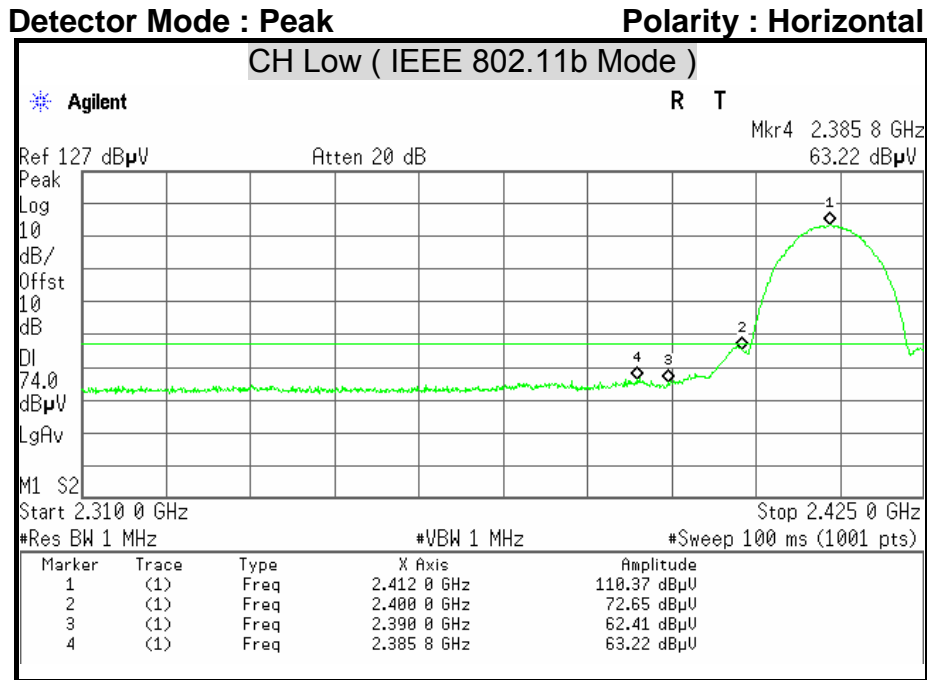



Detector Mode : Peak

Polarity : Vertical

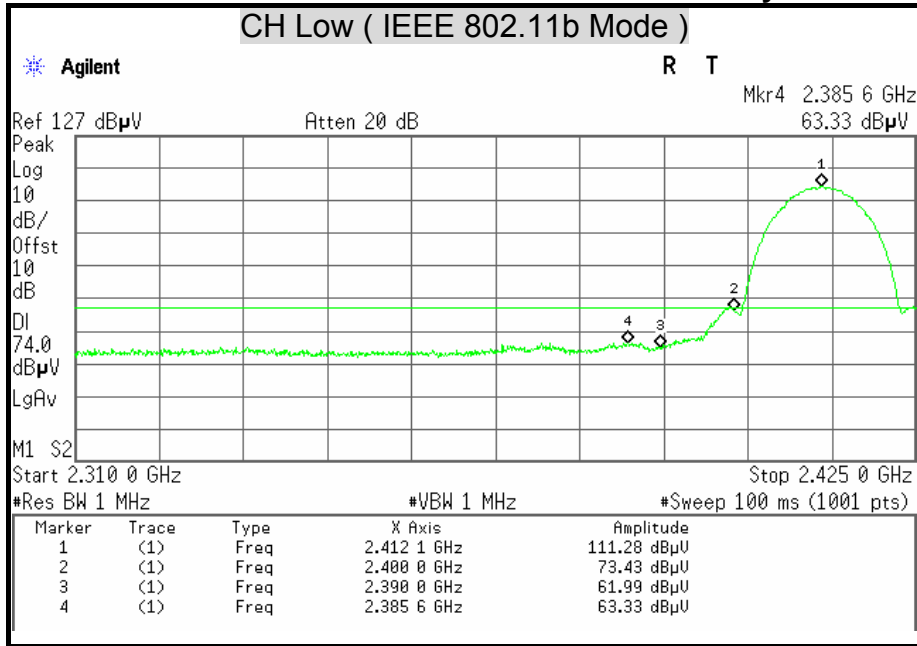

Detector Mode : Average

Polarity : Vertical

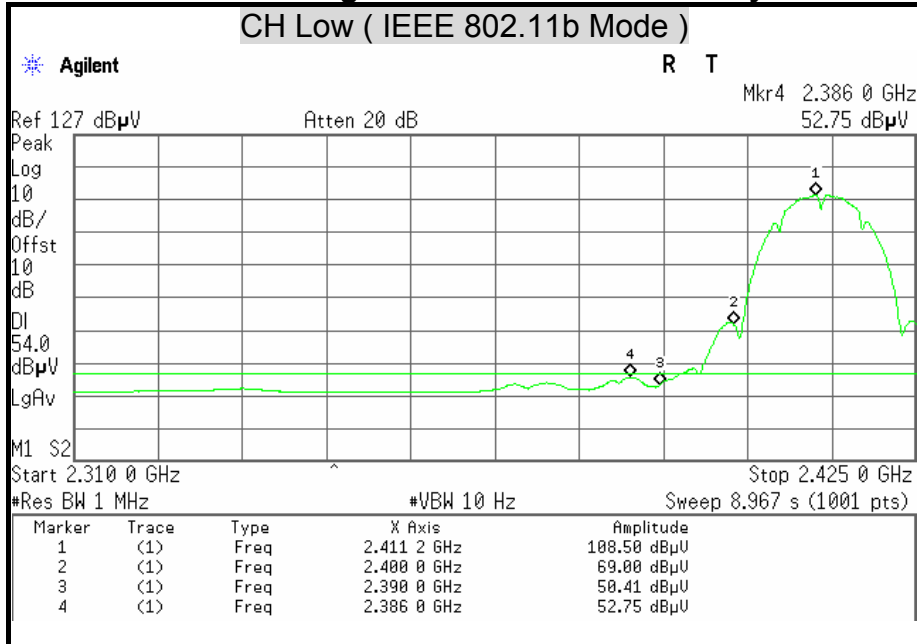



Detector Mode : Peak

Polarity : Horizontal

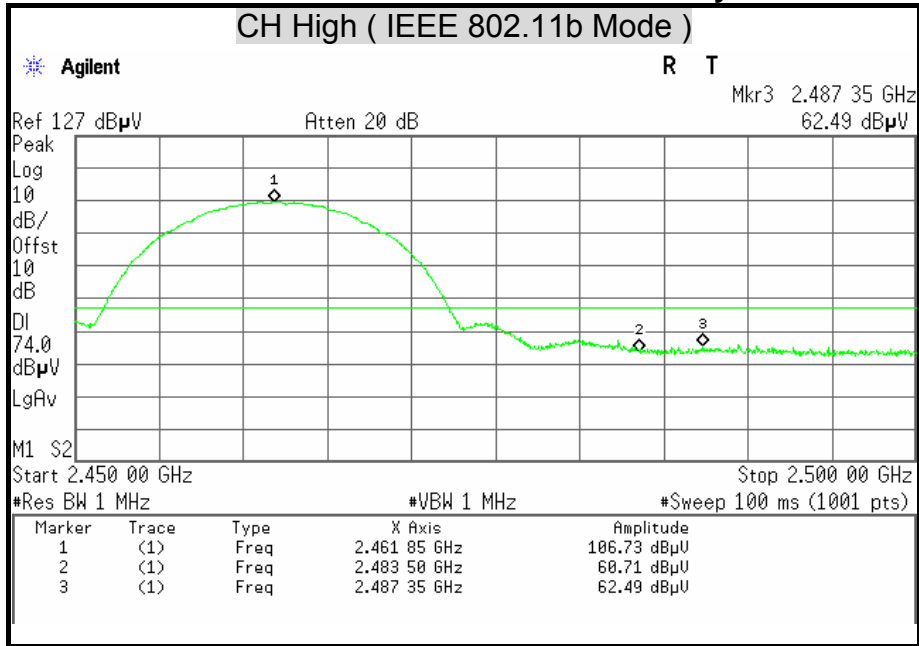

Detector Mode : Average

Polarity : Horizontal

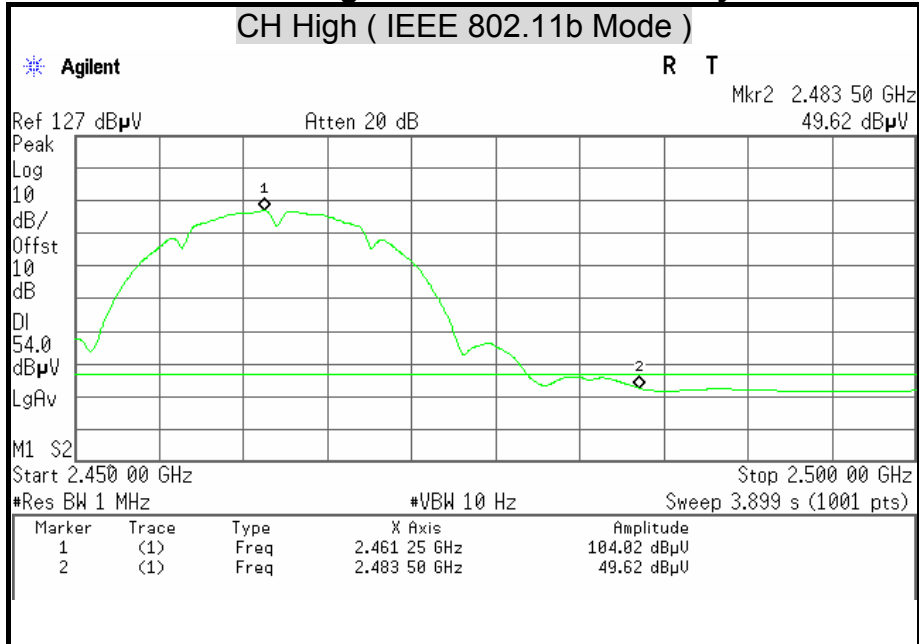



Detector Mode : Peak

Polarity : Vertical

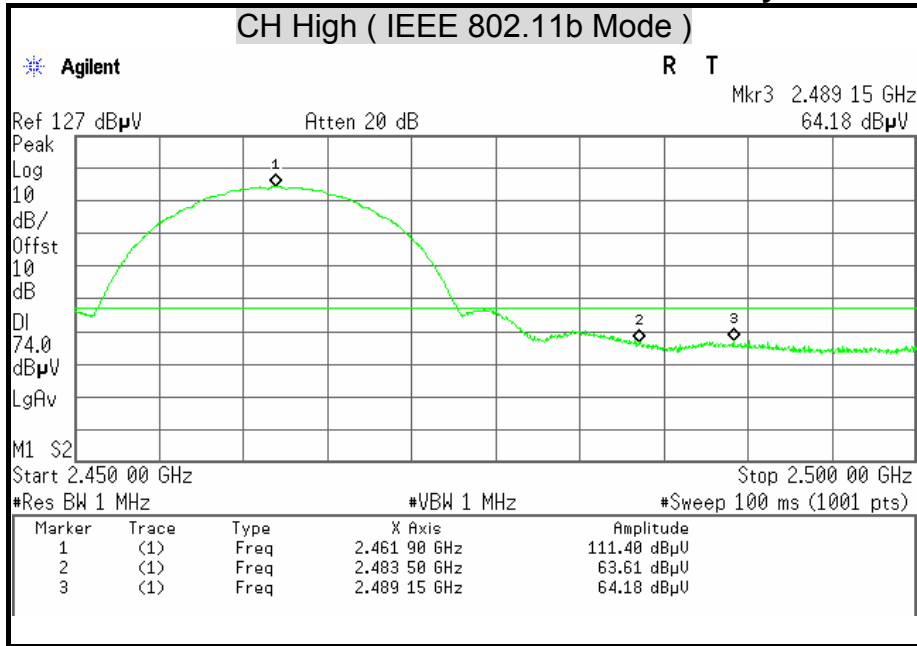

Detector Mode : Average

Polarity : Vertical

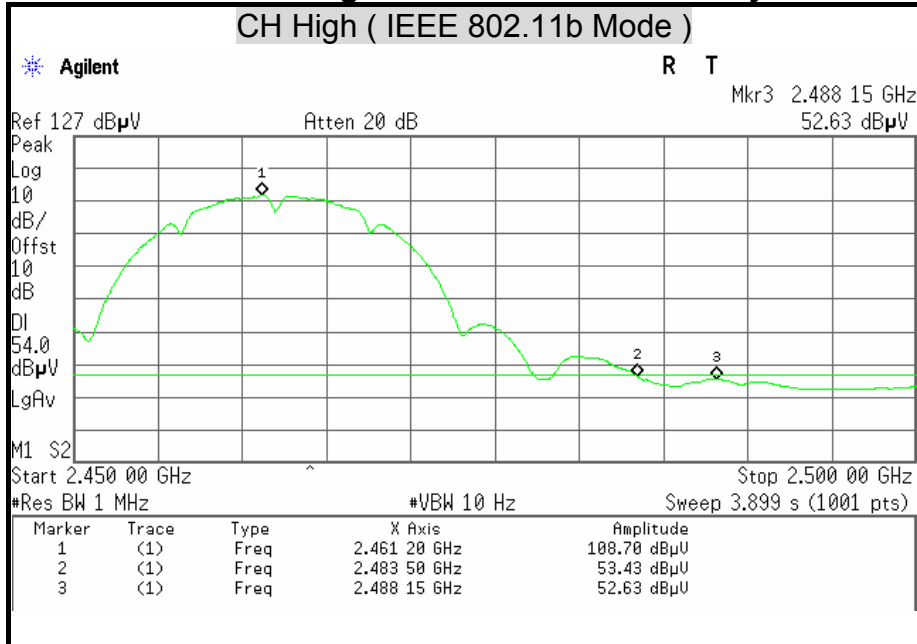





Detector Mode : Peak

Polarity : Horizontal

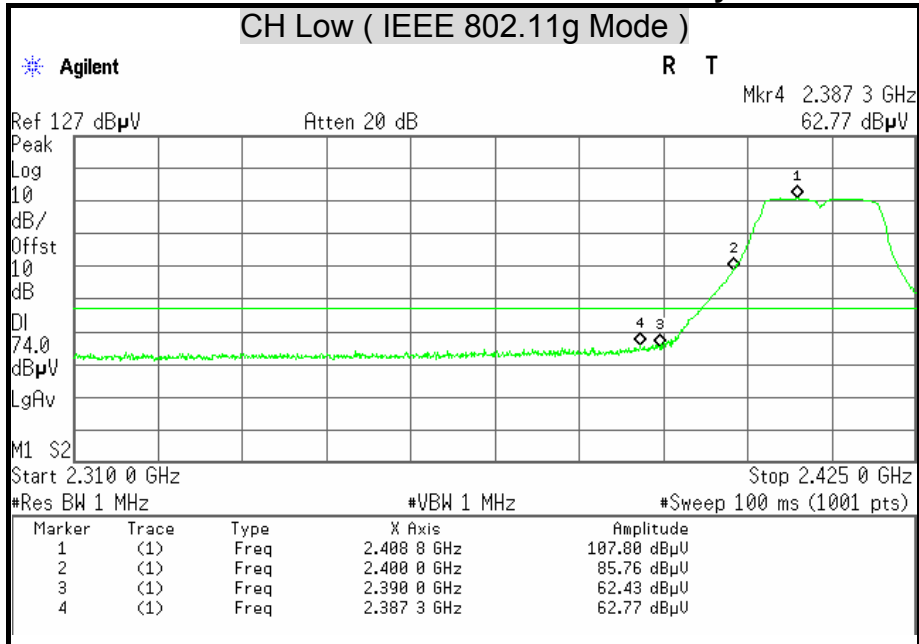

Detector Mode : Average

Polarity : Horizontal

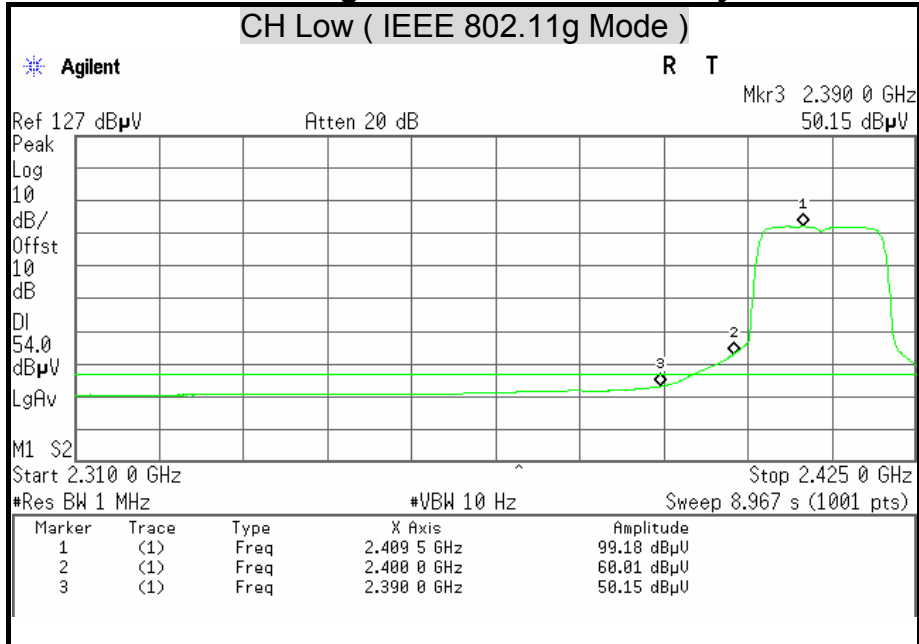



Detector Mode : Peak

Polarity : Vertical

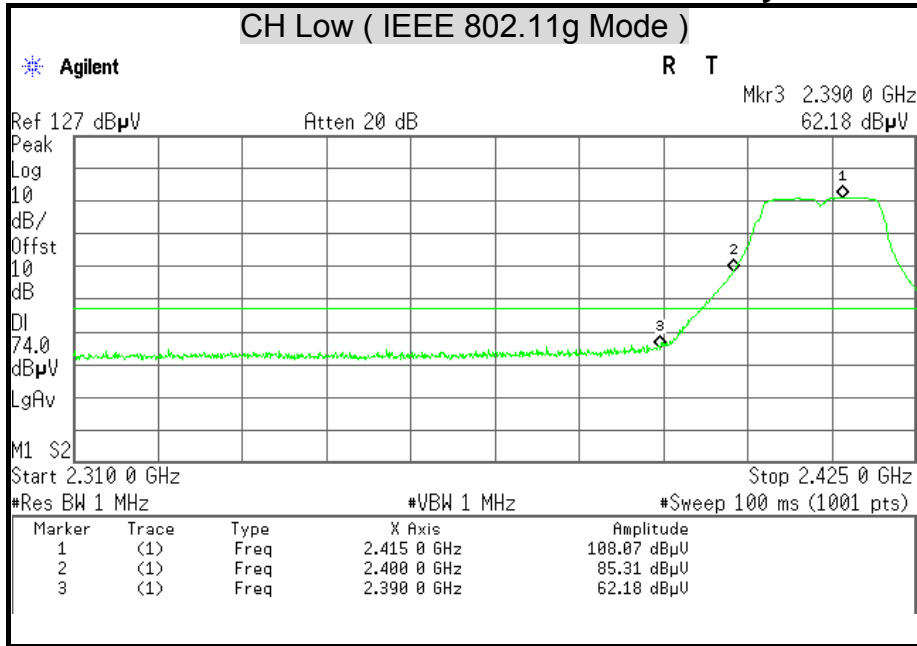

Detector Mode : Average

Polarity : Vertical

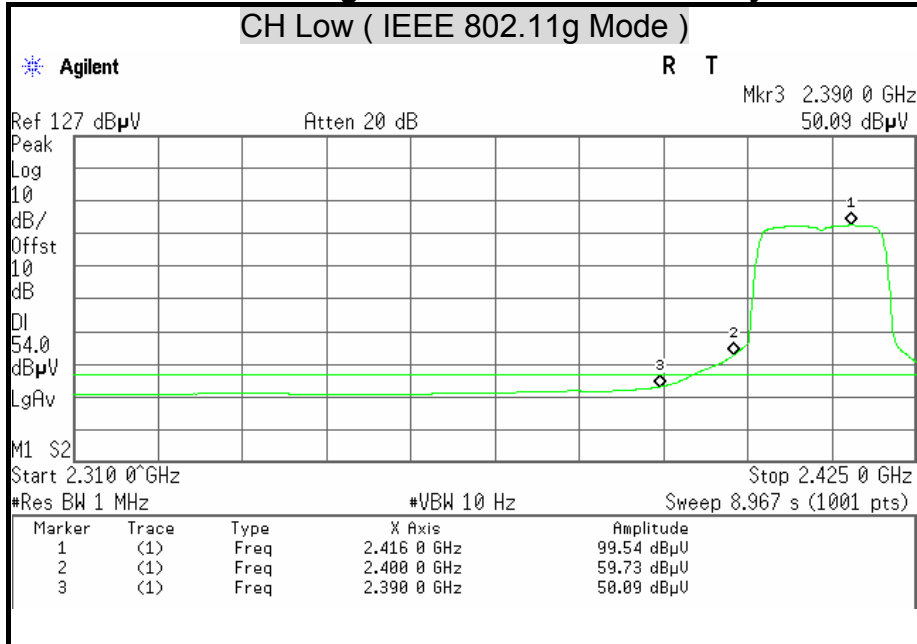



Detector Mode : Peak

Polarity : Horizontal

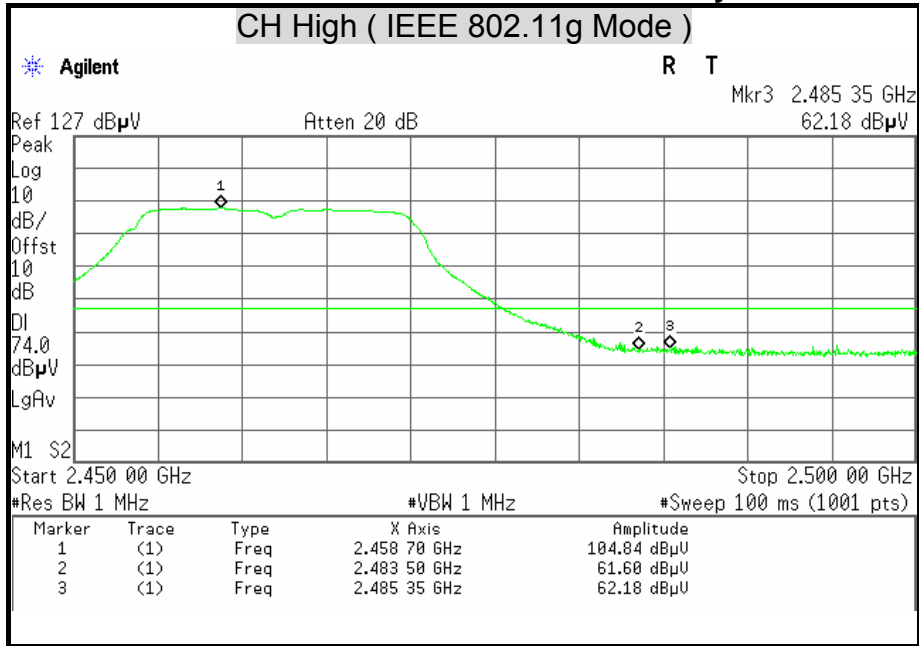

Detector Mode : Average

Polarity : Horizontal

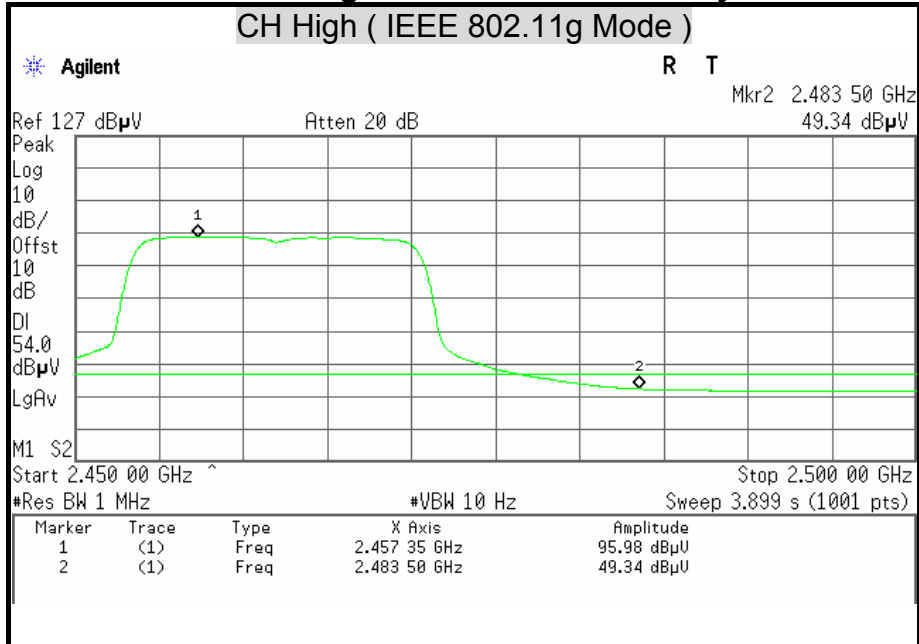



Detector Mode : Peak

Polarity : Vertical

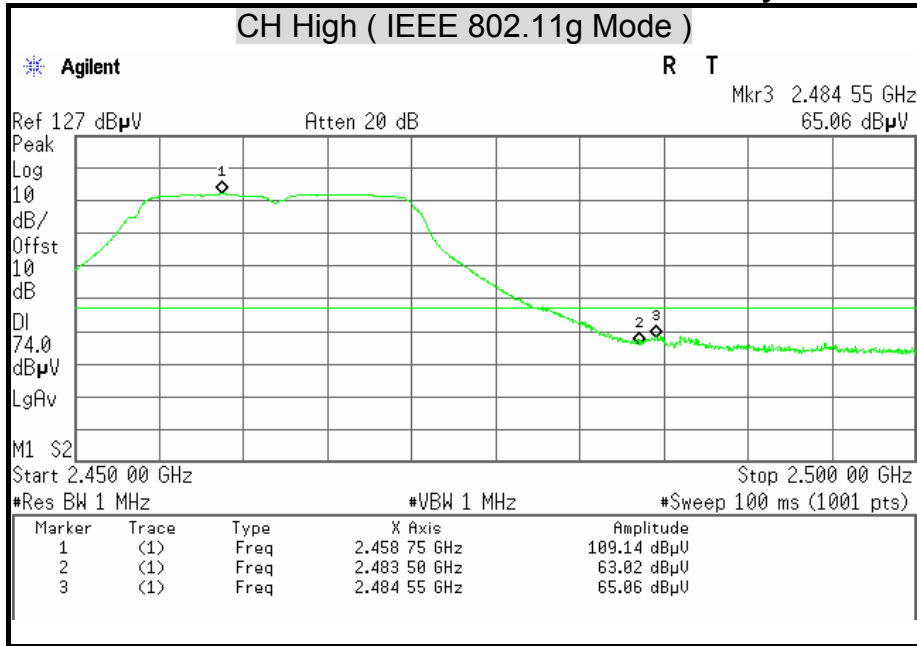

Detector Mode : Average

Polarity : Vertical

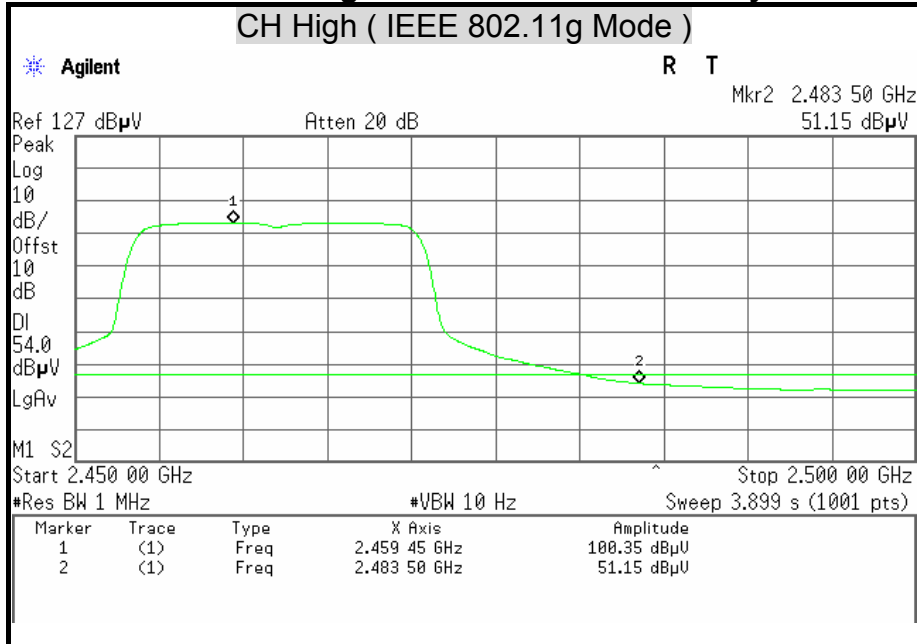



Detector Mode : Peak

Polarity : Horizontal

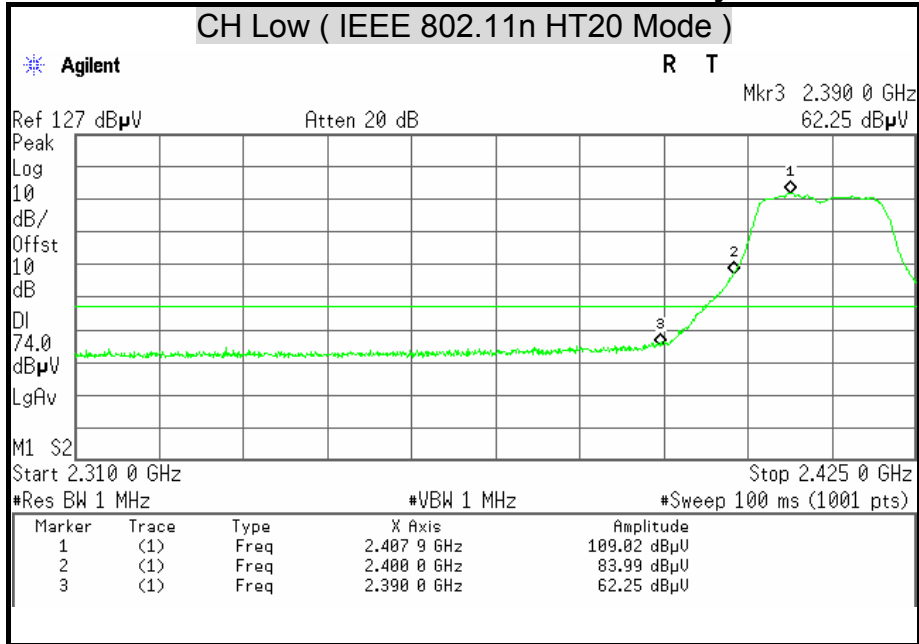

Detector Mode : Average

Polarity : Horizontal

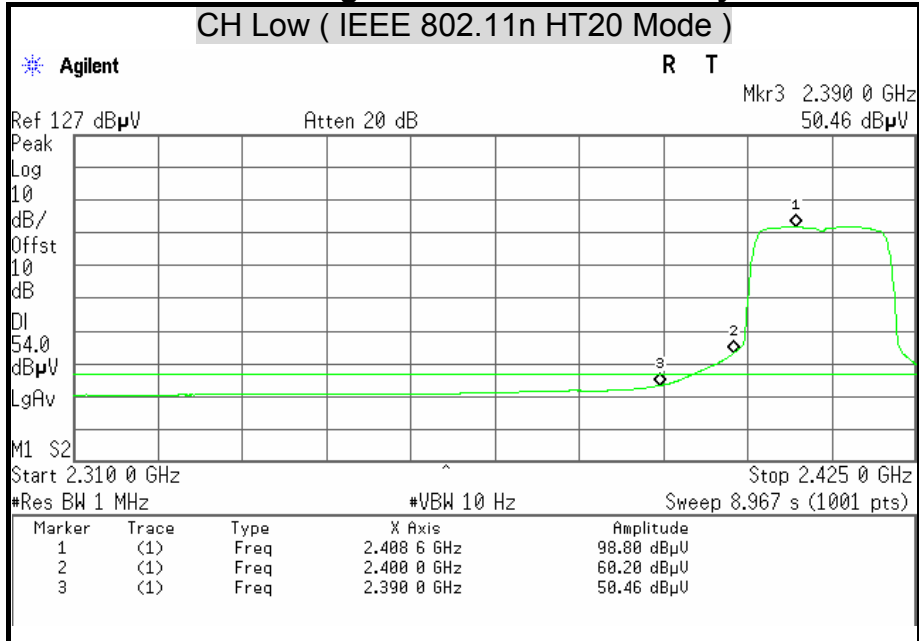



Detector Mode : Peak

Polarity : Vertical

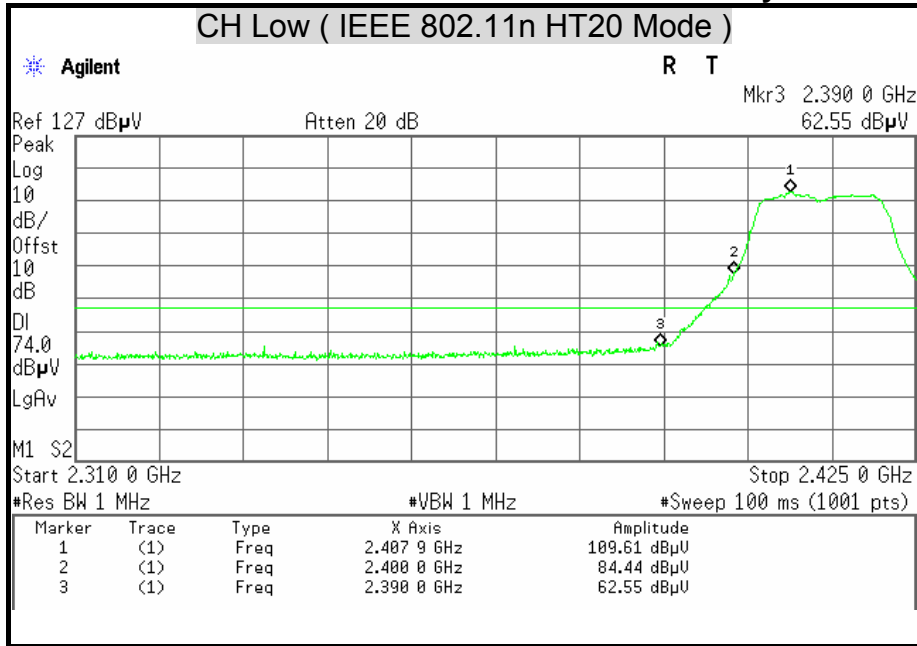

Detector Mode : Average

Polarity : Vertical

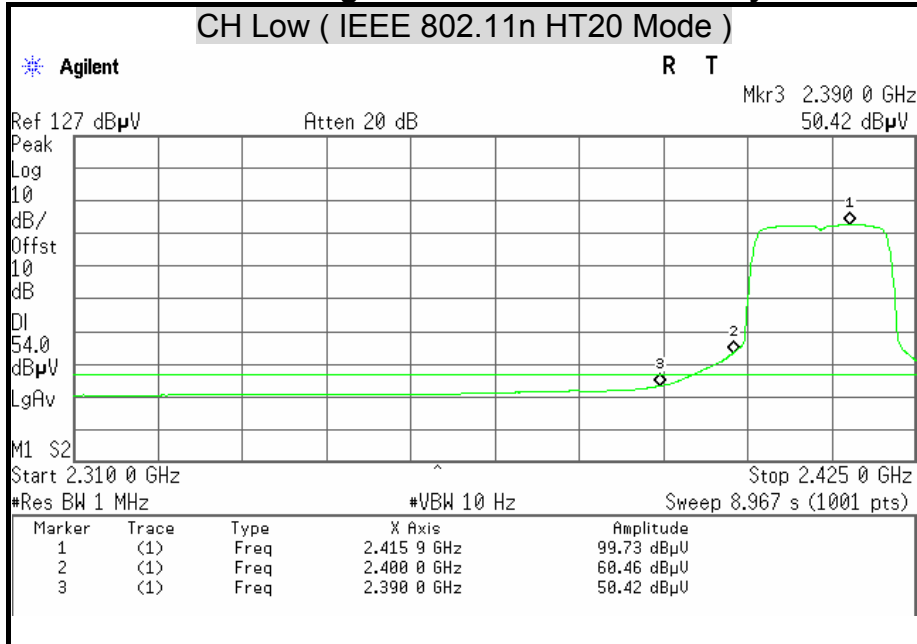



Detector Mode : Peak

Polarity : Horizontal

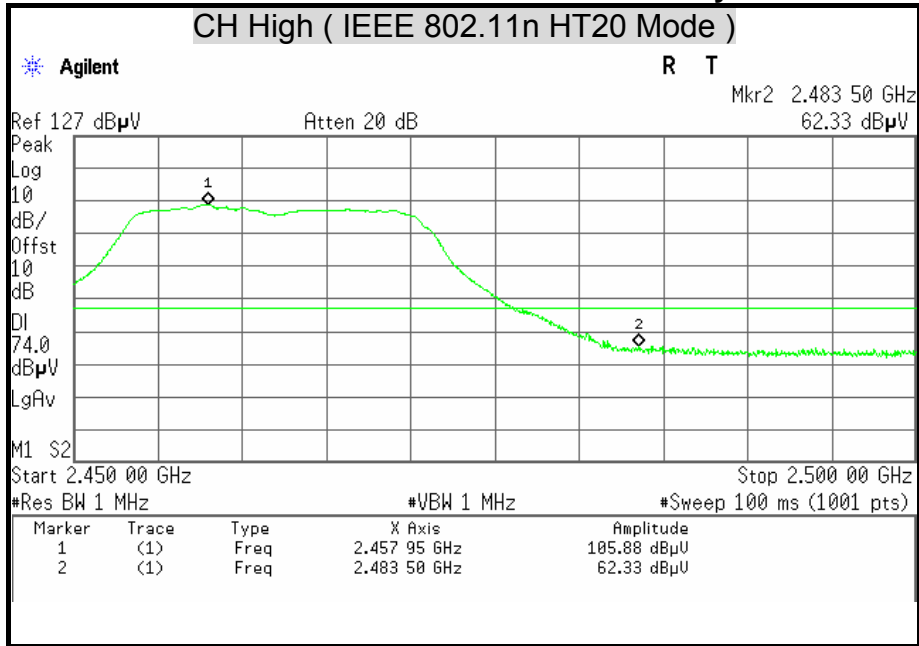

Detector Mode : Average

Polarity : Horizontal

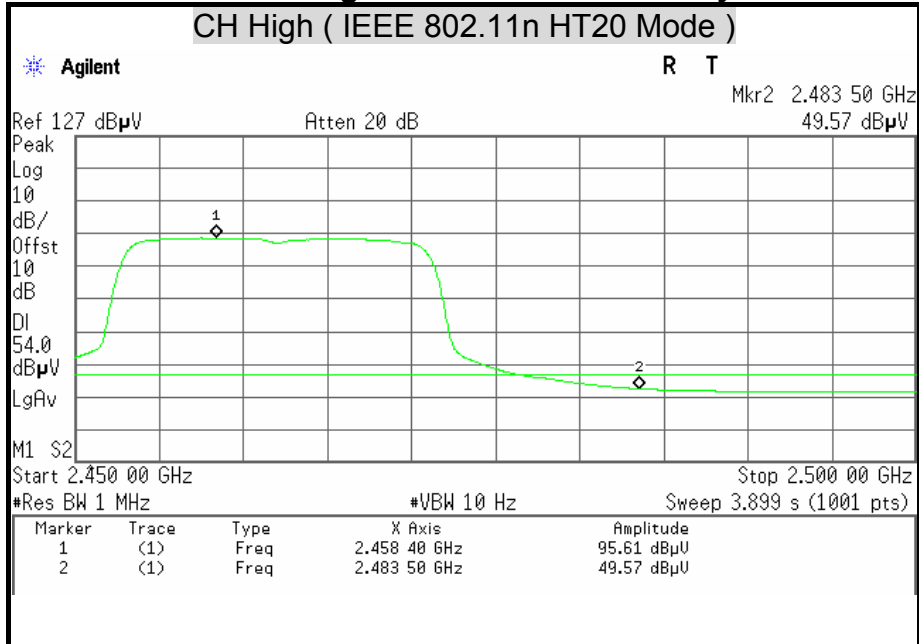



Detector Mode : Peak

Polarity : Vertical

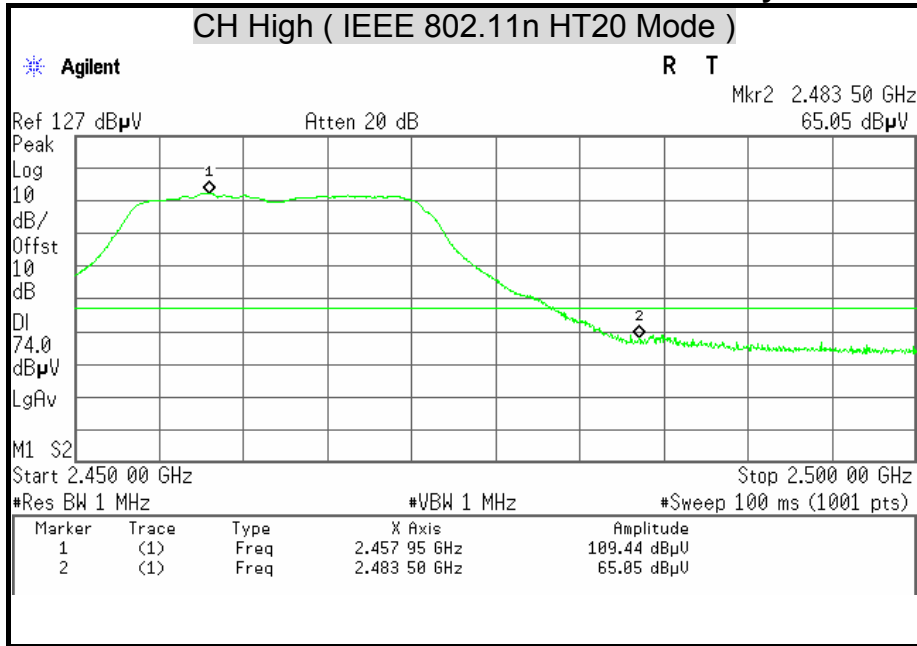

Detector Mode : Average

Polarity : Vertical

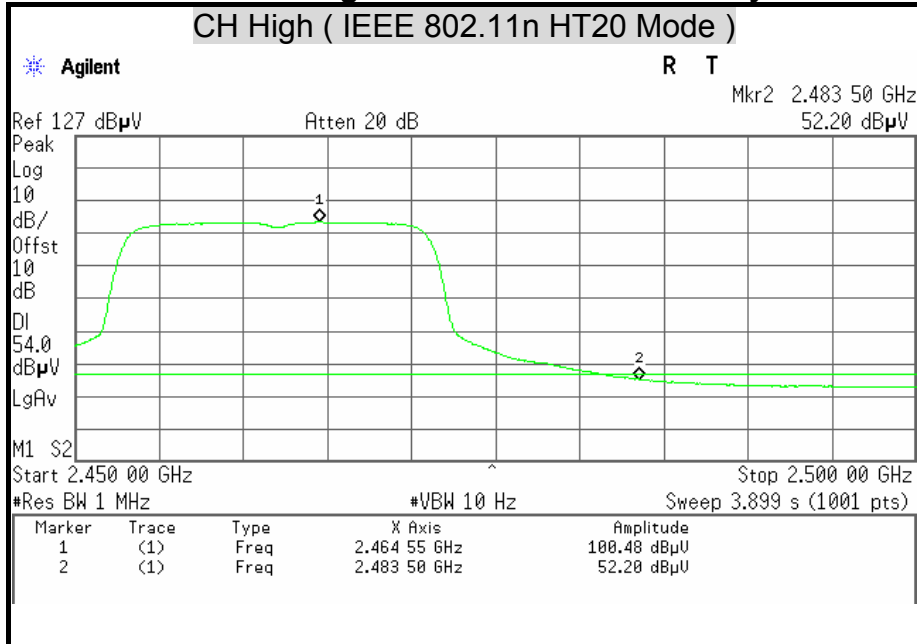





Detector Mode : Peak

Polarity : Horizontal

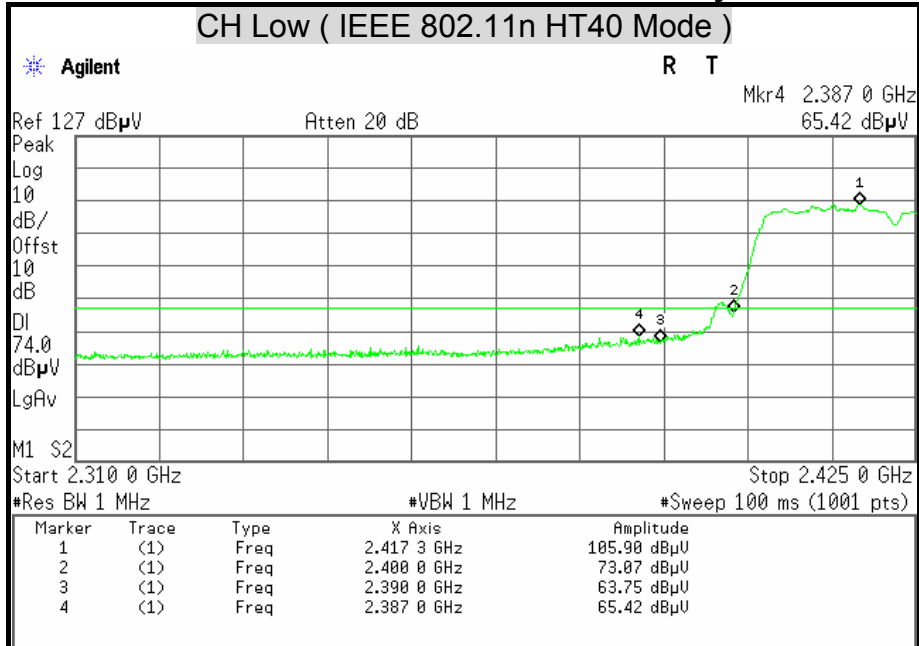

Detector Mode : Average

Polarity : Horizontal

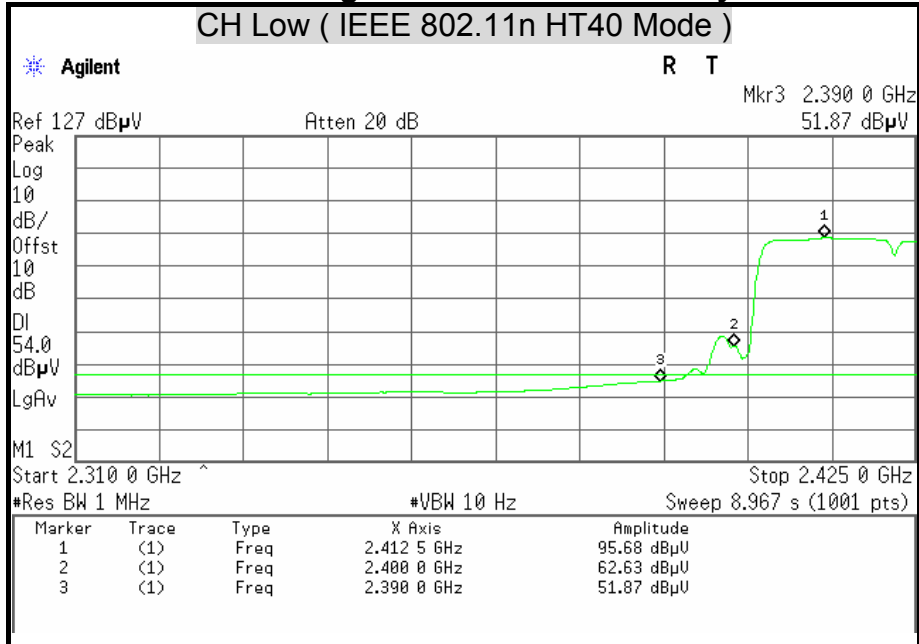



Detector Mode : Peak

Polarity : Vertical

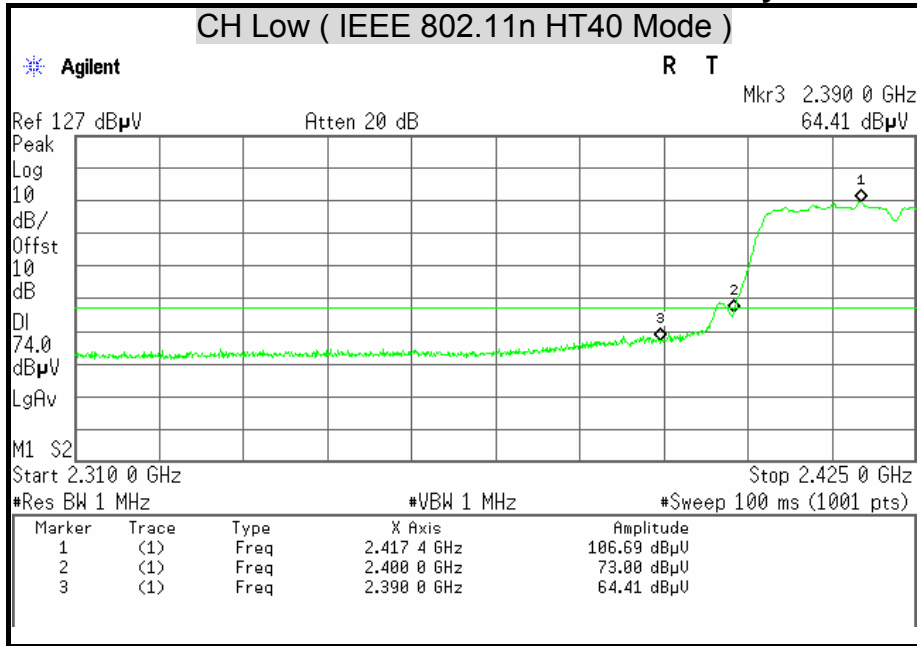

Detector Mode : Average

Polarity : Vertical

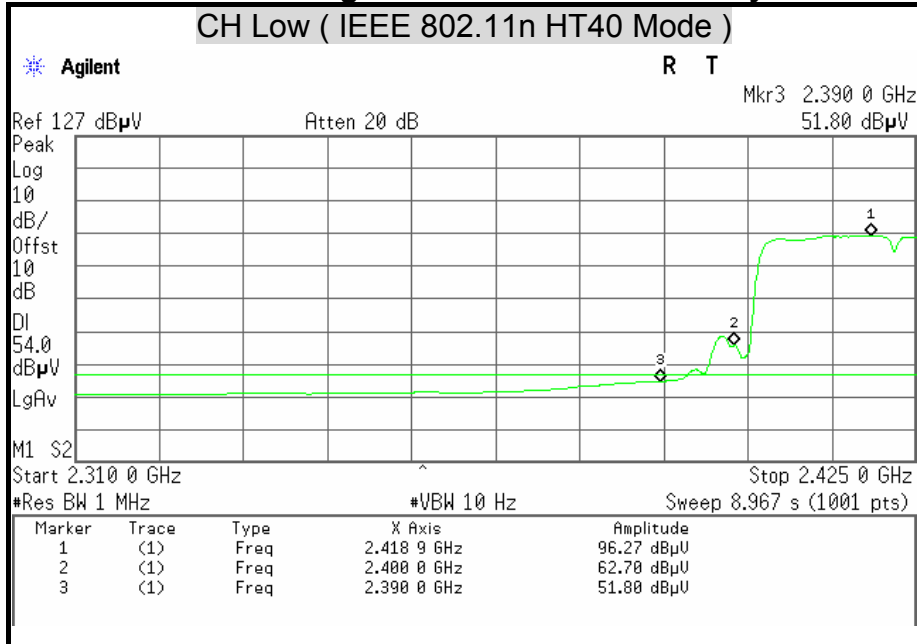



Detector Mode : Peak

Polarity : Horizontal

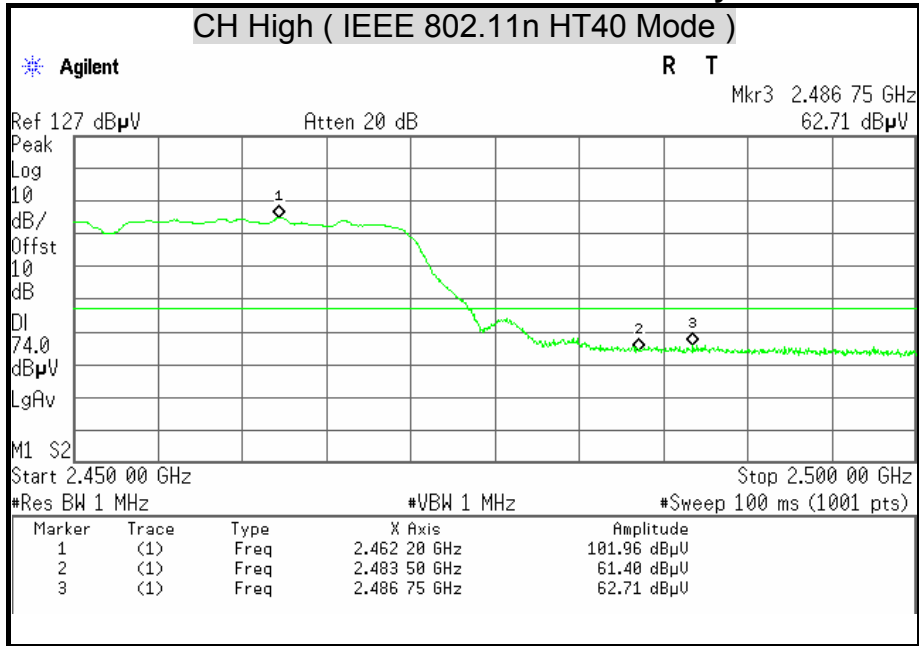

Detector Mode : Average

Polarity : Horizontal

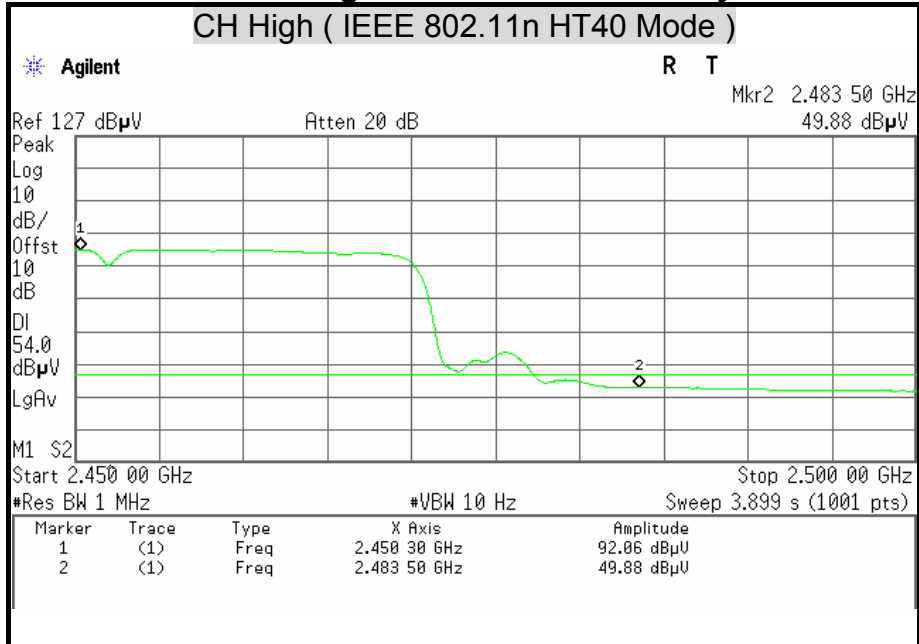



Detector Mode : Peak

Polarity : Vertical

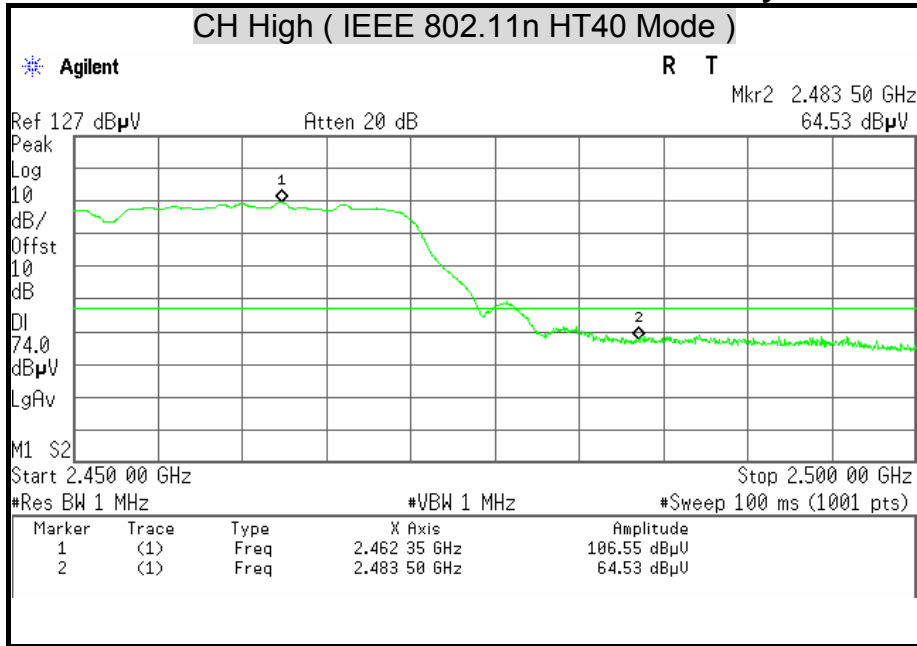

Detector Mode : Average

Polarity : Vertical

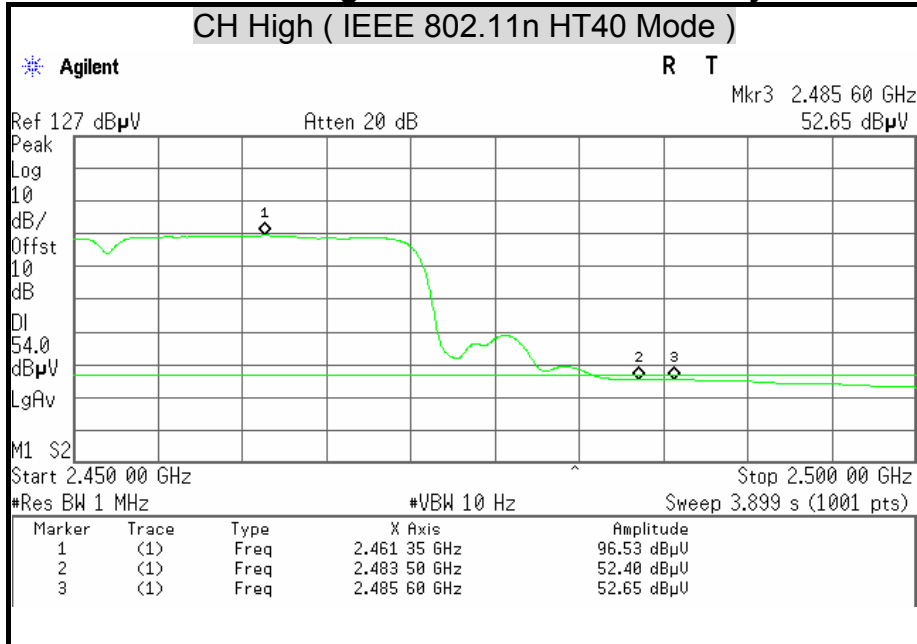



## 7.6 CONDUCTED EMISSION

### LIMITS

§ 15.207 (a) Except as shown in paragraph (b) and (c) this section, for an intentional radiator that is designed to be connected to the public utility (AC) power line, the radio frequency voltage that is conducted back onto the AC power line on any frequency or frequencies within the band 150 kHz to 30 MHz shall not exceed the limits in the following table, as measured using a 50  $\mu$ H/50 ohms line impedance stabilization network (LISN). Compliance with the provisions of this paragraph shall be based on the measurement of the radio frequency voltage between each power line and ground at the power terminal. The lower limit applies at the boundary between the frequency ranges.

Frequency Range (MHz)	Conducted Limit (dB $\mu$ v)	
	Quasi-peak	Average
0.15 - 0.50	66 to 56	56 to 46
0.50 - 5.00	56	46
5.00 - 30.0	60	50

### TEST EQUIPMENT

Name of Equipment	Manufacturer	Model	Serial Number	Calibration Due
L.I.S.N	SCHWARZBECK	NSLK 8127	8127-465	08/07/2013
L.I.S.N	SCHWARZBECK	NSLK 8127	8127-473	03/12/2013
EMI Receiver	ROHDE & SCHWARZ	ESCS 30	835418/008	10/20/2012
Pulse Limiter	ROHDE & SCHWARZ	ESH3-Z2	100117	07/03/2013

*Remark: Each piece of equipment is scheduled for calibration once a year.*



**TEST SETUP**

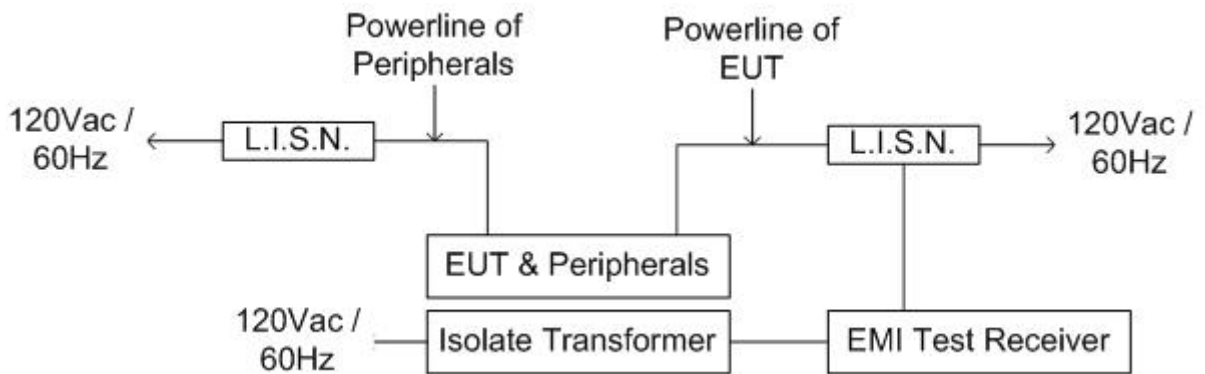
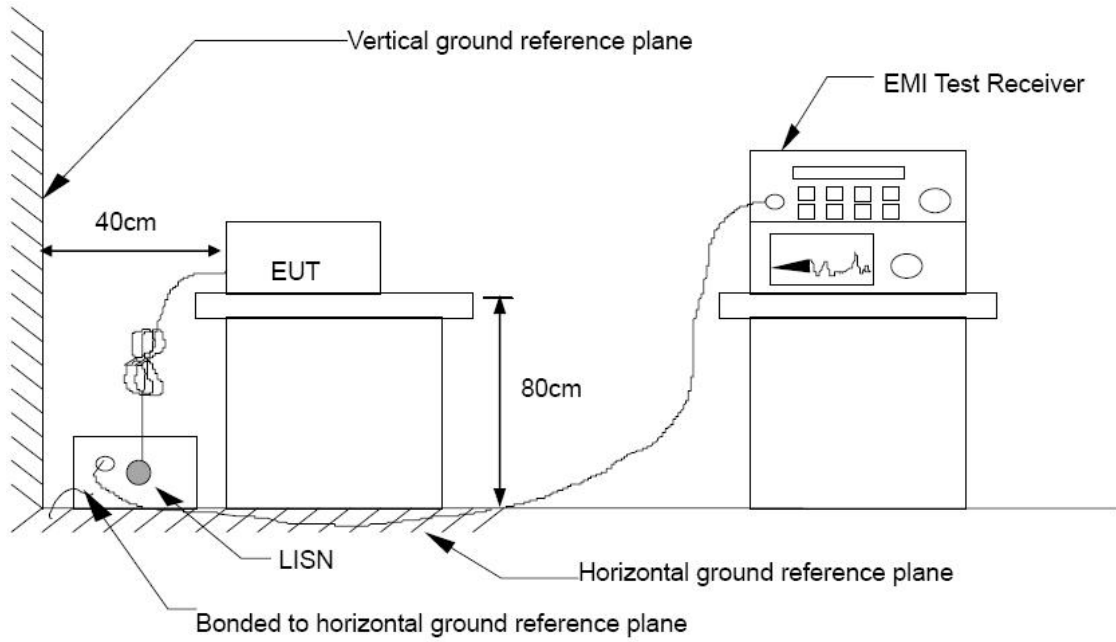



## **TEST PROCEDURE**

The basic test procedure was in accordance with ANSI C63.4:2003.

The test procedure is performed in a 4m × 3m × 2.4m (L×W×H) shielded room.

The EUT along with its peripherals were placed on a 1.0m (W) × 1.5m (L) and 0.8m in height wooden table and the EUT was adjusted to maintain a 0.4 meter space from a vertical reference plane.

The EUT was connected to power mains through a line impedance stabilization network (LISN) which provides 50 ohm coupling impedance for measuring instrument and the chassis ground was bounded to the horizontal ground plane of shielded room. All peripherals were connected to the second LISN and the chassis ground also bounded to the horizontal ground plane of shielded room.

The EUT was located so that the distance between the boundary of the EUT and the closest surface of the LISN is 0.8 m. Where a mains flexible cord was provided by the manufacturer shall be 1 m long, or if in excess of 1 m, the excess cable was folded back and forth as far as possible so as to form a bundle not exceeding 0.4 m in length.



TEST RESULTS

Product Name	Wireless IP CAM	Test By	Waternil Guan
Test Model	F3107	Test Date	2012/08/28
Test Mode	Normal Operating / Power Adapter AMIGO	Temp. & Humidity	26°C, 58%

LINE

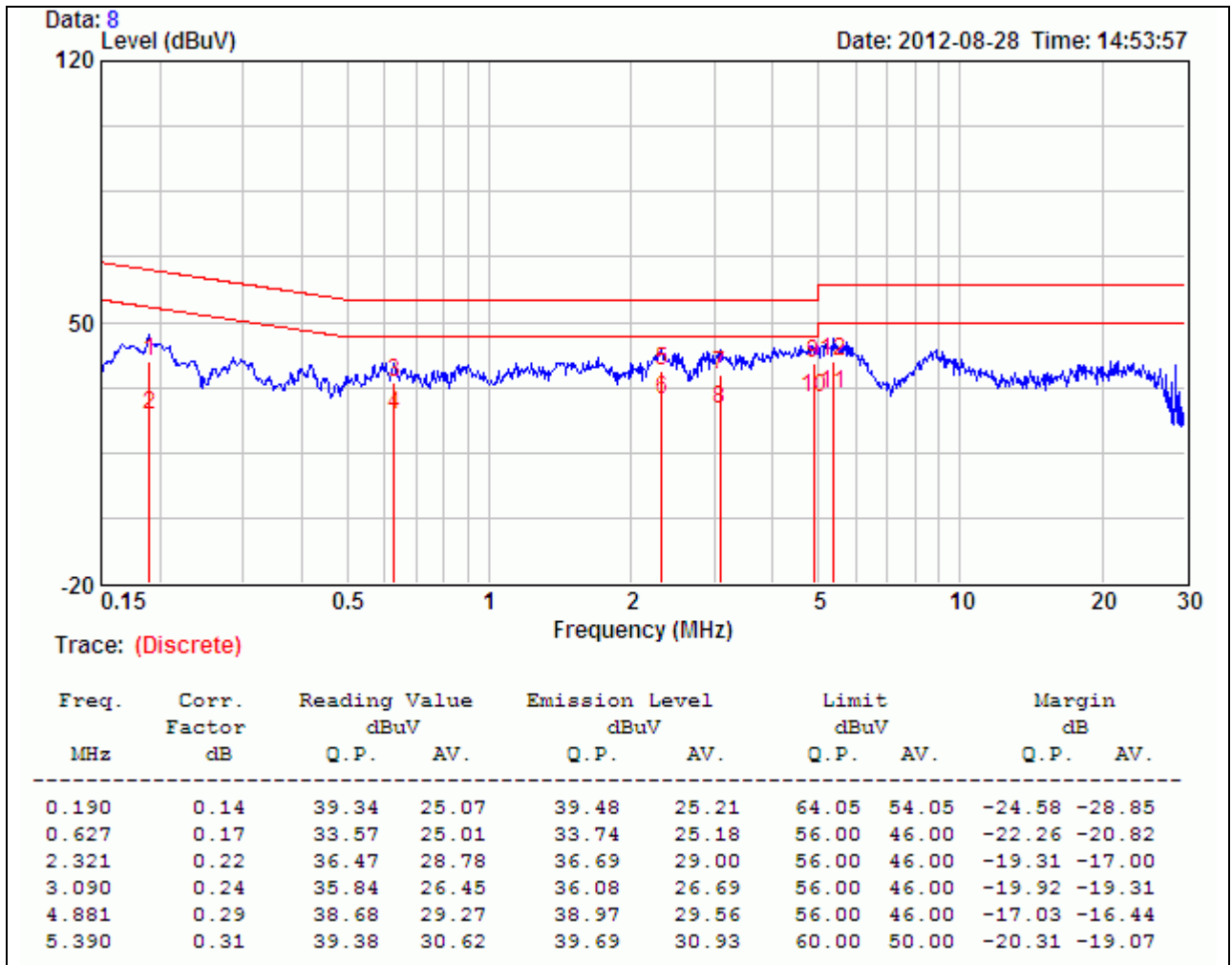

Remark:

1. Correction Factor = Insertion loss + Cable loss
2. Emission level = Reading Value + Correction factor
3. Margin value = Emission level – Limit value





<b>Product Name</b>	Wireless IP CAM	<b>Test By</b>	Waternil Guan
<b>Test Model</b>	F3107	<b>Test Date</b>	2012/08/28
<b>Test Mode</b>	Normal Operating / Power Adapter AMIGO	<b>Temp. &amp; Humidity</b>	26°C, 58%

NEUTRAL

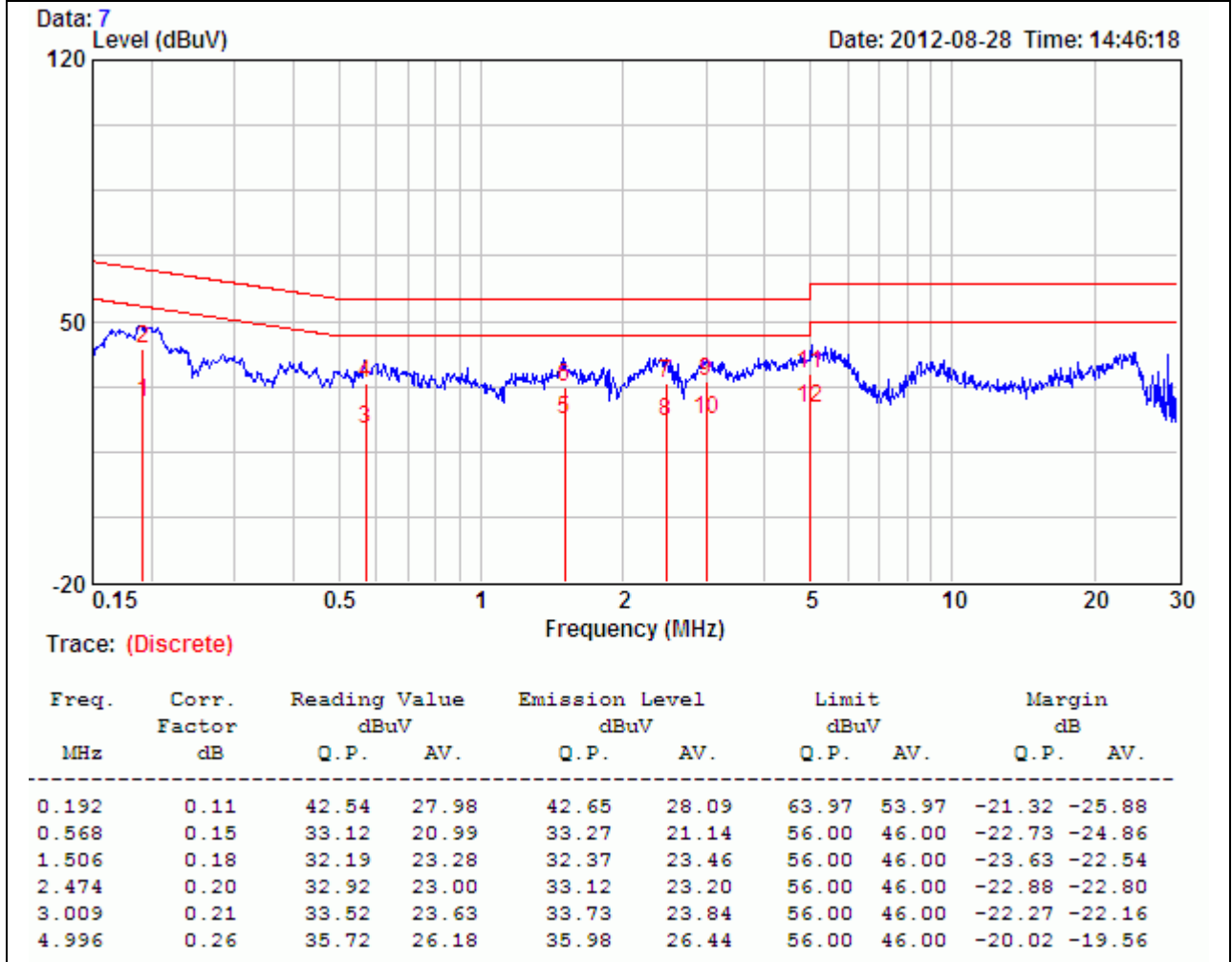

Remark:

1. Correction Factor = Insertion loss + Cable loss
2. Emission level = Reading Value + Correction factor
3. Margin value = Emission level – Limit value



<b>Product Name</b>	Wireless IP CAM	<b>Test By</b>	Waternil Guan
<b>Test Model</b>	F3107	<b>Test Date</b>	2012/08/28
<b>Test Mode</b>	Normal Operating / Power Adapter DVE	<b>Temp. &amp; Humidity</b>	26°C, 58%

LINE

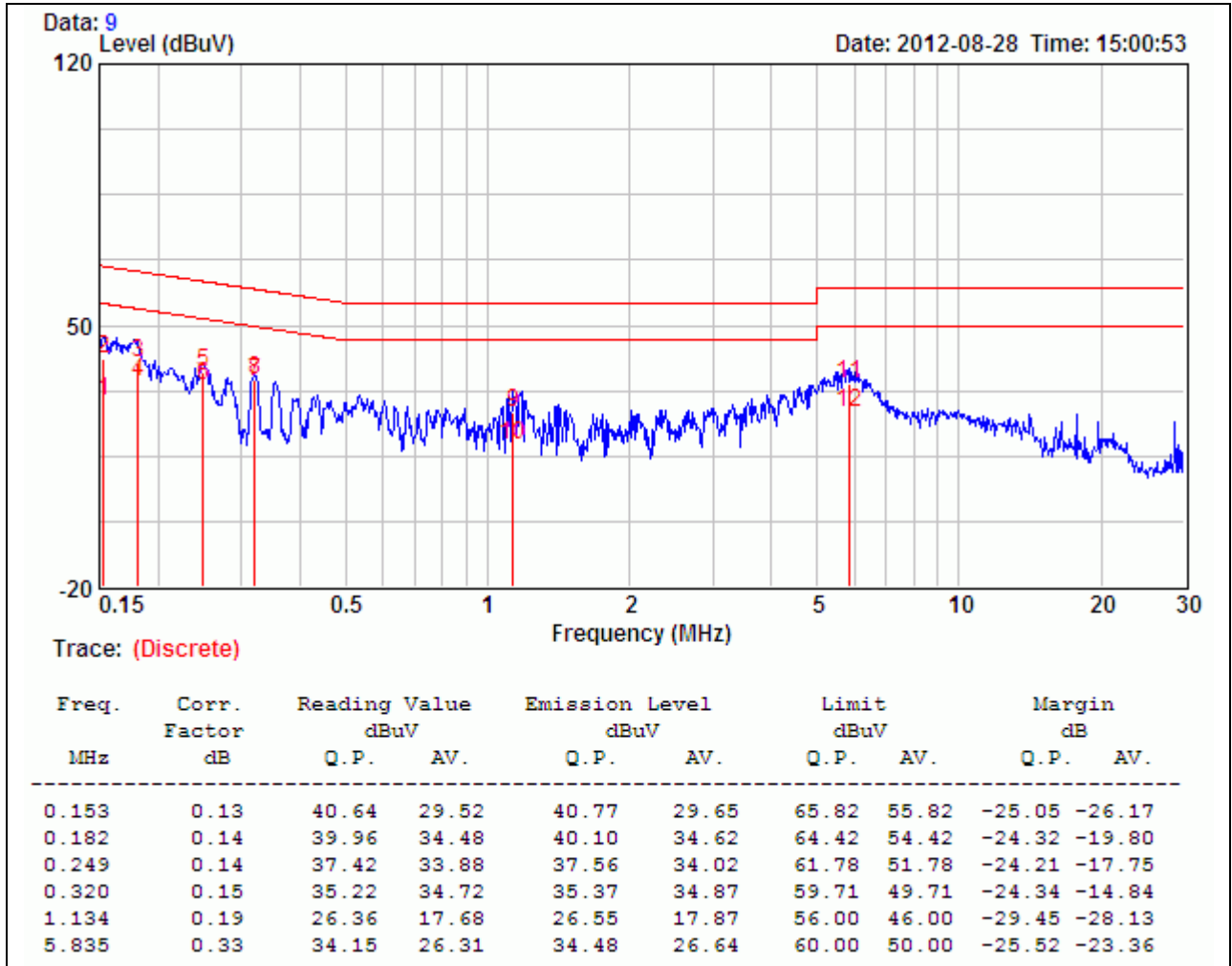

**Remark:**

1. Correction Factor = Insertion loss + Cable loss
2. Emission level = Reading Value + Correction factor
3. Margin value = Emission level – Limit value



<b>Product Name</b>	Wireless IP CAM	<b>Test By</b>	Waternil Guan
<b>Test Model</b>	F3107	<b>Test Date</b>	2012/08/28
<b>Test Mode</b>	Normal Operating / Power Adapter DVE	<b>Temp. &amp; Humidity</b>	26°C, 58%

NEUTRAL

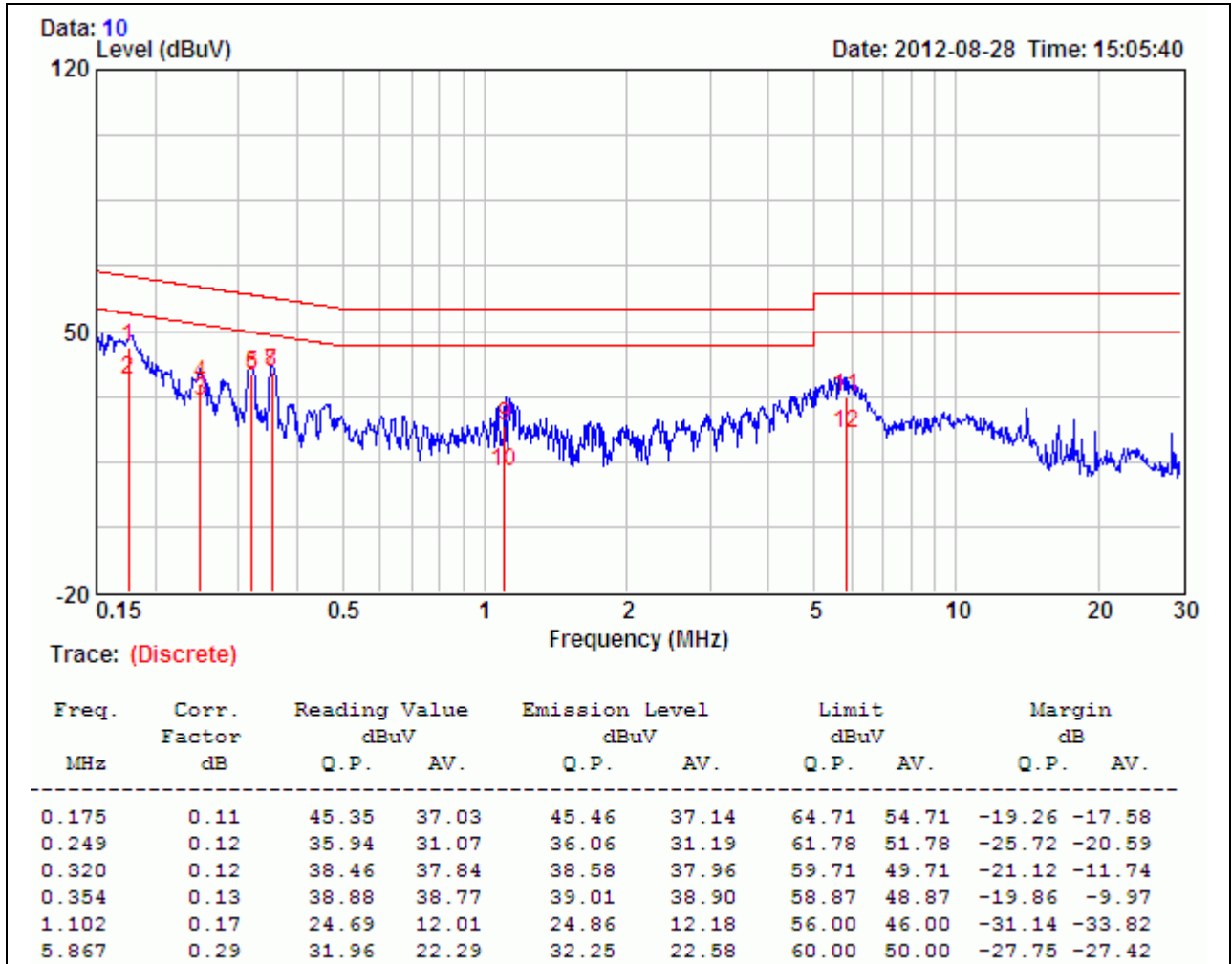

Remark:

1. Correction Factor = Insertion loss + Cable loss
2. Emission level = Reading Value + Correction factor
3. Margin value = Emission level - Limit value