

TEST REPORT**No. SH08110149-002**

Applicant : Ericsson (China) Communications Company Ltd.
Ericsson Tower, No.5 Lize East Street,
Chaoyang District Beijing 100102, P.R.China

Manufacturer : Ericsson (China) Communications Company Ltd.
Ericsson Tower, No.5 Lize East Street,
Chaoyang District Beijing 100102, P.R.China

Equipment : Remote Base Station

Type/Model : RBS 2409((4/HRB 105 14)

Test Result : Pass

TEST SUMMARY

The equipment comply with the requirements according to the following standards:

47CFR Part 24.238(a): 2007: Personal Communications Services

RSS-133(Section 6.5):2008: Spectrum Management and Telecommunications
Radio Standards Specification -2 GHz Personal Communications Services

This report applies to tested sample only. This report shall not be reproduced in part without written approval of Intertek.

Reference	Test item	Result	Note
FCC: 24.238(a) and 2.1053 IC: RSS-133:Section 6.5	Radiated Spurious Emissions	Pass	-

Date of issue: Nov 10, 2008

Prepared by:

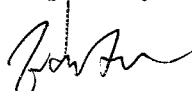

Edwin Xu (Project engineer)

Approved by:

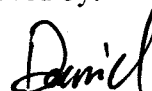

Daniel Zhao (Reviewer)



Content

TEST SUMMARY	1
CONTENT	2
1. GENERAL INFORMATION	3
1.1 Description of Equipment under Test (EUT)	3
1.2 Description of Client	3
1.3 Description of Test Facility	3
1.4 Description of Test Personnel.....	4
2. TEST SPECIFICATIONS	5
2.1 Instrument List	5
2.2 Interfaces of the EUT	5
2.3 System Configuration during Test.....	6
2.4 Modes of Operation.....	7
RADIATED SPURIOUS EMISSION TEST	8
3. RADIATED SPURIOUS EMISSION	8
4.1 Radiated Emission Limit from Frequency Range 30MHz – 20000MHz	8
4.2 Block Diagram of Test Set up	9
4.2.1 Block diagram	9
4.2.2 Test set-up photo	9
4.3 Test Setup and Test Procedure	12
4.4 Test Result.....	13
4.5 Measurement uncertainty	31
4.6 Additions, Deviations and Exclusions from Standards.....	31
APPENDIX I : HARDWARE LIST FOR EUT :	32

1. GENERAL INFORMATION

1.1 Description of Equipment under Test (EUT)

EUT : Remote Base Station
Description of EUT : The equipment is a Radio Equipment of GSM base station. A full technical description is held by Ericsson.
Model number : RBS 2409((4/HRB 105 14)
Sample received date : Nov 03, 2008
Date of test : Nov 03-Nov 04, 2008

1.2 Description of Client

Applicant : Ericsson (China) Communications Company Ltd.
Ericsson Tower
No.5 Lize East Street, Chaoyang District
Beijing 100102, P.R.China
Person of contact : Mr. Leon Zhao
Telephone : 86 10 84767190
Telefax : 86 10 84767738

1.3 Description of Test Facility

Name : Intertek Testing Service Shanghai Limited
Address : Building No. 86, 1198 Qinzhou Road (North),
Shanghai 200233, China
FCC recognition number : 236597
IC recognition number : IC6201
Telephone : 86 21 61278200
Telefax : 86 21 54262353



1.4 Description of Test Personnel

All the tests are performed by Edwin Xu (Engineer of Intertek Testing Services Shanghai Limited) at Intertek Testing Services Shanghai Limited EMC lab.

2. TEST SPECIFICATIONS

2.1 Instrument List

Equipment	Type	Manu.	Internal no.	Cal. Date	Due date
Semi-anechoic chamber	-	Albatross project	EC 3048	2008-6-27	2009-6-26
Test Receiver	ESIB 26	R&S	EC 3045	2008-7-1	2009-6-30
Horn antenna	HF906	R&S	EC 3049	2008-7-1	2009-6-30
Horn antenna	0401	ZHINAN	EC 3047	2008-7-1	2009-6-30
Log-period antenna	AT 1080	AR	EC 3044-7	2008-8-22	2009-8-21
Pre-amplifier	Pre-amp 18	R&S	EC 3222	2008-7-1	2009-6-30

2.2 Interfaces of the EUT

Test Interfaces:

Interface	Name	Mode	Note
Ethernet	Cable	120 ohm	Shielded
AC Power	Cable	120V, 60Hz	-

2.3 System Configuration during Test

The tests were configured as shown below.

Configuration 1:

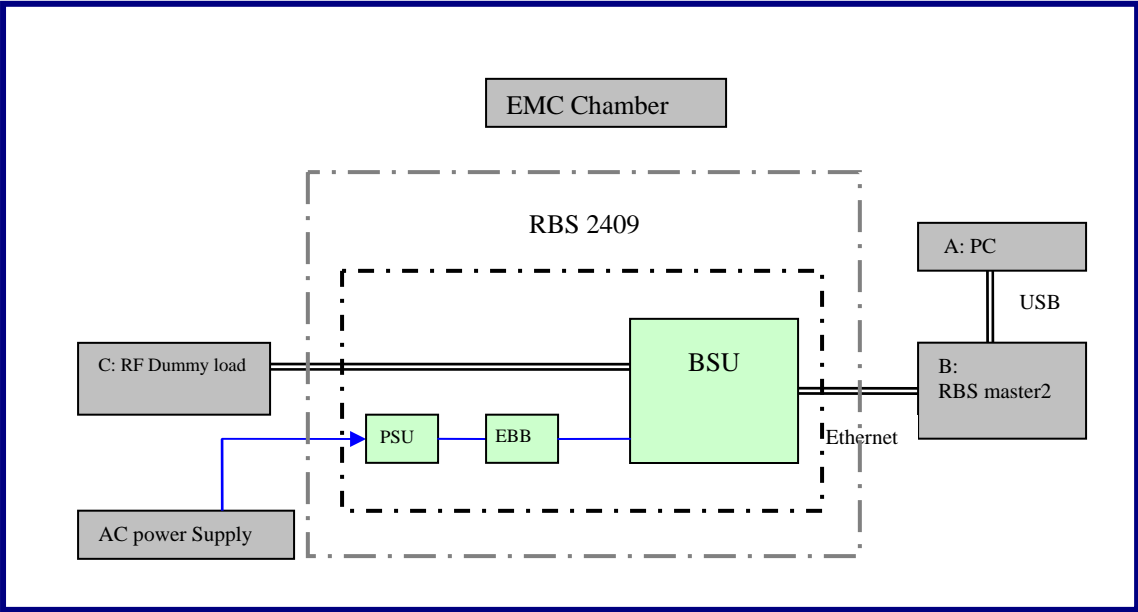

Note: Dummy load C was connected.

Configuration 2:

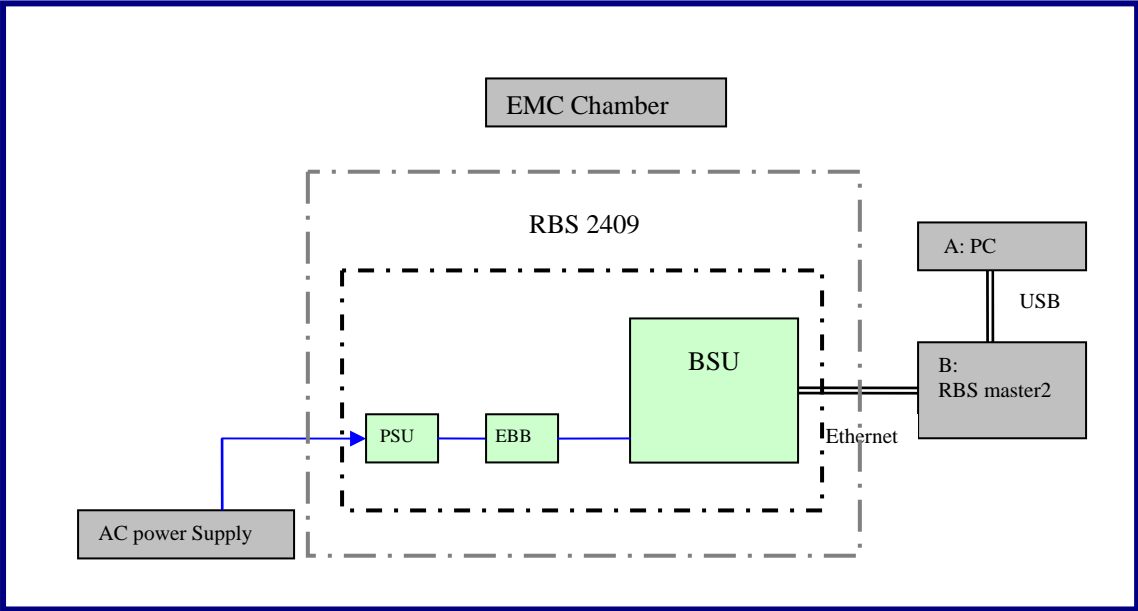

Auxiliary Equipment:

Auxiliary Equipment	Name	Model	Serial Num.	Note
A	Personal Computer	HP Compaq 2510p	-	With software RBS Master2 MMI: R10C01 CUX: R6C01
B	RBS Master 2	LPY 107 1007/1	ETE/L345	-
C	Dummy load	50 ohm	-	-

2.4 Modes of Operation

Emission test:

TRX was set on ARFCN 512, 661 and 810, the maximum output power is 23 dBm. The RBS 2409 was configured to use external antenna with Dummy load and internal antenna. The backup battery EBB-11 was connected.

HW configuration:

Test cases	Configuration	Mode	Antenna	Modulation	ARFCN	Comments
Radio Emission	Configuration 1	Mode 1	External	GMSK	512	With load
			External	8PSK	512	With load
		Mode 2	External	GMSK	661	With load
			External	8PSK	661	With load
		Mode 3	External	GMSK	810	With load
			External	8PSK	810	With load
	Configuration 2	Mode 4	Internal	GMSK	512	-
			Internal	8PSK	512	-
		Mode 5	Internal	GMSK	661	-
			Internal	8PSK	661	-
		Mode 6	Internal	GMSK	810	-
			Internal	8PSK	810	-

Radiated Spurious Emission Test

3. Radiated Spurious Emission

Test Result: Pass

4.1 Radiated Emission Limit from Frequency Range 30MHz – 20000MHz

Limits of Configuration1: External antenna

Frequency (MHz)	Maximum RF Field limit
	dB(μV/m)
30-1000	84.38(Quasi-peak))
1000-20000	84.38 (Average)
<p>Note1. The measurement distance is 3m</p> <p>Note2. For external antenna Gi is 1.64(assuming all emissions are radiated from halfwave dipole antennas according to 2.1053.</p> <p>Note3: The limit: $E(v/m)=(30 \times Gi \times Po)^{0.5} / d - (43 + 10\log(Po))$ $=10\log(30Gi)-20\log(d)+77$ $=84.38$</p>	

Limits of Configuration 2: Internal antenna

Frequency (MHz)	Maximum RF Field limit
	dB(μV/m)
30-1000	84.48(Quasi-peak))
1000-20000	84.48(Average)
<p>Note1. The measurement distance is 3m</p> <p>Note2. For internal antenna Gi is 1.68(provided by the manufacturer)</p> <p>Note3: The limit: $E(v/m)=(30 \times Gi \times Po)^{0.5} / d - (43 + 10\log(Po))$ $=10\log(30Gi)-20\log(d)+77$ $=84.48$</p>	

4.2 Block Diagram of Test Set up

4.2.1 Block diagram

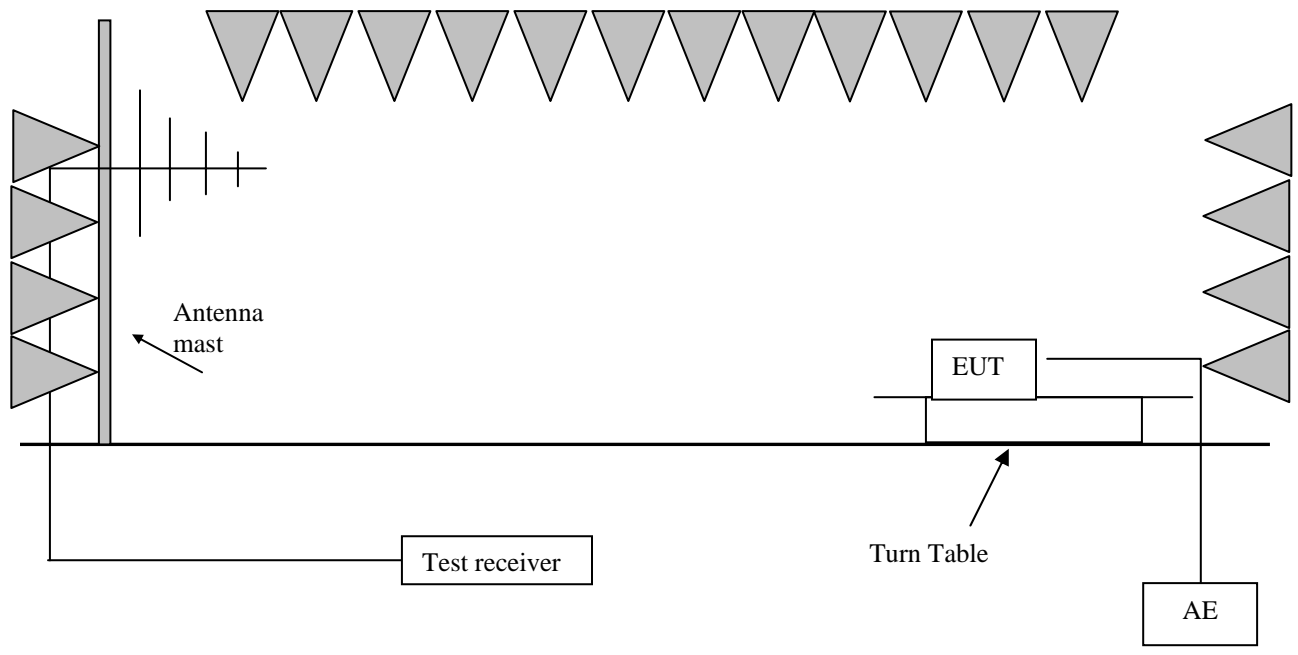

4.2.2 Test set-up photo

30MHz-1000MHz:
Configuration 1:



Configuration 2:

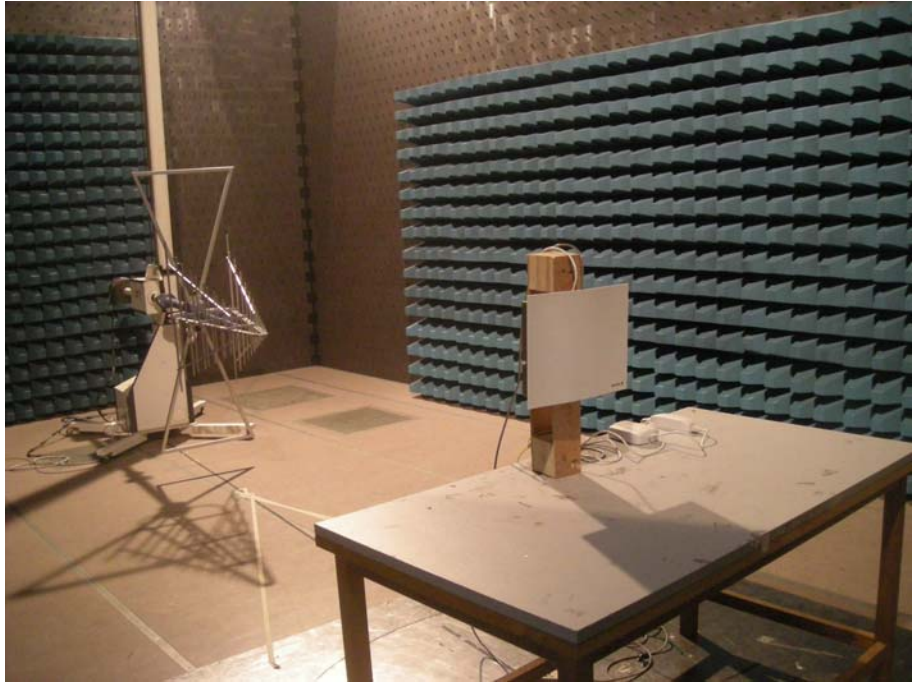

1000MHz-18000MHz:
Configuration 1:

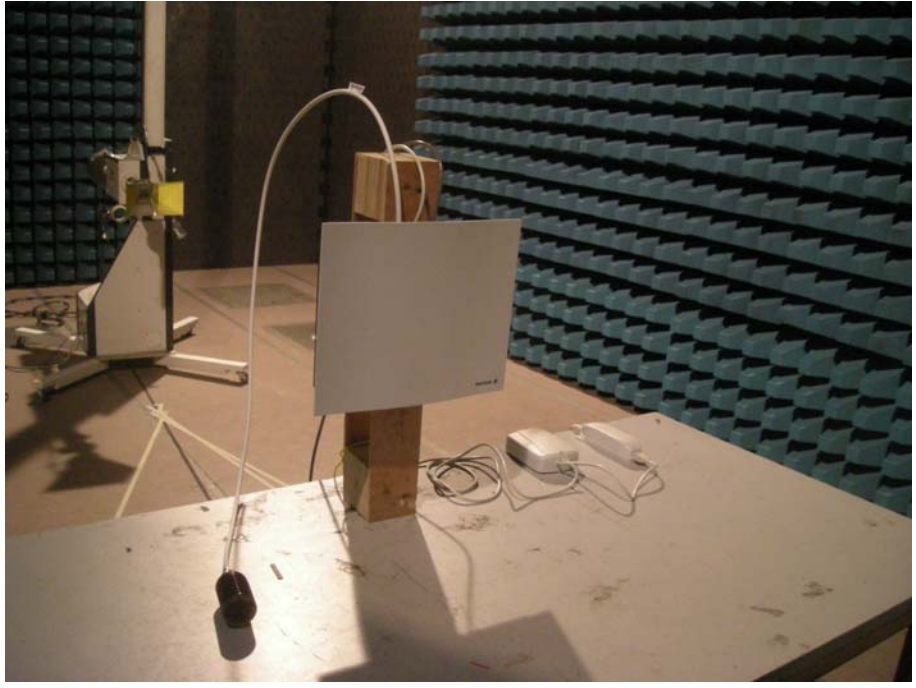

Configuration 2:

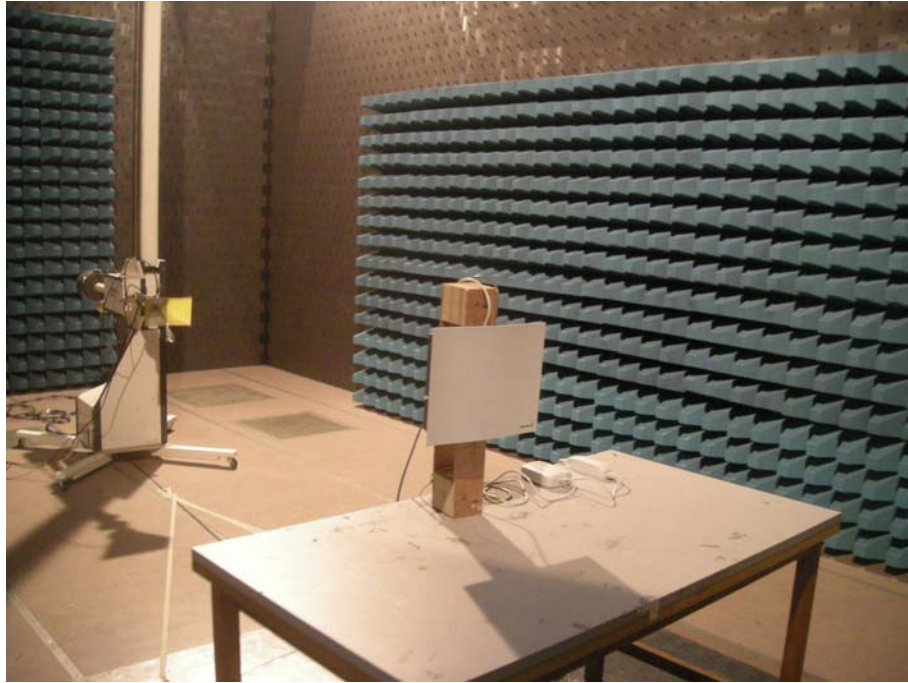

18000MHz-20000MHz:
Configuration 1:



Configuration 2:



4.3 Test Setup and Test Procedure

The measurement was performed in a 3 m semi-anechoic chamber.

The EUT and its accessory equipment were set under its typical operation conditions (worst case was selected) and placed on a turntable at 0.8 m high above the horizontal metal ground plane. The turntable rotated 360 degrees to determine the position of the maximum emission level. The EUT was set 3 meters away from the receiving antenna which was mounted on an antenna mast. The antenna moved up and down between from 1 meter to 4 meters to find out the maximum emission level.

Horn antenna and Log-period antenna were used as receiving antenna. Both horizontal and vertical polarization of the antenna were set on measurement.

On any frequency or frequencies below or equal to 1000 MHz, the limits shown are based on measuring equipment employing quasi-peak detector function and related measurement bandwidths.

On any frequency or frequencies above 1000 MHz, the radiated emission limits are based on the use of measurement instrumentation employing peak and average detector function.

The bandwidth setting on R&S Test Receiver ESIB26 was 120kHz (for 30MHz to 1GHz) and 1MHz (1GHz to 20GHz).

4.4 Test Result

Temperature: 22 °C Relative Humidity: 49 %

Configuration1: Mode 1 GMSK (margin>20dB)

30M-1000M:

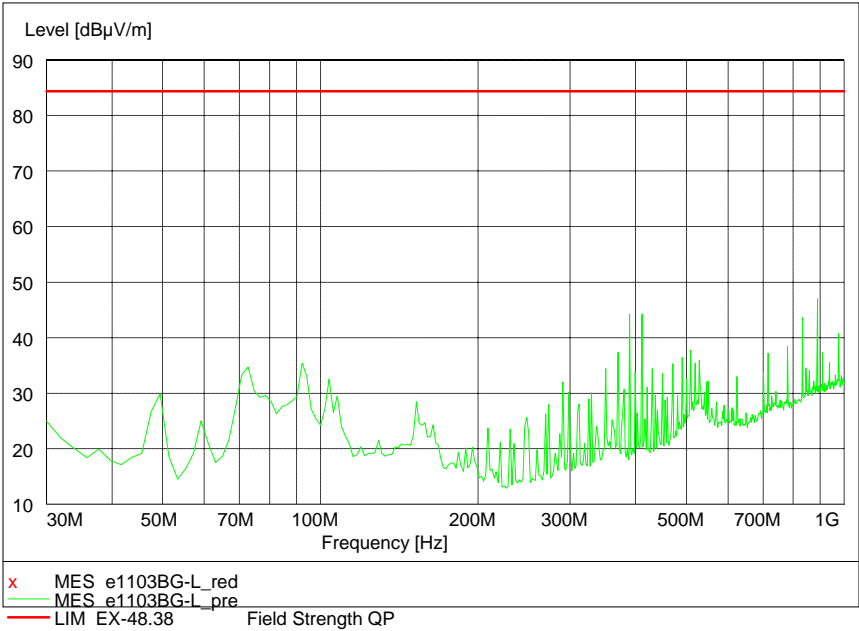

1000M-18000M:

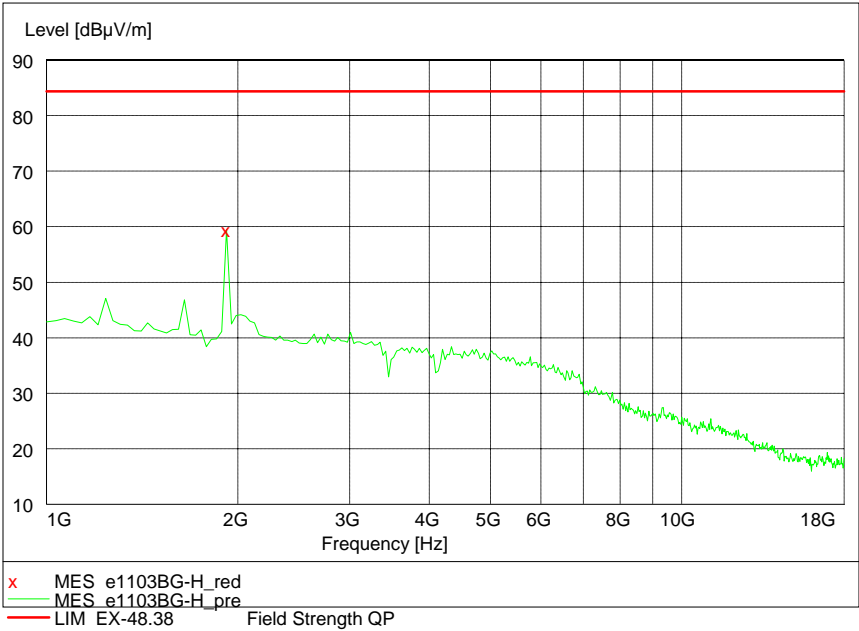

Note: Carrier: 1919.84MHz, 59.50dBµV/m

18000M-20000M:

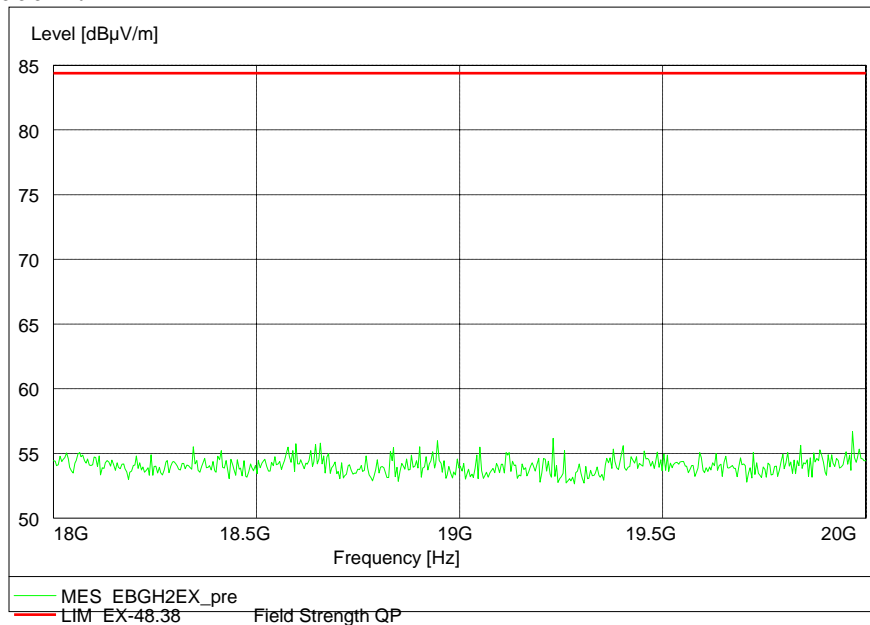

Configuration1: Mode 1 8PSK (margin>20dB)
30M-1000M:

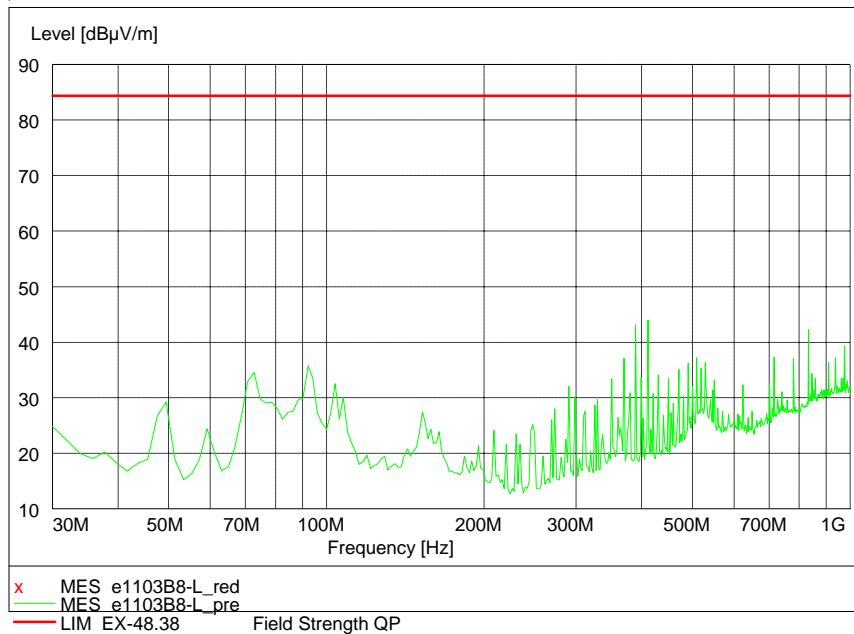

1000M-18000M:

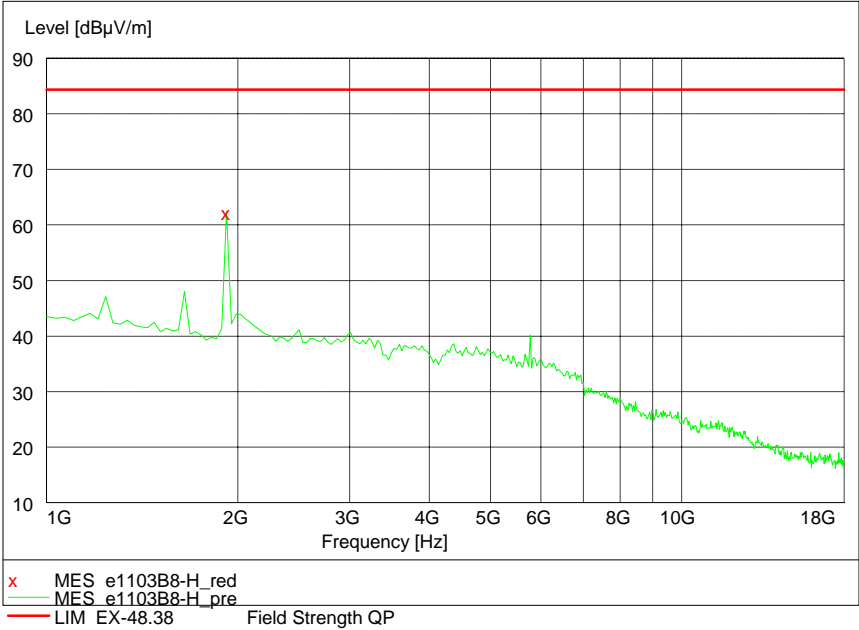

Note: Carrier: 1919.84MHz, 62.40dBµV/m

18000M-20000M:

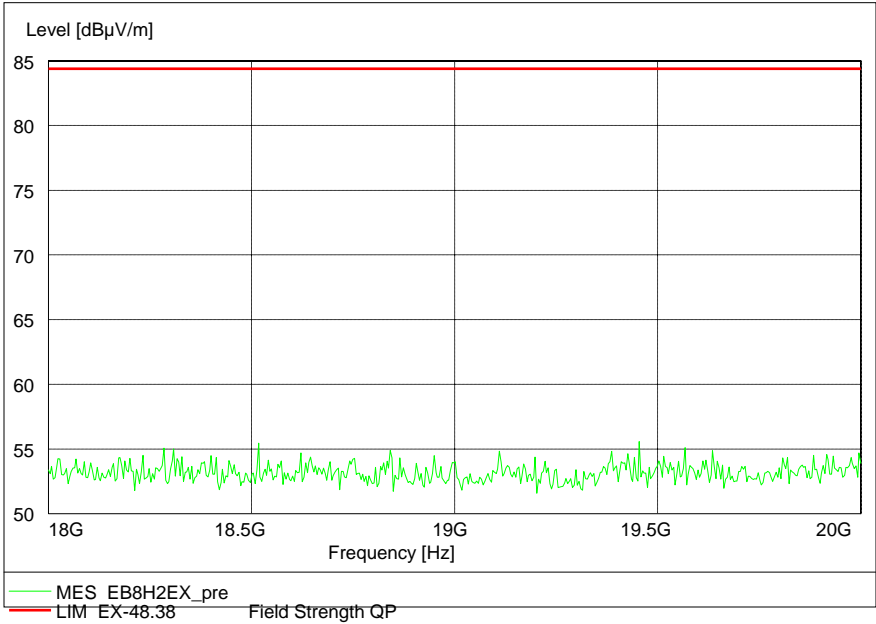

Configuration1: Mode 2 GMSK (margin>20dB)
30M-1000M:

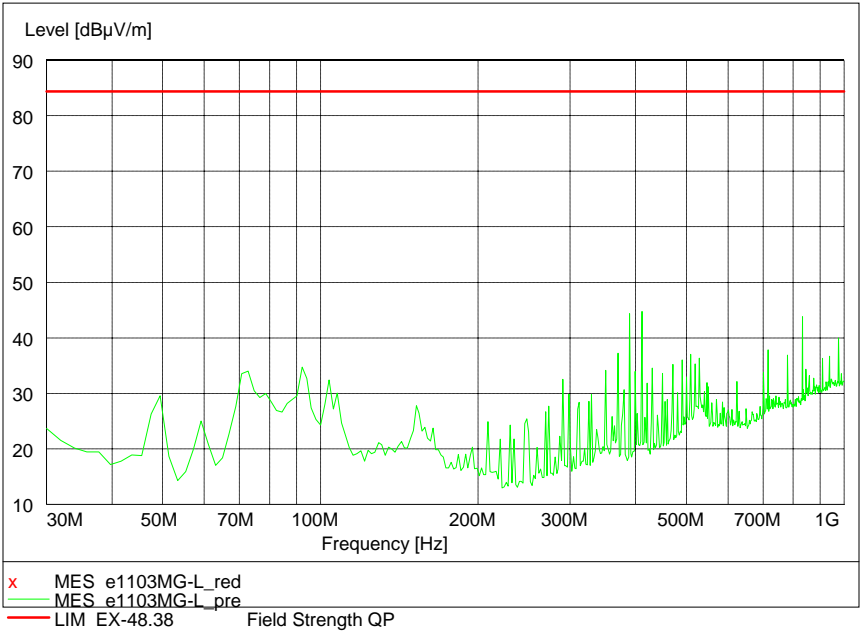

1000M-18000M:

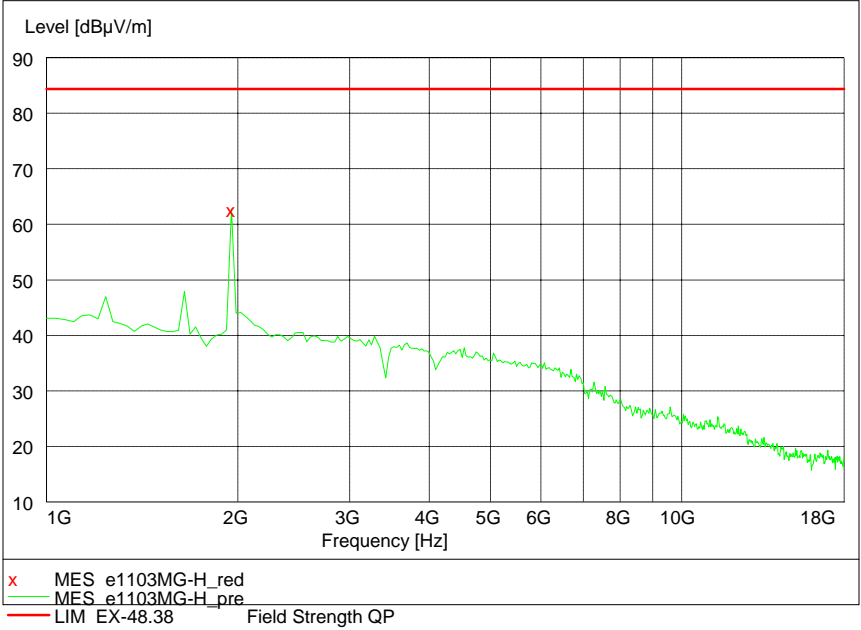

Note: Carrier: 1953.91MHz, 62.80dBµV/m

18000M-20000M:

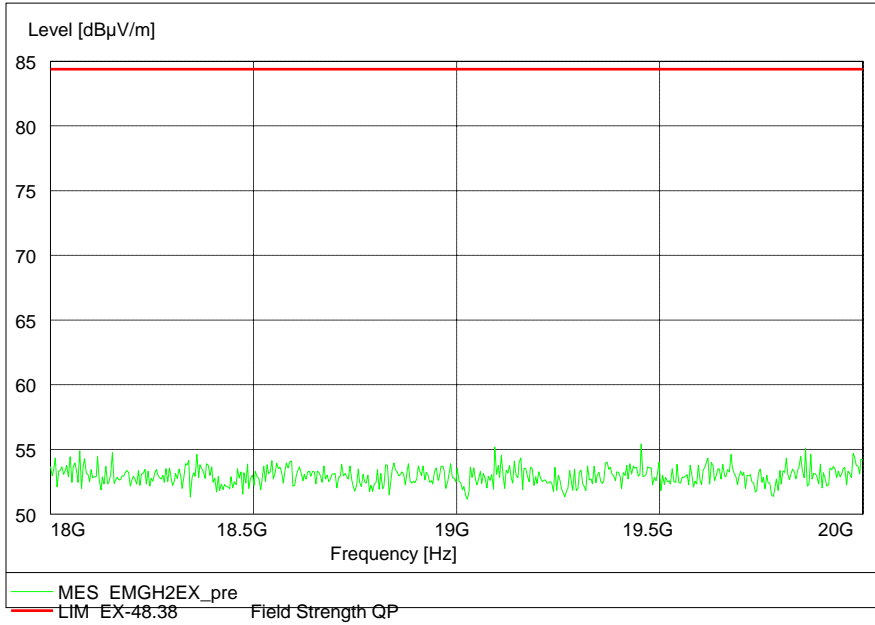

Configuration1: Mode 2 8PSK (margin>20dB)
30M-1000M:

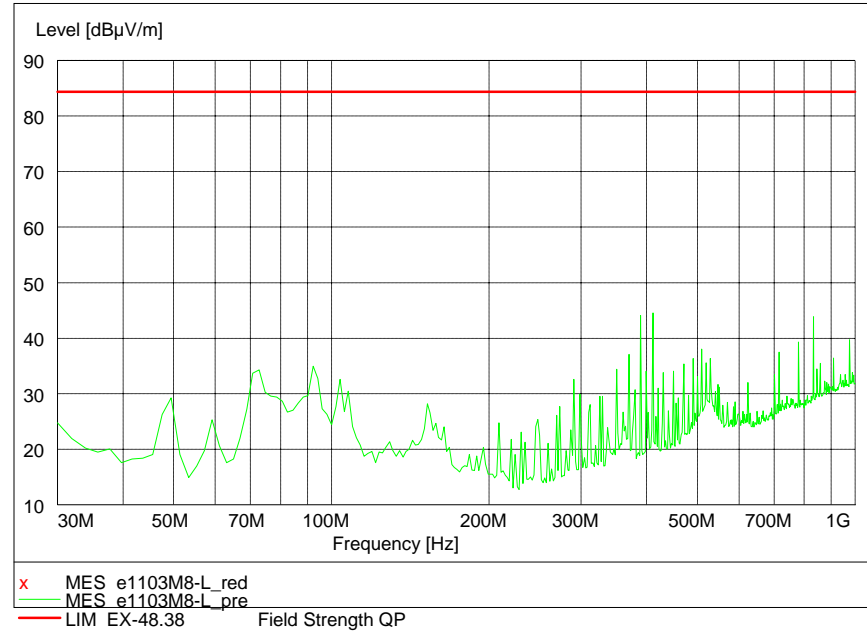

1000M-18000M:

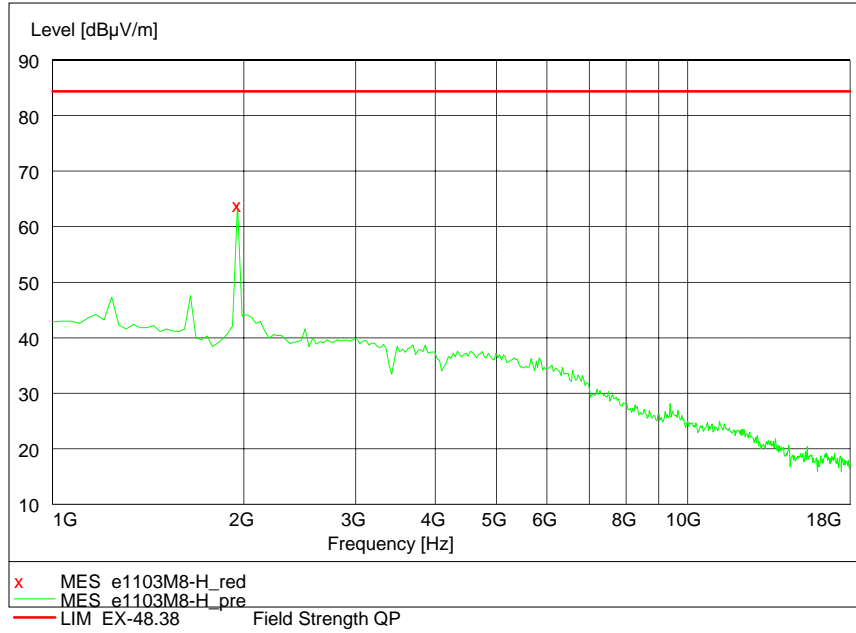

Note: Carrier: 1953.91MHz, 64.00dBµV/m

18000M-20000M:

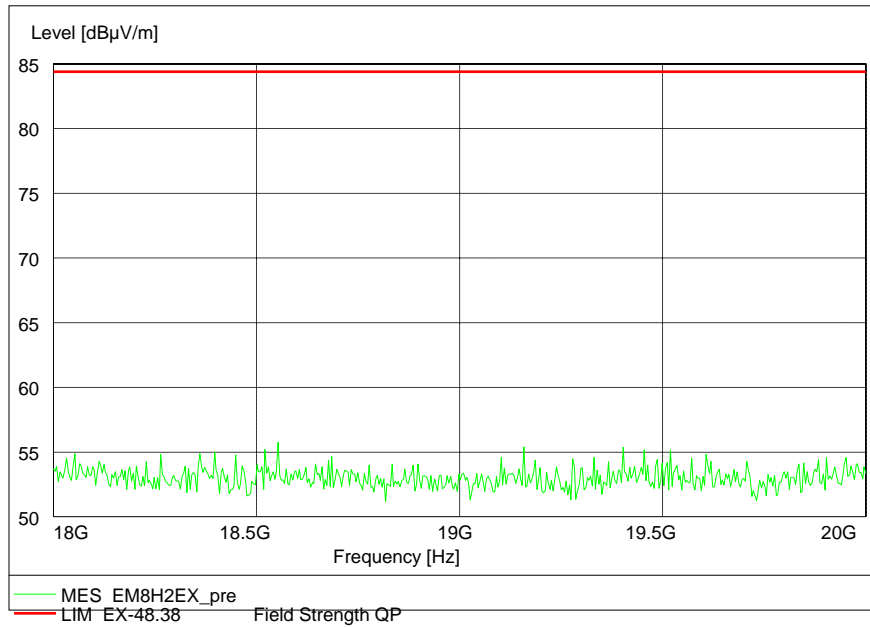

Configuration1: Mode 3 GMSK (margin>20dB)
30M-1000M:

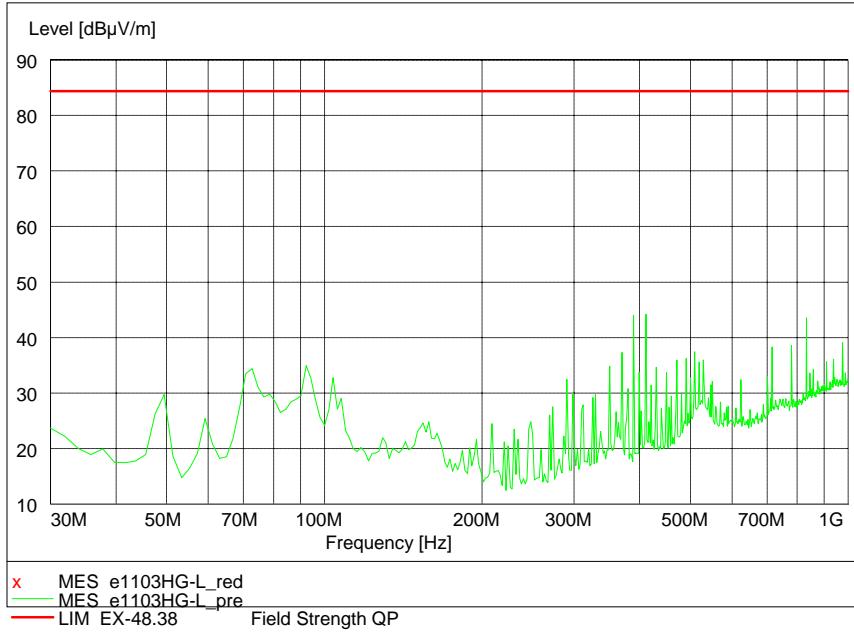

1000M-18000M:

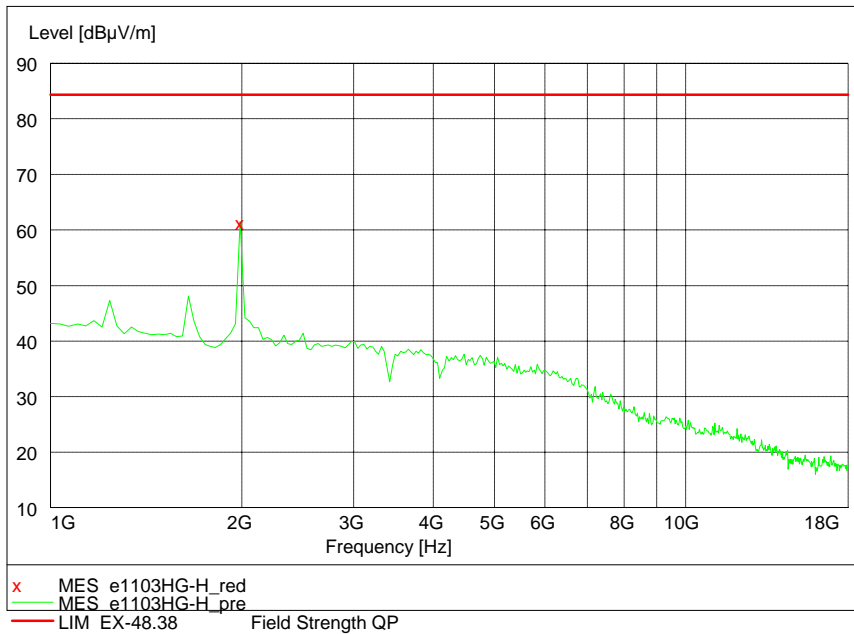

Note: Carrier: 1987.98MHz, 61.50dBµV/m

18000M-20000M:

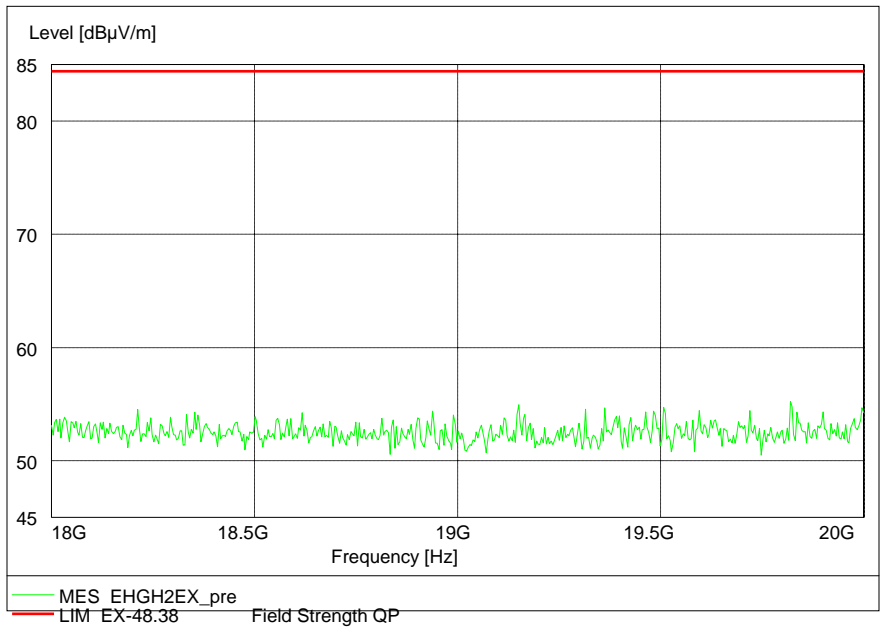

Configuration1: Mode 3 8PSK (margin>20dB)

30M-1000M:

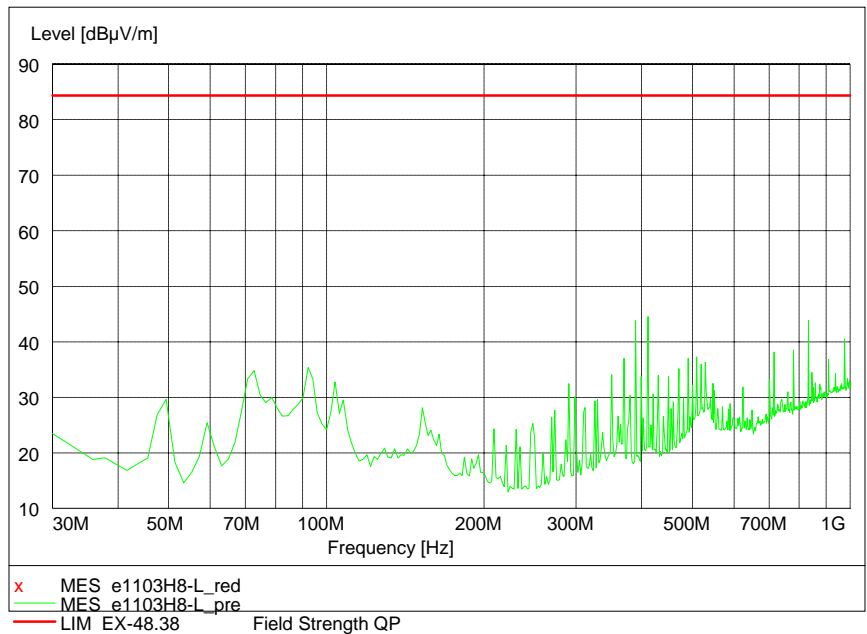

1000M-18000M:

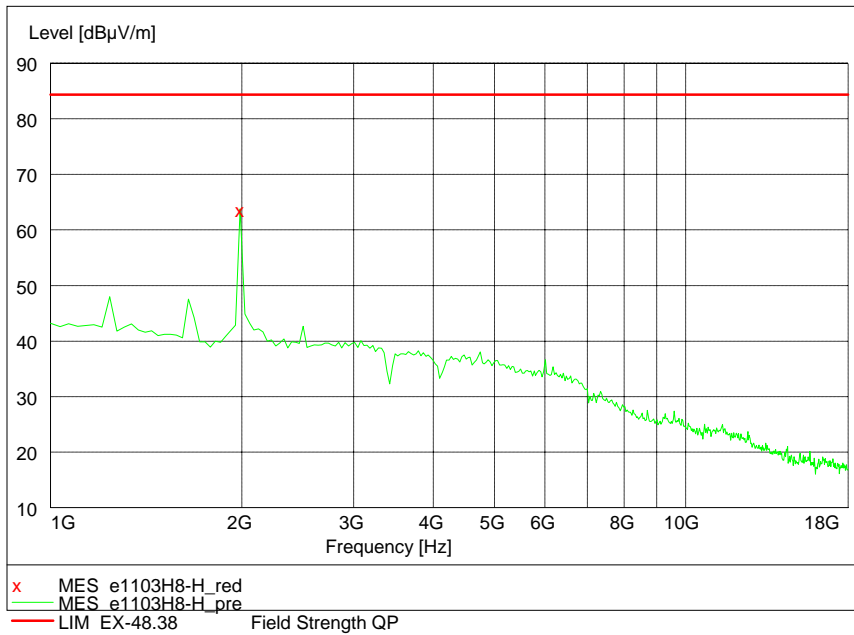

Note: Carrier: 1987.98MHz, 63.80dBµV/m

18000M-20000M:

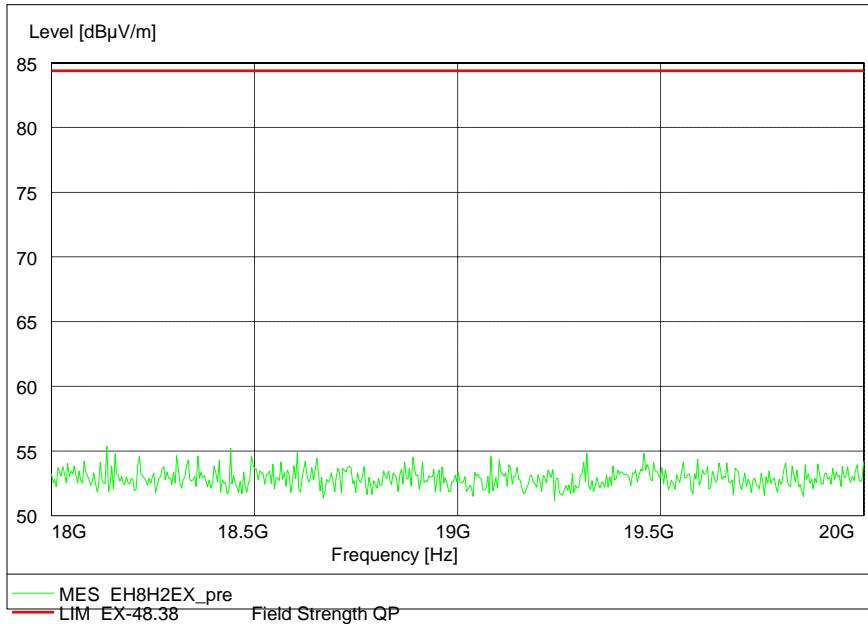

Configuration 2: Mode 4 GMSK
30M-1000M:

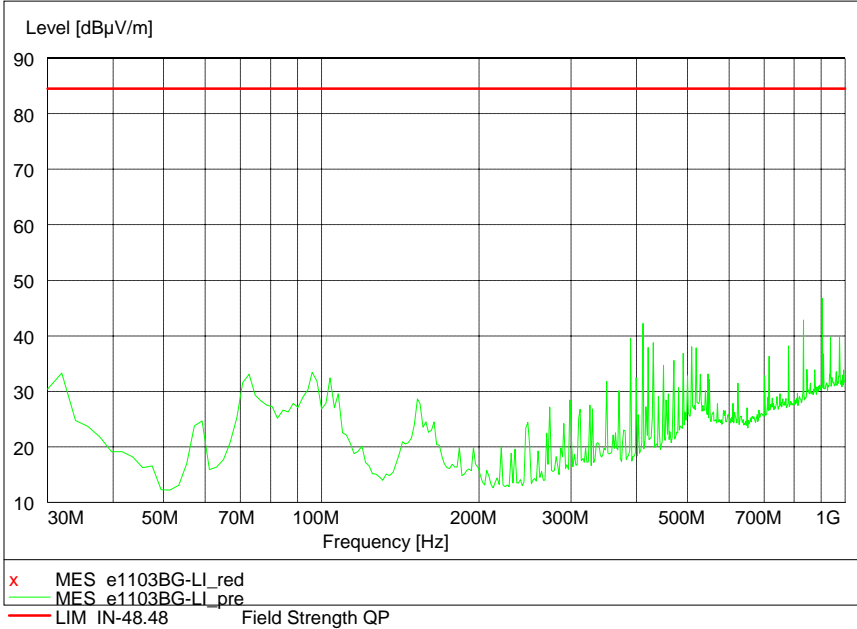

Note: Margin>20dB

1000M-18000M:

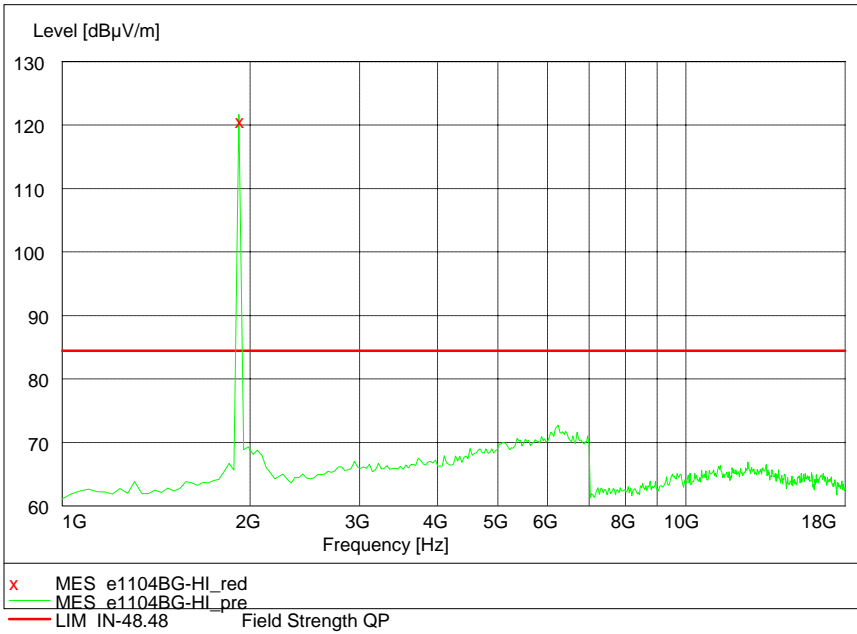

Note: 1. Carrier: 1930.21MHz, 19.41dBm
2. Margin>10dB

18000M-20000M:

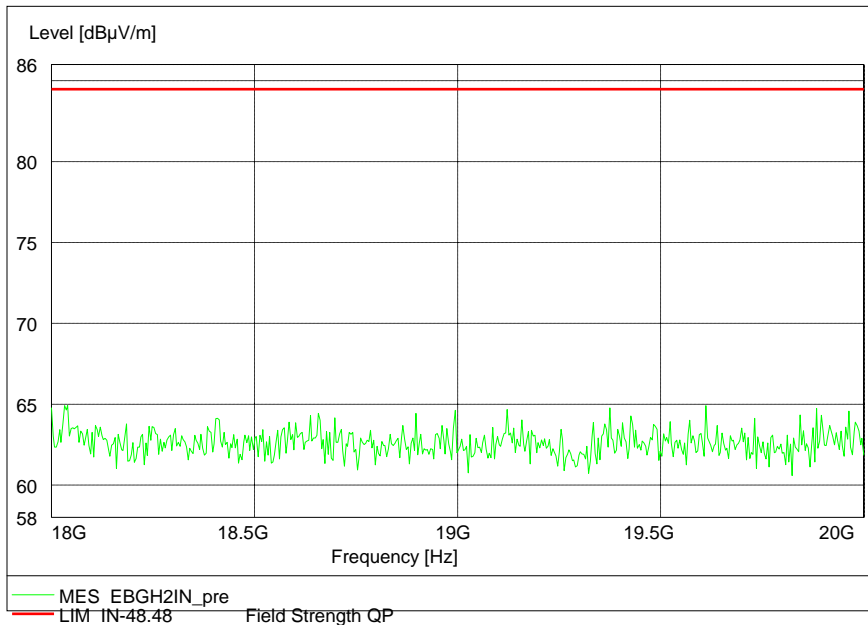

Configuration 2: Mode 4 8PSK

30M-1000M:

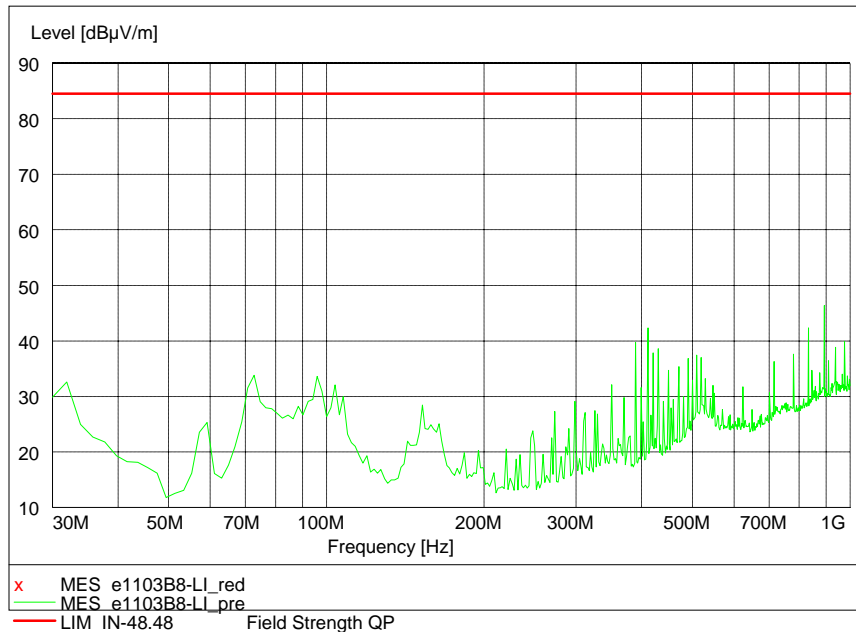

Note: Margin > 20dB

1000M-18000M:

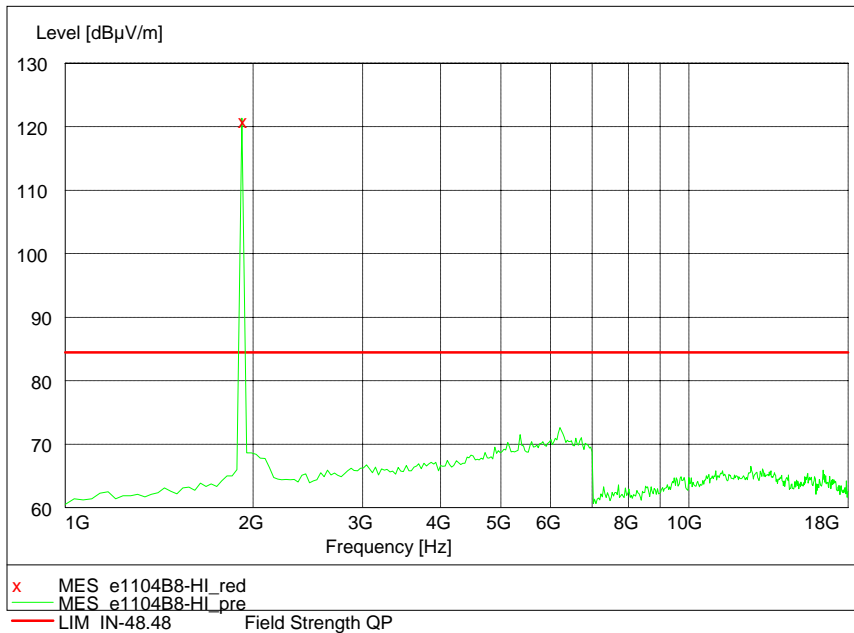

Note: 1. Carrier: 1930.15MHz, 20.79dBm
2. Margin>10dB

18000M-20000M:

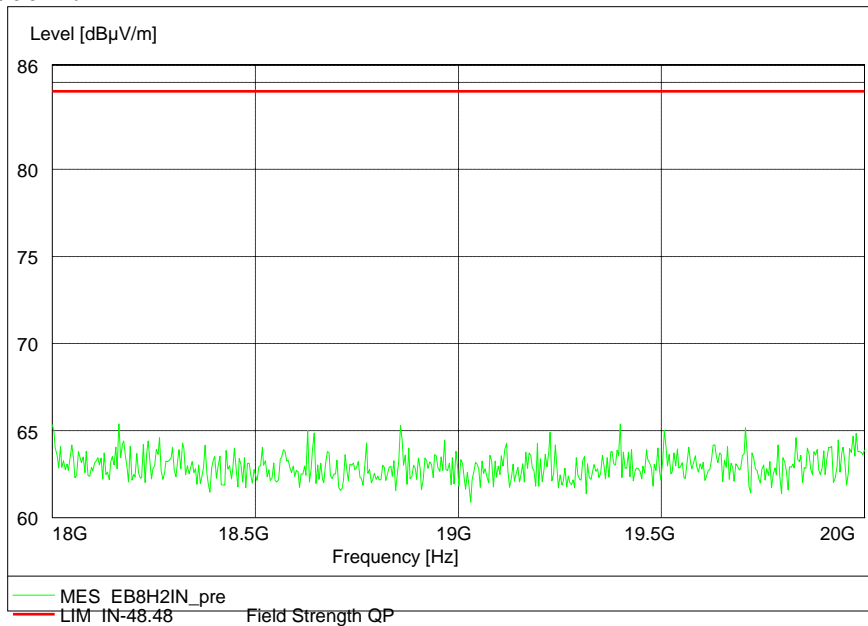

:

Configuration 2: Mode 5 GMSK
30M-1000M:

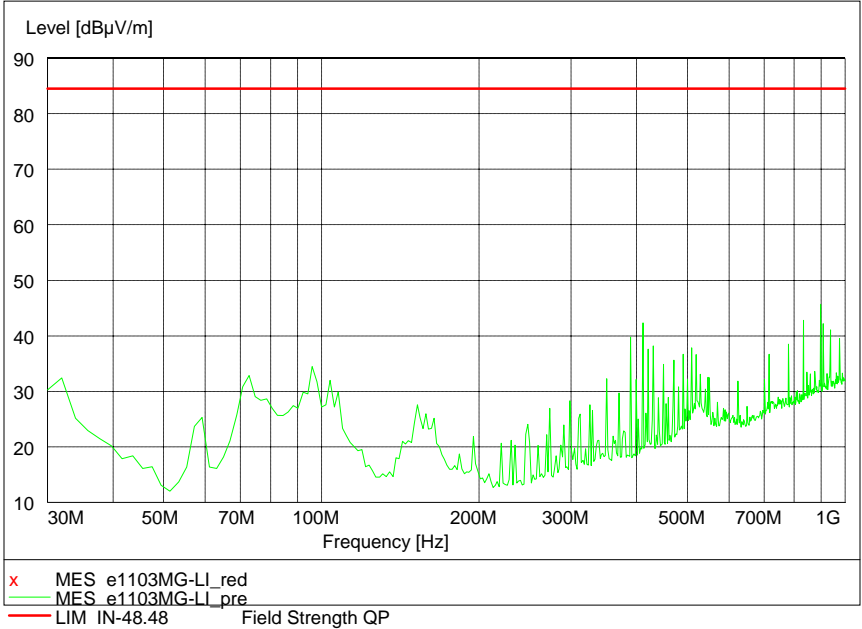

1000M-18000M:

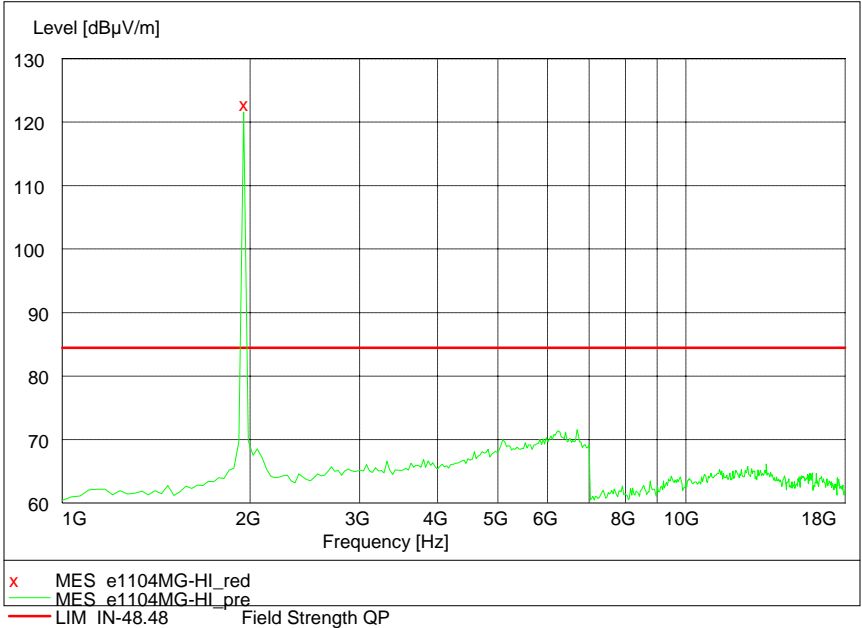

Note: 1. Carrier: 1960.05MHz, 22.84dBm
2. Margin>10dB

18000M-20000M:

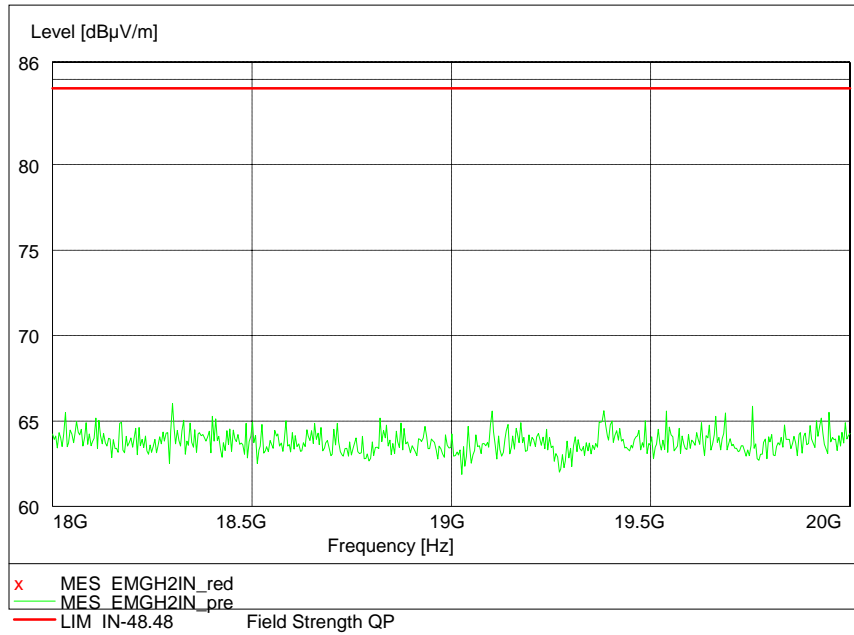

Configuration 2: Mode 5 8PSK
30M-1000M:

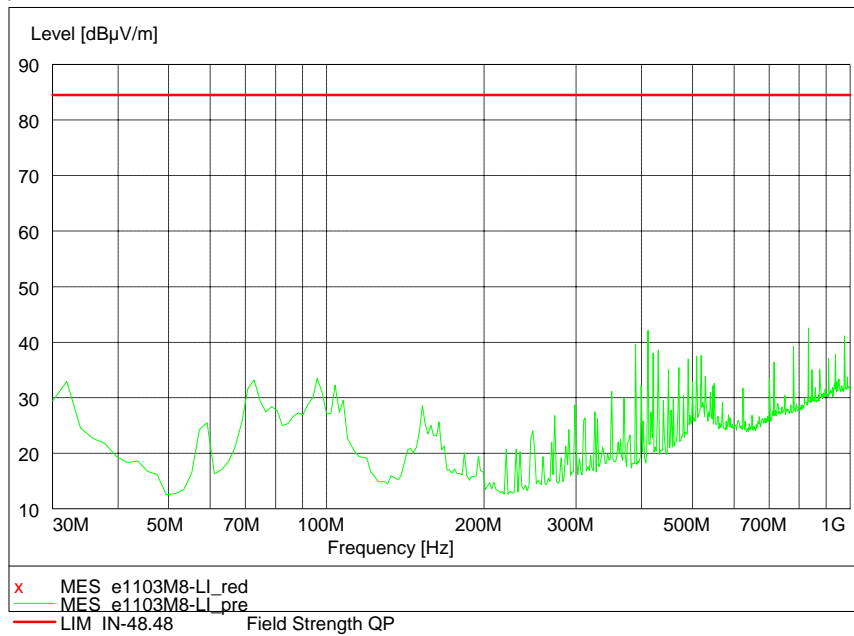

1000M-18000M:

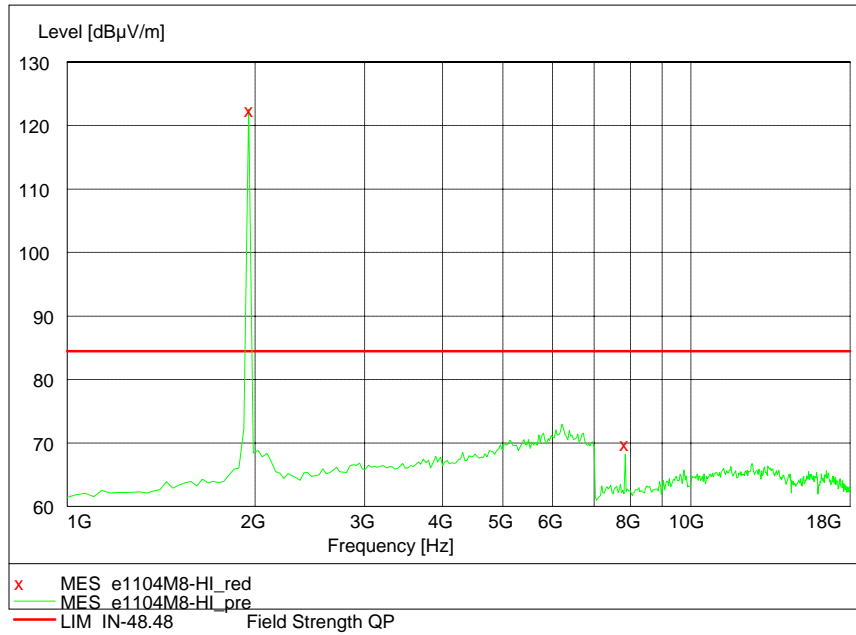

Note: 1. Carrier: 1960.03MHz, 21.57dBm Harmonic: 7840.03MHz, 70.05dBµV/m
2. Margin>10dB

18000M-20000M:

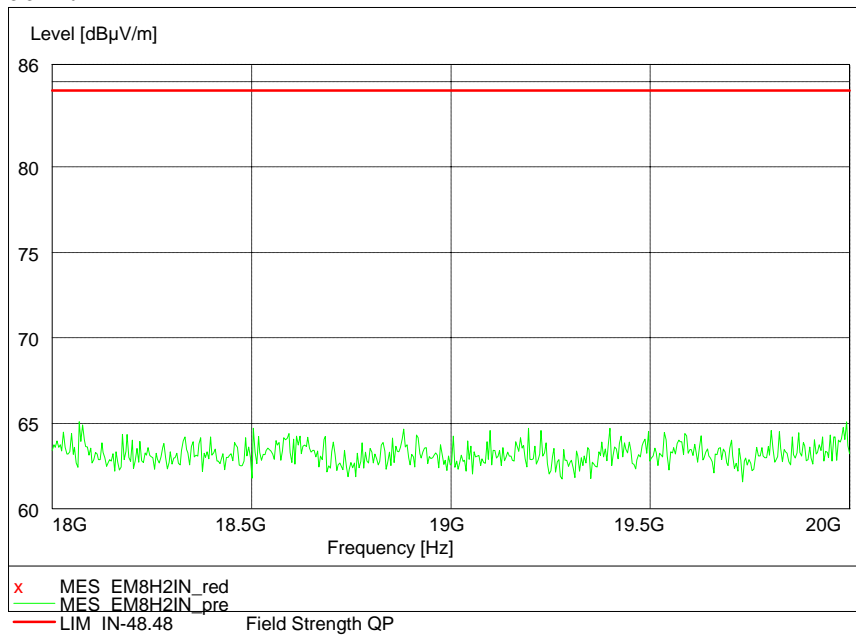

Configuration 2: Mode 6 GMSK
30M-1000M:

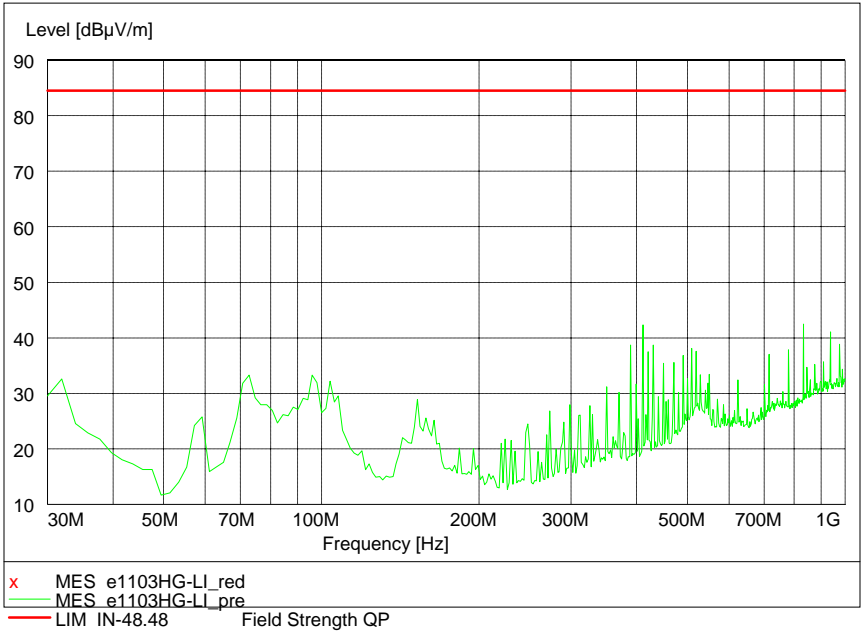

1000M-18000M:

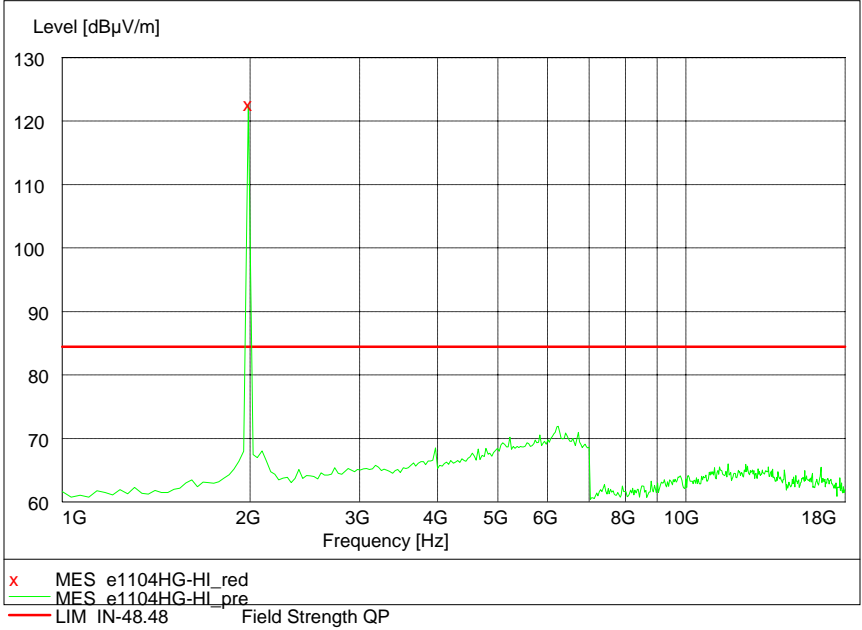

Note: 1. Carrier: 1989.80MHz, 22.59dBm
2. Margin > 10dB

18000M-20000M:

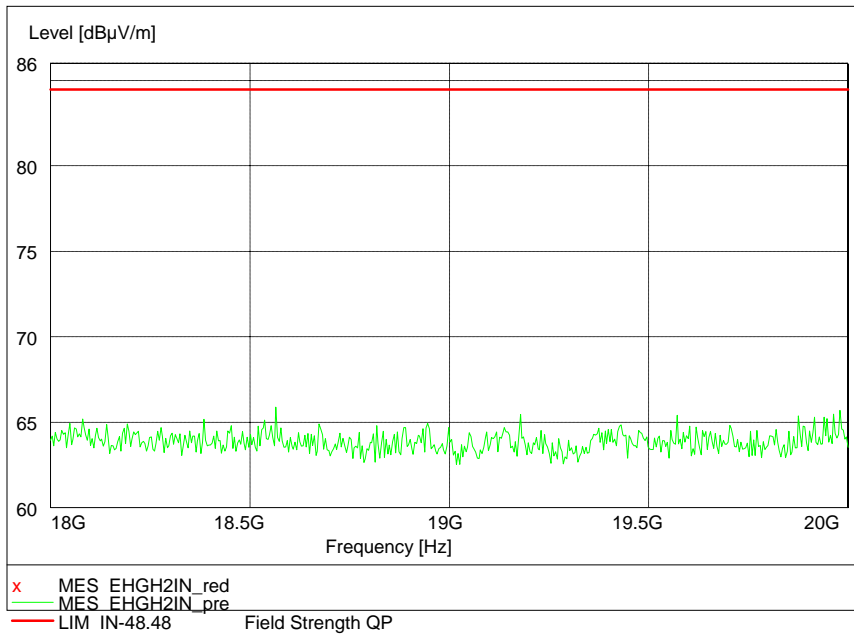

Configuration 2: Mode 6 8PSK

30M-1000M:

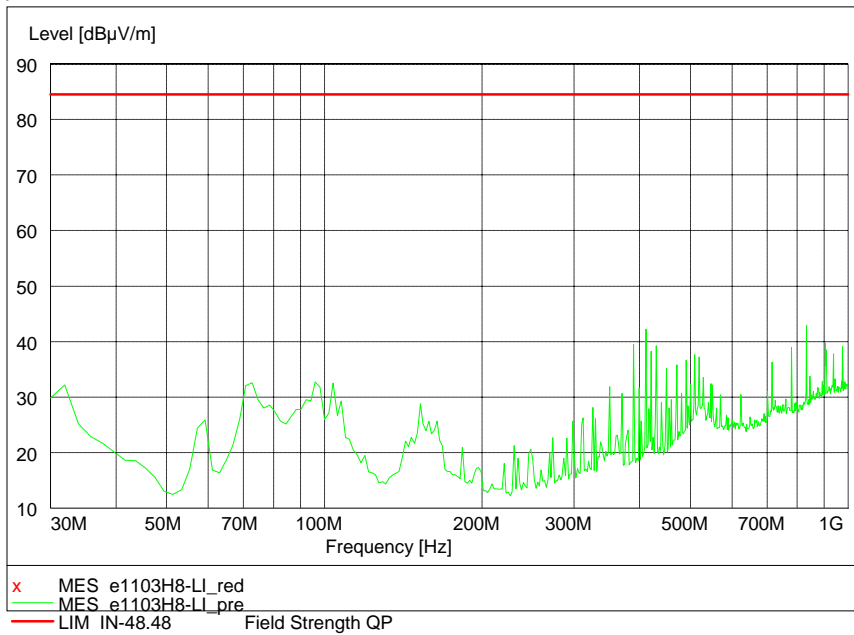

1000M-18000M:

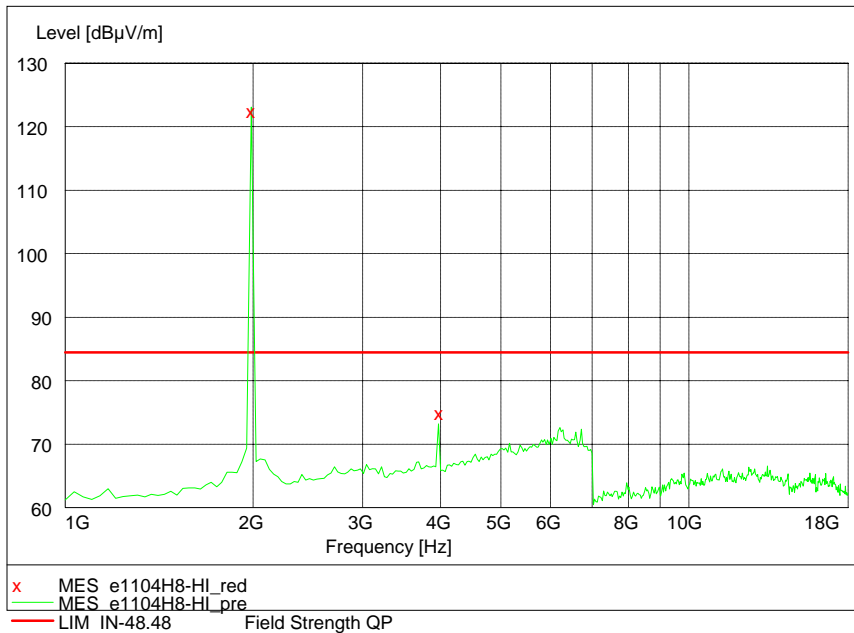

Note: 1. Carrier: 1989.81MHz, 26.35dBm Harmonic: 3979.62MHz, 75.09dBµ V/m
2. Margin>10dB

18000M-20000M:

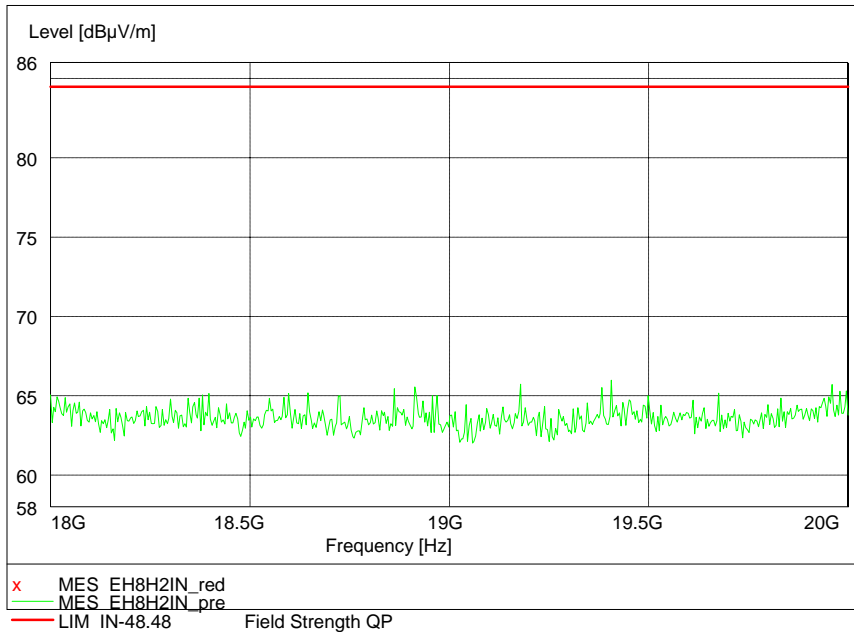

4.5 Measurement uncertainty

The measurement uncertainty describes the overall uncertainty of the given measured value during the operation of the EUT.

Measurement uncertainty is calculated in accordance with CISPR 16-4-2: 2003.

Measurement uncertainty of mains terminal disturbance voltage : ± 4.6 dB

The measurement uncertainty is given with a confidence of 95%, $k=2$.

4.6 Additions, Deviations and Exclusions from Standards

The carrier has not been controlled in this test.

Appendix I : Hardware list for EUT :

RBS 2409 HW list				
Product Name	Product No.	R-State	Serial No.	Date
BSU	KRC 161 175/3	R1A	CB47635658	20081014
PSU-AC-41	BML 151 124/1	R1B	C121001016	20070903
EBB-11	BMK 905 51/1	R1C	T511436873	20080307
SW Version: 08A_R18E				