



RF Test Report

Issued Date: Feb. 27, 2019

Applicant : RONDISH CO. LTD
 Product Type : CarePort
 Trade Name : Rondish
 Model Number : UNCG-31
 FCC ID : WNG-UNCG-31
 EUT Rated Voltage : DC 5 V, 2.5 A
 Test Voltage : 120 Vac / 60 Hz
 Receive Date : Jan. 23 , 2019
 Test Period : Jan. 28 ~ Jan. 29, 2019
 Applicable Standard : FCC 47 CFR PART 15 SUBPART C
 ANSI C63.10:2013
 Test Result : Complied

Testing Laboratory

A Test Lab Techno Corp.

101-104, 1F, A building, Safflower ridge industrial area,
 Taoyuan street, Nanshan district, Shenzhen
 Tel : +86-755-23987770 / Fax : +86-755-26637771
<http://www.atl-lab.com.tw/e-index.htm>



American Association for Laboratory Accreditation number: 3464.02

Note: This report shall not be reproduced except in full, without the written approval of A Test Lab Techno Corp. This document may be altered or revised by A Test Lab Techno Corp. personnel only and shall be noted in the revision section of the document. The client should not use it to claim product endorsement by A2LA, or any government agencies. The test results in the report only apply to the tested sample.

Approved By
 (Manager)

Hai Wang
 (Hai. Wang)

Reviewed By
 (Testing Engineer)

Mick Zhang
 (Mick Zhang)



Revision History

Rev.	Issue Date	Revisions
00	Feb. 27, 2019	Initial Issue



TABLE OF CONTENTS

1	General Information	4
2	EUT Description	6
3	Test Methodology	7
3.1.	Mode of Operation	7
3.2.	EUT Exercise Software	12
3.3.	Configuration of Test System Details	13
3.4.	Test Instruments	14
3.5.	Test Site Environment	15
4	Measurement Procedure	16
4.1.	AC Power Line Conducted Emission Measurement	16
4.2.	Radiated Emission Measurement	18
4.3.	Maximum Conducted Output Power Measurement	23
4.4.	6dB RF Bandwidth Measurement	24
4.5.	Maximum Power Spectral Density Measurement	25
4.6.	Out of Band Conducted Emissions Measurement	26
4.7.	Antenna Measurement	27
5	Test Results	28
	Annex A. Conducted Emission	28
	Annex B. Conducted Test Results	30
	Annex C. Radiated Emission Test Results	54



1 General Information

1.1 Summary of Test Result

Standard	Item	Result	Remark
15.247			
15.207	AC Power Conducted Emission	PASS	----
Standard	Item	Result	Remark
15.247			
15.247(d)	Transmitter Radiated Emissions	PASS	----
15.247(b)(3)	Max. Output Power	PASS	----
15.247(a)(2)	6dB RF Bandwidth	PASS	----
15.247(e)	Maximum Power Spectral Density	PASS	----
15.247(d)	Out of Band Conducted Spurious Emission	PASS	----
15.203	Antenna Requirement	PASS	----

Standard	Description
CFR47, Part 15, Subpart C §15.247	Intentional Radiators
ANSI C63. 10: 2013	American National Standard of Procedures for Compliance Testing of Unlicensed Wireless Devices
ANSI C63. 4: 2014	American National Standard for methods of measurement of radio – noise emissions from low-voltage electrical and electronic equipment in the range of 9 kHz to 40 GHz
KDB558074 D01 v05	GUIDANCE FOR COMPLIANCE MEASUREMENTS ON DIGITAL TRANSMISSION SYSTEM, FREQUENCY HOPPING SPREAD SPECTRUM SYSTEM, AND HYBRID SYSTEM DEVICES OPERATING UNDER SECTION 15.247 OF THE FCC RULES

The test results of this report relate only to the tested sample(s) identified in this report. Manufacturer or whom it may concern should recognize the pass or fail of the test result.



A Test Lab Techno Corp. tested the above equipment under the requirements outlined in the above standards. All indications of Pass/Fail in this report are opinions expressed by A Test Lab Techno Corp. Based on interpretations and/or observations of test results. Measurement Uncertainties were not taken into account and are published for informational purposes only. The test results show that the equipment tested is capable of demonstrating compliance with the requirements as documented in this report.

A Test Lab Techno Corp. will not be liable for any loss or damage resulting from false, inaccurate, inappropriate or incomplete product information provided by the customer.

This test report is electronically signed and valid without handwriting signature. For verification of the electronic signatures, the public keys can be requested at the testing laboratory.

1.2 Measurement Uncertainty

Test Item	Frequency Range	Uncertainty (dB)
Conducted Emission	9kHz ~ 150KHz	2.7
	150kHz ~ 30MHz	2.7
Radiated Emission	9kHz ~ 30MHz	1.7
	30MHz ~ 1000MHz	5.7
	1000MHz ~ 18000MHz	5.5
	18000MHz ~ 26500MHz	4.8
	26500MHz ~ 40000MHz	4.8
Conducted Output Power	+0.27 dB / -0.28 dB	
RF Bandwidth	4.96%	
Power Spectral Density	+0.71 dB / -0.77 dB	



2 EUT Description

Applicant	RONDISH CO. LTD UNIT G&H, 4/F, BLOCK 1, KWAI TAK IND.CTR, 15-33 KWAI TAK ST., KWAI CHUNG,N.T., HONG KONG, China			
Manufacturer	RONDISH CO. LTD UNIT G&H, 4/F, BLOCK 1, KWAI TAK IND.CTR, 15-33 KWAI TAK ST., KWAI CHUNG,N.T., HONG KONG, China			
Product Type	CarePort			
Trade Name	Rondish			
Model Number	UNCG-31			
FCC ID	WNG-UNCG-31			
Operate Freq. Band	Frequency Range (MHz)	Modulation	Channel Bandwidth	Data Rate 400 / 800 GI (ns)
IEEE 802.11b	2412 ~ 2462	DSSS	20MHz	Up to 11Mbps
IEEE 802.11g	2412 ~ 2462	OFDM	20MHz	Up to 54Mbps
IEEE 802.11n 2.4GHz 20MHz	2412 ~ 2462	OFDM	20MHz	Up to 72.2Mbps
IEEE 802.11n 2.4GHz 40MHz	2422 ~ 2452	OFDM	40MHz	Up to 150Mbps
Antenna information	Type		Max. Gain (dBi)	
	Omni Directional		1.95	
Antenna Delivery	See section 3.1			
Operate Temp. Range	0 ~ +45 °C			

Frequency Band	Max. RF Output Power (W)
IEEE 802.11b	0.018
IEEE 802.11g	0.044
IEEE 802.11n 2.4GHz 20MHz	0.037
IEEE 802.11n 2.4GHz 40MHz	0.024



3 Test Methodology

3.1. Mode of Operation

Decision of Test ATL has verified the construction and function in typical operation. All the test modes were carried out with the EUT in normal operation, which was shown in this test report and defined as:

Test Mode
Mode 1: Transmit mode
Mode 2: IEEE 802.11b Continuous TX mode
Mode 3: IEEE 802.11g Continuous TX mode
Mode 4: IEEE 802.11n 2.4GHz 20MHz Continuous TX mode
Mode 5: IEEE 802.11n 2.4GHz 40MHz Continuous TX mode

Software used to control the EUT for staying in continuous transmitting mode was programmed.

After verification, all tests were carried out with the worst case test modes as shown below except radiated spurious emission below 1GHz and power line conducted emissions below 30MHz, which worst case was in TX mode only.

By preliminary testing and verifying three axis (X, Y and Z) position of EUT transmitted status, it was found that "X axis" position was the worst, then the final test was executed the worst condition and test data were recorded in this report.

Test Mode	ANT-0
Mode 2	V
Mode 3	V
Mode 4	V
Mode 5	V

Test Mode	Antenna Delivery	Data Rate	Test Channel
Mode 2	1TX	1M	1, 6, 11
Mode 3	1TX	6M	1, 6, 11
Mode 4	1TX	6.5M	1, 6, 11
Mode 5	1TX	13.5M	3, 6, 9



Duty cycle

Test Mode	Frequency (MHz)	on time (ms)	on+off time (ms)	Duty cycle	Duty Factor (dB)	1/T Minimum VBW (kHz)
Mode 2	2412	31.280	31.280	1.000	0.000	0.010
Mode 3	2412	1.650	1.680	0.982	0.078	0.010
Mode 4	2412	1.540	1.560	0.987	0.056	0.010
Mode 5	2422	0.768	0.792	0.970	0.134	1.302

Duty Cycle Graphs

Mode 2: IEEE 802.11b Continuous TX mode

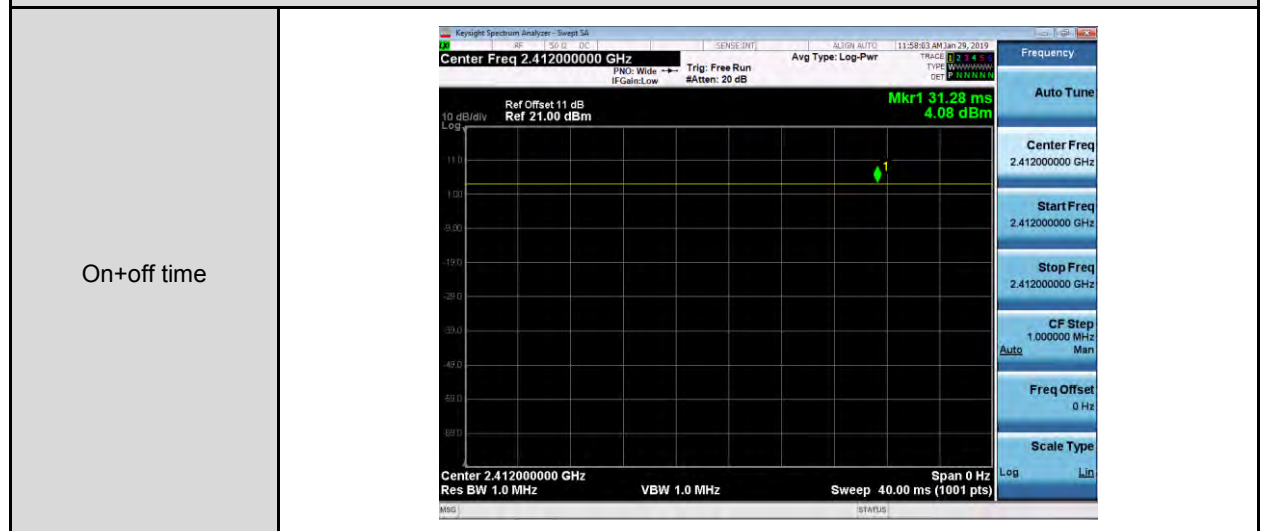



Mode 3: IEEE 802.11g Continuous TX mode

On time

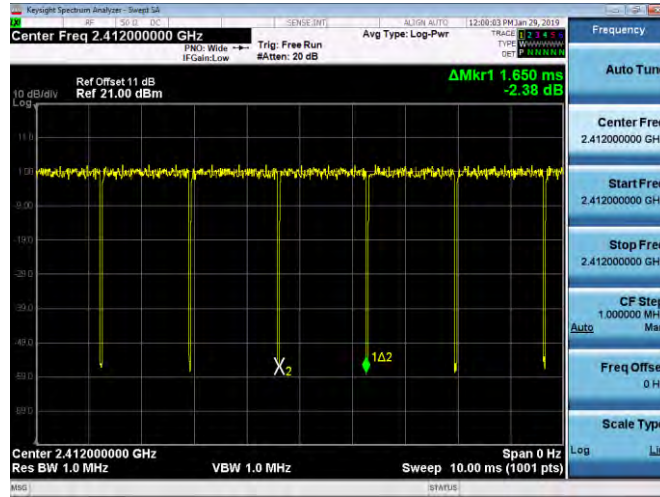

On+off time

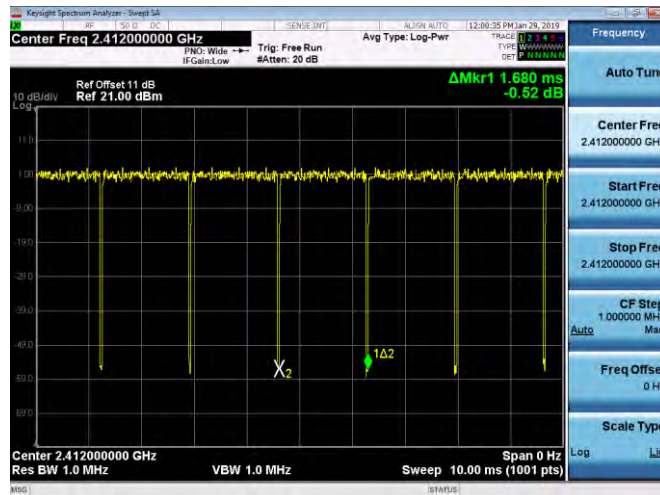



Mode 4: IEEE 802.11n 2.4GHz 20MHz Continuous TX mode

On time

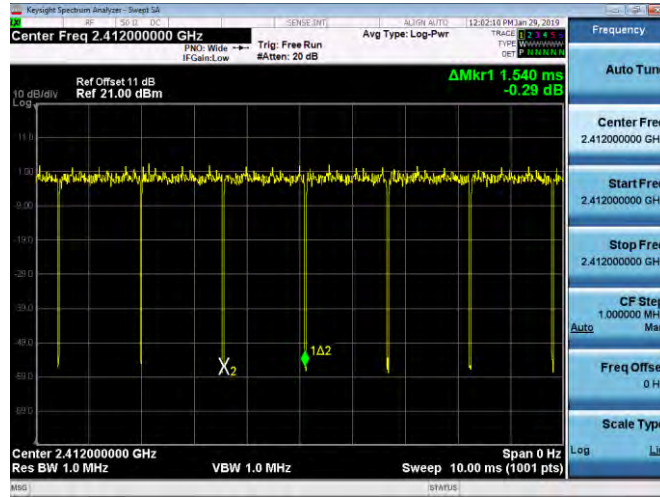

On+off time

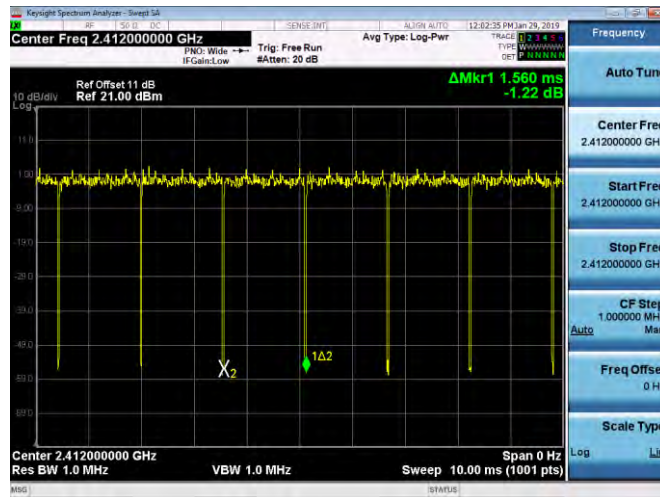



3.2. EUT Exercise Software

1.	Setup the EUT shown on "Configuration of Test System Details".
2.	Turn on the power of all equipment.
3.	Turn on TX function
4.	EUT run test program.

Measurement Software	
1	EZ-EMC Ver. ATL-03A1-1
2	EZ-EMC Ver ATL-ITC-3A1-1

3.3. Configuration of Test System Details

Conducted Emissions

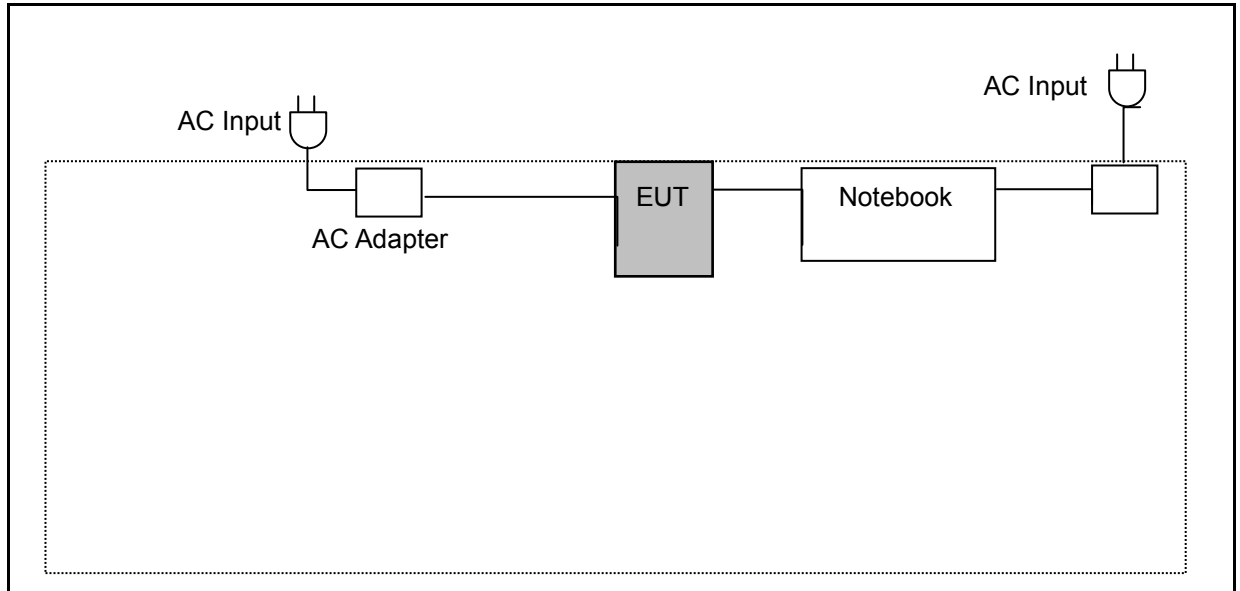

Radiated Emission

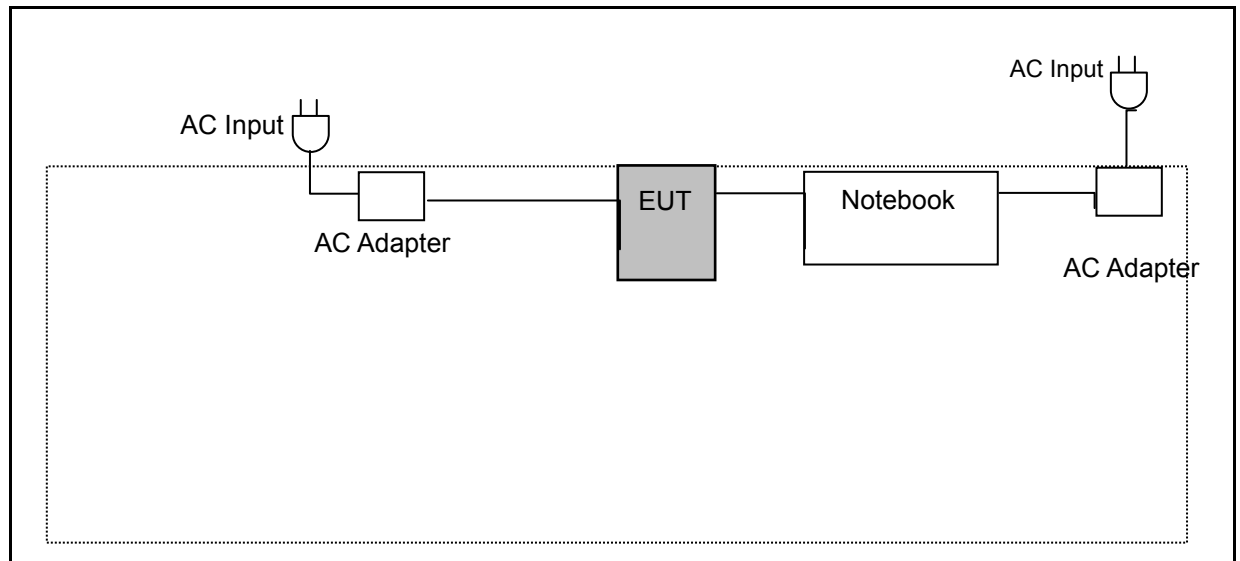

Devices Description					
	Product	Manufacturer	Model Number	Serial Number	Power Cord
(1)	Notebook	Lenovo	LENOVO B490	WB12542618	Non-Shielded, 0.8 m
(2)	AC Adapter	Chicony	ADLX90NCT3A	---	INPUT : AC 100 V to 240 V , 50 Hz / 60 Hz, 0.3 A OUTPUT : DC 20 V , 4.5 A



3.4. Test Instruments

For Conducted Emission

Test Period: Jan. 29, 2019

Equipment	Manufacturer	Model Number	Serial Number	Cal. Date	Cal. Period
Power Sensor	Anritsu	U2021XA	SG54130003	09/18/2018	1 year
Power Sensor	Anritsu	U2021XA	SG54130004	09/18/2018	1 year
Spectrum Analyzer (10 Hz~26.5 GHz)	Agilent	N9020A	MY53420615	09/18/2018	1 year
Programmable temp & humi chamber	ETAI	9712A	647	09/18/2018	1 year
Test Site	ATL	RF	RF	N.C.R.	----

For Radiated Emissions

Test Period: Jan. 28, 2019

Equipment	Manufacturer	Model Number	Serial Number	Cal. Date	Cal. Period
Preamplifier (10 kHz~3 GHz)	EMCI	EMC001330	980300	09/18/2018	1 year
Preamplifier (0.1 GHz~26.5 GHz)	EMCI	EMC012645SE	980318	09/18/2018	1 year
Bilog Antenna (30 MHz~1.4 GHz)	Schwarzbeck	VULB 9168	672	11/21/2018	1 year
Horn Antenna (1 GHz~18 GHz)	ETS	3117	00204949	11/16/2018	1 year
Horn Antenna (18 GHz~26.5 GHz)	ETS	3160-09	00202549	11/16/2018	1 year
Receiver (3 Hz~26.5 GHz)	Keysight	N9038A	MY51210179	09/18/2018	1 year
Spectrum Analyzer (3 Hz~43 GHz)	Keysight	N9030A	MY55410268	09/18/2018	1 year
Cable (9 kHz~1 GHz)	EMCI	N/A	1066LFC	09/18/2018	1 year
Cable (1 GHz~18 GHz)	EMCI	N/A	160719	09/18/2018	1 year
Cable (1 GHz~18 GHz)	EMCI	N/A	160324	09/18/2018	1 year
Cable (1 GHz~18 GHz)	EMCI	N/A	160322	09/18/2018	1 year
Loop Antenna	EMCI	LPA600	272	02/07/2018	1 year
Test Site	OuHeng	MFAC3M	RE-026	03/15/2018	1 year

Note: N.C.R. = No Calibration Request.



3.5. Test Site Environment

Items	Required (IEC 60068-1)	Actual
Temperature (°C)	15-35	26
Humidity (%RH)	25-75	60
Barometric pressure (mbar)	860-1060	950

4 Measurement Procedure

4.1. AC Power Line Conducted Emission Measurement

■ Limit

Frequency (MHz)	Quasi-peak	Average
0.15 - 0.5	66 to 56	56 to 46
0.50 - 5.0	56	46
5.0 - 30.0	60	50

■ Test Setup

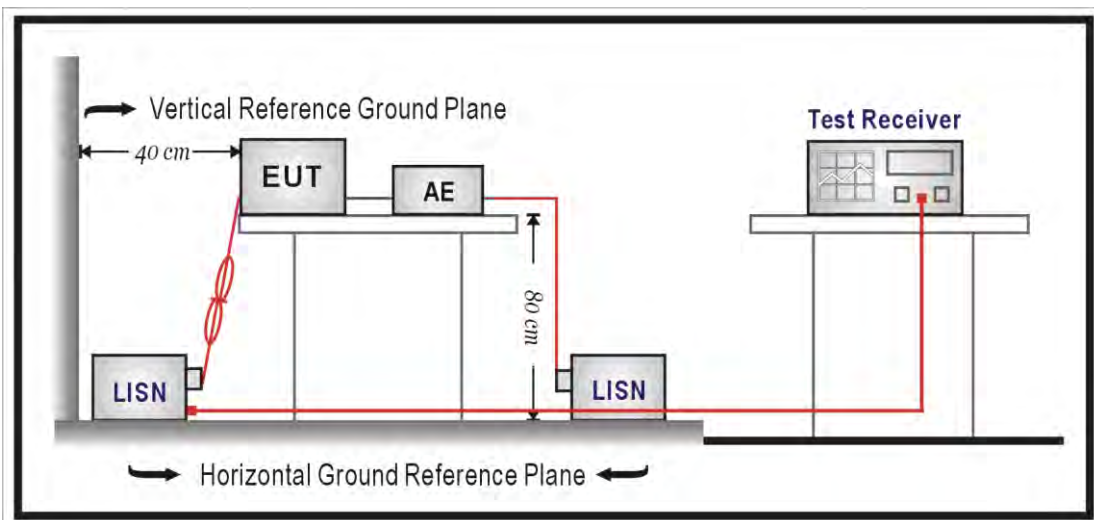

■ Test Procedure

The EUT and simulators are connected to the main power through a line impedance stabilization network (L.I.S.N.). This provides a $50\Omega//50\mu\text{H}$ coupling impedance for the measuring equipment. The peripheral devices are also connected to the main power through a LISN that provides a $50\Omega//50\mu\text{H}$ coupling impedance with 50ohm termination.

Tabletop device shall be placed on a non-conducting platform, of nominal size 1 m by 1.5 m, raised 80 cm above the reference ground plane. The wall of screened room shall be located 40cm to the rear of the EUT. Other surfaces of tabletop or floor standing EUT shall be at least 80cm from any other ground conducting surface including one or more LISNs. For floor-standing device shall be placed under the EUT with a 12mm insulating material.

Conducted emissions were investigated over the frequency range from 0.15 MHz to 30 MHz using a resolution bandwidth of 9 kHz. The equipment under test (EUT) shall be meet the limits in section 4.1, as applicable, including the average limit and the quasi-peak limit when using respectively, an average detector and quasi-peak detector measured in accordance with the methods described of related standard. When all of peak value were complied with quasi-peak and average limit from 150kHz to 30MHz then quasi-peak and average measurement was unnecessary.

The AMN shall be placed 0,8 m from the boundary of the unit under test and bonded to a ground reference plane for AMNs mounted on top of the ground reference plane. This distance is between the closest points of the AMN and the EUT. All other units of the EUT and associated equipment shall be at least 0,8 m from the AMN. If the mains power cable is longer than 1m then the cable shall be folded back and forth at the centre of the lead to form a bundle no longer than 0.4m. All of interconnecting cables that hang closer than 40cm to the ground plane shall be folded back and forth in the center forming a bundle 30 cm to 40 cm long. All of EUT and AE shall be separate place more than 0.1m. All 50Ω ports of the LISN shall be resistively terminated into 50Ω loads when not connected to the measuring instrument.

If the reading of the measuring receiver shows fluctuations close to the limit, the reading shall be observed for at least 15 s at each measurement frequency; the higher reading shall be recorded with the exception of any brief isolated high reading which shall be ignored.



4.2. Radiated Emission Measurement

■ Limit

According to §15.209(a), except as provided elsewhere in this subpart, the emissions from an intentional radiator shall not exceed the field strength levels specified in the following table:

Frequency (MHz)	Field Strength ($\mu\text{V}/\text{m}$ at meter)	Measurement Distance (meters)
0.009 – 0.490	2400 / F (kHz)	300
0.490 – 1.705	24000 / F (kHz)	30
1.705 – 30.0	30	30
30 - 88	100**	3
88-216	150**	3
216-960	200**	3
Above 960	500	3

** Except as provided in paragraph (g), fundamental emissions from intentional radiators operating under this Section shall not be located in the frequency bands 54-72 MHz, 76-88 MHz, 174-216 MHz or 470-806 MHz. However, operation within these frequency bands is permitted under other sections of this Part, e.g., Sections 15.231 and 15.241.

■ Setup

9kHz ~ 30MHz

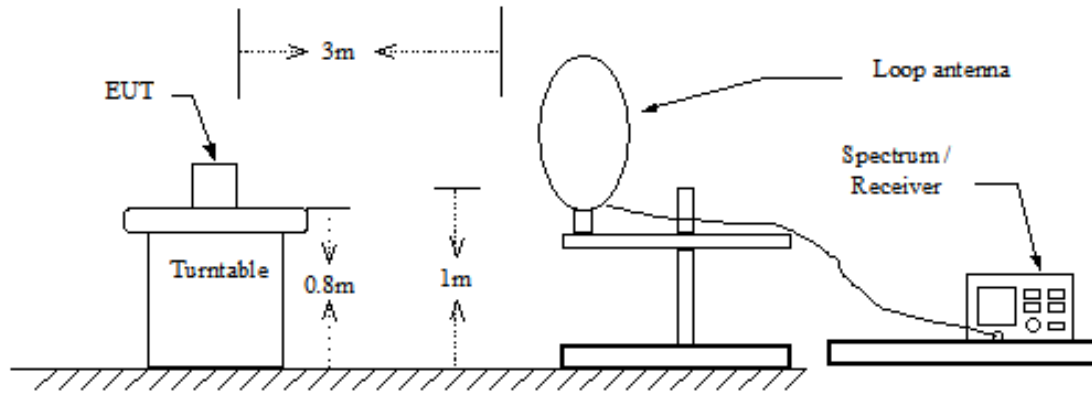

Below 1GHz

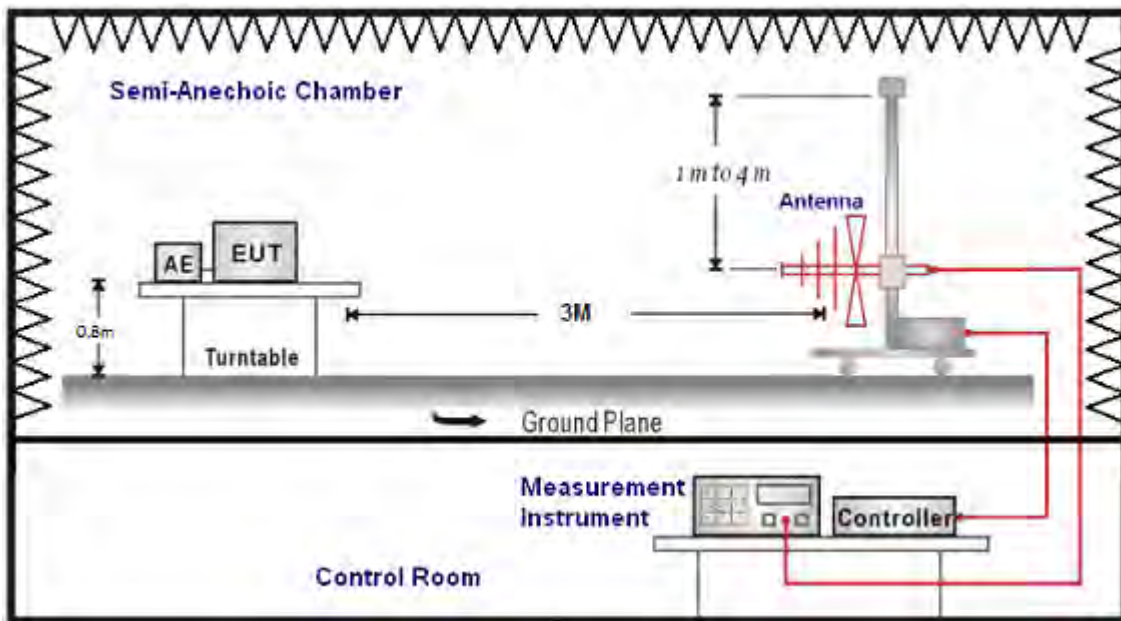

Above 1GHz

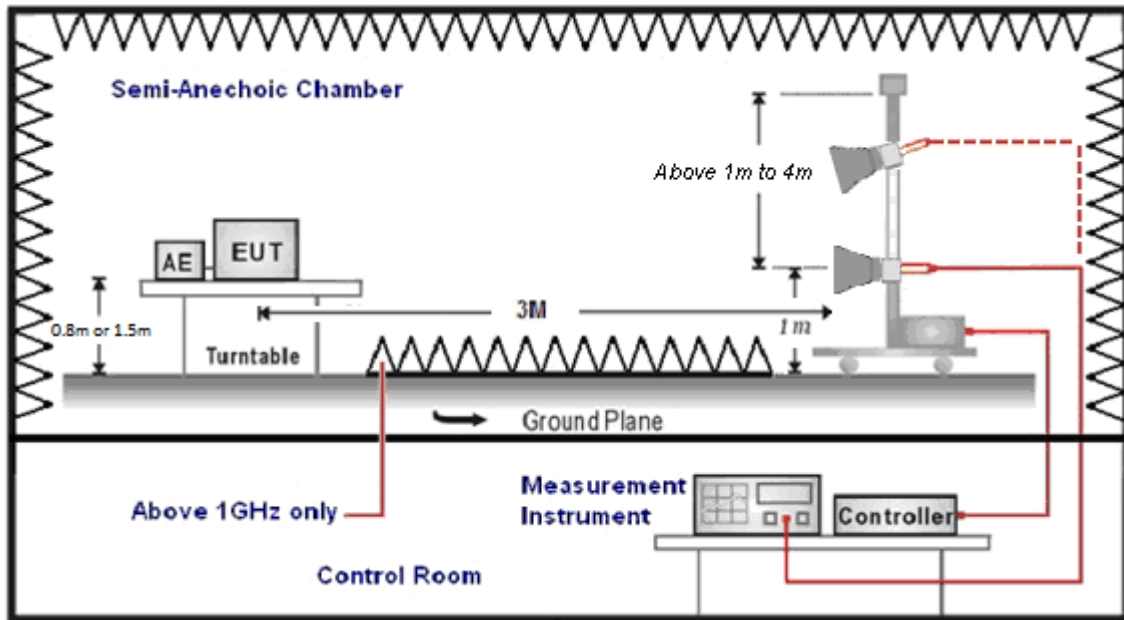



■ **Test Procedure**

Final radiation measurements were made on a three-meter, Semi Anechoic Chamber. The EUT system was placed on a nonconductive turntable which is 0.8 or 1.5 meters height, top surface 1.0 x 1.5 meter. The spectrum was examined from 250 MHz to 2.5 GHz in order to cover the whole spectrum below 10th harmonic which could generate from the EUT. During the test, EUT was set to transmit continuously & Measurements spectrum range from 9 kHz to 26.5 GHz is investigated.

For measurements below 1 GHz the resolution bandwidth is set to 100 kHz for peak detection measurements or 120 kHz for quasi-peak detection measurements. Peak detection is used unless otherwise noted as quasi-peak.

For measurements above 1 GHz the resolution bandwidth is set to 1 MHz, and then the video bandwidth is set to 1 MHz for peak measurements and 10 Hz for average measurements when Duty cycle >0.98 / 1/T for average measurements when Duty cycle <0.98. A nonconductive material surrounded the EUT to supporting the EUT for standing on three orthogonal planes. At each condition, the EUT was rotated 360 degrees, and the antenna was raised and lowered from one to four meters to find the maximum emission levels. Measurements were taken using both horizontal and vertical antenna polarization.

SCHWARZBECK MESS-ELEKTRONIK Biconilog Antenna at 3 Meter and the SCHWARZBECK Double Ridged Guide Antenna was used in frequencies 1 –26.5 GHz at a distance of 3 meter. The antenna at an angle toward the source of the emission. All test results were extrapolated to equivalent signal at 3 meters utilizing an inverse linear distance extrapolation Factor (20dB/decade).

For testing above 1GHz, the emission level of the EUT in peak mode was 20dB lower than average limit (that means the emission level in peak mode also complies with the limit in average mode), then testing will be stopped and peak values of EUT will be reported, otherwise, the emissions will be measured in average mode again and reported.

Appropriate preamplifiers were used for improving sensitivity and precautions were taken to avoid overloading or desensitizing the spectrum analyzer. No post – detector video filters were used in the test.

The spectrum analyzer's 6 dB bandwidth was set to 1 MHz, and the analyzer was operated in the peak detection mode, for frequencies both below and up 1 GHz. The average levels were obtained by subtracting the duty cycle correction factor from the peak readings.

The following procedures were used to convert the emission levels measured in decibels referenced to 1 microvolt (dBuV) into field intensity in micro volts pre meter (uV/m).

The actual field intensity in decibels referenced to 1 microvolt in to field intensity in micro volts per meter (dBuV/m).



The actual field intensity in referenced to 1 microvolt per meter (dBuV/m) is determined by algebraically adding the measured reading in dBuV, the antenna factor (dB), and cable loss (dB) and Subtracting the gain of preamplifier (dB) is auto calculate in spectrum analyzer.

(1) $\text{Amplitude (dBuV/m)} = \text{FI (dBuV)} + \text{AF (dBuV)} + \text{CL (dBuV)} - \text{Gain (dB)}$

FI= Reading of the field intensity.

AF= Antenna factor.

CL= Cable loss.

P.S Amplitude is auto calculate in spectrum analyzer.

(2) $\text{Actual Amplitude (dBuV/m)} = \text{Amplitude (dBuV)} - \text{Dis(dB)}$

The FCC specified emission limits were calculated according the EUT operating frequency and by following linear interpolation equations:

(a) For fundamental frequency : Transmitter Output < +30dBm

(b) For spurious frequency : Spurious emission limits = fundamental emission limit /10

Data of measurement within this frequency range without mark in the table above means the reading of emissions are attenuated more than 20dB below the permissible limits or the field strength is too small to be measured.

4.3. Maximum Conducted Output Power Measurement

■ Limit

For systems using digital modulation in the 2400-2483.5MHz, the limit for maximum output power is 30dBm.

And According to 15.247 (b), if transmitting antennas of directional gain greater than 6 dBi are used, the power shall be reduced by the amount in dB that the directional gain of the antenna exceeds 6dBi.

■ Test Setup

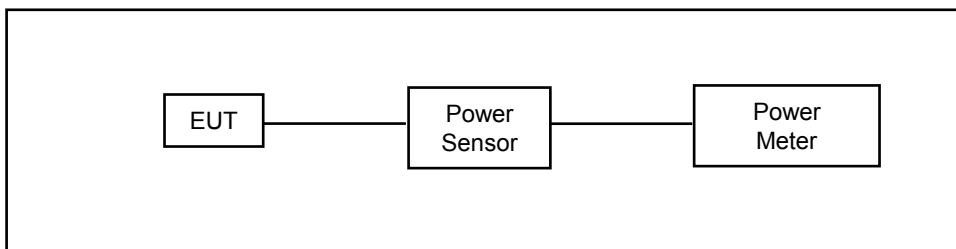

■ Test Procedure

The testing follows the Measurement Procedure of ANSI C63.10-2013 section 11.9.2.3 Method AVGPM.

The tests below are run with the EUT's transmitter set at high power in TX mode. The EUT is needed to force selection of output power level and channel number. While testing, EUT was set to transmit continuously. Remove the Subjective device's antenna and connect the RF output port to power sensor.

4.4. 6dB RF Bandwidth Measurement

■ Limit

6dB RF Bandwidth: Systems using digital modulation techniques may operate in the 2400–2483.5 MHz bands. The minimum 6 dB band-width shall be at least 500 kHz.

■ Test Setup

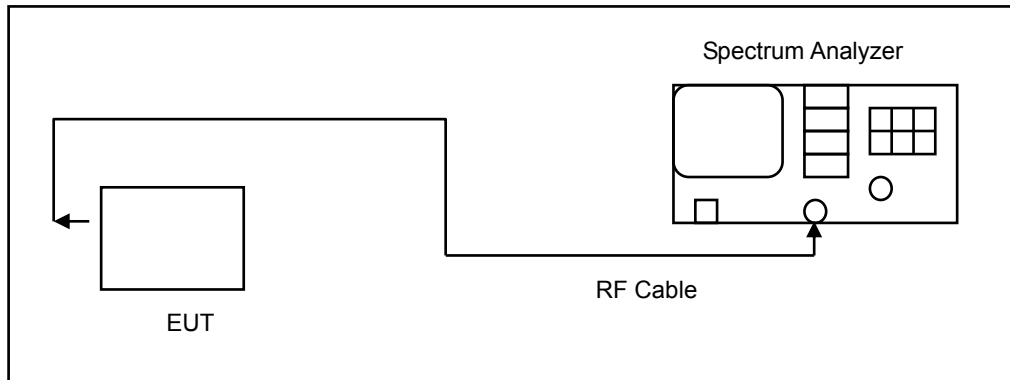

■ Test Procedure

The EUT tested to DTS test procedure of KDB 558074 D01 for compliance to FCC 47CFR 15.247 requirements.

6dB RF Bandwidth: The antenna port of the EUT was connected to the input of a spectrum analyzer. Analyzer RBW was set to 100 kHz. For each RF output channel investigated, the spectrum analyzer center frequency was set to the channel carrier. A peak output reading was taken, a DISPLAY line was drawn 6 dB lower than peak level. The 6 dB bandwidth was determined from where the channel output spectrum intersected the display line.

The test was performed at 3 channels (Channel low, middle, high)

4.5. Maximum Power Spectral Density Measurement

■ Limit

For digitally modulated systems, the power spectral density conducted from the intentional radiator to the antenna shall not be greater than 8 dBm in any 3 kHz band during any time interval of continuous transmission.

■ Test Setup

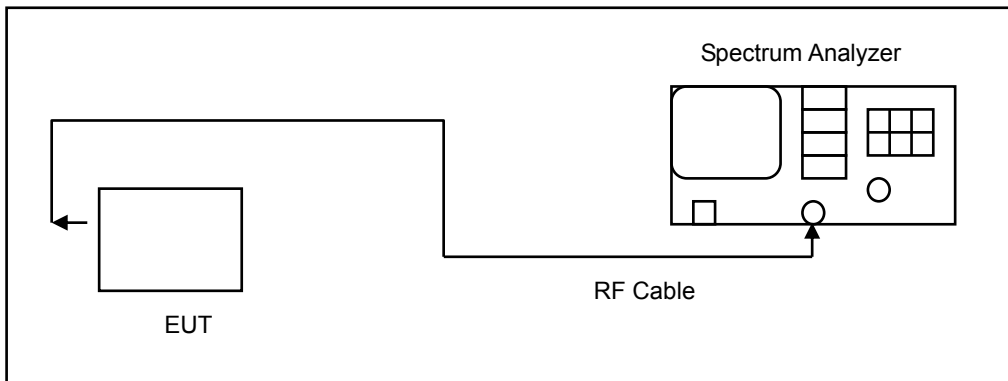

■ Test Procedure

The EUT tested to DTS test procedure of KDB 558074 D01 section 10.2 Method PKPSD for compliance to FCC 47CFR 15.247 requirements.

1. Set analyzer center frequency to DTS channel center frequency.
2. Set the span to 1.5 times the DTS bandwidth.
3. Set the RBW to: $3 \text{ kHz} \leq \text{RBW} \leq 100 \text{ kHz}$.
4. Set the VBW $\geq 3 \times \text{RBW}$.
5. Detector = peak.
6. Sweep time = auto couple.
7. Trace mode = max hold.
8. Allow trace to fully stabilize.
9. Use the peak marker function to determine the maximum amplitude level within the RBW.
10. If measured value exceeds limit, reduce RBW (no less than 3 kHz) and repeat.

4.6. Out of Band Conducted Emissions Measurement

■ Limit

In any 100 kHz bandwidth outside the frequency band in which the spread spectrum or digitally modulated intentional radiator is operating, the radio frequency power that is produced by the intentional radiator shall be at least 20 dB below that in the 100 kHz bandwidth within the band that contains the highest level of the desired power

■ Test Setup

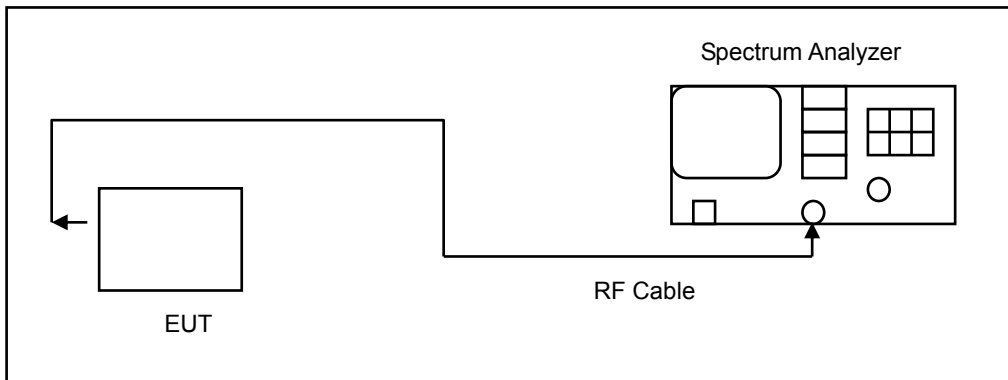

■ Test Procedure

In any 100 kHz bandwidth outside the EUT pass band, the RF power produced by the modulation products of the spreading sequence, the information sequence, and the carrier frequency shall be at least 20 dB below that of the maximum in-band 100 kHz emission, antenna output of the EUT was coupled directly to spectrum analyzer; if an external attenuator and/or cable was used, these losses are compensated for with the analyzer OFFSET function.

All other types of emissions from the EUT shall meet the general limits for radiated frequencies outside the pass band. The test was performed at 3 channels.



4.7. Antenna Measurement

■ Limit

For intentional device, according to 15.203, an intentional radiator shall be designed to ensure that no antenna other than that furnished by the responsible party shall be used with the device.

And According to 15.247 (b), if transmitting antennas of directional gain greater than 6 dBi are used, the power shall be reduced by the amount in dB that the directional gain of the antenna exceeds 6dBi.

■ Antenna Description

See section 2 – antenna information.



5 Test Results

Annex A. Conducted Emission

Standard:	FCC Part 15.247	Line:	L1
Test Mode:	Mode 1	Power:	AC 120 V/60 Hz
		Temp.(°C)/Hum.(%RH):	26(°C)/60 %RH
Description:			

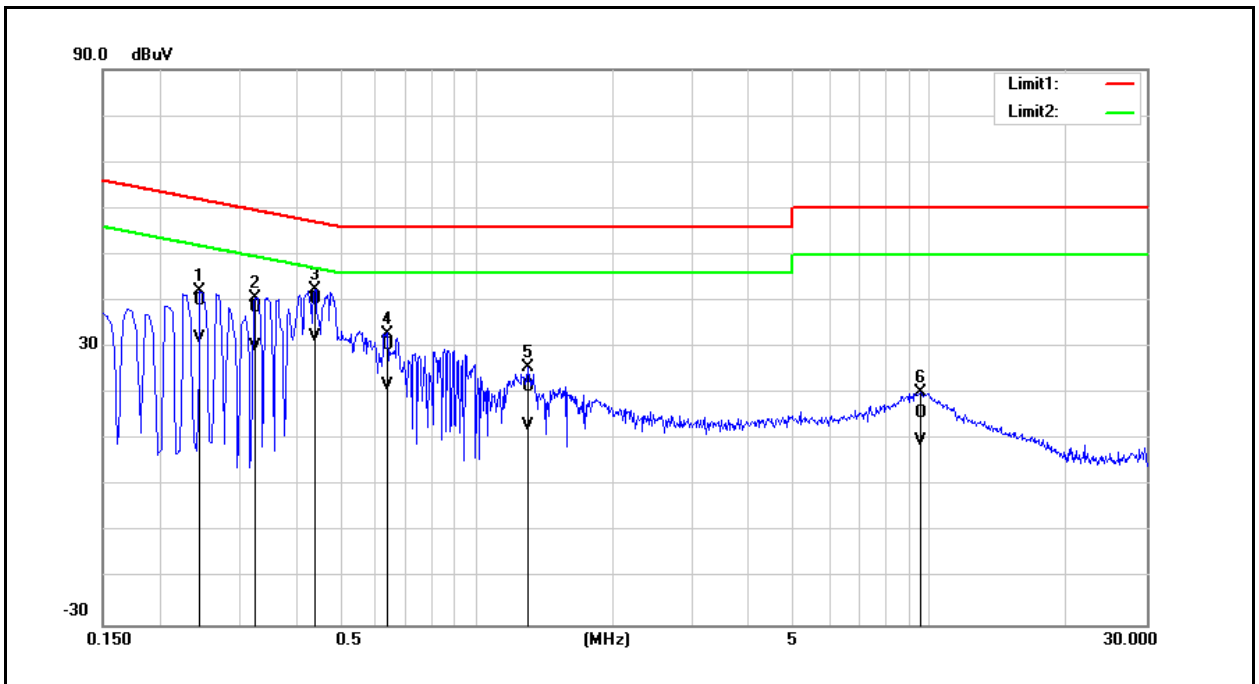

No.	Frequency (MHz)	QP reading (dBuV)	AVG reading (dBuV)	Correction factor (dB)	QP result (dBuV)	AVG result (dBuV)	QP limit (dBuV)	AVG limit (dBuV)	QP margin (dB)	AVG margin (dB)	Remark
1	0.2460	40.13	31.83	0.04	40.17	31.87	61.89	51.89	-21.72	-20.02	Pass
2	0.3260	38.43	30.17	0.05	38.48	30.22	59.55	49.55	-21.07	-19.33	Pass
3	0.4420	40.18	32.32	0.06	40.24	32.38	57.02	47.02	-16.78	-14.64	Pass
4	0.6340	30.43	21.57	0.06	30.49	21.63	56.00	46.00	-25.51	-24.37	Pass
5	1.3020	21.35	12.90	0.09	21.44	12.99	56.00	46.00	-34.56	-33.01	Pass
6	9.5100	15.40	9.41	0.29	15.69	9.70	60.00	50.00	-44.31	-40.30	Pass

Note: 1. Result (dBuV/m) = Correct Factor (dB/m) + Reading(dBuV).

Example: 40.17=0.04+40.13

2. Correction factor (dB) = Cable loss (dB) + L.I.S.N. factor (dB).



Standard:	FCC Part 15.247	Line:	N
Test Mode:	Mode 1	Power:	AC 120 V/60 Hz
		Temp.(°C)/Hum.(%RH):	26(°C)/60 %RH
Description:			

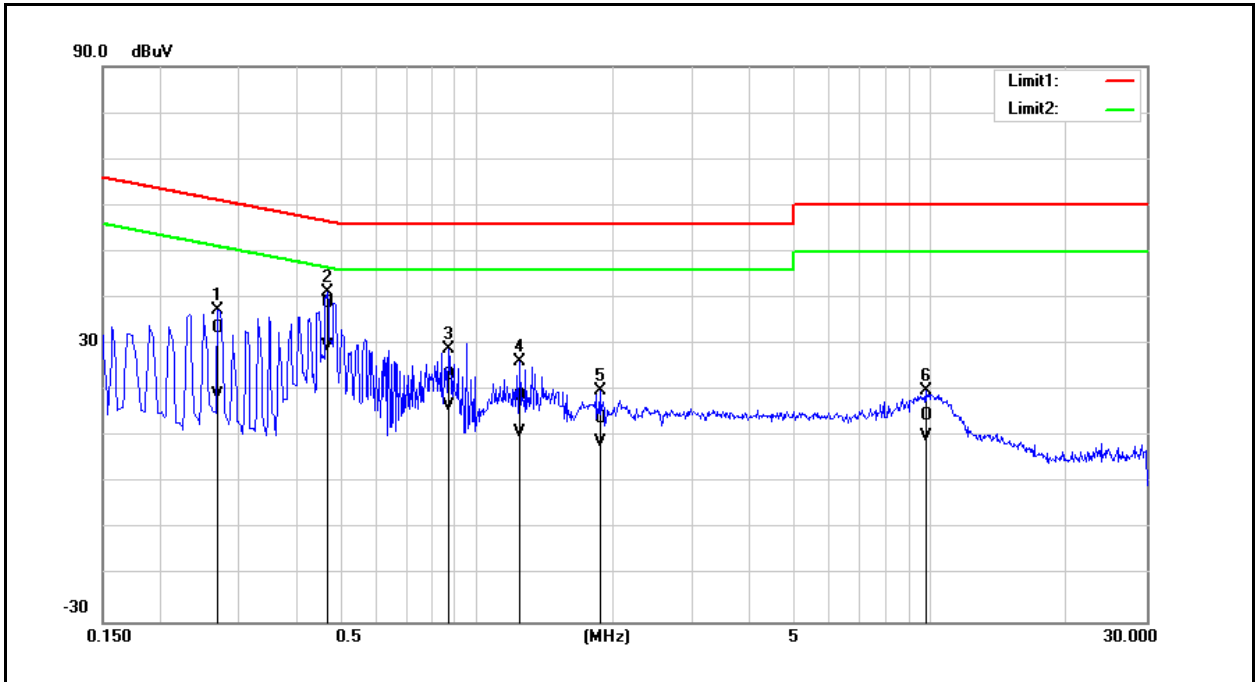

No.	Frequency (MHz)	QP reading (dBuV)	AVG reading (dBuV)	Correction factor (dB)	QP result (dBuV)	AVG result (dBuV)	QP limit (dBuV)	AVG limit (dBuV)	QP margin (dB)	AVG margin (dB)	Remark
1	0.2700	33.46	19.08	0.05	33.51	19.13	61.12	51.12	-27.61	-31.99	Pass
2	0.4700	38.91	29.39	0.06	38.97	29.45	56.51	46.51	-17.54	-17.06	Pass
3	0.8700	23.19	16.47	0.07	23.26	16.54	56.00	46.00	-32.74	-29.46	Pass
4	1.2460	18.74	10.78	0.09	18.83	10.87	56.00	46.00	-37.17	-35.13	Pass
5	1.8700	13.88	8.85	0.11	13.99	8.96	56.00	46.00	-42.01	-37.04	Pass
6	9.8060	14.29	9.91	0.29	14.58	10.20	60.00	50.00	-45.42	-39.80	Pass

Note: 1. Result (dBuV/m) = Correct Factor (dB/m) + Reading(dBuV).

Example: 33.51=0.05+33.46

2. Correction factor (dB) = Cable loss (dB) + L.I.S.N. factor (dB).

Annex B. Conducted Test Results

Maximum Conducted Output Power Measurement

Test Mode	Data Rate (Mbps)	Frequency (MHz)	Average Output Power		Peak Output Power		
			Measurement Results		Measurement Results		Limit
			dBm	W	dBm	W	dBm
Mode 2	1	2412	9.45	0.009	12.46	0.018	< 30
		2437	9.47	0.009	12.57	0.018	< 30
		2462	7.58	0.006	10.57	0.011	< 30
	2	2437	9.44	0.009	12.55	0.018	< 30
	5.5	2437	9.42	0.009	12.52	0.018	< 30
	11	2437	9.39	0.009	12.49	0.018	< 30
Mode 3	6	2412	9.00	0.008	16.27	0.042	< 30
		2437	9.03	0.008	16.41	0.044	< 30
		2462	7.45	0.006	14.80	0.030	< 30
	9	2437	9.00	0.008	16.38	0.043	< 30
	12	2437	9.02	0.008	16.35	0.043	< 30
	18	2437	9.04	0.008	16.32	0.043	< 30
	24	2437	9.07	0.008	16.30	0.043	< 30
	36	2437	9.10	0.008	16.28	0.042	< 30
	48	2437	9.13	0.008	16.25	0.042	< 30
	54	2437	9.15	0.008	13.22	0.021	< 30

Note: The relevant measured result has the offset with cable loss already.



Test Mode	Data Rate (Mbps)	Frequency (MHz)	Average Output Power		Peak Output Power		
			Measurement Results		Measurement Results		Limit
			dBm	W	dBm	W	dBm
Mode 4	6.5	2412	7.79	0.006	15.68	0.037	< 30
		2437	7.99	0.006	15.66	0.037	< 30
		2462	5.88	0.004	13.60	0.023	< 30
	14.4	2437	8.02	0.006	15.63	0.037	< 30
	21.7	2437	8.04	0.006	15.60	0.036	< 30
	28.9	2437	8.07	0.006	15.58	0.036	< 30
	43.3	2437	8.09	0.006	15.57	0.036	< 30
	57.8	2437	8.12	0.006	15.55	0.036	< 30
	65	2437	8.15	0.007	15.52	0.036	< 30
	72.2	2437	8.18	0.007	15.50	0.035	< 30
Mode 5	13.5	2422	6.08	0.004	13.74	0.024	< 30
		2437	5.99	0.004	13.71	0.023	< 30
		2452	4.21	0.003	11.92	0.016	< 30
	30	2437	6.02	0.004	13.69	0.023	< 30
	45	2437	6.04	0.004	13.66	0.023	< 30
	60	2437	6.07	0.004	13.63	0.023	< 30
	90	2437	6.10	0.004	13.61	0.023	< 30
	120	2437	7.12	0.005	13.59	0.023	< 30
	135	2437	7.14	0.005	13.57	0.023	< 30
	150	2437	7.17	0.005	13.54	0.023	< 30

Note: The relevant measured result has the offset with cable loss already.



6dB RF Bandwidth Measurement

Test Mode	Frequency (MHz)	Measurement (kHz)	Limit (kHz)
Mode 2	2412	7082	> 500
	2437	7066	> 500
	2462	7069	> 500
Mode 3	2412	16340	> 500
	2437	16330	> 500
	2462	16340	> 500
Mode 4	2412	17540	> 500
	2437	17330	> 500
	2462	17570	> 500
Mode 5	2422	35160	> 500
	2437	35140	> 500
	2452	35160	> 500



■ Test Graphs

Mode 2: IEEE 802.11b Continuous TX mode

2412 MHz



2437 MHz



2462 MHz





Mode 3: IEEE 802.11g Continuous TX mode

2412 MHz

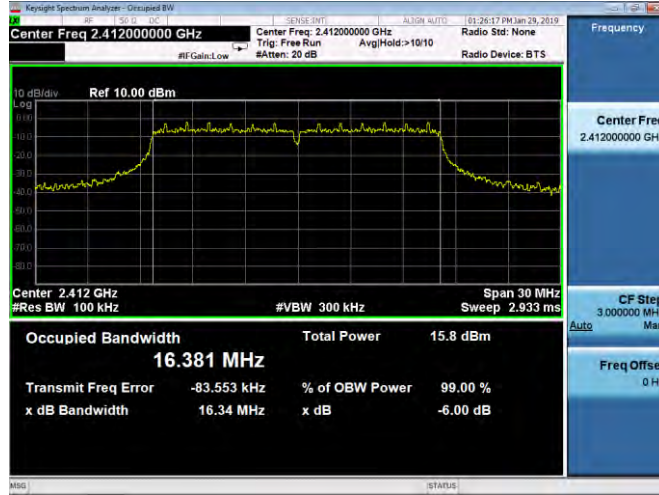

2437 MHz

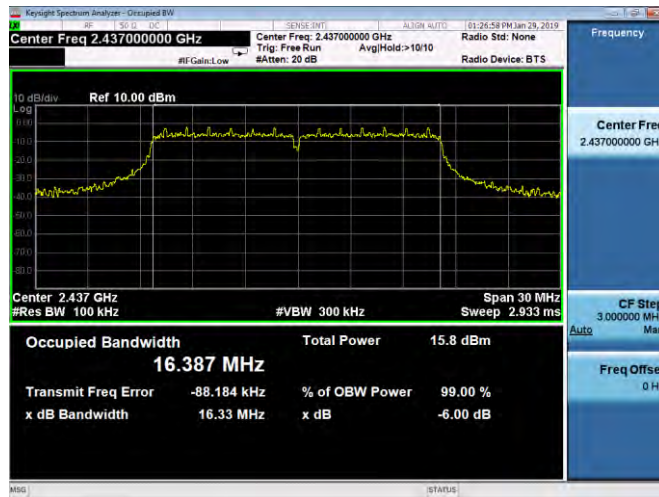

2462 MHz

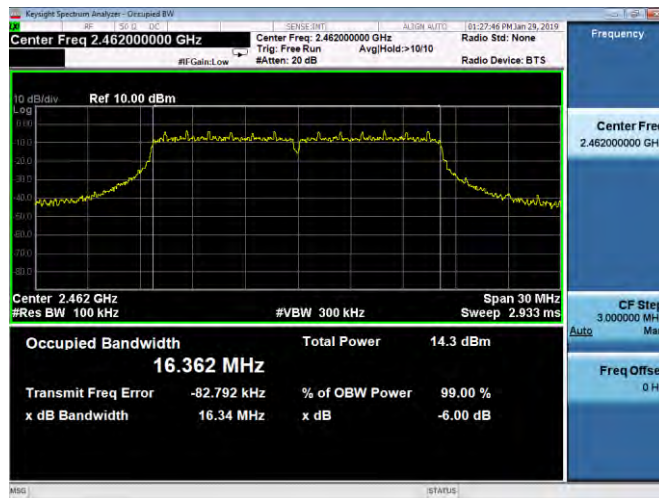



Mode 4: IEEE 802.11n 2.4GHz 20MHz Continuous TX mode

2412 MHz

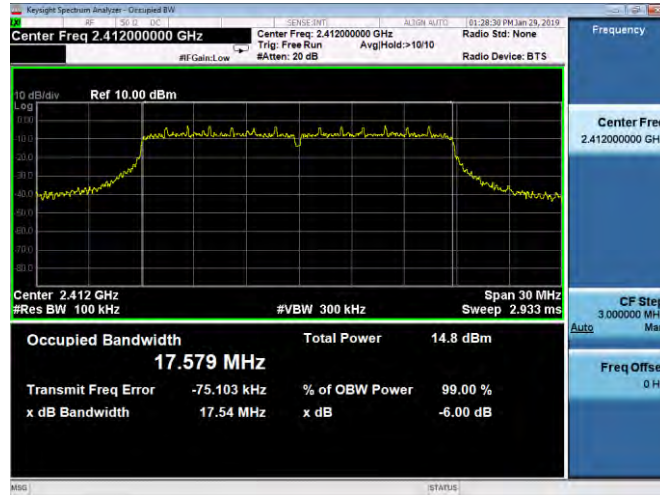

2437 MHz



2462 MHz

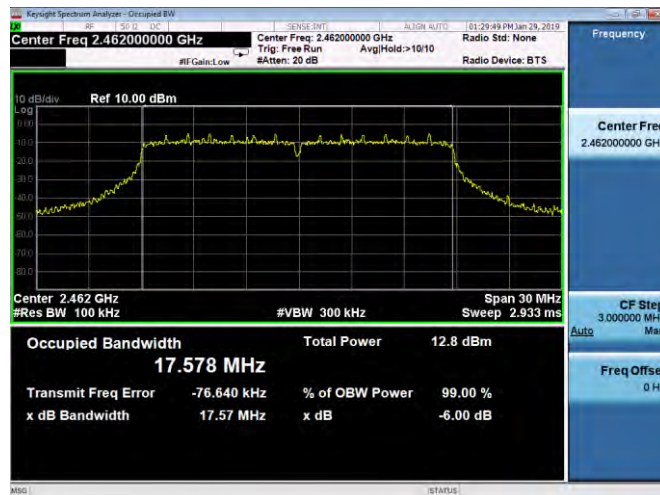



Mode 5: IEEE 802.11n 2.4GHz 40MHz Continuous TX mode

2422 MHz

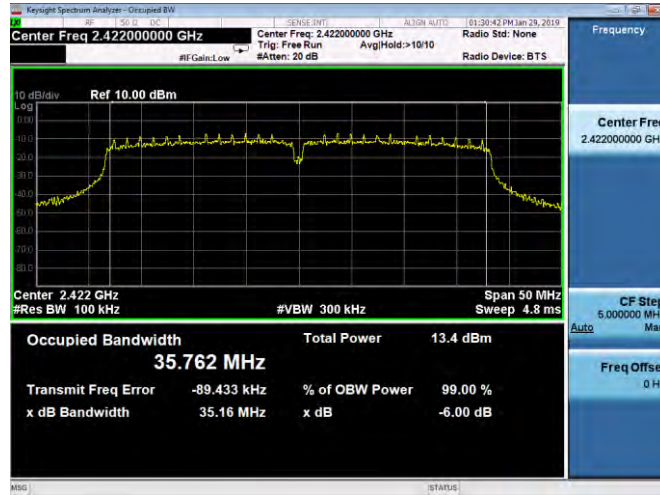

2437 MHz

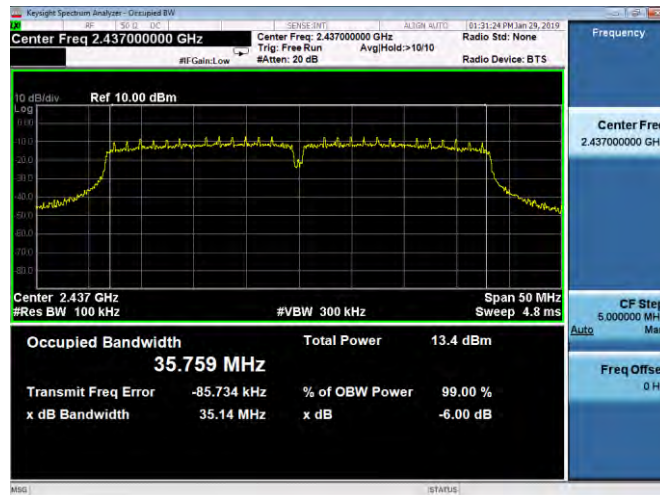

2452 MHz

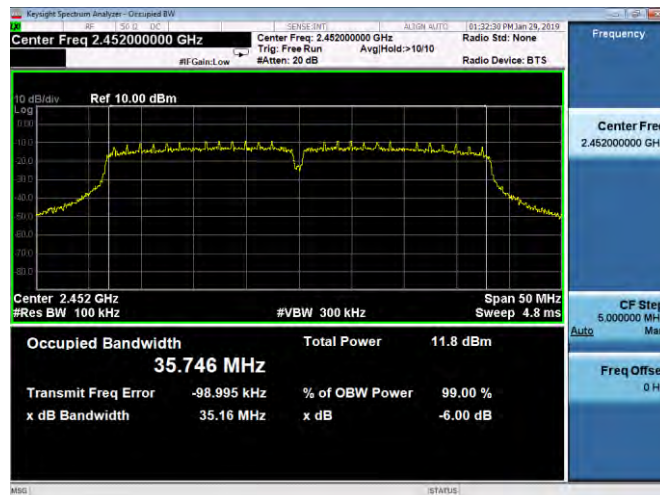

**Maximum Power Spectral Density Measurement**

Test Mode	Frequency (MHz)	Measurement (dBm/3KHz)	Limit (dBm/3KHz)
Mode 2	2412	-13.304	< 8
	2437	-13.072	< 8
	2462	-15.377	< 8
Mode 3	2412	-16.513	< 8
	2437	-16.343	< 8
	2462	-17.230	< 8
Mode 4	2412	-17.361	< 8
	2437	-16.212	< 8
	2462	-19.260	< 8
Mode 5	2422	-21.888	< 8
	2437	-20.993	< 8
	2452	-23.496	< 8



■ Test Graphs

Mode 2: IEEE 802.11b Continuous TX mode

2412 MHz



2437 MHz



2462 MHz

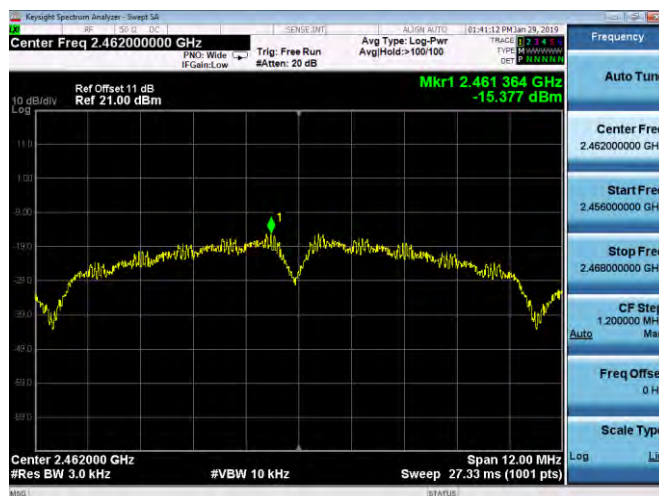



Mode 3: IEEE 802.11g Continuous TX mode

2412 MHz

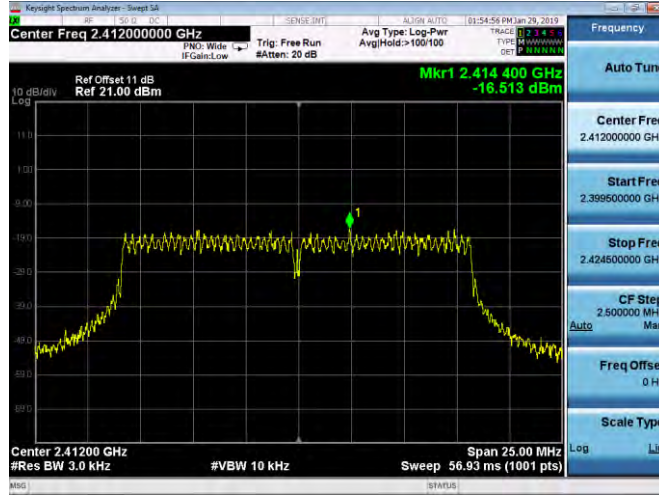

2437 MHz

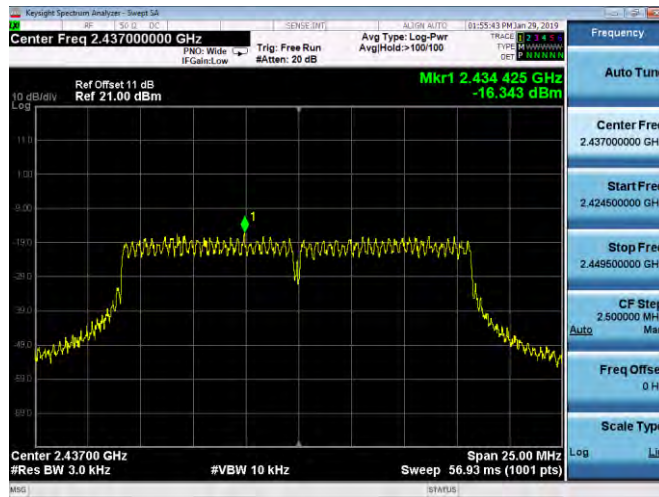

2462 MHz

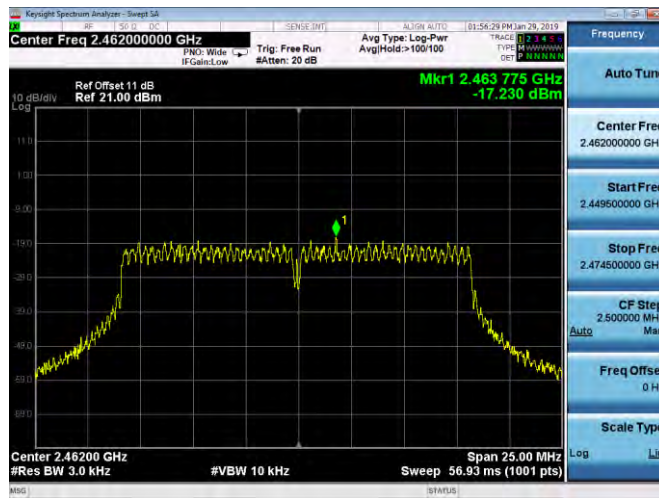



Mode 4: IEEE 802.11n 2.4GHz 20MHz Continuous TX mode

2412 MHz

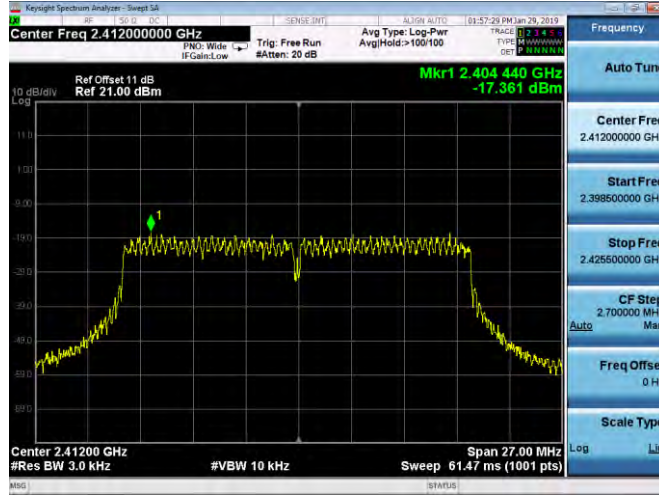

2437 MHz

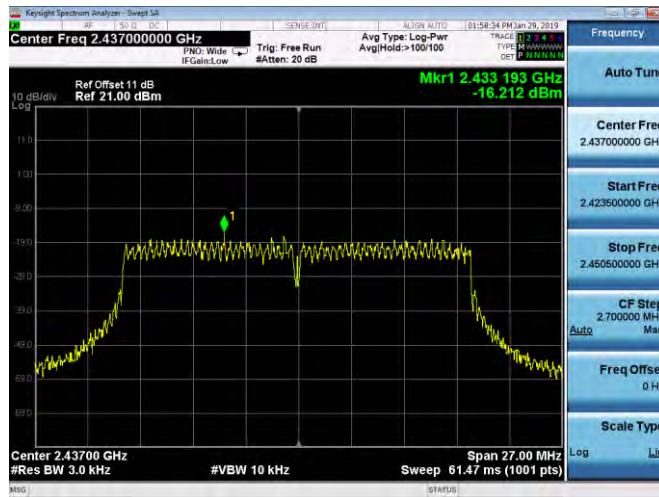

2462 MHz

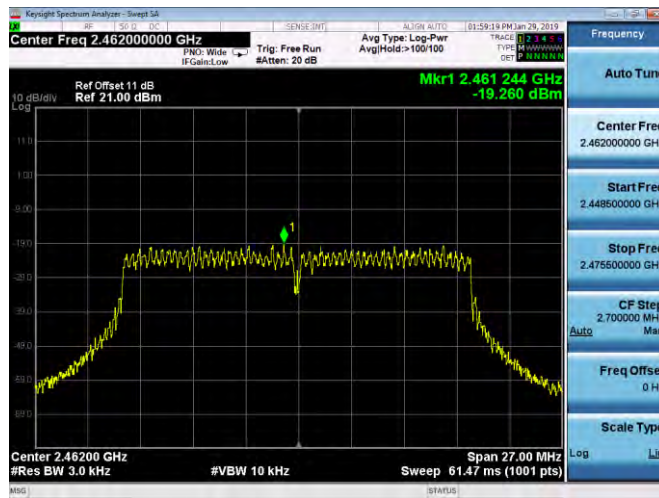



Mode 5: IEEE 802.11n 2.4GHz 40MHz Continuous TX mode

2422 MHz

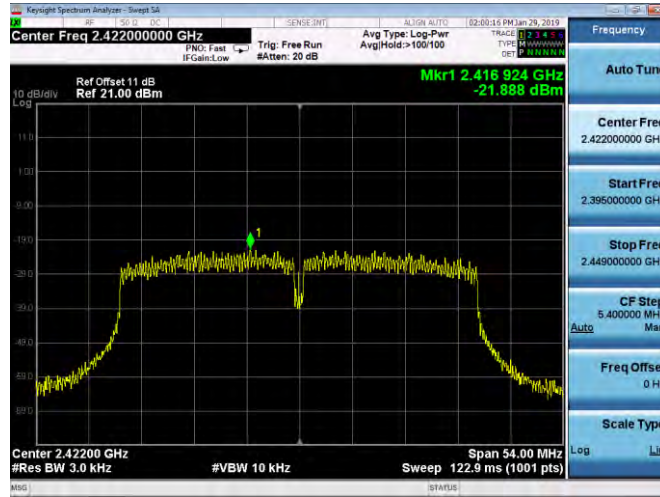

2437 MHz

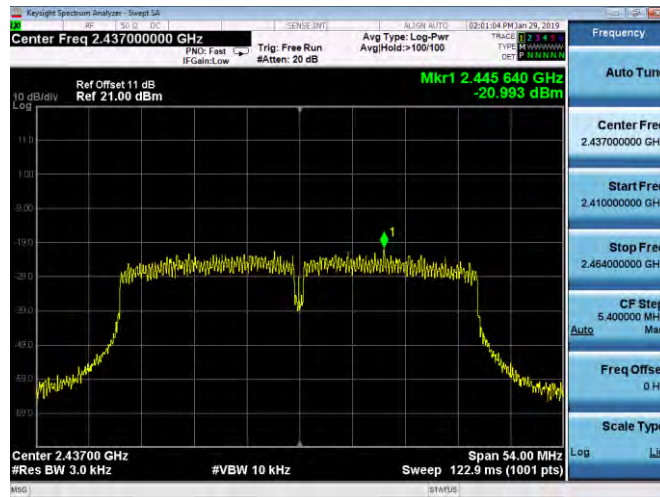

2452 MHz

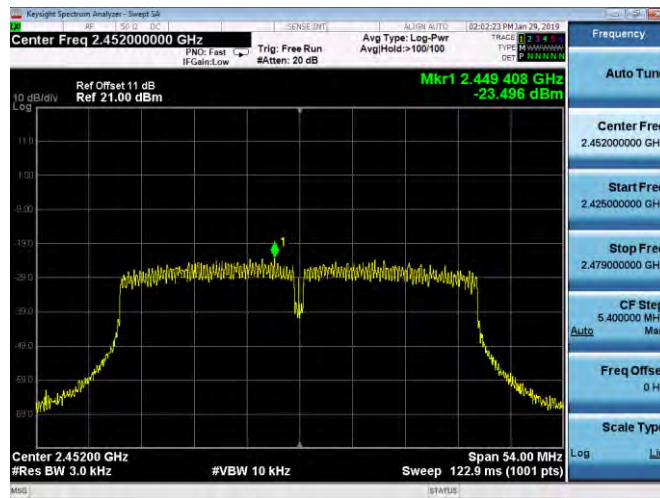





Out of Band Conducted Emissions Measurement

■ Test Graphs

Reference level

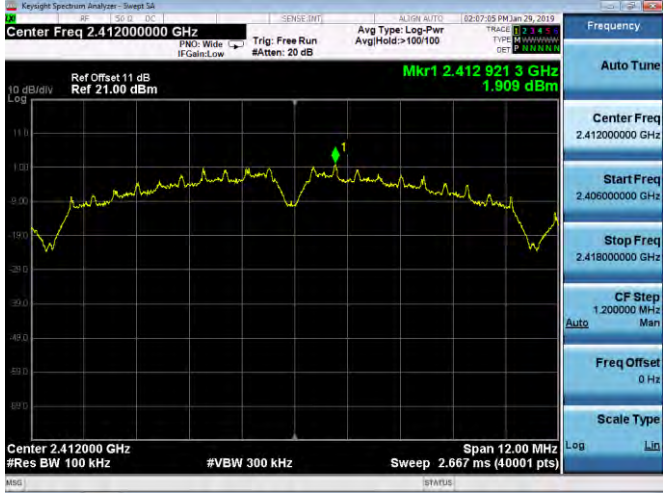
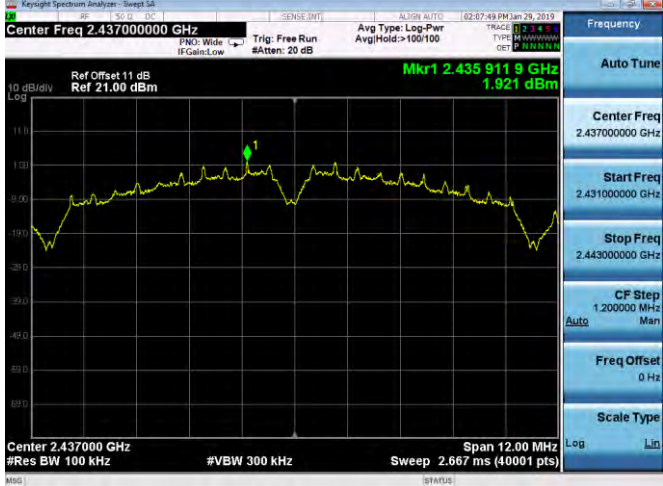
Mode 2: IEEE 802.11b Continuous TX mode

2412 MHz	
2437 MHz	
2462 MHz	



Mode 3: IEEE 802.11g Continuous TX mode

2412 MHz

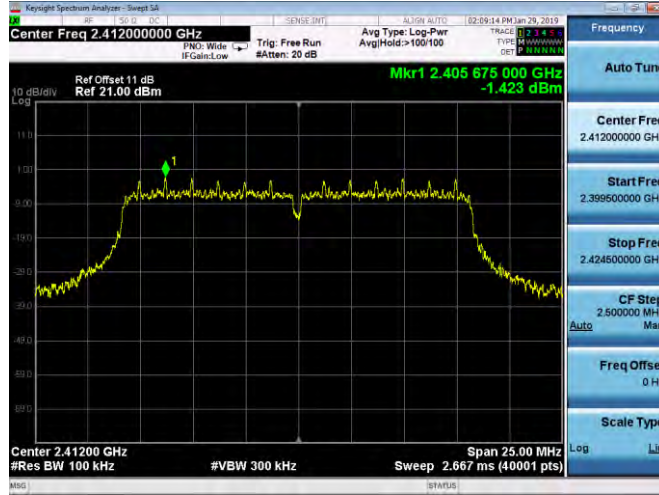

2437 MHz

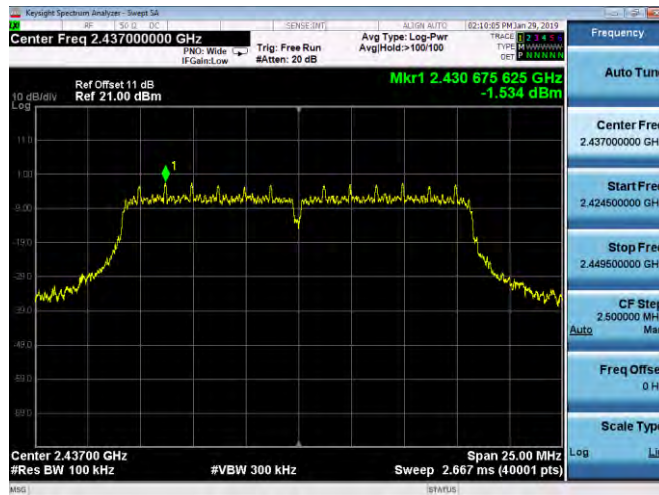

2462 MHz

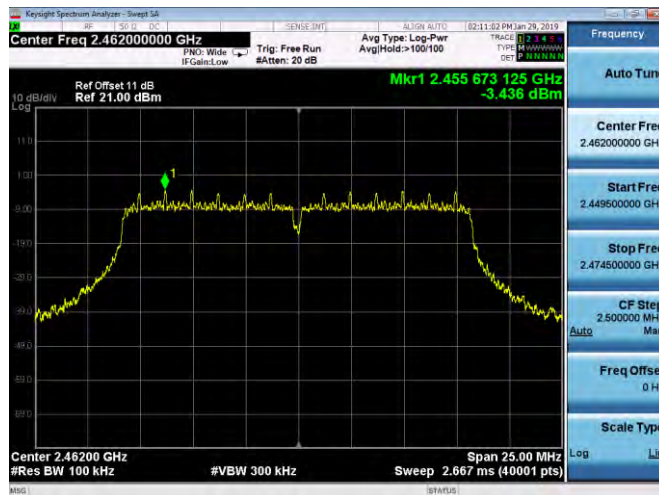



Mode 4: IEEE 802.11n 2.4GHz 20MHz Continuous TX mode

2412 MHz

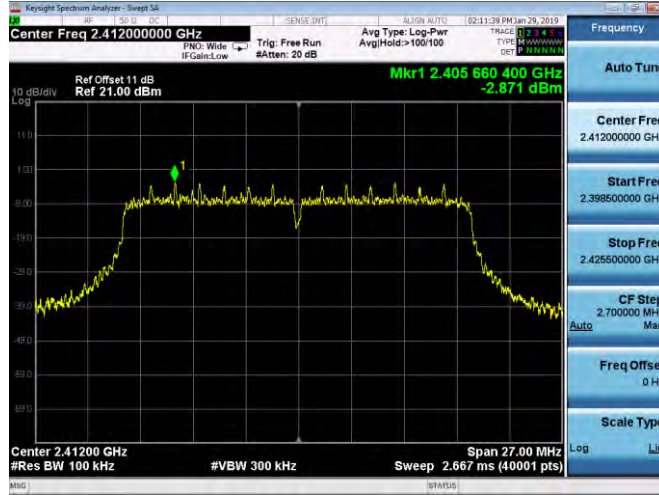

2437 MHz

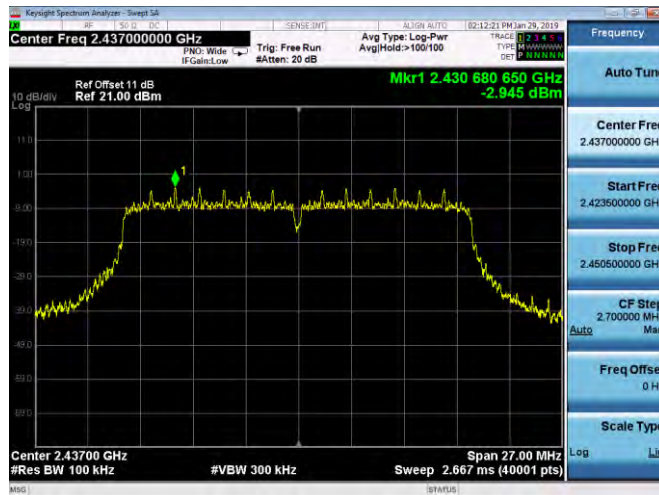

2462 MHz

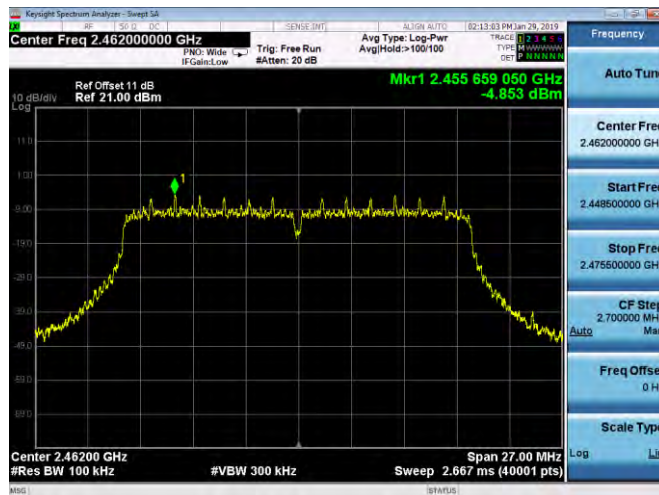



Mode 5: IEEE 802.11n 2.4GHz 40MHz Continuous TX mode

2422 MHz

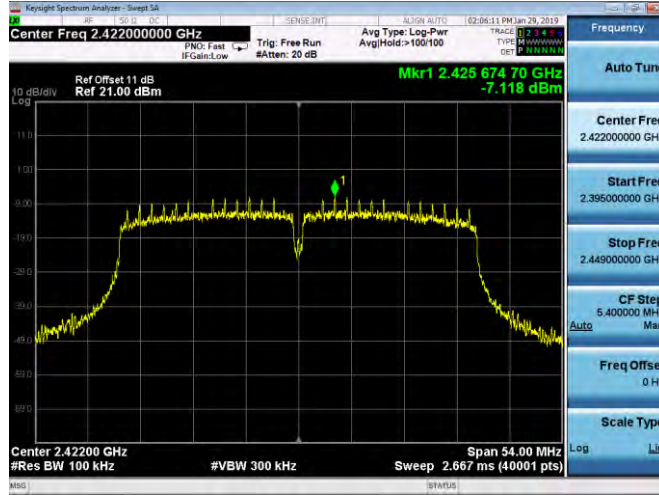

2437 MHz

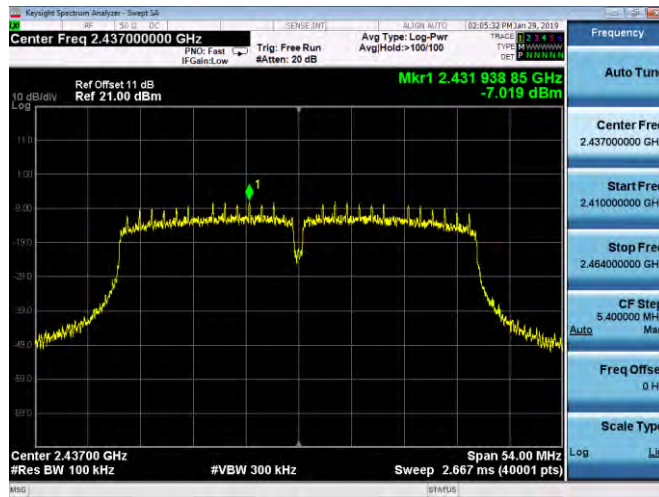

2452 MHz

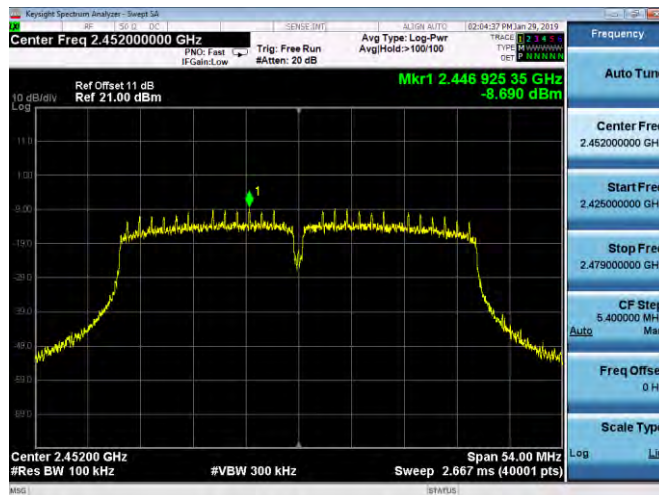



Out of Band Conducted Emissions

Mode 2: IEEE 802.11b Continuous TX mode

2412 MHz

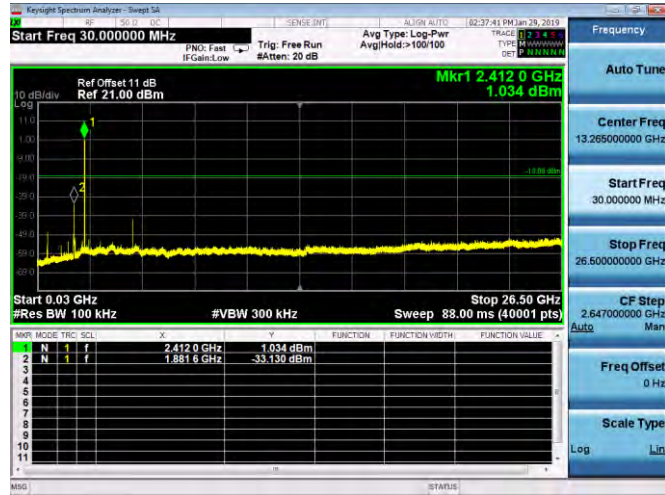

2437 MHz



2462 MHz

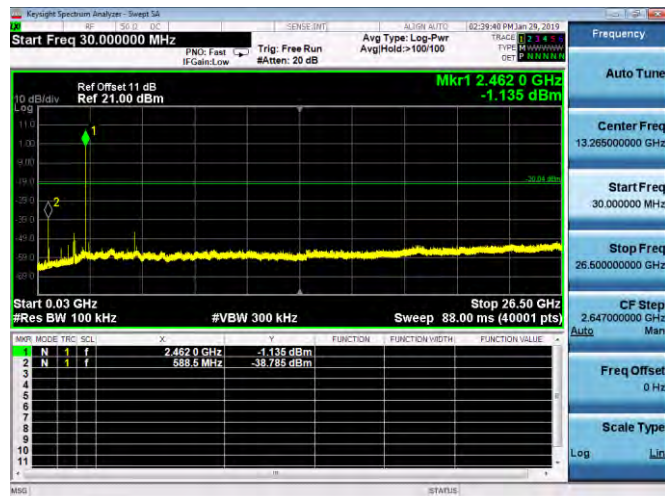



Mode 3: IEEE 802.11g Continuous TX mode

2412 MHz

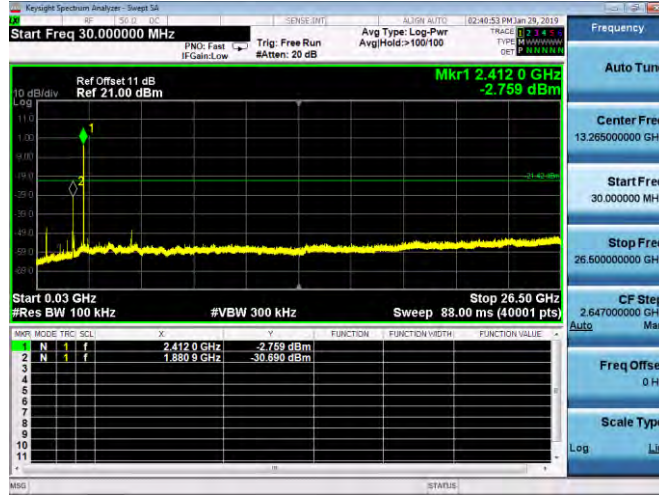

2437 MHz

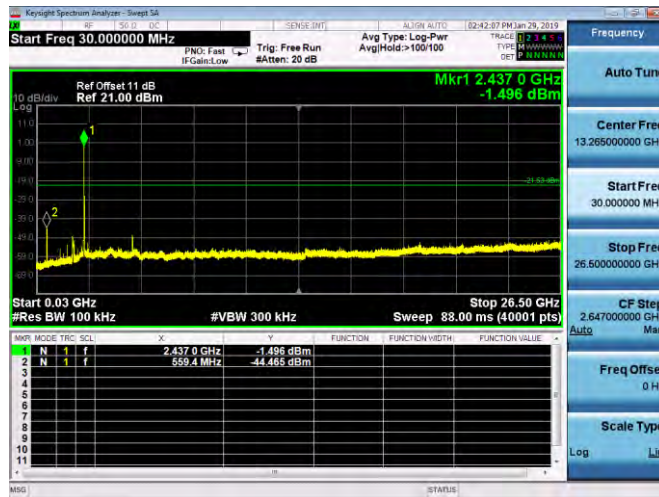

2462 MHz

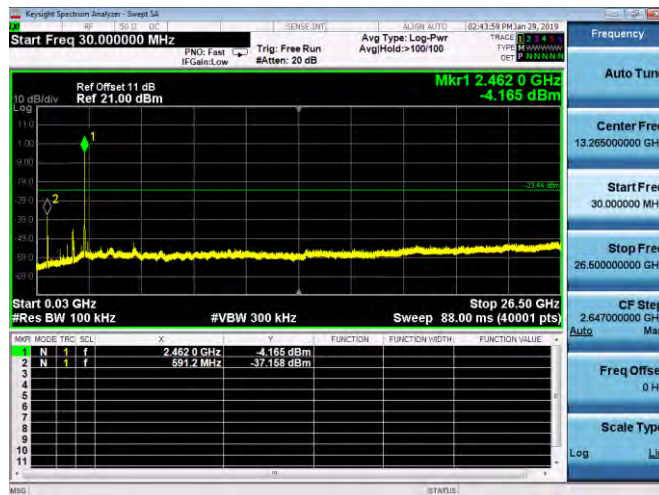



Mode 4: IEEE 802.11n 2.4GHz 20MHz Continuous TX mode

2412 MHz

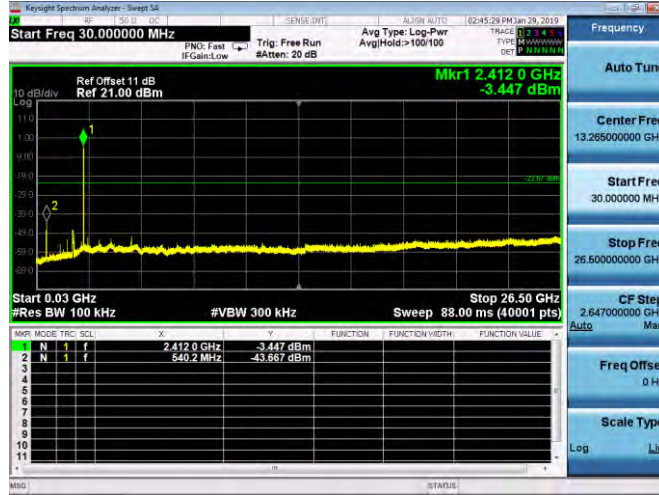

2437 MHz



2462 MHz

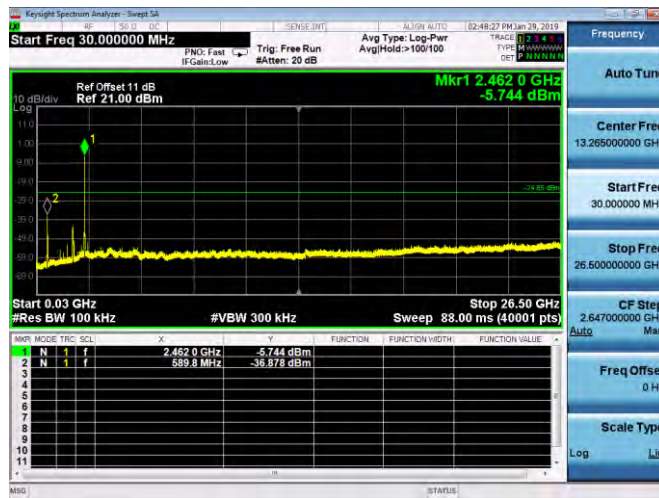



Mode 5: IEEE 802.11n 2.4GHz 40MHz Continuous TX mode

2422 MHz

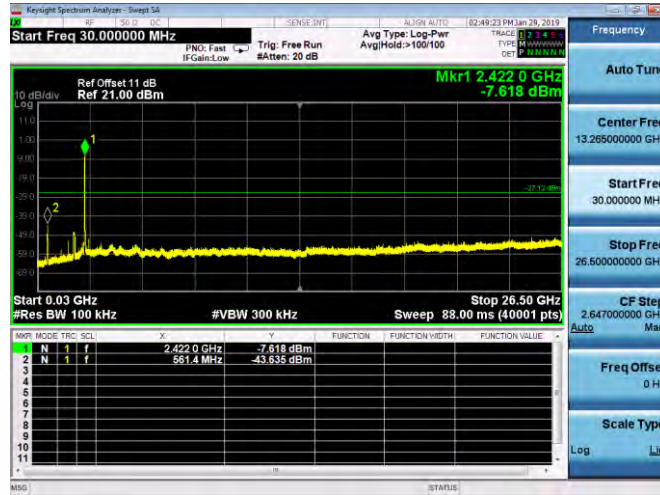

2437 MHz

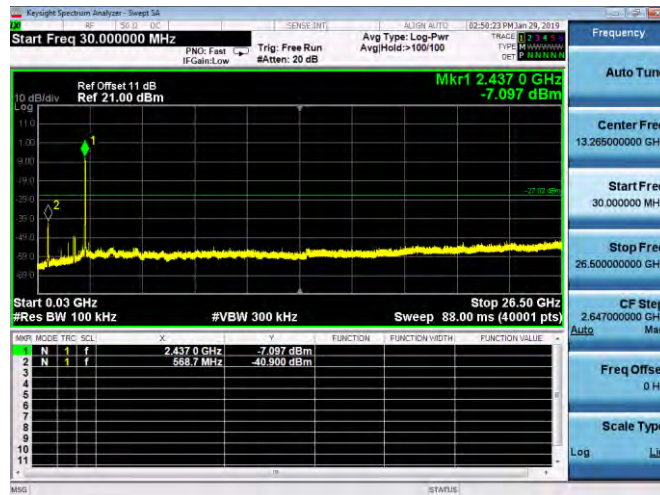

2452 MHz





Conducted Band Edge

Mode 2: IEEE 802.11b Continuous TX mode

2412 MHz

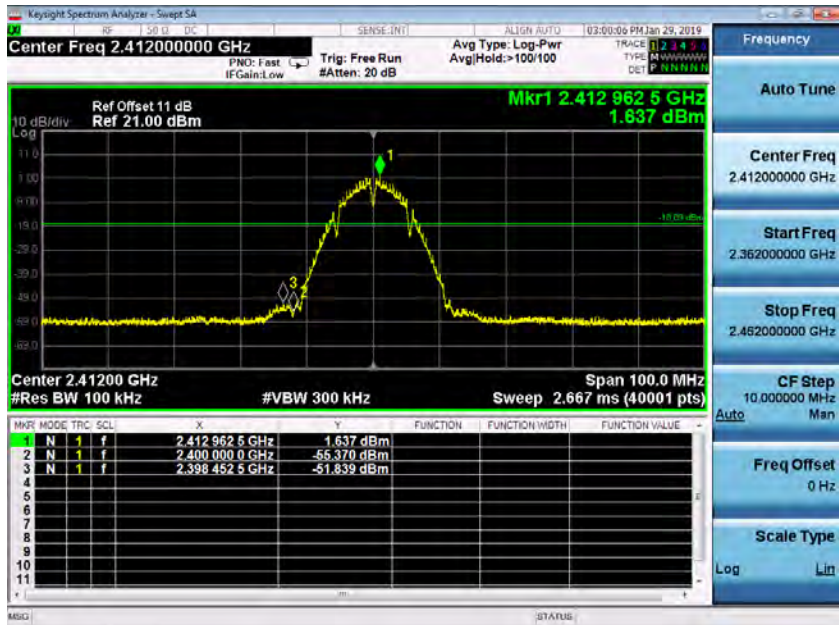

2462 MHz

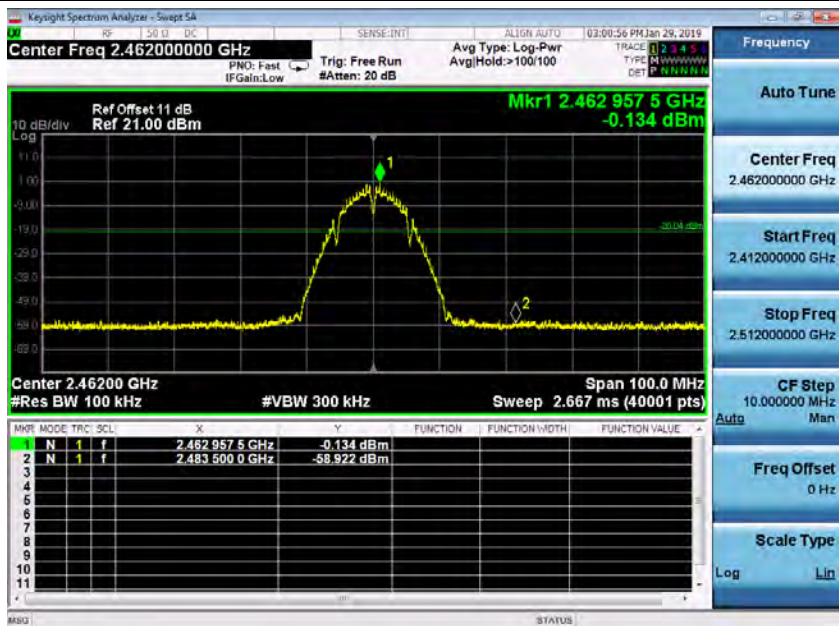



Mode 3: IEEE 802.11g Continuous TX mode

2412 MHz

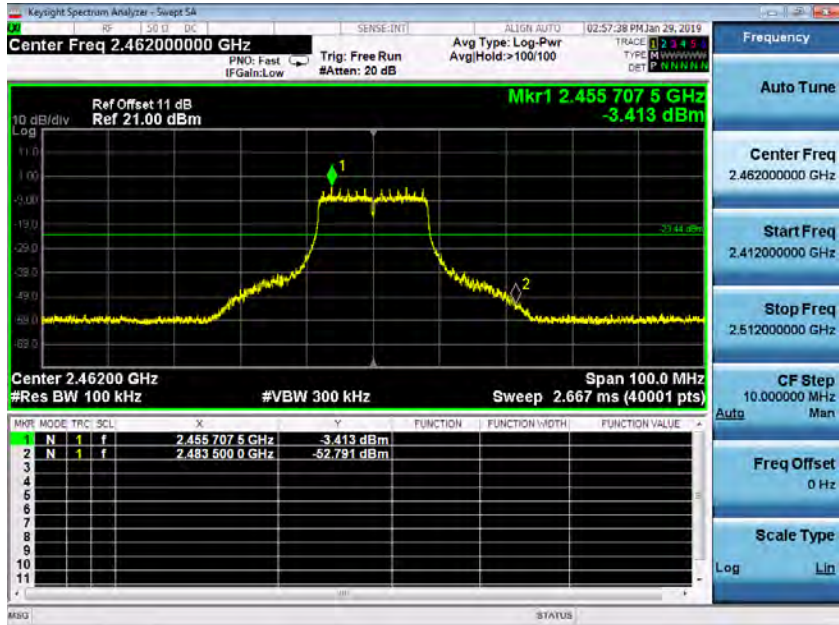

2462 MHz



Mode 4: IEEE 802.11n 2.4GHz 20MHz Continuous TX mode

2412 MHz

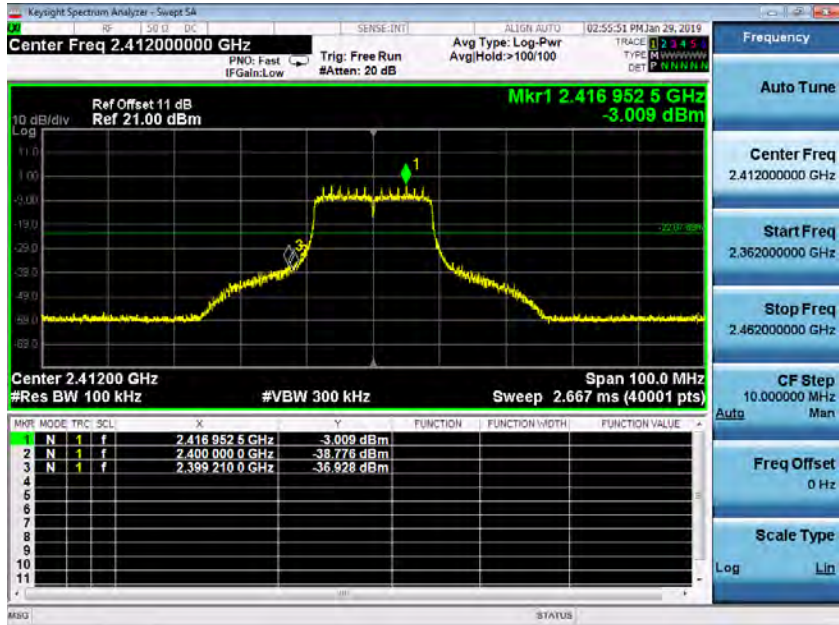

2462 MHz

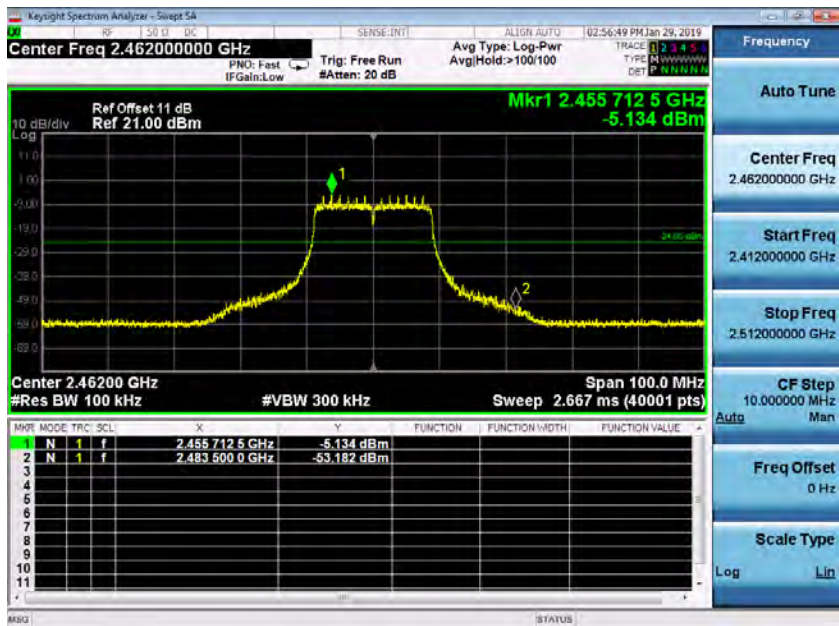



Mode 5: IEEE 802.11n 2.4GHz 40MHz Continuous TX mode

2422 MHz

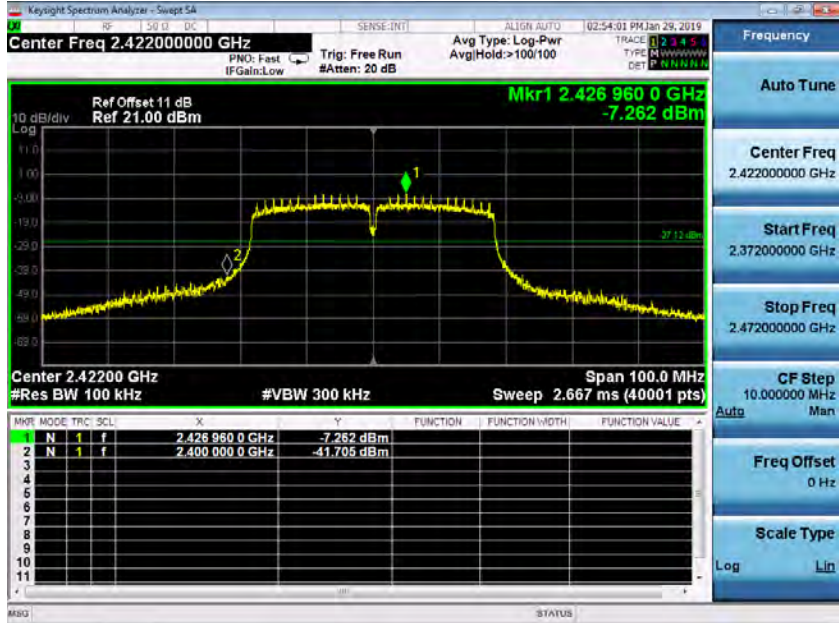

2452 MHz

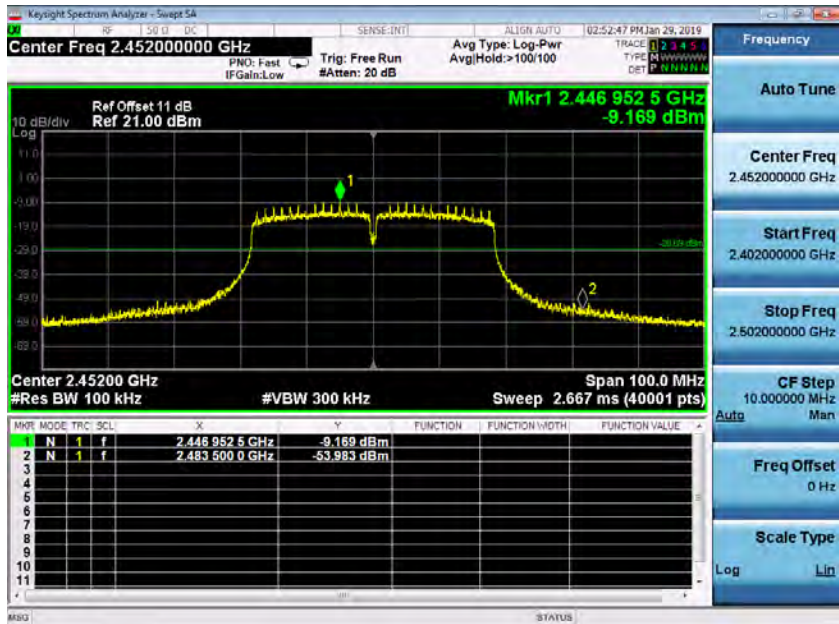



Annex C. Radiated Emission Test Results

Harmonic

Below 1GHz

Standard:		FCC Part 15.247		Test Distance:		3 m	
Test item:		Harmonic		Power:		AC 120 V/60 Hz	
Test Mode:		Mode 1		Temp.(°C)/Hum.(%RH):		26(°C)/60 %RH	
Frequency (MHz)	Reading (dBuV)	Correct Factor (dB/m)	Result (dBuV/m)	Limit (dBuV/m)	Margin (dB)	Remark	Ant.Polar. H / V
62.0100	34.86	-12.14	22.72	40.00	-17.28	QP	H
155.1300	32.46	-11.34	21.12	43.50	-22.38	QP	H
312.2700	34.92	-10.50	24.42	46.00	-21.58	QP	H
600.3600	29.59	-3.77	25.82	46.00	-20.18	QP	H
773.9900	29.56	-1.17	28.39	46.00	-17.61	QP	H
973.8100	30.88	1.01	31.89	54.00	-22.11	QP	H
138.6400	33.35	-11.89	21.46	43.50	-22.04	QP	V
309.3600	31.65	-10.56	21.09	46.00	-24.91	QP	V
432.5500	30.05	-7.61	22.44	46.00	-23.56	QP	V
560.5900	28.72	-4.64	24.08	46.00	-21.92	QP	V
749.7400	31.14	-1.60	29.54	46.00	-16.46	QP	V
981.5700	30.73	1.09	31.82	54.00	-22.18	QP	V

Note: 1. Result (dBuV/m) = Correct Factor (dB/m) + Reading(dBuV).

Example: 22.72= -12.14+34.86

2. Correction factor (dB/m) = Antenna Factor (dB/m) + Cable loss (dB) – Pre-Amplifier gain (dB).

3. When the peak results are less than average limit, so not need to evaluate the average.



Above 1GHz

Standard:	FCC Part 15.247	Test Distance:	3 m
Test item:	Harmonic	Power:	AC 120 V/60 Hz
Frequency:	2412 MHz	Temp.(°C)/Hum.(%RH):	25(°C)/50%RH
Mode:	Mode 2		
Ant.Polar.:	Horizontal		

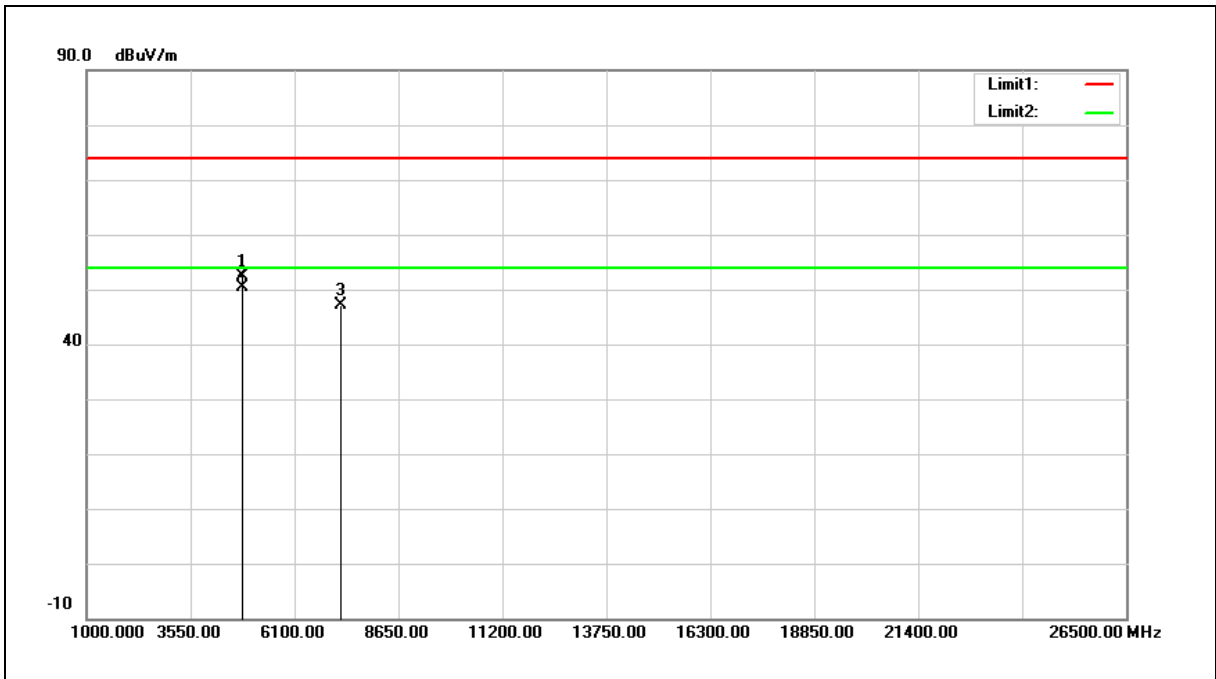

No.	Frequency (MHz)	Reading (dBuV)	Correct Factor (dB/m)	Result (dBuV/m)	Limit (dBuV/m)	Margin (dB)	Remark
1	4824.000	57.55	-5.05	52.50	74.00	-21.50	peak
2	4824.000	55.54	-5.05	50.49	54.00	-3.51	AVG
3	7236.000	48.04	-0.88	47.16	74.00	-26.84	peak

Note:1.Result (dBuV/m) = Correct Factor (dB/m) + Reading(dBuV).

Example: 52.50=-5.05+57.55

2.Correction factor (dB/m) = Antenna Factor (dB/m) + Cable loss (dB) – Pre-Amplifier gain (dB).

3.When the peak results are less than average limit, so not need to evaluate the average.



Standard:	FCC Part 15.247	Test Distance:	3 m
Test item:	Harmonic	Power:	AC 120 V/60 Hz
Frequency:	2412 MHz	Temp.(°C)/Hum.(%RH):	25(°C)/50%RH
Mode:	Mode 2		
Ant.Polar.:	Vertical		

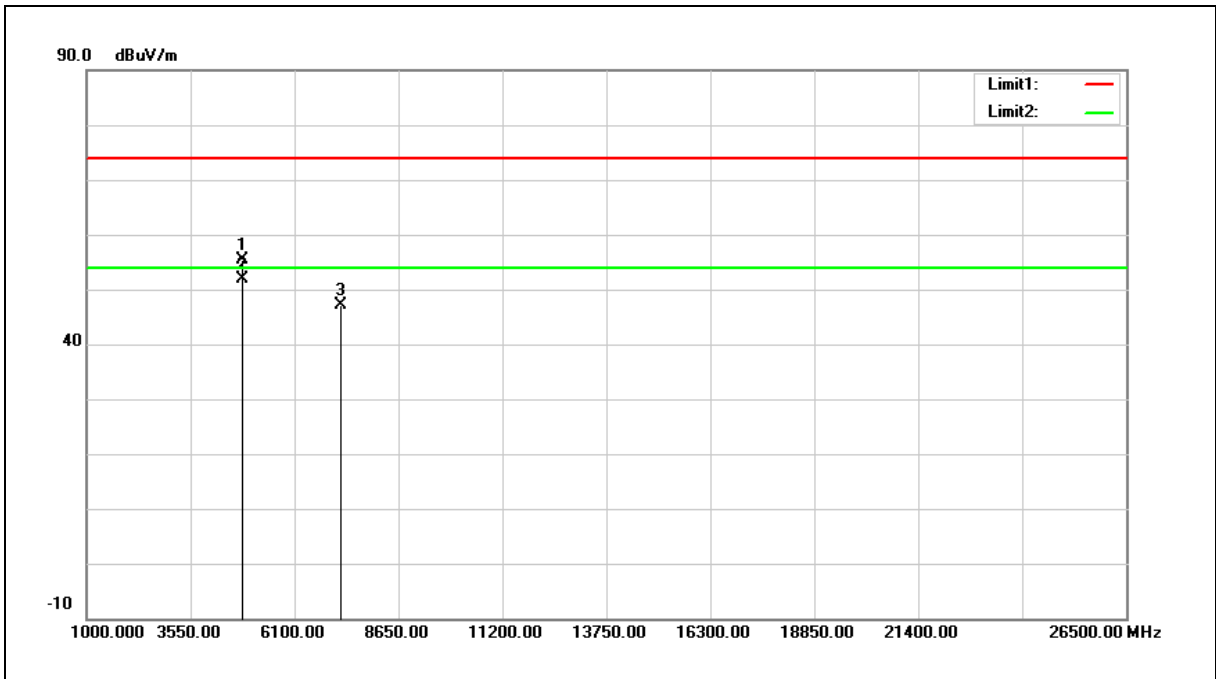

No.	Frequency (MHz)	Reading (dBuV)	Correct Factor (dB/m)	Result (dBuV/m)	Limit (dBuV/m)	Margin (dB)	Remark
1	4824.000	60.49	-5.05	55.44	74.00	-18.56	peak
2	4824.000	57.03	-5.05	51.98	54.00	-2.02	AVG
3	7236.000	47.91	-0.88	47.03	74.00	-26.97	peak

Note:1.Result (dBuV/m) = Correct Factor (dB/m) + Reading(dBuV).

Example: 55.44=-5.05+60.49

2.Correction factor (dB/m) = Antenna Factor (dB/m) + Cable loss (dB) – Pre-Amplifier gain (dB).

3.When the peak results are less than average limit, so not need to evaluate the average.



Standard:	FCC Part 15.247	Test Distance:	3 m
Test item:	Harmonic	Power:	AC 120 V/60 Hz
Frequency:	2437 MHz	Temp.(°C)/Hum.(%RH):	25(°C)/50%RH
Mode:	Mode 2		
Ant.Polar.:	Horizontal		

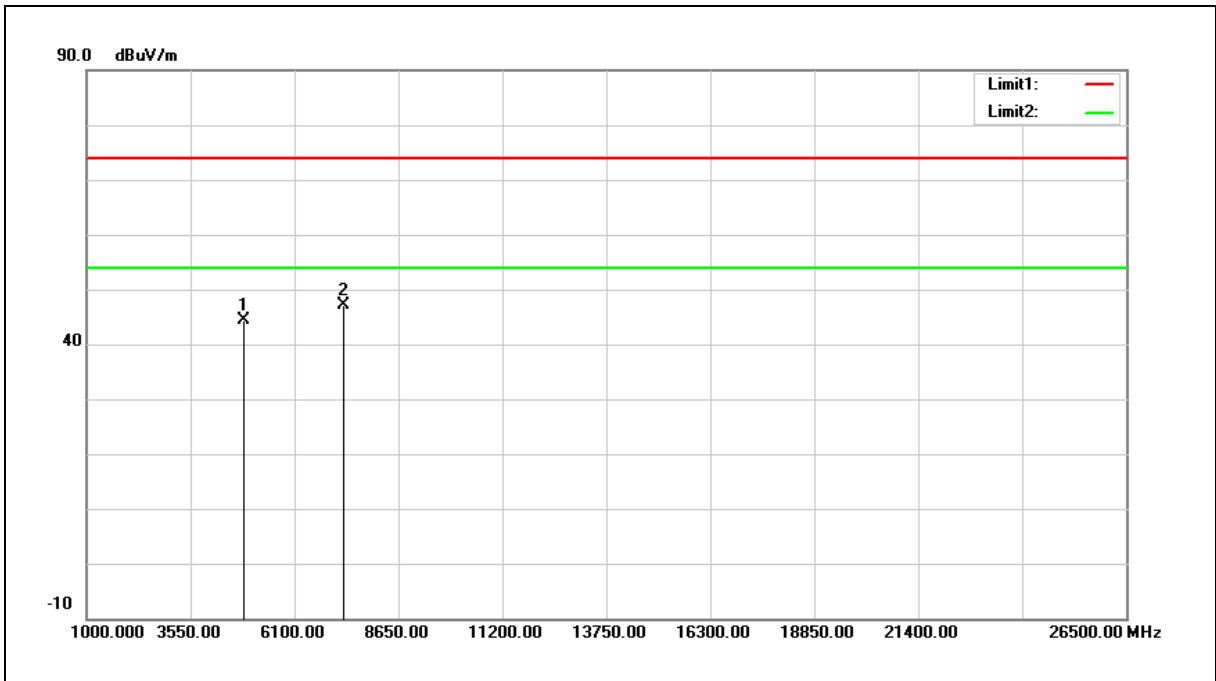

No.	Frequency (MHz)	Reading (dBuV)	Correct Factor (dB/m)	Result (dBuV/m)	Limit (dBuV/m)	Margin (dB)	Remark
1	4874.000	49.42	-5.09	44.33	74.00	-29.67	peak
2	7311.000	47.73	-0.67	47.06	74.00	-26.94	peak

- Note: 1.Result (dBuV/m) = Correct Factor (dB/m) + Reading(dBuV).
 2.Correction factor (dB/m) = Antenna Factor (dB/m) + Cable loss (dB) – Pre-Amplifier gain (dB).
 3.When the peak results are less than average limit, so not need to evaluate the average.



Standard:	FCC Part 15.247	Test Distance:	3 m
Test item:	Harmonic	Power:	AC 120 V/60 Hz
Frequency:	2437 MHz	Temp.(°C)/Hum.(%RH):	25(°C)/50%RH
Mode:	Mode 2		
Ant.Polar.:	Vertical		

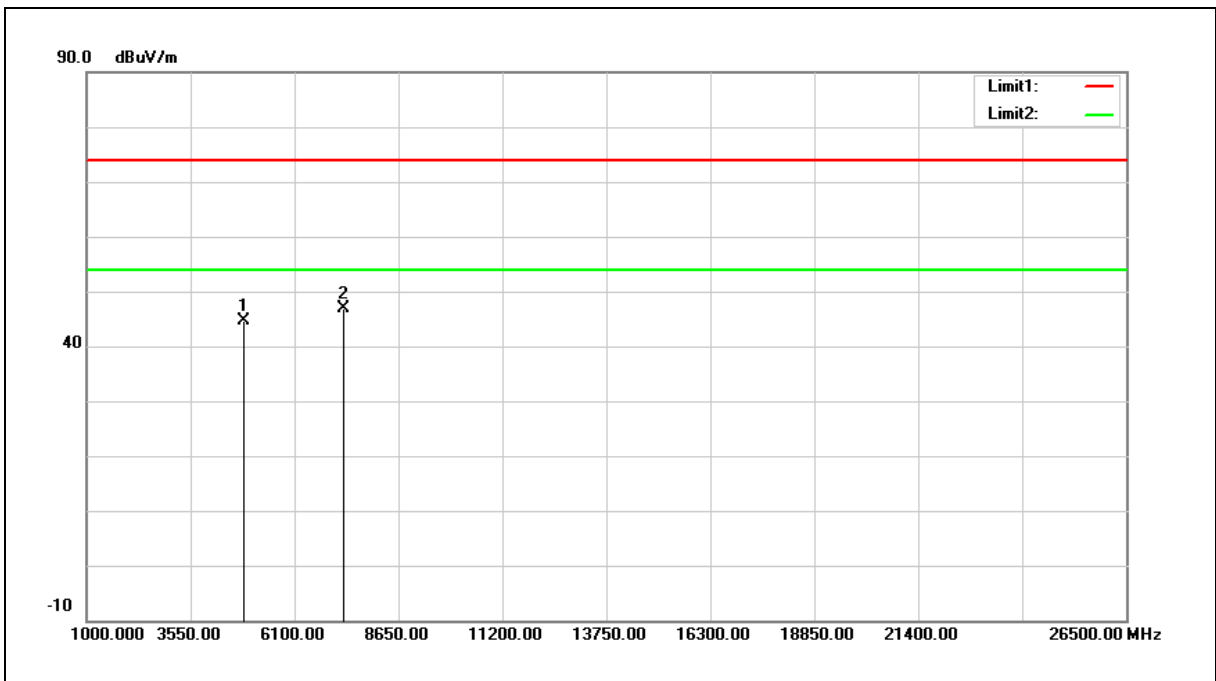

No.	Frequency (MHz)	Reading (dBuV)	Correct Factor (dB/m)	Result (dBuV/m)	Limit (dBuV/m)	Margin (dB)	Remark
1	4874.000	49.80	-5.09	44.71	74.00	-29.29	peak
2	7311.000	47.66	-0.67	46.99	74.00	-27.01	peak

- Note: 1.Result (dBuV/m) = Correct Factor (dB/m) + Reading(dBuV).
 2.Correction factor (dB/m) = Antenna Factor (dB/m) + Cable loss (dB) – Pre-Amplifier gain (dB).
 3.When the peak results are less than average limit, so not need to evaluate the average.



Standard:	FCC Part 15.247	Test Distance:	3 m
Test item:	Harmonic	Power:	AC 120 V/60 Hz
Frequency:	2462 MHz	Temp.(°C)/Hum.(%RH):	25(°C)/50%RH
Mode:	Mode 2		
Ant.Polar.:	Horizontal		

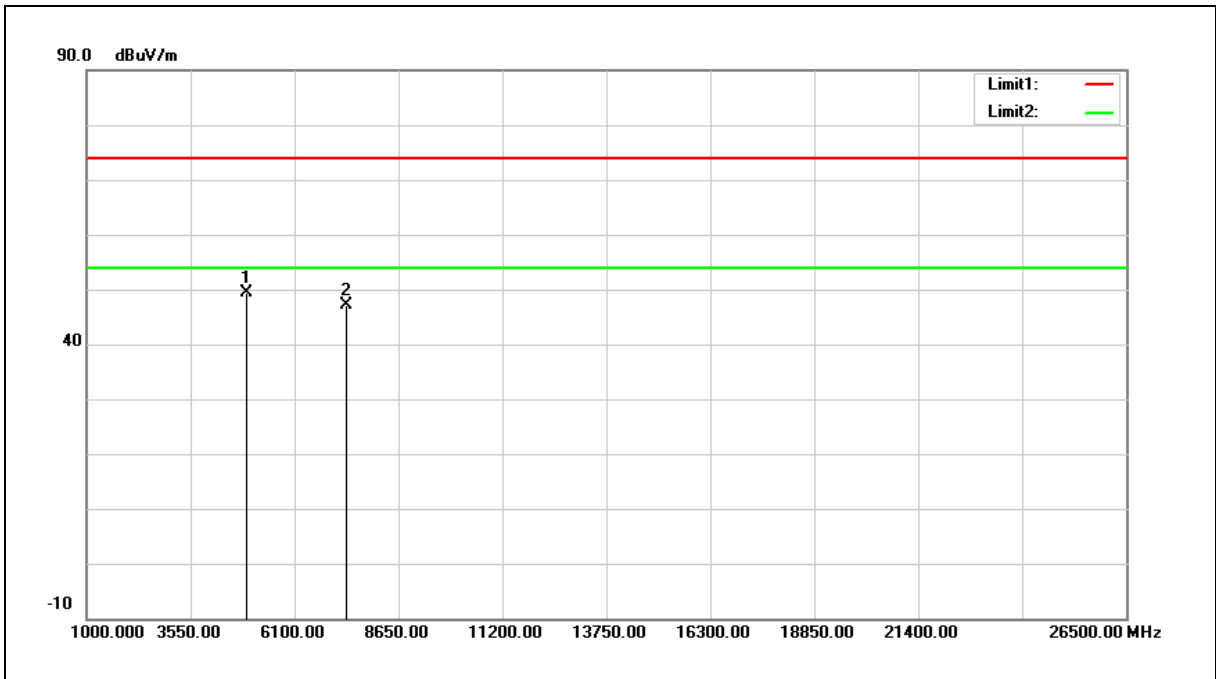

No.	Frequency (MHz)	Reading (dBuV)	Correct Factor (dB/m)	Result (dBuV/m)	Limit (dBuV/m)	Margin (dB)	Remark
1	4924.000	54.60	-5.14	49.46	74.00	-24.54	peak
2	7386.000	47.66	-0.45	47.21	74.00	-26.79	peak

Note: 1.Result (dBuV/m) = Correct Factor (dB/m) + Reading(dBuV).

2.Correction factor (dB/m) = Antenna Factor (dB/m) + Cable loss (dB) – Pre-Amplifier gain (dB).

3.When the peak results are less than average limit, so not need to evaluate the average.



Standard:	FCC Part 15.247	Test Distance:	3 m
Test item:	Harmonic	Power:	AC 120 V/60 Hz
Frequency:	2462 MHz	Temp.(°C)/Hum.(%RH):	25(°C)/50%RH
Mode:	Mode 2		
Ant.Polar.:	Vertical		

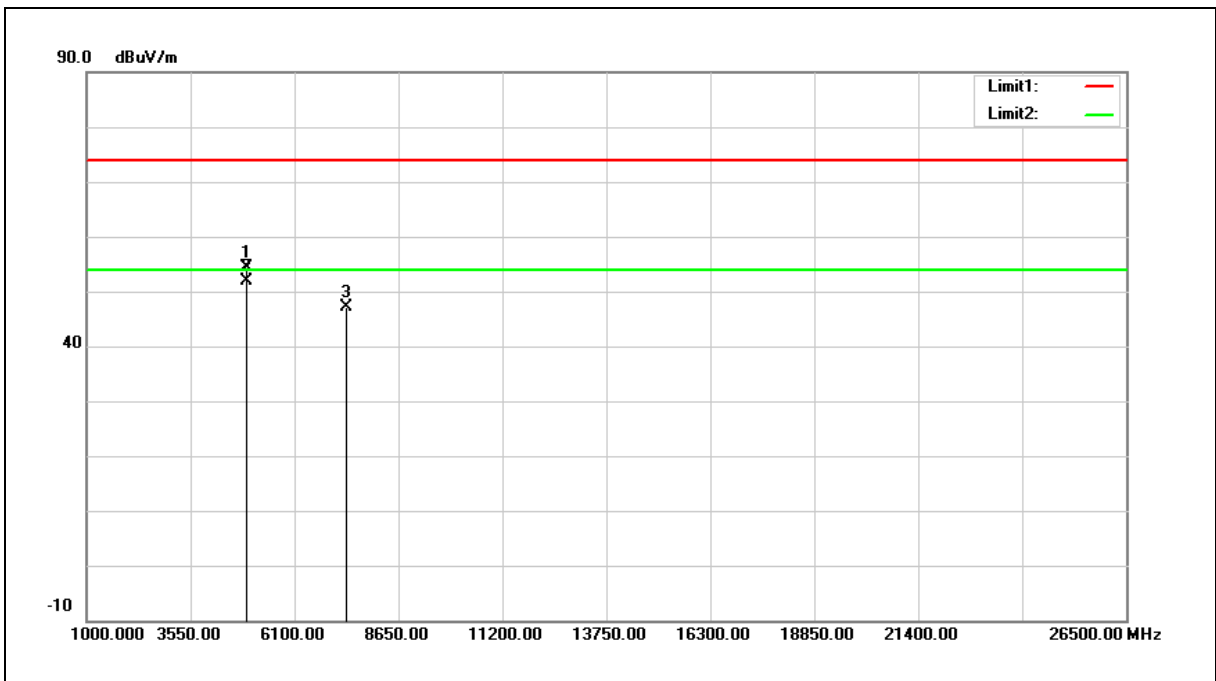

No.	Frequency (MHz)	Reading (dBuV)	Correct Factor (dB/m)	Result (dBuV/m)	Limit (dBuV/m)	Margin (dB)	Remark
1	4924.000	59.58	-5.14	54.44	74.00	-19.56	peak
2	4924.000	57.09	-5.14	51.95	54.00	-2.05	AVG
3	7386.000	47.52	-0.45	47.07	74.00	-26.93	peak

Note:1.Result (dBuV/m) = Correct Factor (dB/m) + Reading(dBuV).

2.Correction factor (dB/m) = Antenna Factor (dB/m) + Cable loss (dB) – Pre-Amplifier gain (dB).

3.When the peak results are less than average limit, so not need to evaluate the average.



Standard:	FCC Part 15.247	Test Distance:	3 m
Test item:	Harmonic	Power:	AC 120 V/60 Hz
Frequency:	2412 MHz	Temp.(°C)/Hum. (%RH):	25(°C)/50%RH
Mode:	Mode 3		
Ant.Polar.:	Horizontal		

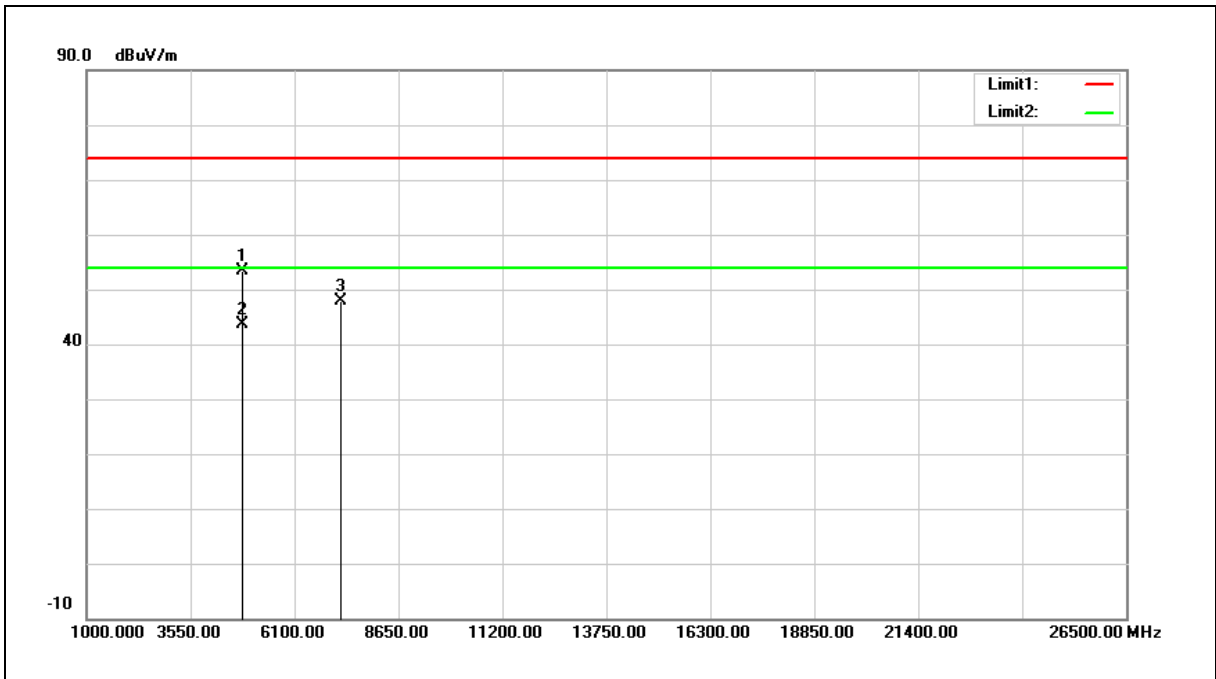

No.	Frequency (MHz)	Reading (dBuV)	Correct Factor (dB/m)	Result (dBuV/m)	Limit (dBuV/m)	Margin (dB)	Remark
1	4824.000	58.50	-5.05	53.45	74.00	-20.55	peak
2	4824.000	48.69	-5.05	43.64	54.00	-10.36	AVG
3	7236.000	48.82	-0.88	47.94	74.00	-26.06	peak

Note:1.Result (dBuV/m) = Correct Factor (dB/m) + Reading(dBuV).

2.Correction factor (dB/m) = Antenna Factor (dB/m) + Cable loss (dB) – Pre-Amplifier gain (dB).

3.When the peak results are less than average limit, so not need to evaluate the average.



Standard:	FCC Part 15.247	Test Distance:	3 m
Test item:	Harmonic	Power:	AC 120 V/60 Hz
Frequency:	2412 MHz	Temp.(°C)/Hum.(%RH):	25(°C)/50%RH
Mode:	Mode 3		
Ant.Polar.:	Vertical		

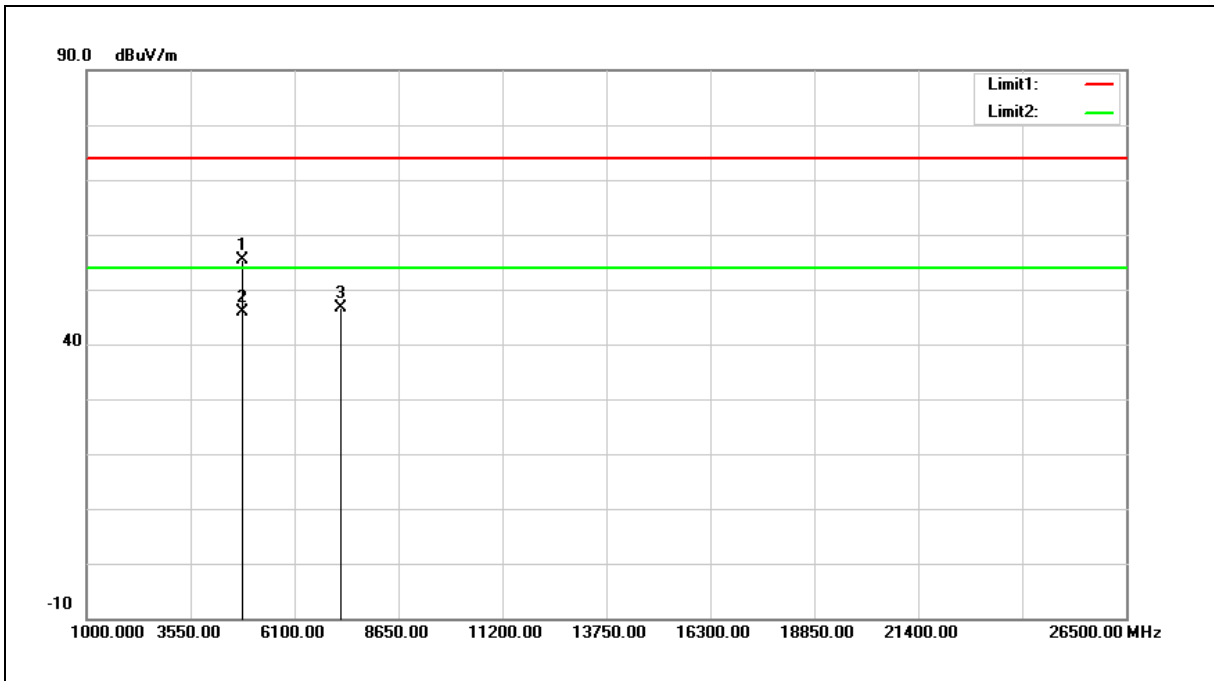

No.	Frequency (MHz)	Reading (dBuV)	Correct Factor (dB/m)	Result (dBuV/m)	Limit (dBuV/m)	Margin (dB)	Remark
1	4824.000	60.39	-5.05	55.34	74.00	-18.66	peak
2	4824.000	50.94	-5.05	45.89	54.00	-8.11	AVG
3	7236.000	47.60	-0.88	46.72	74.00	-27.28	peak

Note:1.Result (dBuV/m) = Correct Factor (dB/m) + Reading(dBuV).

2.Correction factor (dB/m) = Antenna Factor (dB/m) + Cable loss (dB) – Pre-Amplifier gain (dB).

3.When the peak results are less than average limit, so not need to evaluate the average.



Standard:	FCC Part 15.247	Test Distance:	3 m
Test item:	Harmonic	Power:	AC 120 V/60 Hz
Frequency:	2437 MHz	Temp.(°C)/Hum.(%RH):	25(°C)/50%RH
Mode:	Mode 3		
Ant.Polar.:	Horizontal		

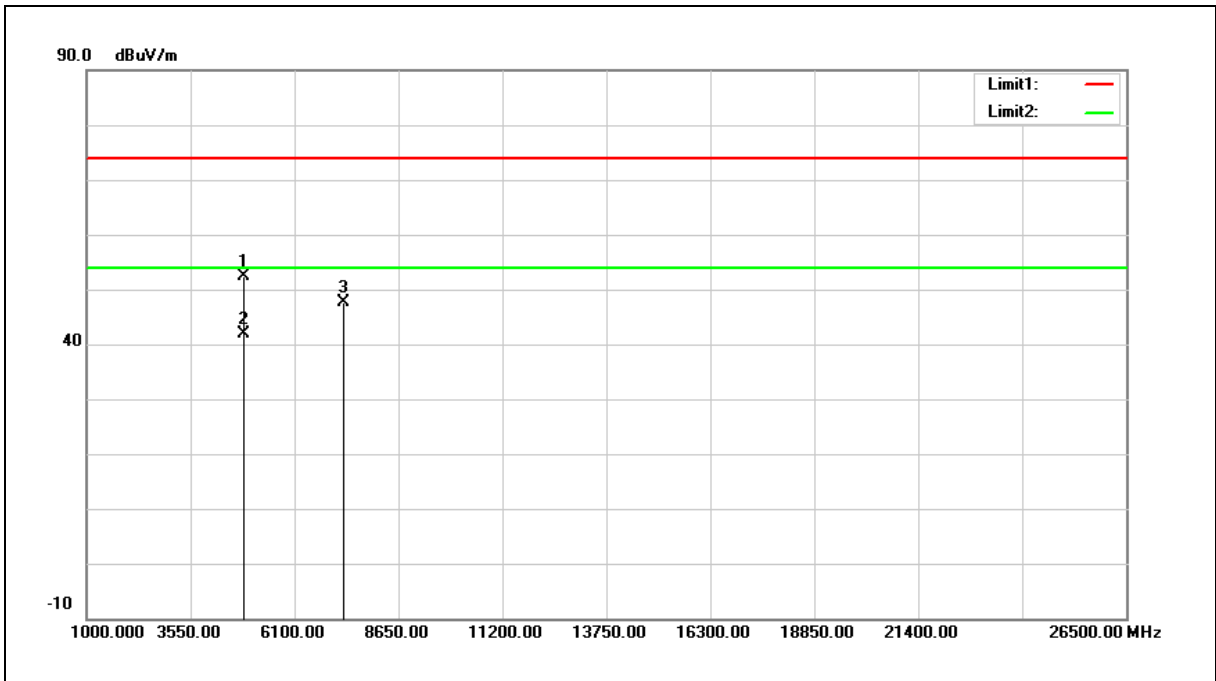

No.	Frequency (MHz)	Reading (dBuV)	Correct Factor (dB/m)	Result (dBuV/m)	Limit (dBuV/m)	Margin (dB)	Remark
1	4874.000	57.48	-5.09	52.39	74.00	-21.61	peak
2	4874.000	46.96	-5.09	41.87	54.00	-12.13	AVG
3	7311.000	48.34	-0.67	47.67	74.00	-26.33	peak

Note:1.Result (dBuV/m) = Correct Factor (dB/m) + Reading(dBuV).

2.Correction factor (dB/m) = Antenna Factor (dB/m) + Cable loss (dB) – Pre-Amplifier gain (dB).

3.When the peak results are less than average limit, so not need to evaluate the average.



Standard:	FCC Part 15.247	Test Distance:	3 m
Test item:	Harmonic	Power:	AC 120 V/60 Hz
Frequency:	2437 MHz	Temp.(°C)/Hum.(%RH):	25(°C)/50%RH
Mode:	Mode 3		
Ant.Polar.:	Vertical		

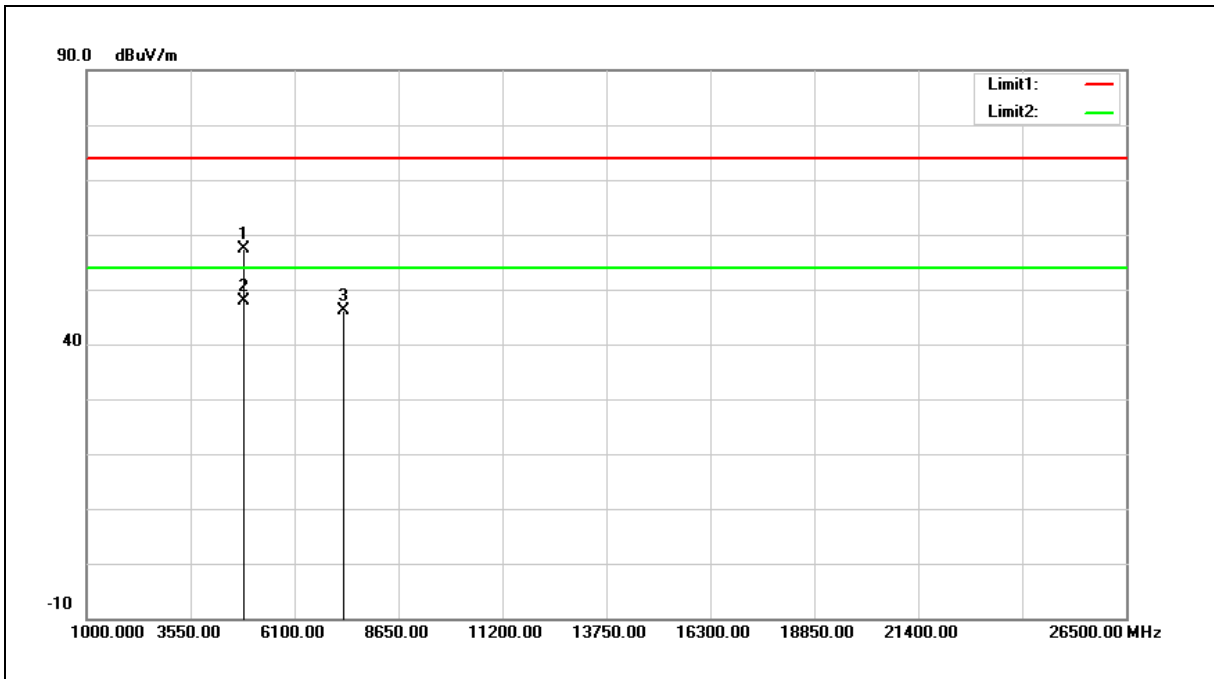

No.	Frequency (MHz)	Reading (dBuV)	Correct Factor (dB/m)	Result (dBuV/m)	Limit (dBuV/m)	Margin (dB)	Remark
1	4874.000	62.49	-5.09	57.40	74.00	-16.60	peak
2	4874.000	52.90	-5.09	47.81	54.00	-6.19	AVG
3	7311.000	46.79	-0.67	46.12	74.00	-27.88	peak

Note:1.Result (dBuV/m) = Correct Factor (dB/m) + Reading(dBuV).

2.Correction factor (dB/m) = Antenna Factor (dB/m) + Cable loss (dB) – Pre-Amplifier gain (dB).

3.When the peak results are less than average limit, so not need to evaluate the average.



Standard:	FCC Part 15.247	Test Distance:	3 m
Test item:	Harmonic	Power:	AC 120 V/60 Hz
Frequency:	2462 MHz	Temp.(°C)/Hum.(%RH):	25(°C)/50%RH
Mode:	Mode 3		
Ant.Polar.:	Horizontal		

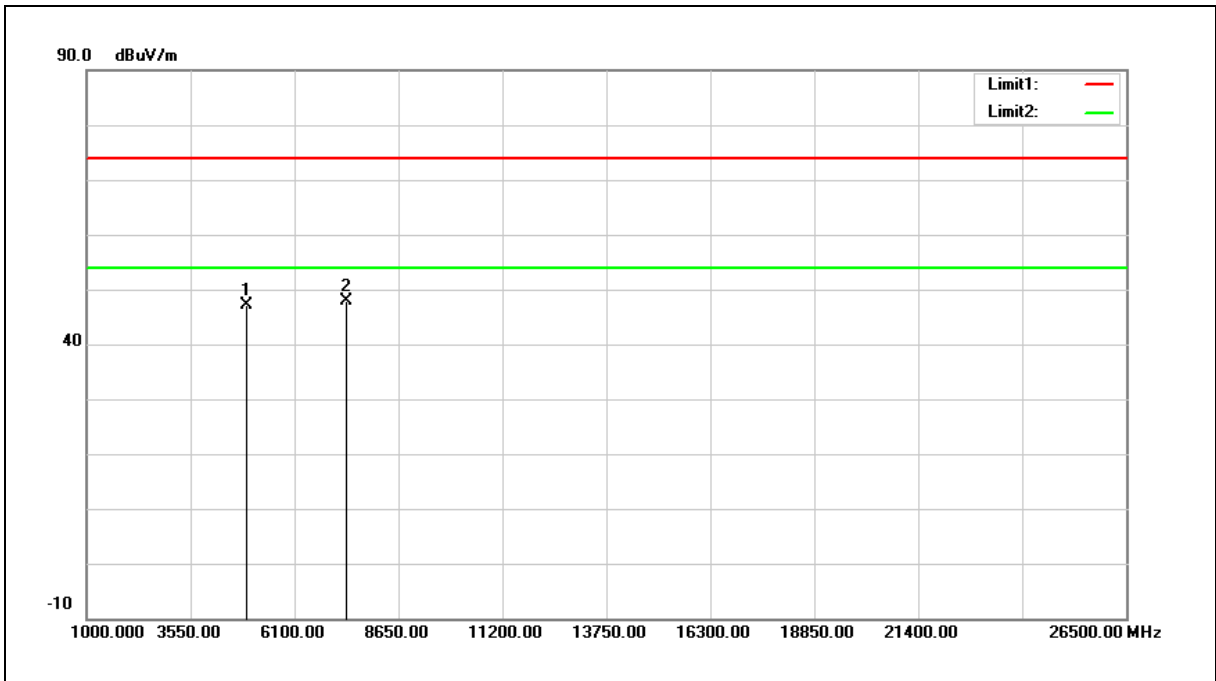

No.	Frequency (MHz)	Reading (dBuV)	Correct Factor (dB/m)	Result (dBuV/m)	Limit (dBuV/m)	Margin (dB)	Remark
1	4924.000	52.36	-5.14	47.22	74.00	-26.78	peak
2	7386.000	48.36	-0.45	47.91	74.00	-26.09	peak

- Note: 1.Result (dBuV/m) = Correct Factor (dB/m) + Reading(dBuV).
 2.Correction factor (dB/m) = Antenna Factor (dB/m) + Cable loss (dB) – Pre-Amplifier gain (dB).
 3.When the peak results are less than average limit, so not need to evaluate the average.



Standard:	FCC Part 15.247	Test Distance:	3 m
Test item:	Harmonic	Power:	AC 120 V/60 Hz
Frequency:	2462 MHz	Temp.(°C)/Hum.(%RH):	25(°C)/50%RH
Mode:	Mode 3		
Ant.Polar.:	Vertical		

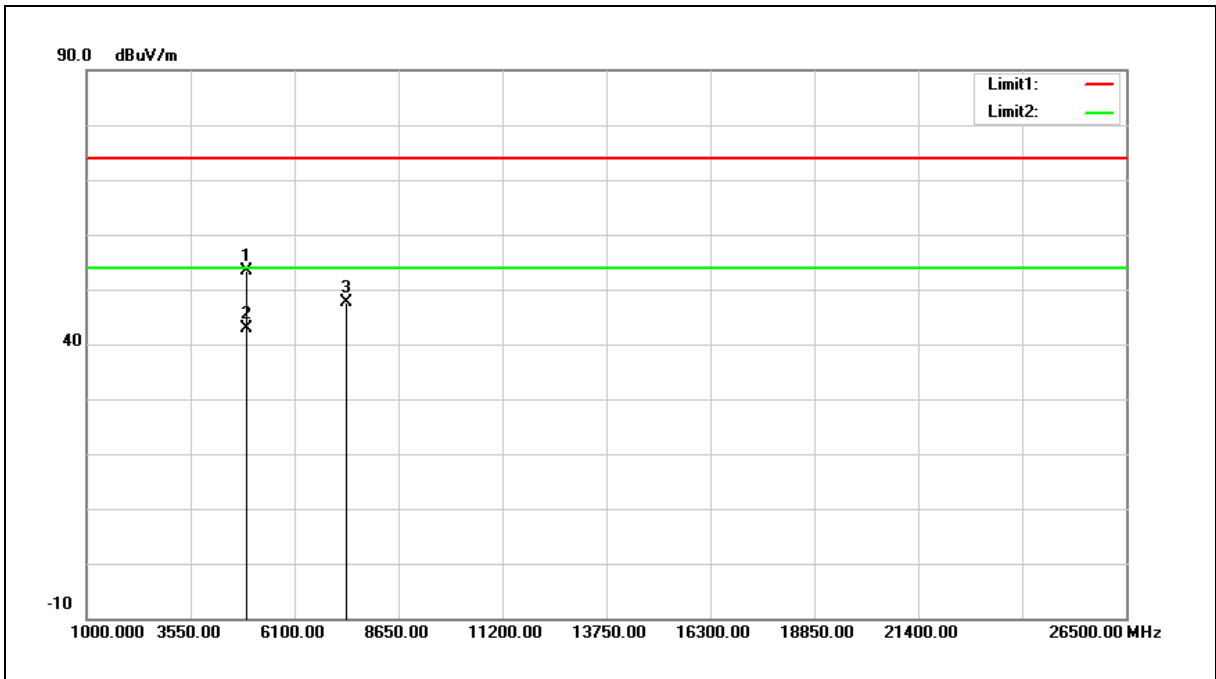

No.	Frequency (MHz)	Reading (dBuV)	Correct Factor (dB/m)	Result (dBuV/m)	Limit (dBuV/m)	Margin (dB)	Remark
1	4924.000	58.60	-5.14	53.46	74.00	-20.54	peak
2	4924.000	47.91	-5.14	42.77	54.00	-11.23	AVG
3	7386.000	48.04	-0.45	47.59	74.00	-26.41	peak

Note:1.Result (dBuV/m) = Correct Factor (dB/m) + Reading(dBuV).

2.Correction factor (dB/m) = Antenna Factor (dB/m) + Cable loss (dB) – Pre-Amplifier gain (dB).

3.When the peak results are less than average limit, so not need to evaluate the average.



Standard:	FCC Part 15.247	Test Distance:	3 m
Test item:	Harmonic	Power:	AC 120 V/60 Hz
Frequency:	2412 MHz	Temp.(°C)/Hum.(%RH):	25(°C)/50%RH
Mode:	Mode 4		
Ant.Polar.:	Horizontal		

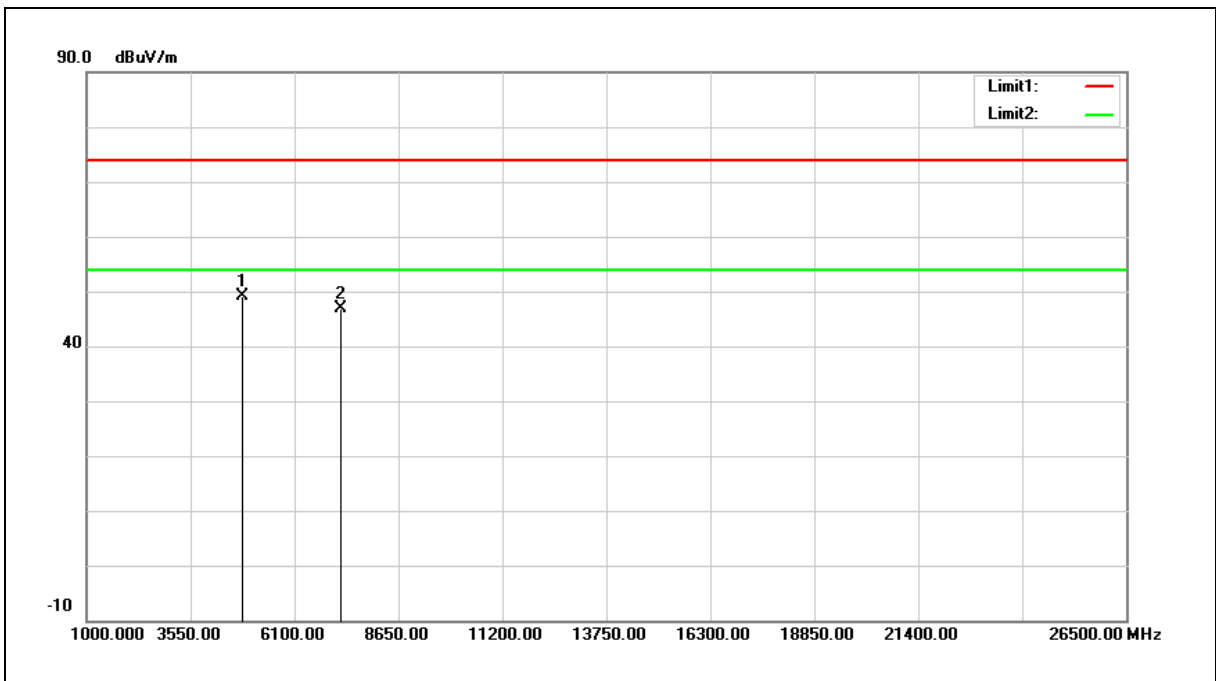

No.	Frequency (MHz)	Reading (dBuV)	Correct Factor (dB/m)	Result (dBuV/m)	Limit (dBuV/m)	Margin (dB)	Remark
1	4824.000	54.13	-5.05	49.08	74.00	-24.92	peak
2	7236.000	47.67	-0.88	46.79	74.00	-27.21	peak

Note: 1.Result (dBuV/m) = Correct Factor (dB/m) + Reading(dBuV).

2.Correction factor (dB/m) = Antenna Factor (dB/m) + Cable loss (dB) – Pre-Amplifier gain (dB).

3.When the peak results are less than average limit, so not need to evaluate the average.



Standard:	FCC Part 15.247	Test Distance:	3 m
Test item:	Harmonic	Power:	AC 120 V/60 Hz
Frequency:	2412 MHz	Temp.(°C)/Hum.(%RH):	25(°C)/50%RH
Mode:	Mode 4		
Ant.Polar.:	Vertical		

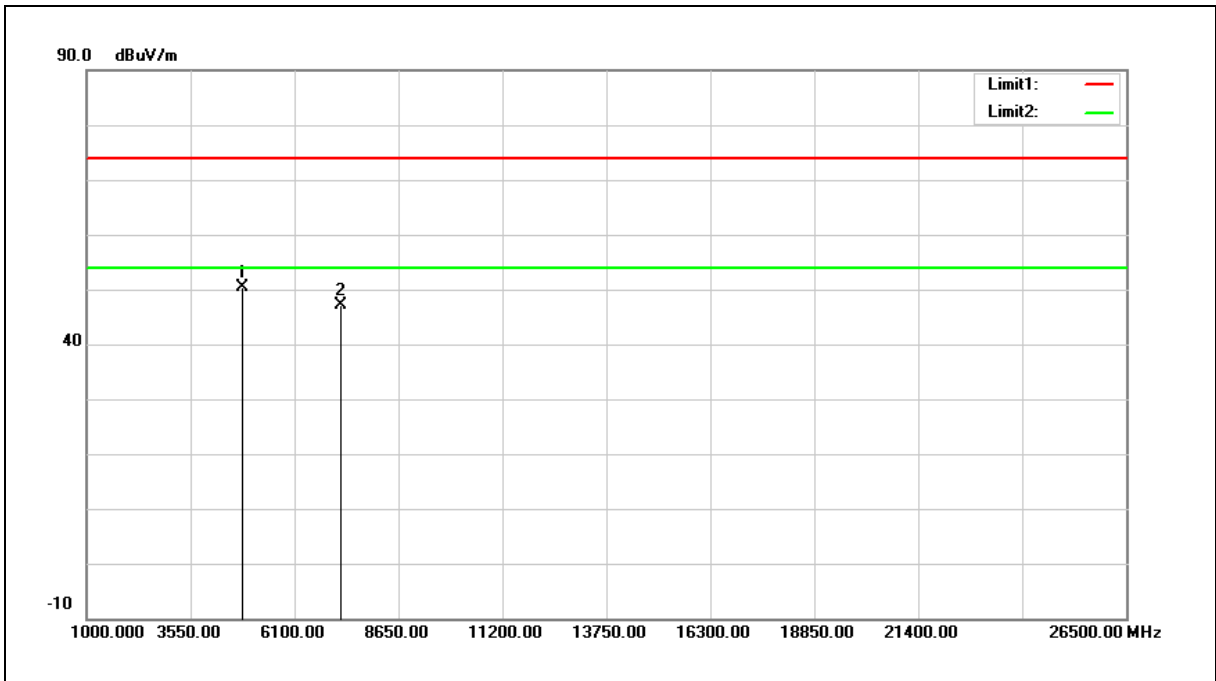

No.	Frequency (MHz)	Reading (dBuV)	Correct Factor (dB/m)	Result (dBuV/m)	Limit (dBuV/m)	Margin (dB)	Remark
1	4824.000	55.39	-5.05	50.34	74.00	-23.66	peak
2	7236.000	47.90	-0.88	47.02	74.00	-26.98	peak

- Note: 1.Result (dBuV/m) = Correct Factor (dB/m) + Reading(dBuV).
 2.Correction factor (dB/m) = Antenna Factor (dB/m) + Cable loss (dB) – Pre-Amplifier gain (dB).
 3.When the peak results are less than average limit, so not need to evaluate the average.



Standard:	FCC Part 15.247	Test Distance:	3 m
Test item:	Harmonic	Power:	AC 120 V/60 Hz
Frequency:	2437 MHz	Temp.(°C)/Hum.(%RH):	25(°C)/50%RH
Mode:	Mode 4		
Ant.Polar.:	Horizontal		

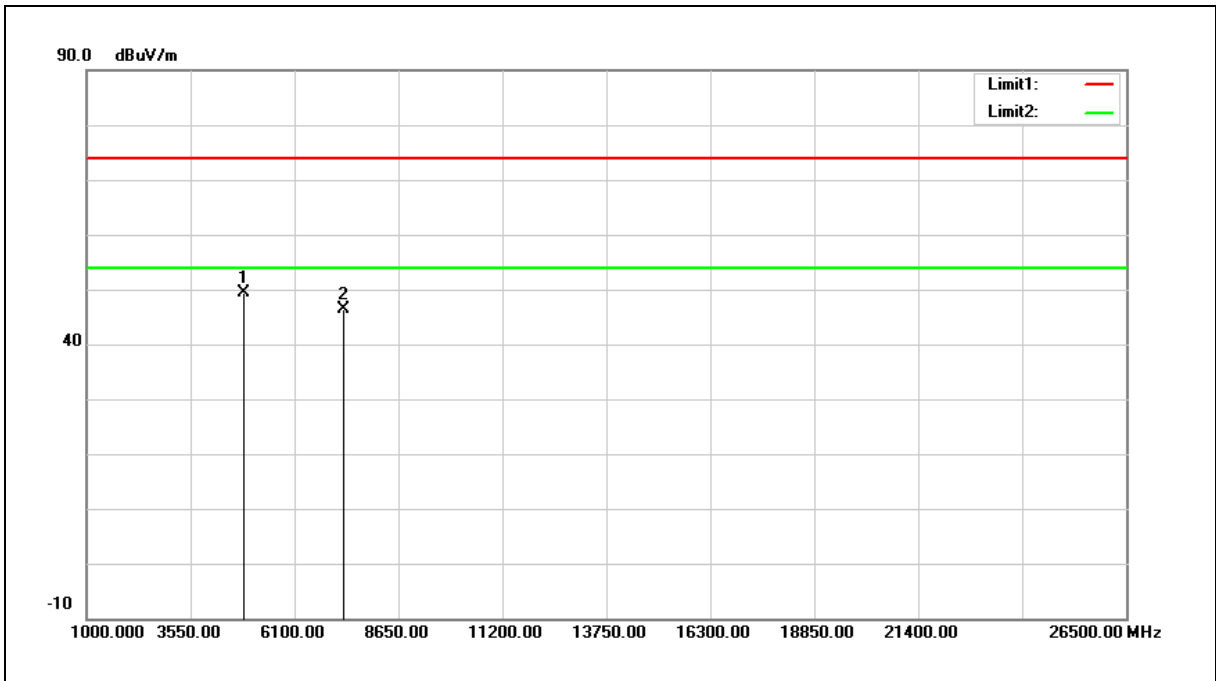

No.	Frequency (MHz)	Reading (dBuV)	Correct Factor (dB/m)	Result (dBuV/m)	Limit (dBuV/m)	Margin (dB)	Remark
1	4874.000	54.36	-5.09	49.27	74.00	-24.73	peak
2	7311.000	47.01	-0.67	46.34	74.00	-27.66	peak

- Note: 1.Result (dBuV/m) = Correct Factor (dB/m) + Reading(dBuV).
 2.Correction factor (dB/m) = Antenna Factor (dB/m) + Cable loss (dB) – Pre-Amplifier gain (dB).
 3.When the peak results are less than average limit, so not need to evaluate the average.



Standard:	FCC Part 15.247	Test Distance:	3 m
Test item:	Harmonic	Power:	AC 120 V/60 Hz
Frequency:	2437 MHz	Temp.(°C)/Hum.(%RH):	25(°C)/50%RH
Mode:	Mode 4		
Ant.Polar.:	Vertical		

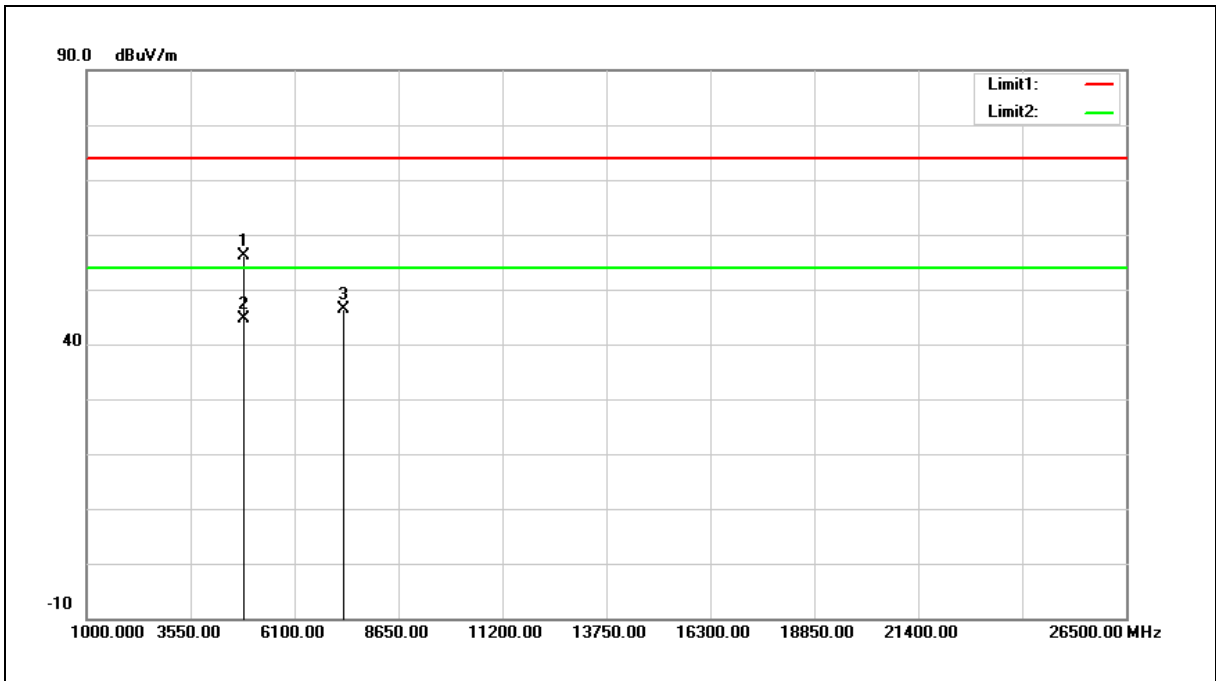

No.	Frequency (MHz)	Reading (dBuV)	Correct Factor (dB/m)	Result (dBuV/m)	Limit (dBuV/m)	Margin (dB)	Remark
1	4874.000	61.30	-5.09	56.21	74.00	-17.79	peak
2	4874.000	49.72	-5.09	44.63	54.00	-9.37	AVG
3	7311.000	47.02	-0.67	46.35	74.00	-27.65	peak

Note:1.Result (dBuV/m) = Correct Factor (dB/m) + Reading(dBuV).

2.Correction factor (dB/m) = Antenna Factor (dB/m) + Cable loss (dB) – Pre-Amplifier gain (dB).

3.When the peak results are less than average limit, so not need to evaluate the average.



Standard:	FCC Part 15.247	Test Distance:	3 m
Test item:	Harmonic	Power:	AC 120 V/60 Hz
Frequency:	2462 MHz	Temp.(°C)/Hum.(%RH):	25(°C)/50%RH
Mode:	Mode 4		
Ant.Polar.:	Horizontal		

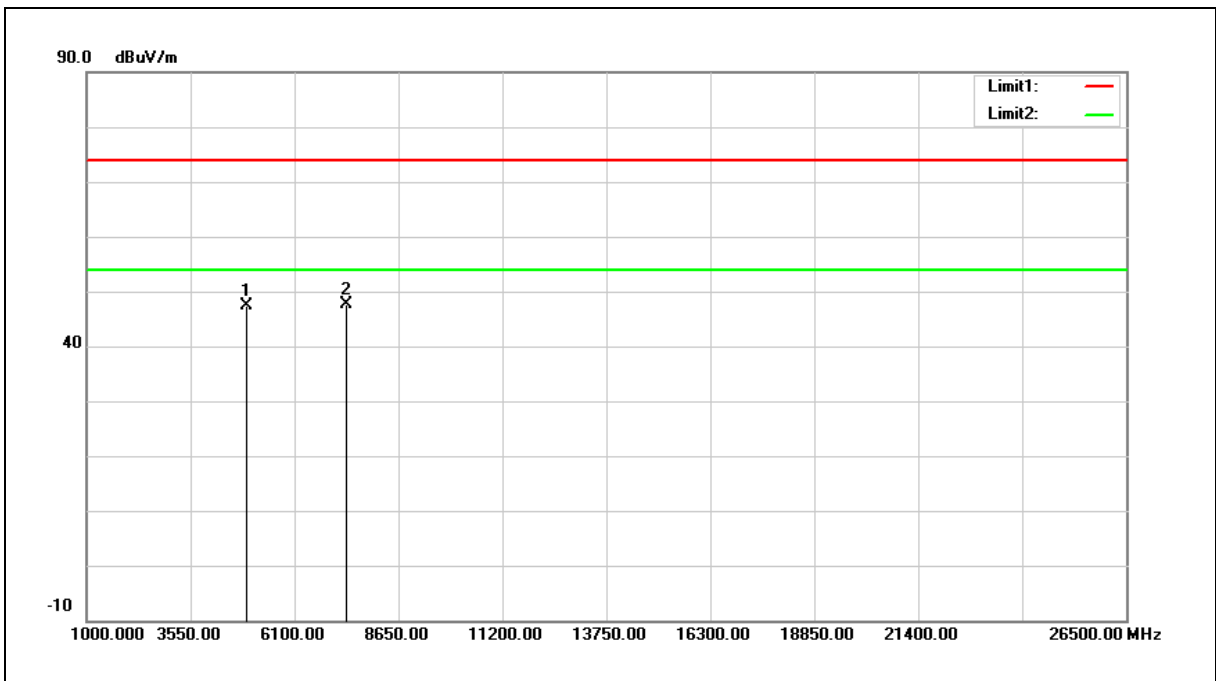

No.	Frequency (MHz)	Reading (dBuV)	Correct Factor (dB/m)	Result (dBuV/m)	Limit (dBuV/m)	Margin (dB)	Remark
1	4924.000	52.47	-5.14	47.33	74.00	-26.67	peak
2	7386.000	48.16	-0.45	47.71	74.00	-26.29	peak

- Note: 1.Result (dBuV/m) = Correct Factor (dB/m) + Reading(dBuV).
 2.Correction factor (dB/m) = Antenna Factor (dB/m) + Cable loss (dB) – Pre-Amplifier gain (dB).
 3.When the peak results are less than average limit, so not need to evaluate the average.



Standard:	FCC Part 15.247	Test Distance:	3 m
Test item:	Harmonic	Power:	AC 120 V/60 Hz
Frequency:	2462 MHz	Temp.(°C)/Hum.(%RH):	25(°C)/50%RH
Mode:	Mode 4		
Ant.Polar.:	Vertical		

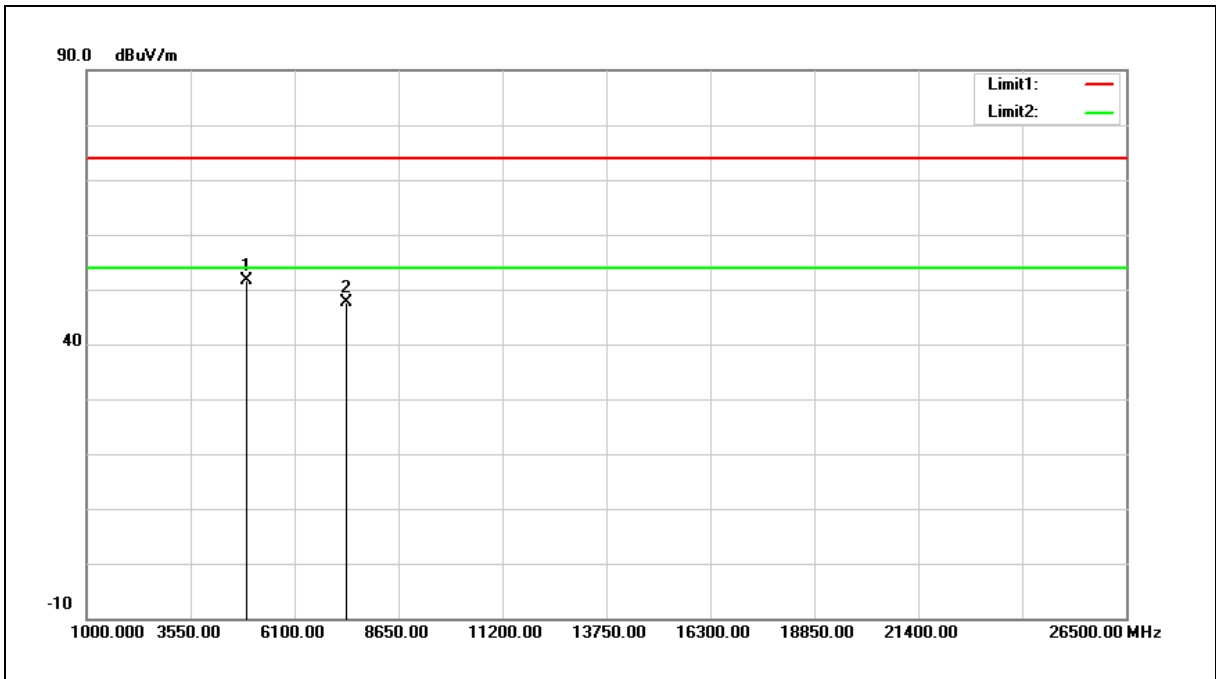

No.	Frequency (MHz)	Reading (dBuV)	Correct Factor (dB/m)	Result (dBuV/m)	Limit (dBuV/m)	Margin (dB)	Remark
1	4924.000	56.73	-5.14	51.59	74.00	-22.41	peak
2	7386.000	48.02	-0.45	47.57	74.00	-26.43	peak

Note: 1.Result (dBuV/m) = Correct Factor (dB/m) + Reading(dBuV).

2.Correction factor (dB/m) = Antenna Factor (dB/m) + Cable loss (dB) – Pre-Amplifier gain (dB).

3.When the peak results are less than average limit, so not need to evaluate the average.



Standard:	FCC Part 15.247	Test Distance:	3 m
Test item:	Harmonic	Power:	AC 120 V/60 Hz
Frequency:	2422MHz	Temp.(°C)/Hum.(%RH):	25(°C)/50%RH
Mode:	Mode 5		
Ant.Polar.:	Horizontal		

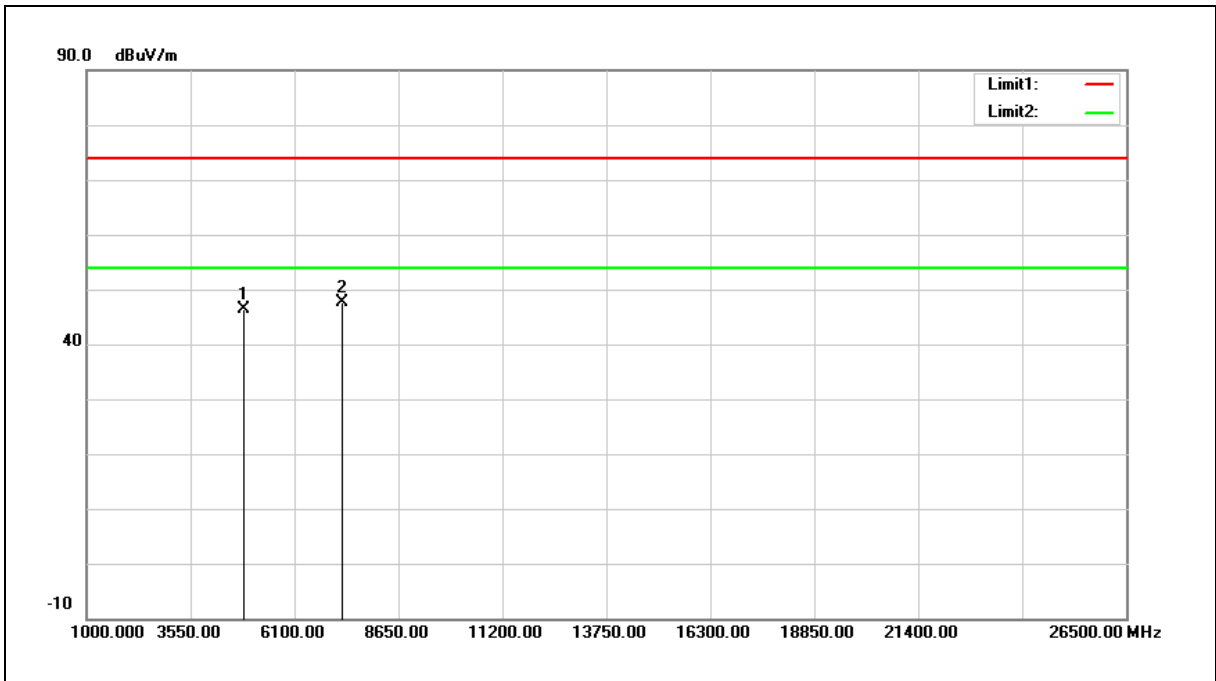

No.	Frequency (MHz)	Reading (dBuV)	Correct Factor (dB/m)	Result (dBuV/m)	Limit (dBuV/m)	Margin (dB)	Remark
1	4844.000	51.51	-5.07	46.44	74.00	-27.56	peak
2	7266.000	48.45	-0.79	47.66	74.00	-26.34	peak

- Note: 1.Result (dBuV/m) = Correct Factor (dB/m) + Reading(dBuV).
 2.Correction factor (dB/m) = Antenna Factor (dB/m) + Cable loss (dB) – Pre-Amplifier gain (dB).
 3.When the peak results are less than average limit, so not need to evaluate the average.



Standard:	FCC Part 15.247	Test Distance:	3 m
Test item:	Harmonic	Power:	AC 120 V/60 Hz
Frequency:	2422MHz	Temp.(°C)/Hum.(%RH):	25(°C)/50%RH
Mode:	Mode 5		
Ant.Polar.:	Vertical		

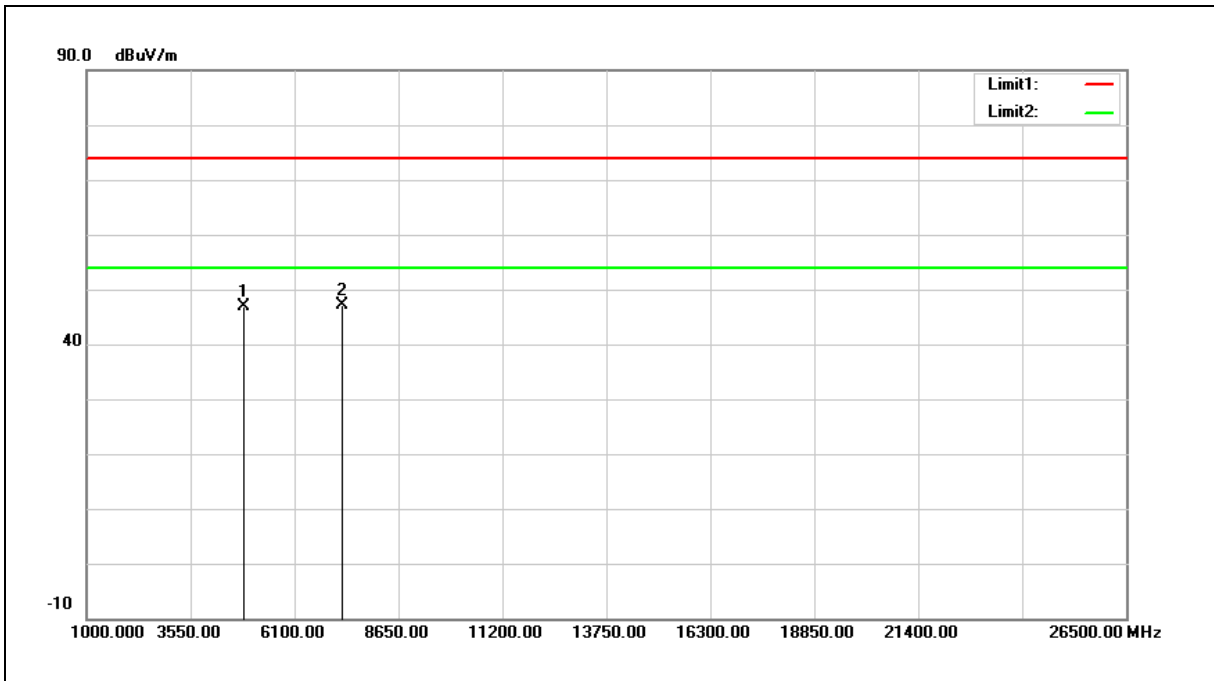

No.	Frequency (MHz)	Reading (dBuV)	Correct Factor (dB/m)	Result (dBuV/m)	Limit (dBuV/m)	Margin (dB)	Remark
1	4844.000	51.96	-5.07	46.89	74.00	-27.11	peak
2	7266.000	47.86	-0.79	47.07	74.00	-26.93	peak

- Note: 1.Result (dBuV/m) = Correct Factor (dB/m) + Reading(dBuV).
 2.Correction factor (dB/m) = Antenna Factor (dB/m) + Cable loss (dB) – Pre-Amplifier gain (dB).
 3.When the peak results are less than average limit, so not need to evaluate the average.



Standard:	FCC Part 15.247	Test Distance:	3 m
Test item:	Harmonic	Power:	AC 120 V/60 Hz
Frequency:	2437 MHz	Temp.(°C)/Hum.(%RH):	25(°C)/50%RH
Mode:	Mode 5		
Ant.Polar.:	Horizontal		

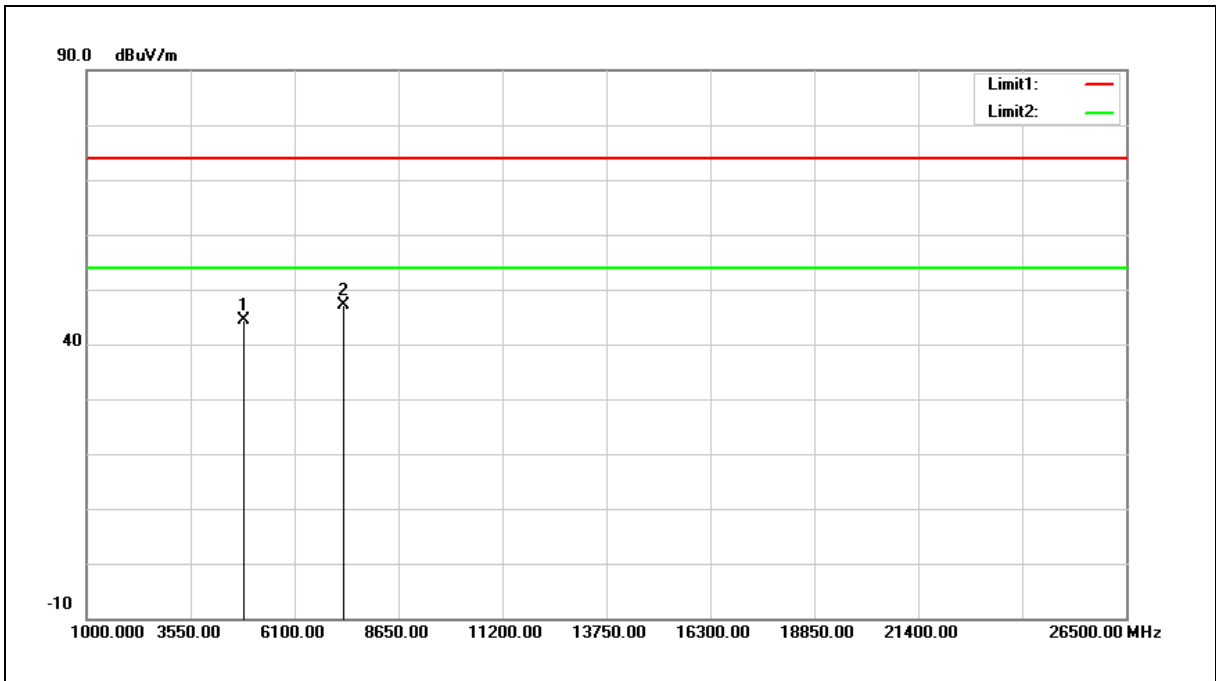

No.	Frequency (MHz)	Reading (dBuV)	Correct Factor (dB/m)	Result (dBuV/m)	Limit (dBuV/m)	Margin (dB)	Remark
1	4874.000	49.50	-5.09	44.41	74.00	-29.59	peak
2	7311.000	47.68	-0.67	47.01	74.00	-26.99	peak

- Note: 1.Result (dBuV/m) = Correct Factor (dB/m) + Reading(dBuV).
 2.Correction factor (dB/m) = Antenna Factor (dB/m) + Cable loss (dB) – Pre-Amplifier gain (dB).
 3.When the peak results are less than average limit, so not need to evaluate the average.



Standard:	FCC Part 15.247	Test Distance:	3 m
Test item:	Harmonic	Power:	AC 120 V/60 Hz
Frequency:	2437 MHz	Temp.(°C)/Hum.(%RH):	25(°C)/50%RH
Mode:	Mode 5		
Ant.Polar.:	Vertical		

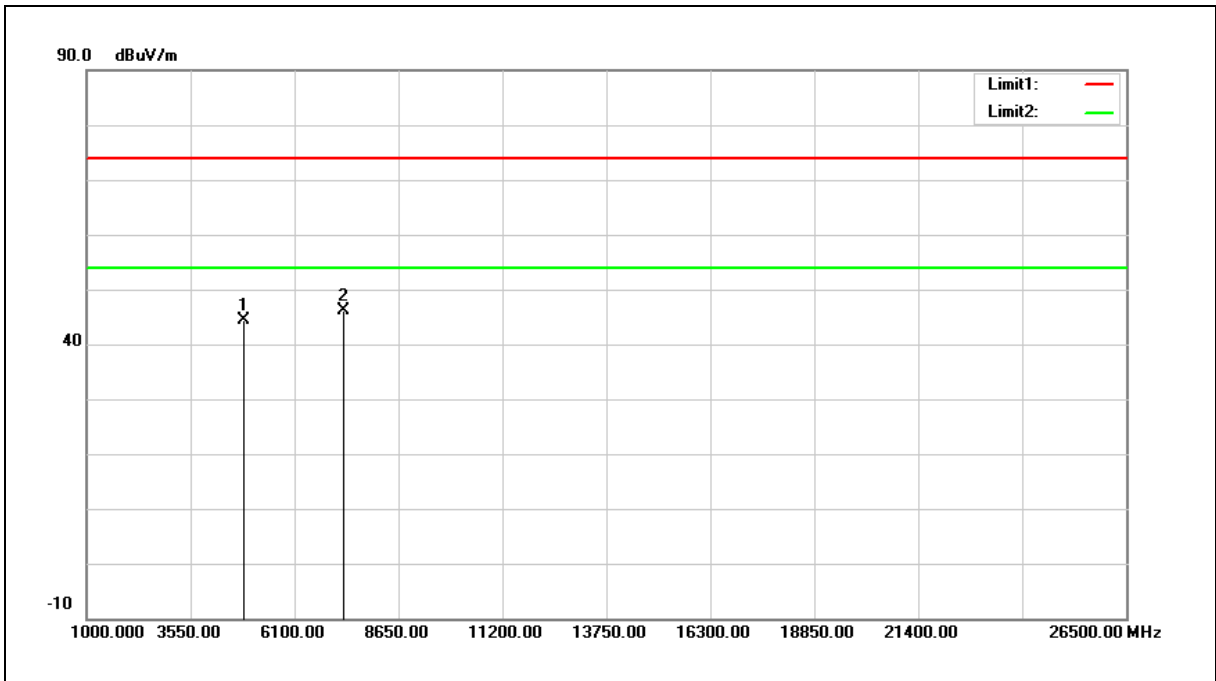

No.	Frequency (MHz)	Reading (dBuV)	Correct Factor (dB/m)	Result (dBuV/m)	Limit (dBuV/m)	Margin (dB)	Remark
1	4874.000	49.53	-5.09	44.44	74.00	-29.56	peak
2	7311.000	46.89	-0.67	46.22	74.00	-27.78	peak

- Note: 1.Result (dBuV/m) = Correct Factor (dB/m) + Reading(dBuV).
 2.Correction factor (dB/m) = Antenna Factor (dB/m) + Cable loss (dB) – Pre-Amplifier gain (dB).
 3.When the peak results are less than average limit, so not need to evaluate the average.



Standard:	FCC Part 15.247	Test Distance:	3 m
Test item:	Harmonic	Power:	AC 120 V/60 Hz
Frequency:	2452 MHz	Temp.(°C)/Hum.(%RH):	25(°C)/50%RH
Mode:	Mode 5		
Ant.Polar.:	Horizontal		

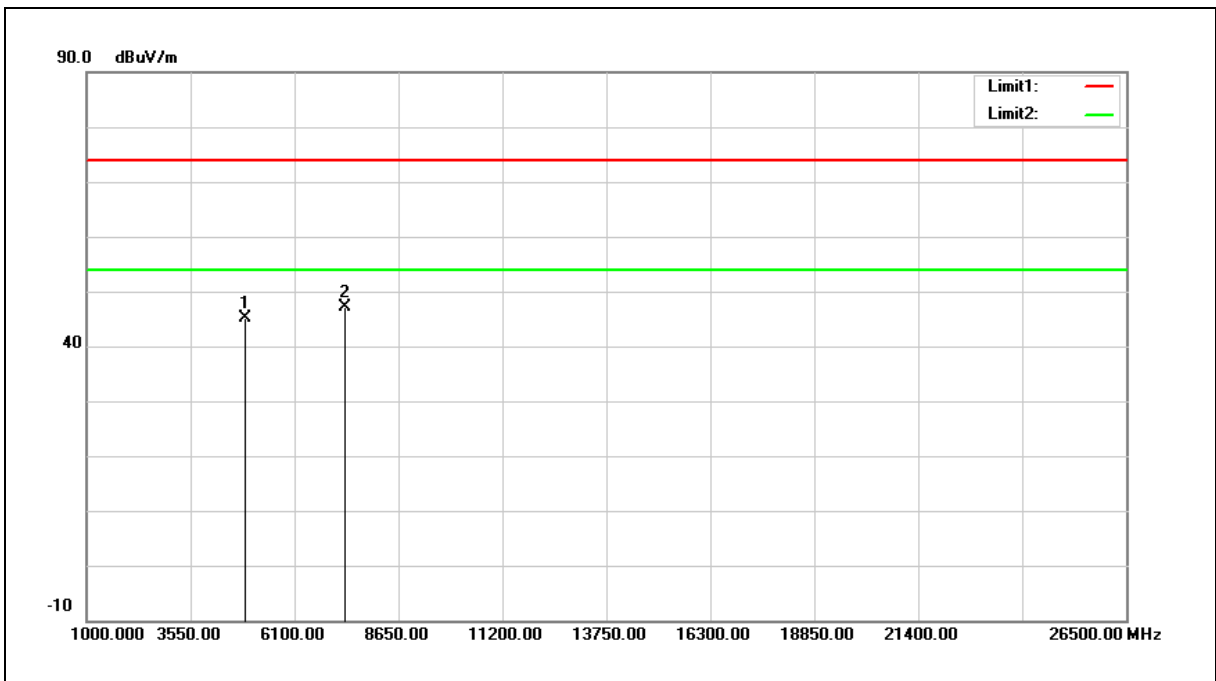

No.	Frequency (MHz)	Reading (dBuV)	Correct Factor (dB/m)	Result (dBuV/m)	Limit (dBuV/m)	Margin (dB)	Remark
1	4904.000	50.29	-5.12	45.17	74.00	-28.83	peak
2	7356.000	47.68	-0.54	47.14	74.00	-26.86	peak

- Note: 1.Result (dBuV/m) = Correct Factor (dB/m) + Reading(dBuV).
 2.Correction factor (dB/m) = Antenna Factor (dB/m) + Cable loss (dB) – Pre-Amplifier gain (dB).
 3.When the peak results are less than average limit, so not need to evaluate the average.



Standard:	FCC Part 15.247	Test Distance:	3 m
Test item:	Harmonic	Power:	AC 120 V/60 Hz
Frequency:	2452 MHz	Temp.(°C)/Hum.(%RH):	25(°C)/50%RH
Mode:	Mode 5		
Ant.Polar.:	Vertical		

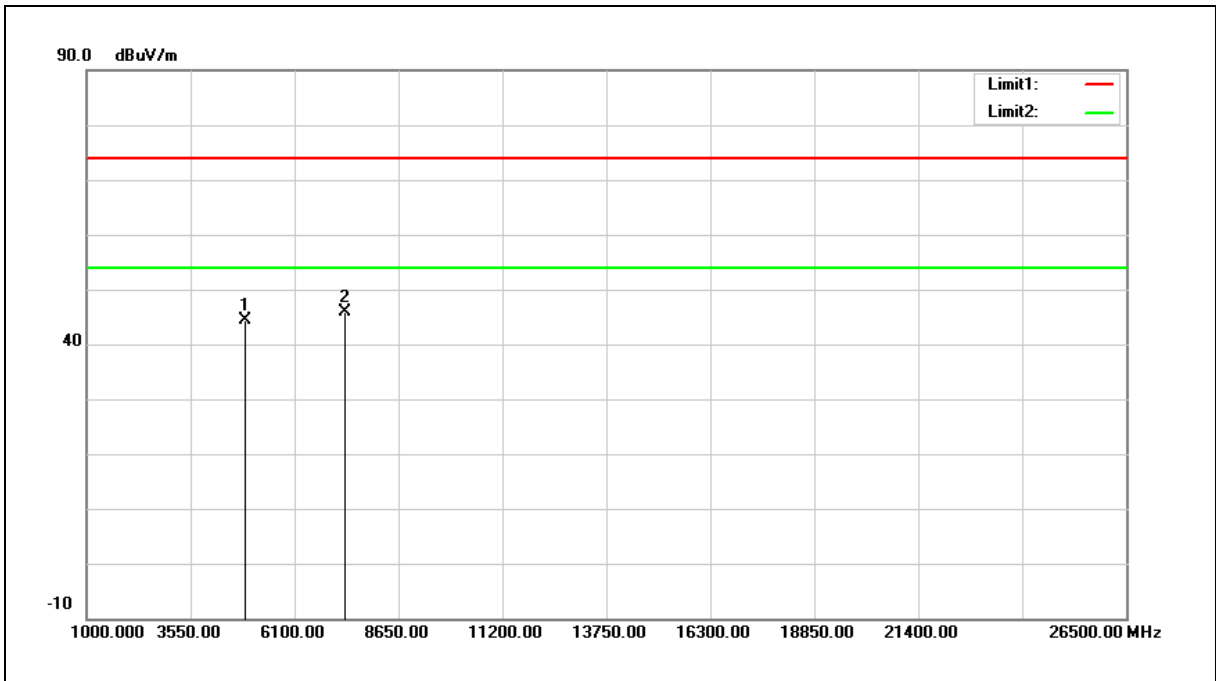

No.	Frequency (MHz)	Reading (dBuV)	Correct Factor (dB/m)	Result (dBuV/m)	Limit (dBuV/m)	Margin (dB)	Remark
1	4904.000	49.48	-5.12	44.36	74.00	-29.64	peak
2	7356.000	46.38	-0.54	45.84	74.00	-28.16	peak

Note: 1.Result (dBuV/m) = Correct Factor (dB/m) + Reading(dBuV).

2.Correction factor (dB/m) = Antenna Factor (dB/m) + Cable loss (dB) – Pre-Amplifier gain (dB).

3.When the peak results are less than average limit, so not need to evaluate the average.



Band Edge

Standard:	FCC Part 15.247	Test Distance:	3 m
Test item:	Band edge	Power:	AC 120 V/60 Hz
Frequency:	2412 MHz	Temp.(°C)/Hum.(%RH):	25(°C)/50%RH
Mode:	Mode 2		
Ant.Polar.:	Horizontal		

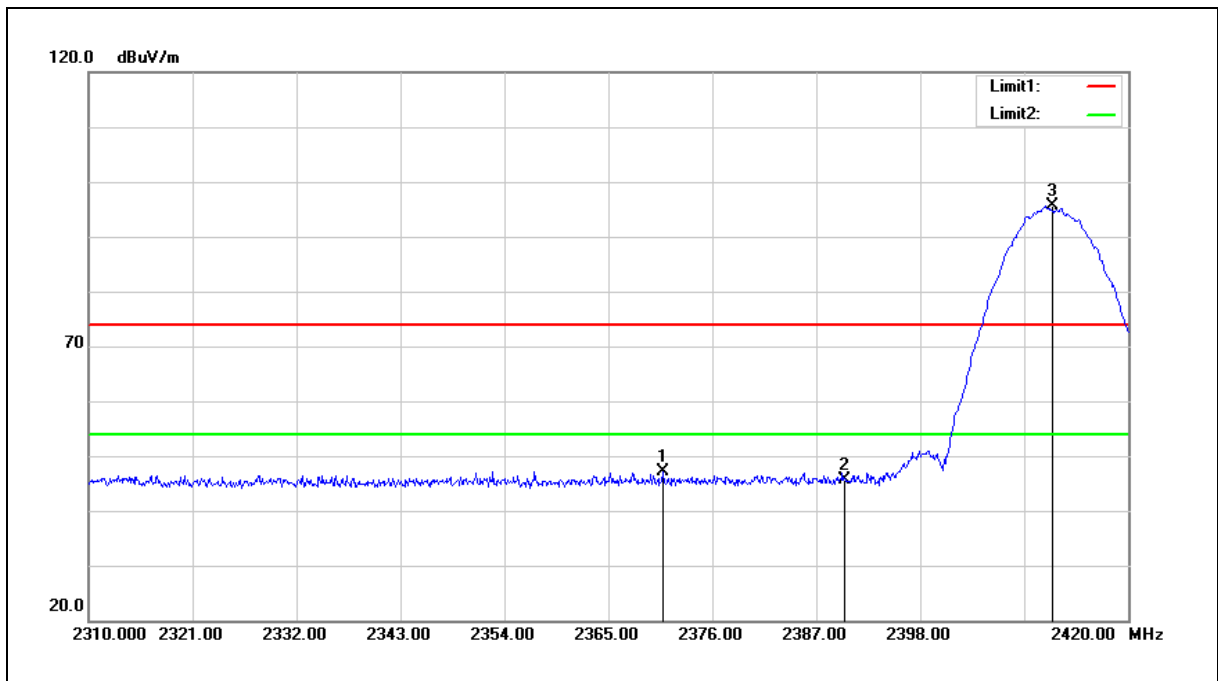

No.	Frequency (MHz)	Reading (dBuV)	Correct Factor (dB/m)	Result (dBuV/m)	Limit (dBuV/m)	Margin (dB)	Remark
1	2370.720	57.08	-9.84	47.24	74.00	-26.76	peak
2	2390.000	55.37	-9.78	45.59	74.00	-28.41	peak
3	2412.000	105.30	-9.72	95.58	74.00	21.58	peak

Note:1.Result (dBuV/m) = Correct Factor (dB/m) + Reading(dBuV).

Example: 47.24=-9.84+57.08

2.Correction factor (dB/m) = Antenna Factor (dB/m) + Cable loss (dB) – Pre-Amplifier gain (dB).

3.When the peak results are less than average limit, so not need to evaluate the average.



Standard:	FCC Part 15.247	Test Distance:	3 m
Test item:	Band edge	Power:	AC 120 V/60 Hz
Frequency:	2412 MHz	Temp.(°C)/Hum.(%RH):	25(°C)/50%RH
Mode:	Mode 2		
Ant.Polar.:	Vertical		

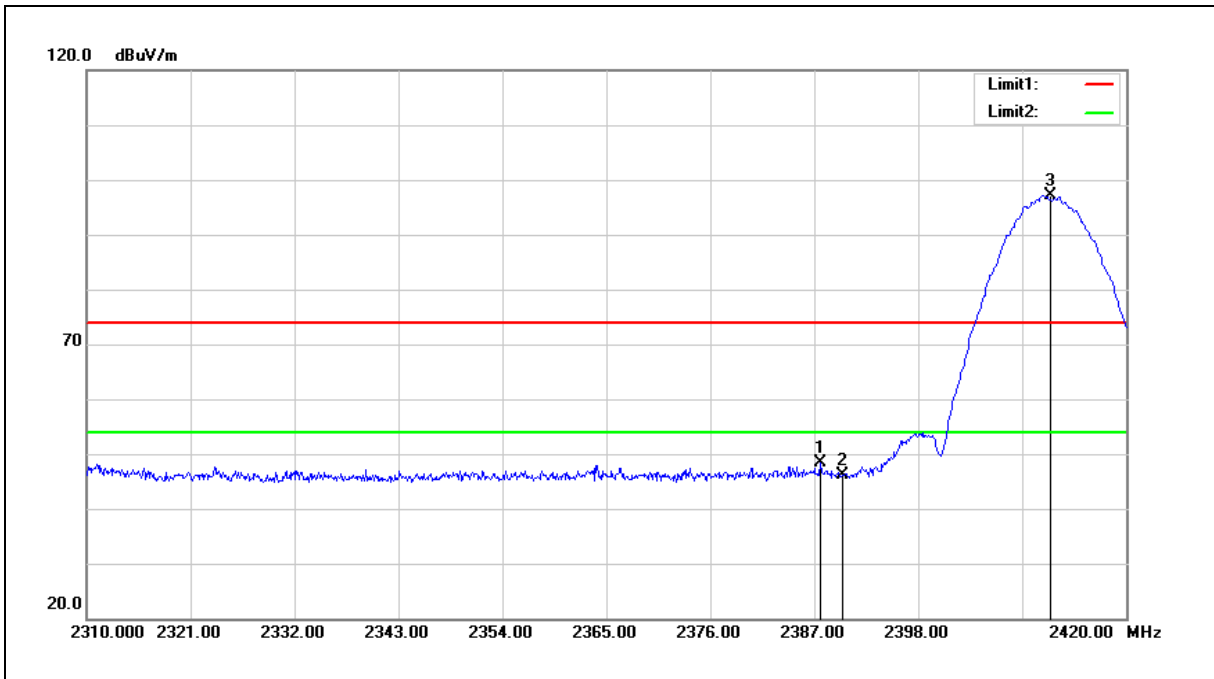

No.	Frequency (MHz)	Reading (dBuV)	Correct Factor (dB/m)	Result (dBuV/m)	Limit (dBuV/m)	Margin (dB)	Remark
1	2387.660	58.09	-9.79	48.30	74.00	-25.70	peak
2	2390.000	55.92	-9.78	46.14	74.00	-27.86	peak
3	2412.000	106.87	-9.72	97.15	74.00	23.15	peak

Note:1.Result (dBuV/m) = Correct Factor (dB/m) + Reading(dBuV).

Example: 48.30=-9.79+58.09

2.Correction factor (dB/m) = Antenna Factor (dB/m) + Cable loss (dB) – Pre-Amplifier gain (dB).

3.When the peak results are less than average limit, so not need to evaluate the average.



Standard:	FCC Part 15.247	Test Distance:	3 m
Test item:	Band edge	Power:	AC 120 V/60 Hz
Frequency:	2462 MHz	Temp.(°C)/Hum.(%RH):	25(°C)/50%RH
Mode:	Mode 2		
Ant.Polar.:	Horizontal		

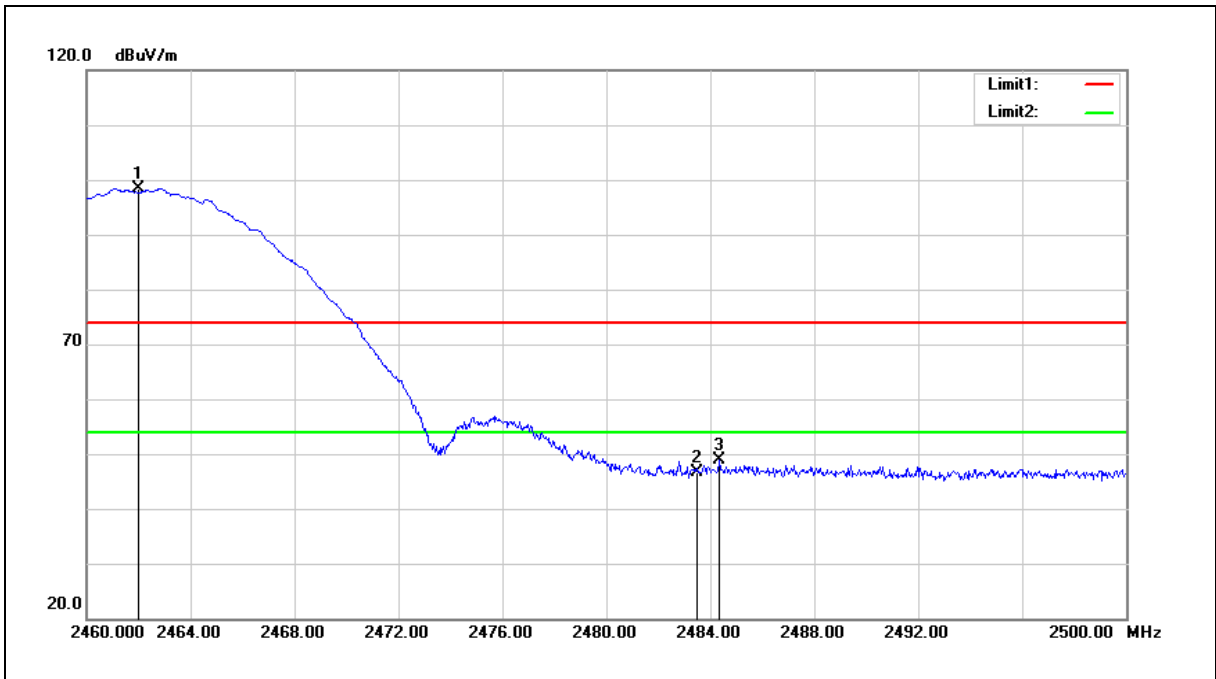

No.	Frequency (MHz)	Reading (dBuV)	Correct Factor (dB/m)	Result (dBuV/m)	Limit (dBuV/m)	Margin (dB)	Remark
1	2462.000	108.04	-9.61	98.43	74.00	24.43	peak
2	2483.500	56.12	-9.56	46.56	74.00	-27.44	peak
3	2484.360	58.45	-9.56	48.89	74.00	-25.11	peak

Note:1.Result (dBuV/m) = Correct Factor (dB/m) + Reading(dBuV).

2.Correction factor (dB/m) = Antenna Factor (dB/m) + Cable loss (dB) – Pre-Amplifier gain (dB).

3.When the peak results are less than average limit, so not need to evaluate the average.



Standard:	FCC Part 15.247	Test Distance:	3 m
Test item:	Band edge	Power:	AC 120 V/60 Hz
Frequency:	2462 MHz	Temp.(°C)/Hum.(%RH):	25(°C)/50%RH
Mode:	Mode 2		
Ant.Polar.:	Vertical		

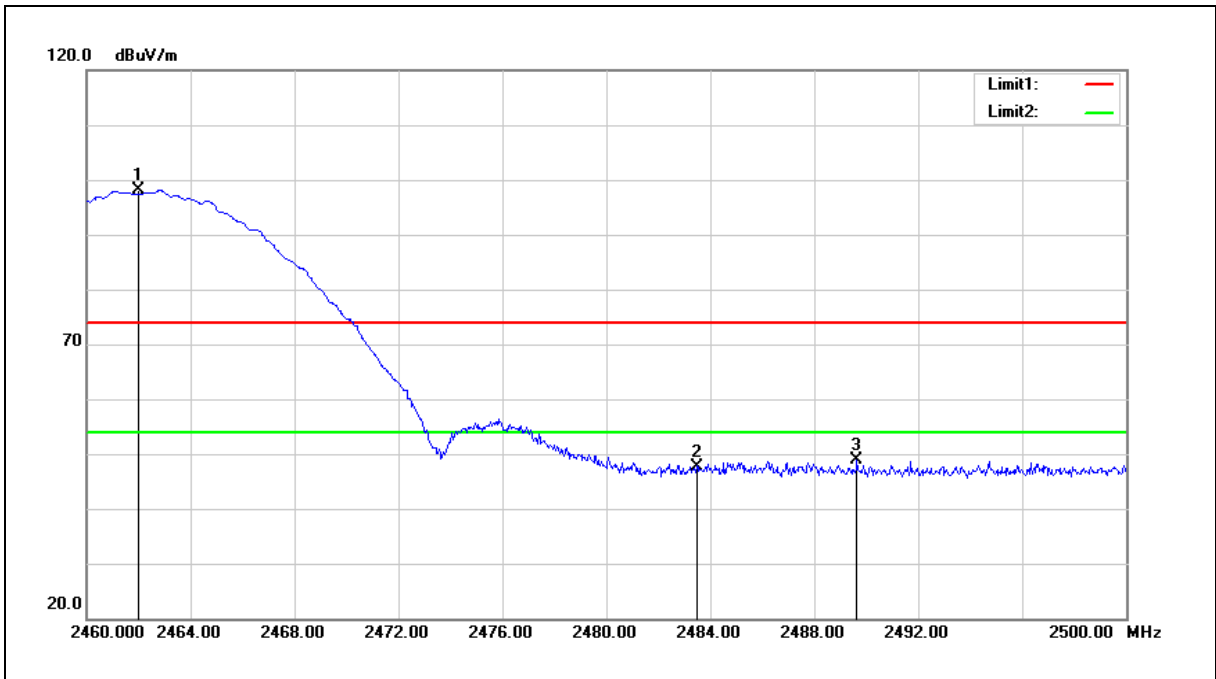

No.	Frequency (MHz)	Reading (dBuV)	Correct Factor (dB/m)	Result (dBuV/m)	Limit (dBuV/m)	Margin (dB)	Remark
1	2462.000	107.69	-9.61	98.08	74.00	24.08	peak
2	2483.500	57.11	-9.56	47.55	74.00	-26.45	peak
3	2489.640	58.31	-9.55	48.76	74.00	-25.24	peak

Note:1.Result (dBuV/m) = Correct Factor (dB/m) + Reading(dBuV).

2.Correction factor (dB/m) = Antenna Factor (dB/m) + Cable loss (dB) – Pre-Amplifier gain (dB).

3.When the peak results are less than average limit, so not need to evaluate the average.



Standard:	FCC Part 15.247	Test Distance:	3 m
Test item:	Band edge	Power:	AC 120 V/60 Hz
Frequency:	2412 MHz	Temp.(°C)/Hum.(%RH):	25(°C)/50%RH
Mode:	Mode 3		
Ant.Polar.:	Horizontal		

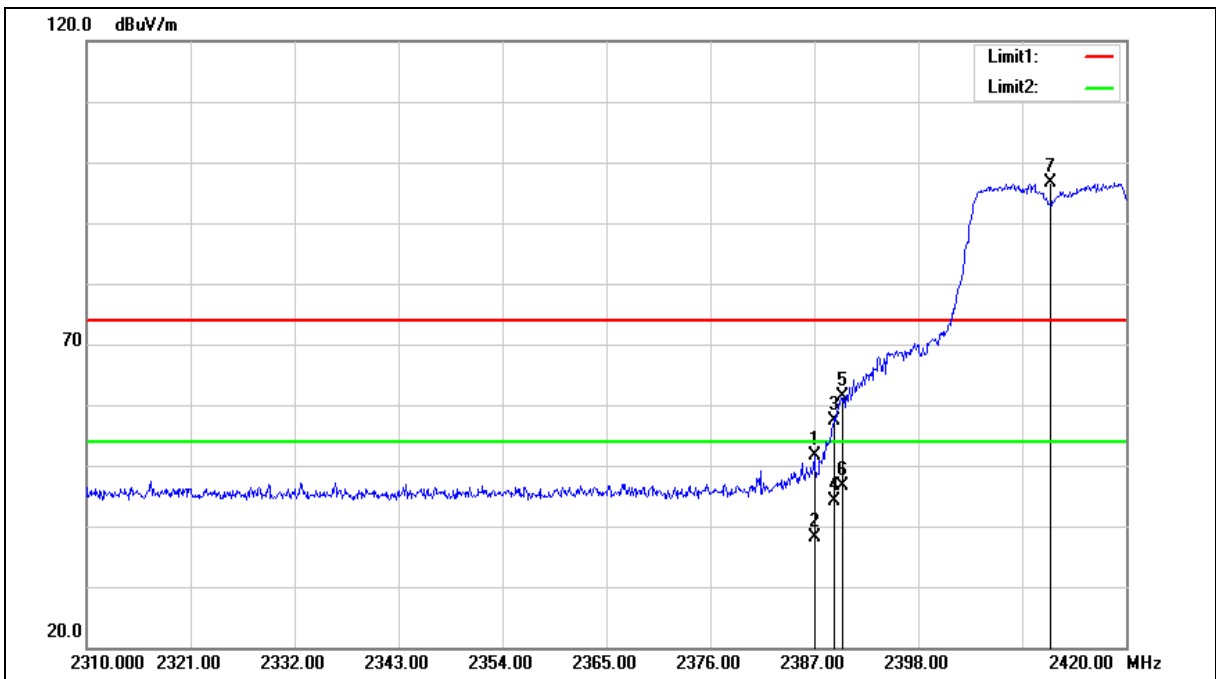

No.	Frequency (MHz)	Reading (dBuV)	Correct Factor (dB/m)	Result (dBuV/m)	Limit (dBuV/m)	Margin (dB)	Remark
1	2387.000	61.48	-9.79	51.69	74.00	-22.31	peak
2	2387.000	47.94	-9.79	38.15	54.00	-15.85	AVG
3	2389.090	67.19	-9.79	57.40	74.00	-16.60	peak
4	2389.090	53.95	-9.79	44.16	54.00	-9.84	AVG
5	2390.000	71.20	-9.78	61.42	74.00	-12.58	peak
6	2390.000	56.52	-9.78	46.74	54.00	-7.26	AVG
7	2412.000	106.33	-9.72	96.61	74.00	22.61	peak

Note:1.Result (dBuV/m) = Correct Factor (dB/m) + Reading(dBuV).

2.Correction factor (dB/m) = Antenna Factor (dB/m) + Cable loss (dB) – Pre-Amplifier gain (dB).

3.When the peak results are less than average limit, so not need to evaluate the average.



Standard:	FCC Part 15.247	Test Distance:	3 m
Test item:	Band edge	Power:	AC 120 V/60 Hz
Frequency:	2412 MHz	Temp.(°C)/Hum.(%RH):	25(°C)/50%RH
Mode:	Mode 3		
Ant.Polar.:	Vertical		

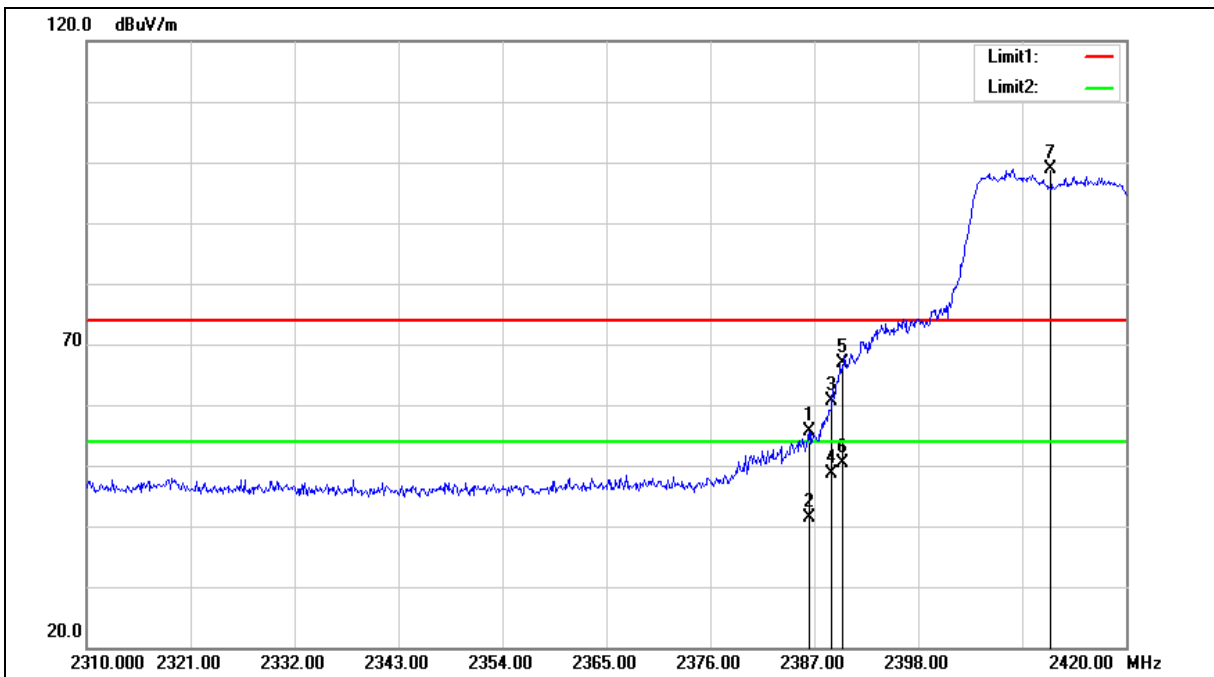

No.	Frequency (MHz)	Reading (dBuV)	Correct Factor (dB/m)	Result (dBuV/m)	Limit (dBuV/m)	Margin (dB)	Remark
1	2386.450	65.35	-9.79	55.56	74.00	-18.44	peak
2	2386.450	51.09	-9.79	41.30	54.00	-12.70	AVG
3	2388.870	70.53	-9.79	60.74	74.00	-13.26	peak
4	2388.870	58.47	-9.79	48.68	54.00	-5.32	AVG
5	2390.000	76.66	-9.78	66.88	74.00	-7.12	peak
6	2390.000	60.15	-9.78	50.37	54.00	-3.63	AVG
7	2412.000	108.52	-9.72	98.80	74.00	24.80	peak

Note:1.Result (dBuV/m) = Correct Factor (dB/m) + Reading(dBuV).

2.Correction factor (dB/m) = Antenna Factor (dB/m) + Cable loss (dB) – Pre-Amplifier gain (dB).

3.When the peak results are less than average limit, so not need to evaluate the average.



Standard:	FCC Part 15.247	Test Distance:	3 m
Test item:	Band edge	Power:	AC 120 V/60 Hz
Frequency:	2462 MHz	Temp.(°C)/Hum.(%RH):	25(°C)/50%RH
Mode:	Mode 3		
Ant.Polar.:	Horizontal		

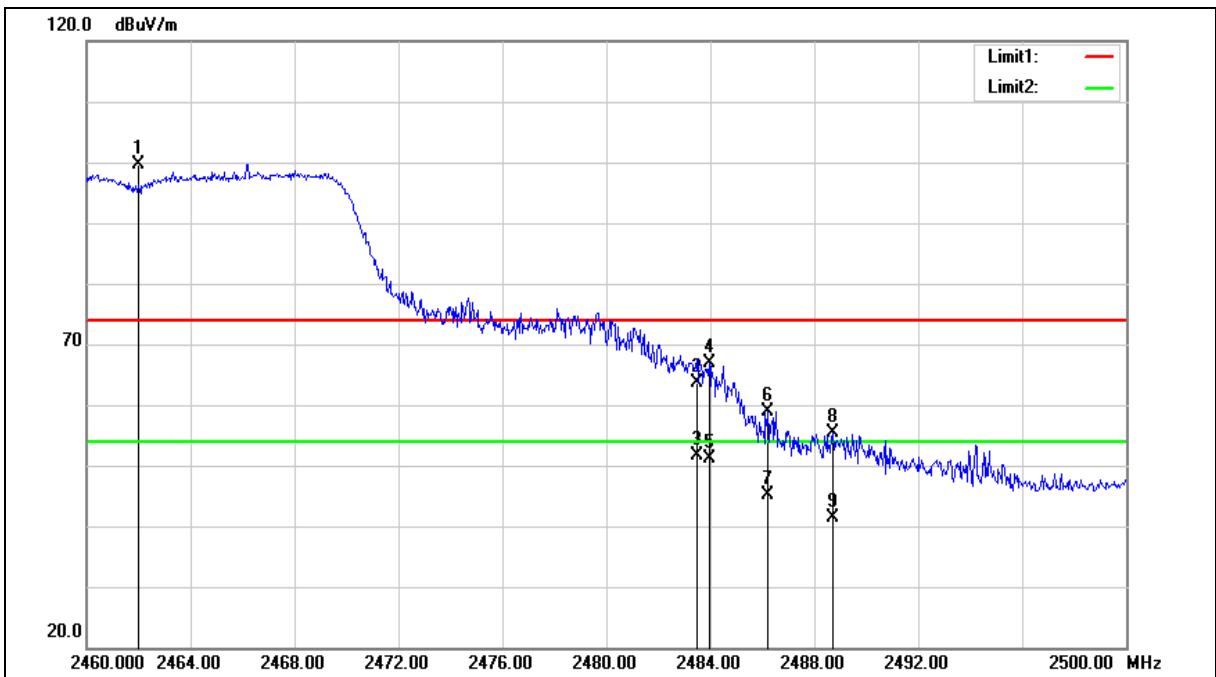

No.	Frequency (MHz)	Reading (dBuV)	Correct Factor (dB/m)	Result (dBuV/m)	Limit (dBuV/m)	Margin (dB)	Remark
1	2462.000	109.16	-9.61	99.55	74.00	25.55	peak
2	2483.500	73.22	-9.56	63.66	74.00	-10.34	peak
3	2483.500	61.28	-9.56	51.72	54.00	-2.28	AVG
4	2483.960	76.36	-9.56	66.80	74.00	-7.20	peak
5	2483.960	60.67	-9.56	51.11	54.00	-2.89	AVG
6	2486.200	68.53	-9.56	58.97	74.00	-15.03	peak
7	2486.200	54.65	-9.56	45.09	54.00	-8.91	AVG
8	2488.720	64.86	-9.56	55.30	74.00	-18.70	peak
9	2488.720	51.00	-9.56	41.44	54.00	-12.56	AVG

Note:1.Result (dBuV/m) = Correct Factor (dB/m) + Reading(dBuV).

2.Correction factor (dB/m) = Antenna Factor (dB/m) + Cable loss (dB) – Pre-Amplifier gain (dB).

3.When the peak results are less than average limit, so not need to evaluate the average.



Standard:	FCC Part 15.247	Test Distance:	3 m
Test item:	Band edge	Power:	AC 120 V/60 Hz
Frequency:	2462 MHz	Temp.(°C)/Hum.(%RH):	25(°C)/50%RH
Mode:	Mode 3		
Ant.Polar.:	Vertical		

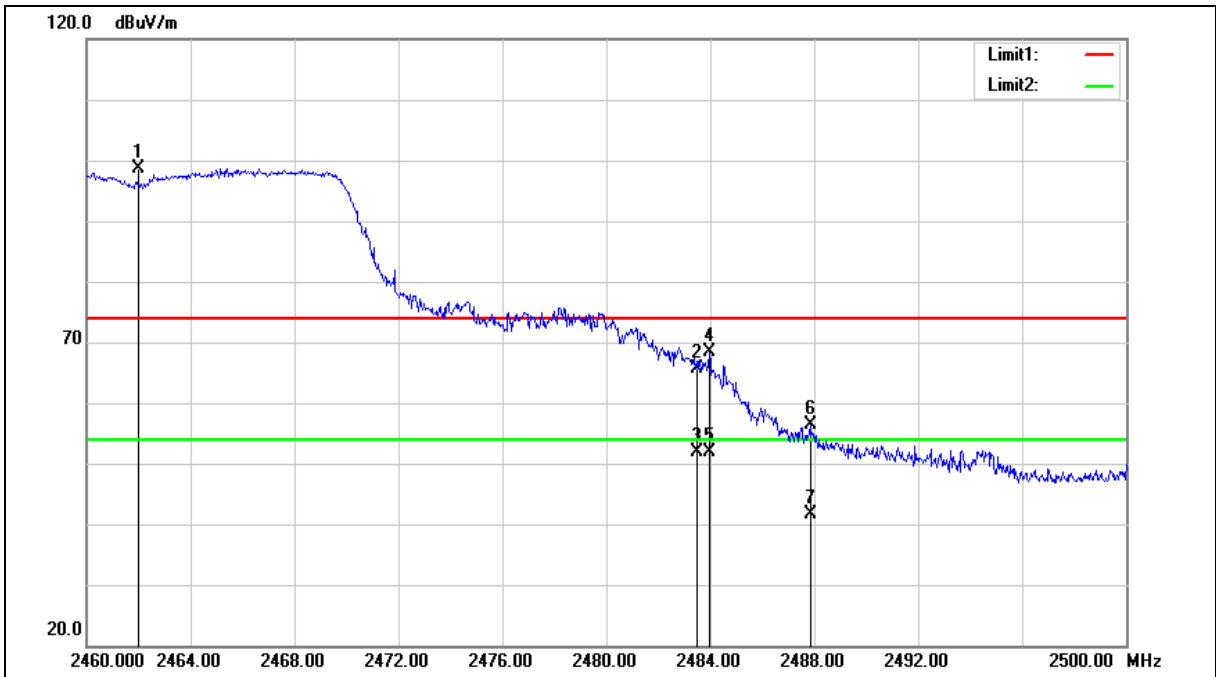

No.	Frequency (MHz)	Reading (dBuV)	Correct Factor (dB/m)	Result (dBuV/m)	Limit (dBuV/m)	Margin (dB)	Remark
1	2462.000	108.36	-9.61	98.75	74.00	24.75	peak
2	2483.500	75.12	-9.56	65.56	74.00	-8.44	peak
3	2483.500	61.39	-9.56	51.83	54.00	-2.17	AVG
4	2483.960	77.89	-9.56	68.33	74.00	-5.67	peak
5	2483.960	61.51	-9.56	51.95	54.00	-2.05	AVG
6	2487.840	65.83	-9.56	56.27	74.00	-17.73	peak
7	2487.840	51.12	-9.56	41.56	54.00	-12.44	AVG

Note:1.Result (dBuV/m) = Correct Factor (dB/m) + Reading(dBuV).

2.Correction factor (dB/m) = Antenna Factor (dB/m) + Cable loss (dB) – Pre-Amplifier gain (dB).

3.When the peak results are less than average limit, so not need to evaluate the average.



Standard:	FCC Part 15.247	Test Distance:	3 m
Test item:	Band edge	Power:	AC 120 V/60 Hz
Frequency:	2412 MHz	Temp.(°C)/Hum.(%RH):	25(°C)/50%RH
Mode:	Mode 4		
Ant.Polar.:	Horizontal		

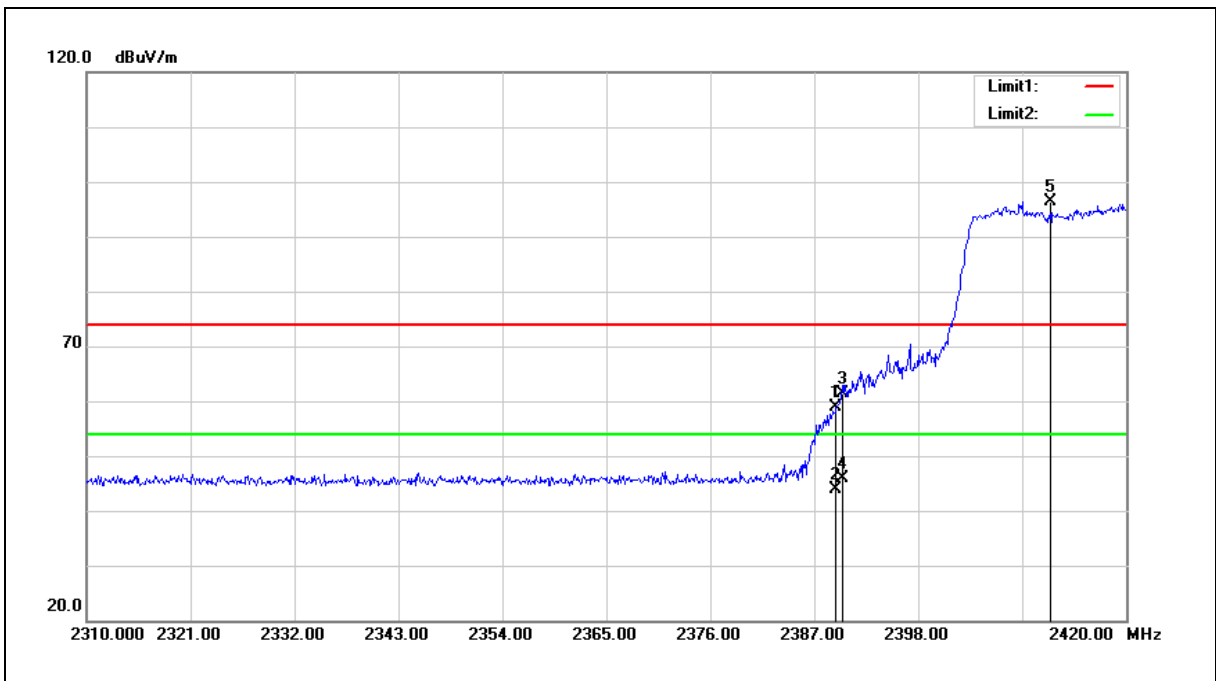

No.	Frequency (MHz)	Reading (dBuV)	Correct Factor (dB/m)	Result (dBuV/m)	Limit (dBuV/m)	Margin (dB)	Remark
1	2389.310	68.55	-9.79	58.76	74.00	-15.24	peak
2	2389.310	53.64	-9.79	43.85	54.00	-10.15	AVG
3	2390.000	71.19	-9.78	61.41	74.00	-12.59	peak
4	2390.000	55.69	-9.78	45.91	54.00	-8.09	AVG
5	2412.000	106.03	-9.72	96.31	74.00	22.31	peak

Note:1.Result (dBuV/m) = Correct Factor (dB/m) + Reading(dBuV).

2.Correction factor (dB/m) = Antenna Factor (dB/m) + Cable loss (dB) – Pre-Amplifier gain (dB).

3.When the peak results are less than average limit, so not need to evaluate the average.



Standard:	FCC Part 15.247	Test Distance:	3 m
Test item:	Band edge	Power:	AC 120 V/60 Hz
Frequency:	2412 MHz	Temp.(°C)/Hum.(%RH):	25(°C)/50%RH
Mode:	Mode 4		
Ant.Polar.:	Vertical		

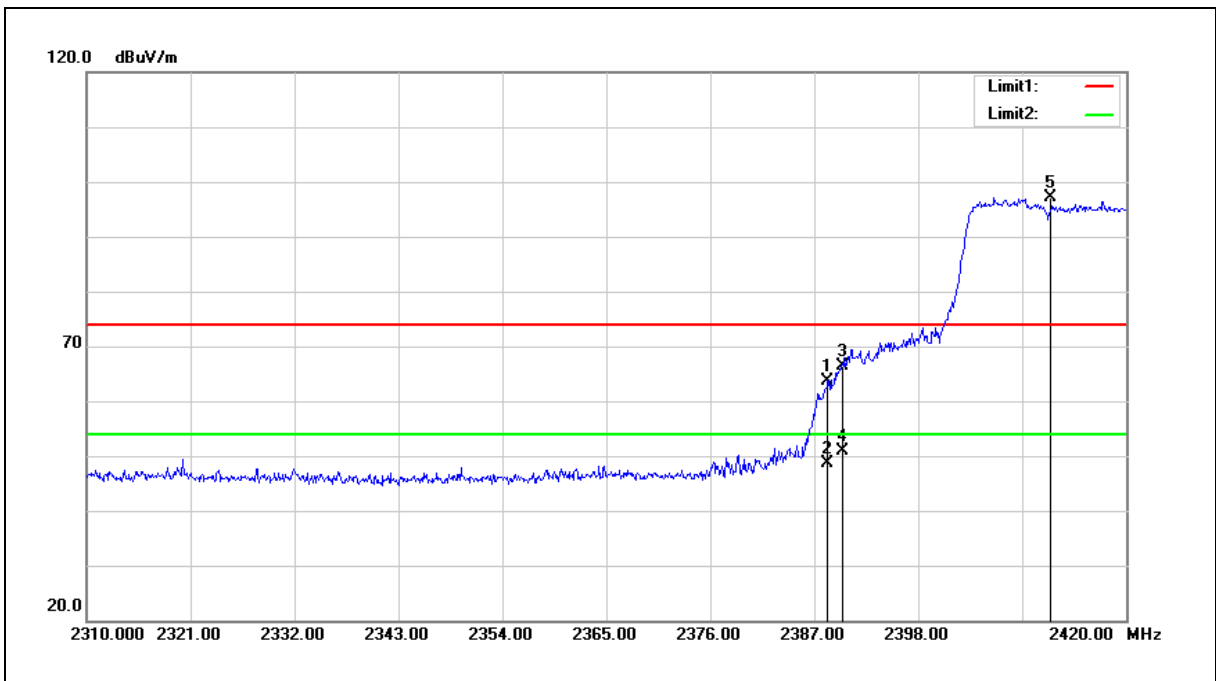

No.	Frequency (MHz)	Reading (dBuV)	Correct Factor (dB/m)	Result (dBuV/m)	Limit (dBuV/m)	Margin (dB)	Remark
1	2388.430	73.54	-9.79	63.75	74.00	-10.25	peak
2	2388.430	58.40	-9.79	48.61	54.00	-5.39	AVG
3	2390.000	76.27	-9.78	66.49	74.00	-7.51	peak
4	2390.000	60.77	-9.78	50.99	54.00	-3.01	AVG
5	2412.000	106.88	-9.72	97.16	74.00	23.16	peak

Note:1.Result (dBuV/m) = Correct Factor (dB/m) + Reading(dBuV).

2.Correction factor (dB/m) = Antenna Factor (dB/m) + Cable loss (dB) – Pre-Amplifier gain (dB).

3.When the peak results are less than average limit, so not need to evaluate the average.



Standard:	FCC Part 15.247	Test Distance:	3 m
Test item:	Band edge	Power:	AC 120 V/60 Hz
Frequency:	2462 MHz	Temp.(°C)/Hum.(%RH):	25(°C)/50%RH
Mode:	Mode 4		
Ant.Polar.:	Horizontal		

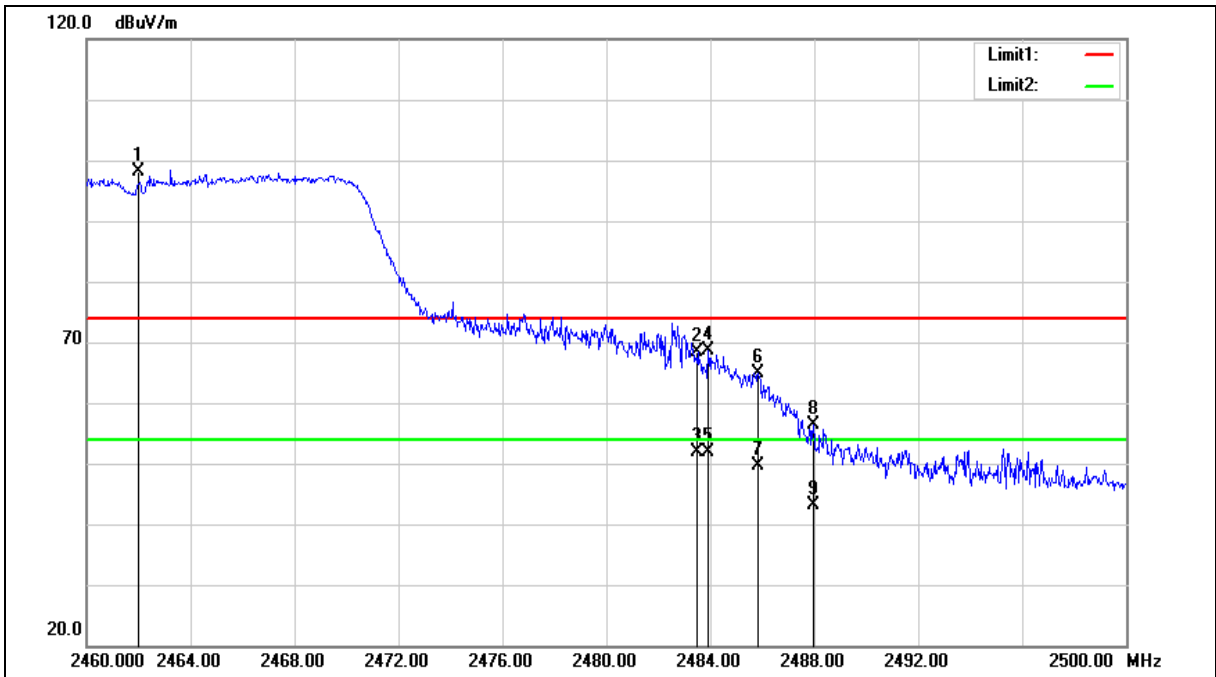

No.	Frequency (MHz)	Reading (dBuV)	Correct Factor (dB/m)	Result (dBuV/m)	Limit (dBuV/m)	Margin (dB)	Remark
1	2462.000	107.86	-9.61	98.25	74.00	24.25	peak
2	2483.500	78.04	-9.56	68.48	74.00	-5.52	peak
3	2483.500	61.55	-9.56	51.99	54.00	-2.01	AVG
4	2483.920	78.11	-9.56	68.55	74.00	-5.45	peak
5	2483.920	61.32	-9.56	51.76	54.00	-2.24	AVG
6	2485.840	74.53	-9.56	64.97	74.00	-9.03	peak
7	2485.840	59.07	-9.56	49.51	54.00	-4.49	AVG
8	2487.960	66.01	-9.56	56.45	74.00	-17.55	peak
9	2487.960	52.72	-9.56	43.16	54.00	-10.84	AVG

Note:1.Result (dBuV/m) = Correct Factor (dB/m) + Reading(dBuV).

2.Correction factor (dB/m) = Antenna Factor (dB/m) + Cable loss (dB) – Pre-Amplifier gain (dB).

3.When the peak results are less than average limit, so not need to evaluate the average.



Standard:	FCC Part 15.247	Test Distance:	3 m
Test item:	Band edge	Power:	AC 120 V/60 Hz
Frequency:	2462 MHz	Temp.(°C)/Hum.(%RH):	25(°C)/50%RH
Mode:	Mode 4		
Ant.Polar.:	Vertical		

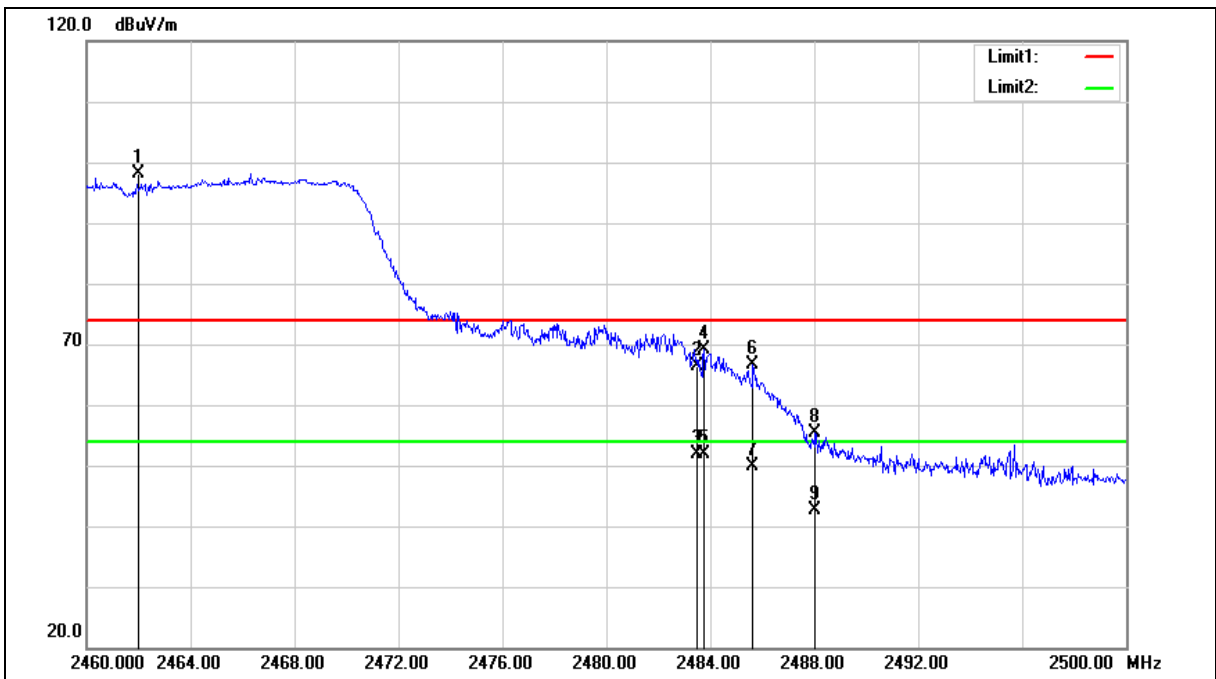

No.	Frequency (MHz)	Reading (dBuV)	Correct Factor (dB/m)	Result (dBuV/m)	Limit (dBuV/m)	Margin (dB)	Remark
1	2462.000	107.79	-9.61	98.18	74.00	24.18	peak
2	2483.500	75.84	-9.56	66.28	74.00	-7.72	peak
3	2483.500	61.54	-9.56	51.98	54.00	-2.02	AVG
4	2483.760	78.61	-9.56	69.05	74.00	-4.95	peak
5	2483.760	61.51	-9.56	51.95	54.00	-2.05	AVG
6	2485.640	76.08	-9.56	66.52	74.00	-7.48	peak
7	2485.640	59.34	-9.56	49.78	54.00	-4.22	AVG
8	2488.040	65.04	-9.56	55.48	74.00	-18.52	peak
9	2488.040	52.28	-9.56	42.72	54.00	-11.28	AVG

Note:1.Result (dBuV/m) = Correct Factor (dB/m) + Reading(dBuV).

2.Correction factor (dB/m) = Antenna Factor (dB/m) + Cable loss (dB) – Pre-Amplifier gain (dB).

3.When the peak results are less than average limit, so not need to evaluate the average.



Standard:	FCC Part 15.247	Test Distance:	3 m
Test item:	Band edge	Power:	AC 120 V/60 Hz
Frequency:	2422MHz	Temp.(°C)/Hum.(%RH):	25(°C)/50%RH
Mode:	Mode 5		
Ant.Polar.:	Horizontal		

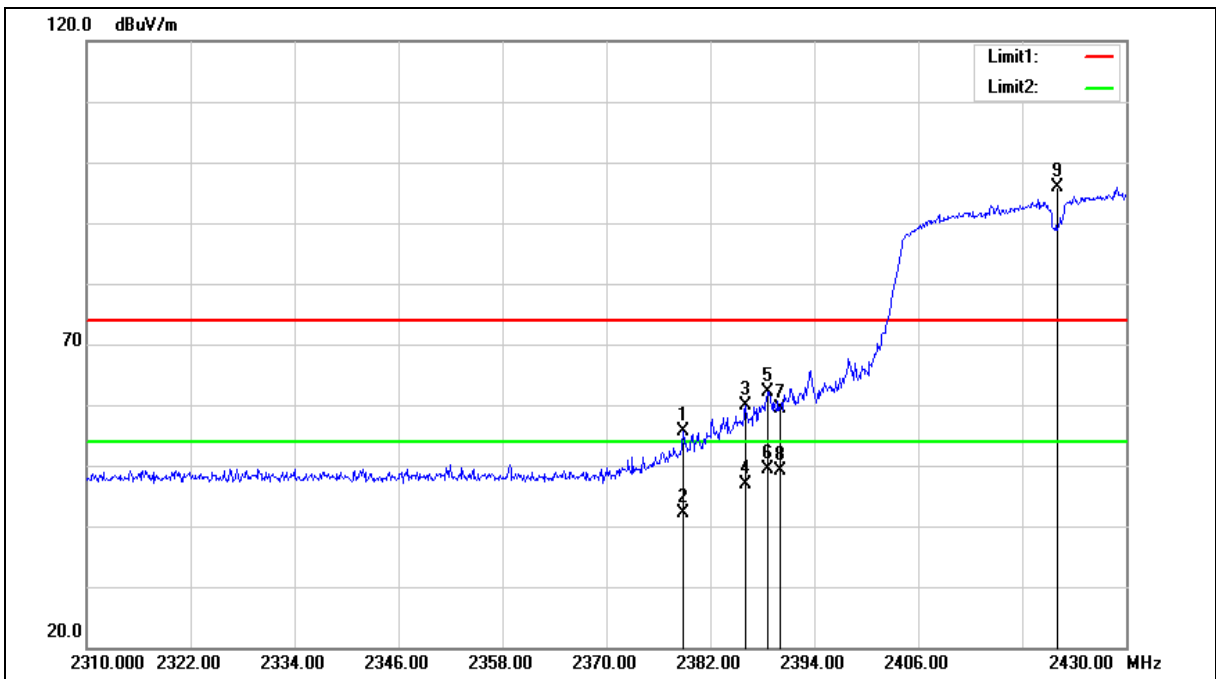

No.	Frequency (MHz)	Reading (dBuV)	Correct Factor (dB/m)	Result (dBuV/m)	Limit (dBuV/m)	Margin (dB)	Remark
1	2378.880	65.33	-9.82	55.51	74.00	-18.49	peak
2	2378.880	51.98	-9.82	42.16	54.00	-11.84	AVG
3	2386.080	69.58	-9.79	59.79	74.00	-14.21	peak
4	2386.080	56.70	-9.79	46.91	54.00	-7.09	AVG
5	2388.600	71.94	-9.79	62.15	74.00	-11.85	peak
6	2388.600	59.08	-9.79	49.29	54.00	-4.71	AVG
7	2390.000	69.15	-9.78	59.37	74.00	-14.63	peak
8	2390.000	58.95	-9.78	49.17	54.00	-4.83	AVG
9	2422.000	105.62	-9.70	95.92	74.00	21.92	peak

Note:1.Result (dBuV/m) = Correct Factor (dB/m) + Reading(dBuV).

2.Correction factor (dB/m) = Antenna Factor (dB/m) + Cable loss (dB) – Pre-Amplifier gain (dB).

3.When the peak results are less than average limit, so not need to evaluate the average.



Standard:	FCC Part 15.247	Test Distance:	3 m
Test item:	Band edge	Power:	AC 120 V/60 Hz
Frequency:	2422MHz	Temp.(°C)/Hum.(%RH):	25(°C)/50%RH
Mode:	Mode 5		
Ant.Polar.:	Vertical		

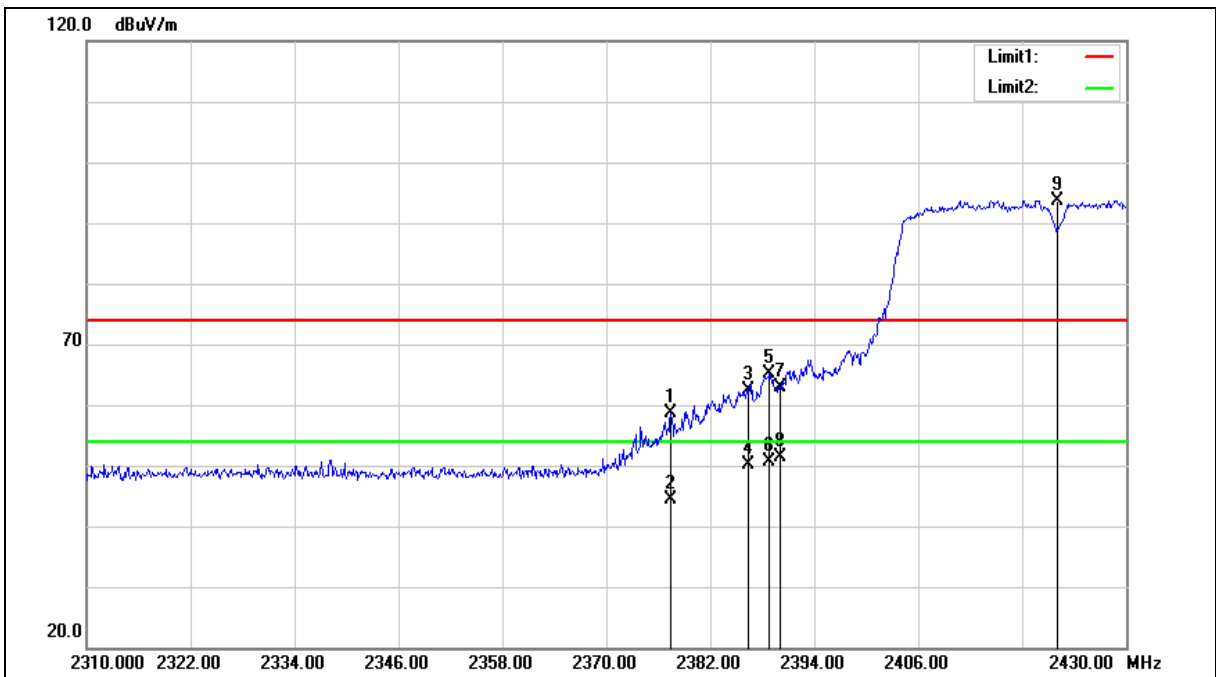

No.	Frequency (MHz)	Reading (dBuV)	Correct Factor (dB/m)	Result (dBuV/m)	Limit (dBuV/m)	Margin (dB)	Remark
1	2377.440	68.57	-9.82	58.75	74.00	-15.25	peak
2	2377.440	54.19	-9.82	44.37	54.00	-9.63	AVG
3	2386.440	72.20	-9.79	62.41	74.00	-11.59	peak
4	2386.440	60.03	-9.79	50.24	54.00	-3.76	AVG
5	2388.840	74.93	-9.79	65.14	74.00	-8.86	peak
6	2388.840	60.53	-9.79	50.74	54.00	-3.26	AVG
7	2390.000	72.65	-9.78	62.87	74.00	-11.13	peak
8	2390.000	61.28	-9.78	51.50	54.00	-2.50	AVG
9	2422.000	103.43	-9.70	93.73	74.00	19.73	peak

Note:1.Result (dBuV/m) = Correct Factor (dB/m) + Reading(dBuV).

2.Correction factor (dB/m) = Antenna Factor (dB/m) + Cable loss (dB) – Pre-Amplifier gain (dB).

3.When the peak results are less than average limit, so not need to evaluate the average.



Standard:	FCC Part 15.247	Test Distance:	3 m
Test item:	Band edge	Power:	AC 120 V/60 Hz
Frequency:	2452 MHz	Temp.(°C)/Hum.(%RH):	25(°C)/50%RH
Mode:	Mode 5		
Ant.Polar.:	Horizontal		

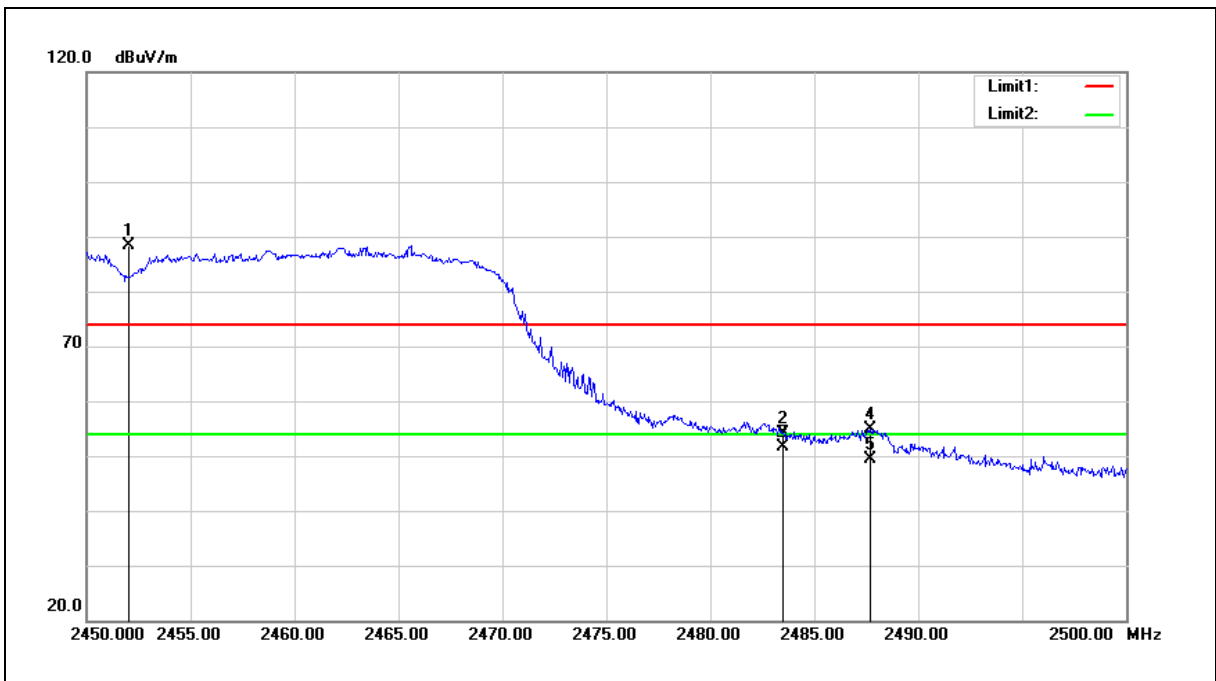

No.	Frequency (MHz)	Reading (dBuV)	Correct Factor (dB/m)	Result (dBuV/m)	Limit (dBuV/m)	Margin (dB)	Remark
1	2452.000	98.04	-9.64	88.40	74.00	14.40	peak
2	2483.500	63.73	-9.56	54.17	74.00	-19.83	peak
3	2483.500	61.11	-9.56	51.55	54.00	-2.45	AVG
4	2487.700	64.32	-9.56	54.76	74.00	-19.24	peak
5	2487.700	58.83	-9.56	49.27	54.00	-4.73	AVG

Note:1.Result (dBuV/m) = Correct Factor (dB/m) + Reading(dBuV).

2.Correction factor (dB/m) = Antenna Factor (dB/m) + Cable loss (dB) – Pre-Amplifier gain (dB).

3.When the peak results are less than average limit, so not need to evaluate the average.



Standard:	FCC Part 15.247	Test Distance:	3 m
Test item:	Band edge	Power:	AC 120 V/60 Hz
Frequency:	2452 MHz	Temp.(°C)/Hum.(%RH):	25(°C)/50%RH
Mode:	Mode 5		
Ant.Polar.:	Vertical		

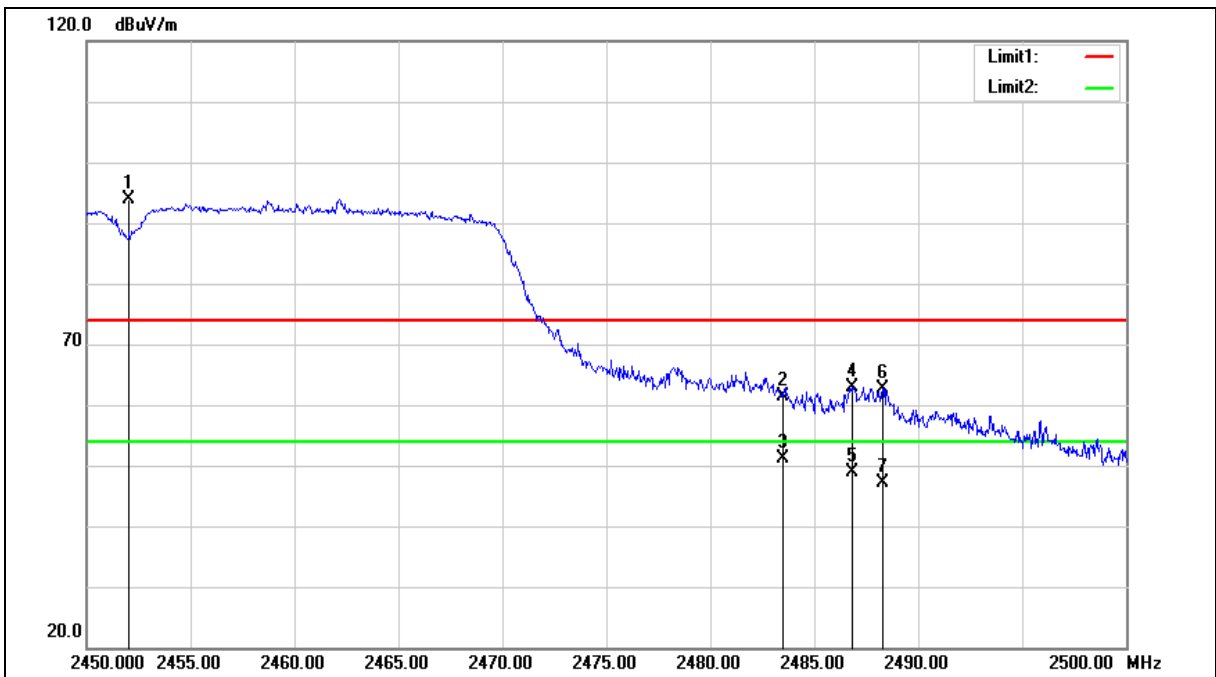

No.	Frequency (MHz)	Reading (dBuV)	Correct Factor (dB/m)	Result (dBuV/m)	Limit (dBuV/m)	Margin (dB)	Remark
1	2452.000	103.49	-9.64	93.85	74.00	19.85	peak
2	2483.500	70.97	-9.56	61.41	74.00	-12.59	peak
3	2483.500	60.66	-9.56	51.10	54.00	-2.90	AVG
4	2486.800	72.50	-9.56	62.94	74.00	-11.06	peak
5	2486.800	58.51	-9.56	48.95	54.00	-5.05	AVG
6	2488.300	72.12	-9.56	62.56	74.00	-11.44	peak
7	2488.300	56.73	-9.56	47.17	54.00	-6.83	AVG

Note:1.Result (dBuV/m) = Correct Factor (dB/m) + Reading(dBuV).

2.Correction factor (dB/m) = Antenna Factor (dB/m) + Cable loss (dB) – Pre-Amplifier gain (dB).

3.When the peak results are less than average limit, so not need to evaluate the average.