



# RF Test Report

Issued Date: Mar. 17, 2021

Applicant : RONDISH COMPANY LIMITED  
Product Type : Wireless Handset  
Trade Name : Rondish  
Model Number : NEC-05  
FCC ID : WNG-NEC-05  
EUT Rated Voltage : DC 3 V  
Test Voltage : DC 2.97 V, DC 3.30 V, DC 3.63 V  
Applicable Standard : FCC 47 CFR PART 15 SUBPART C  
ANSI C63.10:2013  
Receive Date : Nov. 23, 2020  
Test Period : Mar. 03, 2021

## Issue by

A Test Lab Techno Corp.  
101-104, 1F, A building, Safflower ridge industrial area,  
Taoyuan street, Nanshan district, Shenzhen  
Tel : +86-755-23987770 / Fax : +86-755-26637771  
<http://www.atl-lab.com.tw/e-index.htm>



American Association for Laboratory Accreditation number: 3464.02  
Test Firm MRA designation number: CN1168

### Note:

1. The test results are valid only for samples provided by customers and under the test conditions described in this report.
2. This report shall not be reproduced except in full, without the written approval of A Test Lab Technology Corporation.
3. The relevant information is provided by customers in this test report. According to the correctness, appropriateness or completeness of the information provided by the customer, if there is any doubt or error in the information which affects the validity of the test results, the laboratory does not take the responsibility.

Approved By

(Manager)

(Louis Shen)

Reviewed By

(Testing Engineer)

(Joyce Feng)



### Revision History

Rev.	Issue Date	Revisions
00	Mar. 17, 2021	Initial Issue



## TABLE OF CONTENTS

<b>1</b>	<b>General Information .....</b>	<b>4</b>
1.1.	Summary of Test Result.....	4
1.2.	Measurement Uncertainty.....	4
<b>2</b>	<b>EUT Description.....</b>	<b>5</b>
<b>3</b>	<b>Test Methodology.....</b>	<b>5</b>
3.1.	Mode of Operation .....	5
3.2.	EUT Test Step.....	6
3.3.	Configuration of Test System Details .....	6
3.4.	Test Instruments .....	7
3.5.	Test Site Environment.....	7
<b>4</b>	<b>Measurement Procedure.....</b>	<b>8</b>
4.1.	AC Power Line Conducted Emission Measurement .....	8
4.2.	Radiated Emissions Measurement .....	10
4.3.	20 dB Bandwidth Measurement.....	14
4.4.	Antenna Requirement.....	15
<b>5</b>	<b>Test Results .....</b>	<b>16</b>
	Annex A. Conducted Test Results .....	16
	Annex B. Radiated Emissions Measurement .....	17

# 1 General Information

## 1.1. Summary of Test Result

Standard	Item	Results	Remark
15.207	AC Power Conducted Emission	PASS	----
15.231(a)	Transmitter Deactivation Time	PASS	----
15.231(b)	Transmitter Radiated Emissions	PASS	----
15.231(c)	20 dB Bandwidth	PASS	----
15.203	Antenna Requirement	PASS	----
CFR 47 Part 15.231(2010) / ANSI C63.10:2013			

Standard	Description
CFR47, Part 15, Subpart C	Intentional Radiators
ANSI C63. 10: 2013	American National Standard of Procedures for Compliance Testing of Unlicensed Wireless Devices

### Decision Rule

- Uncertainty is not included.
- Uncertainty is included.

## 1.2. Measurement Uncertainty

Test Item	Frequency Range	Uncertainty (dB)
Conducted Emission	150 kHz ~ 30 MHz	2.7
Radiated Emission	30 MHz ~ 1000 MHz	1.7
	1000 MHz ~ 18000 MHz	5.7
	18000 MHz ~ 26500 MHz	5.5
	26500 MHz ~ 40000 MHz	4.8
RF Bandwidth	4.96 %	

## 2 EUT Description

Applicant	RONDISH COMPANY LIMITED UNIT G&H, 4/F, Block 1, KWAI TAK IND. CTR, 15-33 K Hong Kong	
Manufacturer	RONDISH COMPANY LIMITED UNIT G&H, 4/F, Block 1, KWAI TAK IND. CTR, 15-33 K Hong Kong	
Product Type	Wireless Handset	
Trade Name	Rondish	
Model Number	NEC-05	
FCC ID	WNG-NEC-05	
Frequency Range	433.92 MHz	
Modulation Type	ASK	
Number of Channels	1 Channel	
Antenna Type	wire antenna	
RF Cable information	Cable Loss(dB)	Provided by
	-2	<input type="checkbox"/> Manufacturer <input checked="" type="checkbox"/> Testing Laboratory
Operate Temp. Range	5 ~40 °C	

## 3 Test Methodology

### 3.1. Mode of Operation

Test Mode
Mode 1: Transmitter Mode
Mode 2: Continuous TX Mode

Then, the above highest fundamental level mode of the configuration of the EUT and antenna was chosen for all final test items.

By preliminary testing and verifying three axis (X, Y and Z) position of EUT transmitted status, it was found that “Z axis” position was the worst, then the final test was executed the worst condition and test data were recorded in this report.

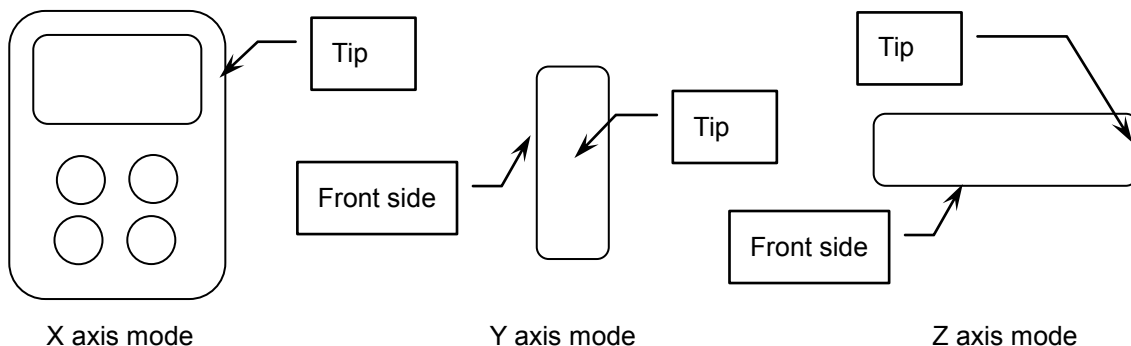

### 3.2. EUT Test Step

1.	Setup the EUT and simulators as shown on 1.3.
----	-----------------------------------------------

Measurement Software			
No.	Description	Software	Version
1	Radiated Emission	EZ EMC	1.1.4.4

### 3.3. Configuration of Test System Details

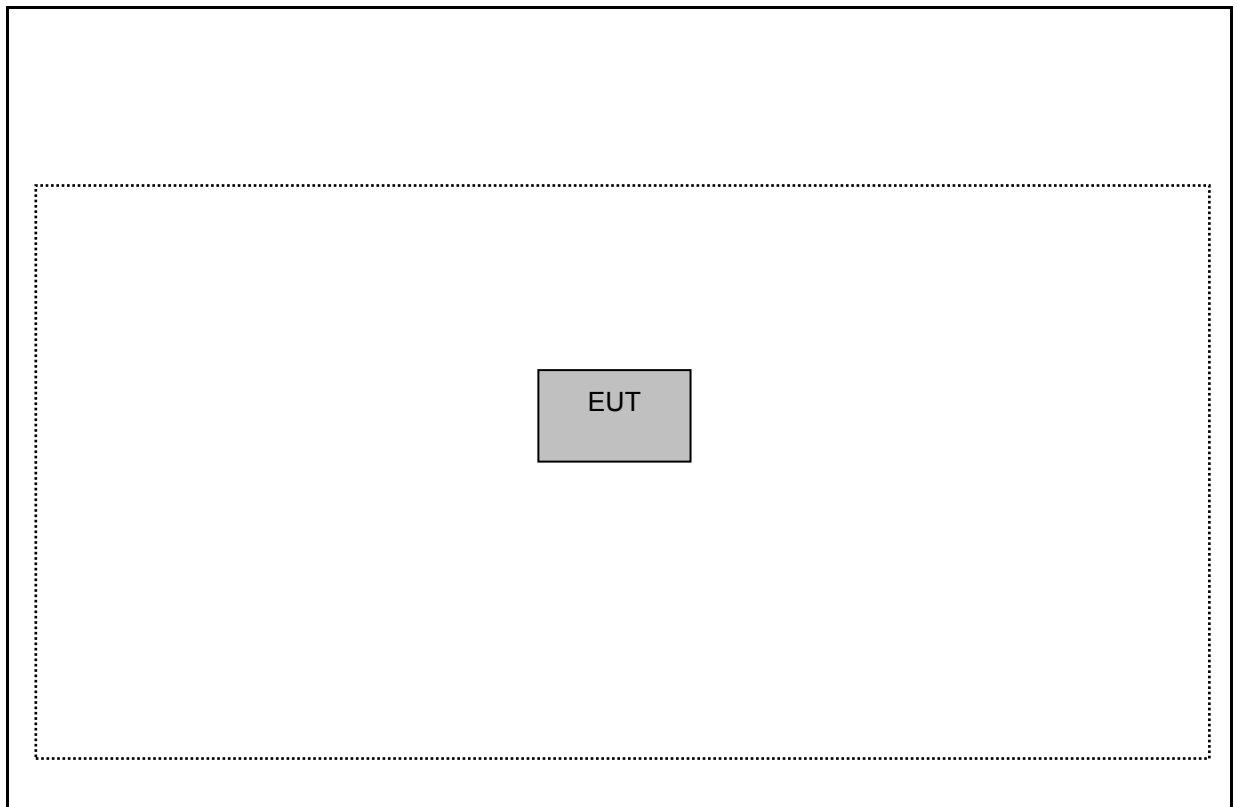



### 3.4. Test Instruments

For Radiated Emissions

Test Period: Mar. 03, 2021

Equipment	Manufacturer	Model Number	Serial Number	Cal. Date	Cal. Period
Temperature & Humidity Chamber	TAICHY	MHU-225LA	980729	12/19/2020	1 year
Power Sensor	Agilent	U2021XA	SG54130003	09/01/2020	1 year
Power Sensor	Agilent	U2021XA	SG54130004	09/01/2020	1 year
Signal Generator	Agilent	E8257D	MY53400659	08/09/2020	1 year
Signal Generator	Agilent	N5182B	MY53050940	05/15/2020	1 year
Test Site	ATL	TE05	TE05	N.C.R.	-----

For Conducted Emission

Test Period: Mar. 03, 2021

Equipment	Manufacturer	Model Number	Serial Number	Cal. Date	Cal. Period
Receiver (9 kHz~3 GHz)	R&S	ESR3	101923	01/09/2021	1 year
LISN	R&S	ENV216	101942	01/09/2021	1 year
LISN	R&S	ENV216	101943	01/09/2021	1 year

For Conducted

Test Period: Mar. 03, 2021

Equipment	Manufacturer	Model Number	Serial Number	Cal. Date	Cal. Period
Spectrum Analyzer (3 Hz~50 GHz)	Agilent	N9030A	MY53420615	09/01/2020	1 year

### 3.5. Test Site Environment

Items	Required (IEC 60068-1)	Actual
Temperature (°C)	15-35	26
Humidity (%RH)	25-75	60
Barometric pressure (mbar)	860-1060	990

## 4 Measurement Procedure

### 4.1. AC Power Line Conducted Emission Measurement

#### ■ Limit

Frequency (MHz)	Quasi-peak	Average
0.15 - 0.5	66 to 56	56 to 46
0.50 - 5.0	56	46
5.0 - 30.0	60	50

#### ■ Test Setup

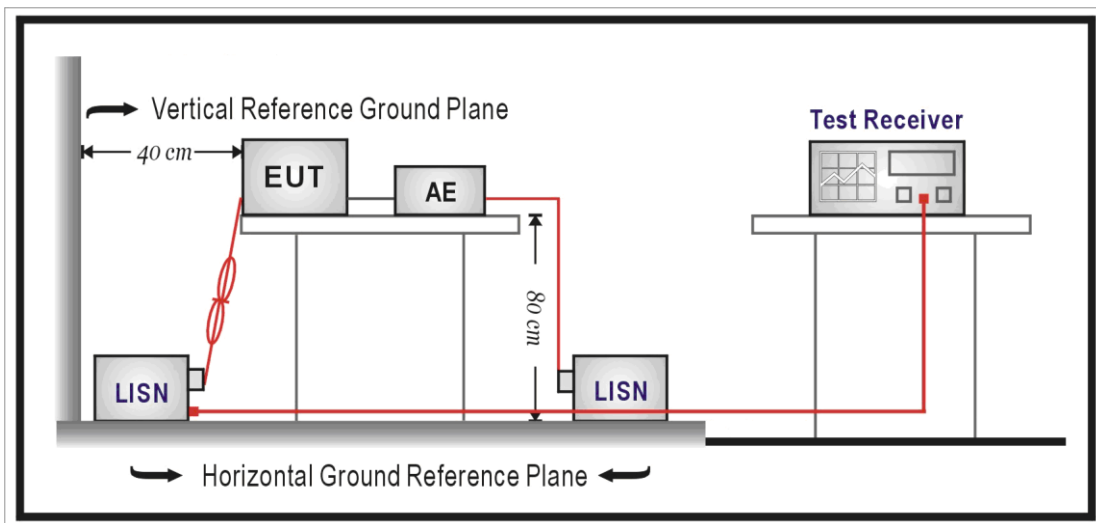



#### ■ Test Procedure

The EUT and simulators are connected to the main power through a line impedance stabilization network (L.I.S.N.). This provides a  $50\Omega// 50\mu\text{H}$  coupling impedance for the measuring equipment. The peripheral devices are also connected to the main power through a LISN that provides a  $50\Omega// 50\mu\text{H}$  coupling impedance with 50ohm termination.

Tabletop device shall be placed on a non-conducting platform, of nominal size 1 m by 1.5 m, raised 80 cm above the reference ground plane. The wall of screened room shall be located 40cm to the rear of the EUT. Other surfaces of tabletop or floor standing EUT shall be at least 80cm from any other ground conducting surface including one or more LISNs. For floor-standing device shall be placed under the EUT with a 12mm insulating material.

Conducted emissions were investigated over the frequency range from 0.15 MHz to 30 MHz using a resolution bandwidth of 9 kHz. The equipment under test (EUT) shall be meet the limits in section 4.1, as applicable, including the average limit and the quasi-peak limit when using respectively, an average detector and quasi-peak detector measured in accordance with the methods described of related standard. When all of peak value were complied with quasi-peak and average limit from 150kHz to 30MHz then quasi-peak and average measurement was unnecessary.

The AMN shall be placed 0,8 m from the boundary of the unit under test and bonded to a ground reference plane for AMNs mounted on top of the ground reference plane. This distance is between the closest points of the AMN and the EUT. All other units of the EUT and associated equipment shall be at least 0,8 m from the AMN. If the mains power cable is longer than 1m then the cable shall be folded back and forth at the centre of the lead to form a bundle no longer than 0.4m. All of interconnecting cables that hang closer than 40cm to the ground plane shall be folded back and forth in the center forming a bundle 30 cm to 40 cm long. All of EUT and AE shall be separate place more than 0.1m. All  $50\ \Omega$  ports of the LISN shall be resistively terminated into  $50\ \Omega$  loads when not connected to the measuring instrument.

If the reading of the measuring receiver shows fluctuations close to the limit, the reading shall be observed for at least 15 s at each measurement frequency; the higher reading shall be recorded with the exception of any brief isolated high reading which shall be ignored.

## 4.2. Radiated Emissions Measurement

### ■ Limit

According to FCC Part 15.231(b) requirement:

In addition to the provisions of §15.205, the field strength of emissions from intentional radiator operated under this section shall not exceed the following:

#### Fundamental and harmonics emission limits

Frequency range (MHz)	Average Field Strength of Fundamental (dB $\mu$ V/m@3 m)	Peak Field Strength of Fundamental (dB $\mu$ V/m@3 m)
433.92	43.66	45.29

#### General Radiated emission Limit

Frequency range (MHz)	Field Strength of Fundamental ( $\mu$ V/m at 3 m)	Field Strength of Harmonics ( $\mu$ V/m at 3 m)
40.66 to 40.70	2250 (67.04 dBuV)	225 (47.04 dBuV)
70 to 130	1250 (61.94 dBuV)	125 (41.94 dBuV)
130 to 174	1250 (61.94 dBuV) to 3750 (71.48 dBuV)	125 (41.94 dBuV) to 375 (51.48 dBuV)
174 to 260	3750 (71.48 dBuV)	375 (51.48 dBuV)
260 to 470	3750 (71.48 dBuV) to 12500 (81.94 dBuV)	375 (51.48 dBuV) to 1250 (61.94 dBuV)
470 and above	12500 (81.94 dBuV)	1250 (61.94 dBuV)

Remark: 1. The table above tighter limit applies at the band edges.

2. The measurement distance in meters, which that between form closest point of EUT to instrument antenna.

■ Setup

Below 1 GHz

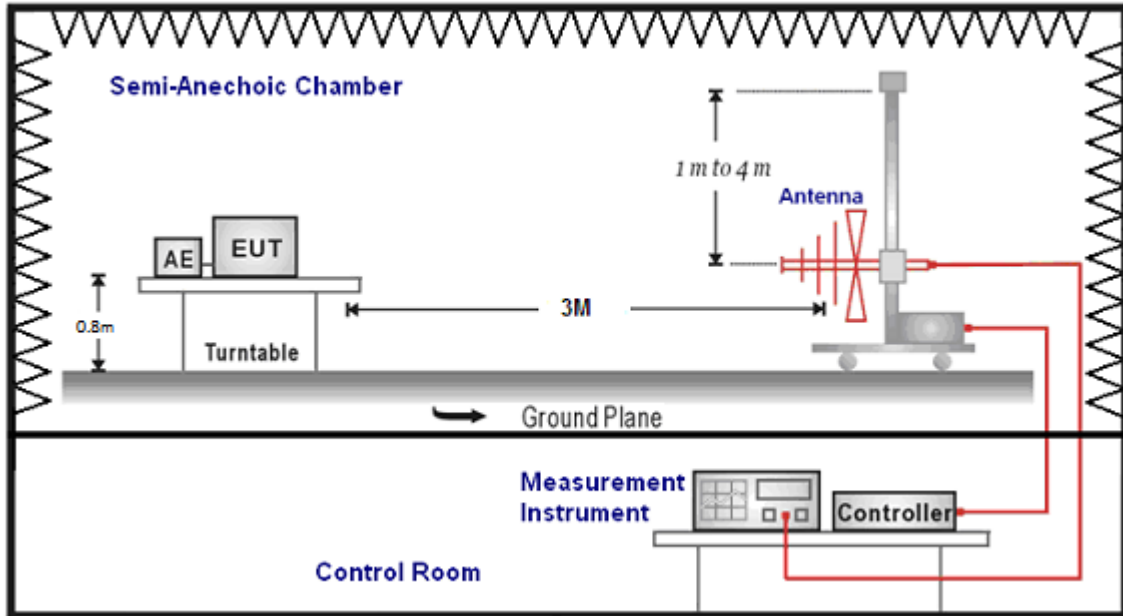

Above 1 GHz

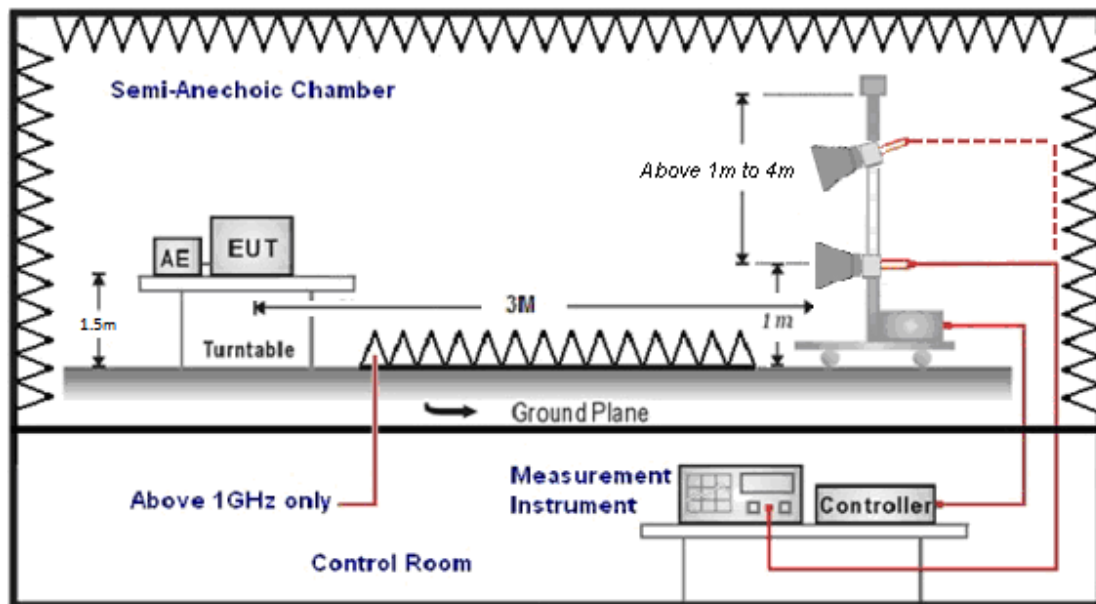

## ■ Test Procedure

Final radiation measurements were made on a three-meter, Semi Anechoic Chamber. The EUT system was placed on a nonconductive turntable which is 0.8 or 1.5 meters height, top surface 1.0 x 1.5 meter. The spectrum was examined from 250 MHz to 2.5 GHz in order to cover the whole spectrum below 10th harmonic which could generate from the EUT. During the test, EUT was set to transmit continuously & Measurements spectrum range from 30 MHz to 26.5 GHz is investigated.

For measurements below 1 GHz the resolution bandwidth is set to 100 kHz for peak detection measurements or 120 kHz for quasi-peak detection measurements. Peak detection is used unless otherwise noted as quasi-peak. For measurements above 1 GHz the resolution bandwidth is set to 1 MHz, and then the video bandwidth is set to 3 MHz for peak measurements and 10 Hz for average measurements.

A nonconductive material surrounded the EUT to supporting the EUT for standing on three orthogonal planes. At each condition, the EUT was rotated 360 degrees, and the antenna was raised and lowered from one to four meters to find the maximum emission levels. Measurements were taken using both horizontal and vertical antenna polarization.

SCHWARZBECK MESS-ELEKTRONIK Biconilog Antenna at 3 Meter and the SCHWARZBECK Double Ridged Guide Antenna was used in frequencies 1 – 26.5 GHz at a distance of 1 meter. All test results were extrapolated to equivalent signal at 3 meters utilizing an inverse linear distance extrapolation Factor (20 dB/decade).

For testing above 1 GHz, the emission level of the EUT in peak mode was 20 dB lower than average limit (that means the emission level in peak mode also complies with the limit in average mode), then testing will be stopped and peak values of EUT will be reported, otherwise, the emissions will be measured in average mode again and reported.

Appropriate preamplifiers were used for improving sensitivity and precautions were taken to avoid overloading or desensitizing the spectrum analyzer. No post – detector video filters were used in the test.

The spectrum analyzer's 6 dB bandwidth was set to 1 MHz, and the analyzer was operated in the peak detection mode, for frequencies both below and up 1 GHz. The average levels were obtained by subtracting the duty cycle correction factor from the peak readings.

The following procedures were used to convert the emission levels measured in decibels referenced to 1 microvolt (dBuV) into field intensity in micro volts pre meter (uV/m).

The actual field intensity in decibels referenced to 1 microvolt in to field intensity in micro volts per meter (dBuV/m).



The actual field intensity in referenced to 1 microvolt per meter (dBuV/m) is determined by algebraically adding the measured reading in dBuV, the antenna factor (dB), and cable loss (dB) and Subtracting the gain of preamplifier (dB) is auto calculate in spectrum analyzer.

$$(1) \text{ Amplitude (dBuV/m)} = \text{FI (dBuV)} + \text{AF (dBuV)} + \text{CL (dBuV)} - \text{Gain (dB)}$$

FI= Reading of the field intensity.

AF= Antenna factor.

CL= Cable loss.

P.S Amplitude is auto calculate in spectrum analyzer.

$$(2) \text{ Actual Amplitude (dBuV/m)} = \text{Amplitude (dBuV)} - \text{Dis(dB)}$$

The FCC specified emission limits were calculated according the EUT operating frequency and by following linear interpolation equations:

(a) For fundamental frequency : Transmitter Output < +30 dBm

(b) For spurious frequency : Spurious emission limits = fundamental emission limit /10

Data of measurement within this frequency range without mark in the table above means the reading of emissions are attenuated more than 20 dB below the permissible limits or the field strength is too small to be measured.

#### ■ Calculation of Average Factor

The output field strengths of specification in accordance with the FCC rules specify measurements with an average detector. During the test, a spectrum analyzer incorporating a peak detector was used. Therefore, a reduction factor can be applied to the resultant peak signal level and compared to the limit for measurement instrumentation incorporating an average detector.

Please see the diagrams below.

(\*) When the field strength (or envelope power) is not constant or when it is in pulses, and an averaging detector is specified to be used, the value of field strength or power over one complete pulse train, excluding blanking intervals, shall be averaged as long as the pulse train does not exceed 0.1 seconds. In cases where the pulse train exceeds 0.1 seconds, the average value (of field strength or output power) shall be determined during a 0.1 second interval during which the field strength or power is at its maximum value.

### 4.3. 20 dB Bandwidth Measurement

#### ■ Limit

According to FCC Part 15.231(c) requirement:

The 20 dB

$$\text{B.W Limit} = 0.25 \% * f \text{ (MHz)} = 0.25 \% * 315 \text{ MHz} = 787.5 \text{ kHz}$$

#### ■ Test Setup

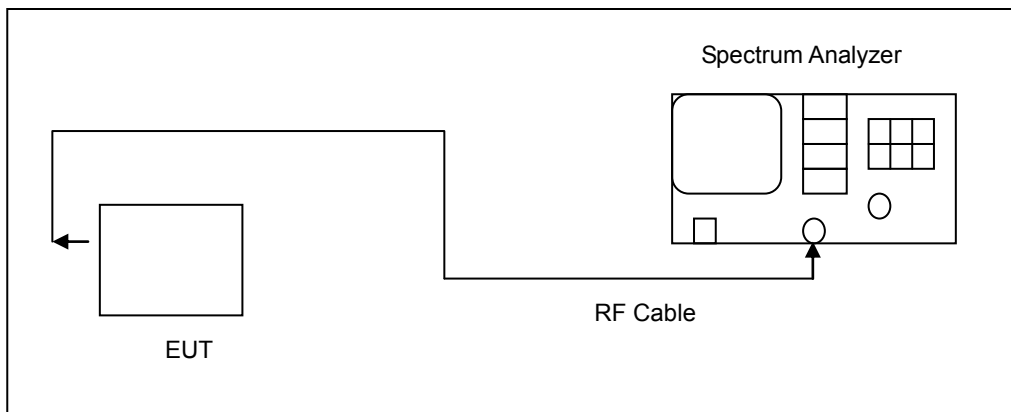

#### ■ Test Procedure

The RF output port of the Equipment-Under-Test is directly coupled to the input of the analyzer through a specialized RF connector and a 10 dB passive attenuator. A fully charged battery was used for the supply voltage. The RF function of the EUT was enabled. The spectrum analyzer used the following settings:

1. Span = 1 MHz
2. RBW  $\geq$  1 % of the 20 dB span
3. VBW  $\geq$  RBW
4. Sweep = auto
5. Detector function = peak
6. Trace = max hold

The trace was allowed to stabilize. The EUT was transmitting at its maximum data rate. The marker-to-peak function was used to set the marker to the peak of the emission. The marker-delta function was used to measure 20 dB down one side of the emission. The marker-delta function and marker was moved to the other side of the emission until it was even with the reference marker. The marker-delta reading at this point was the 20 dB bandwidth of the emission.



#### 4.4. Antenna Requirement

- **Limit**

For intentional device, according to 15.203, an intentional radiator shall be designed to ensure that no antenna other than that furnished by the responsible party shall be used with the device.

- **Antenna Connector Construction**

See section 2 – antenna information.



## 5 Test Results

### Annex A. Conducted Test Results

#### 20 dB Bandwidth Measurement

Test Mode	Mode 2	
Frequency (MHz)	20 dB Bandwidth (kHz)	Limited (kHz)
433.92	14.89	1084.82

#### ■ Test Graphs

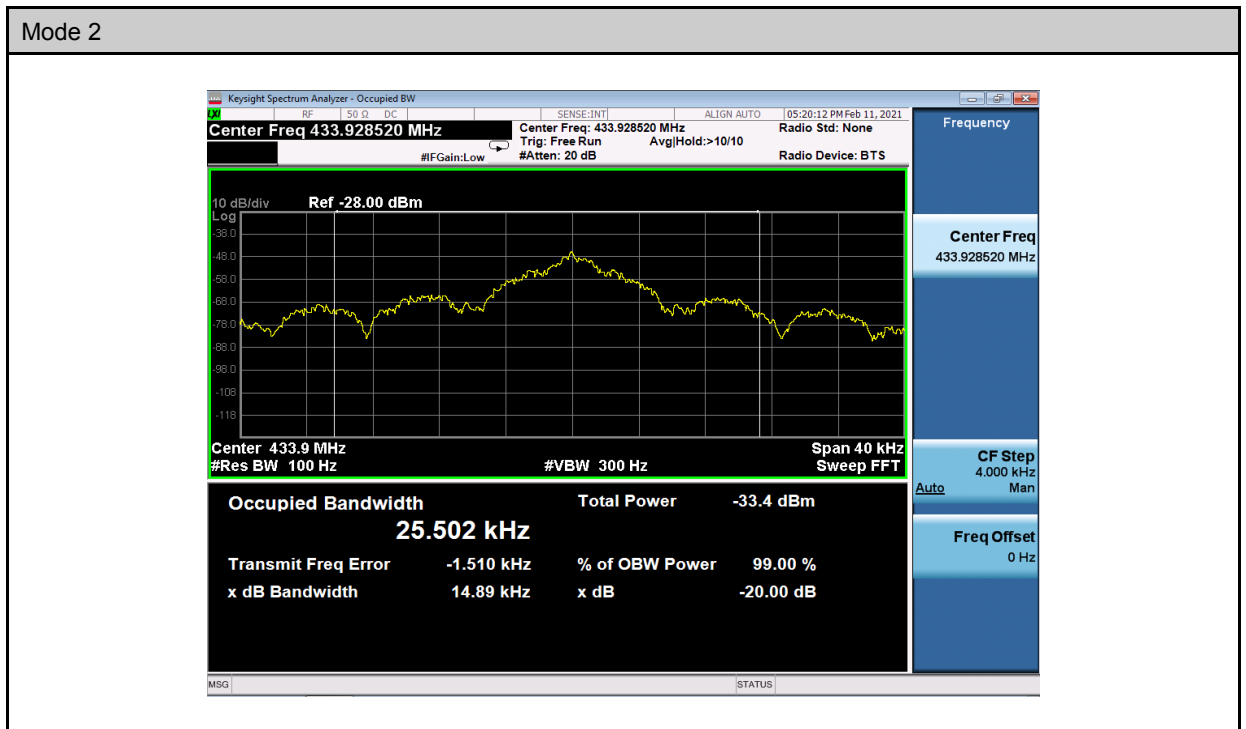



## Annex B. Radiated Emissions Measurement

### Duty Cycle Test Diagrams

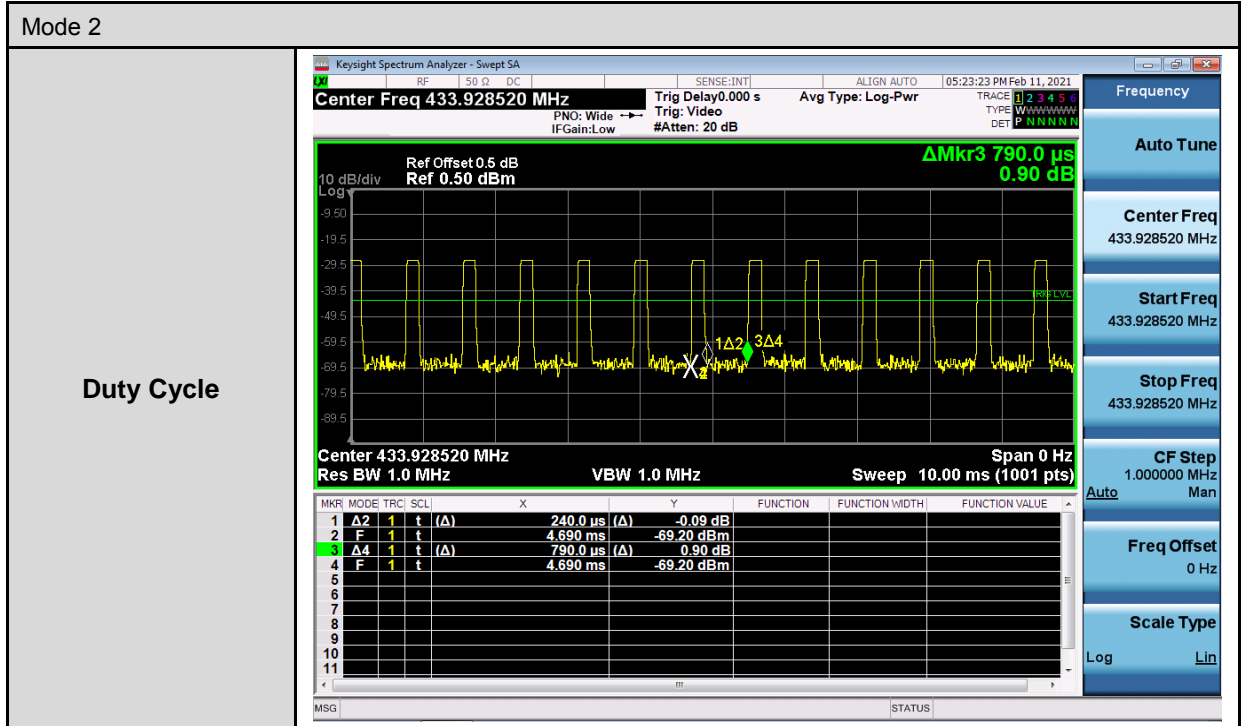

### Duty Cycle Results

Test Mode	Mode 2		
Item	Results	Note	
Ton	0.24 ms	----	
Tp	0.79 ms	----	
Duty Cycle	0.30379	----	
Averaging Factor (20 log * Duty Cycle )	-10.348	----	

Please see the diagrams below.

Note:

1. RB=100 kHz, VB=300 kHz, SPAN=0
2. Duty Cycle= Ton/Tp



### Transmitter Deactivation Time

The EUT was complied with the requirement of FCC 15.231 (a) (1), which employed a switch that will automatically deactivate the transmitter within less than 5 seconds of being released.

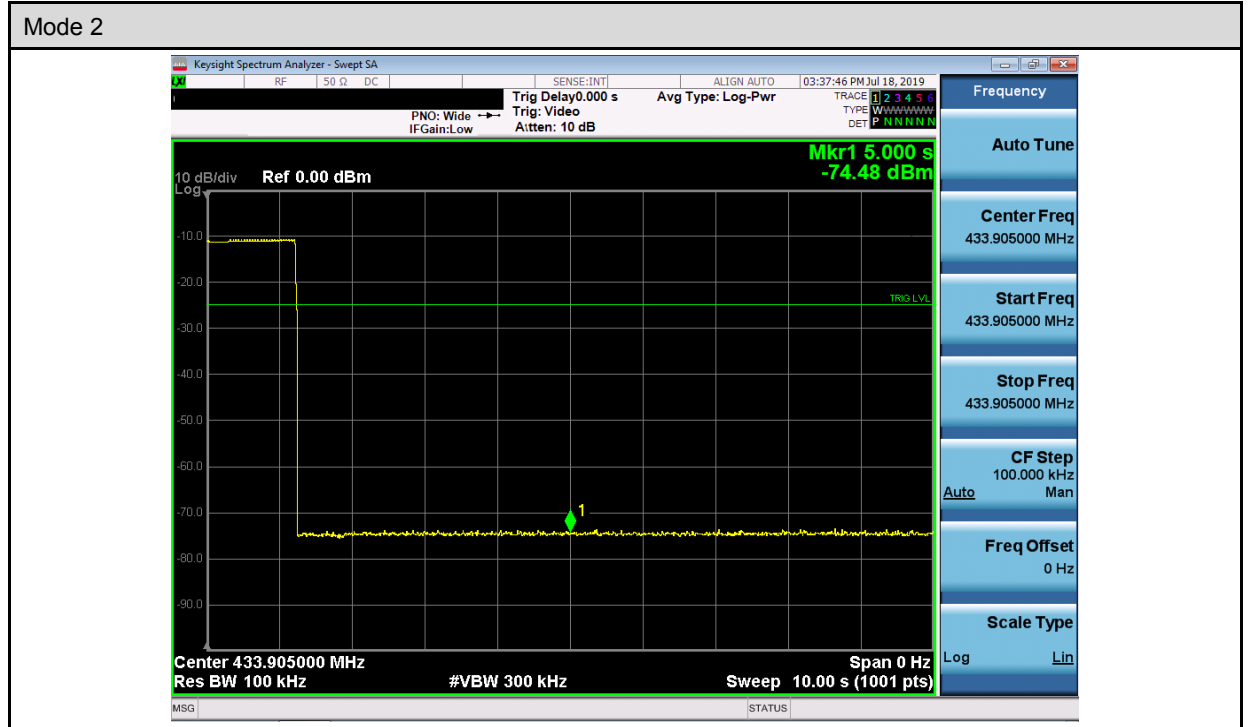



**Fundamental Frequency Test Results**

Standard:	FCC Part 15.231	Test Distance:	3 m
Test item:	Fundamental	Power:	DC 3 V
Test Mode:	Mode 2	Temp.(°C)/Hum.(%RH):	26(°C)/60 %RH
Ant.Polar.:	Horizontal		

No.	Frequency (MHz)	Reading (dBuV)	Correct Factor (dB/m)	Result (dBuV/m)	Limit (dBuV/m)	Margin (dB)	Remark
1	433.9400	52.29	-7.00	45.29	100.83	-55.54	peak

Note:1.Result (dBuV/m) = Correct Factor (dB/m) + Reading(dBuV).

Example: 45.29=-7.00+52.29

2.Correction factor (dB/m) = Antenna Factor (dB/m) + Cable loss (dB) – Pre-Amplifier gain (dB).

3.When the peak results are less than average limit, so not need to evaluate the average.

Standard:	FCC Part 15.231	Test Distance:	3 m
Test item:	Fundamental	Power:	DC 3 V
Test Mode:	Mode 2	Temp.(°C)/Hum.(%RH):	26(°C)/60 %RH
Ant.Polar.:	Vertical		

No.	Frequency (MHz)	Reading (dBuV)	Correct Factor (dB/m)	Result (dBuV/m)	Limit (dBuV/m)	Margin (dB)	Remark
1	433.9250	43.85	-7.00	36.85	100.83	-63.98	peak

Note:1.Result (dBuV/m) = Correct Factor (dB/m) + Reading(dBuV).

Example: 36.85=-7.00+43.85

2.Correction factor (dB/m) = Antenna Factor (dB/m) + Cable loss (dB) – Pre-Amplifier gain (dB).

3.When the peak results are less than average limit, so not need to evaluate the average.



**Below 1 GHz**

Note : Data of measurement within this frequency range without mark in the table above means the reading of emissions are attenuated more than 20 dB below the permissible limits or the field strength is too small to be measured.

Standard:		FCC Part 15.231		Test Distance:		3 m	
Test item:		Harmonic		Power:		DC 3 V	
Test Mode:		Mode 2		Temp.(°C)/Hum.(%RH):		26(°C)/60 %RH	
Description:		Model Number : NEC-05					
Frequency (MHz)	Reading (dBuV)	Correct Factor (dB/m)	Result (dBuV/m)	Limit (dBuV/m)	Margin (dB)	Remark	Ant.Polar. H / V
510.1500	28.63	-4.92	23.71	46.00	-22.29	QP	H
596.4800	28.62	-2.92	25.70	46.00	-20.30	QP	H
717.7300	28.65	-1.16	27.49	46.00	-18.51	QP	H
810.8500	28.83	0.40	29.23	46.00	-16.77	QP	H
867.8450	43.89	0.80	44.69	46.00	-1.31	peak	H
867.8450	43.53	0.80	44.33	46.00	-1.67	QP	H
933.0700	28.33	1.33	29.66	46.00	-16.34	QP	H
566.4100	28.78	-3.62	25.16	46.00	-20.84	QP	V
692.5100	29.38	-1.58	27.80	46.00	-18.20	QP	V
803.0900	28.95	0.34	29.29	46.00	-16.71	QP	V
867.8400	35.40	0.80	36.20	46.00	-9.80	QP	V
908.8200	28.21	1.10	29.31	46.00	-16.69	QP	V
948.5900	31.39	1.47	32.86	46.00	-13.14	QP	V

Note:1.Result (dBuV/m) = Correct Factor (dB/m) + Reading(dBuV).

Example: 23.71=-4.92+28.63

2.Correction factor (dB/m) = Antenna Factor (dB/m) + Cable loss (dB) – Pre-Amplifier gain (dB).

3.When the peak results are less than average limit, so not need to evaluate the average.



**Above 1 GHz**

Standard:	FCC Part 15.231	Test Distance:	3 m				
Test item:	Harmonic	Power:	DC 3 V				
Test Mode:	Mode 2	Temp.(°C)/Hum.(%RH):	26(°C)/60 %RH				
Description:	Model Number : NEC-05						
Frequency (MHz)	Reading (dBuV)	Correct Factor (dB/m)	Result (dBuV/m)	Limit (dBuV/m)	Margin (dB)	Remark	Ant.Polar. H / V
2172.000	56.70	-11.29	45.41	74.00	-28.59	peak	H
2604.000	58.82	-10.21	48.61	74.00	-25.39	peak	H
2912.000	51.93	-8.98	42.95	74.00	-31.05	peak	H
3472.000	56.70	-8.57	48.13	74.00	-25.87	peak	H
3904.000	52.15	-7.60	44.55	74.00	-29.45	peak	H
4500.000	50.13	-6.04	44.09	74.00	-29.91	peak	H
2172.000	55.95	-11.29	44.66	74.00	-29.34	peak	V
2604.000	55.33	-10.21	45.12	74.00	-28.88	peak	V
3076.000	51.63	-8.61	43.02	74.00	-30.98	peak	V
3432.000	51.31	-8.57	42.74	74.00	-31.26	peak	V
3904.000	51.42	-7.60	43.82	74.00	-30.18	peak	V
4040.000	51.15	-7.27	43.88	74.00	-30.12	peak	V

Note:1.Result (dBuV/m) = Correct Factor (dB/m) + Reading(dBuV).

2.Correction factor (dB/m) = Antenna Factor (dB/m) + Cable loss (dB) – Pre-Amplifier gain (dB).

3.When the peak results are less than average limit, so not need to evaluate the average.



**Band edge**

Standard:		FCC Part 15.231		Test Distance:		3 m	
Test item:		Band edge		Power:		DC 3 V	
Test Mode:		Mode 2		Temp.(°C)/Hum.(%RH):		26(°C)/60 %RH	
Frequency (MHz)	Reading (dBuV)	Correct Factor (dB/m)	Result (dBuV/m)	Limit (dBuV/m)	Margin (dB)	Remark	Ant.Polar. H / V
406.5371	28.59	-7.76	20.83	46.00	-25.17	peak	H
420.8817	29.76	-7.37	22.39	46.00	-23.61	peak	H
578.2453	29.30	-3.34	25.96	46.00	-20.04	peak	H
597.9424	29.57	-2.89	26.68	46.00	-19.32	peak	H
405.0384	28.41	-7.81	20.60	46.00	-25.40	peak	V
410.0000	27.46	-7.67	19.79	46.00	-26.21	peak	V
522.3651	30.16	-4.64	25.52	46.00	-20.48	peak	V
601.7962	29.78	-2.82	26.96	46.00	-19.04	peak	V

Note:1.Result (dBuV/m) = Correct Factor (dB/m) + Reading(dBuV).

Example: 20.83=-7.76+28.59

2.Correction factor (dB/m) = Antenna Factor (dB/m) + Cable loss (dB) – Pre-Amplifier gain (dB).

3.When the peak results are less than average limit, so not need to evaluate the average.

--- END---