



RADIO TESTREPORT

Report No.:STS2109058W01

Issued for

RONDISH CO. LTD

UNIT G&H,4/F,Block 1, KWAI TAK IND.CTR,15-33K
HONGKONG, China

Product Name:	Paging transmitter
Brand Name:	N/A
Model Name:	GP2009TR
Series Model:	N/A
FCC ID:	WNG-GP2009TR-FCC
Test Standard:	FCC Part 15.231

Any reproduction of this document must be done in full. No single part of this document may be reproduced without permission from STS, all test data presented in this report is only applicable to presented test sample





TEST REPORT CERTIFICATION

Applicant's Name.....: RONDISH CO. LTD
Address: UNIT G&H,4/F,Block 1, KWAI TAK IND.CTR,15-33K HONGKONG, China
Manufacturer's Name.....: RONDISH CO.LTD
Address: UNIT G&H,4/F,Block 1, KWAI TAK IND.CTR,15-33K HONGKONG, China

Product Description

Product Name.....: Paging transmitter
Brand Name: N/A
Model Name: GP2009TR
Series Model.....: N/A

Test Standards.....: FCC Part 15.231

Test Procedure: ANSI C63.10-2013

This device described above has been tested by STS, the test results show that the equipment under test (EUT) is in compliance with the FCC requirements. And it is applicable only to the tested sample identified in the report.

This report shall not be reproduced except in full, without the written approval of STS, this document only be altered or revised by STS, personal only, and shall be noted in the revision of the document.

Date of Test: 09 Sept. 2021
Date of performance of tests.....: 09 Sept. 2021 ~ 18 Sept. 2021
Date of Issue: 18 Sept. 2021
Test Result.....: Pass

Testing Engineer : [Signature]
(Chris Chen)

Technical Manager : [Signature]
(Sean she)

Authorized Signatory : [Signature]
(Vita Li)





TABLE OF CONTENTS	Page
1. SUMMARY OF TEST RESULTS	6
1.1 TEST FACTORY	6
1.2 MEASUREMENT UNCERTAINTY	6
2. GENERAL INFORMATION	7
2.1 GENERAL DESCRIPTION OF THE EUT	7
2.2 DESCRIPTION OF THE TEST MODES	8
2.3 BLOCK DIAGRAM SHOWING THE CONFIGURATION OF SYSTEM TESTED	8
2.4 DESCRIPTION OF NECESSARY ACCESSORIES AND SUPPORT UNITS	9
2.5 EQUIPMENTS LIST	10
3. EMC EMISSION TEST	12
3.1 CONDUCTED EMISSION MEASUREMENT	12
3.2 TEST PROCEDURE	13
3.3 TEST SETUP	13
3.4 TEST RESULTS	14
4. RADIATED EMISSION MEASUREMENT	16
4.1 RADIATED EMISSION LIMITS	16
4.2 TEST PROCEDURE	18
4.3 DEVIATION FROM TEST STANDARD	18
4.4 TEST SETUP	19
4.5 EUT OPERATING CONDITIONS	20
4.6 TEST RESULTS	20
4.7 FIELD STRENGTH CALCULATION	21
5. BANDWIDTH TEST	25
5.1 LIMIT	25
5.2 TEST REQUIREMENTS	25
5.3 TEST PROCEDURE	25
5.4 TEST SETUP	25
5.5 EUT OPERATION CONDITIONS	25
5.6 TEST RESULTS	26
6. DUTY CYCLE	27
6.1 TEST PROCEDURE	27
6.2 TEST SETUP	27
6.3 EUT OPERATION CONDITIONS	27
6.4 TEST RESULTS	28



TABLE OF CONTENTS	Page
7. AUTOMATICALLY DEACTIVATE	29
7.1 STANDARD REQUIREMENT	29
7.2 TEST PROCEDURE	29
8. ANTENNA REQUIREMENT	31
8.1 STANDARD REQUIREMENT	31
8.2 EUT ANTENNA	31
APPENDIX 1-PHOTOS OF TEST SETUP	32





Revision History

Rev.	Issue Date	Report NO.	Effect Page	Contents
00	18 Sept. 2021	STS2109058W01	ALL	Initial Issue





1. SUMMARY OF TEST RESULTS

Test procedures according to the technical standards:

FCC Part 15.231, Subpart C			
Standard Section	Test Item	Judgment	Remark
15.207	Conducted Emission	PASS	--
15.205(a)/15.209/ 15.231.(b)	Radiated Spurious Emission	PASS	--
15.231(a)(1)/ 15.231(b)(2)	Transmission requirement	PASS	--
15.231(C)	20 dB Bandwidth	PASS	--
15.203	Antenna Requirement	PASS	--

NOTE: (1) "N/A" denotes test is not applicable in this Test Report.

(2) All tests are according to ANSI C63.10-2013.

1.1 TEST FACTORY

SHENZHEN STS TEST SERVICES CO., LTD

Add. : A 1/F, Building B, Zhuoke Science Park, No.190 Chongqing Road, HepingShequ, Fuyong Sub-District, Bao'an District, Shenzhen, Guang Dong, China

FCC test Firm Registration Number: 625569

IC test Firm Registration Number: 12108A

A2LA Certificate No.: 4338.01

1.2 MEASUREMENT UNCERTAINTY

The reported uncertainty of measurement $y \pm U$, where expanded uncertainty U is based on a standard uncertainty multiplied by a coverage factor of $k=2$, providing a level of confidence of approximately **95** %.

No.	Item	Uncertainty
1	RF output power, conducted	± 0.68 dB
2	Unwanted Emissions, conducted	± 2.988 dB
3	All emissions, radiated 9K-30MHz	± 2.84 dB
4	All emissions, radiated 30M-1GHz	± 4.39 dB
5	All emissions, radiated 1G-6GHz	± 5.10 dB
6	All emissions, radiated >6G	± 5.48 dB
7	Conducted Emission (9KHz-150KHz)	± 2.79 dB
8	Conducted Emission (150KHz-30MHz)	± 2.80 dB



2. GENERAL INFORMATION

2.1 GENERAL DESCRIPTION OF THE EUT

Product Name	Paging transmitter
Trade Name	N/A
Model Name	GP2009TR
Series Model	N/A
Model Difference	N/A
Frequency band	459.1MHz
Rating	Input: 5V, 1A
Adapter	Input: 100-240V, 50/60Hz, 0.15A Output: 5V@1A
Modulation Type	FSK
Hardware version number	V9
Software version number	Ver 1.00
Connecting I/O Port(s)	N/A

Note:

1. For a more detailed features description, please refer to the manufacturer's specifications or the User Manual.

2. Table for filed Antenna

Ant.	Brand	Model Name	Antenna Type	Connector	Gain (dBi)	NOTE
1	N/A	GP2009TR	Rod antenna	N/A	3	Antenna

Note: The antenna information refer the manufacturer provide report, applicable only to the tested sample identified in the report.

2.2 DESCRIPTION OF THE TEST MODES

To investigate the maximum EMI emission characteristics generates from EUT, the test system was pre-scanning tested base on the consideration of following EUT operation mode or test configuration mode which possible have effect on EMI emission level. Each of these EUT operation mode(s) or test configuration mode(s) mentioned above was evaluated respectively.

Pretest Mode	Description
Mode 1	TX Mode

For Conducted Emission/Radiated Emission	
Final Test Mode	Description
Mode 1	TX Mode

2.3 BLOCK DIAGRAM SHOWING THE CONFIGURATION OF SYSTEM TESTED

Radiated Spurious Emission Test

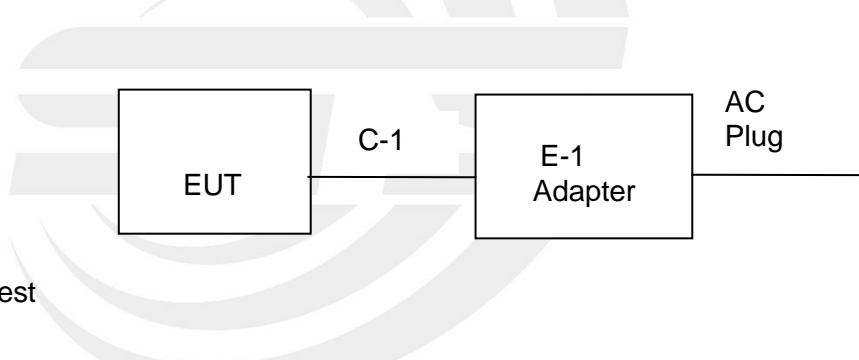

Conducted Emission Test

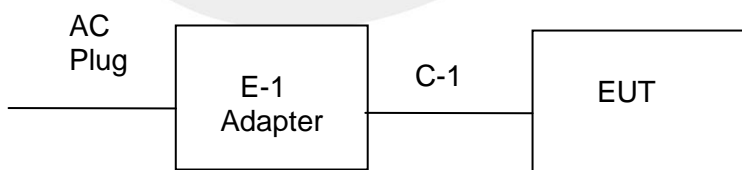



2.4 DESCRIPTION OF NECESSARY ACCESSORIES AND SUPPORT UNITS

The EUT has been tested as an independent unit together with other necessary accessories or support units. The following support units or accessories were used to form a representative test configuration during the tests.

Necessary accessories

Item	Equipment	Mfr/Brand	Model/Type No.	Length	Note
E-1	Adapter	N/A	GS-502A	N/A	N/A
C-1	USB Cable	N/A	N/A	195cm	NO

Support units

Item	Equipment	Mfr/Brand	Model/Type No.	Length	Note
N/A	N/A	N/A	N/A	N/A	N/A

Note:

- (1) For detachable type I/O cable should be specified the length in cm in 『Length』 column.
- (2) “YES” is means “with core”; “NO” is means “without core”.



2.5 EQUIPMENTS LIST

Radiation Test equipment

Kind of Equipment	Manufacturer	Type No.	Serial No.	Last calibration	Calibrated until
Test Receiver	R&S	ESCI	101427	2020.10.12	2021.10.11
Signal Analyzer	R&S	FSV 40-N	101823	2020.10.10	2021.10.09
Active loop Antenna	ZHINAN	ZN30900C	16035	2021.04.11	2023.04.10
Bilog Antenna	TESEQ	CBL6111D	34678	2020.10.12	2022.10.11
Horn Antenna	SCHWARZBECK	BBHA 9120D	02014	2019.10.15	2021.10.14
SHF-EHF Horn Antenna (18G-40GHz)	A-INFO	LB-180400-KF	J211020657	2020.10.12	2022.10.11
Pre-Amplifier(0.1M-3G Hz)	EM	EM330	060665	2020.10.12	2021.10.11
Pre-Amplifier (1G-18GHz)	SKET	LNPA-01018G-45	SK201808090 1	2020.10.12	2021.10.11
Pre-Amplifier (18G-40GHz)	SKET	LNPA-1840-50	SK201810180 1	2020.10.10	2021.10.09
Temperature & Humidity	HH660	Mieo	N/A	2020.10.13	2021.10.12
Turn table	EM	SC100_1	60531	N/A	N/A
Antenna mast	EM	SC100	N/A	N/A	N/A
Test SW	FARAD	EZ-EMC(Ver.STSLAB-03A1 RE)			

Conduction Test equipment

Kind of Equipment	Manufacturer	Type No.	Serial No.	Last calibration	Calibrated until
Test Receiver	R&S	ESCI	101427	2020.10.12	2021.10.11
LISN	R&S	ENV216	101242	2020.10.12	2021.10.11
LISN	EMCO	3810/2NM	23625	2020.10.12	2021.10.11
Temperature & Humidity	HH660	Mieo	N/A	2020.10.13	2021.10.12
Test SW	FARAD	EZ-EMC(Ver.STSLAB-03A1 RE)			



RF Connected Test

Kind of Equipment	Manufacturer	Type No.	Serial No.	Last calibration	Calibrated until
Power Sensor	Keysight	U2021XA	MY55520005	2020.10.10	2021.10.09
			MY55520006	2020.10.10	2021.10.09
			MY56120038	2020.10.10	2021.10.09
			MY56280002	2020.10.10	2021.10.09
Signal Analyzer	Agilent	N9020A	MY51110105	2021.03.04	2022.03.03
Temperature & Humidity	HH660	Mieo	N/A	2020.10.13	2021.10.12
Test SW	FARAD	LZ-RF /LzRf-3A3			





3. EMC EMISSION TEST

3.1 CONDUCTED EMISSION MEASUREMENT

3.1.1 POWER LINE CONDUCTED EMISSION LIMITS

The radio frequency voltage that is conducted back onto the AC power line on any frequency or frequencies, within the band 150 kHz to 30 MHz, shall not exceed the limits in the following table.

FREQUENCY (MHz)	Class B (dBuV)		Standard
	Quasi-peak	Average	
0.15 -0.5	66 - 56 *	56 - 46 *	CISPR
0.50 -5.0	56.00	46.00	CISPR
5.0 -30.0	60.00	50.00	CISPR

0.15 -0.5	66 - 56 *	56 - 46 *	FCC
0.50 -5.0	56.00	46.00	FCC
5.0 -30.0	60.00	50.00	FCC

Note:

(1) The tighter limit applies at the band edges.

(2) The limit of “ * ” marked band means the limitation decreases linearly with the logarithm of the frequency in the range.

The following table is the setting of the receiver

Receiver Parameters	Setting
Attenuation	10 dB
Start Frequency	0.15 MHz
Stop Frequency	30 MHz
IF Bandwidth	9 kHz

3.2 TEST PROCEDURE

- a. The EUT is 0.8 m from the horizontal ground plane and 0.4 m from the vertical ground plane with EUT being connected to the power mains through a line impedance stabilization network (LISN). All other support equipments are powered from additional LISN(s). The LISN provides 50 Ohm/ 50uH of coupling impedance for the measuring instrument.
- b. Interconnecting cables that hang closer than 40 cm to the ground plane shall be folded back and forth in the center forming a bundle 30 to 40 cm long.
- c. I/O cables that are not connected to a peripheral shall be bundled in the center. The end of the cable may be terminated, if required, using the correct terminating impedance. The overall length shall not exceed 1 m.
- d. LISN at least 80 cm from nearest part of EUT chassis.
- e. For the actual test configuration, please refer to the related Item –EUT Test Photos.

3.3 TEST SETUP

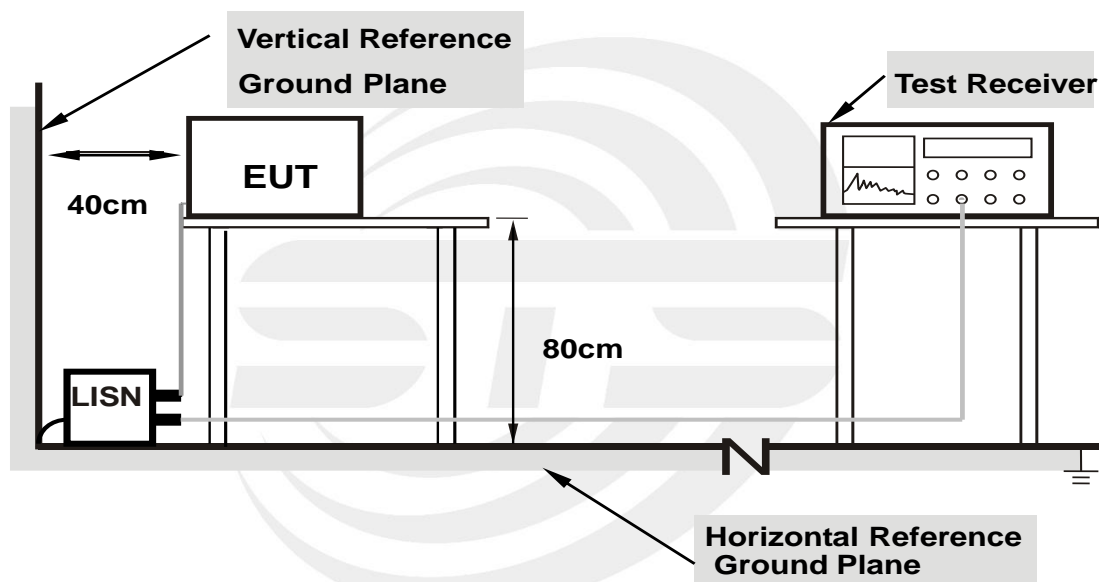

Note: 1. Support units were connected to second LISN.

2. Both of LISNs (AMN) are 80 cm from EUT and at least 80 cm from other units and other metal planes support units.



3.4 TEST RESULTS

Temperature:	26.8°C	Relative Humidity:	55%
Test Voltage:	AC 120V/60Hz	Phase:	L
Test Mode:	Mode 1		

No.	Frequency (MHz)	Reading (dBuV)	Correct Factor(dB)	Result (dBuV)	Limit (dBuV)	Margin (dB)	Remark
1	0.2260	13.76	20.50	34.26	62.60	-28.34	QP
2	0.2260	0.10	20.50	20.60	52.60	-32.00	AVG
3	0.5740	14.18	20.45	34.63	56.00	-21.37	QP
4	0.5740	7.99	20.45	28.44	46.00	-17.56	AVG
5	1.8540	8.76	20.38	29.14	56.00	-26.86	QP
6	1.8540	-1.35	20.38	19.03	46.00	-26.97	AVG
7	4.7660	7.57	20.53	28.10	56.00	-27.90	QP
8	4.7660	-1.97	20.53	18.56	46.00	-27.44	AVG
9	11.2660	6.99	21.09	28.08	60.00	-31.92	QP
10	11.2660	-4.02	21.09	17.07	50.00	-32.93	AVG
11	25.8580	7.80	22.80	30.60	60.00	-29.40	QP
12	25.8580	-4.04	22.80	18.76	50.00	-31.24	AVG

Remark:

1. All readings are Quasi-Peak and Average values
2. Margin = Result (Result = Reading + Factor) – Limit
3. Factor=LISN factor+Cable loss+Limiter (10dB)

100.0 dBuV

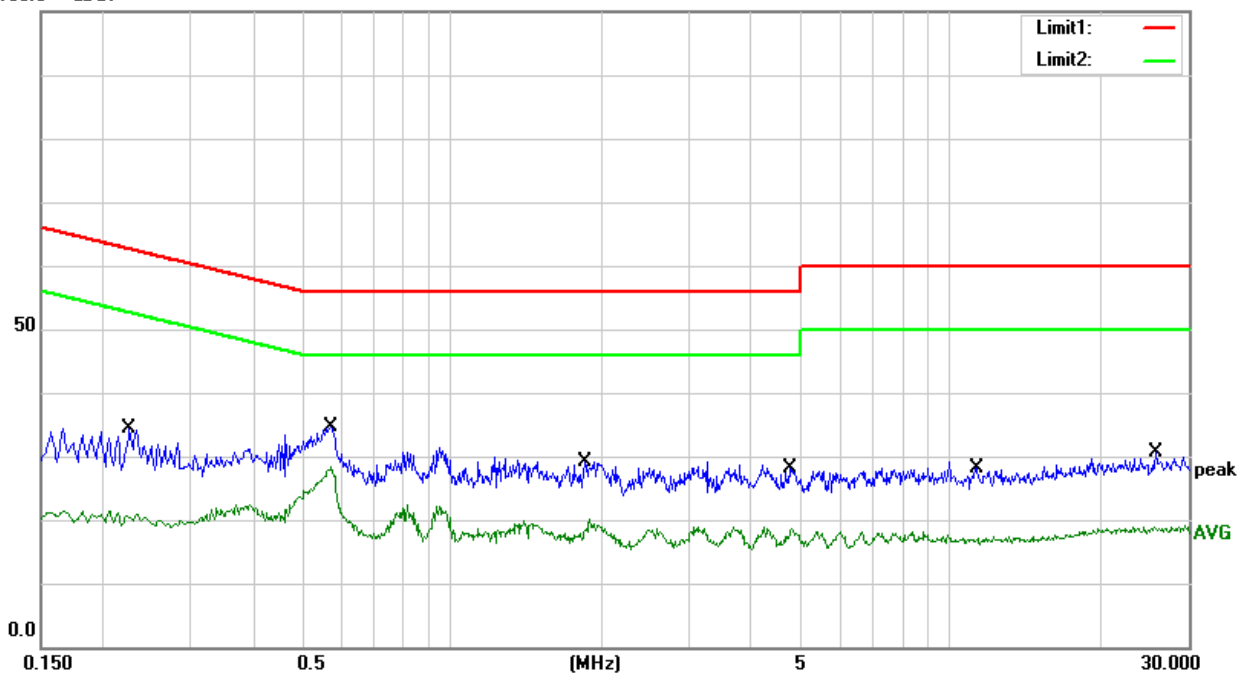



Temperature:	26.8°C	Relative Humidity:	55%
Test Voltage:	AC 120V/60Hz	Phase:	N
Test Mode:	Mode 1		

No.	Frequency (MHz)	Reading (dBuV)	Correct Factor(dB)	Result (dBuV)	Limit (dBuV)	Margin (dB)	Remark
1	0.1700	15.16	20.34	35.50	64.96	-29.46	QP
2	0.1700	0.31	20.34	20.65	54.96	-34.31	AVG
3	0.5740	15.78	20.45	36.23	56.00	-19.77	QP
4	0.5740	2.98	20.45	23.43	46.00	-22.57	AVG
5	1.4700	9.55	20.34	29.89	56.00	-26.11	QP
6	1.4700	-2.02	20.34	18.32	46.00	-27.68	AVG
7	3.7180	11.52	20.49	32.01	56.00	-23.99	QP
8	3.7180	-2.21	20.49	18.28	46.00	-27.72	AVG
9	8.3020	7.30	20.72	28.02	60.00	-31.98	QP
10	8.3020	-3.69	20.72	17.03	50.00	-32.97	AVG
11	21.2940	7.08	22.86	29.94	60.00	-30.06	QP
12	21.2940	-4.27	22.86	18.59	50.00	-31.41	AVG

Remark:

1. All readings are Quasi-Peak and Average values
2. Margin = Result (Result =Reading + Factor)–Limit
3. Factor=LISN factor+Cable loss+Limiter (10dB)

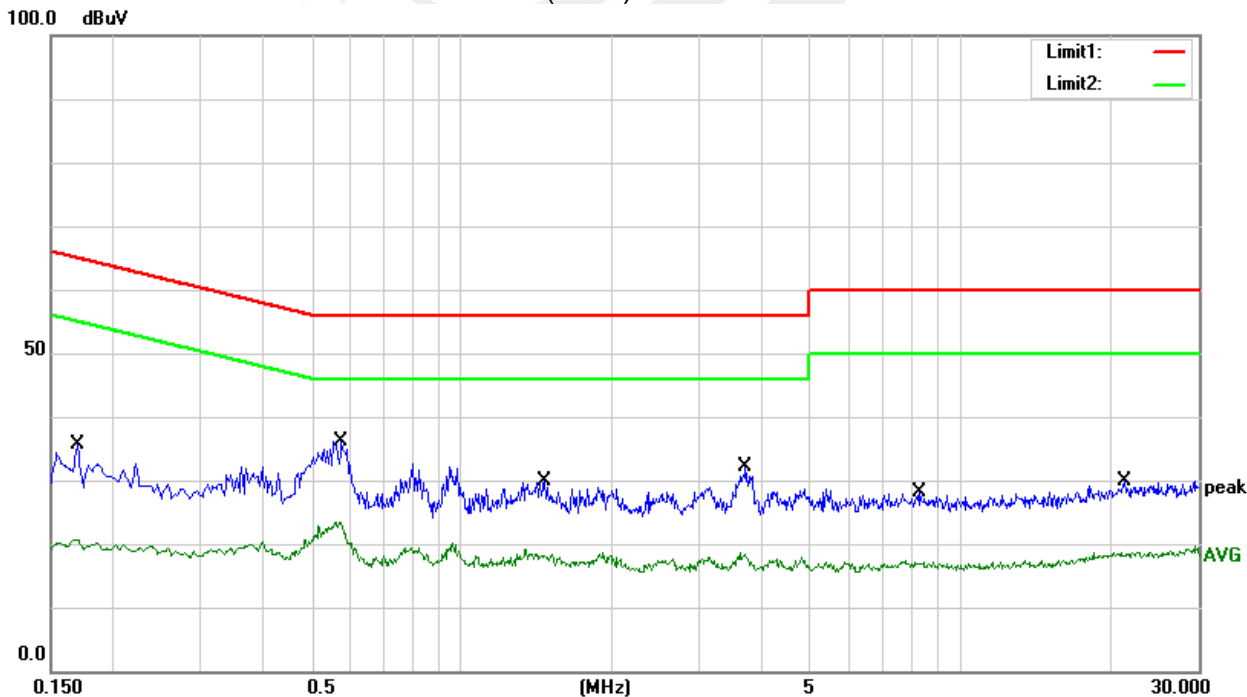



4. RADIATED EMISSION MEASUREMENT

4.1 RADIATED EMISSION LIMITS

In case the emission fall within the restricted band specified on Part 15.205(a), then the Part 15.209(a) and Part 15.231(b) limit in the table below has to be followed.

LIMITS OF RADIATED EMISSION MEASUREMENT (0.009MHz - 1000MHz)

Frequencies (MHz)	Field Strength (micovolts/meter)	Measurement Distance (meters)
0.009~0.490	2400/F(KHz)	300
0.490~1.705	24000/F(KHz)	30
1.705~30.0	30	30
30~40.66	100	3
40.70~70	100	3

Fundamental Frequency (MHz)	Field Strength of fundamental (microvolts/meter)	Field Strength of Unwanted Emissions (microvolts/meter)
40.66~40.70	2,250	225
70~130	1,250	125
130~174	1,250 to 3,750**	125 to 375**
174~260	3750	375
260~470	3,750 to 12,500**	375 to 1,250**
Above 470	12,500	1,250

LIMITS OF RADIATED EMISSION MEASUREMENT (Above 1000MHz)

FREQUENCY (MHz)	Class B (dBuV/m) (at 3M)	
	PEAK	AVERAGE
Above 1000	74	54

NOTE:

- (1) The limit for radiated test was performed according to FCC PART 15C.
- (2) Emission level (dBuV/m)=20log Emission level (uV/m).



LIMITS OF RESTRICTED FREQUENCY BANDS

FREQUENCY (MHz)	FREQUENCY (MHz)	FREQUENCY (MHz)	FREQUENCY (GHz)
0.090-0.110	16.42-16.423	399.9-410	4.5-5.15
0.495-0.505	16.69475-16.69525	608-614	5.35-5.46
2.1735-2.1905	16.80425-16.80475	960-1240	7.25-7.75
4.125-4.128	25.5-25.67	1300-1427	8.025-8.5
4.17725-4.17775	37.5-38.25	1435-1626.5	9.0-9.2
4.20725-4.20775	73-74.6	1645.5-1646.5	9.3-9.5
6.215-6.218	74.8-75.2	1660-1710	10.6-12.7
6.26775-6.26825	108-121.94	1718.8-1722.2	13.25-13.4
6.31175-6.31225	123-138	2200-2300	14.47-14.5
8.291-8.294	149.9-150.05	2310-2390	15.35-16.2
8.362-8.366	156.52475-156.52525	2483.5-2500	17.7-21.4
8.37625-8.38675	156.7-156.9	2690-2900	22.01-23.12
8.41425-8.41475	162.0125-167.17	3260-3267	23.6-24.0
12.29-12.293	167.72-173.2	3332-3339	31.2-31.8
12.51975-12.52025	240-285	3345.8-3358	36.43-36.5
12.57675-12.57725	322-335.4	3600-4400	Above 38.6
13.36-13.41			

Spectrum Parameter	Setting
Detector	Peak
Attenuation	Auto
Start Frequency	1000 MHz
Stop Frequency	10th carrier harmonic
RB / VB (emission in restricted band)	1MHz / 3MHz

Receiver Parameter	Setting
Attenuation	Auto
Start ~ Stop Frequency	9kHz~90kHz / RB 200Hz for PK & AV
Start ~ Stop Frequency	90kHz~110kHz / RB 200Hz for QP
Start ~ Stop Frequency	110kHz~490kHz / RB 200Hz for PK & AV
Start ~ Stop Frequency	490kHz~30MHz / RB 9kHz for QP
Start ~ Stop Frequency	30MHz~1000MHz / RB 120kHz for QP



4.2 TEST PROCEDURE

- a. The test is performed in a 3m Semi-Anechoic Chamber; the antenna factor, cable loss and so on of the site (factors) is calculated to correct the reading. The EUT is placed on a 0.8m high insulating Turn Table, and keeps 3m away from the Test Antenna, which is mounted on a variable-height antenna master tower.
During test, The table was rotated 360 degrees to determine the position of the highest radiation.
- b. In the frequency range of 9KHz to 30MHz, magnetic field is measured with Loop Test Antenna. The Test Antenna is positioned with its plane vertical at 1m distance from the EUT. The center of the Loop Test Antenna is 1m above the ground. During the measurement the Loop Test Antenna rotates about its vertical axis for maximum response at each azimuth about the EUT.
- c. In the frequency range 30MHz-1GHz, Bi-Log Test Antenna used. Test Antenna is 3m away from the EUT. Test Antenna height is varied from 1m to 4m above the ground to determine the maximum value of the field strength. The emission levels at both horizontal and vertical polarizations should be tested.
- d. In the frequency above 1GHz, Place the measurement antenna 3m away from the EUT for each area of the EUT determined to be a source of emissions at the specified measurement distance, while keeping the measurement antenna aimed at the source of emissions at each frequency of significant emissions, with polarization oriented for maximum response. The measurement antenna elevation for maximum emissions shall be restricted to a range of heights of from 1 m to 4 m above the ground or reference ground plane.
- f. The initial step in collecting conducted emission data is a spectrum analyzer peak detector mode pre-scanning the measurement frequency range. Significant peaks are then marked and then Quasi Peak detector mode re-measured.
- g. If the Peak Mode measured value compliance with and lower than Quasi Peak Mode Limit, the EUT shall be deemed to meet QP Limits and then no additional QP Mode measurement performed.
- h. For the actual test configuration, please refer to the related Item –EUT Test Photos.

Both horizontal and vertical antenna polarities and performed pretest to three orthogonal axis were tested. The worst case emissions were reported

4.3 DEVIATION FROM TEST STANDARD

No deviation

4.4 TEST SETUP

(A) Radiated Emission Test-Up Frequency Below 30MHz

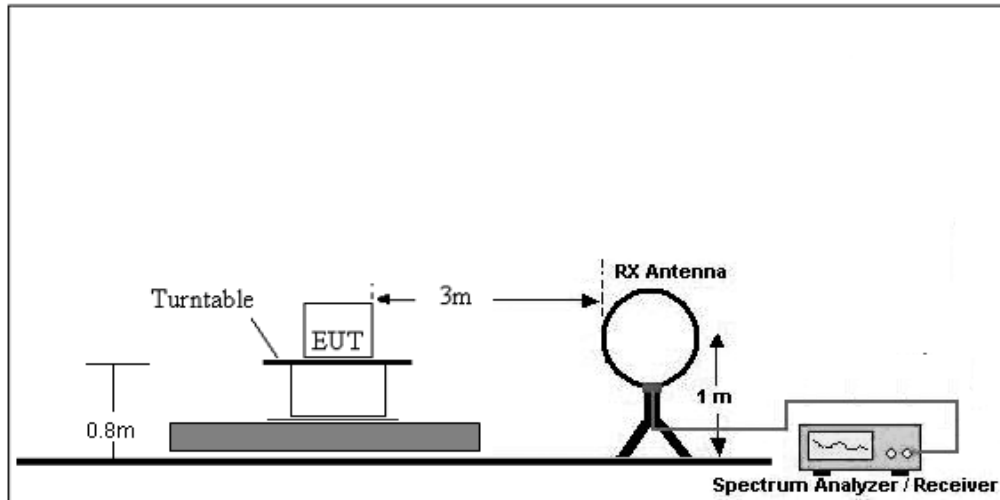

(B) Radiated Emission Test-Up Frequency 30MHz~1GHz

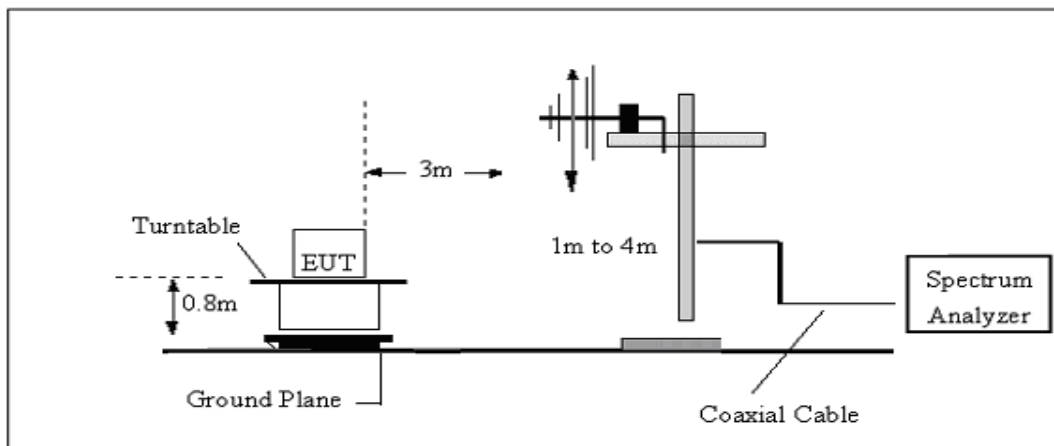

(C) Radiated Emission Test-Up Frequency Above 1GHz

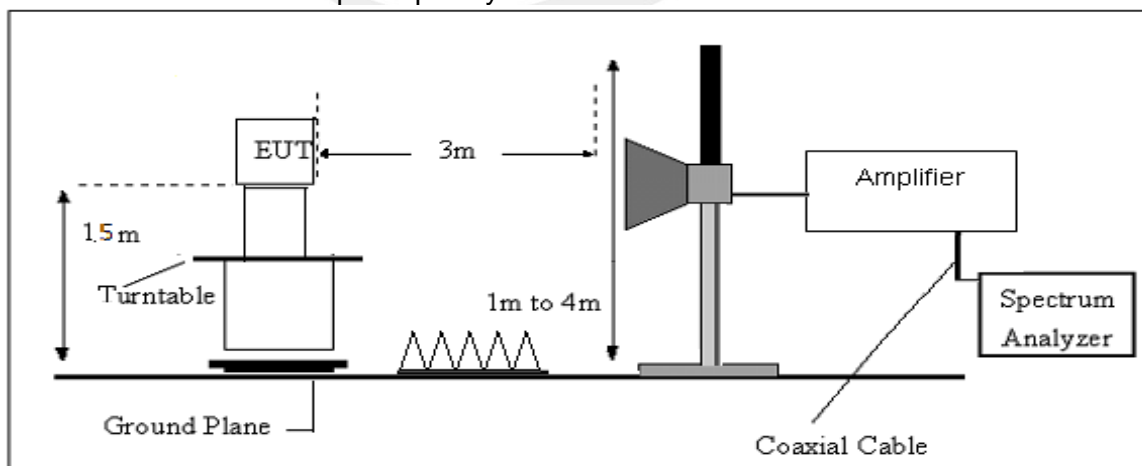

4.5 EUT OPERATING CONDITIONS

The EUT tested system was configured as the statements of 2.4 Unless otherwise a special operating condition is specified in the follows during the testing.

4.6 TEST RESULTS

INTRODUCTION TO PDCF

Reference: (§15.35 Measurement detector functions and bandwidths.)

- a. Part 15 of the FCC Rules provides for the operation of low power communication devices without an individual license (e.g., intrusion detectors, pulsed water tank level gauges, etc.), subject to certain requirements. Some of these devices use extremely narrow pulses to generate wideband emissions, which are measured to determine compliance with the rules. These measurements are typically performed with a receiver or spectrum analyzer. Depending on a number of factors (e.g., resolution bandwidth, pulsewidth, etc.), the spectrum analyzer may not always display the true peak value of the measured emission. This effect, called “pulse desensitization,” relates to the capabilities of the measuring instrument. For the measurement and reporting of the true peak of pulsed emissions, it may be necessary to apply a “pulse desensitization correction factor” (PDCF) to the measured value, pursuant to 47 CFR 15.35(a).

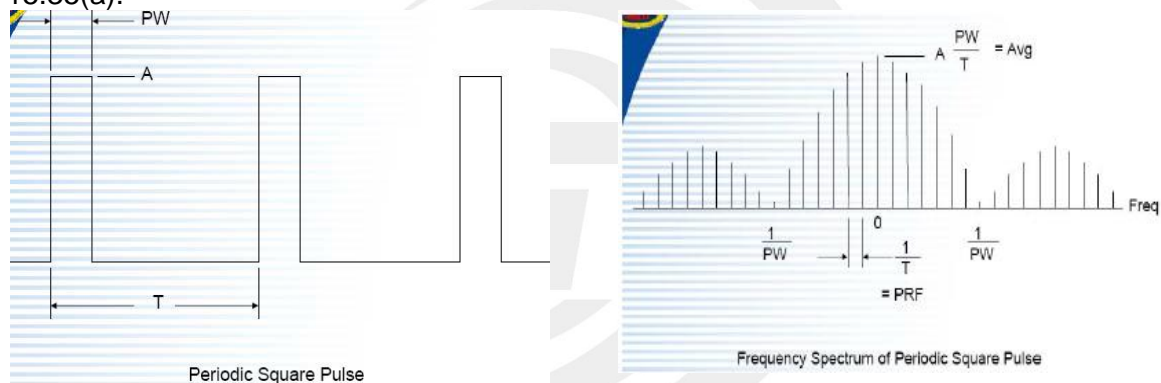

If using spectrum analyzer to measure pulse signal, it have to make sure the RBW use is at least $2/PW$.

•When RBW is less than $2/PW$, you are able to measure the true peak level of the pulse signal. If this is the case, PDCF is required to compensate to determine true peak value.

Pulse desensitization:

$PW = 100000 \text{ usec}$, $\text{Period} = 100000 \text{ usec}$, $\text{Level} = A$

$RBW > 2/PW = 0.02K$, $1/T = 0.01K$

NOTE: $2 / PW < RBW$, first don't need

- b. For the actual test, please refer to the ANSI C63.10, Annex C refer to section 6. for more detail



4.7 FIELD STRENGTH CALCULATION

The field strength is calculated by adding the Antenna Factor and Cable Factor and subtracting the Amplifier Gain and Duty Cycle Correction Factor (if any) from the measured reading. The basic equation with a sample calculation is as follows:

$$FS = RA + AF + CL - AG$$

Where

FS = Field Strength

CL = Cable Attenuation Factor (Cable Loss)

RA = Reading Amplitude

AG = Amplifier Gain

AF = Antenna Factor

For example

Frequency (MHz)	FS (dB μ V/m)	RA (dB μ V/m)	AF (dB)	CL (dB)	AG (dB)	Factor (dB)
300	40	58.1	12.2	1.6	31.9	-18.1

$$\text{Factor} = \text{AF} + \text{CL} - \text{AG}$$

4.8 TEST RESULTS

(Radiated Emission < 30MHz (9KHz-30MHz, H-field))

Freq. (MHz)	Reading (dBuV/m)	Limit (dBuV/m)	Margin (dB)	State P/F
--	--	--	--	PASS
--	--	--	--	PASS

Note: The amplitude of spurious emissions which are attenuated by more than 20dB below the permissible value has no need to be reported.

Distance extrapolation factor = $40 \log(\text{specific distance}/\text{test distance})$ (dB);

Limit line = specific limits (dBuV) + distance extrapolation factor.



Between 30MHz – 5000 MHz

Temperature:	23.1 °C	Relative Humidity:	60%
Test Voltage:	DC 5V	Phase:	Horizontal
Test Mode:	Mode 1		

No.	Frequency (MHz)	Reading (dBuV)	Correct Factor(dB/m)	Result (dBuV/m)	Limit (dBuV/m)	Margin (dB)	Remark
1	125.0600	40.53	-18.22	22.31	43.50	-21.19	QP
2	267.6500	36.50	-15.06	21.44	46.00	-24.56	QP
4	561.5600	36.79	-5.51	31.28	46.00	-14.72	QP
5	741.9800	36.45	-2.12	34.33	46.00	-11.67	QP
6	918.5200	57.62	-0.05	57.57	61.62	-4.05	QP

Fundamental Frequency

No.	Frequency (MHz)	Reading (dBuV)	Correct Factor(dB/m)	Duty cycle Factor(dB/m)	Result (dBuV/m)	Limit (dBuV/m)	Margin (dB)	Remark
3	459.1000	87.34	-9.48	-	77.86	81.62	-3.76	QP

Remark:

1. All readings are Quasi-Peak and Average values
2. Margin = Result (Result =Reading + Factor)–Limit
3. Factor=LISN factor+Cable loss+Limiter (10dB)

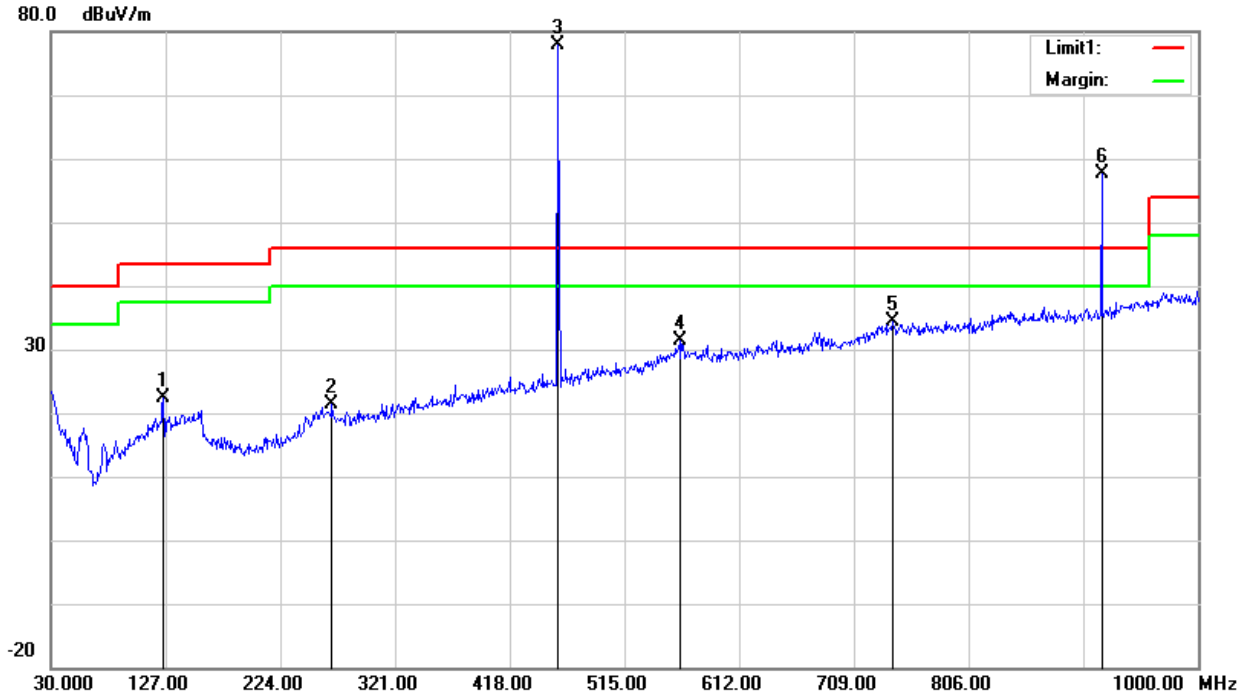



Temperature:	23.1 °C	Relative Humidity:	60%
Test Voltage:	DC 5V	Phase:	Vertical
Test Mode:	Mode 1		

No.	Frequency (MHz)	Reading (dBuV)	Correct Factor(dB/m)	Result (dBuV/m)	Limit (dBuV/m)	Margin (dB)	Remark
1	30.9700	44.91	-13.35	31.56	40.00	-8.44	QP
2	353.9800	36.36	-12.98	23.38	46.00	-22.62	QP
4	740.0400	37.08	-2.11	34.97	46.00	-11.03	QP
5	869.0500	39.29	-0.52	38.77	46.00	-7.23	QP
6	918.5200	54.11	-0.05	54.06	61.62	-7.56	QP

Fundamental Frequency

No.	Frequency (MHz)	Reading (dBuV)	Correct Factor(dB/m)	Duty cycle Factor(dB/m)	Result (dBuV/m)	Limit (dBuV/m)	Margin (dB)	Remark
3	459.1000	87.79	-9.48	-	78.31	81.62	-3.31	QP

Remark:

1. All readings are Quasi-Peak and Average values
2. Margin = Result (Result = Reading + Factor) – Limit
3. Factor=LISN factor+Cable loss+Limiter (10dB)

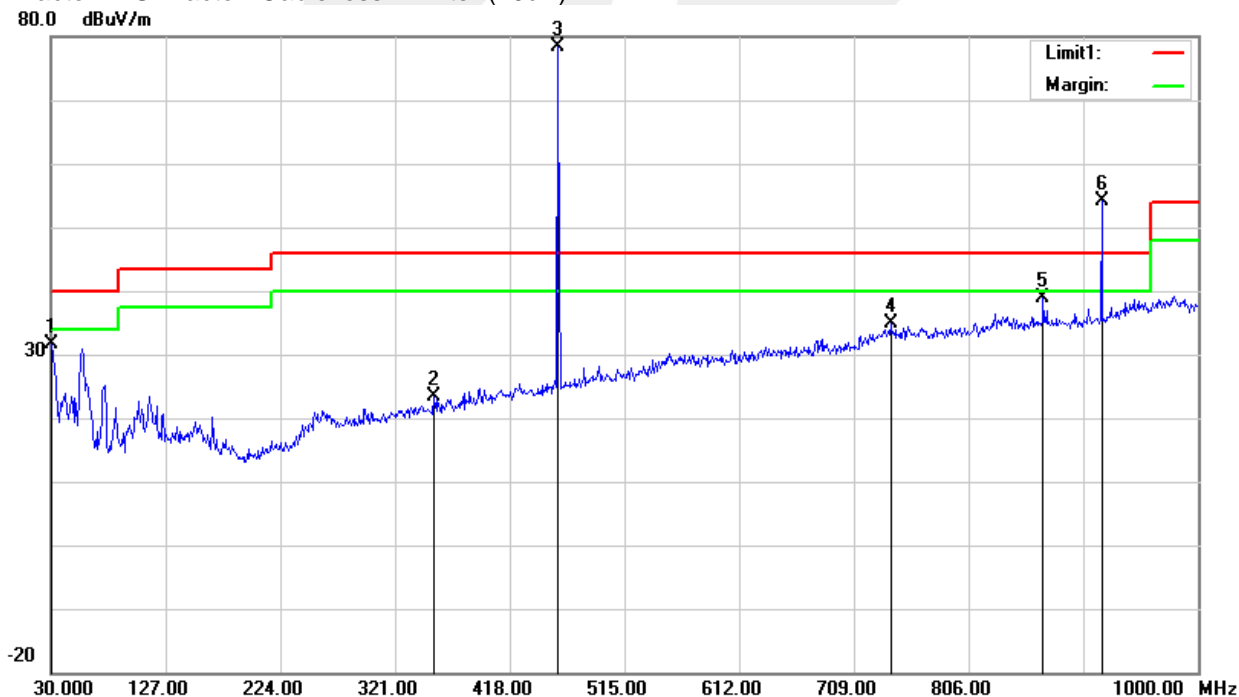



PEAK TEST RESULTS:

Frequency	Reading	Detector	Amplifier	Loss	Antenna Factor	Corrected Factor	Corrected Amplitude	FCC Part 15.231/15.209/205		RX
								Limit	Margin	Antenna
(MHz)	(dB μ V/m)	(PK/QP/AV)	(dB)	(dB)	(dB)	(dB)	(dB μ V/m)	(dB μ V/m)	(dB)	(H/V)
1377.35	55.06	PK	45.1	4.0	25.1	-16.00	39.06	74	-34.94	H
1377.35	55.84	PK	45.1	4.0	25.1	-16.00	39.84	74	-34.16	V
1836.44	52.84	PK	44.1	5.3	25	-13.80	39.04	74	-34.96	H
1836.44	54.37	PK	44.1	5.3	25	-13.80	40.57	74	-33.43	V
2295.39	51.37	PK	43.8	5.4	25.9	-12.47	38.90	74	-35.10	H
2295.39	51.92	PK	43.8	5.4	25.9	-12.47	39.45	74	-34.55	V

Note: 1. Above 2.6 GHz The amplitude of spurious emissions which are attenuated by more than 20dB below the permissible value has no need to be reported.
2. The PK value is less than the AV limit, so AV data does not need to be tested.

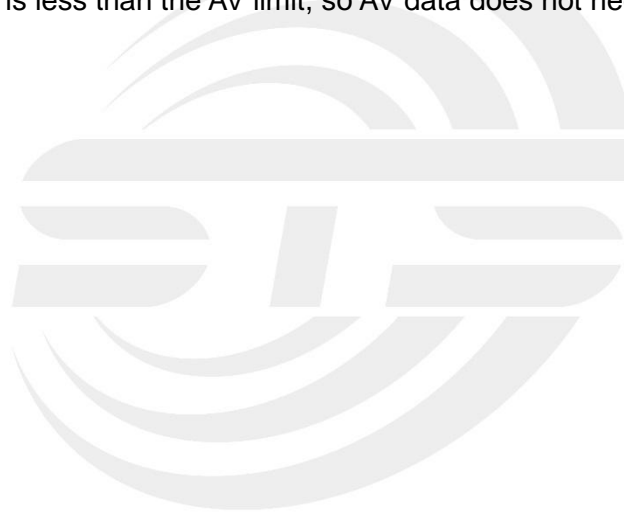

5. BANDWIDTH TEST

5.1 LIMIT

FCC Part15.231,Subpart C				
Section	Test Item	Limit	Frequency Range (MHz)	Result
15.231(C)	20 Bandwidth	The20dB bandwidth of the emissions shall not exceed 0.25% of the center frequency	459.1	PASS

Spectrum Parameter	Setting
Attenuation	Auto
Span Frequency	> Measurement Bandwidth
RB	300 Hz (20dB Bandwidth)
VB	910 Hz (20dB Bandwidth)
Detector	Peak
Trace	Max Hold
Sweep Time	Auto

5.2 TEST REQUIREMENTS

The bandwidth of the emission shall be no wider than 0.25% of the center frequency for devices operating above 70 MHz and below 900 MHz. For devices operating above 900 MHz, the emission shall be no wider than 0.5% of the center frequency. Bandwidth is determined at the points 20 dB down from the modulated carrier.

5.3 TEST PROCEDURE

- a. The EUT was directly connected to the spectrum analyzer and antenna output port as show in the block diagram below.
- b. Spectrum Setting: RBW= 300Hz, VBW=910Hz, Sweep time = Auto.

5.4 TEST SETUP



5.5 EUT OPERATION CONDITIONS

TX mode.



5.6 TEST RESULTS

Centre Frequency	Measurement		
	20dB Bandwidth (KHz)	Limit(kHz)	Frequency Range (MHz)
459.1 MHz	13.37	1148	PASS

459.1MHz

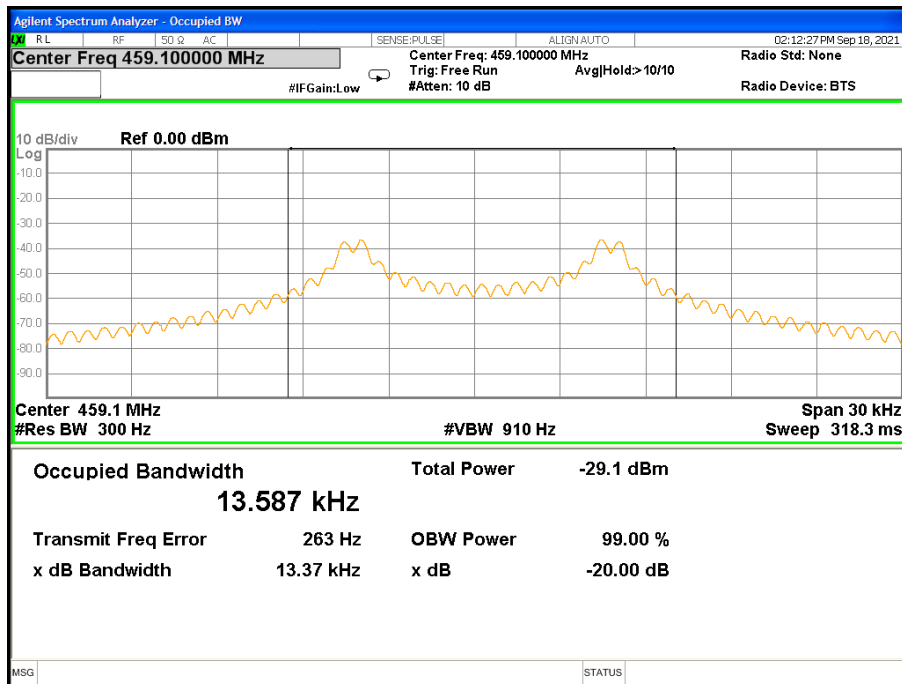

6. DUTY CYCLE

6.1 TEST PROCEDURE

The EUT was directly connected to the spectrum analyzer and antenna output port as show in the block diagram below.

The Duty Cycle Was Determined By The Following Equation: To Calculate The Actual Field Intensity,The Duty Cycle Correction Factor In Decibel Is Needed For Later Use And Can Be Obtained From Following Conversion

Duty Cycle(%)=Total On Interval In A Complete Pulse Train/ Length Of A Complete Pulse Train * %

Duty Cycle Correction Factor(Db)=20 * Log10(Duty Cycle(%))

6.2 TEST SETUP



6.3 EUT OPERATION CONDITIONS

TX mode.



6.4 TEST RESULTS

FCC Part15.231(a)	
Total On interval in a complete pulse train(ms)	100
Length of a complete pulse train(ms)	100
Duty Cycle (%)	100%
Duty Cycle Correction Factor(dB)	0.00

Refer to the duty cycle plot (as below), This device meets the FCC requirement. Length of a complete pulse train

Remark:FCC part15.35(c) required that a complete pulse train is more than 0.1 seconds, the measured field strength shall be determined from the average absolute voltage during a 0.1 second interval during which the field strength is at its maximum value.

TX Mode

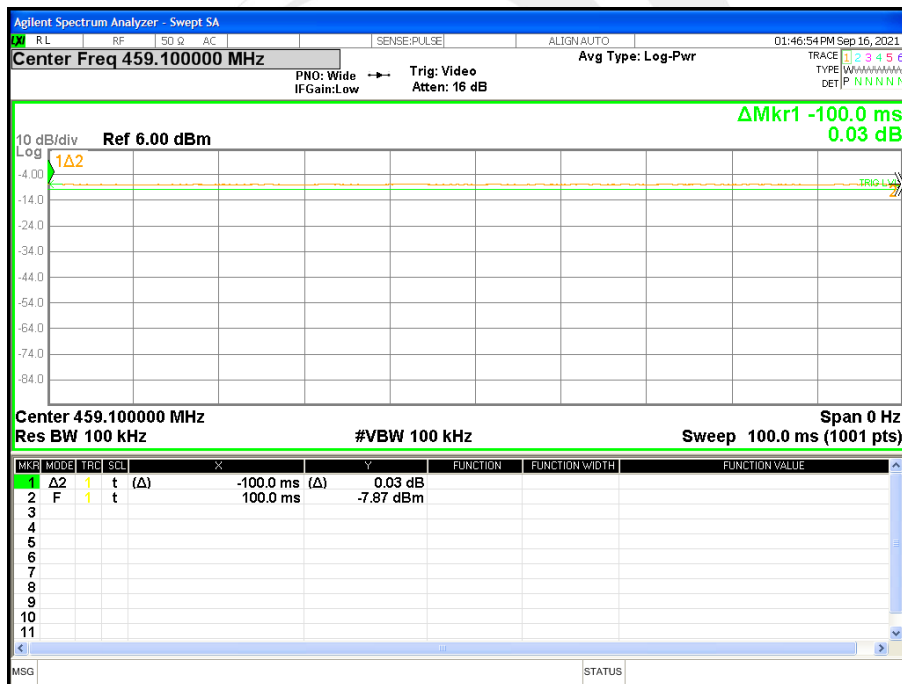

7. AUTOMATICALLY DEACTIVATE

7.1 STANDARD REQUIREMENT

A manually operated transmitter shall employ a switch that will automatically deactivate the transmitter within not more than 5 seconds of being released.

7.2 TEST PROCEDURE

The EUT was directly connected to the spectrum analyzer and antenna output port as show in the block diagram below.

Spectrum Setting : RBW= 100KHz, VBW=300KHz, Sweep time = Auto.

Note: Only press launch about 0.15 s

Note:

(1)Refer to the plot (As Below),We find a manually operated transmitter shall employ a switch that will automatically deactivate the transmitteri immediatly, within not more than 5 seconds of being released.

(2)The EUT is comply with FCC PART 15 clause 15.231(a)(1) manually working mode are pre-tested and only the worst result is reported.

7.3 TEST SETUP





7.4 TEST RESULTS

Activation time	Limit(Sec)	Result
1.16 s	5 s	Pass



Mark 1: Hold down the Key(Start transmitting)

Mark 2: Loose the Key

Mark 3: Stop transmitting

Activation time= Mark 3 - Mark 1=1.660-0.500=1.16 s



8. ANTENNA REQUIREMENT

8.1 STANDARD REQUIREMENT

According to the FCC Part 15 Paragraph 15.203, an intentional radiator shall be designed to ensure that no antenna other than that furnished by the responsible party shall be used with the device. The use of a permanently attached antenna to the intentional radiator shall be considered sufficient to comply with the provisions of this section.

8.2 EUT ANTENNA

The EUT antenna is Rod Antenna with BNC connector use adhesive to make sure permanently attached. It conforms to the standard requirements.





APPENDIX 1-PHOTOS OF TEST SETUP

Note: See test photos in setup photo document for the actual connections between Product and support equipment.

*****END OF THE REPORT*****

