



Certificate #5376.01



**EUROFINS ELECTRICAL TESTING SERVICE (SHENZHEN) Co., LTD.**

# **RADIO TEST - REPORT**

**FCC Compliance Test Report**

**Product name: Door Monitor Tester**

**Model name: DMT-21**

**FCC ID: WNG-DMT-21**

**Test Report Number: EFGX23080002-IE-01-E03**

## Content

<b>1</b>	<b>General Information</b>	<b>3</b>
1.1	Notes	3
1.2	Testing laboratory	4
1.3	Details of approval holder	4
1.4	Details of Manufacturer	4
1.5	Application details	4
1.6	Test item	4
1.7	Test standards	5
<b>2</b>	<b>Technical test</b>	<b>6</b>
2.1	Summary of test results	6
2.2	Test environment	6
2.3	Measurement uncertainty	6
2.4	Test mode	6
2.5	Test equipment utilized	7
2.6	Auxiliary Equipment Used during Test:	7
2.7	Test software information	7
2.8	Customized Configurations	7
2.9	Test Environments	7
2.10	Test setup	8
2.11	Test results	11
<b>3</b>	<b>Technical Requirement</b>	<b>12</b>
3.1	Conducted emission AC power port	12
3.2	20 dB bandwidth	13
3.3	Radiated emission	15

## 1 General Information

### 1.1 Notes

The results of this test report relate exclusively to the item tested as specified in chapter “Description of test item” and are not transferable to any other test items.

Eurofins Product Testing Service (Shenzhen) Co., Ltd. is not responsible for any generalisations and conclusions drawn from this report. Any modification of the test item can lead to invalidity of test results and this test report may therefore be not applicable to the modified test item.

The test report may only be reproduced or published in full. Reproducing or publishing extracts of the report requires the prior written approval of the Eurofins Product Testing Service (Shenzhen) Co., Ltd.

This document is subject to the General Terms and Conditions and the Testing and Certification System of Eurofins Product Testing Service (Shenzhen) Co., Ltd., available on request or accessible at [www.eurofins.com](http://www.eurofins.com).

#### Operator:

2023-10-12		Bruce Zheng / Project Engineer	
Date	Eurofins-Lab.	Name / Title	Signature

#### Technical responsibility for area of testing:

2023-10-12		Albert Xu / Lab Manager	
Date	Eurofins-Lab.	Name / Title	Signature

## 1.2 Testing laboratory

### **Eurofins Electrical Testing Service (Shenzhen) Co., Ltd.**

1st Floor, Building 2, Chungu, Meisheng Huigu Science and Technology Park, No. 83 Dabao Road, Bao'an District, Shenzhen. P.R.China.

Telephone : +86-755-82911867

Fax : +86-755-82910749

The Laboratory has passed the Accreditation by the American Association for Laboratory Accrediation (A2LA). The Accreditation number is 5376.01

The Laboratory has been listed by industry Canada to perform electromagnetic emission measurements, The CAB identifier is CN0088

## 1.3 Details of approval holder

Name : Rondish Co. Ltd  
Address : UNIT G&H, 4/F, Block 1, KWAI TAK IND. CTR, 15-33 K  
HONGKONG, China  
Telephone : ./.  
Fax : ./.

## 1.4 Details of Manufacturer

Name : Rondish Co. Ltd  
Address : UNIT G&H, 4/F, Block 1, KWAI TAK IND. CTR, 15-33 K  
HONGKONG, China  
Telephone : ./.  
Fax : ./.

## 1.5 Application details

Date of receipt of application : 2023-08-01  
Date of receipt of test item : 2023-08-01  
Date of test : 2023-08-01 to 2023-09-22  
Date of issue : 2023-10-12

## 1.6 Test item

Product type : Door Monitor Tester  
Model name : DMT-21  
Brand : Rondish  
Serial number : N/A  
Ratings : 9V Battery  
Test voltage : DC 9V  
FCC ID : WNG-DMT-21  
PMN : Door Monitor Tester  
Additional information : N/A

### **RadioTechnical data**

Frequency range : 20KHz  
Radio Tech. : N/A  
Frequency channel : 1 Channel  
Modulation : OOK  
Antenna type : Internal antenna

## 1.7 Test standards

<b>Test Standards</b>	
FCC Part 15 Subpart C 2018 Edition	PART 15 - RADIO FREQUENCY DEVICES Subpart C - Intentional Radiators

### Test Method

- 1: ANSI C63.4-2014, American National Standard for Methods of Measurement of Radio-Noise Emissions from Low-Voltage Electrical and Electronic Equipment in the Range of 9 kHz to 40 GHz.
- 2: ANSI C63.10-2013, American National Standard for Testing Unlicensed Wireless Devices.

## 2 Technical test

### 2.1 Summary of test results

No deviations from the technical specification(s) were ascertained in the course of the tests performed.

or

The deviations as specified were ascertained in the course of the tests performed.

### 2.2 Test environment

Temperature : 20 ... 25°C  
 Relative humidity content : 30 ... 60%  
 Air pressure : 100 ... 101kPa

### 2.3 Measurement uncertainty

The uncertainty is calculated using the methods suggested in the "Guide to the Expression of Uncertainty in Measurement" (GUM) published by ISO.

System Measurement Uncertainty	
Test Items	Extended Uncertainty
Uncertainty for Conducted RF test	RF Power Conducted: 1.16dB Frequency test involved: 1.05×10 <sup>-7</sup> or 1%
Uncertainty for Radiated Spurious Emission 25MHz-3000MHz	Horizontal: 4.46dB; Vertical: 4.54dB;
Uncertainty for Radiated Spurious Emission 3000MHz-18000MHz	Horizontal: 4.42dB; Vertical: 4.41dB;
Uncertainty for Radiated Spurious Emission 18000MHz-40000MHz	Horizontal: 4.63dB; Vertical: 4.62dB;

### 2.4 Test mode

The EUT was set at continuously transmitting during the test.

## 2.5 Test equipment utilized

EQUIPMENT ID	EQUIPMENT NAME	MODEL NO.	CAL. DUE DATE
23-2-13-01	EMI Test Receiver	ESR7	2024-03-22
23-2-13-02	Signal Analyzer	N9020B-544	2024-03-22
23-2-12-01	Active Loop Antenna	FMZB 1519B	2024-05-29
23-2-12-02	TRILOG Broadband Antenna	VULB9168	2024-05-29
23-2-12-03	Horn Antenna	3117	2024-05-29
23-2-12-04	Horn Antenna	BBHA 9170	2024-05-29
23-2-12-05	Universal Antenna Stand	CLSA0110	2024-03-22
23-2-10-01	Preamplifier	BBV9745	2024-03-22
23-2-10-02	Preamplifier	EMC001330	2024-03-22
23-2-10-03	Preamplifier	EMC051845SE	2024-03-22
23-2-10-14	Switch and Control Unit	ERIT-E-JS0806-SF1	N/A

## 2.6 Auxiliary Equipment Used during Test:

DESCRIPTION	MANUFACTURER	MODEL NO.	S/N
N/A	N/A	N/A	N/A

## 2.7 Test software information

Test Software Version	N/A		
Modulation	Setting TX Power	TX Pattern	Packet Type
OOK	Default	Default	Default

## 2.8 Customized Configurations

EUT Conf.	Signal Description	Operating Frequency
TM1	OOK	20KHz

## 2.9 Test Environments

Environment Parameter	Temperature	Voltage	Relative Humidity
101.7Kpa	26.5°C	9Vdc	52.3%

## 2.10 Test setup

Ac line conducted

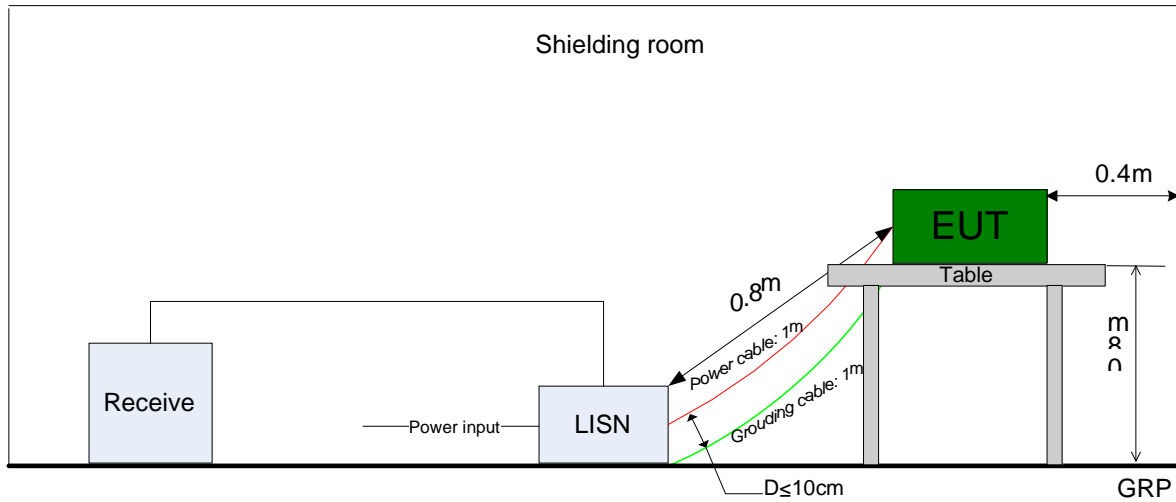

RF Conducted tests

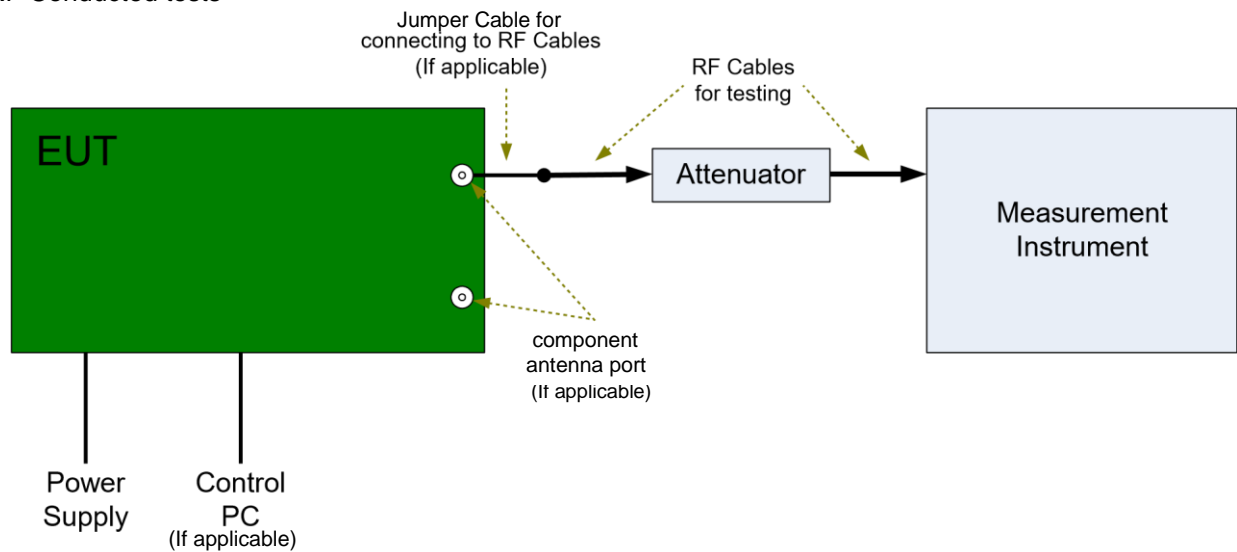



## Radiated tests below 30MHz

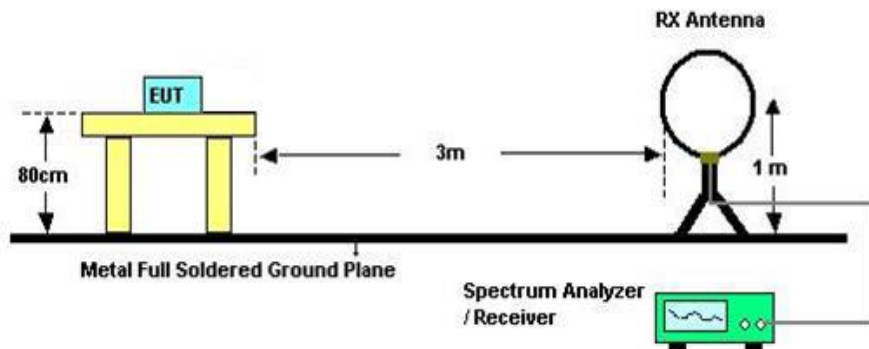

## Radiated tests below 1GHz

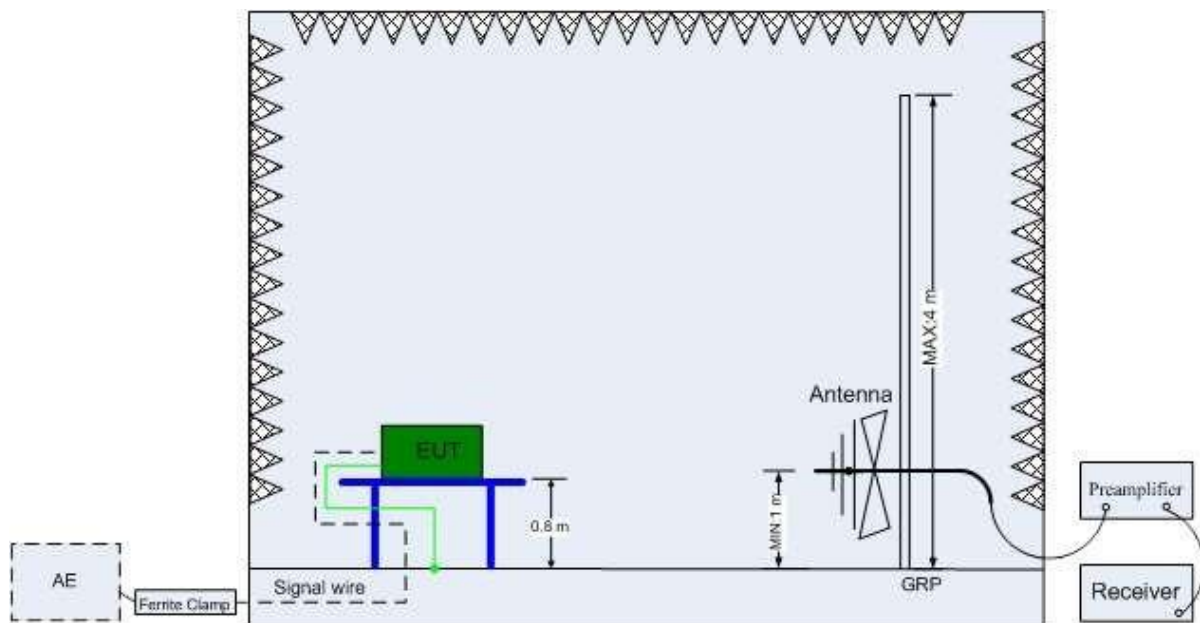

## Radiated tests above 1GHz

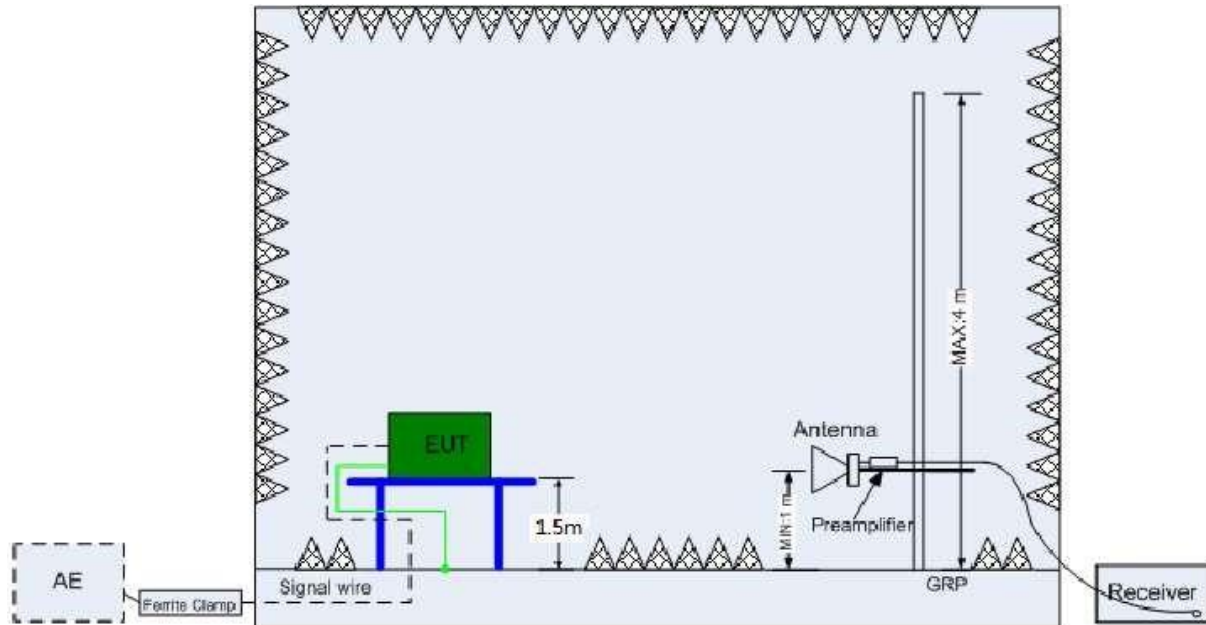

## 2.11 Test results

 1<sup>st</sup> test

 test after modification

 production test

Technical Requirements				
FCC Part 15 Subpart C				
Test Condition		Test Result	Verdict	Test Site
§15.207	Conducted emission AC power port	N/A	N/A	N/A
§15.215(c)(1)	20dB bandwidth	See page 14	Pass	Site 1
§15.249(a)&(d) & §15.209 & §15.205	Radiated emission	See page 17	Pass	Site 1
§15.203	Antenna requirement	See note 1	Pass	--

Remark 1: N/A – Not Applicable.

Note 1: The EUT uses a internal antenna. According to §15.203, it is considered sufficiently to comply with the provisions of this section.

### 3 Technical Requirement

#### 3.1 Conducted emission AC power port

**Test Method:**

The test method was referred to the subclause 6.2 of ANSI C63.10-2013.

The EUT is placed on a non-conducting table 40 cm from the vertical ground plane and 80 cm above the horizontal ground plane. The EUT is configured in accordance with ANSI C63.10.

The receiver is set to a resolution bandwidth of 9 kHz. Peak detection is used unless otherwise noted as quasi-peak or average.

Line conducted data is recorded for both Neutral and Live lines.

**Limit:**

FCC §15.207 (a)

Frequency	QP Limit	AV Limit
MHz	dB $\mu$ V	dB $\mu$ V
0.150-0.500	66-56*	56-46*
0.500-5	56	46
5-30	60	50

Decreasing linear.

**Test Result:**

Not Applicable

## 3.2 20 dB bandwidth

### Test Method:

The test method was referred to the subclause 6.9.2 of ANSI C63.10-2013.

The occupied bandwidth is measured as the width of the spectral envelope of the modulated signal, at an amplitude level reduced from a reference value by a specified ratio (or in decibels, a specified number of dB down from the reference value). Typical ratios, expressed in dB, are -6 dB, -20 dB, and -26 dB, corresponding to 6 dB BW, 20 dB BW, and 26 dB BW, respectively. In this subclause, the ratio is designated by “-xx dB.” The reference value is either the level of the unmodulated carrier or the highest level of the spectral envelope of the modulated signal, as stated by the applicable requirement. Some requirements might specify a specific maximum or minimum value for the “-xx dB” bandwidth; other requirements might specify that the “-xx dB” bandwidth be entirely contained within the authorized or designated frequency band.

- a) The spectrum analyzer center frequency is set to the nominal EUT channel center frequency. The span range for the EMI receiver or spectrum analyzer shall be between two times and five times the OBW.
- b) The nominal IF filter bandwidth (3 dB RBW) shall be in the range of 1% to 5% of the OBW and video bandwidth (VBW) shall be approximately three times RBW, unless otherwise specified by the applicable requirement.
- c) Set the reference level of the instrument as required, keeping the signal from exceeding the maximum input mixer level for linear operation. In general, the peak of the spectral envelope shall be more than  $[10 \log (OBW/RBW)]$  below the reference level. Specific guidance is given in 4.1.5.2.
- d) Steps a) through c) might require iteration to adjust within the specified tolerances.
- e) The dynamic range of the instrument at the selected RBW shall be more than 10 dB below the target “-xx dB down” requirement; that is, if the requirement calls for measuring the -20 dB OBW, the instrument noise floor at the selected RBW shall be at least 30 dB below the reference value.
- f) Set detection mode to peak and trace mode to max hold.
- g) Determine the reference value: Set the EUT to transmit an unmodulated carrier or modulated signal, as applicable. Allow the trace to stabilize. Set the spectrum analyzer marker to the highest level of the displayed trace (this is the reference value).
- h) Determine the “-xx dB down amplitude” using  $[(\text{reference value}) - xx]$ . Alternatively, this calculation may be made by using the marker-delta function of the instrument.
- i) If the reference value is determined by an unmodulated carrier, then turn the EUT modulation ON, and either clear the existing trace or start a new trace on the spectrum analyzer and allow the new trace to stabilize. Otherwise, the trace from step g) shall be used for step j).
- j) Place two markers, one at the lowest frequency and the other at the highest frequency of the envelope of the spectral display, such that each marker is at or slightly below the “ixx dB down amplitude” determined in step h). If a marker is below this “-xx dB down amplitude” value, then it shall be as close as possible to this value. The occupied bandwidth is the frequency difference between the two markers. Alternatively, set a marker at the lowest frequency of the envelope of the spectral display, such that the marker is at or slightly below the “ixx dB down amplitude” determined in step h). Reset the marker-delta function and move the marker to the other side of the emission until the delta marker amplitude is at the same level as the reference marker amplitude. The marker-delta frequency reading at this point is the specified emission bandwidth.
- k) The occupied bandwidth shall be reported by providing plot(s) of the measuring instrument display; the plot axes and the scale units per division shall be clearly labeled. Tabular data may be reported in addition to the plot(s).

**Limit:**

None; for reporting purposes only.

**Test Result:**

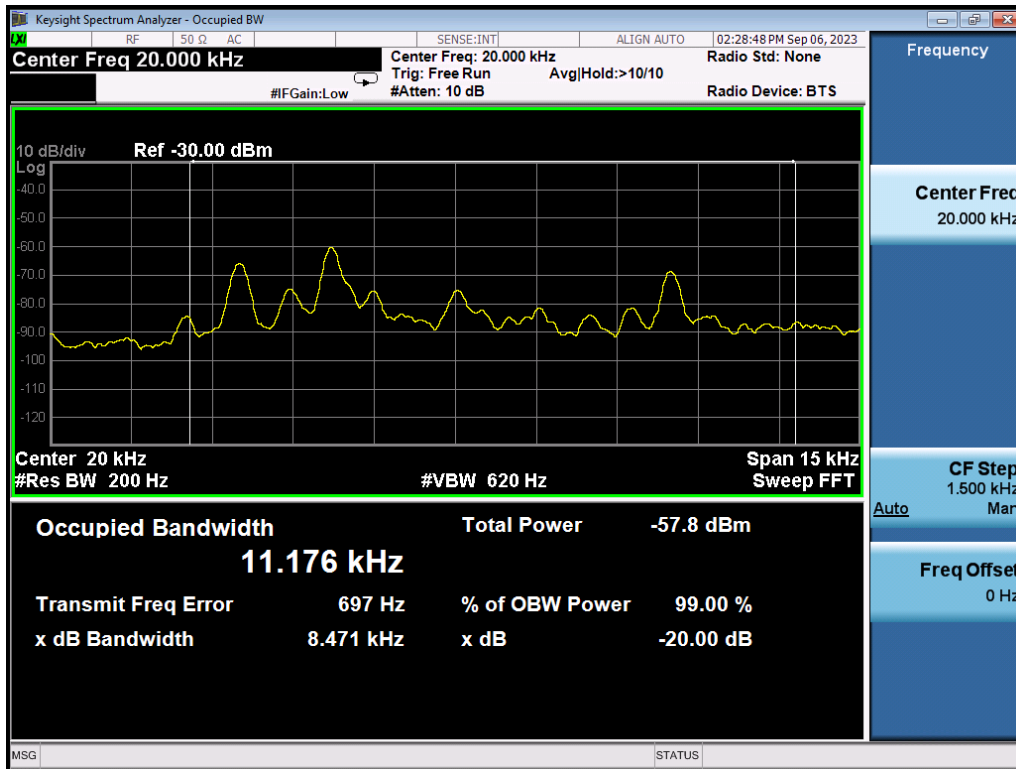

**Test Graphs**

### 3.3 Radiated emission

#### Test Method:

The test method was referred to the subclause 11.11/11.12 of ANSI C63.10-2013.

- 1: The EUT was placed on a turn table which is 1.5m above ground plane for above 1GHz and 0.8m above ground for below 1GHz at 3 meter chamber room for test. The table was rotated 360 degrees to determine the position of the highest radiation.
- 2: The EUT was set 3 meters away from the interference – receiving antenna, which was mounted on the top of a variable – height antenna tower.
- 3: The height of antenna is varied from one meter to four meters above the ground to determine the maximum value of the field strength. Both horizontal and vertical polarizations of the antenna are set to make the measurement.
- 4: For each suspected emission, the EUT was arranged to its worst case and then the antenna was tuned to heights from 1 meter to 4 meters and the rotatable table was turned from 0 degrees to 360 degrees to find the maximum reading.
- 5: Use the following spectrum analyzer settings According to C63.10:

For Above 1GHz

Span = wide enough to capture the peak level of the in-band emission and all spurious  
RBW = 1MHz, VBW $\geq$ RBW for peak measurement, Sweep = auto, Detector function = peak,  
Trace = max hold.

For Below 1GHz

Use the following spectrum analyzer settings:

Span = wide enough to capture the peak level of the in-band emission and all spurious  
RBW = 100 KHz, VBW $\geq$ RBW for peak measurement, Sweep = auto, Detector function = peak,  
Trace = max hold.

For Below 30MHz

Use the following spectrum analyzer settings:

Span = wide enough to capture the peak level of the in-band emission and all spurious  
RBW = 200 Hz, VBW $\geq$ RBW from 9KHz to 0.15MHz, RBW 9KHz VBW $\geq$ RBW from 0.15MHz to 30MHz for peak measurement, Sweep = auto, Detector function = peak, Trace = max hold.

#### Note:

- 1: The resolution bandwidth and video bandwidth of test receiver/spectrum analyzer is 120 KHz for Quasi-peak detection (QP) at frequency below 1GHz.
- 2: The resolution bandwidth of test receiver/spectrum analyzer is 1MHz and the video bandwidth is 3MHz for peak detection (PK) at frequency above 1GHz.
- 3: The resolution bandwidth of test receiver/spectrum analyzer is 1MHz and the video bandwidth is 3MHz for RMS Average ((duty cycle < 98%) for Average detection (AV) at frequency above 1GHz, then the measurement results was added to a correction factor (20log(1/duty cycle)).
- 4: The resolution bandwidth of test receiver/spectrum analyzer is 1MHz and the video bandwidth is 10Hz (duty cycle > 98%) for Average detection (AV) at frequency above 1GHz.
- 5: When duty cycle <98%, The resolution bandwidth of test receiver/spectrum analyzer is 1MHz and the video bandwidth is VBW  $\geq$  1 / T, the T is transmission duration (T).

**Limit:**

FCC §15.205 and §15.209

Frequency Range (MHz)	Field Strength Limit ( $\mu\text{V/m}$ ) at 3 m	Field Strength Limit ( $\text{dB}\mu\text{V/m}$ ) at 3 m
0.009-0.490	2400/F(kHz) @ 300 m	-
0.490-1.705	24000/F(kHz) @ 30 m	-
1.705 - 30	30 @ 30m	-
30 - 88	100	40
88 - 216	150	43.5
216 - 960	200	46
Above 960	500	54

## §15.205 Restricted bands of operation

MHz	MHz	MHz	GHz
0.090-0.110	16.42-16.423	399.9-410	4.5-5.15
0.495-0.505	16.69475-16.69525	608-614	5.35-5.46
2.1735-2.1905	16.80425-16.80475	960-1240	7.25-7.75
4.125-4.128	25.5-25.67	1300-1427	8.025-8.5
4.17725-4.17775	37.5-38.25	1435-1626.5	9.0-9.2
4.20725-4.20775	73-74.6	1645.5-1646.5	9.3-9.5
6.215-6.218	74.8-75.2	1660-1710	10.6-12.7
6.26775-6.26825	108-121.94	1718.8-1722.2	13.25-13.4
6.31175-6.31225	123-138	2200-2300	14.47-14.5
8.291-8.294	149.9-150.05	2310-2390	15.35-16.2
8.362-8.366	156.52475-156.52525	2483.5-2500	17.7-21.4
8.37625-8.38675	156.7-156.9	2690-2900	22.01-23.12
8.41425-8.41475	162.0125-167.17	3260-3267	23.6-24.0
12.29-12.293	167.72-173.2	3332-3339	31.2-31.8
12.51975-12.52025	240-285	3345.8-3358	36.43-36.5
12.57675-12.57725	322-335.4	3600-4400	
13.36-13.41			



### Test Result:

The report only records the worst case.

The low frequency, which started from 9 kHz to 30MHz with X/Y/Z axis, was pre-scanned and the result which was 20dB lower than the limit line per 15.31(o) was not reported.

According to C63.10, if the peak (or quasi-peak) measured value complies with the average limit, it is unnecessary to perform an average measurement, so AV emission value did not show in below table if the peak value complies with average limit. "-" means 20db below the limit

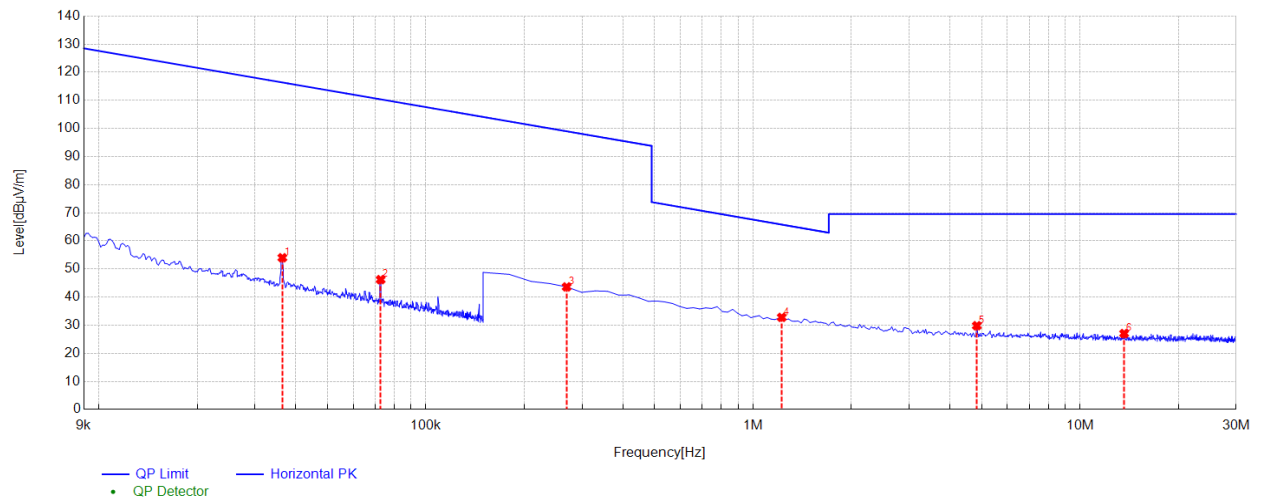

NO.	Freq. [MHz]	Reading [dBµV/m]	Level [dBµV/m]	Factor [dB/m]	Limit [dBµV/m]	Margin [dB]	Height [cm]	Angle [°]	Polarity	Verdict
1	0.0364	65.71	54.01	-11.70	116.38	62.37	100	41	X	PASS
2	0.0727	58.06	46.22	-11.84	110.36	64.14	100	303	X	PASS
3	0.2694	55.38	43.62	-11.76	98.99	55.37	100	274	X	PASS
4	1.2246	44.38	32.79	-11.59	65.79	33.00	100	312	X	PASS
5	4.8364	41.01	29.81	-11.20	69.50	39.69	100	150	X	PASS
6	13.6422	38.09	27.03	-11.06	69.50	42.47	100	176	X	PASS

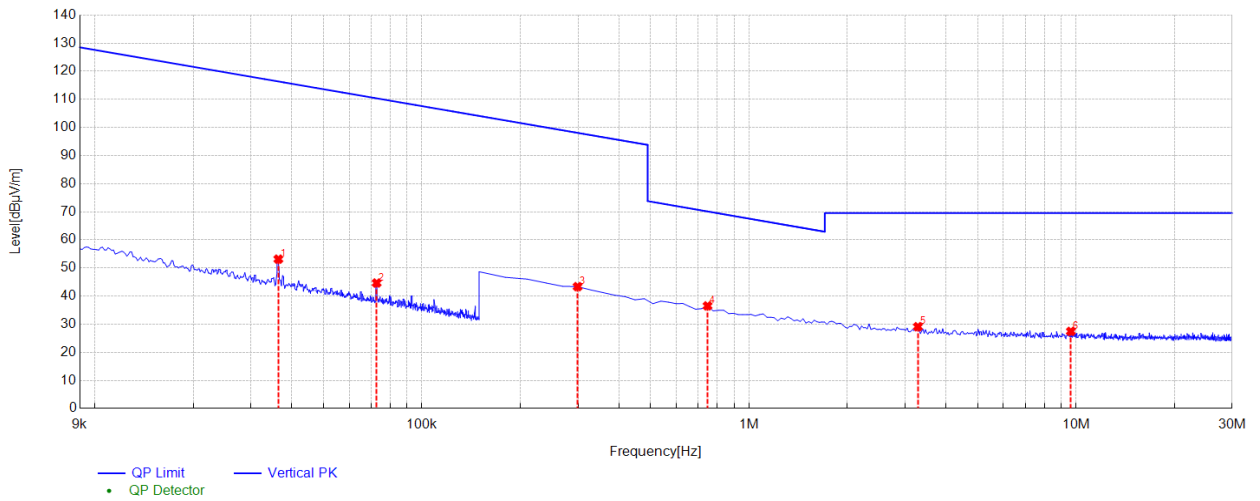

NO.	Freq. [MHz]	Reading [dBµV/m]	Level [dBµV/m]	Factor [dB/m]	Limit [dBµV/m]	Margin [dB]	Height [cm]	Angle [°]	Polarity	Verdict
1	0.0364	64.85	53.15	-11.70	116.38	63.23	100	246	Y	PASS
2	0.0727	56.50	44.66	-11.84	110.36	65.70	100	129	Y	PASS
3	0.2992	55.12	43.36	-11.76	98.08	54.72	100	295	Y	PASS
4	0.7470	48.19	36.52	-11.67	70.11	33.59	100	187	Y	PASS
5	3.2842	40.45	29.10	-11.35	69.50	40.40	100	9	Y	PASS
6	9.6423	38.43	27.45	-10.98	69.50	42.05	100	38	Y	PASS

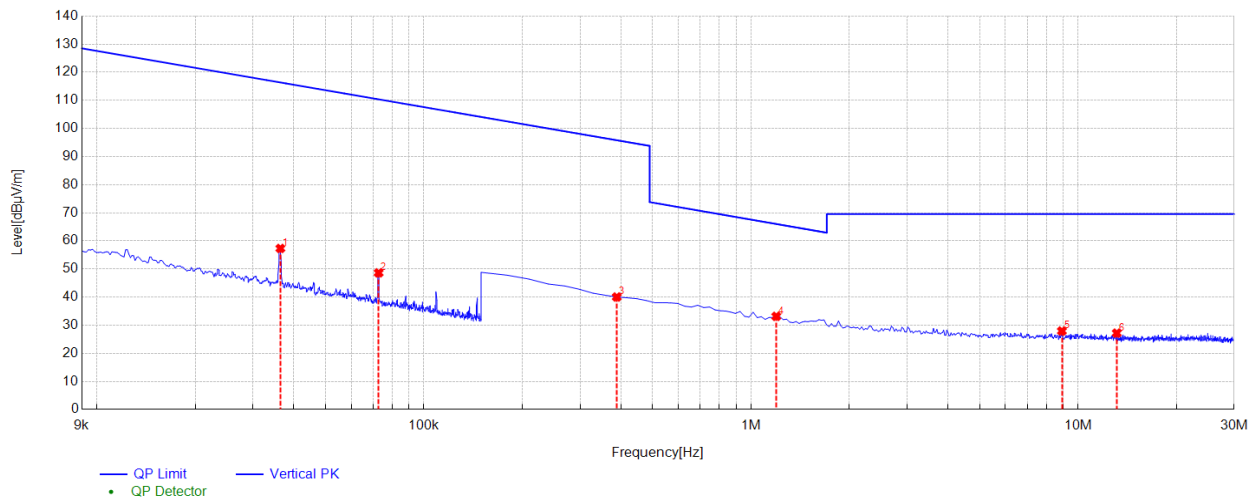

NO.	Freq. [MHz]	Reading [dBµV/m]	Level [dBµV/m]	Factor [dB/m]	Limit [dBµV/m]	Margin [dB]	Height [cm]	Angle [°]	Polarity	Verdict
1	0.0364	69.02	57.32	-11.70	116.38	59.06	100	288	Z	PASS
2	0.0727	60.46	48.62	-11.84	110.36	61.74	100	226	Z	PASS
3	0.3888	51.78	40.03	-11.75	95.81	55.78	100	223	Z	PASS
4	1.1948	44.74	33.14	-11.60	66.01	32.87	100	338	Z	PASS
5	8.9259	38.95	27.93	-11.02	69.50	41.57	100	326	Z	PASS
6	13.1348	38.24	27.18	-11.06	69.50	42.32	100	279	Z	PASS

**-END of report-**