



FCC PART 15 SUBPART C and RSS-210 TEST REPORT

FCC Part 15.249 and RSS-210 Section A2.9

Report Reference No.....: WE08080011

Compiled by

(position+printed name+signature)..: File administrators Tracy Qi

Supervised by

(position+printed name+signature)..: Test Engineer Tracy Qi

Approved by

(position+printed name+signature)..: Manager Jimmy Li

Date of issue.....: Sep 10, 2008

Testing Laboratory Name: Shenzhen Huatongwei International Inspection Co., Ltd

Address.....: Keji Nan No.12 Road, Hi-tech Park, Shenzhen, China

Applicant's name.....: Peak Products

Address.....: 45 Sterling St, West Boylston, MA, USA

Test specification:

Standard: **FCC Part 15.249: Operation within the bands 920-928 MHz, 2400-2483.5 MHz, 5725-5850 MHz and 24.0 - 24.25 GHz.**

RSS-210 Issue 7 Section A2.9 902-928, 2400-2483.5 and 5725-5875 MHz

TRF Originator.....: Shenzhen Huatongwei International Inspection CO., Ltd

Master TRF.....: Dated 2006-06

Shenzhen Huatongwei International Inspection Co., Ltd. All rights reserved.

This publication may be reproduced in whole or in part for non-commercial purposes as long as the Shenzhen Huatongwei International Inspection Co., Ltd is acknowledged as copyright owner and source of the material. Shenzhen Huatongwei International Inspection Co., Ltd takes no responsibility for and will not assume liability for damages resulting from the reader's interpretation of the reproduced material due to its placement and context.

Test item description : Wireless dongle

Trade Mark: /

Model/Type reference.....: WR-101

Listed Models: /

Result.....: **Positive**

TEST REPORT

Test Report No. :	WE08080011	Sep 10, 2008
		Date of issue

Equipment under Test : Wireless dongle

Model /Type : WR-101

Listed Models : /

Applicant : Peak Products

Address : 45 Sterling St, West Boylston, MA, USA

Test Result according to the standards on page 4:	Positive
--	-----------------

The test report merely corresponds to the test sample.

It is not permitted to copy extracts of these test result without the written permission of the test laboratory.

Contents

<u>1.</u>	<u>TEST STANDARDS</u>	<u>4</u>
<u>2.</u>	<u>SUMMARY</u>	<u>5</u>
2.1.	General Remarks	5
2.2.	Equipment Under Test	5
2.3.	Short description of the Equipment under Test (EUT)	5
2.4.	EUT operation mode	5
2.5.	EUT configuration	5
2.6.	Related Submittal(s) / Grant (s)	6
2.7.	Modifications	6
<u>3.</u>	<u>TEST ENVIRONMENT</u>	<u>7</u>
3.1.	Address of the test laboratory	7
3.2.	Test Facility	7
3.3.	Environmental conditions	8
3.4.	Configuration of Tested System	8
3.5.	Statement of the measurement uncertainty	9
3.6.	Equipments Used during the Test	9
<u>4.</u>	<u>TEST CONDITIONS AND RESULTS</u>	<u>10</u>
4.1.	Conducted Emissions Test	10
4.2.	Radiated Emission Test	12
4.3.	Band Edge Measurement	17
4.4.	20dB Bandwidth Measurement	19
<u>5.</u>	<u>TEST SETUP PHOTOS OF THE EUT</u>	<u>21</u>
<u>6.</u>	<u>EXTERNAL AND INTERNAL PHOTOS OF THE EUT</u>	<u>22</u>

1. TEST STANDARDS

The tests were performed according to following standards:

FCC Rules Part 15.249: Frequency Hopping, Direct Spread Spectrum and Hybrid Systems that are in operation within the bands of 902-928 MHz, 2400-2483.5 MHz, 5725-5850 MHz and 24.0 - 24.25 GHz.

RSS-210 Issue 7 June 2007: Spectrum Management and Telecommunications Radio Standards Specification **Low-power Licence-exempt Radiocommunication Devices (All Frequency Bands): Category I Equipment**

2.6. Related Submittal(s) / Grant (s)

This submittal(s) (test report) is intended for FCC ID: **WMM-WR101** and IC: **7892A-WR101** filing to comply with Section 15.249 of the FCC Part 15, Subpart C Rules.

2.7. Modifications

No modifications were implemented to meet testing criteria.

3. TEST ENVIRONMENT

3.1. Address of the test laboratory

Shenzhen Huatongwei International Inspection Co., Ltd
Keji Nan No.12 Road, Hi-tech Park, Shenzhen, China
Phone: 86-755-26715686 Fax: 86-755-26748089

The sites are constructed in conformance with the requirements of ANSI C63.7, ANSI C63.4 (2003) and CISPR Publication 22.

3.2. Test Facility

The test facility is recognized, certified, or accredited by the following organizations:

CNAS-Lab Code: L1225

Shenzhen Huatongwei International Inspection Co., Ltd has been assessed and proved to be in compliance with CNAS-CL01 Accreditation Criteria for Testing and Calibration Laboratories (identical to ISO/IEC 17025: 2005 General Requirements) for the Competence of Testing and Calibration Laboratories, Date of Registration: August 02, 2007. Valid time is until March 04, 2009.

A2LA-Lab Cert. No. 2243.01

Shenzhen Huatongwei International Inspection Co., Ltd, EMC Laboratory has been accredited by A2LA for technical competence in the field of electrical testing, and proved to be in compliance with ISO/IEC 17025: 2005 General Requirements for the Competence of Testing and Calibration Laboratories and any additional program requirements in the identified field of testing. Valid time is from Aug 24, 2005 to Sept 30, 2009.

FCC-Registration No.: 662850

Shenzhen Huatongwei International Inspection Co., Ltd, EMC Laboratory has been registered and fully described in a report filed with the FCC (Federal Communications Commission). The acceptance letter from the FCC is maintained in our files. Registration 662850, Renewal date September, 2009.

IC-Registration No.: 5377

The 3m Alternate Test Site of Shenzhen Huatongwei International Inspection Co., Ltd has been registered by Certification and Engineering Bureau of Industry Canada for the performance of radiated measurements with Registration No. 5377 on November 28th, 2005.

ACA

Shenzhen Huatongwei International Inspection Co., Ltd, EMC Laboratory can also perform testing for the Australian C-Tick mark as a result of our A2LA accreditation.

NEMKO-Aut. No.: ELA125

Shenzhen Huatongwei International Inspection Co., Ltd has been assessed the quality assurance system, the testing facilities, qualifications and testing practices of the relevant parts of the organization. The quality assurance system of the Laboratory has been validated against ISO/IEC 17025:2005 or equivalent. The laboratory also fulfils the conditions described in Nemko Document NLA-10, the Authorization is valid through April 25, 2009.

VCCI

The 3m Semi-anechoic chamber (12.2m×7.95m×6.7m) and Shielded Room (8m×4m×3m) of Shenzhen Huatongwei International Inspection Co., Ltd has been registered in accordance with the Regulations for Voluntary Control Measures with Registration No.: R-2484. Date of Registration: December 20, 2006. Valid time is until December 19, 2009.

Main Ports Conducted Interference Measurement of Shenzhen Huatongwei International Inspection Co., Ltd has been registered in accordance with the Regulations for Voluntary Control Measures with Registration No.: C-2726. Date of Registration: December 20, 2006. Valid time is until December 19, 2009.

IECEE CB

Shenzhen Huatongwei International Inspection Co Ltd has been assessed and determined to fully comply with the requirements of ISO/IEC 17025: 2005-05, The Basic Rules, IECEE 01: 2006-10 and Rules of Procedure IECEE 02: 2006-10, and the relevant IECEE CB-Scheme Operational Documents. It is therefore entitled to operate as a CB Testing Laboratory under the responsibility of Nemko A/S. This certificate remains valid until May 25th 2009 at which time it will be reissued by the IECEE Executive Secretary upon successful completion of the normally scheduled 3-year Reassessment Program administered by the IECEE CB Scheme.

DNV

Shenzhen Huatongwei International Inspection Co Ltd has been found to comply with the requirements of DNV towards subcontractor of EMC and safety testing services in conjunction with the EMC and Low voltage Directives and in the voluntary field. The acceptance is based on a formal quality Audit and follow-ups according to relevant parts of ISO/IEC Guide 17025(2005), in accordance with the requirements of the DNV Laboratory Quality Manual towards subcontractors. Valid time is until 09 July, 2010.

3.3. Environmental conditions

During the measurement the environmental conditions were within the listed ranges:

Temperature:	<u>15-35 ° C</u>
Humidity:	<u>30-60 %</u>
Atmospheric pressure:	<u>950-1050mbar</u>

3.4. Configuration of Tested System

Fig. 2-1 Configuration of Tested System

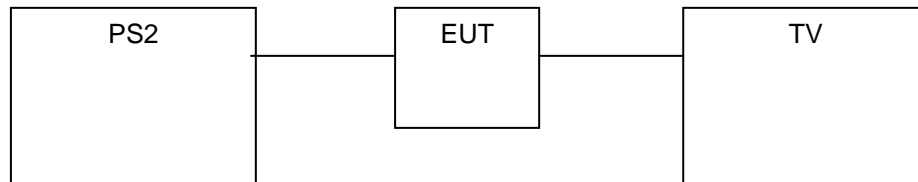

Table 2-1 Equipment Used in Tested System

Components	Manufacturer	Model No.	Series No.	Certificate
PlayStation2	SONY	SCPH-70007	N/A	FCC, CE
TV	KONKA	T1476A	AQN333HH1044805	CCC

3.5. Statement of the measurement uncertainty

The data and results referenced in this document are true and accurate. The reader is cautioned that there may be errors within the calibration limits of the equipment and facilities. The measurement uncertainty was calculated for all measurements listed in this test report acc. to CISPR 16 - 4 „Specification for radio disturbance and immunity measuring apparatus and methods – Part 4: Uncertainty in EMC Measurements“ and is documented in the Shenzhen Huatongwei International Inspection Co., Ltd quality system acc. to DIN EN ISO/IEC 17025. Furthermore, component and process variability of devices similar to that tested may result in additional deviation. The manufacturer has the sole responsibility of continued compliance of the device.

Hereafter the best measurement capability for Shenzhen Huatongwei laboratory is reported:

Test	Range	Measurement Uncertainty	Notes
Radiated Emission	30~1000MHz	4.22dB	(1)
Radiated Emission	1~12.75GHz	4.35dB	(1)
Conducted Disturbance	0.15~30MHz	3.29dB	(1)

(1) This uncertainty represents an expanded uncertainty expressed at approximately the 95% confidence level using a coverage factor of k=2.

3.6. Equipments Used during the Test

AC Power Conducted Emission					
Item	Test Equipment	Manufacturer	Model No.	Serial No.	Last Cal.
1	EMI TEST RECEIVER	ROHDE & SCHWARZ	ESCS30	100038	2007/10
2	ARTIFICIAL MAINS	ROHDE & SCHWARZ	ESH2-Z5	100028	2007/10
3	PULSE LIMITER	ROHDE & SCHWARZ	ESHSZ2	100044	2007/10
4	EMI TEST SOFTWARE	ROHDE & SCHWARZ	ES-K1 1.71	N/A	2007/10

Radiated Emissions					
Item	Test Equipment	Manufacturer	Model No.	Serial No.	Last Cal.
1	ULTRA-BROADBAND ANTENNA	ROHDE & SCHWARZ	HL562	100015	2007/10
2	EMI TEST RECEIVER	ROHDE & SCHWARZ	ESI 26	100009	2007/10
3	RF TEST PANEL	ROHDE & SCHWARZ	TS / RSP	335015/ 0017	2007/10
4	TURNTABLE	ETS	2088	2149	2007/10
5	ANTENNA MAST	ETS	2075	2346	2007/10
6	EMI TEST SOFTWARE	ROHDE & SCHWARZ	ESK1	N/A	2007/10

Bandwidth / Band Edge Measurement					
Item	Test Equipment	Manufacturer	Model No.	Serial No.	Last Cal.
1	EMI TEST RECEIVER	ROHDE & SCHWARZ	ESCI	100106	2007/10

4. TEST CONDITIONS AND RESULTS

4.1. Conducted Emissions Test

TEST CONFIGURATION

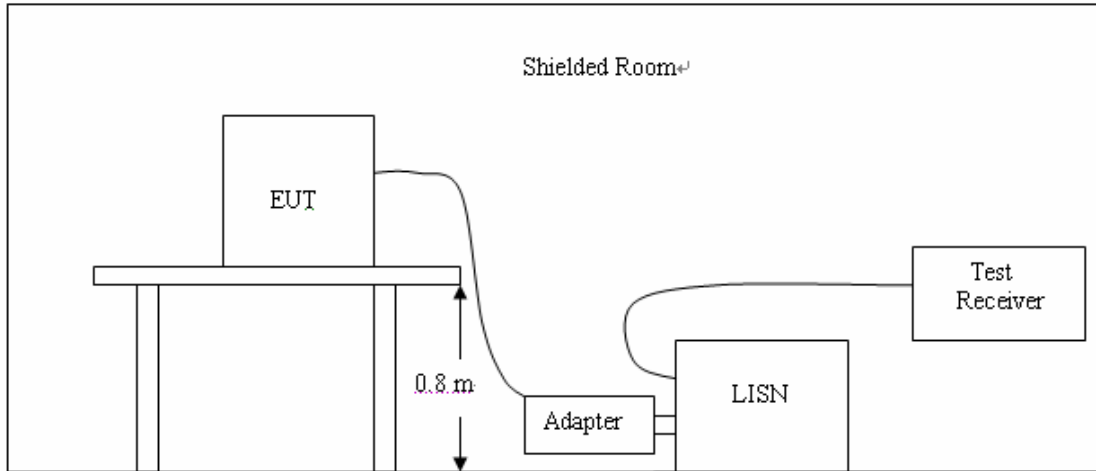

TEST PROCEDURE

- 1 The equipment was set up as per the test configuration to simulate typical actual usage per the user's manual. The EUT is a tabletop system, a wooden table with a height of 0.8 meters is used and is placed on the ground plane as per ANSI C63.4.
- 2 Support equipment, if needed, was placed as per ANSI C63.4.
- 3 All I/O cables were positioned to simulate typical actual usage as per ANSI C63.4.
- 4 If a EUT received DC power from the adapter, the adapter received AC120V/60Hz power through a Line Impedance Stabilization Network (LISN) which supplied power source and was grounded to the ground plane.
- 5 All support equipments received AC power from a second LISN, if any.
- 6 The EUT test program was started. Emissions were measured on each current carrying line of the EUT using a spectrum Analyzer / Receiver connected to the LISN powering the EUT. The LISN has two monitoring points: Line 1 (Hot Side) and Line 2 (Neutral Side). Two scans were taken: one with Line 1 connected to Analyzer / Receiver and Line 2 connected to a 50 ohm load; the second scan had Line 1 connected to a 50 ohm load and Line 2 connected to the Analyzer / Receiver.
- 7 Analyzer / Receiver scanned from 150 KHz to 30MHz for emissions in each of the test modes.
- 8 During the above scans, the emissions were maximized by cable manipulation.

Conducted Power Line Emission Limit

For unintentional device, according to § 15.107(a) Line Conducted Emission Limits is as following :

Frequency (MHz)	Maximum RF Line Voltage (dB μ V)			
	CLASS A		CLASS B	
	Q.P.	Ave.	Q.P.	Ave.
0.15 - 0.50	79	66	66-56*	56-46*
0.50 - 5.00	73	60	56	46
5.00 - 30.0	73	60	60	50

* Decreasing linearly with the logarithm of the frequency

For intentional device, according to §15.207(a) Line Conducted Emission Limit is same as above table.

TEST RESULTS

Owing to the DC power operation of EUT, this test item is not performed.

4.2. Radiated Emission Test

TEST CONFIGURATION

(A) Radiated Emission Test Set-Up, Frequency Below 30MHz

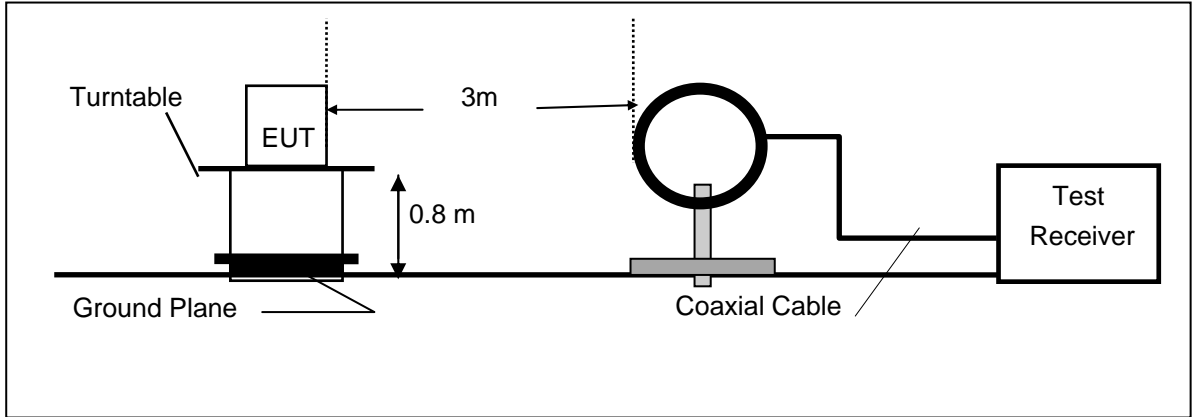

(B) Radiated Emission Test Set-Up, Frequency below 1000MHz

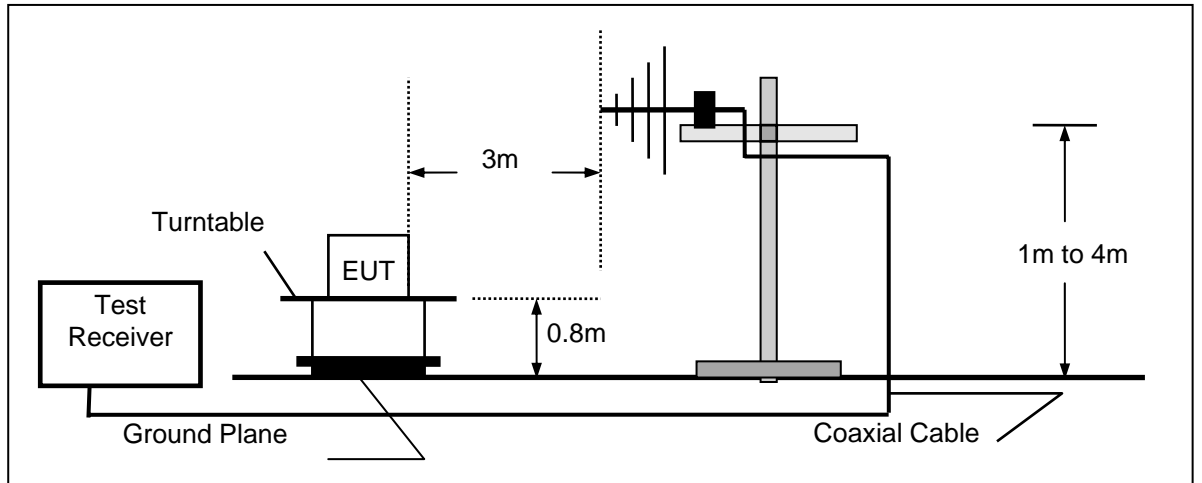

(C) Radiated Emission Test Set-Up, Frequency above 1000MHz

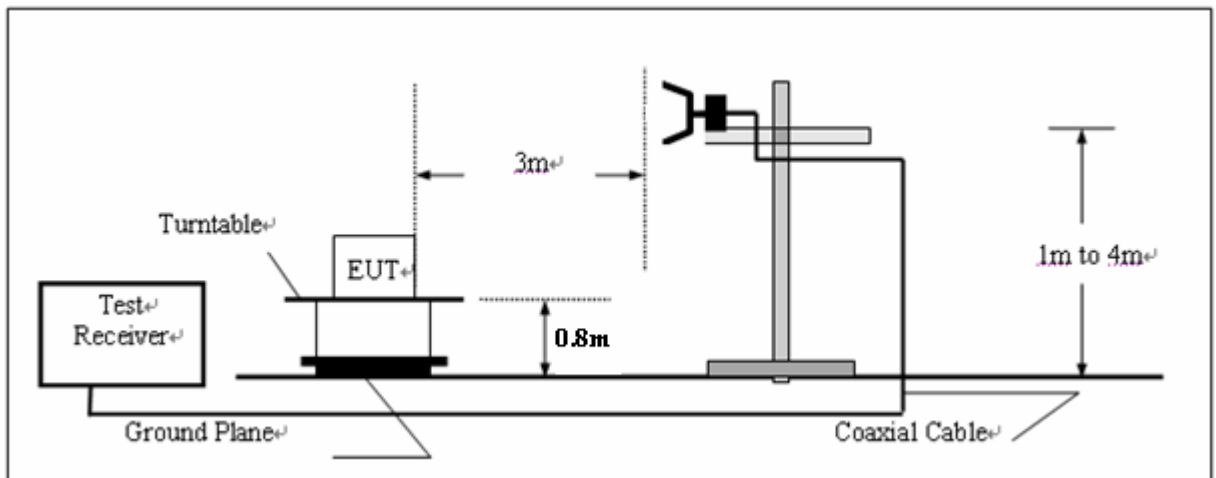

TEST PROCEDURE

- 1 The EUT was placed on a turn table which is 0.8m above ground plane.
- 2 Maximum procedure was performed by raising the receiving antenna from 1m to 4m and rotating the turn table from 0° to 360° to acquire the highest emissions from EUT
3. And also, each emission was to be maximized by changing the polarization of receiving antenna both horizontal and vertical.
4. Repeat above procedures until all frequency measurements have been completed.

Field Strength Calculation

The field strength is calculated by adding the Antenna Factor and Cable Factor and subtracting the Amplifier Gain and Duty Cycle Correction Factor(if any) from the measured reading. The basic equation with a sample calculation is as follows:

$$FS = RA + AF + CL - AG$$

Where FS = Field Strength	CL = Cable Attenuation Factor (Cable Loss)
RA = Reading Amplitude	AG = Amplifier Gain
AF = Antenna Factor	

RADIATION LIMIT

For unintentional device, according to § 15.109(a), except for Class A digital devices, the field strength of radiated emissions from unintentional radiators at a distance of 3 meters shall not exceed the following values:

Frequency (MHz)	Distance (Meters)	Radiated (dBµV/m)	Radiated (µV/m)
30-88	3	40.0	100
88-216	3	43.5	150
216-960	3	46.0	200
Above 960	3	54.0	500

For intentional device, according to § 15.209(a), the general requirement of field strength of radiated emissions from intentional radiators at a distance of 3 meters shall not exceed the above table.

Fundamental and Harmonics Emission Limits

Frequency MHz	Field Strength of Fundamental		Field Strength of Harmonics	
	(mV/m @3m)	(dBuV/m @3m)	(uV/m @3m)	(dBuV/m @3m)
2400-2483.5	50	94 (Average) 114 (Peak)	500	54 (Average) 74 (Peak)

Test Procedure

1. The EUT is placed on a turntable, which is 0.8m above ground plane.
2. The turntable shall be rotated for 360 degrees to determine the position of maximum emission level.
3. EUT is set 3m away from the receiving antenna, which is varied from 1m to 4m to find out the highest emissions.
4. Maximum procedure was performed on the six highest emissions to ensure EUT compliance.
5. And also, each emission was to be maximized by changing the polarization of receiving antenna both horizontal and vertical.
6. Repeat above procedures until the measurements for all frequencies are complete.

TEST RESULTS

Operation Mode: TX on Top Channel Temperature: 20 °C Humidity: 70 % RH Polarity: Ver. / Hor.

Freq. (MHz)	Ant.Pol. H/V	DetectorMode (PK/AV)	Reading (dBuV)	Ant./CL/ Amp. CF(dB)	Actual FS (dBuV/m)	Limit3m (dBuV/m)	Safe Margin (dB)	Note
2469	V	Peak	76.20	-3.30	72.90	93.98	-21.08	F
2469	H	Peak	72.80	-3.30	69.50	93.98	-24.48	F
4938	V	Peak	42.30	3.90	46.20	73.98	-27.78	H
4938	H	Peak	40.00	3.90	43.90	73.98	-30.08	H
7407	V		---					H
7407	H		---					H
916.41	H	Peak	6.80	25.50	32.30	46.00	-13.70	
916.41	V	Peak	8.40	25.50	33.90	46.00	-12.10	
Others			---					

Remark:

- (1) Measuring frequencies from 30 MHz to the 25 GHz.
- (2) "F" denotes fundamental frequency; "H" denotes spurious frequency. "E" denotes band edge frequency.
- (3) * denotes emission frequency which appearing within the Restricted Bands specified in provision of 15.205, then the general radiated emission limits in 15.209 apply.
- (4) Data of measurement within this frequency range shown "---" in the table above means the reading of emissions are attenuated more than 20dB below the permissible limits or the field strength is too small to be measured.
- (5) The IF bandwidth of EMI Test Receiver was 120KHz for measuring from 30 MHz to 1 GHz and 1 MHz for measuring above 1 GHz

Operation Mode: TX on Mid Channel Temperature: 20 °C Humidity: 70 % RH Polarity: Ver. / Hor.

Freq. (MHz)	Ant.Pol. H/V	DetectorMode (PK/AV)	Reading (dBuV)	Ant./CL/ Amp. CF(dB)	Actual FS (dBuV/m)	Limit3m (dBuV/m)	Safe Margin (dB)	Note
2440	V	Peak	79.20	-3.40	75.80	93.98	-18.18	F
2440	H	Peak	74.10	-3.40	70.70	93.98	-23.28	F
4880	V	Peak	41.10	3.70	44.80	73.98	-29.18	H
4880	H	Peak	40.40	3.70	44.10	73.98	-29.88	H
7320	V		---					H
7320	H		---					H
916.41	H	Peak	6.80	25.50	32.30	46.00	-13.70	
916.41	V	Peak	8.40	25.50	33.90	46.00	-12.10	
Others			---					

Remark:

- (1) *Measuring frequencies from 30 MHz to the 25 GHz.*
- (2) *"F" denotes fundamental frequency; "H" denotes spurious frequency. "E" denotes band edge frequency.*
- (3) ** denotes emission frequency which appearing within the Restricted Bands specified in provision of 15.205, then the general radiated emission limits in 15.209 apply.*
- (4) *Data of measurement within this frequency range shown "---" in the table above means the reading of emissions are attenuated more than 20dB below the permissible limits or the field strength is too small to be measured.*
- (5) *The IF bandwidth of EMI Test Receiver was 120KHz for measuring from 30 MHz to 1 GHz and 1 MHz for measuring above 1 GHz*

Operation Mode: TX on Bot Channel Temperature: 20 °C Humidity: 70 % RH Polarity: Ver. / Hor.

Freq. (MHz)	Ant.Pol. H/V	DetectorMode (PK/AV)	Reading (dBuV)	Ant./CL/ Amp. CF(dB)	Actual FS (dBuV/m)	Limit3m (dBuV/m)	Safe Margin (dB)	Note
2410	V	Peak	72.90	-3.50	69.40	93.98	-24.58	F
2410	H	Peak	71.10	-3.50	67.60	93.98	-26.38	F
4820	V	Peak	47.20	3.80	51.00	73.98	-22.98	H
4820	H	Peak	36.20	3.80	40.00	73.98	-33.98	H
7230	V		---					H
7230	H		---					H
916.41	H	Peak	6.80	25.50	32.30	46.00	-13.70	
916.41	V	Peak	8.40	25.50	33.90	46.00	-12.10	
Others			---					

Remark:

- (1) *Measuring frequencies from 30 MHz to the 25 GHz.*
- (2) *"F" denotes fundamental frequency; "H" denotes spurious frequency. "E" denotes band edge frequency.*
- (3) ** denotes emission frequency which appearing within the Restricted Bands specified in provision of 15.205, then the general radiated emission limits in 15.209 apply.*
- (4) *Data of measurement within this frequency range shown "---" in the table above means the reading of emissions are attenuated more than 20dB below the permissible limits or the field strength is too small to be measured.*
- (5) *The IF bandwidth of EMI Test Receiver was 120KHz for measuring from 30 MHz to 1 GHz and 1 MHz for measuring above 1 GHz*

4.3. Band Edge Measurement

TEST CONFIGURATION

Same as Section 4.2

TEST PROCEDURE

The band edge compliance of RF radiated emission should be measured by following the guidance in ANSI C63.4 with respect to maximizing the emission by rotating the EUT, measuring the emission while the EUT is situated in three orthogonal planes (if appropriate), adjusting the measurement antenna height and polarization etc. Set RBW to 100KHz and VBM to 300KHz to measure the peak field strength and set RBW to 1MHz and VBW to 10Hz to measure the average radiated field strength.

The conducted RF band edge was measured by using a spectrum analyzer. Set span wide enough to capture the highest in-band emission and the emission at the band edge. Set RBW to 100 KHz and VBM to 300 KHz, to measure the conducted peak band edge.

LIMIT

FCC PART 15.249(d) Emissions radiated outside of the specified frequency bands, except for harmonics, shall be attenuated by at least 50 dB below the level of the fundamental or to the general radiated emission limits in §15.209, whichever is the lesser attenuation.

TEST RESULTS

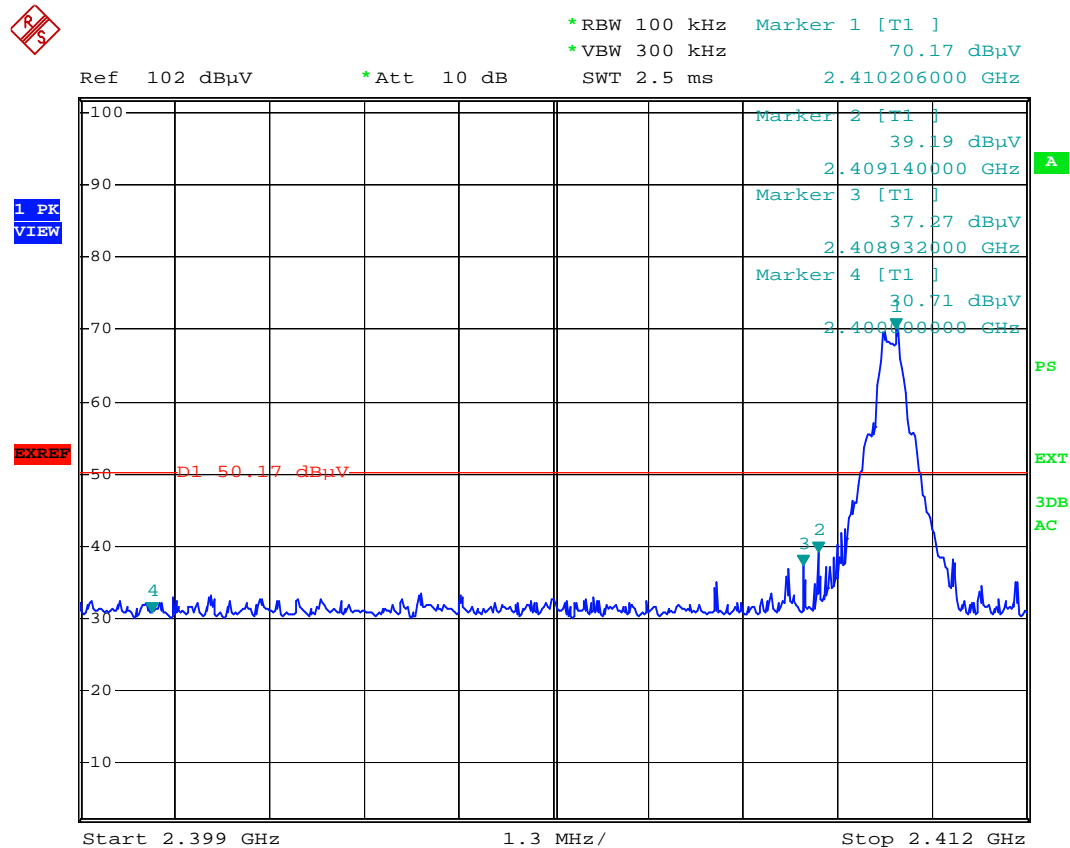

Date: 21.AUG.2008 22:38:19



*RBW 100 kHz Marker 1 [T1]
*VBW 300 kHz 70.53 dBμV
SWT 2.5 ms 2.469360000 GHz

Ref 102 dBμV

*Att 10 dB

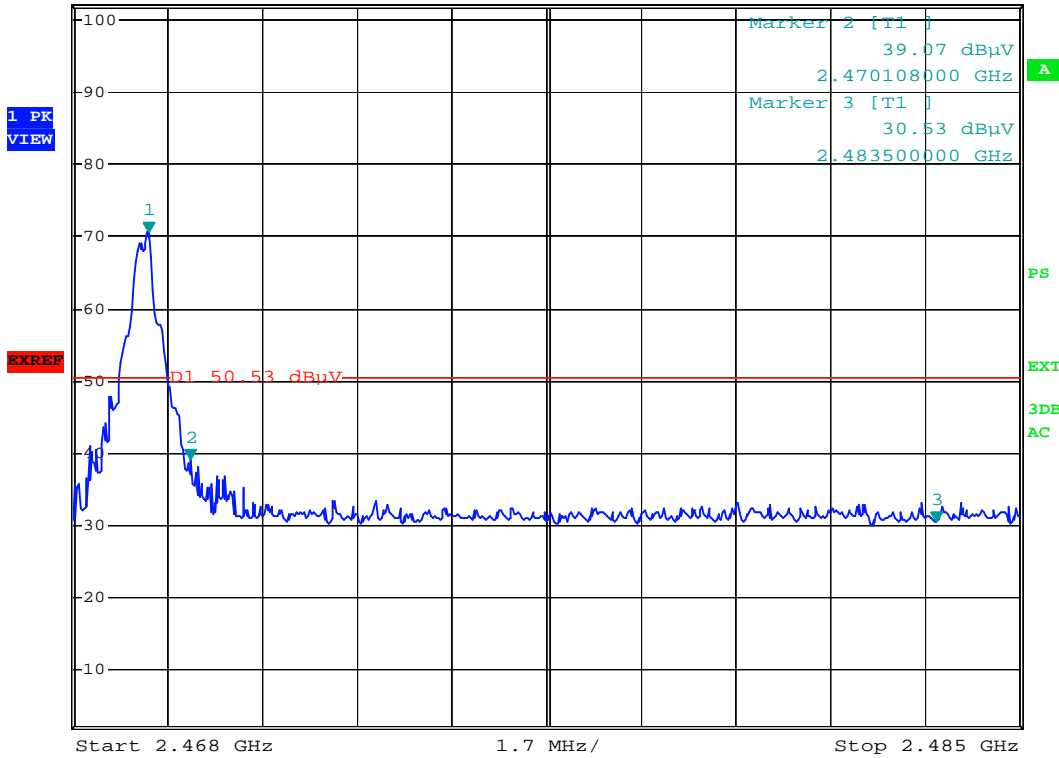

Date: 21.AUG.2008 22:45:23

Note:

1. The field strength of any emissions which appear outside of this band shall not exceed the general radiated emission limits in Section 15.209.
2. The average measurement was not performed when the peak measured data under the limit of average detection.

4.4. 20dB Bandwidth Measurement

TEST CONFIGURATION

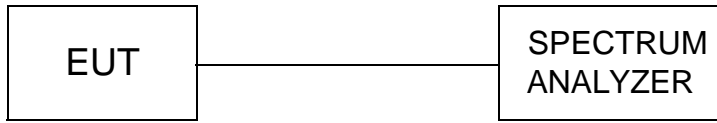

TEST PROCEDURE

The transmitter output is connected to the spectrum analyzer. The spectrum analyzer center frequency is set to the transmitter frequency. The RBW is set to 30 KHz and VBW is set 300 KHz.

LIMIT

RSS-210 A1.1.3, For the purpose of Section A1.1, the 99% bandwidth shall be no wider than 0.25% of the centre frequency for devices operating between 70-900 MHz. For devices operating above 900 MHz, the emission shall be no wider than 0.5% of the centre frequency.

TEST RESULTS

Bottom Channel:

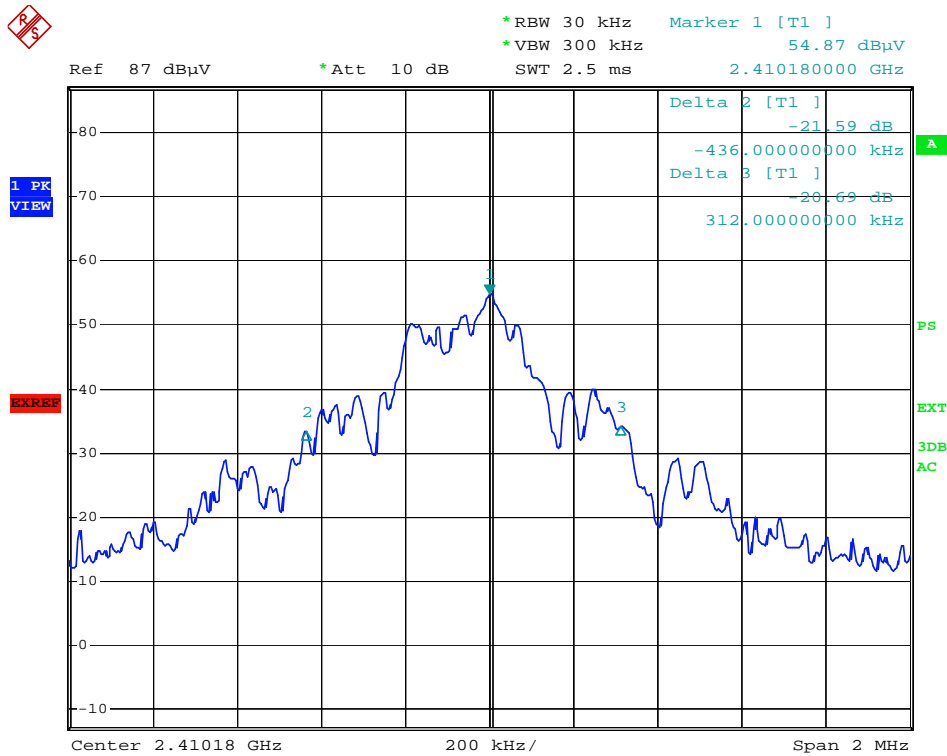

Mid Channel:

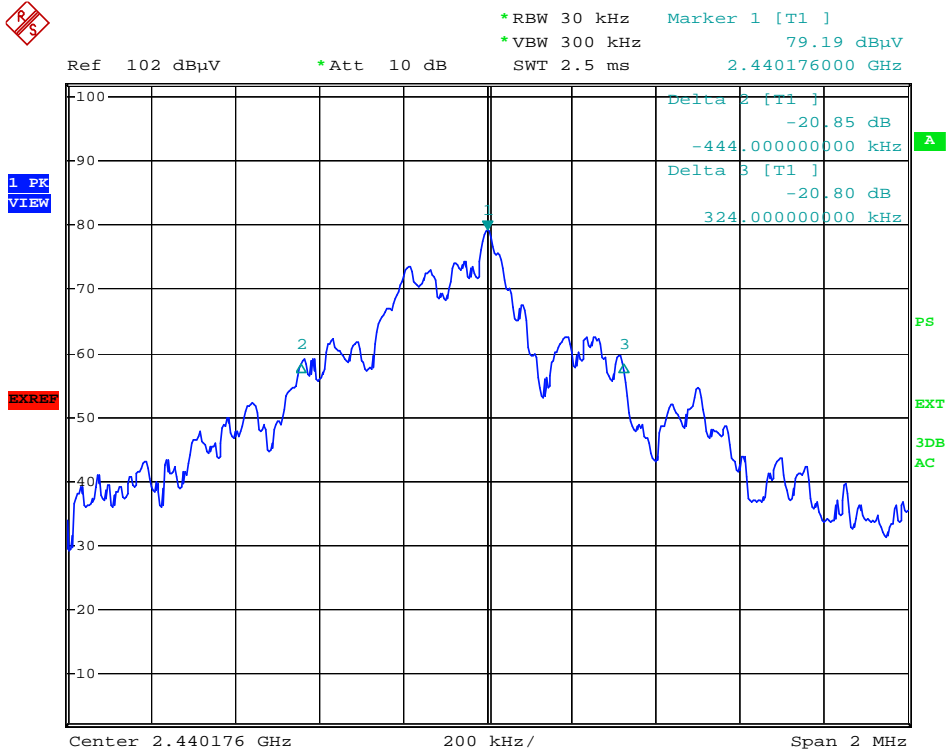

Date: 22.AUG.2008 00:10:57

Top Channel:

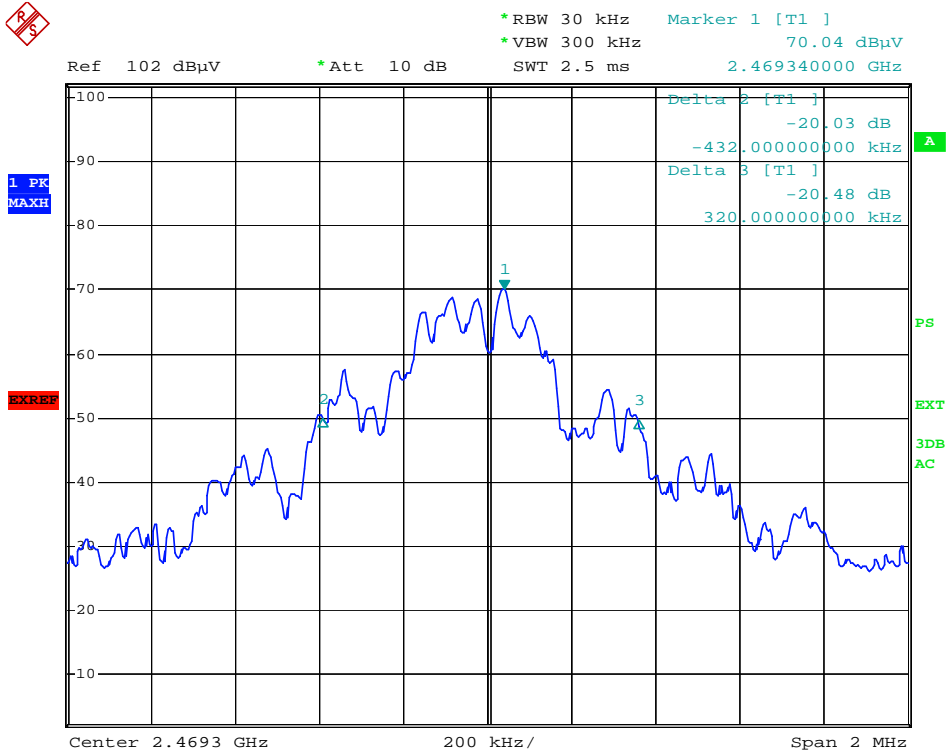

Date: 22.AUG.2008 00:18:54

5. Test Setup Photos of the EUT

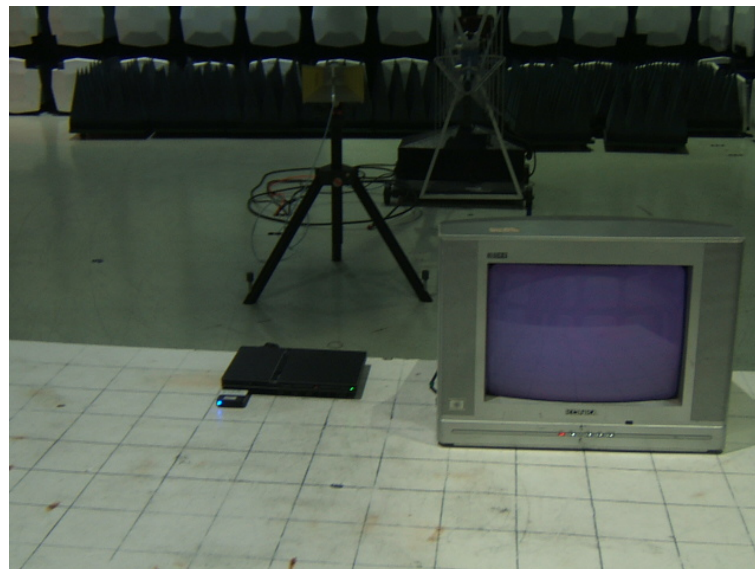
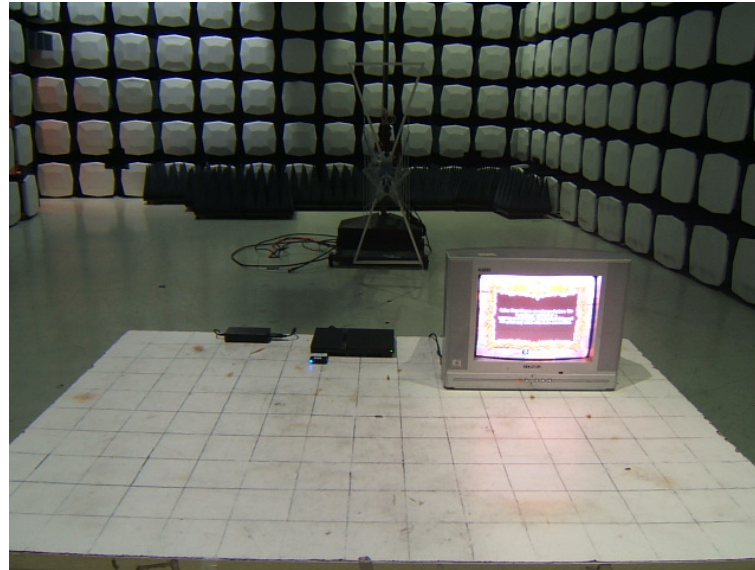

6. External and Internal Photos of the EUT

External Photos



Internal Photos

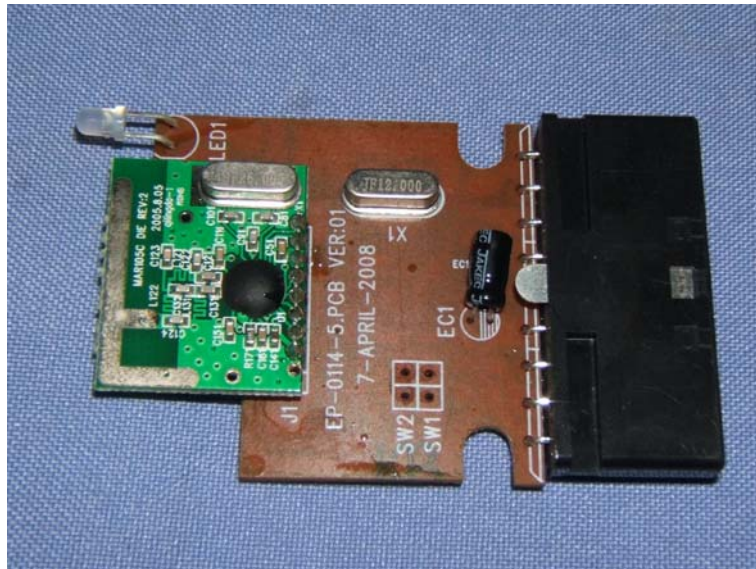

.....End of Report.....