



### FCC Part 15, Subpart C Test Report

FCC ID: WLQTSRX

Applicant: DEI Sales, Inc., dba Polk Audio

Address: 5541 FERMI COURT, CARLSBAD, CA ,92008, USA

Manufacturer: Polk Audio, LLC

Address: 5541 FERMI COURT, CARLSBAD, CA ,92008, USA

Product(s): True Surround Home Theatre System

Brand(s): **polk**

Test Model(s): TSRX1 TRUE SURROUND SB

Series Model(s): N/A

Test Date: Mar. 10, 2022 ~ Apr. 13, 2022

Issued Date: May 18, 2022

Issued By: Hwa-Hsing (Dongguan) Testing Co., Ltd.

Address: No.101, Bld N1, Yuyuan 2Rd, Yuyuan Industrial Park, HuangJiang Town, Dongguan, China

Test Firm Registration No.: 915896

Designation Number: CN1255

Standards: 47 CFR FCC Part 15, Subpart C (Section 15.247)  
ANSI C63.10:2013

The above equipment has been tested by **Hwa-Hsing (Dongguan) Testing Co., Ltd.**, and found compliance with the requirement of the above standards. The test record, data evaluation & Equipment Under Test (EUT) configurations represented herein are true and accurate accounts of the measurements of the sample's EMC characteristics under the conditions specified in this report.

Prepared by :

\_\_\_\_\_  
Tank Tan

Reviewed by :

\_\_\_\_\_  
Scott He

Approved by :

\_\_\_\_\_  
Harry Li

This report is for your exclusive use. Any copying or replication of this report to or for any other person or entity, or use of our name or trademark, is permitted only with our prior written permission. This report sets forth our findings solely with respect to the test samples identified herein. The results set forth in this report are not indicative or representative of the quality or characteristics of the lot from which a test sample was taken or any similar or identical product unless specifically and expressly noted. Our report includes all of the tests requested by you and the results thereof based upon the information that you provided to us. You have 60 days from date of issuance of this report to notify us of any material error or omission caused by our negligence, provided, however, that such notice shall be in writing and shall specifically address the issue you wish to raise. A failure to raise such issue within the prescribed time shall constitute your unqualified acceptance of the completeness of this report, the tests conducted and the correctness of the report contents. Unless specific mention, the uncertainty of measurement has been explicitly taken into the account to declare the compliance or non-compliance to the specification. The report must not be used by the client to claim product certification, approval, or endorsement by A2LA or any agency of the federal government. The report must not be used by the client to claim product certification, approval, or endorsement by TAF or any government agencies.

Lab: [Hwa-Hsing \(Dongguan\) Testing Co., Ltd.](#)

Address: [No.101, Bld N1, Yuyuan 2Rd, Yuyuan Industrial Park, HuangJiang Town, Dongguan, China](#)

Tel: [0769-83078199](tel:0769-83078199)

Web.: [www.hwa-hsing.com](http://www.hwa-hsing.com)

E-Mail: [customerservice.dg@hwa-hsing.com](mailto:customerservice.dg@hwa-hsing.com)

Release

[Ver. 1.5](#)



## Table of Contents

Release Control Record .....	4
<b>1 Summary of Test Results .....</b>	<b>5</b>
1.1 Measurement Uncertainty .....	5
1.2 Modification Record .....	5
<b>2 General Information .....</b>	<b>6</b>
2.1 General Description of EUT .....	6
2.2 Description of Test Modes .....	7
2.2.1 Test Mode Applicability and Tested Channel Detail .....	8
2.3 Description of Support Units .....	10
2.3.1 Configuration of System under Test .....	10
<b>3 Test Types and Results .....</b>	<b>11</b>
3.1 Radiated Emission and Band-edge Measurement .....	11
3.1.1 Limits of Radiated Emission and Band-edge Measurement .....	11
3.1.2 Test Instruments .....	12
3.1.3 Test Procedures .....	13
3.1.4 Deviation from Test Standard .....	14
3.1.5 Test Setup .....	15
3.1.6 EUT Operating Conditions .....	16
3.1.7 Test Results .....	17
3.2 Conducted Emission Measurement .....	29
3.2.1 Limits of Conducted Emission Measurement .....	29
3.2.2 Test Instruments .....	29
3.2.3 Test Procedures .....	30
3.2.4 Test Setup .....	30
3.2.5 EUT Operating Condition .....	30
3.2.6 Deviation from Test Standard .....	30
3.2.7 Test Results .....	31
3.3 Number of Hopping Frequency Used .....	33
3.3.1 Limits of Hopping Frequency Used Measurement .....	33
3.3.2 Test Setup .....	33
3.3.3 Test Instruments .....	33
3.3.4 Test Procedure .....	33
3.3.5 Deviation from Test Standard .....	33
3.3.6 Test Results .....	34
3.4 Dwell Time on Each Channel .....	35
3.4.1 Limits of Dwell Time on Each Channel Measurement .....	35
3.4.2 Test Setup .....	35
3.4.3 Test Instruments .....	35
3.4.4 Test Procedures .....	35
3.4.5 Deviation from Test Standard .....	35
3.4.6 Test Results .....	36
3.5 Channel Bandwidth .....	39
3.5.1 Limits of Channel Bandwidth Measurement .....	39
3.5.2 Test Setup .....	39
3.5.3 Test Instruments .....	39
3.5.4 Test Procedure .....	39
3.5.5 Deviation from Test Standard .....	39
3.5.6 EUT Operating Condition .....	39
3.5.7 Test Results .....	40



3.6	Occupied Bandwidth Measurement.....	42
3.6.1	Test Setup.....	42
3.6.2	Test Instruments .....	42
3.6.3	Test Procedure .....	42
3.6.4	Deviation from Test Standard .....	42
3.6.5	EUT Operating Conditions.....	42
3.6.6	Test Results .....	43
3.7	Hopping Channel Separation.....	45
3.7.1	Limits of Hopping Channel Separation Measurement.....	45
3.7.2	Test Setup.....	45
3.7.3	Test Instruments .....	45
3.7.4	Test Procedure .....	45
3.7.5	Deviation from Test Standard .....	45
3.7.6	Test Results .....	46
3.8	Maximum Output Power .....	48
3.8.1	Limits of Maximum Output Power Measurement .....	48
3.8.2	Test Setup.....	48
3.8.3	Test Instruments .....	48
3.8.4	Test Procedure .....	48
3.8.5	Deviation from Test Standard .....	49
3.8.6	EUT Operating Condition .....	49
3.8.7	Test Results .....	50
3.9	Conducted Out of Band Emission Measurement .....	53
3.9.1	Limits of Conducted Out of Band Emission Measurement.....	53
3.9.2	Test Setup.....	53
3.9.3	Test Instruments .....	53
3.9.4	Test Procedure .....	53
3.9.5	Deviation from Test Standard .....	54
3.9.6	EUT Operating Condition .....	54
3.9.7	Test Results .....	55
<b>4</b>	<b>Pictures of Test Arrangements.....</b>	<b>61</b>
<b>5</b>	<b>Test Instruments.....</b>	<b>62</b>
	<b>Appendix – Information on the Testing Laboratories .....</b>	<b>63</b>



### Release Control Record

Issue No.	Description	Date Issued
220115KH01-RF-US-01	Original Release	May 18, 2022



**1 Summary of Test Results**

47 CFR FCC Part 15, Subpart C (Section 15.247) KDB 558074 D01 15.247 Meas Guidance v05r02 ANSI C63.10:2013;			
FCC Clause	Test Item	Result	Remarks
15.207	AC Power Conducted Emission	Pass	Meet the requirement of limit.
15.247(a)(1) (iii)	Number of Hopping Frequency Used	Pass	Meet the requirement of limit.
15.247(a)(1) (iii)	Dwell Time on Each Channel	Pass	Meet the requirement of limit.
15.247(a)(1)	1. Hopping Channel Separation 2. Spectrum Bandwidth of a Frequency Hopping Sequence Spread Spectrum System	Pass	Meet the requirement of limit.
15.247(b)	Maximum Peak Output Power	Pass	Meet the requirement of limit.
---	Occupied Bandwidth Measurement	Pass	Reference only
15.205 & 209	Radiated Emissions	Pass	Meet the requirement of limit.
15.247(d)	Band Edge Measurement	Pass	Meet the requirement of limit.
15.247(d)	Antenna Port Emission	Pass	Meet the requirement of limit.
15.203	Antenna Requirement	Pass	No antenna connector is used.

**Note 1:** If the Frequency Hopping System operating in 2400-2483.5MHz band and the output power less than 125mW. The hopping channel carrier frequencies separated by a minimum of 25kHz or two-thirds of the 20dB bandwidth of hopping channel whichever is greater.

**Note 2:** The EUT has been verified to comply with the requirements of FCC Part 15, Subpart B, Class B (sDoC). The test report has been issued separately.

**1.1 Measurement Uncertainty**

Where relevant, the following measurement uncertainty levels have been estimated for tests performed on the EUTs specified in CISPR 16-4-2:

The listed uncertainties are the worst-case uncertainty for the entire range of measurement. Please note that the uncertainty values are provided for informational purposes only and are not used in determining the PASS/FAIL results.

Measurement	Frequency	Expanded Uncertainty (k=2) (±)
Conducted Emissions at mains ports	150kHz ~ 30MHz	2.66 dB
Radiated Emissions up to 1 GHz	9KHz ~ 30MHz	2.16 dB
	30MHz ~ 1000MHz	3.47 dB
Radiated Emissions above 1 GHz	1GHz ~ 18GHz	4.84 dB
	18GHz ~ 40GHz	4.67 dB

Note: This uncertainty represents an expanded uncertainty expressed at approximately the 95% confidence level using a coverage factor of k = 2.

**1.2 Modification Record**

There were no modifications required for compliance.



## 2 General Information

### 2.1 General Description of EUT

Product(s)	True Surround Home Theatre System
Test Model(s)	TSRX1 TRUE SURROUND SB
Series Model(s)	N/A
Status of EUT	Engineering Prototype
Power Supply Rating	AC Input 100-240V~ 50/60Hz 65W
Modulation Type	GFSK, $\pi/4$ DQPSK, 8DPSK
Transfer Rate	1/2/3Mbps
Operating Frequency	2402 ~ 2480MHz
Number of Channel	79
RF Output Power	10.361dBm (Peak)
Antenna Type	PCB Antenna
Antenna Gain	1.54dBi Maximum peak Gain
Antenna Connector	N/A
Accessory Device	Infrared remote controller
Cable Supplied	AC Cable: Unshielded, Detachable, 190cm

Note:

1. Please refer to the EUT photo document (Reference No.: 220115KH01-1&-2) for detailed product photo.
2. The above EUT information is declared by manufacturer and for more detailed features description, please refer to the manufacturer's specifications or User's Manual.



## 2.2 Description of Test Modes

79 channels are provided to this EUT:

Channel	Freq. (MHz)	Channel	Freq. (MHz)	Channel	Freq. (MHz)	Channel	Freq. (MHz)
0	2402	20	2422	40	2442	60	2462
1	2403	21	2423	41	2443	61	2463
2	2404	22	2424	42	2444	62	2464
3	2405	23	2425	43	2445	63	2465
4	2406	24	2426	44	2446	64	2466
5	2407	25	2427	45	2447	65	2467
6	2408	26	2428	46	2448	66	2468
7	2409	27	2429	47	2449	67	2469
8	2410	28	2430	48	2450	68	2470
9	2411	29	2431	49	2451	69	2471
10	2412	30	2432	50	2452	70	2472
11	2413	31	2433	51	2453	71	2473
12	2414	32	2434	52	2454	72	2474
13	2415	33	2435	53	2455	73	2475
14	2416	34	2436	54	2456	74	2476
15	2417	35	2437	55	2457	75	2477
16	2418	36	2438	56	2458	76	2478
17	2419	37	2439	57	2459	77	2479
18	2420	38	2440	58	2460	78	2480
19	2421	39	2441	59	2461		



2.2.1 Test Mode Applicability and Tested Channel Detail

EUT Configure Mode	Applicable test items	X-Axis	Y-Axis	Z-Axis	Voltage Supply
Conducted	AC Power Conducted Emission	N/A	N/A	N/A	AC120V/60Hz
Radiated	Radiated Emissions	√	√	√	
Antenna Port Conducted Measurement	Number of Hopping Frequency Used	N/A	N/A	N/A	
	Dwell Time on Each Channel	N/A	N/A	N/A	
	Band Edge Measurement	N/A	N/A	N/A	
	Antenna Port Emission	N/A	N/A	N/A	
	Conducted power	N/A	N/A	N/A	
	Hopping Channel Separation	N/A	N/A	N/A	
	Spectrum Bandwidth of a Frequency Hopping Sequence Spread Spectrum System	N/A	N/A	N/A	

1. \*: The EUT had been pre-tested on the positioned of each 3 Axis. The worst case was found when positioned on **Z-plane**.

2. "N/A" means no effect.

**Evaluation of difference data rate:**

Applicable test items	Modulation Type		The Worst-case Modulation
	$\pi/4$ DQPSK	8DPSK	
Radiated Emissions	√	√	<b>8DPSK</b>
Maximum Peak Output Power	√	√	<b>8DPSK</b>
Occupied Bandwidth Measurement	√	√	<b>8DPSK</b>
Number of Hopping Frequency Used	√	√	<b>8DPSK</b>
Dwell Time on Each Channel	√	√	<b>8DPSK</b>

**Test Condition:**

Applicable test items	Environmental Conditions	Test Data	Tested by
AC Power Conducted Emission	21deg. C, 45%RH	Apr. 10, 2022	Jim Xu
Radiated Emissions	21deg. C, 45%RH	Apr. 11, 2022	Jim Xu
Antenna Port Conducted Measurement	21deg. C, 45%RH	Apr. 11, 2022	King Ye

- Pre-Scan has been conducted to determine the worst-case mode from all possible combinations between available modulations, data rates and antenna ports (if EUT with antenna diversity architecture). Following channel(s) was (were) selected for the final test as listed below.





**Radiated Emission Test (Above 1 GHz):**

EUT Configure Mode	Available Channel	Tested Channel	Modulation Technology	Modulation Type	Packet Type
-	0 to 78	0, 39, 78	FHSS	GFSK	DH5
-	0 to 78	0, 39, 78	FHSS	8DPSK	3DH5

**Radiated Emission Test (Below 1 GHz):**

EUT Configure Mode	Available Channel	Tested Channel	Modulation Technology	Modulation Type	Packet Type
-	0 to 78	0	FHSS	8DPSK	3DH5

**Power Line Conducted Emission Test:**

EUT Configure Mode	Available Channel	Tested Channel	Modulation Technology	Modulation Type	Packet Type
-	0 to 78	0	FHSS	8DPSK	3DH5

**Antenna Port Conducted Measurement:**

This item includes all test value of each mode, but only includes spectrum plot of worst value of each mode.

EUT Configure Mode	Available Channel	Tested Channel	Modulation Technology	Modulation Type	Packet Type
-	0 to 78	0, 39, 78	FHSS	GFSK	DH5
-	0 to 78	0, 39, 78	FHSS	8DPSK	3DH5



### 2.3 Description of Support Units

The EUT has been tested as an independent unit together with other necessary accessories or support units. The following support units or accessories were used to form a representative test configuration during the tests.

No.	Product	Brand	Model No.	Serial No.	FCC ID
1.	Notebook	HUAWEI	NbD-WFH9	EUEPM21725002655	N/A

No.	Signal Cable Description of The Above Support Units
1.	USB serial cable Un-shieldin1.2m
2.	/
3.	/

#### 2.3.1 Configuration of System under Test

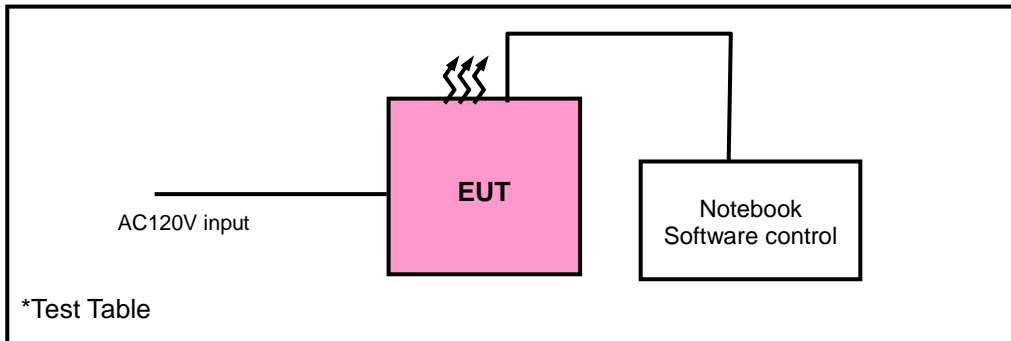



### 3 Test Types and Results

#### 3.1 Radiated Emission and Band-edge Measurement

##### 3.1.1 Limits of Radiated Emission and Band-edge Measurement

Radiated emissions which fall in the restricted bands must comply with the radiated emission limits specified as below table. Other emissions shall be at least 20 dB below the highest level of the desired power:

Frequencies (MHz)	Field Strength (microvolts/meter)	Measurement Distance (meters)
0.009 ~ 0.490	2400/F(kHz)	300
0.490 ~ 1.705	24000/F(kHz)	30
1.705 ~ 30.0	30	30
30 ~ 88	100	3
88 ~ 216	150	3
216 ~ 960	200	3
Above 960	500	3

\* DTS emissions in non-restricted frequency bands Subclause 11.11 of ANSI C63.10 is applicable.

\* DTS emissions in restricted frequency bands Subclause 11.12 of ANSI C63.10 is applicable

**Note:**

1. The lower limit shall apply at the transition frequencies.
2. Emission level (dBuV/m) = 20 log Emission level (uV/m).
3. For frequencies above 1000 MHz, the field strength limits are based on average detector, however, the peak field strength of any emission shall not exceed the maximum permitted average limits, specified above by more than 20 dB under any condition of modulation.



3.1.2 Test Instruments

Radiated emission below 30MHz:

Equipment	Manufacturer	Model No.	Serial No.	Next Cal.
EMI Test Receiver	Rohde&Schwarz	ESR 7	100962	2023/01/12
3m Semi-anechoic Chamber	MAORUI	9m*6m*6m	NSEMC003	2023/04/15*
Test software	FARAD	FARAD	EZ_EMCV1.1.4.2	N/A
Loop Antenna	EMCI	HLA 6121	45745	2022/12/13*
Preamplifier	EMCI	EMC001340	980201	2022/09/12
Antenna Tower	MF	MFA-440H	NA	NA
Turn Table	MF	MFT-201SS	NA	NA
Antenna Tower&Turn Table Controller	MF	MF-7802	NA	NA

Frequency Range below 1GHz:

Equipment	Manufacturer	Model No.	Serial No.	Next Cal.
EMI Test Receiver	Rohde&Schwarz	ESR 7	100962	2023/01/12
Broadband antenna	Schwarzbeck	VULB 9168	00937	2022/12/14*
3m Semi-anechoic Chamber	MAORUI	9m*6m*6m	NSEMC003	2023/04/15*
Signal Amplifier	Com-power	PAM-103	18020051	2022/09/14
Attenuator	Rohde&Schwarz	TS2GA-6dB	18101101	N/A
Test software	FARAD	FARAD	EZ_EMCV1.1.4.2	N/A

Frequency Range 1-18GHz:

Equipment	Manufacturer	Model No.	Serial No.	Next Cal.
3m Semi-anechoic Chamber	MAORUI	9m*6m*6m	NSEMC003	2023/04/15*
Horn Antenna	Schwarzbeck	BBHA 9170	01959	2022/09/15*
Broadband Coaxial Preamplifier	Schwarzbeck	BBV 9718	00025	2022/08/14
Spectrum	Keysight	N9020A	MY51240612	2022/09/12
Antenna Tower	MF	MFA-440H	NA	NA
Turn Table	MF	MFT-201SS	NA	NA
Antenna Tower&Turn Table Controller	MF	MF-7802	NA	NA

Frequency Range 18-40GHz:

Equipment	Manufacturer	Model No.	Serial No.	Next Cal.
3m Semi-anechoic Chamber	MAORUI	9m*6m*6m	NSEMC003	2023/04/15*
Spectrum Analyzer	Rohde&Schwarz	FSV-40N	101783	2022/09/14
Horn Antenna	Schwarzbeck	BBHA 9170	BBHA9170242	2022/09/15*
Pre-Amplifier	EMCI	EMC 184045	980102	2022/09/14
Antenna Tower	MF	MFA-440H	NA	NA
Turn Table	MF	MFT-201SS	NA	NA
Antenna Tower&Turn Table Controller	MF	MF-7802	NA	NA

- Note: 1. The calibration interval of the above test instruments is 12months (\* The Antenna and Chamber was 24 months) and the calibrations are traceable to CEPREI/CHINA.  
 2. The test was performed in 966.



3.1.3 Test Procedures

a. **Peak emission levels are measured by setting the instrument as follow:**

1) RBW& VBW setting as a function of frequency:

Frequency	RBW	VBW
9kHz~150kHz	200Hz	600Hz
0.15MHz~30MHz	9kHz	30kHz
30MHz~1000MHz	120kHz	300kHz
>1000MHz	1MHz	3MHz

- 2) Detector = peak.
- 3) Sweep time = auto.
- 4) Trace mode = max hold.
- 5) Allow sweeps to continue until the trace stabilizes. (Note that the required measurement time may be lengthened for low-duty-cycle applications.)

Note: If the peak-detected amplitude can be shown to comply with the average limit, then it is not necessary to perform a separate average measurement

b. **Average emission levels are measured by setting the instrument as follow:**

● **Trace averaging with continuous EUT transmission at full power**

If the EUT can be configured or modified to transmit continuously ( $D \geq 98\%$ ), then the average emission levels shall be measured using the following method (with EUT transmitting continuously):

- 1) RBW=1 MHz (unless otherwise specified).
- 2)  $VBW \geq 3 * RBW$ .
- 3) Detector =RMS
- 4) Sweep time = auto.
- 5) Perform a trace average of at least 100 traces.

● **Trace averaging across ON and OFF times of the EUT transmissions followed by duty cycle correction**

If continuous transmission of the EUT ( $D \geq 98\%$ ) cannot be achieved and the duty cycle is constant (duty cycle variations are less than  $\pm 2\%$ ), then the following procedure shall be used

- 1) The EUT shall be configured to operate at the maximum achievable duty cycle.
- 2) Measure the duty cycle D of the transmitter output signal as described in 11.6.
- 3) RBW=1 MHz (unless otherwise specified).
- 4)  $VBW \geq 3 * RBW$ .
- 5) Detector =RMS
- 6) Sweep time = auto.
- 7) Perform a trace average of at least 100 traces.

A correction factor shall be added to the measurement results prior to comparing with the emission limit to compute the emission level that would have been measured had the test been performed at 100% duty cycle. The correction factor is computed as follows:

\*If power averaging (rms) mode was used in step 5), then the applicable correction factor is  $[10 \log (1/ D)]$ , where D is the duty cycle.

\*\*If linear voltage averaging mode was used in step f), then the applicable correction factor is  $[20 \log (1/D)]$ , where D is the duty cycle.

\*\*\*If a specific emission is demonstrated to be continuous ( $D > 98\%$ ) rather than turning ON and OFF with the transmit cycle, then no duty cycle correction is required for that



● **Reduced VBW Averaging across ON and OFF times of the EUT transmissions with max hold**

If continuous transmission of the EUT ( $D > 98\%$ ) cannot be achieved and the duty cycle is not constant (duty cycle variations exceed  $\pm 2\%$ ), then the following procedure shall be used:

- 1) RBW = 1 MHz.
  - 2)  $VBW \geq 1/T$ .
  - 3) Detector = peak
  - 4) Sweep time = auto.
  - 5) Trace mode = max hold.
  - 6) Allow max hold to run for at least  $[50 \times (1/D)]$  traces
- c. The EUT was placed on the top of a rotating table 0.8 meters (below 1GHz) / 1.5 meters (1-18GHz) / 1.5 meters (18-40GHz) above the reference ground. The table was rotated 360 degrees to determine the position of the highest radiation.
- d. The EUT was set 3 meters away from the interference-receiving antenna (Below 1GHz) & (Above 1-18GHz), which was mounted on the top of a variable-height antenna tower. The EUT was set 1 meters away from the interference-receiving antenna (18-40GHz).
- e. The height of antenna is varied from one meter to four meters above the ground to determine the maximum value of the field strength. Both horizontal and vertical polarizations of the antenna are set to make the measurement.
- f. For each suspected emission, the EUT was arranged to its worst case and then the antenna was tuned to heights from 1 meter to 4 meters and the rotatable table was turned from 0 degrees to 360 degrees to find the maximum reading.
- g. The test-receiver system was set to quasi-peak detect function and specified bandwidth with maximum hold mode when the test frequency is below 1 GHz.

The test-receiver system was set to peak and average detected function and specified bandwidth with maximum hold mode when the test frequency is above 1 GHz. If the peak reading value also meets average limit, measurement with the average detector is unnecessary.

Note:

1. Test procedures for measuring FHSS device: The use of a duty cycle correction factor (DCCF) is permitted for calculating average radiated field strength emission levels for an FHSS device in 15.247. This DCCF can be applied when the unwanted emission limit is subject to an average field strength limit (e.g., within a Government Restricted band) and the conditions specified in Section 15.35(c) can be satisfied. The average radiated field strength is calculated by subtracting the DCCF from the maximum radiated field strength level as determined through measurement. The maximum radiated field strength level represents the worst-case (maximum amplitude) RMS measurement of the emission(s) during continuous transmission (i.e., not including any time intervals during which the transmitter is off or is transmitting at a reduced power level). It is also acceptable to apply the DCCF to a measurement performed with a peak detector instead of the specified RMS power averaging detector. Note that Section 15.35(c) specifies that the DCCF shall represent the worst-case (greatest duty cycle) over any 100 msec transmission period. Subclause 7.5 of ANSI C63.10 provides additional measurement guidance applicable to determination of the DCCF.
2. All modes of operation were investigated and the worst-case emissions are reported.

3.1.4 Deviation from Test Standard

No deviation.



### 3.1.5 Test Setup

Radiated emission below 30MHz:

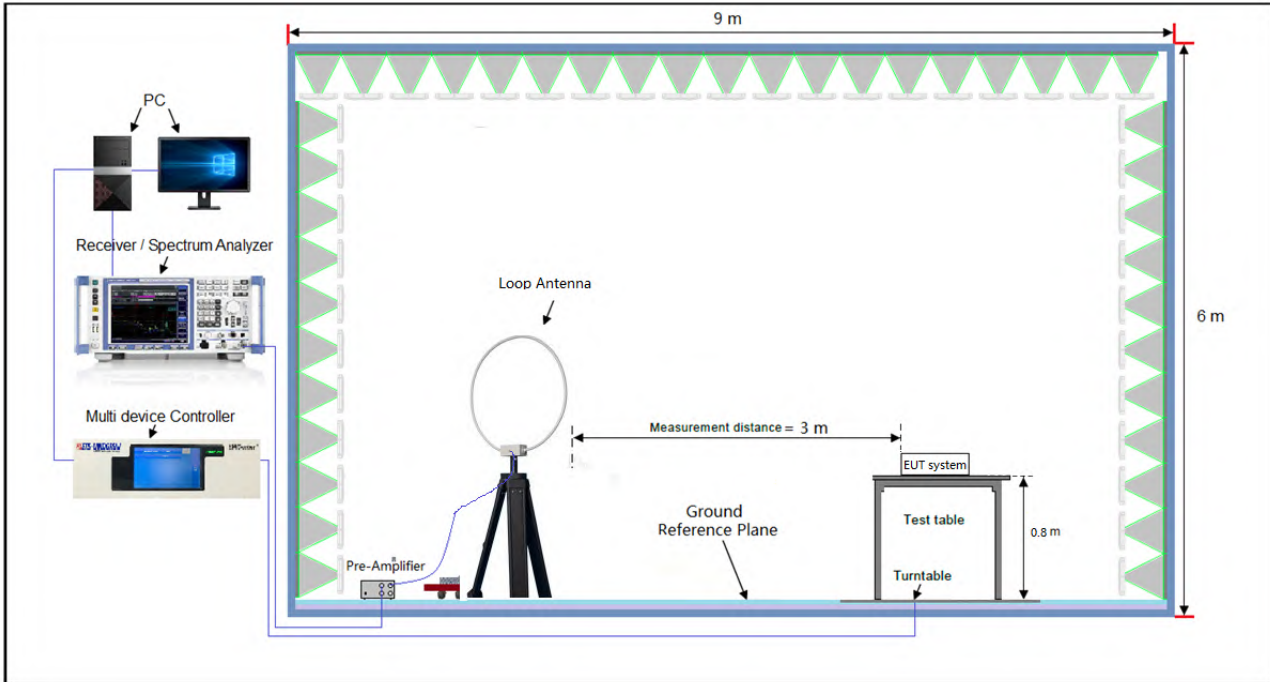

Frequency Range below 1GHz:

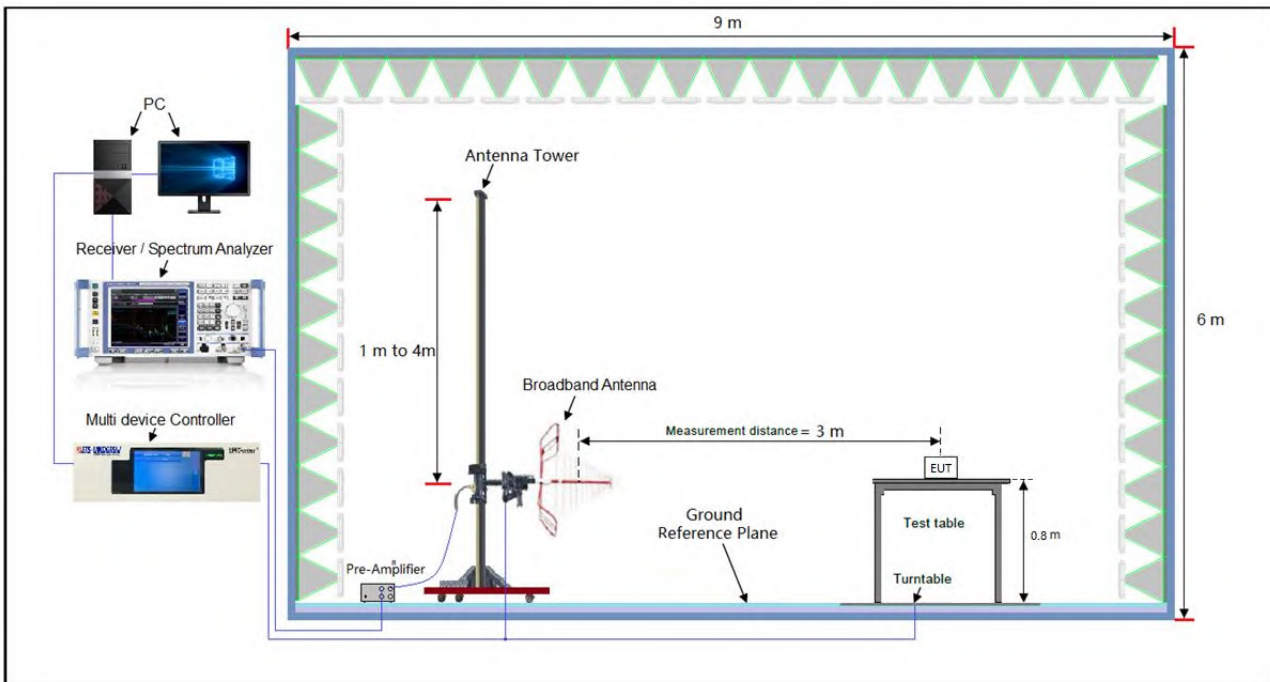



Frequency Range above 1GHz:

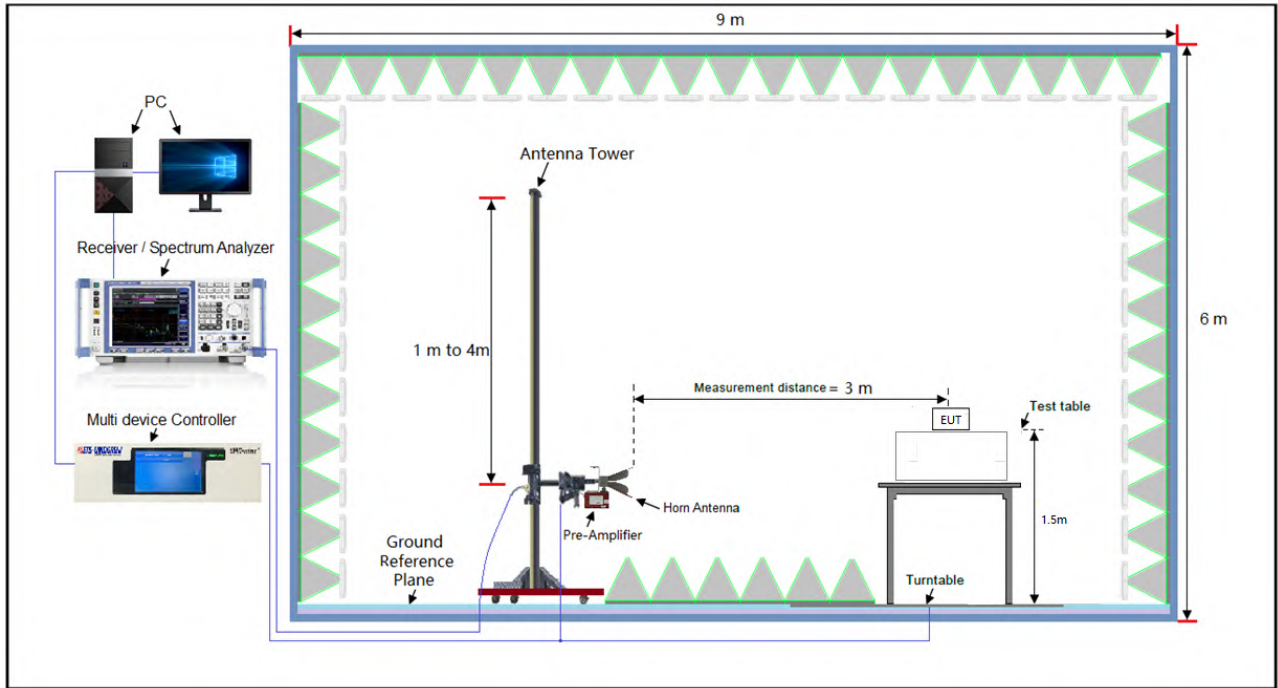

Frequency Range 18-40GHz:

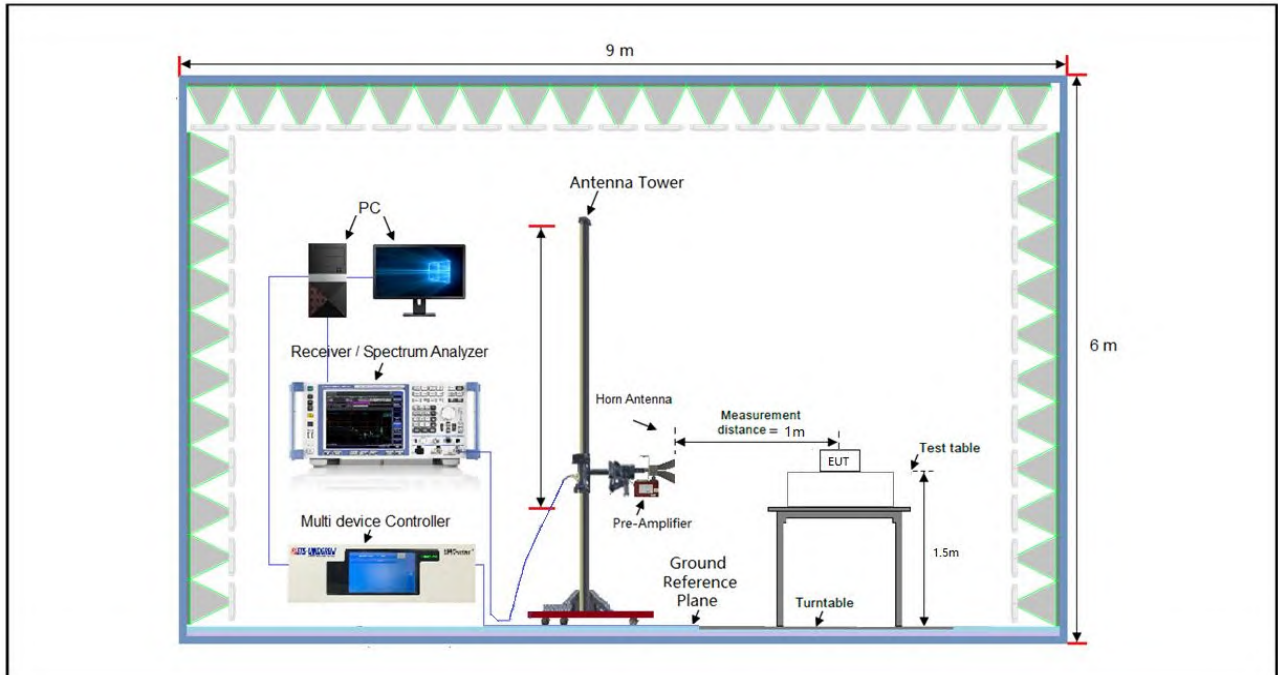

\*For the actual test configuration, please refer to the attached file (Test Setup Photo).

3.1.6 EUT Operating Conditions

Set the EUT under transmission condition continuously at specific channel frequency.





3.1.7 Test Results

**9 kHz ~ 30 MHz Data:**

The amplitude of spurious emissions attenuated more than 20 dB below the permissible value is not required to be report.

**30 MHz ~ 1GHz Worst-Case Data:**

Frequency Range	30MHz ~ 1GHz	Detector Function	Peak (PK) Quasi-peak (QP)
Test Channel	Channel 0		

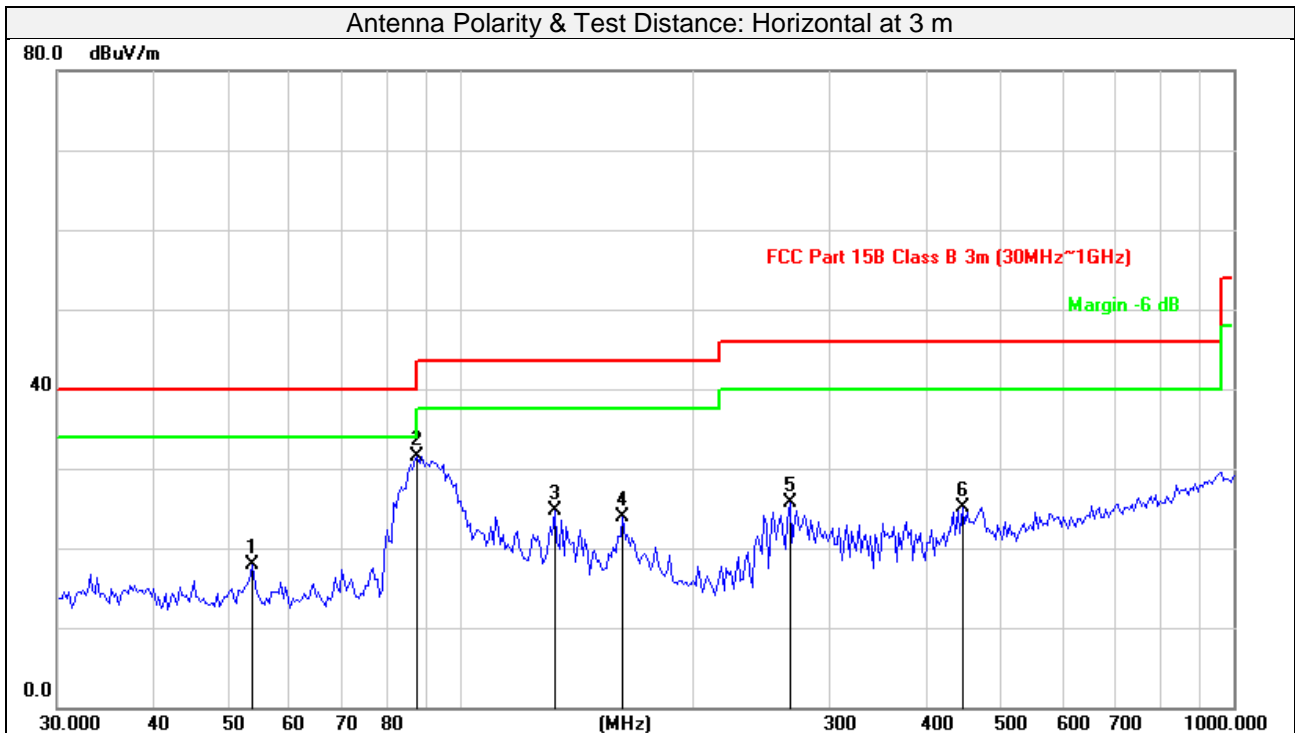

No.	Frequency (MHz)	Reading (dBuV)	Factor (dB)	Emission Level (dBuV/m)	Limit (dBuV/m)	Margin (dB)	Detector	Antenna Height (cm)	Table Angle (Degree)
1	53.7559	34.64	-16.82	17.82	40.00	-22.18	peak	200	132
2	87.9136	49.87	-18.33	31.54	40.00	-8.46	peak	200	254
3	132.1489	40.16	-15.54	24.62	43.50	-18.88	peak	300	297
4	162.0197	36.84	-12.94	23.90	43.50	-19.60	peak	300	164
5	266.8395	40.66	-14.89	25.77	46.00	-20.23	peak	200	95
6	445.6932	35.67	-10.48	25.19	46.00	-20.81	peak	200	301

Remarks:

- 1.Emission Level = Read Level + Factor (Antenna Factor + Cable Loss - Preamp Factor)
- 2.Margin value = Emission level – Limit value



Frequency Range	30MHz ~ 1GHz	Detector Function	Peak (PK) Quasi-peak (QP)
Test Channel	Channel 0		

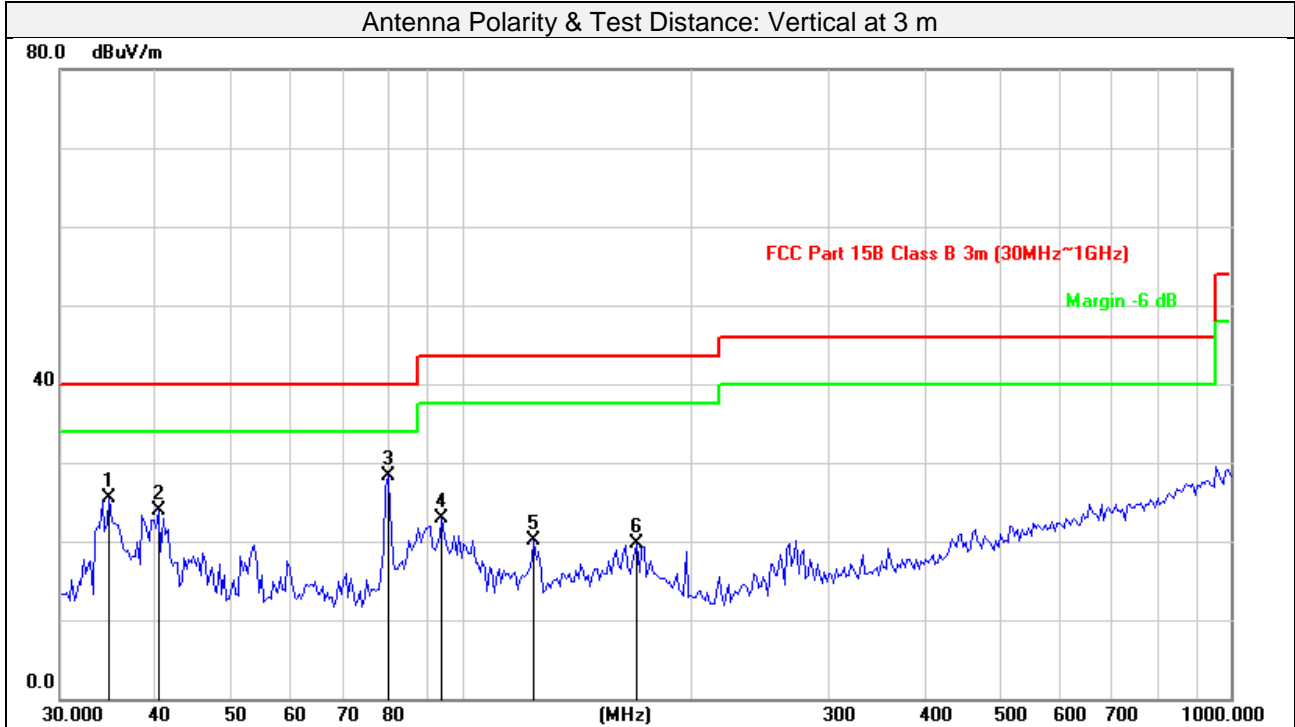

No.	Frequency (MHz)	Reading (dBuV)	Factor (dB)	Emission Level (dBuV/m)	Limit (dBuV/m)	Margin (dB)	Detector	Antenna Height (cm)	Table Angle (Degree)
1	34.7705	42.35	-16.78	25.57	40.00	-14.43	peak	100	228
2	40.2995	40.58	-16.74	23.84	40.00	-16.16	peak	100	184
3	80.2383	45.96	-17.69	28.27	40.00	-11.73	peak	100	164
4	94.3137	41.03	-18.04	22.99	43.50	-20.51	peak	100	215
5	124.0501	36.04	-15.92	20.12	43.50	-23.38	peak	200	300
6	168.9970	32.41	-12.69	19.72	43.50	-23.78	peak	200	15

Remarks:

1. Emission Level = Read Level + Factor (Antenna Factor + Cable Loss - Preamp Factor)
2. Margin value = Emission level – Limit value



Above 1GHz Data:

GFSK

Frequency Range	1GHz ~ 25GHz	Detector Function	Peak (PK) Average (AVG)
Test Channel	Channel 0		

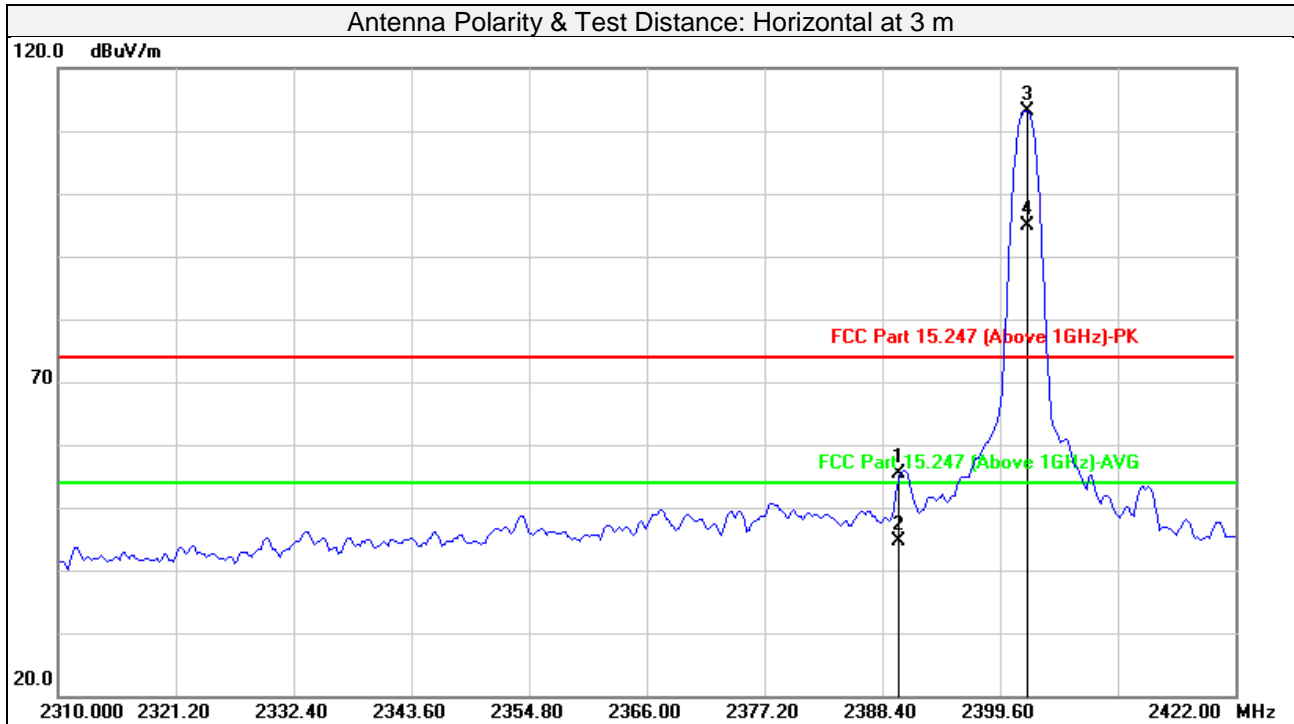

No.	Frequency (MHz)	Reading (dBuV)	Factor (dB)	Emission Level (dBuV/m)	Limit (dBuV/m)	Margin (dB)	Detector	Antenna Height (cm)	Table Angle (Degree)
1	2390.000	56.71	-1.30	55.41	74.00	-18.59	peak	339	267
2	2390.000	45.94	-1.30	44.64	54.00	-9.36	AVG	339	267
3#	2402.249	114.42	-1.30	113.12			peak	339	267
4#	2402.249	96.19	-1.30	94.89			AVG	339	267
5	4804.000	48.73	4.43	53.16	74.00	-20.84	peak	100	128
6	4804.000	36.92	4.43	41.35	54.00	-12.65	AVG	100	128
7	7206.000	46.72	9.09	55.81	74.00	-18.19	peak	100	264
8	7206.000	40.52	9.09	49.61	54.00	-4.39	AVG	100	264
9	9608.000	49.36	12.45	61.81	74.00	-12.19	peak	100	133
10	9608.000	38.29	12.45	50.74	54.00	-3.26	AVG	100	133

Remarks:

- Emission Level = Read Level + Factor (Antenna Factor + Cable Loss - Preamp Factor)  
Margin value = Emission level – Limit value
- #2402MHz: Fundamental frequency.
- The amplitude of spurious emissions attenuated more than 20 dB below the permissible value is not required to be report.



Frequency Range	1GHz ~ 25GHz	Detector Function	Peak (PK) Average (AVG)
Test Channel	Channel 0		

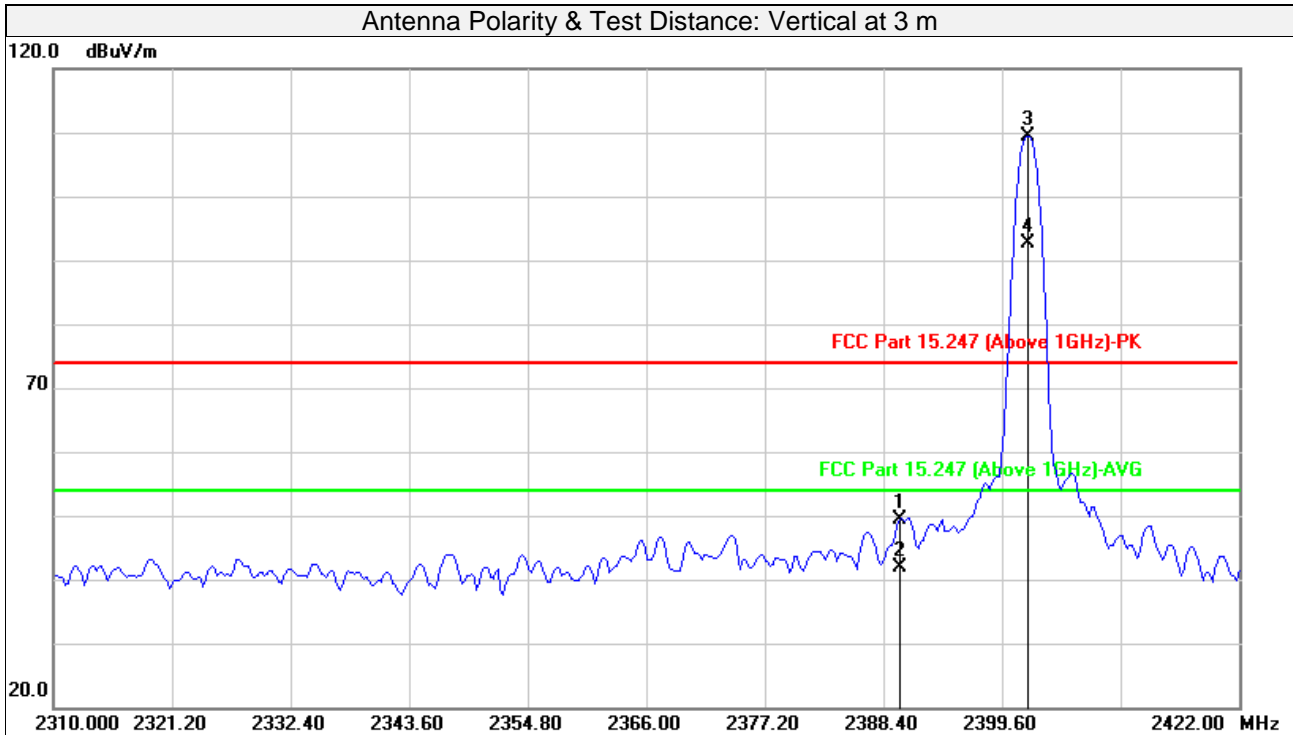

No.	Frequency (MHz)	Reading (dBuV)	Factor (dB)	Emission Level (dBuV/m)	Limit (dBuV/m)	Margin (dB)	Detector	Antenna Height (cm)	Table Angle (Degree)
1	2389.904	50.72	-1.30	49.42	74.00	-24.58	peak	100	92
2	2389.904	43.09	-1.30	41.79	54.00	-12.21	AVG	100	92
3#	2402.024	110.57	-1.30	109.27			peak	100	92
4#	2402.024	93.83	-1.30	92.53			AVG	100	92
5	4804.000	49.88	4.43	54.31	74.00	-19.69	peak	200	267
6	4804.000	38.56	4.43	42.99	54.00	-11.01	AVG	200	267
7	7206.000	47.03	9.09	56.12	74.00	-17.88	peak	200	196
8	7206.000	41.69	9.09	50.78	54.00	-3.22	AVG	200	196
9	9608.000	50.46	12.45	62.91	74.00	-11.09	peak	100	124
10	9608.000	38.41	12.45	50.86	54.00	-3.14	AVG	100	124

Remarks:

- Emission Level = Read Level + Factor (Antenna Factor + Cable Loss - Preamp Factor)  
Margin value = Emission level – Limit value
- #2402MHz: Fundamental frequency.
- The amplitude of spurious emissions attenuated more than 20 dB below the permissible value is not required to be report.



Frequency Range	1GHz ~ 25GHz	Detector Function	Peak (PK) Average (AVG)
Test Channel	Channel 39		

Antenna Polarity & Test Distance: Horizontal at 3 m									
No.	Frequency (MHz)	Reading (dBuV)	Factor (dB)	Emission Level (dBuV/m)	Limit (dBuV/m)	Margin (dB)	Detector	Antenna Height (cm)	Table Angle (Degree)
1#	2479.800	107.57	-1.24	106.33			peak	100	323
2#	2479.800	90.72	-1.24	89.48			AVG	100	323
3	2488.104	53.99	-1.25	52.74	74.00	-21.26	peak	100	323
4	2488.104	38.75	-1.25	37.50	54.00	-16.50	AVG	100	323
5	4960.000	44.32	4.90	49.22	74.00	-24.78	peak	100	217
6	4960.000	35.39	4.90	40.29	54.00	-13.71	AVG	100	217
7	7440.000	48.50	9.40	57.90	74.00	-16.10	peak	219	238
8	7440.000	40.16	9.40	49.56	54.00	-4.44	AVG	219	238
Antenna Polarity & Test Distance: Vertical at 3 m									
No.	Frequency (MHz)	Reading (dBuV)	Factor (dB)	Emission Level (dBuV/m)	Limit (dBuV/m)	Margin (dB)	Detector	Antenna Height (cm)	Table Angle (Degree)
1#	2441.000	110.41	-1.27	109.14			peak	100	267
2#	2441.000	90.74	-1.27	89.47			AVG	100	267
3	4882.000	48.51	4.66	53.17	74.00	-20.83	peak	100	196
4	4882.000	37.28	4.66	41.94	54.00	-12.06	AVG	100	196
5	7323.000	46.40	9.24	55.64	74.00	-18.36	peak	100	124
6	7323.000	39.93	9.24	49.17	54.00	-4.83	AVG	100	124
7	9764.000	48.99	12.95	61.94	74.00	-12.06	peak	100	247
8	9764.000	37.97	12.95	50.92	54.00	-3.08	AVG	100	247

Remarks:

- Emission Level = Read Level + Factor (Antenna Factor + Cable Loss - Preamp Factor)  
Margin value = Emission level – Limit value
- #2441MHz: Fundamental frequency.
- The amplitude of spurious emissions attenuated more than 20 dB below the permissible value is not required to be report.



Frequency Range	1GHz ~ 25GHz	Detector Function	Peak (PK) Average (AVG)
Test Channel	Channel 78		

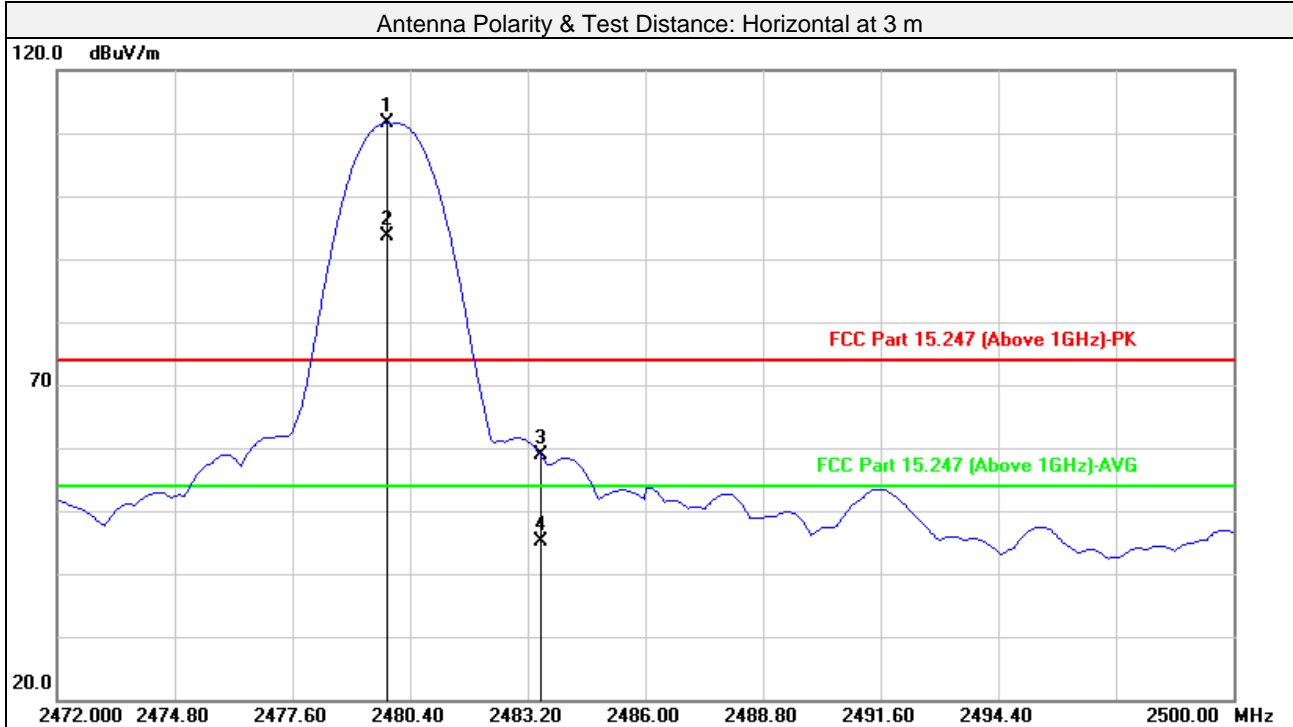

No.	Frequency (MHz)	Reading (dBuV)	Factor (dB)	Emission Level (dBuV/m)	Limit (dBuV/m)	Margin (dB)	Detector	Antenna Height (cm)	Table Angle (Degree)
1#	2479.856	112.79	-1.24	111.55			peak	391	260
2#	2479.856	94.91	-1.24	93.67			AVG	391	260
3	2483.500	60.22	-1.25	58.97	74.00	-15.03	peak	391	260
4	2483.500	46.26	-1.25	45.01	54.00	-8.99	AVG	391	260
5	4960.000	49.11	4.90	54.01	74.00	-19.99	peak	100	315
6	4960.000	37.28	4.90	42.18	54.00	-11.82	AVG	100	315
7	7440.000	45.72	9.40	55.12	74.00	-18.88	peak	100	224
8	7440.000	39.87	9.40	49.27	54.00	-4.73	AVG	100	224
9	9920.000	49.36	13.46	62.82	74.00	-11.18	peak	100	101
10	9920.000	35.91	13.46	49.37	54.00	-4.63	AVG	100	101

Remarks:

- Emission Level = Read Level + Factor (Antenna Factor + Cable Loss - Preamp Factor)  
Margin value = Emission level – Limit value
- #2480MHz: Fundamental frequency.
- The amplitude of spurious emissions attenuated more than 20 dB below the permissible value is not required to be report.



Frequency Range	1GHz ~ 25GHz	Detector Function	Peak (PK) Average (AVG)
Test Channel	Channel 78		

Antenna Polarity & Test Distance: Vertical at 3 m

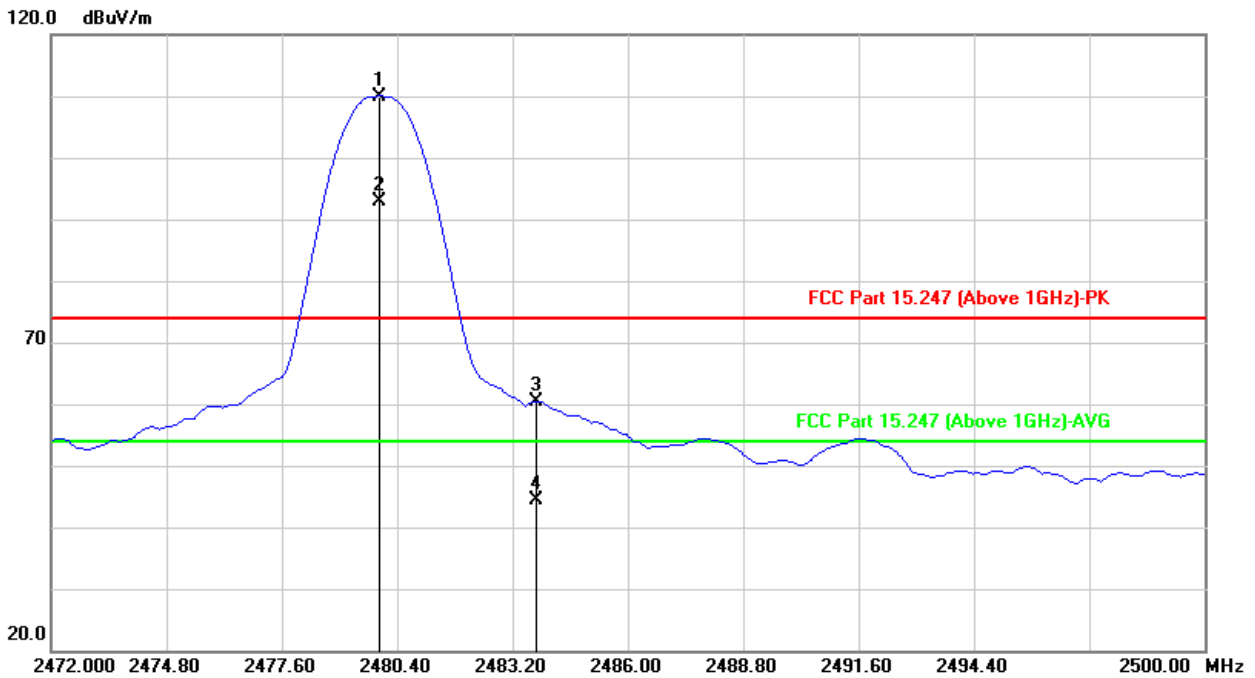

No.	Frequency (MHz)	Reading (dBuV)	Factor (dB)	Emission Level (dBuV/m)	Limit (dBuV/m)	Margin (dB)	Detector	Antenna Height (cm)	Table Angle (Degree)
1#	2479.968	111.24	-1.24	110.00			peak	100	94
2#	2479.968	94.13	-1.24	92.89			AVG	100	94
3	2483.784	61.68	-1.25	60.43	74.00	-13.57	peak	100	94
4	2483.784	45.57	-1.25	44.32	54.00	-9.68	AVG	100	94
5	4960.000	51.04	4.90	55.94	74.00	-18.06	peak	200	172
6	4960.000	38.77	4.90	43.67	54.00	-10.33	AVG	200	172
7	7440.000	46.78	9.40	56.18	74.00	-17.82	peak	100	69
8	7440.000	41.31	9.40	50.71	54.00	-3.29	AVG	100	69
9	9920.000	50.31	13.46	63.77	74.00	-10.23	peak	100	203
10	9920.000	36.72	13.46	50.18	54.00	-3.82	AVG	100	203

Remarks:

- Emission Level = Read Level + Factor (Antenna Factor + Cable Loss - Preamp Factor)  
Margin value = Emission level – Limit value
- #2480MHz: Fundamental frequency.
- The amplitude of spurious emissions attenuated more than 20 dB below the permissible value is not required to be report.



8DPSK

Frequency Range	1GHz ~ 25GHz	Detector Function	Peak (PK) Average (AVG)
Test Channel	Channel 0		

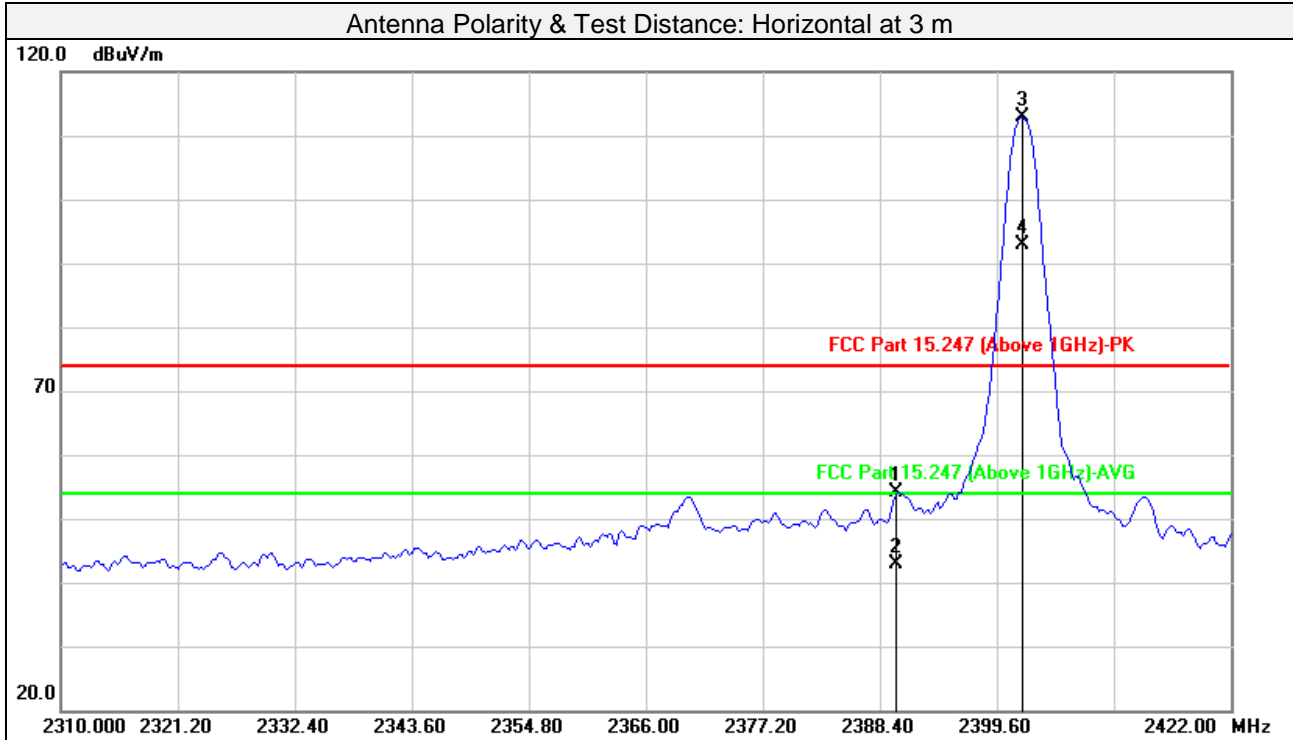

No.	Frequency (MHz)	Reading (dBuV)	Factor (dB)	Emission Level (dBuV/m)	Limit (dBuV/m)	Margin (dB)	Detector	Antenna Height (cm)	Table Angle (Degree)
1	2390.000	55.34	-1.30	54.04	74.00	-19.96	peak	336	268
2	2390.000	44.18	-1.30	42.88	54.00	-11.12	AVG	336	268
3#	2402.024	114.18	-1.30	112.88			peak	336	268
4#	2402.024	94.29	-1.30	92.99			AVG	336	268
5	4804.000	48.07	4.43	52.50	74.00	-21.50	peak	100	77
6	4804.000	35.86	4.43	40.29	54.00	-13.71	AVG	100	77
7	7206.000	46.29	9.09	55.38	74.00	-18.62	peak	100	51
8	7206.000	38.43	9.09	47.52	54.00	-6.48	AVG	100	51
9	9608.000	47.69	12.45	60.14	74.00	-13.86	peak	100	291
10	9608.000	38.19	12.45	50.64	54.00	-3.36	AVG	100	291

Remarks:

- Emission Level = Read Level + Factor (Antenna Factor + Cable Loss - Preamp Factor)  
Margin value = Emission level – Limit value
- #2402MHz: Fundamental frequency.
- The amplitude of spurious emissions attenuated more than 20 dB below the permissible value is not required to be report.





Frequency Range	1GHz ~ 25GHz	Detector Function	Peak (PK) Average (AVG)
Test Channel	Channel 0		

Antenna Polarity & Test Distance: Vertical at 3 m

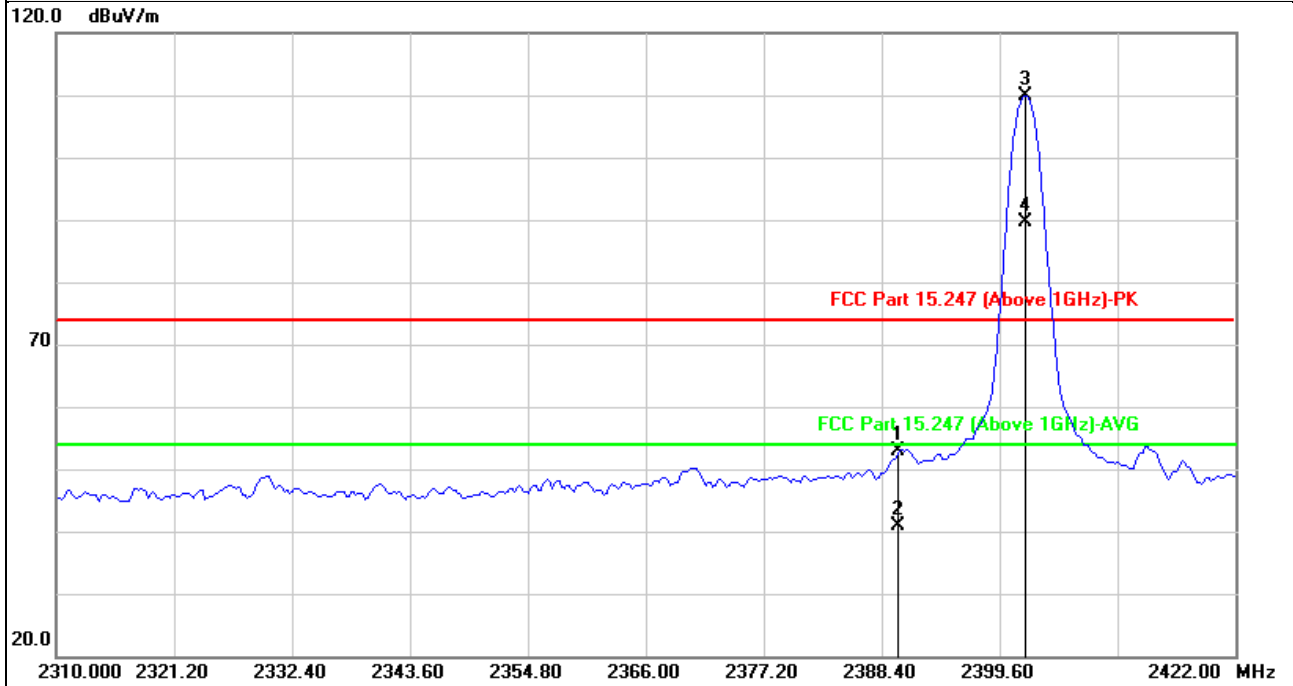

No.	Frequency (MHz)	Reading (dBuV)	Factor (dB)	Emission Level (dBuV/m)	Limit (dBuV/m)	Margin (dB)	Detector	Antenna Height (cm)	Table Angle (Degree)
1	2390.000	54.23	-1.30	52.93	74.00	-21.07	peak	100	93
2	2390.000	42.19	-1.30	40.89	54.00	-13.11	AVG	100	93
3#	2402.024	111.27	-1.30	109.97			peak	100	93
4#	2402.024	90.83	-1.30	89.53			AVG	100	93
5	4804.000	45.02	4.43	49.45	74.00	-24.55	peak	100	182
6	4804.000	33.17	4.43	37.60	54.00	-16.40	AVG	100	182
7	7206.000	48.66	9.09	57.75	74.00	-16.25	peak	200	41
8	7206.000	40.17	9.09	49.26	54.00	-4.74	AVG	200	41
9	9608.000	50.39	12.45	62.84	74.00	-11.16	peak	200	146
10	9608.000	37.99	12.45	50.44	54.00	-3.56	AVG	200	146

Remarks:

- Emission Level = Read Level + Factor (Antenna Factor + Cable Loss - Preamp Factor)  
Margin value = Emission level – Limit value
- #2402MHz: Fundamental frequency.
- The amplitude of spurious emissions attenuated more than 20 dB below the permissible value is not required to be report.



Frequency Range	1GHz ~ 25GHz	Detector Function	Peak (PK) Average (AVG)
Test Channel	Channel 39		

Antenna Polarity & Test Distance: Horizontal at 3 m									
No.	Frequency (MHz)	Reading (dBuV)	Factor (dB)	Emission Level (dBuV/m)	Limit (dBuV/m)	Margin (dB)	Detector	Antenna Height (cm)	Table Angle (Degree)
1#	2441.000	111.58	-1.27	110.31			peak	100	229
2#	2441.000	93.58	-1.27	92.31			AVG	100	229
3	4882.000	48.35	4.66	53.01	74.00	-20.99	peak	100	133
4	4882.000	36.96	4.66	41.62	54.00	-12.38	AVG	200	133
5	7323.000	45.07	9.24	54.31	74.00	-19.69	peak	200	207
6	7323.000	37.89	9.24	47.13	54.00	-6.87	AVG	100	207
7	9764.000	48.33	12.95	61.28	74.00	-12.72	peak	100	172
8	9764.000	37.69	12.95	50.64	54.00	-3.36	AVG	100	172
Antenna Polarity & Test Distance: Vertical at 3 m									
No.	Frequency (MHz)	Reading (dBuV)	Factor (dB)	Emission Level (dBuV/m)	Limit (dBuV/m)	Margin (dB)	Detector	Antenna Height (cm)	Table Angle (Degree)
1#	2441.000	109.91	-1.27	108.64			peak	300	294
2#	2441.000	89.61	-1.27	88.34			AVG	300	294
3	4882.000	49.18	4.66	53.84	74.00	-20.16	peak	100	176
4	4882.000	36.98	4.66	41.64	54.00	-12.36	AVG	100	176
5	7323.000	45.54	9.24	54.78	74.00	-19.22	peak	100	211
6	7323.000	40.58	9.24	49.82	54.00	-4.18	AVG	100	211
7	9764.000	48.72	12.95	61.67	74.00	-12.33	peak	100	105
8	9764.000	37.96	12.95	50.91	54.00	-3.09	AVG	100	105

**Remarks:**

- Emission Level = Read Level + Factor (Antenna Factor + Cable Loss - Preamp Factor)  
Margin value = Emission level – Limit value
- #2441MHz: Fundamental frequency.
- The amplitude of spurious emissions attenuated more than 20 dB below the permissible value is not required to be report.



Frequency Range	1GHz ~ 25GHz	Detector Function	Peak (PK) Average (AVG)
Test Channel	Channel 78		

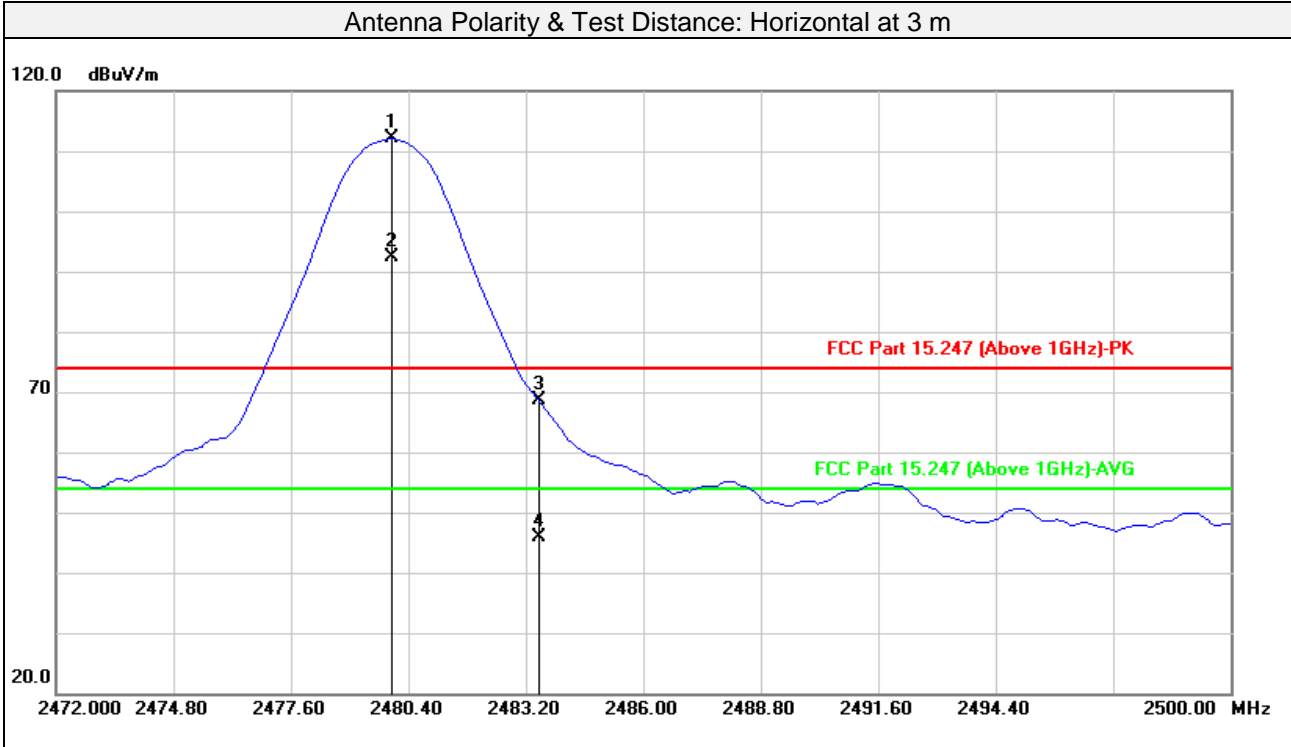

No.	Frequency (MHz)	Reading (dBuV)	Factor (dB)	Emission Level (dBuV/m)	Limit (dBuV/m)	Margin (dB)	Detector	Antenna Height (cm)	Table Angle (Degree)
1#	2480.024	113.30	-1.24	112.06			peak	221	262
2#	2480.024	93.57	-1.24	92.33			AVG	221	262
3	2483.500	69.84	-1.25	68.59	74.00	-5.41	peak	221	262
4	2483.500	47.16	-1.25	45.91	54.00	-8.09	AVG	221	262
5	4960.000	48.71	4.90	53.61	74.00	-20.39	peak	100	125
6	4960.000	36.51	4.90	41.41	54.00	-12.59	AVG	100	125
7	7440.000	45.41	9.40	54.81	74.00	-19.19	peak	100	216
8	7440.000	37.55	9.40	46.95	54.00	-7.05	AVG	100	216
9	9920.000	48.32	13.46	61.78	74.00	-12.22	peak	100	171
10	9920.000	37.28	13.46	50.74	54.00	-3.26	AVG	100	171

Remarks:

- Emission Level = Read Level + Factor (Antenna Factor + Cable Loss - Preamp Factor)  
Margin value = Emission level – Limit value
- #2480MHz: Fundamental frequency.
- The amplitude of spurious emissions attenuated more than 20 dB below the permissible value is not required to be report.



Frequency Range	1GHz ~ 25GHz	Detector Function	Peak (PK) Average (AVG)
Test Channel	Channel 78		

Antenna Polarity & Test Distance: Vertical at 3 m

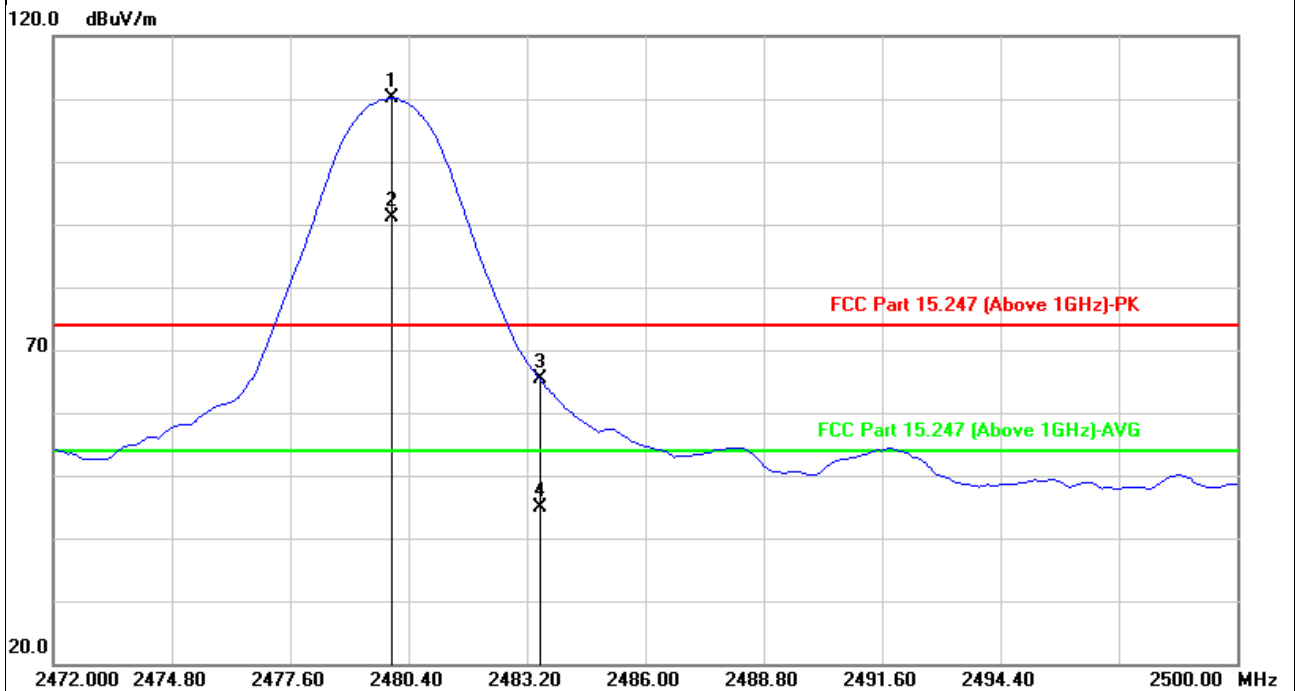

No.	Frequency (MHz)	Reading (dBuV)	Factor (dB)	Emission Level (dBuV/m)	Limit (dBuV/m)	Margin (dB)	Detector	Antenna Height (cm)	Table Angle (Degree)
1#	2480.024	111.44	-1.24	110.20			peak	100	94
2#	2480.024	92.33	-1.24	91.09			AVG	100	94
3	2483.500	66.68	-1.25	65.43	74.00	-8.57	peak	100	94
4	2483.500	46.02	-1.25	44.77	54.00	-9.23	AVG	100	94
5	4960.000	49.38	4.90	54.28	74.00	-19.72	peak	200	206
6	4960.000	37.67	4.90	42.57	54.00	-11.43	AVG	200	206
7	7440.000	46.35	9.40	55.75	74.00	-18.25	peak	100	288
8	7440.000	40.27	9.40	49.67	54.00	-4.33	AVG	100	288
9	9920.000	49.45	13.46	62.91	74.00	-11.09	peak	100	136
10	9920.000	37.38	13.46	50.84	54.00	-3.16	AVG	100	136

Remarks:

- Emission Level = Read Level + Factor (Antenna Factor + Cable Loss - Preamp Factor)  
Margin value = Emission level – Limit value
- #2480MHz: Fundamental frequency.
- The amplitude of spurious emissions attenuated more than 20 dB below the permissible value is not required to be report.



**3.2 Conducted Emission Measurement**

3.2.1 Limits of Conducted Emission Measurement

Frequency (MHz)	Conducted Limit (dBuV)	
	Quasi-peak	Average
0.15 - 0.5	66 - 56	56 - 46
0.50 - 5.0	56	46
5.0 - 30.0	60	50

Note: 1. The lower limit shall apply at the transition frequencies.  
 2. The limit decreases in line with the logarithm of the frequency in the range of 0.15 to 0.50MHz.

3.2.2 Test Instruments

Description & Manufacturer	Model No.	Serial No.	Due Date of Calibration
EMI Test Receiver Rohde&Schwarz	ESCI3	101418	2022/09/12
Artificial Mains Network Rohde&Schwarz	ENV216	3560.6550.15	2022/09/12
Test software FARAD	EZ_EMCC V1.1.4.2	N/A	N/A
Hygrothermograph Yuhuaze	HTC-1	NA	2022/09/12
Digital Multimeter FLUKE	15B+	43512617WS	2022/09/12

Note: 1. The calibration interval of the above test instruments is 12 months and the calibrations are traceable to CEPREI/CHINA.  
 2. The test was performed in Shielded Room 1.



### 3.2.3 Test Procedures

- The EUT was placed 0.4 meters from the conducting wall of the shielded room with EUT being connected to the power mains through a line impedance stabilization network (LISN). Other support units were connected to the power mains through another LISN. The two LISNs provide 50 ohm/ 50uH of coupling impedance for the measuring instrument.
- Both lines of the power mains connected to the EUT were checked for maximum conducted interference.
- The frequency range from 150kHz to 30MHz was searched. Emission levels under (Limit – 20dB) was not recorded.

**Note:** All modes of operation were investigated and the worst-case emissions are reported.

### 3.2.4 Test Setup

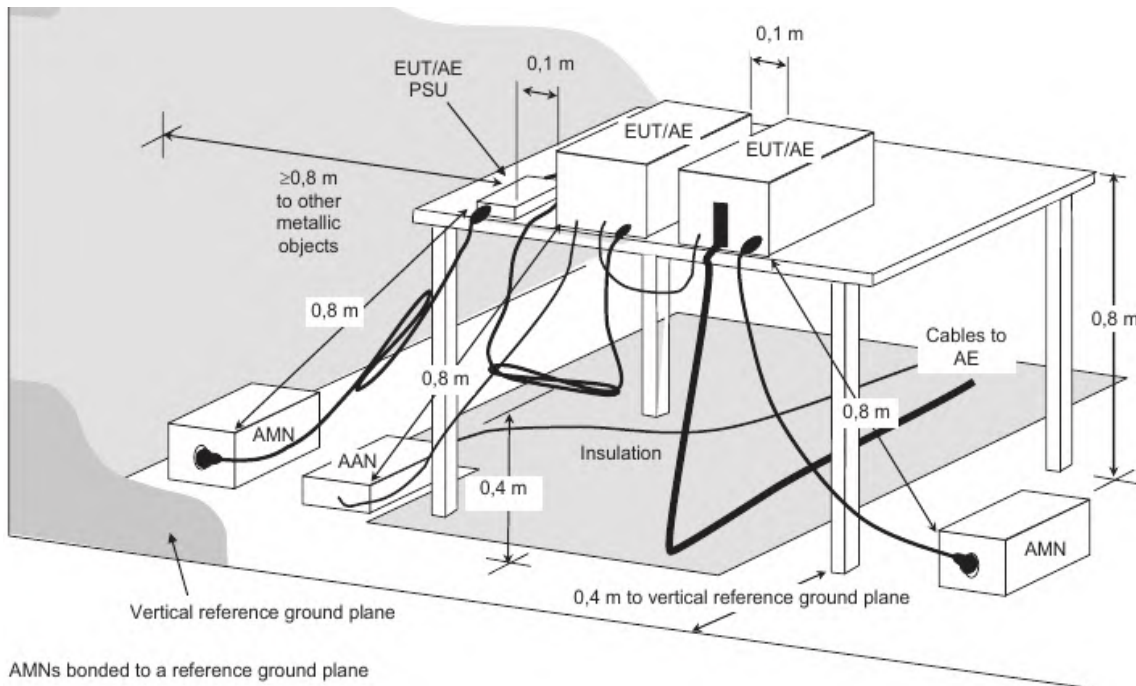

For the actual test configuration, please refer to the attached file (Test Setup Photo).

### 3.2.5 EUT Operating Condition

Set the EUT under transmission condition continuously at specific channel frequency.

### 3.2.6 Deviation from Test Standard

No deviation.



3.2.7 Test Results

Frequency Range	150kHz ~ 30MHz	Detector Function & Resolution bandwidth	Quasi-Peak (QP) / Average (AV), 9kHz
-----------------	----------------	--	--------------------------------------

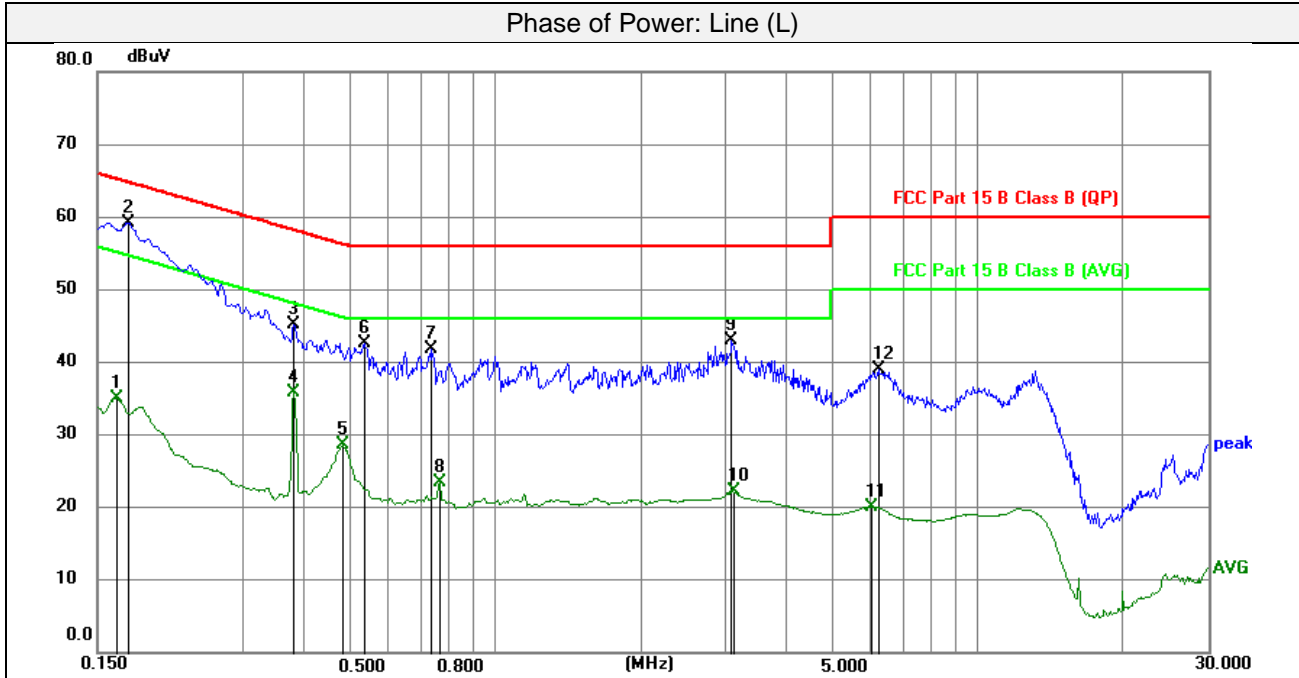

No.	Frequency (MHz)	Reading (dBuV)	Correction Factor (dB)	Emission Level (dBuV)	Limit (dBuV)	Margin (dB)	Remark
1	0.1635	24.83	10.17	35.00	55.28	-20.28	AVG
2	0.1725	49.09	10.16	59.25	64.84	-5.59	peak
3	0.3839	35.11	10.10	45.21	58.19	-12.98	peak
4	0.3839	25.68	10.10	35.78	48.19	-12.41	AVG
5	0.4852	18.43	10.11	28.54	46.25	-17.71	AVG
6	0.5369	32.49	10.11	42.60	56.00	-13.40	peak
7	0.7417	31.70	10.09	41.79	56.00	-14.21	peak
8	0.7687	13.33	10.09	23.42	46.00	-22.58	AVG
9	3.1065	32.95	10.09	43.04	56.00	-12.96	peak
10	3.1087	12.13	10.09	22.22	46.00	-23.78	AVG
11	6.0135	10.12	9.99	20.11	50.00	-29.89	AVG
12	6.2227	29.02	10.01	39.03	60.00	-20.97	peak

Remarks:

1. Q.P. and AV. are abbreviations of quasi-peak and average individually.
2. The emission levels of other frequencies were very low against the limit.
3. Margin value = Emission level - Limit value
4. Correction factor = Insertion loss + Cable loss
5. Emission Level = Correction Factor + Reading Value.



Frequency Range	150kHz ~ 30MHz	Detector Function & Resolution andwidth	Quasi-Peak (QP) / Average (AV), 9kHz
-----------------	----------------	---	--------------------------------------

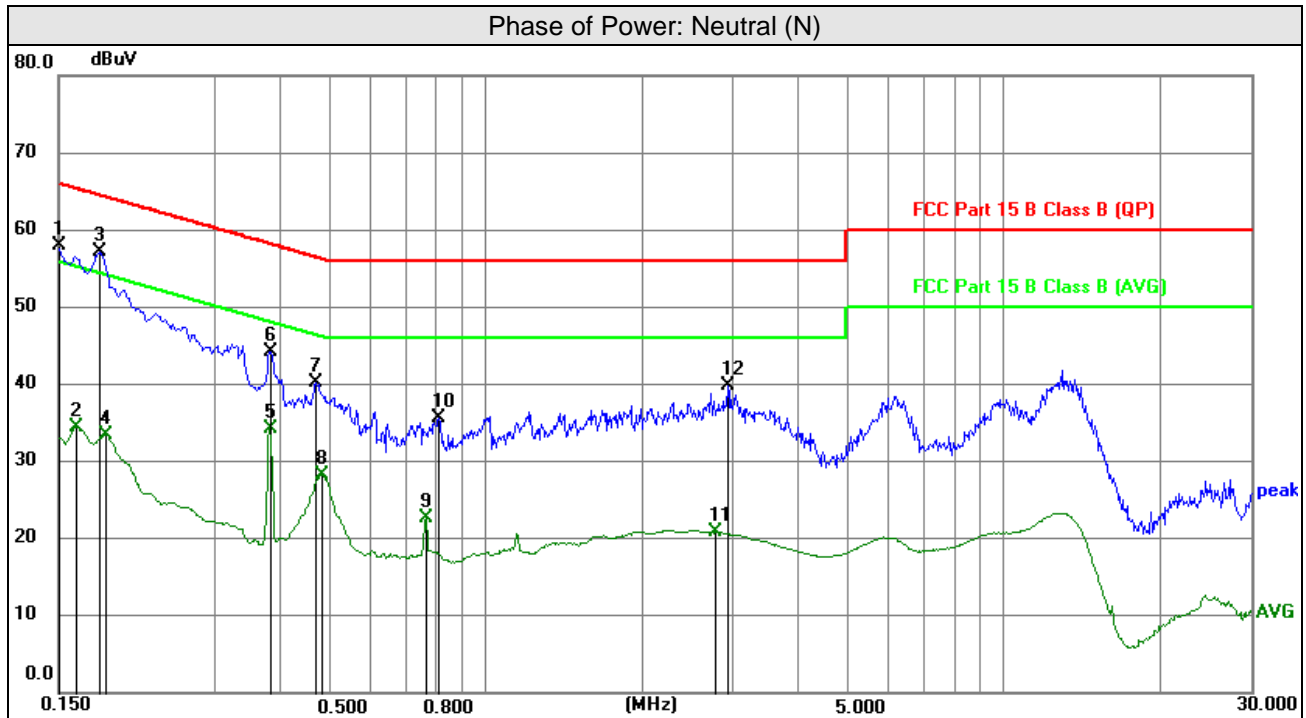

No.	Frequency (MHz)	Reading (dBuV)	Correct Factor (dB)	Emission Level (dBuV)	Limit (dBuV)	Margin (dB)	Remark
1	0.1500	47.84	10.19	58.03	66.00	-7.97	peak
2	0.1613	24.24	10.17	34.41	55.40	-20.99	AVG
3	0.1793	46.98	10.16	57.14	64.52	-7.38	peak
4	0.1838	23.23	10.15	33.38	54.31	-20.93	AVG
5	0.3840	24.17	10.10	34.27	48.19	-13.92	AVG
6	0.3862	34.15	10.10	44.25	58.15	-13.90	peak
7	0.4717	30.09	10.11	40.20	56.48	-16.28	peak
8	0.4852	18.15	10.11	28.26	46.25	-17.99	AVG
9	0.7687	12.56	10.09	22.65	46.00	-23.35	AVG
10	0.8137	25.44	10.08	35.52	56.00	-20.48	peak
11	2.7869	10.78	10.09	20.87	46.00	-25.13	AVG
12	2.9310	29.70	10.09	39.79	56.00	-16.21	peak

**Remarks:**

1. Q.P. and AV. are abbreviations of quasi-peak and average individually.
2. The emission levels of other frequencies were very low against the limit.
3. Margin value = Emission level - Limit value
4. Correction factor = Insertion loss + Cable loss
5. Emission Level = Correction Factor + Reading Value.





### 3.3 Number of Hopping Frequency Used

#### 3.3.1 Limits of Hopping Frequency Used Measurement

At least 15 channels frequencies, and should be equally spaced.

#### 3.3.2 Test Setup

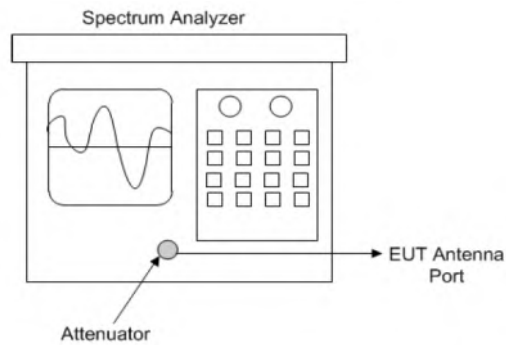

Spectrum analyzer test configuration

#### 3.3.3 Test Instruments

Refer to section 5 to get information of above instrument.

#### 3.3.4 Test Procedure

- Check the calibration of the measuring instrument (SA) using either an internal calibrator or a known signal from an external generator.
- Turn on the EUT and connect its antenna terminal to measurement via a low loss cable. Then set it to any one measured frequency within its operating range and make sure the instrument is operated in its linear range.
- Set the SA on MaxHold Mode, and then keep the EUT in hopping mode. Record all the signals from each channel until each one has been recorded.
- Set the SA on View mode and then plot the result on SA screen.
- Repeat above procedures until all frequencies measured were complete.

#### 3.3.5 Deviation from Test Standard

No deviation.



### 3.3.6 Test Results

There are 79 hopping frequencies in the hopping mode. Please refer to next page for the test result. On the plots, it shows that the hopping frequencies are equally spaced.

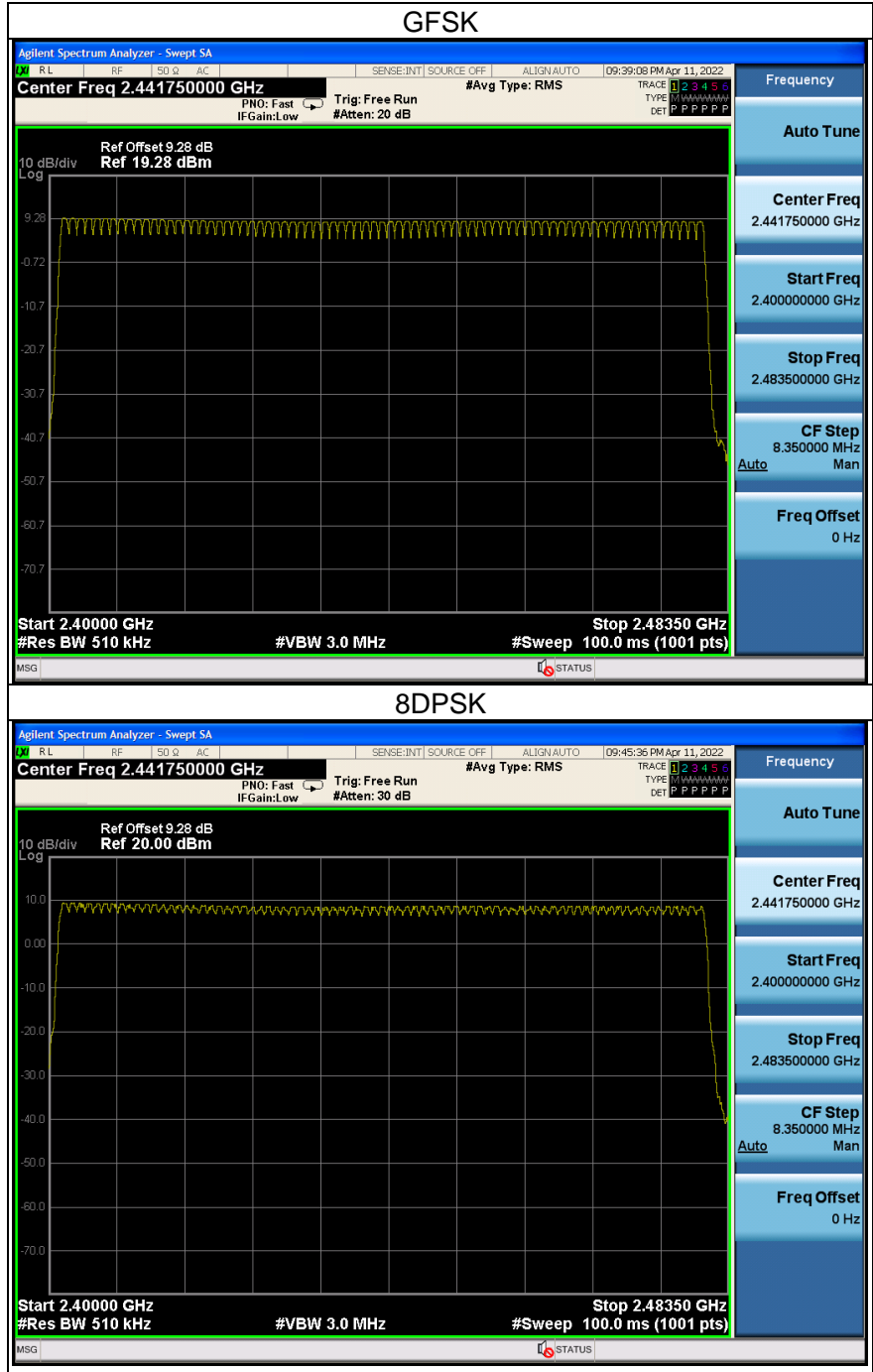



### 3.4 Dwell Time on Each Channel

#### 3.4.1 Limits of Dwell Time on Each Channel Measurement

The average time of occupancy on any channel shall not be greater than 0.4 seconds within a period of 0.4 seconds multiplied by the number of hopping channels employed.

#### 3.4.2 Test Setup

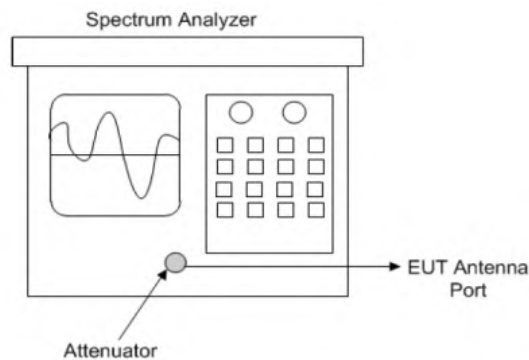

Spectrum analyzer test configuration

#### 3.4.3 Test Instruments

Refer to section 5 to get information of above instrument.

#### 3.4.4 Test Procedures

- Check the calibration of the measuring instrument (SA) using either an internal calibrator or a known signal from an external generator.
- Turn on the EUT and connect its antenna terminal to measurement via a low loss cable. Then set it to any one measured frequency within its operating range and make sure the instrument is operated in its linear range.
- Adjust the center frequency of SA on any frequency be measured and set SA to zero span mode. And then, set RBW and VBW of spectrum analyzer to proper value.
- Measure the time duration of one transmission on the measured frequency. And then plot the result with time difference of this time duration.
- Repeat above procedures until all different time-slot modes have been completed.

#### 3.4.5 Deviation from Test Standard

No deviation.



3.4.6 Test Results

GFSK

Mode	Number of Hopping Channel	Number of transmission in a period (channel number*0.4 sec)				Length of transmission time (msec)	Result (msec)	Limit (msec)	Verdict
		Period (sec)	Sweep time (sec)	times in a sweep	times in a period				
DH1	79	31.6	3.16	32	320	0.372	119.04	400	Pass
DH3	79	31.6	3.16	16	160	1.620	259.20	400	Pass
DH5	79	31.6	3.16	11	110	2.868	315.48	400	Pass

Note: Test plots of the transmitting time slot are shown as below.

8DPSK

Mode	Number of Hopping Channel	Number of transmission in a period (channel number*0.4 sec)				Length of transmission time (msec)	Result (msec)	Limit (msec)	Verdict
		Period (sec)	Sweep time (sec)	times in a sweep	times in a period				
3DH1	79	31.6	3.16	32	320	0.379	121.28	400	Pass
3DH3	79	31.6	3.16	16	160	1.629	260.64	400	Pass
3DH5	79	31.6	3.16	10	100	2.882	317.02	400	Pass

Note: Test plots of the transmitting time slot are shown as below.



GFSK

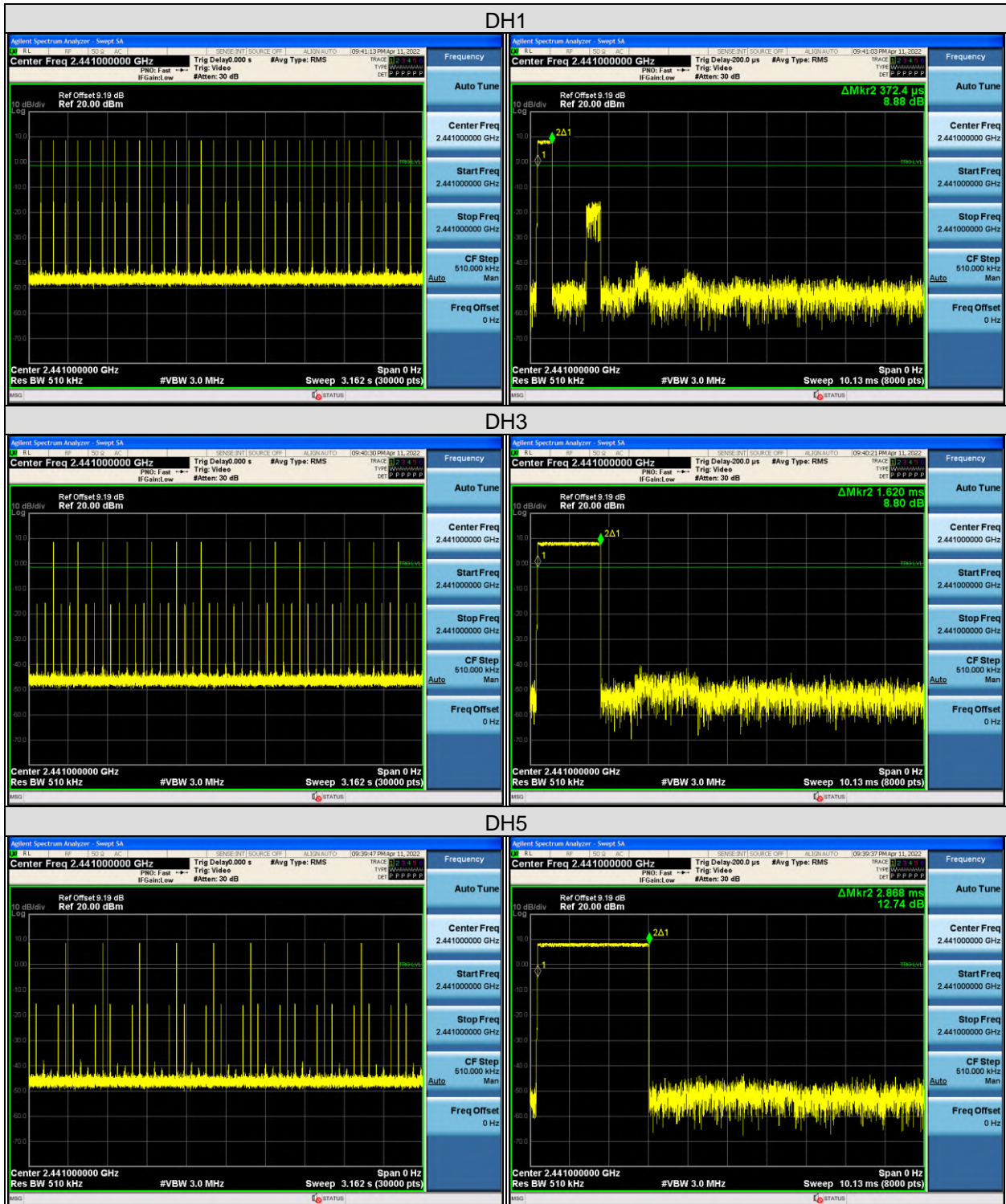



8DPSK

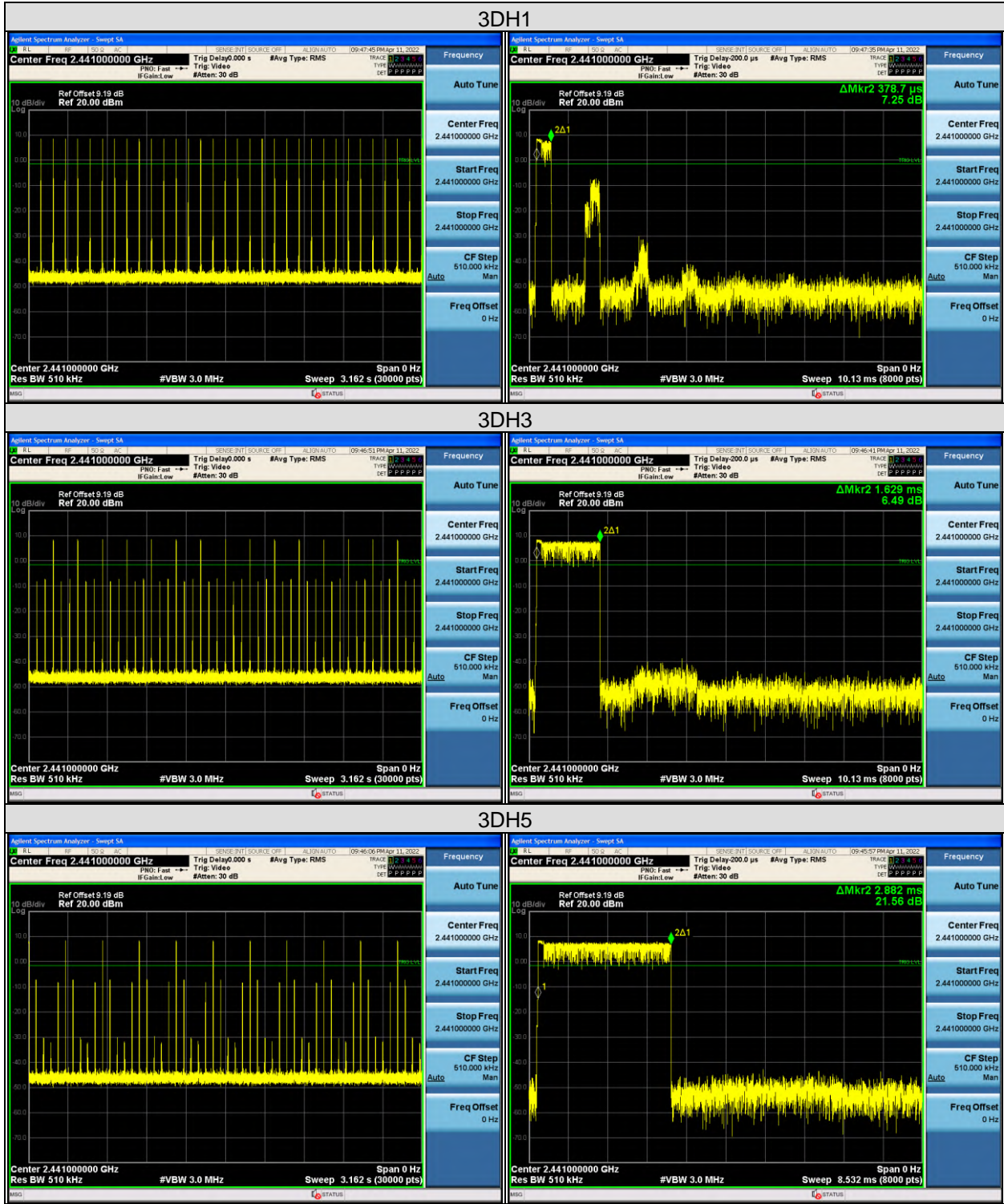



### 3.5 Channel Bandwidth

#### 3.5.1 Limits of Channel Bandwidth Measurement

For frequency hopping system operating in the 2400-2483.5 MHz, if the 20 dB bandwidth of hopping channel is greater than 25 kHz, two-thirds 20 dB bandwidth of hopping channel shall be a minimum limit for the hopping channel separation.

#### 3.5.2 Test Setup

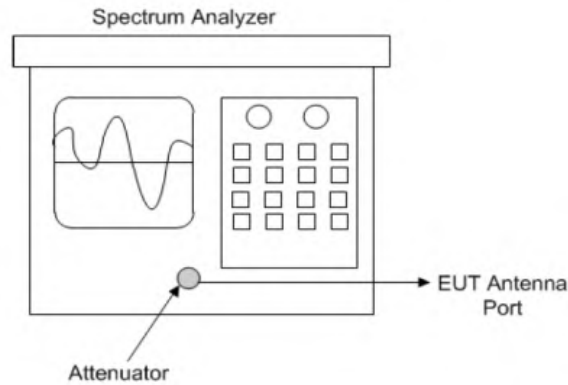

Spectrum analyzer test configuration

#### 3.5.3 Test Instruments

Refer to section 5 to get information of above instrument.

#### 3.5.4 Test Procedure

- Check the calibration of the measuring instrument using either an internal calibrator or a known signal from an external generator.
- Turn on the EUT and connect it to measurement instrument. Then set it to any one convenient frequency within its operating range. Set a reference level on the instrument equal to the highest peak value.
- Measure the frequency difference of two frequencies that were attenuated 20 dB from the reference level. Record the frequency difference as the emission bandwidth.
- Repeat above procedures until all frequencies measured were complete.

#### 3.5.5 Deviation from Test Standard

No deviation.

#### 3.5.6 EUT Operating Condition

The software provided by client enabled the EUT to transmit and receive data at lowest, middle and highest channel frequencies individually.



3.5.7 Test Results

Channel	Frequency (MHz)	20dB Bandwidth (MHz)	
		GFSK	8DPSK
0	2402	0.948	1.272
39	2441	1.038	1.323
78	2480	0.948	1.266





Lab: [Hwa-Hsing \(Dongguan\) Testing Co., Ltd.](#)  
 Address: [No.101, Bld N1, Yuyuan 2Rd, Yuyuan Industrial Park, HuangJiang Town, Dongguan, China](#)

Tel: [0769-83078199](tel:0769-83078199)  
 Web.: [www.hwa-hsing.com](http://www.hwa-hsing.com)  
 E-Mail: [customerservice.dg@hwa-hsing.com](mailto:customerservice.dg@hwa-hsing.com)

Release  
 Ver. 1.5



### 3.6 Occupied Bandwidth Measurement

#### 3.6.1 Test Setup

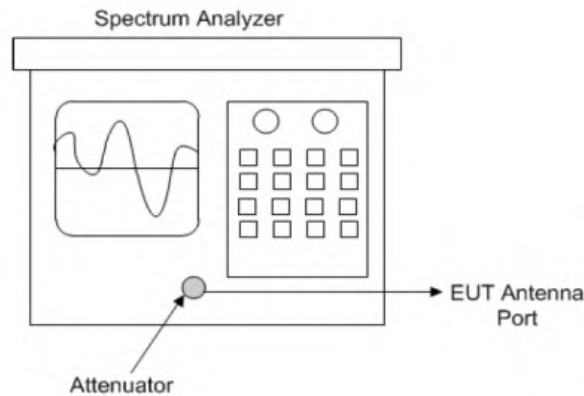

Spectrum analyzer test configuration

#### 3.6.2 Test Instruments

Refer to section 5 to get information of above instrument

#### 3.6.3 Test Procedure

The transmitter output was connected to the spectrum analyzer through an attenuator. The bandwidth of the fundamental frequency was measured by spectrum analyzer with resolution bandwidth in the range of 1% to 5% of the anticipated emission bandwidth, and a video bandwidth at least 3x the resolution bandwidth and set the detector to PEAK. The width of a frequency band such that, below the lower and above the upper frequency limits, the mean powers emitted are each equal to a specified percentage 0.5% of the total mean power of a given emission.

#### 3.6.4 Deviation from Test Standard

No deviation.

#### 3.6.5 EUT Operating Conditions

The software provided by client to enable the EUT under transmission condition continuously at lowest, middle and highest channel frequencies individually.



3.6.6 Test Results

Channel	Frequency (MHz)	OccupiedBandwidth (MHz)	
		GFSK	8DPSK
0	2402	0.9082	1.1834
39	2441	0.9044	1.2036
78	2480	0.9244	1.1757





### 3.7 Hopping Channel Separation

#### 3.7.1 Limits of Hopping Channel Separation Measurement

At least 25 kHz or two-third of 20 dB hopping channel bandwidth (whichever is greater).

#### 3.7.2 Test Setup

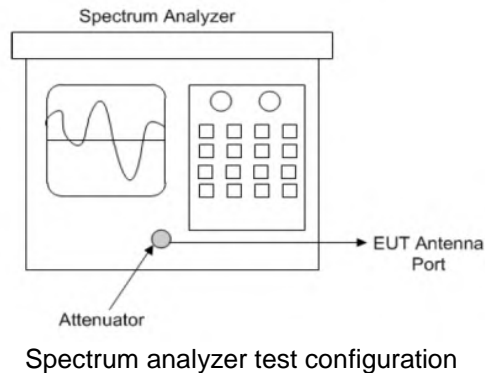

#### 3.7.3 Test Instruments

Refer to section 5 to get information of above instrument.

#### 3.7.4 Test Procedure

Measurement Procedure REF

- Check the calibration of the measuring instrument using either an internal calibrator or a known signal from an external generator.
- Turn on the EUT and connect it to measurement instrument. Then set it to any one convenient frequency within its operating range.
- By using the MaxHold function record the separation of two adjacent channels.
- Measure the frequency difference of these two adjacent channels by SA MARK function. And then plot the result on SA screen.
- Repeat above procedures until all frequencies measured were complete.

#### 3.7.5 Deviation from Test Standard

No deviation.



3.7.6 Test Results

Channel No.	Frequency (MHz)	Adjacent Channel Separation (MHz)		Minimum Limit (MHz)		Pass / Fail
		GFSK	8DPSK	GFSK	8DPSK	
0	2402	1.002	1.008	0.632	0.848	Pass
39	2441	0.987	0.999	0.692	0.882	Pass
78	2480	0.996	1.002	0.632	0.844	Pass

**Note:** The minimum limit is two-third 20 dB bandwidth.



Spectrum Plot



Lab: [Hwa-Hsing \(Dongguan\) Testing Co., Ltd.](#)  
Address: [No.101, Bld N1, Yuyuan 2Rd, Yuyuan Industrial Park, HuangJiang Town, Dongguan, China](#)

Tel: [0769-83078199](tel:0769-83078199)  
Web: [www.hwa-hsing.com](http://www.hwa-hsing.com)  
E-Mail: [customerservice.dg@hwa-hsing.com](mailto:customerservice.dg@hwa-hsing.com)

Release [Ver. 1.5](#)



### 3.8 Maximum Output Power

#### 3.8.1 Limits of Maximum Output Power Measurement

The Maximum Output Power Measurement is 125mW.

#### 3.8.2 Test Setup

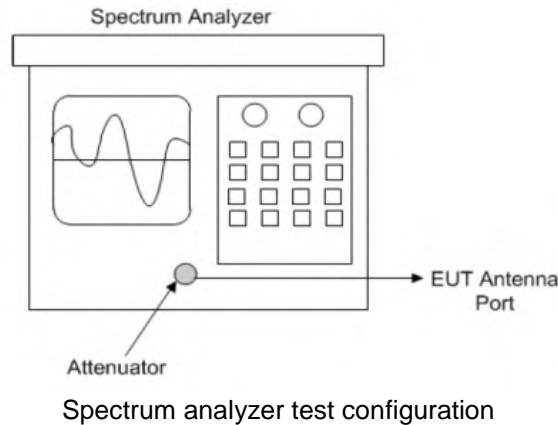

#### 3.8.3 Test Instruments

Refer to section 5 to get information of above instrument.

#### 3.8.4 Test Procedure

Measurement using a spectrum analyzer (SA), Selection of test method:

The proper test method is selected based on the following criteria:

- a) **Method AVGSA-1 or method AVGSA-1A (alternative)** shall be applied if either of the following conditions can be satisfied:
  - 1) The EUT transmits continuously (or with a  $D > 98\%$ ).
  - 2) Sweep triggering can be implemented in such a way that the device transmits at the maximum power control level throughout the duration of each of the instrument sweeps to be averaged. This condition can generally be achieved by triggering the instrument's sweep if the duration of the sweep (with the instrument configured as in method AVGSA-1) is equal to or shorter than the duration  $T$  of each transmission from the EUT, and if those transmissions exhibit full power throughout their durations.
- b) **Method AVGSA-2 or method AVGSA-2A (alternative)** shall be applied if the conditions of the preceding item a) cannot be achieved and the transmissions exhibit a constant duty cycle during the measurement duration. Duty cycle will be considered to be constant if variations are less than +2%.
- c) **Method AVGSA-3 or method AVGSA-3A (alternative)** shall be applied if the conditions of the preceding item a) and item b) cannot be achieved.





**Method AVGSA-3 or method AVGSA-3A:**

- a) Check the calibration of the measuring instrument using either an internal calibrator or a known signal from an external generator.
- b) Turn on the EUT and connect it to measurement instrument. Then set it to any one convenient frequency within its operating range. Set a reference level on the measuring instrument equal to the highest peak value.
- c) SA Setting:
  - 1\* Set span to at least 1.5 times the OBW
  - 2\* Set sweep trigger to "free run."
  - 3\* Set RBW= 1% to 5% of the OBW. not to exceed 1MHz.
  - 4\* Set VBW  $\geq 3 \times$  RBW
  - 5\* Number of points in sweep  $\geq 2 \times$  span /RBW.(This gives bin-to-bin spacing  $\leq$  RBW / 2. so that narrowband signals are not lost between frequency bins).
  - 6\* Sweep time  $\leq$  (number of points in sweep) x T. where T is defined in 11.6. If this gives a sweep time less than the auto sweep time of the instrument. then method AVGSA-3 shall not be used (use AVGSA-3A). The purpose of this step is so that the averaging time in each bin is less than or equal to the minimum time of a transmission.
  - 7\* Detector =RMS (power averaging).
  - 8\* Trace mode =max hold.
  - 9\* Allow max hold to run for at least 60 s or longer as needed to allow the trace to stabilize.
  - 10\* Compute power by integrating the spectrum across the OBW of the signal using the instrument's band power measurement function with band limits set equal to the OBW band edges. If the instrument does not have a band power function. then sum the spectrum levels (in power units) at intervals equal to the RBW extending across the entire OBW
- d. Measure the captured power within the band and recording the plot.
- e. Repeat above procedures until all frequencies required were complete.

**3.8.5 Deviation from Test Standard**

No deviation.

**3.8.6 EUT Operating Condition**

The software provided by client enabled the EUT to transmit and receive data at lowest, middle and highest channel frequencies individually.



3.8.7 Test Results

**PEAK POWER**

Channel No.	Freq. (MHz)	Output Power (mW)		Output Power (dBm)		Power Limit (mW)	Pass / Fail
		GFSK	8DPSK	GFSK	8DPSK		
0	2402	9.110	10.867	9.595	10.361	125	Pass
39	2441	7.468	8.964	8.732	9.525	125	Pass
78	2480	7.439	8.927	8.715	9.507	125	Pass

**AVERAGE POWER**

Channel No.	Freq. (MHz)	Output Power (mW)		Output Power (dBm)		Power Limit (mW)	Pass / Fail
		GFSK	8DPSK	GFSK	8DPSK		
0	2402	5.237	5.794	7.191	7.630	125	Pass
39	2441	5.192	5.093	7.153	7.070	125	Pass
78	2480	4.690	5.274	6.712	7.221	125	Pass



Peak Power Spectrum Plot

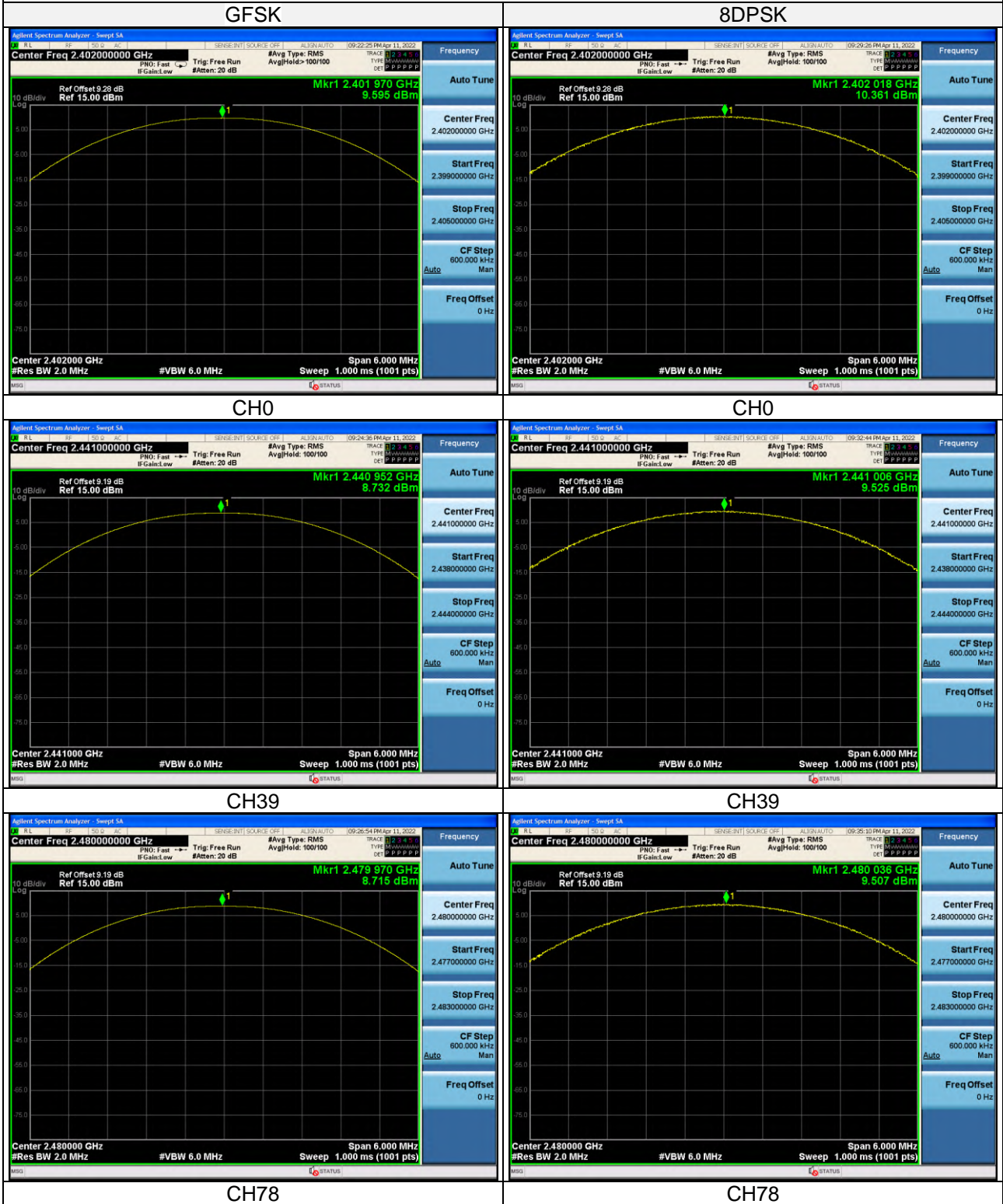



Average Power Spectrum Plot

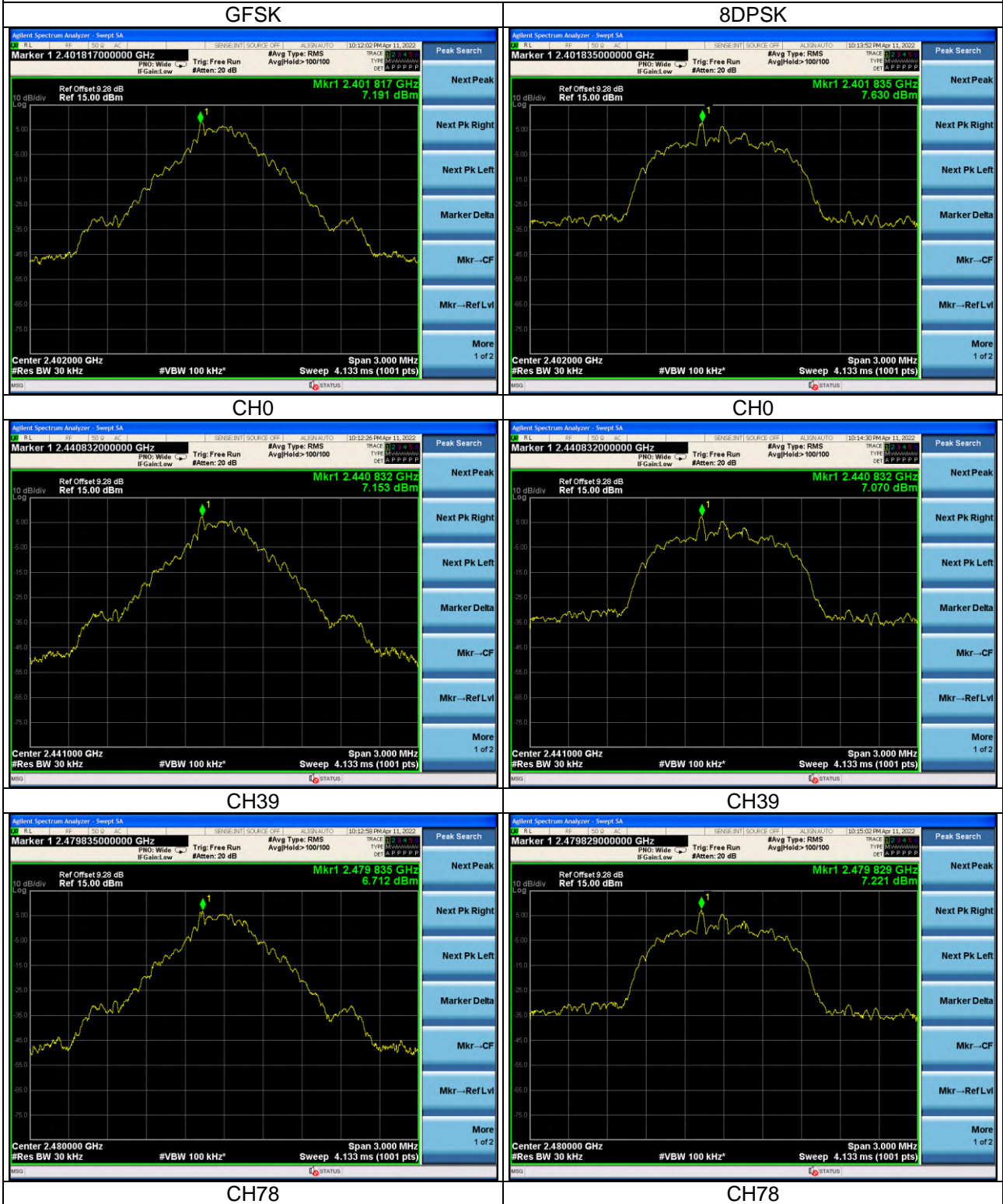



### 3.9 Conducted Out of Band Emission Measurement

#### 3.9.1 Limits of Conducted Out of Band Emission Measurement

- a. **If the maximum peak conducted output power procedure was used to determine compliance as described in 11.9.1**, then the peak output power measured in any 100 kHz bandwidth outside of the authorized frequency band shall be attenuated by at least 20 dB relative to the maximum in-band peak PSD level in 100 kHz (i.e., 20 dBc).
- b. **If maximum conducted (average) output power was used to determine compliance as described in 11.9.2**, then the peak power in any 100 kHz bandwidth outside of the authorized frequency band shall be attenuated by at least 30 dB relative to the maximum in-band peak PSD level in 100 kHz (i.e., 30 dBc)

#### 3.9.2 Tets Setup

- DTS emissions in non-restricted frequency bands Subclause 11.11 of ANSI C63.10 is applicable.
- DTS emissions in restricted frequency bands Subclause 11.12 of ANSI C63.10 is applicable

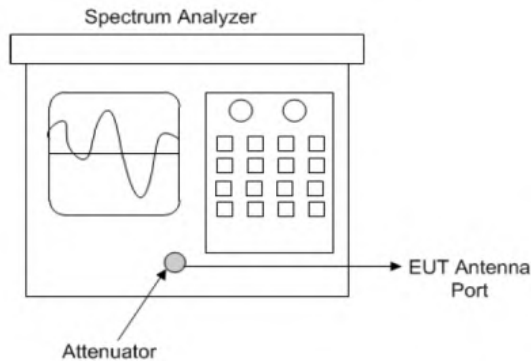

Spectrum analyzer test configuration

#### 3.9.3 Test Instruments

Refer to section 5 to get information of above instrument.

#### 3.9.4 Test Procedure

- a. Establish a reference level by using the following procedure:
  - 1) Set instrument center frequency to DTS channel center frequency.
  - 2) Set the span to 21.5 times the DTS bandwidth)
  - 3) Set the RBW= 100 kHz)
  - 4) Set the VBW  $\geq 3 \times$  RBW
  - 5) Detector = peak
  - 6) Sweep time = auto coupling
  - 7) Trace mode =max hold
  - 8) Allow trace to fully stabilize
  - 9) Use the peak marker function to determine the maximum PSD level.

Note that the channel found to contain the maximum PSD level can be used to establish the reference level.



b. Establish an emission level by using the following procedure:

- 1) Set the center frequency and span to encompass frequency range to be measured.
- 2) Set the RBW = 100 kHz
- 3) Set the VBW  $\geq$  300 kHz.
- 4) Detector = peak.
- 5) Sweep time = auto couple.
- 6) Trace mode = max hold.
- 7) Allow trace to fully stabilize.
- 8) Use the peak marker function to determine the maximum power level in any 100 kHz band segment within the fundamental EBW.

### 3.9.5 Deviation from Test Standard

No deviation.

### 3.9.6 EUT Operating Condition

The software provided by client enabled the EUT to transmit and receive data at lowest, middle and highest channel frequencies individually.



3.9.7 Test Results

The spectrum plots are attached on the following images. D1 line indicates the highest level, D2 line indicates the 30dB offset below D1. It shows compliance with the requirement.

GFSK

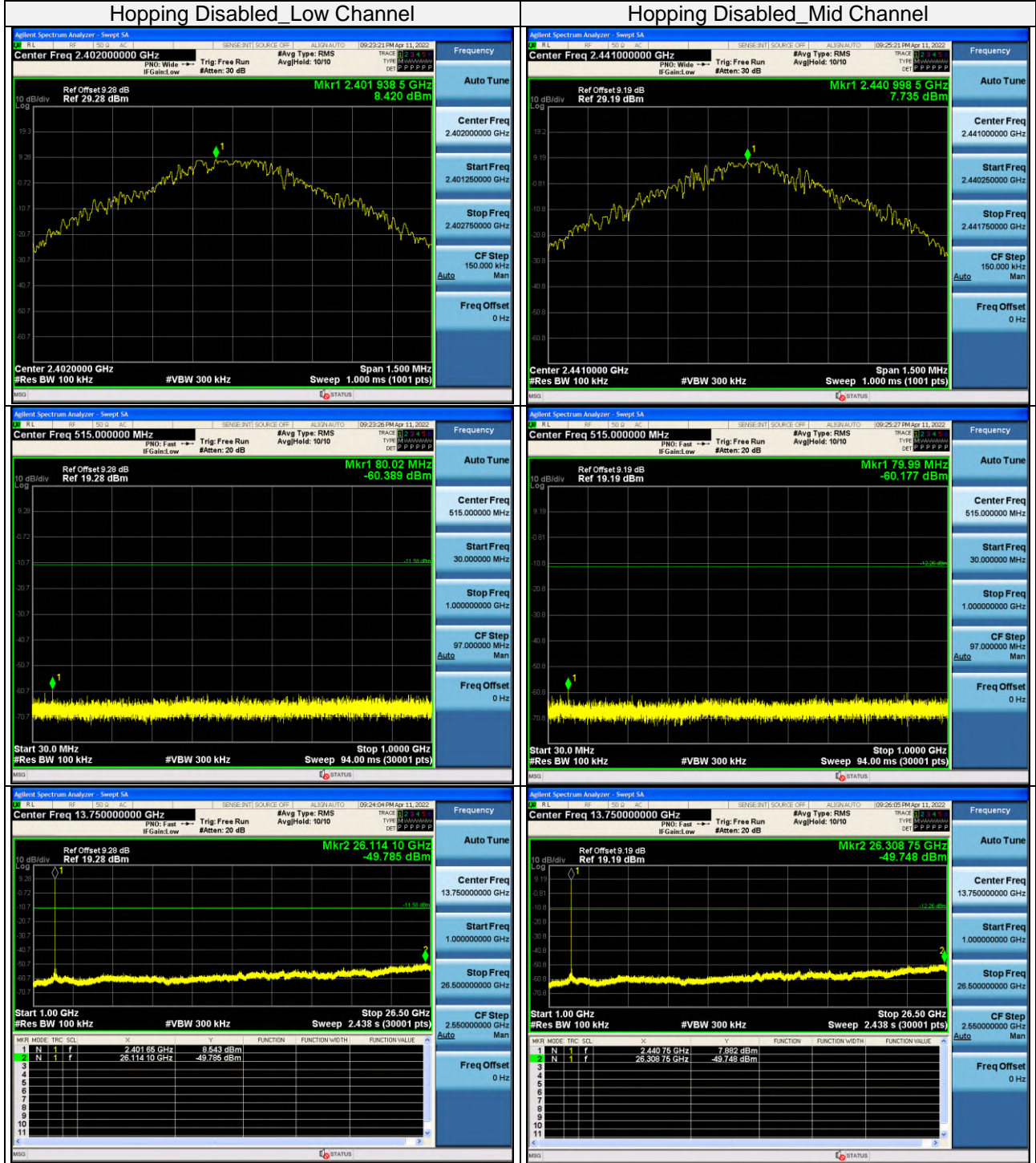

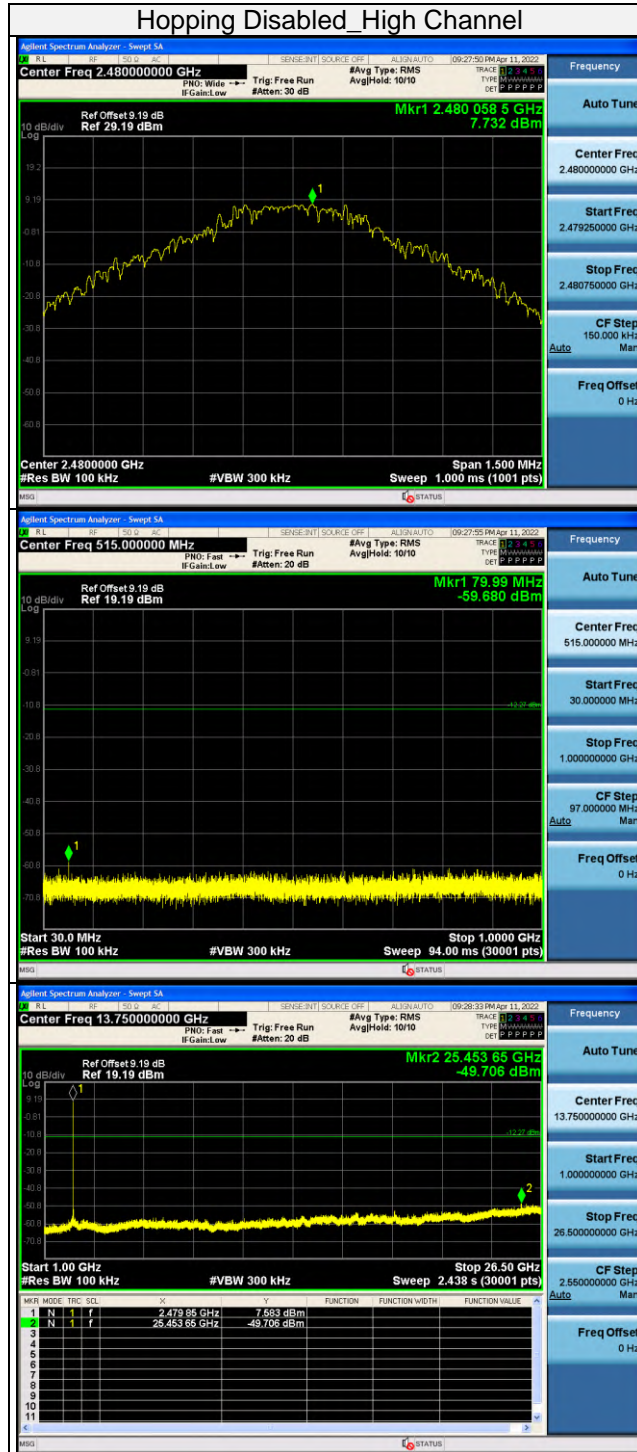





8DPSK

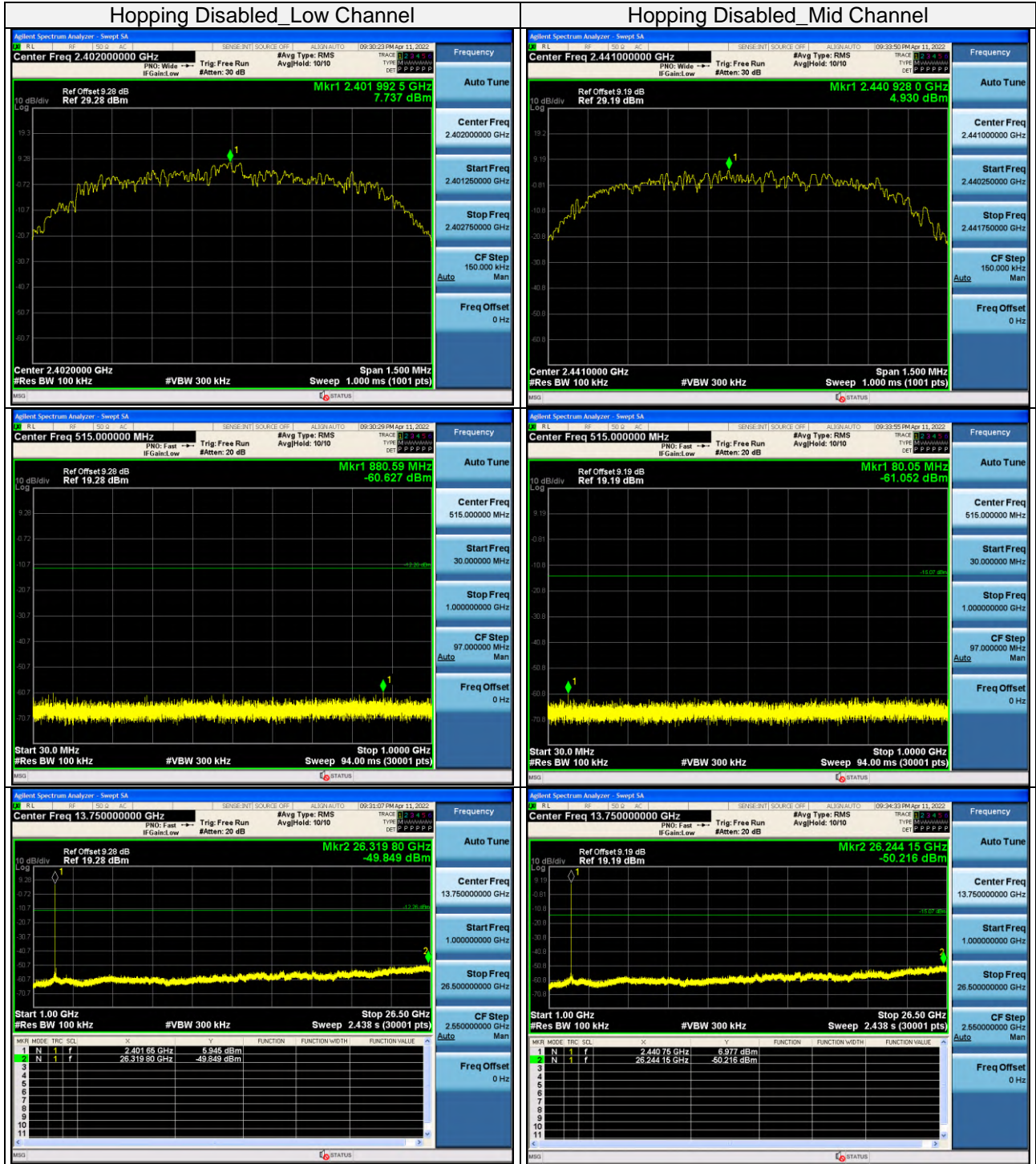

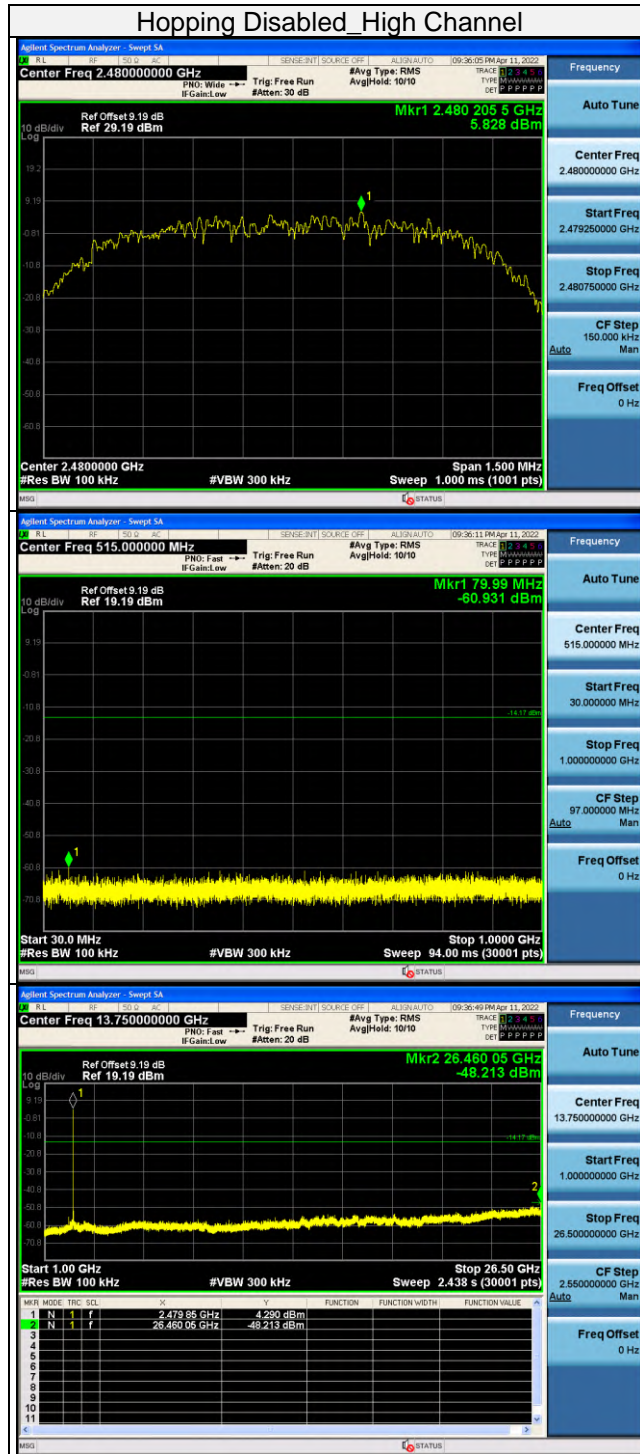



Bandedge: GFSK

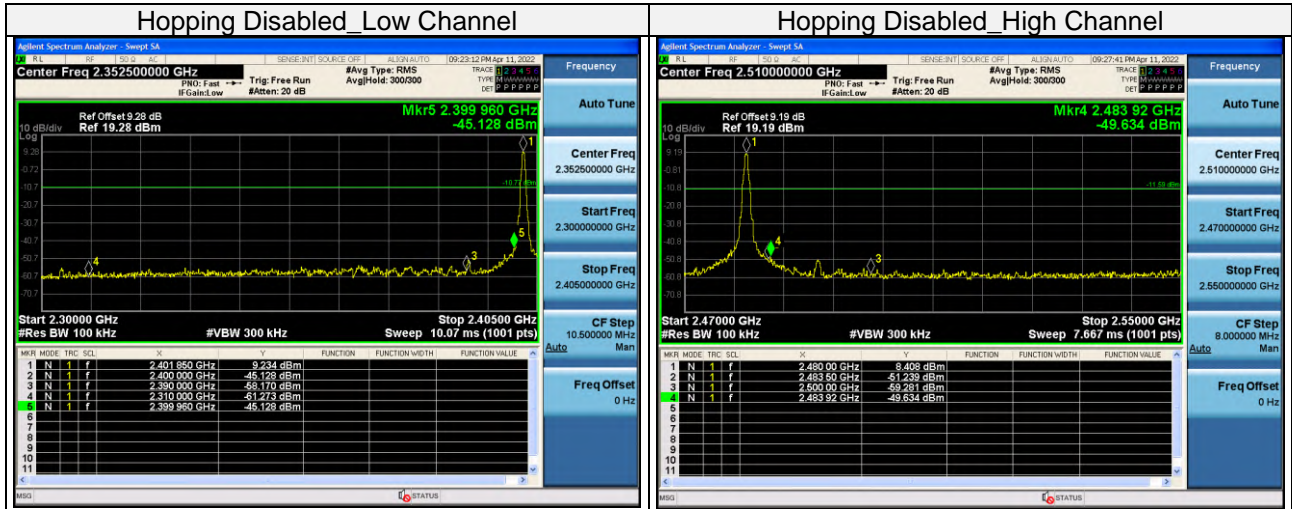

Bandedge: 8DPSK

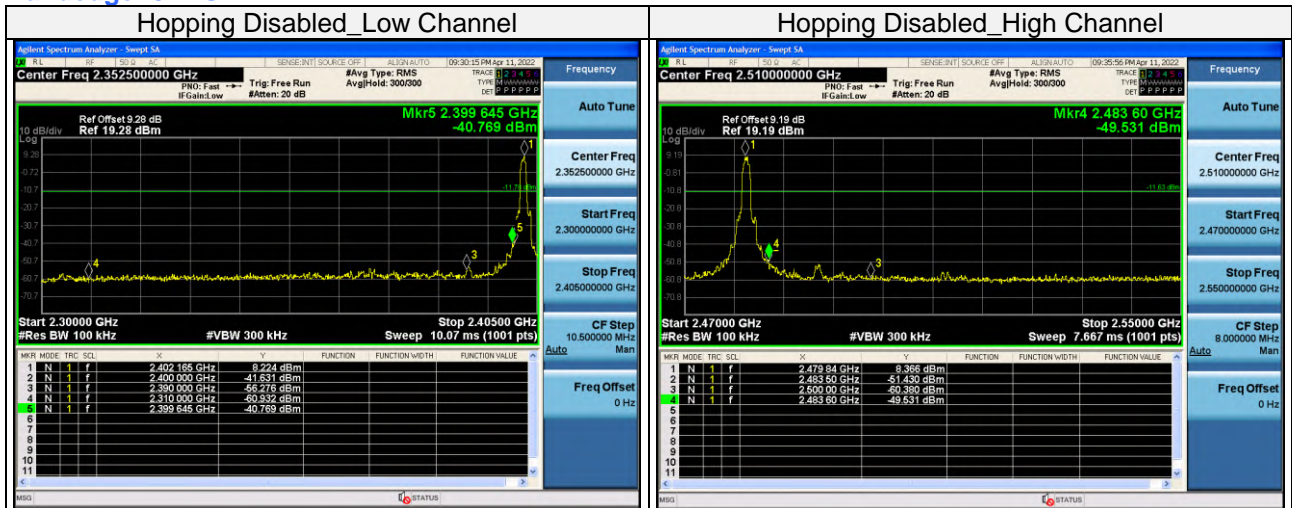



GFSK

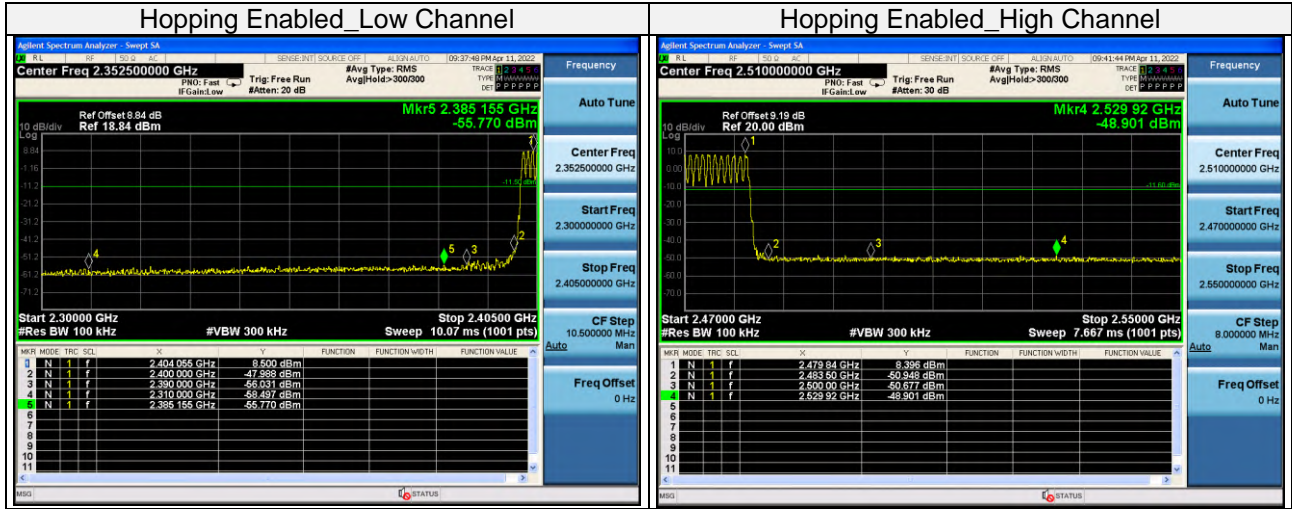

8DPSK

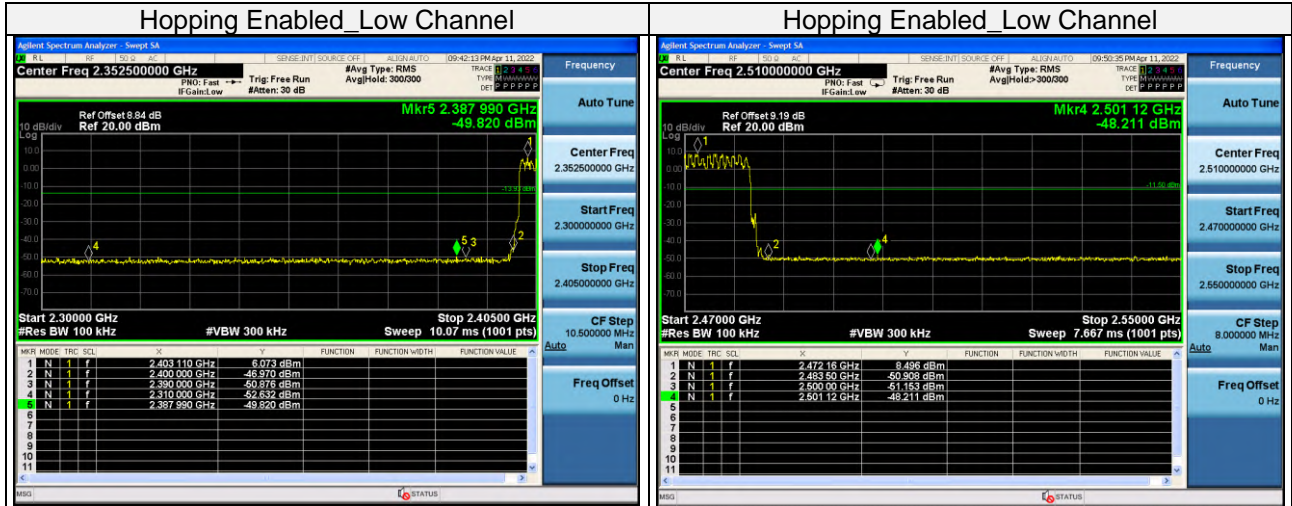



**HWA-HSING** Test Report No.: 220115KH01-RF-US-01

#### **4 Pictures of Test Arrangements**

Please refer to the attached file (Test Setup Photo).



**5 Test Instruments**

Description & Manufacturer	Model No.	Serial No.	Due Date of Calibration
Spectrum Keysight	N9020A	MY51240612	2022/09/12
Spectrum Analyzer Rohde&Schwarz	FSV-40N	101783	2022/09/12
Power Meter 10Hz~18GHz Tonscend	JS0806-2	188060126	2022/09/12
Signal generator Keysight	E4421B	GB40051020	2022/09/12
Signal generator Keysight	N5182A	MY47420944	2022/09/12
Test Software Tonscend	JS0806-2	NA	NA
Hygrothermograph Yuhuaze	HTC-1	NA	2022/09/12

Note:

1. The calibration interval of the above test instruments is 12 months and the calibrations are traceable to CEPREI/CHINA.
2. The test was performed in Chamber 1.



**HWA-HSING** Test Report No.: 220115KH01-RF-US-01

### **Appendix – Information on the Testing Laboratories**

We, [Hwa-Hsing \(Dongguan\) Co., Ltd.](#), A global provider of TESTING and CERTIFICATION services for consumer products, electronic products and wireless information technology products. Adhering to the core values “HONEST and TRUSTWORTHY, OBJECTIVE and IMPARTIALITY, RIGOROUS and AFFICIENT”, commitment to provide professional, perfect and efficient comprehensive ONE-STOP solution of TESTING and CERTIFICATION services for Manufacturers, Buyers, Traders, Brands, Retailers. Assist client to better manage risk, protect their brands, reduce costs and cut time to over 150 markets in global. Our laboratories are FCC recognized accredited test firms and accredited and approved according to ISO/IEC 17025.

If you have any comments, please feel free to contact us at the following:

Lab Address: [No.101, Bld N1, Yuyuan 2Rd, Yuyuan Industrial Park, HuangJiang Town, Dongguan, China](#)

Contact Tel: [0769-83078199](tel:0769-83078199)

Email: [Customerservice.dg@hwa-hsing.com](mailto:Customerservice.dg@hwa-hsing.com)

Web Site: [www.hwa-hsing.com](http://www.hwa-hsing.com)

The address and road map of all our labs can be found in our web site also.

--- END ---