

FCC Test Report

Report No.: RF140729D01A-3

FCC ID: WLQOMNISB1PLUSTX

Test Model: Omni SB1 Plus Soundbar

Received Date: Dec. 10, 2015

Test Date: Dec. 14 ~ 21, 2015

Issued Date: Dec. 22, 2015

Applicant: Polk Audio

Address: 5601 Metro Drive Baltimore Maryland 21215 United States

Issued By: Bureau Veritas Consumer Products Services (H.K.) Ltd., Taoyuan Branch

Lab Address: No. 47-2, 14th Ling, Chia Pau Vil., Lin Kou Dist., New Taipei City, Taiwan (R.O.C.)



This report is for your exclusive use. Any copying or replication of this report to or for any other person or entity, or use of our name or trademark, is permitted only with our prior written permission. This report sets forth our findings solely with respect to the test samples identified herein. The results set forth in this report are not indicative or representative of the quality or characteristics of the lot from which a test sample was taken or any similar or identical product unless specifically and expressly noted. Our report includes all of the tests requested by you and the results thereof based upon the information that you provided to us. You have 60 days from date of issuance of this report to notify us of any material error or omission caused by our negligence, provided, however, that such notice shall be in writing and shall specifically address the issue you wish to raise. A failure to raise such issue within the prescribed time shall constitute your unqualified acceptance of the completeness of this report, the tests conducted and the correctness of the report contents. Unless specific mention, the uncertainty of measurement has been explicitly taken into account to declare the compliance or non-compliance to the specification. The report must not be used by the client to claim product certification, approval, or endorsement by TAF or any government agencies.



Table of Contents

Release Control Record	4
1 Certificate of Conformity	5
2 Summary of Test Results	6
2.1 Measurement Uncertainty	6
2.2 Modification Record	6
3 General Information	7
3.1 General Description of EUT	7
3.2 Description of Test Modes	9
3.2.1 Test Mode Applicability and Tested Channel Detail	11
3.3 Duty Cycle of Test Signal	13
3.4 Description of Support Units	14
3.4.1 Configuration of System under Test	14
3.5 General Description of Applied Standard	14
4 Test Types and Results	15
4.1 Radiated Emission and Bandedge Measurement.....	15
4.1.1 Limits of Radiated Emission and Bandedge Measurement	15
4.1.2 Test Instruments	16
4.1.3 Test Procedure	17
4.1.4 Deviation from Test Standard	17
4.1.5 Test Setup.....	18
4.1.6 EUT Operating Condition	18
4.1.7 Test Results	19
4.2 Conducted Emission Measurement	55
4.2.1 Limits of Conducted Emission Measurement	55
4.2.2 Test Instruments	55
4.2.3 Test Procedure	56
4.2.4 Deviation from Test Standard	56
4.2.5 Test Setup.....	56
4.2.6 EUT Operating Condition	56
4.2.7 Test Results	57
4.3 Transmit Power Measurement	59
4.3.1 Limits of Transmit Power Measurement	59
4.3.2 Test Setup.....	59
4.3.3 Test Instruments	60
4.3.4 Test Procedure	60
4.3.5 Deviation from Test Standard	60
4.3.6 EUT Operating Condition	60
4.3.7 Test Result.....	61
4.4 Peak Power Spectral Density Measurement.....	69
4.4.1 Limits of Peak Power Spectral Density Measurement	69
4.4.2 Test Setup.....	69
4.4.3 Test Instruments	69
4.4.4 Test Procedure	69
4.4.5 Deviation from Test Standard	70
4.4.6 EUT Operating Condition	70
4.4.7 Test Results	71
4.5 Frequency Stability Measurement.....	75
4.5.1 Limits of Frequency Stability Measurement.....	75
4.5.2 Test Setup.....	75
4.5.3 Test Instruments	75
4.5.4 Test Procedure	75



4.5.5	Deviation from Test Standard	75
4.5.6	EUT Operating Condition	75
4.5.7	Test Results	76
4.6	6dB Bandwidth Measurement	77
4.6.1	Limits of 6dB Bandwidth Measurement	77
4.6.2	Test Setup	77
4.6.3	Test Instruments	77
4.6.4	Test Procedure	77
4.6.5	Deviation from Test Standard	77
4.6.6	EUT Operating Condition	77
4.6.7	Test Results	78
5	Pictures of Test Arrangements	80
	Appendix – Information on the Testing Laboratories	81



Release Control Record

Issue No.	Description	Date Issued
RF140729D01A-3	Original release.	Dec. 22, 2015

1 Certificate of Conformity

Product: Soundbar

Brand:



Test Model: Omni SB1 Plus Soundbar

Sample Status: Engineering sample

Applicant: Polk Audio

Test Date: Dec. 14 ~ 21, 2015

Standard: 47 CFR FCC Part 15, Subpart E (Section 15.407)
ANSI C63.10: 2013

The above equipment has been tested by **Bureau Veritas Consumer Products Services (H.K.) Ltd., Taoyuan Branch**, and found compliance with the requirement of the above standards. The test record, data evaluation & Equipment Under Test (EUT) configurations represented herein are true and accurate accounts of the measurements of the sample's EMC characteristics under the conditions specified in this report.

Prepared by :

Annie Chang

Date:

Dec. 22, 2015

Annie Chang / Senior Specialist

Approved by :

Rex Lai

Date:

Dec. 22, 2015

Rex Lai / Assistant Manager

2 Summary of Test Results

47 CFR FCC Part 15, Subpart E (SECTION 15.407)			
FCC Clause	Test Item	Result	Remarks
15.407(b)(6)	AC Power Conducted Emissions	PASS	Meet the requirement of limit. Minimum passing margin is -24.16dB at 0.15000MHz.
15.407(b)(1/2/3/4/6)	Radiated Emissions & Band Edge Measurement	PASS	Meet the requirement of limit. Minimum passing margin is -1.0dB at 208.53MHz.
15.407(a)(1/2/3)	Max Average Transmit Power	PASS	Meet the requirement of limit.
15.407(a)(1/2/3)	Peak Power Spectral Density	PASS	Meet the requirement of limit.
15.407(e)	6dB bandwidth	PASS	Meet the requirement of limit. (U-NII-3 Band only)
15.407(g)	Frequency Stability	PASS	Meet the requirement of limit.
15.203	Antenna Requirement	PASS	No antenna connector is used.

2.1 Measurement Uncertainty

Where relevant, the following measurement uncertainty levels have been estimated for tests performed on the EUT as specified in CISPR 16-4-2:

Measurement	Frequency	Expanded Uncertainty (k=2) (\pm)
Conducted Emissions at mains ports	150kHz ~ 30MHz	2.78 dB
Radiated Emissions up to 1 GHz	30MHz ~ 1000MHz	4.00 dB
Radiated Emissions above 1 GHz	1GHz ~ 40GHz	3.36 dB

2.2 Modification Record

There were no modifications required for compliance.

3 General Information

3.1 General Description of EUT

Product	Soundbar
Brand	
Test Model	Omni SB1 Plus Soundbar
Status of EUT	Engineering sample
Power Supply Rating	24Vdc from AC Adapter
Modulation Type	64QAM, 16QAM, QPSK, BPSK
Modulation Technology	OFDM
Transfer Rate	802.11a: 54.0/ 48.0/ 36.0/ 24.0/ 18.0/ 12.0/ 9.0/ 6.0Mbps 802.11n: up to 150.0Mbps
Operating Frequency	5180 ~ 5240MHz, 5260 ~ 5320MHz, 5500 ~ 5700MHz 5745 ~ 5825MHz
Number of Channel	5180 ~ 5240MHz: 4 for 802.11a, 802.11n (20MHz) 2 for 802.11n (40MHz) 5260 ~ 5320MHz: 4 for 802.11a, 802.11n (20MHz) 2 for 802.11n (40MHz) 5500 ~ 5700MHz 8 for 802.11a, 802.11n (20MHz) 3 for 802.11n (40MHz) 5745 ~ 5825MHz: 5 for 802.11a, 802.11n (20MHz) 2 for 802.11n (40MHz)
Output Power	5180 ~ 5240MHz: 22.0mW 5260 ~ 5320MHz: 20.4mW 5500 ~ 5700MHz: 20.1mW 5745 ~ 5825MHz: 20.8mW
Antenna Type	PIFA antenna with 2.04dBi gain
Antenna Connector	N/A
Accessory Device	Adapter
Data Cable Supplied	N/A

Note:

1. The EUT incorporates a SISO function. Physically, the EUT provides one completed transmitter and one receiver.

Modulation Mode	TX FUNCTION
802.11a	1TX
802.11n (20MHz)	1TX
802.11n (40MHz)	1TX

2. The EUT consumes power from an AC adapter as follows:

Brand	Model No.	Spec.
polk	DYS602-240250W	AC I/P: 100-240Vac, 50/60Hz, 1.5A Max. DC O/P: 24Vdc, 2.5A Non-shielded AC cable (1.8m) 2 Pin Non-shielded DC cable with one core (1.8m)

3. The above EUT information is declared by manufacturer and for more detailed features description, please refer to the manufacturer's specifications or user's manual.

3.2 Description of Test Modes

FOR 5180 ~ 5240MHz

4 channels are provided for 802.11a, 802.11n (20MHz):

Channel	Frequency	Channel	Frequency
36	5180 MHz	44	5220 MHz
40	5200 MHz	48	5240 MHz

2 channels are provided for 802.11n (40MHz):

Channel	Frequency	Channel	Frequency
38	5190 MHz	46	5230 MHz

FOR 5260 ~ 5320MHz

4 channels are provided for 802.11a, 802.11n (20MHz)

CHANNEL	FREQUENCY	CHANNEL	FREQUENCY
52	5260 MHz	60	5300 MHz
56	5280 MHz	64	5320 MHz

2 channels are provided for 802.11n (40MHz)

CHANNEL	FREQUENCY	CHANNEL	FREQUENCY
54	5270 MHz	62	5310 MHz

FOR 5500 ~ 5700MHz

8 channels are provided for 802.11a, 802.11n (20MHz)

CHANNEL	FREQUENCY	CHANNEL	FREQUENCY
100	5500 MHz	116	5580 MHz
104	5520 MHz	132	5660 MHz
108	5540 MHz	136	5680 MHz
112	5560 MHz	140	5700 MHz

3 channels are provided for 802.11n (40MHz)

CHANNEL	FREQUENCY	CHANNEL	FREQUENCY
102	5510 MHz	134	5670 MHz
110	5550 MHz		

FOR 5745 ~ 5825MHz:

5 channels are provided for 802.11a, 802.11n (20MHz):

Channel	Frequency	Channel	Frequency
149	5745MHz	161	5805MHz
153	5765MHz	165	5825MHz
157	5785MHz		

2 channels are provided for 802.11n (40MHz):

Channel	Frequency	Channel	Frequency
151	5755MHz	159	5795MHz

3.2.1 Test Mode Applicability and Tested Channel Detail

EUT CONFIGURE MODE	APPLICABLE TO				DESCRIPTION
	RE≥1G	RE<1G	PLC	APCM	
-	√	√	√	√	-

Where **RE≥1G**: Radiated Emission above 1GHz **RE<1G**: Radiated Emission below 1GHz
PLC: Power Line Conducted Emission **APCM**: Antenna Port Conducted Measurement

Radiated Emission Test (Above 1GHz):

- Pre-Scan has been conducted to determine the worst-case mode from all possible combinations between available modulations, data rates and antenna ports (if EUT with antenna diversity architecture).
- Following channel(s) was (were) selected for the final test as listed below.

EUT CONFIGURE MODE	MODE	FREQ. BAND (MHz)	AVAILABLE CHANNEL	TESTED CHANNEL	MODULATION TECHNOLOGY	MODULATION TYPE	DATA RATE (Mbps)
-	802.11a	5180-5240	36 to 48	36, 40, 48	OFDM	BPSK	6.0
-	802.11n (20MHz)		36 to 48	36, 40, 48	OFDM	BPSK	6.5
-	802.11n (40MHz)		38 to 46	38, 46	OFDM	BPSK	13.5
-	802.11a	5260-5320	52 to 64	52, 60, 64	OFDM	BPSK	6.0
-	802.11n (20MHz)		52 to 64	52, 60, 64	OFDM	BPSK	6.5
-	802.11n (40MHz)		54 to 62	54, 62	OFDM	BPSK	13.5
-	802.11a	5500-5700	100 to 140	100, 116, 132, 140	OFDM	BPSK	6.0
-	802.11n (20MHz)		100 to 140	100, 116, 132, 140	OFDM	BPSK	6.5
-	802.11n (40MHz)		102 to 134	102, 110, 134	OFDM	BPSK	13.5
-	802.11a	5745-5825	149 to 165	149, 157, 165	OFDM	BPSK	6.0
-	802.11n (20MHz)		149 to 165	149, 157, 165	OFDM	BPSK	6.5
-	802.11n (40MHz)		151 to 159	151, 159	OFDM	BPSK	13.5

Radiated Emission Test (Below 1GHz):

- Pre-Scan has been conducted to determine the worst-case mode from all possible combinations between available modulations, data rates and antenna ports (if EUT with antenna diversity architecture).
- Following channel(s) was (were) selected for the final test as listed below.

EUT CONFIGURE MODE	MODE	FREQ. BAND (MHz)	AVAILABLE CHANNEL	TESTED CHANNEL	MODULATION TECHNOLOGY	MODULATION TYPE	DATA RATE (Mbps)
-	802.11a	5180-5320	36 to 64	36	OFDM	BPSK	6.0
-	802.11a	5500-5825	100 to 165		OFDM	BPSK	6.0

Power Line Conducted Emission Test:

- Pre-Scan has been conducted to determine the worst-case mode from all possible combinations between available modulations, data rates and antenna ports (if EUT with antenna diversity architecture).
- Following channel(s) was (were) selected for the final test as listed below.

EUT CONFIGURE MODE	MODE	FREQ. BAND (MHz)	AVAILABLE CHANNEL	TESTED CHANNEL	MODULATION TECHNOLOGY	MODULATION TYPE	DATA RATE (Mbps)
-	802.11a	5180-5320	36 to 64	36	OFDM	BPSK	6.0
-	802.11a	5500-5825	100 to 165		OFDM	BPSK	6.0

Antenna Port Conducted Measurement:

- This item includes all test value of each mode, but only includes spectrum plot of worst value of each mode.
- Pre-Scan has been conducted to determine the worst-case mode from all possible combinations between available modulations, data rates and antenna ports (if EUT with antenna diversity architecture).
- Following channel(s) was (were) selected for the final test as listed below.

EUT CONFIGURE MODE	MODE	FREQ. BAND (MHz)	AVAILABLE CHANNEL	TESTED CHANNEL	MODULATION TECHNOLOGY	MODULATION TYPE	DATA RATE (Mbps)
-	802.11a	5180-5240	36 to 48	36, 40, 48	OFDM	BPSK	6.0
-	802.11n (20MHz)		36 to 48	36, 40, 48	OFDM	BPSK	6.5
-	802.11n (40MHz)		38 to 46	38, 46	OFDM	BPSK	13.5
-	802.11a	5260-5320	52 to 64	52, 60, 64	OFDM	BPSK	6.0
-	802.11n (20MHz)		52 to 64	52, 60, 64	OFDM	BPSK	6.5
-	802.11n (40MHz)		54 to 62	54, 62	OFDM	BPSK	13.5
-	802.11a	5500-5700	100 to 140	100, 116, 140	OFDM	BPSK	6.0
-	802.11n (20MHz)		100 to 140	100, 116, 140	OFDM	BPSK	6.5
-	802.11n (40MHz)		102 to 134	102, 110, 134	OFDM	BPSK	13.5
-	802.11a	5745-5825	149 to 165	149, 157, 165	OFDM	BPSK	6.0
-	802.11n (20MHz)		149 to 165	149, 157, 165	OFDM	BPSK	6.5
-	802.11n (40MHz)		151 to 159	151, 159	OFDM	BPSK	13.5

Test Condition:

APPLICABLE TO	ENVIRONMENTAL CONDITIONS	INPUT POWER	TESTED BY
RE≥1G	28deg. C, 69% RH	120Vac, 60Hz	Aaron You
RE<1G	28deg. C, 69% RH	120Vac, 60Hz	Aaron You
PLC	25deg. C, 73% RH	120Vac, 60Hz	Dalen Dai
APCM	25deg. C, 73% RH	120Vac, 60Hz	Saxon Lee

3.3 Duty Cycle of Test Signal

Duty cycle of test signal is 100 %



3.4 Description of Support Units

The EUT has been tested as an independent unit together with AC adapter.

3.4.1 Configuration of System under Test

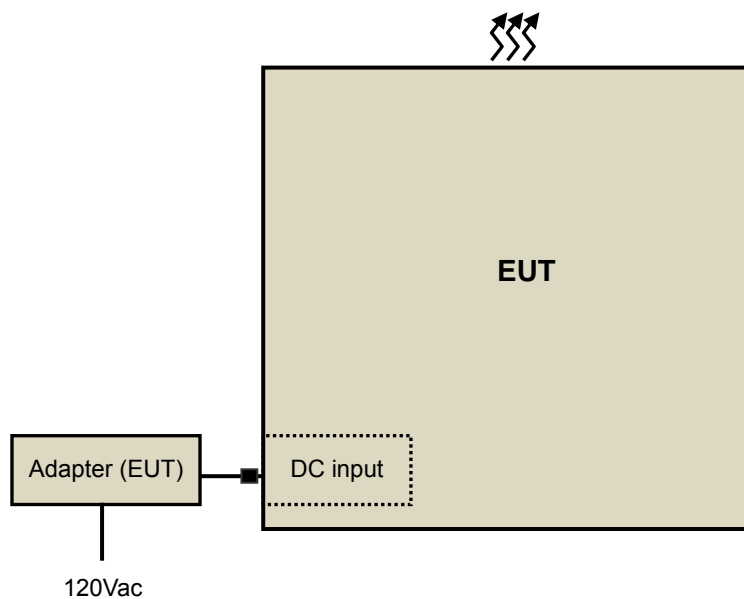

3.5 General Description of Applied Standard

The EUT is a RF Product. According to the specifications of the manufacturer, it must comply with the requirements of the following standards:

FCC Part 15, Subpart E (15.407)
789033 D02 General UNII Test Procedure New Rules v01r02
ANSI C63.10-2013

All test items have been performed and recorded as per the above standards.

4 Test Types and Results

4.1 Radiated Emission and Bandedge Measurement

4.1.1 Limits of Radiated Emission and Bandedge Measurement

Radiated emissions which fall in the restricted bands must comply with the radiated emission limits specified as below table.

Frequencies (MHz)	Field Strength (microvolts/meter)	Measurement Distance (meters)
0.009 ~ 0.490	2400/F(kHz)	300
0.490 ~ 1.705	24000/F(kHz)	30
1.705 ~ 30.0	30	30
30 ~ 88	100	3
88 ~ 216	150	3
216 ~ 960	200	3
Above 960	500	3

NOTE:

1. The lower limit shall apply at the transition frequencies.
2. Emission level (dBuV/m) = 20 log Emission level (uV/m).
3. For frequencies above 1000MHz, the field strength limits are based on average detector, however, the peak field strength of any emission shall not exceed the maximum permitted average limits, specified above by more than 20dB under any condition of modulation.

LIMITS OF UNWANTED EMISSION OUT OF THE RESTRICTED BANDS

APPLICABLE TO	LIMIT	
789033 D02 General UNII Test Procedure New Rules v01	FIELD STRENGTH AT 3m	
	PK:74 (dBμV/m)	AV:54 (dBμV/m)
APPLICABLE TO	EIRP LIMIT	EQUIVALENT FIELD STRENGTH AT 3m
15.407(b)(1)	PK:-27 (dBm/MHz)	PK:68.2(dBμV/m)
15.407(b)(2)		
15.407(b)(3)		
15.407(b)(4)	PK:-27 (dBm/MHz) ^{*1} PK:-17 (dBm/MHz) ^{*2}	PK: 68.2(dBμV/m) ^{*1} PK:78.2 (dBμV/m) ^{*2}

NOTE: ^{*1} beyond 10MHz of the band edge ^{*2} within 10 MHz of band edge

The following formula is used to convert the equipment isotropic radiated power (eirp) to field strength:

$$E = \frac{1000000\sqrt{30P}}{3} \quad \mu\text{V/m, where P is the eirp (Watts).$$



4.1.2 Test Instruments

DESCRIPTION & MANUFACTURER	MODEL NO.	SERIAL NO.	CALIBRATED DATE	CALIBRATED UNTIL
HP Preamplifier	8447D	2432A03504	Feb. 26, 2015	Feb. 25, 2016
HP Preamplifier	8449B	3008A01201	Feb. 26, 2015	Feb. 25, 2016
MITEQ Preamplifier	AMF-6F-260400-33-8P	892164	Mar. 01, 2015	Feb. 28, 2016
Agilent TEST RECEIVER	N9038A	MY51210129	Jan. 20, 2015	Jan. 19, 2016
Schwarzbeck Antenna	VULB 9168	139	Feb. 04, 2015	Feb. 03, 2016
Schwarzbeck Antenna	VHBA 9123	480	May 29, 2015	May 28, 2017
Schwarzbeck Horn Antenna	BBHA-9170	212	Feb. 09, 2015	Feb. 08, 2016
Schwarzbeck Horn Antenna	BBHA 9120-D1	D130	Feb. 10, 2015	Feb. 09, 2016
ADT. Turn Table	TT100	0306	NA	NA
ADT. Tower	AT100	0306	NA	NA
Software	Radiated_V7.6.15.9.4	NA	NA	NA
SUHNER RF cable With 4dB PAD	SF104	CABLE-CH6	Aug. 15, 2015	Aug. 14, 2016
SUHNER RF cable With 3dB PAD	SF102	Cable-CH8-3.6m	Aug. 15, 2015	Aug. 14, 2016
EMCO Horn Antenna	3115	00028257	Feb. 05, 2015	Feb. 04, 2016
Highpass filter Wainwright Instruments	WHK 3.1/18G-10SS	SN 8	NA	NA
ROHDE & SCHWARZ Spectrum Analyzer	FSV40	101042	Sep. 23, 2015	Sep. 22, 2016
Anritsu Power Sensor	MA2411B	0738404	Apr. 21, 2015	Apr. 20, 2016
Anritsu Power Meter	ML2495A	0842014	Apr. 21, 2015	Apr. 20, 2016

- NOTE:** 1. The calibration interval of the above test instruments is 12/24 months. And the calibrations are traceable to NML/ROC and NIST/USA.
2. The horn antenna and HP preamplifier (model: 8449B) are used only for the measurement of emission frequency above 1GHz if tested.
3. The test was performed in Chamber No. 6.
4. The Industry Canada Reference No. IC 7450E-6.
5. The FCC Site Registration No. is 447212.

4.1.3 Test Procedure

- a. The EUT was placed on the top of a rotating table 0.8 meters (for below 1GHz) / 1.5 meters (for above 1GHz) above the ground at 3 meter chamber room for test. The table was rotated 360 degrees to determine the position of the highest radiation.
- b. The EUT was set 3 meters away from the interference-receiving antenna, which was mounted on the top of a variable-height antenna tower.
- c. The height of antenna is varied from one meter to four meters above the ground to determine the maximum value of the field strength. Both horizontal and vertical polarizations of the antenna are set to make the measurement.
- d. For each suspected emission, the EUT was arranged to its worst case and then the antenna was tuned to heights from 1 meter to 4 meters and the rotatable table was turned from 0 degrees to 360 degrees to find the maximum reading.
- e. The test-receiver system was set to quasi-peak detect function and specified bandwidth with maximum hold mode when the test frequency is below 1 GHz.
- f. The test-receiver system was set to peak and average detect function and specified bandwidth with maximum hold mode when the test frequency is above 1 GHz. If the peak reading value also meets average limit, measurement with the average detector is unnecessary.

Note:

1. The resolution bandwidth and video bandwidth of test receiver/spectrum analyzer is 120kHz for Quasi-peak detection (QP) at frequency below 1GHz.
2. The resolution bandwidth of test receiver/spectrum analyzer is 1 MHz and the video bandwidth is 3 MHz for Peak detection (PK) at frequency above 1GHz.
3. The resolution bandwidth of test receiver/spectrum analyzer is 1MHz and the video bandwidth is 3MHz for RMS Average (Duty cycle < 98%) for Average detection (AV) at frequency above 1GHz, then the measurement results was added to a correction factor ($10 \log(1/\text{duty cycle})$).
4. The resolution bandwidth of test receiver/spectrum analyzer is 1MHz and the video bandwidth is 10Hz (Duty cycle $\geq 98\%$) for Average detection (AV) at frequency above 1GHz.
5. All modes of operation were investigated and the worst-case emissions are reported.

4.1.4 Deviation from Test Standard

No deviation.

4.1.5 Test Setup

<Frequency Range below 1GHz>

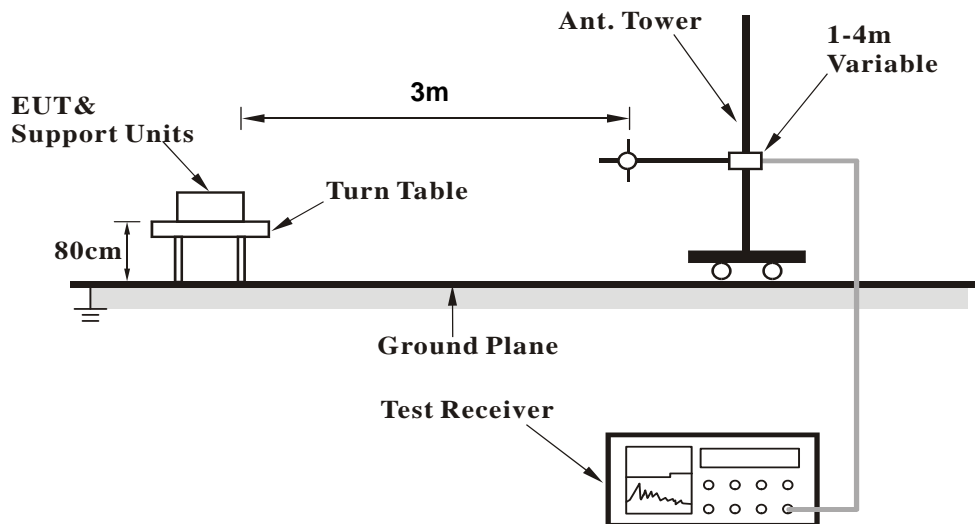

<Frequency Range above 1GHz>

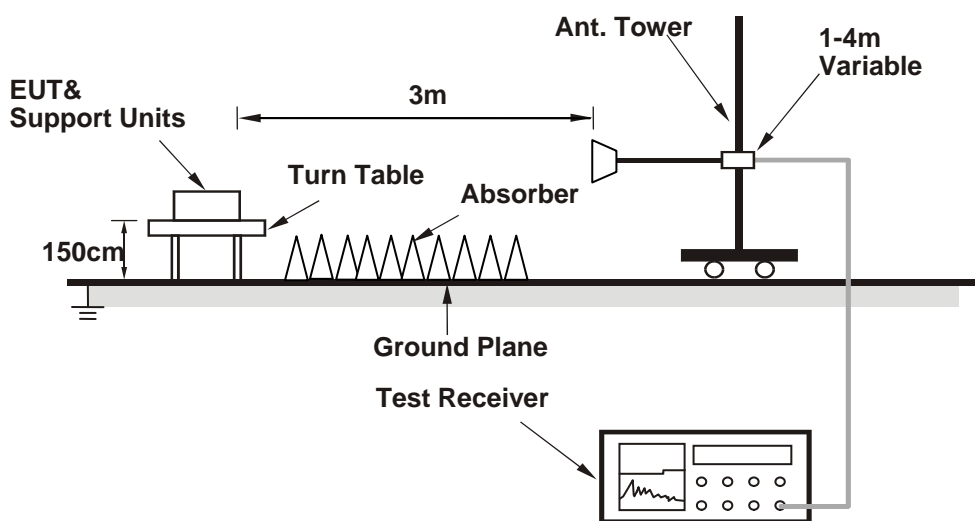

For the actual test configuration, please refer to the attached file (Test Setup Photo).

4.1.6 EUT Operating Condition

- a. Turn on the power of all equipment.
- b. Set the EUT under transmitting condition.



4.1.7 Test Results

ABOVE 1GHz DATA

802.11a

CHANNEL	TX Channel 36	DETECTOR FUNCTION	Peak (PK)
FREQUENCY RANGE	1GHz ~ 40GHz		Average (AV)

ANTENNA POLARITY & TEST DISTANCE: HORIZONTAL AT 3 M								
NO.	FREQ. (MHz)	EMISSION LEVEL (dBuV/m)	LIMIT (dBuV/m)	MARGIN (dB)	ANTENNA HEIGHT (m)	TABLE ANGLE (Degree)	RAW VALUE (dBuV)	CORRECTION FACTOR (dB/m)
1	5150.00	63.6 PK	74.0	-10.4	1.02 H	210	57.82	5.82
2	5150.00	49.5 AV	54.0	-4.5	1.02 H	210	43.71	5.82
3	*5180.00	107.7 PK			1.02 H	210	101.97	5.75
4	*5180.00	98.2 AV			1.02 H	210	92.43	5.75
5	#10360.00	57.9 PK	74.0	-16.1	1.00 H	154	45.21	12.69
6	#10360.00	45.4 AV	54.0	-8.6	1.00 H	154	32.73	12.69
ANTENNA POLARITY & TEST DISTANCE: VERTICAL AT 3 M								
NO.	FREQ. (MHz)	EMISSION LEVEL (dBuV/m)	LIMIT (dBuV/m)	MARGIN (dB)	ANTENNA HEIGHT (m)	TABLE ANGLE (Degree)	RAW VALUE (dBuV)	CORRECTION FACTOR (dB/m)
1	5150.00	58.6 PK	74.0	-15.4	1.24 V	213	52.74	5.82
2	5150.00	46.4 AV	54.0	-7.6	1.24 V	213	40.57	5.82
3	*5180.00	99.6 PK			1.24 V	213	93.86	5.75
4	*5180.00	90.1 AV			1.24 V	213	84.33	5.75
5	#10360.00	55.0 PK	74.0	-19.1	1.13 V	231	42.26	12.69
6	#10360.00	42.9 AV	54.0	-11.1	1.13 V	231	30.17	12.69

REMARKS:

1. Emission Level(dBuV/m) = Raw Value(dBuV) + Correction Factor(dB/m)
2. Correction Factor(dB/m) = Antenna Factor(dB/m) + Cable Factor(dB) – Pre-Amplifier Factor(dB)
3. The other emission levels were very low against the limit.
4. Margin value = Emission Level – Limit value
5. " * ": Fundamental frequency.
6. " # ": The radiated frequency is out of the restricted band.



CHANNEL	TX Channel 40	DETECTOR FUNCTION	Peak (PK)
FREQUENCY RANGE	1GHz ~ 40GHz		Average (AV)

ANTENNA POLARITY & TEST DISTANCE: HORIZONTAL AT 3 M

NO.	FREQ. (MHz)	EMISSION LEVEL (dBuV/m)	LIMIT (dBuV/m)	MARGIN (dB)	ANTENNA HEIGHT (m)	TABLE ANGLE (Degree)	RAW VALUE (dBuV)	CORRECTION FACTOR (dB/m)
1	*5200.00	105.1 PK			1.01 H	213	99.38	5.70
2	*5200.00	95.4 AV			1.01 H	213	89.68	5.70
3	#10400.00	58.3 PK	74.0	-15.7	1.19 H	197	45.77	12.55
4	#10400.00	45.1 AV	54.0	-8.9	1.19 H	197	32.54	12.55

ANTENNA POLARITY & TEST DISTANCE: VERTICAL AT 3 M

NO.	FREQ. (MHz)	EMISSION LEVEL (dBuV/m)	LIMIT (dBuV/m)	MARGIN (dB)	ANTENNA HEIGHT (m)	TABLE ANGLE (Degree)	RAW VALUE (dBuV)	CORRECTION FACTOR (dB/m)
1	*5200.00	98.1 PK			1.20 V	210	92.38	5.70
2	*5200.00	88.2 AV			1.20 V	210	82.46	5.70
3	#10400.00	55.5 PK	74.0	-18.5	1.08 V	254	42.93	12.55
4	#10400.00	42.7 AV	54.0	-11.3	1.08 V	254	30.19	12.55

REMARKS:

- Emission Level(dBuV/m) = Raw Value(dBuV) + Correction Factor(dB/m)
- Correction Factor(dB/m) = Antenna Factor(dB/m) + Cable Factor(dB) – Pre-Amplifier Factor(dB)
- The other emission levels were very low against the limit.
- Margin value = Emission Level – Limit value
- " * ": Fundamental frequency.
- " # ": The radiated frequency is out of the restricted band.



CHANNEL	TX Channel 48	DETECTOR FUNCTION	Peak (PK)
FREQUENCY RANGE	1GHz ~ 40GHz		Average (AV)

ANTENNA POLARITY & TEST DISTANCE: HORIZONTAL AT 3 M								
NO.	FREQ. (MHz)	EMISSION LEVEL (dBuV/m)	LIMIT (dBuV/m)	MARGIN (dB)	ANTENNA HEIGHT (m)	TABLE ANGLE (Degree)	RAW VALUE (dBuV)	CORRECTION FACTOR (dB/m)
1	*5240.00	106.1 PK			1.01 H	211	100.24	5.86
2	*5240.00	96.4 AV			1.01 H	211	90.52	5.86
3	5350.00	60.6 PK	74.0	-13.4	1.01 H	211	54.35	6.28
4	5350.00	48.8 AV	54.0	-5.2	1.01 H	211	42.54	6.28
5	#10480.00	57.8 PK	74.0	-16.2	1.08 H	284	44.73	13.09
6	#10480.00	46.1 AV	54.0	-7.9	1.08 H	284	33.01	13.09
ANTENNA POLARITY & TEST DISTANCE: VERTICAL AT 3 M								
NO.	FREQ. (MHz)	EMISSION LEVEL (dBuV/m)	LIMIT (dBuV/m)	MARGIN (dB)	ANTENNA HEIGHT (m)	TABLE ANGLE (Degree)	RAW VALUE (dBuV)	CORRECTION FACTOR (dB/m)
1	*5240.00	99.8 PK			1.43 V	360	93.96	5.86
2	*5240.00	90.0 AV			1.43 V	360	84.17	5.86
3	5350.00	59.6 PK	74.0	-14.4	1.43 V	252	53.35	6.28
4	5350.00	46.3 AV	54.0	-7.7	1.43 V	252	39.99	6.28
5	#10480.00	56.2 PK	74.0	-17.8	1.00 V	301	43.08	13.09
6	#10480.00	44.5 AV	54.0	-9.5	1.00 V	301	31.44	13.09

REMARKS:

1. Emission Level(dBuV/m) = Raw Value(dBuV) + Correction Factor(dB/m)
2. Correction Factor(dB/m) = Antenna Factor(dB/m) + Cable Factor(dB) – Pre-Amplifier Factor(dB)
3. The other emission levels were very low against the limit.
4. Margin value = Emission Level – Limit value
5. " * ": Fundamental frequency.
6. " # ": The radiated frequency is out of the restricted band.



CHANNEL	TX Channel 52	DETECTOR FUNCTION	Peak (PK)
FREQUENCY RANGE	1GHz ~ 40GHz		Average (AV)

ANTENNA POLARITY & TEST DISTANCE: HORIZONTAL AT 3 M								
NO.	FREQ. (MHz)	EMISSION LEVEL (dBuV/m)	LIMIT (dBuV/m)	MARGIN (dB)	ANTENNA HEIGHT (m)	TABLE ANGLE (Degree)	RAW VALUE (dBuV)	CORRECTION FACTOR (dB/m)
1	5150.00	61.6 PK	74.0	-12.5	1.00 H	212	55.73	5.82
2	5150.00	47.2 AV	54.0	-6.8	1.00 H	212	41.34	5.82
3	*5260.00	106.1 PK			1.00 H	212	100.13	5.92
4	*5260.00	95.9 AV			1.00 H	212	89.97	5.92
5	#10520.00	57.2 PK	74.0	-16.8	1.00 H	332	43.96	13.27
6	#10520.00	46.5 AV	54.0	-7.5	1.00 H	332	33.27	13.27
ANTENNA POLARITY & TEST DISTANCE: VERTICAL AT 3 M								
NO.	FREQ. (MHz)	EMISSION LEVEL (dBuV/m)	LIMIT (dBuV/m)	MARGIN (dB)	ANTENNA HEIGHT (m)	TABLE ANGLE (Degree)	RAW VALUE (dBuV)	CORRECTION FACTOR (dB/m)
1	5150.00	59.3 PK	74.0	-14.7	1.00 V	211	53.52	5.82
2	5150.00	45.7 AV	54.0	-8.3	1.00 V	211	39.92	5.82
3	*5260.00	97.2 PK			1.00 V	211	91.27	5.92
4	*5260.00	87.8 AV			1.00 V	211	81.83	5.92
5	#10520.00	55.9 PK	74.0	-18.2	1.03 V	163	42.58	13.27
6	#10520.00	45.2 AV	54.0	-8.8	1.03 V	163	31.94	13.27

REMARKS:

- Emission Level(dBuV/m) = Raw Value(dBuV) + Correction Factor(dB/m)
- Correction Factor(dB/m) = Antenna Factor(dB/m) + Cable Factor(dB) – Pre-Amplifier Factor(dB)
- The other emission levels were very low against the limit.
- Margin value = Emission Level – Limit value
- " * ": Fundamental frequency.
- " # ": The radiated frequency is out of the restricted band.



CHANNEL	TX Channel 60	DETECTOR FUNCTION	Peak (PK)
FREQUENCY RANGE	1GHz ~ 40GHz		Average (AV)

ANTENNA POLARITY & TEST DISTANCE: HORIZONTAL AT 3 M

NO.	FREQ. (MHz)	EMISSION LEVEL (dBuV/m)	LIMIT (dBuV/m)	MARGIN (dB)	ANTENNA HEIGHT (m)	TABLE ANGLE (Degree)	RAW VALUE (dBuV)	CORRECTION FACTOR (dB/m)
1	*5300.00	105.8 PK			1.04 H	209	99.72	6.08
2	*5300.00	96.2 AV			1.04 H	209	90.08	6.08
3	10600.00	57.4 PK	74.0	-16.6	1.24 H	89	43.96	13.47
4	10600.00	45.6 AV	54.0	-8.4	1.24 H	89	32.17	13.47

ANTENNA POLARITY & TEST DISTANCE: VERTICAL AT 3 M

NO.	FREQ. (MHz)	EMISSION LEVEL (dBuV/m)	LIMIT (dBuV/m)	MARGIN (dB)	ANTENNA HEIGHT (m)	TABLE ANGLE (Degree)	RAW VALUE (dBuV)	CORRECTION FACTOR (dB/m)
1	*5300.00	97.3 PK			1.10 V	212	91.23	6.08
2	*5300.00	87.9 AV			1.10 V	212	81.81	6.08
3	10600.00	55.6 PK	74.0	-18.4	1.00 V	341	42.13	13.47
4	10600.00	44.4 AV	54.0	-9.6	1.00 V	341	30.92	13.47

REMARKS:

1. Emission Level(dBuV/m) = Raw Value(dBuV) + Correction Factor(dB/m)
2. Correction Factor(dB/m) = Antenna Factor(dB/m) + Cable Factor(dB) – Pre-Amplifier Factor(dB)
3. The other emission levels were very low against the limit.
4. Margin value = Emission Level – Limit value
5. " * " : Fundamental frequency.



CHANNEL	TX Channel 64	DETECTOR FUNCTION	Peak (PK)
FREQUENCY RANGE	1GHz ~ 40GHz		Average (AV)

ANTENNA POLARITY & TEST DISTANCE: HORIZONTAL AT 3 M

NO.	FREQ. (MHz)	EMISSION LEVEL (dBuV/m)	LIMIT (dBuV/m)	MARGIN (dB)	ANTENNA HEIGHT (m)	TABLE ANGLE (Degree)	RAW VALUE (dBuV)	CORRECTION FACTOR (dB/m)
1	*5320.00	106.3 PK			1.00 H	210	100.12	6.16
2	*5320.00	96.5 AV			1.00 H	210	90.32	6.16
3	5350.00	62.0 PK	74.0	-12.0	1.00 H	210	55.74	6.28
4	5350.00	47.6 AV	54.0	-6.4	1.00 H	210	41.33	6.28
5	10640.00	58.8 PK	74.0	-15.2	1.29 H	332	45.23	13.60
6	10640.00	46.7 AV	54.0	-7.3	1.29 H	332	33.07	13.60

ANTENNA POLARITY & TEST DISTANCE: VERTICAL AT 3 M

NO.	FREQ. (MHz)	EMISSION LEVEL (dBuV/m)	LIMIT (dBuV/m)	MARGIN (dB)	ANTENNA HEIGHT (m)	TABLE ANGLE (Degree)	RAW VALUE (dBuV)	CORRECTION FACTOR (dB/m)
1	*5320.00	98.3 PK			1.22 V	201	92.12	6.16
2	*5320.00	88.7 AV			1.22 V	201	82.51	6.16
3	5350.00	57.7 PK	74.0	-16.3	1.22 V	201	51.43	6.28
4	5350.00	45.3 AV	54.0	-8.7	1.22 V	201	38.98	6.28
5	10640.00	56.0 PK	74.0	-18.0	1.03 V	297	42.37	13.60
6	10640.00	43.8 AV	54.0	-10.2	1.03 V	297	30.21	13.60

REMARKS:

1. Emission Level(dBuV/m) = Raw Value(dBuV) + Correction Factor(dB/m)
2. Correction Factor(dB/m) = Antenna Factor(dB/m) + Cable Factor(dB) – Pre-Amplifier Factor(dB)
3. The other emission levels were very low against the limit.
4. Margin value = Emission Level – Limit value
5. " * ": Fundamental frequency.



CHANNEL	TX Channel 100	DETECTOR FUNCTION	Peak (PK)
FREQUENCY RANGE	1GHz ~ 40GHz		Average (AV)

ANTENNA POLARITY & TEST DISTANCE: HORIZONTAL AT 3 M

NO.	FREQ. (MHz)	EMISSION LEVEL (dBuV/m)	LIMIT (dBuV/m)	MARGIN (dB)	ANTENNA HEIGHT (m)	TABLE ANGLE (Degree)	RAW VALUE (dBuV)	CORRECTION FACTOR (dB/m)
1	5460.00	60.6 PK	74.0	-13.4	1.19 H	221	53.98	6.63
2	5460.00	46.8 AV	54.0	-7.2	1.19 H	221	40.13	6.63
3	#5470.00	50.9 PK	74.0	-23.1	1.19 H	221	44.26	6.66
4	#5470.00	48.5 AV	54.0	-5.5	1.19 H	221	41.87	6.66
5	*5500.00	104.2 PK			1.19 H	221	97.48	6.74
6	*5500.00	94.7 AV			1.19 H	221	87.94	6.74
7	11000.00	57.9 PK	74.0	-16.1	1.07 H	203	44.32	13.54
8	11000.00	46.1 AV	54.0	-7.9	1.07 H	203	32.54	13.54

ANTENNA POLARITY & TEST DISTANCE: VERTICAL AT 3 M

NO.	FREQ. (MHz)	EMISSION LEVEL (dBuV/m)	LIMIT (dBuV/m)	MARGIN (dB)	ANTENNA HEIGHT (m)	TABLE ANGLE (Degree)	RAW VALUE (dBuV)	CORRECTION FACTOR (dB/m)
1	5460.00	57.1 PK	74.0	-16.9	1.10 V	249	50.48	6.63
2	5460.00	45.6 AV	54.0	-8.4	1.10 V	249	38.97	6.63
3	#5470.00	57.7 PK	74.0	-16.4	1.10 V	249	50.99	6.66
4	#5470.00	46.6 AV	54.0	-7.5	1.10 V	249	39.89	6.66
5	*5500.00	101.6 PK			1.10 V	249	94.81	6.74
6	*5500.00	91.8 AV			1.10 V	249	85.05	6.74
7	11000.00	55.9 PK	74.0	-18.1	1.00 V	173	42.36	13.54
8	11000.00	44.7 AV	54.0	-9.3	1.00 V	173	31.17	13.54

REMARKS:

- Emission Level(dBuV/m) = Raw Value(dBuV) + Correction Factor(dB/m)
- Correction Factor(dB/m) = Antenna Factor(dB/m) + Cable Factor(dB) – Pre-Amplifier Factor(dB)
- The other emission levels were very low against the limit.
- Margin value = Emission Level – Limit value
- " * ": Fundamental frequency.
- " # ": The radiated frequency is out of the restricted band.



CHANNEL	TX Channel 116	DETECTOR FUNCTION	Peak (PK)
FREQUENCY RANGE	1GHz ~ 40GHz		Average (AV)

ANTENNA POLARITY & TEST DISTANCE: HORIZONTAL AT 3 M

NO.	FREQ. (MHz)	EMISSION LEVEL (dBuV/m)	LIMIT (dBuV/m)	MARGIN (dB)	ANTENNA HEIGHT (m)	TABLE ANGLE (Degree)	RAW VALUE (dBuV)	CORRECTION FACTOR (dB/m)
1	*5580.00	104.9 PK			1.03 H	213	98.09	6.78
2	*5580.00	95.6 AV			1.03 H	213	88.81	6.78
3	11160.00	58.1 PK	74.0	-15.9	1.17 H	234	43.09	14.99
4	11160.00	46.8 AV	54.0	-7.2	1.17 H	234	31.77	14.99

ANTENNA POLARITY & TEST DISTANCE: VERTICAL AT 3 M

NO.	FREQ. (MHz)	EMISSION LEVEL (dBuV/m)	LIMIT (dBuV/m)	MARGIN (dB)	ANTENNA HEIGHT (m)	TABLE ANGLE (Degree)	RAW VALUE (dBuV)	CORRECTION FACTOR (dB/m)
1	*5580.00	100.9 PK			1.00 V	238	94.14	6.78
2	*5580.00	91.6 AV			1.00 V	238	84.84	6.78
3	11160.00	57.2 PK	74.0	-16.8	1.09 V	219	42.17	14.99
4	11160.00	45.2 AV	54.0	-8.8	1.09 V	219	30.22	14.99

REMARKS:

1. Emission Level(dBuV/m) = Raw Value(dBuV) + Correction Factor(dB/m)
2. Correction Factor(dB/m) = Antenna Factor(dB/m) + Cable Factor(dB) – Pre-Amplifier Factor(dB)
3. The other emission levels were very low against the limit.
4. Margin value = Emission Level – Limit value
5. " * ": Fundamental frequency.



CHANNEL	TX Channel 132	DETECTOR FUNCTION	Peak (PK)
FREQUENCY RANGE	1GHz ~ 40GHz		Average (AV)

ANTENNA POLARITY & TEST DISTANCE: HORIZONTAL AT 3 M

NO.	FREQ. (MHz)	EMISSION LEVEL (dBuV/m)	LIMIT (dBuV/m)	MARGIN (dB)	ANTENNA HEIGHT (m)	TABLE ANGLE (Degree)	RAW VALUE (dBuV)	CORRECTION FACTOR (dB/m)
1	*5660.00	103.2 PK			1.02 H	227	96.71	6.46
2	*5660.00	93.5 AV			1.02 H	227	86.99	6.46
3	11320.00	57.4 PK	74.0	-16.6	1.06 H	257	42.31	15.06
4	11320.00	47.1 AV	54.0	-6.9	1.06 H	257	32.07	15.06

ANTENNA POLARITY & TEST DISTANCE: VERTICAL AT 3 M

NO.	FREQ. (MHz)	EMISSION LEVEL (dBuV/m)	LIMIT (dBuV/m)	MARGIN (dB)	ANTENNA HEIGHT (m)	TABLE ANGLE (Degree)	RAW VALUE (dBuV)	CORRECTION FACTOR (dB/m)
1	*5660.00	98.1 PK			1.33 V	224	91.61	6.46
2	*5660.00	88.3 AV			1.33 V	224	81.81	6.46
3	11320.00	56.2 PK	74.0	-17.8	1.05 V	314	41.13	15.06
4	11320.00	45.9 AV	54.0	-8.1	1.05 V	314	30.87	15.06

REMARKS:

1. Emission Level(dBuV/m) = Raw Value(dBuV) + Correction Factor(dB/m)
2. Correction Factor(dB/m) = Antenna Factor(dB/m) + Cable Factor(dB) – Pre-Amplifier Factor(dB)
3. The other emission levels were very low against the limit.
4. Margin value = Emission Level – Limit value
5. " * ": Fundamental frequency.



CHANNEL	TX Channel 140	DETECTOR FUNCTION	Peak (PK)
FREQUENCY RANGE	1GHz ~ 40GHz		Average (AV)

ANTENNA POLARITY & TEST DISTANCE: HORIZONTAL AT 3 M								
NO.	FREQ. (MHz)	EMISSION LEVEL (dBuV/m)	LIMIT (dBuV/m)	MARGIN (dB)	ANTENNA HEIGHT (m)	TABLE ANGLE (Degree)	RAW VALUE (dBuV)	CORRECTION FACTOR (dB/m)
1	*5700.00	101.4 PK			1.02 H	216	95.18	6.24
2	*5700.00	91.7 AV			1.02 H	216	85.43	6.24
3	#5725.00	59.4 PK	74.0	-14.6	1.02 H	216	52.95	6.42
4	#5725.00	47.4 AV	54.0	-6.6	1.02 H	216	40.95	6.42
5	11400.00	57.1 PK	74.0	-16.9	1.00 H	302	42.13	14.95
6	11400.00	46.5 AV	54.0	-7.5	1.00 H	302	31.55	14.95
ANTENNA POLARITY & TEST DISTANCE: VERTICAL AT 3 M								
NO.	FREQ. (MHz)	EMISSION LEVEL (dBuV/m)	LIMIT (dBuV/m)	MARGIN (dB)	ANTENNA HEIGHT (m)	TABLE ANGLE (Degree)	RAW VALUE (dBuV)	CORRECTION FACTOR (dB/m)
1	*5700.00	97.3 PK			1.19 V	230	91.06	6.24
2	*5700.00	87.8 AV			1.19 V	230	81.54	6.24
3	#5725.00	58.5 PK	74.0	-15.5	1.19 V	230	52.06	6.42
4	#5725.00	46.9 AV	54.0	-7.1	1.19 V	230	40.51	6.42
5	11400.00	56.9 PK	74.0	-17.1	1.06 V	339	41.93	14.95
6	11400.00	45.0 AV	54.0	-9.0	1.06 V	339	30.09	14.95

REMARKS:

- Emission Level(dBuV/m) = Raw Value(dBuV) + Correction Factor(dB/m)
- Correction Factor(dB/m) = Antenna Factor(dB/m) + Cable Factor(dB) – Pre-Amplifier Factor(dB)
- The other emission levels were very low against the limit.
- Margin value = Emission Level – Limit value
- " * ": Fundamental frequency.
- " # ": The radiated frequency is out of the restricted band.



CHANNEL	TX Channel 149	DETECTOR FUNCTION	Peak (PK)
FREQUENCY RANGE	1GHz ~ 40GHz		Average (AV)

ANTENNA POLARITY & TEST DISTANCE: HORIZONTAL AT 3 M

NO.	FREQ. (MHz)	EMISSION LEVEL (dBuV/m)	LIMIT (dBuV/m)	MARGIN (dB)	ANTENNA HEIGHT (m)	TABLE ANGLE (Degree)	RAW VALUE (dBuV)	CORRECTION FACTOR (dB/m)
1	#5725.00	71.8 PK	74.0	-2.2	1.19 H	250	65.39	6.42
2	#5725.00	52.9 AV	54.0	-1.1	1.19 H	250	46.51	6.42
3	*5745.00	103.2 PK			1.19 H	250	96.63	6.57
4	*5745.00	93.5 AV			1.19 H	250	86.95	6.57
5	11490.00	58.0 PK	74.0	-16.0	1.06 H	154	42.37	15.60
6	11490.00	47.7 AV	54.0	-6.3	1.06 H	154	32.11	15.60

ANTENNA POLARITY & TEST DISTANCE: VERTICAL AT 3 M

NO.	FREQ. (MHz)	EMISSION LEVEL (dBuV/m)	LIMIT (dBuV/m)	MARGIN (dB)	ANTENNA HEIGHT (m)	TABLE ANGLE (Degree)	RAW VALUE (dBuV)	CORRECTION FACTOR (dB/m)
1	#5725.00	69.1 PK	74.0	-4.9	1.08 V	211	62.68	6.42
2	#5725.00	52.4 AV	54.0	-1.6	1.08 V	211	46.01	6.42
3	*5745.00	100.4 PK			1.08 V	211	93.78	6.57
4	*5745.00	90.6 AV			1.08 V	211	83.98	6.57
5	11490.00	57.5 PK	74.0	-16.5	1.00 V	360	41.88	15.60
6	11490.00	46.7 AV	54.0	-7.3	1.00 V	360	31.06	15.60

REMARKS:

1. Emission Level(dBuV/m) = Raw Value(dBuV) + Correction Factor(dB/m)
2. Correction Factor(dB/m) = Antenna Factor(dB/m) + Cable Factor(dB) – Pre-Amplifier Factor(dB)
3. The other emission levels were very low against the limit.
4. Margin value = Emission Level – Limit value
5. " * ": Fundamental frequency.
6. " # ": The radiated frequency is out of the restricted band.



CHANNEL	TX Channel 157	DETECTOR FUNCTION	Peak (PK)
FREQUENCY RANGE	1GHz ~ 40GHz		Average (AV)

ANTENNA POLARITY & TEST DISTANCE: HORIZONTAL AT 3 M

NO.	FREQ. (MHz)	EMISSION LEVEL (dBuV/m)	LIMIT (dBuV/m)	MARGIN (dB)	ANTENNA HEIGHT (m)	TABLE ANGLE (Degree)	RAW VALUE (dBuV)	CORRECTION FACTOR (dB/m)
1	*5785.00	103.5 PK			1.20 H	248	96.69	6.85
2	*5785.00	94.1 AV			1.20 H	248	87.28	6.85
3	11570.00	58.0 PK	74.0	-16.0	1.27 H	35	43.02	14.97
4	11570.00	47.4 AV	54.0	-6.6	1.27 H	35	32.47	14.97

ANTENNA POLARITY & TEST DISTANCE: VERTICAL AT 3 M

NO.	FREQ. (MHz)	EMISSION LEVEL (dBuV/m)	LIMIT (dBuV/m)	MARGIN (dB)	ANTENNA HEIGHT (m)	TABLE ANGLE (Degree)	RAW VALUE (dBuV)	CORRECTION FACTOR (dB/m)
1	*5785.00	101.5 PK			1.06 V	212	94.63	6.85
2	*5785.00	92.1 AV			1.06 V	212	85.29	6.85
3	11570.00	56.7 PK	74.0	-17.3	1.09 V	251	41.76	14.97
4	11570.00	46.0 AV	54.0	-8.1	1.09 V	251	30.98	14.97

REMARKS:

1. Emission Level(dBuV/m) = Raw Value(dBuV) + Correction Factor(dB/m)
2. Correction Factor(dB/m) = Antenna Factor(dB/m) + Cable Factor(dB) – Pre-Amplifier Factor(dB)
3. The other emission levels were very low against the limit.
4. Margin value = Emission Level – Limit value
5. " * ": Fundamental frequency.

CHANNEL	TX Channel 165	DETECTOR FUNCTION	Peak (PK)
FREQUENCY RANGE	1GHz ~ 40GHz		Average (AV)

ANTENNA POLARITY & TEST DISTANCE: HORIZONTAL AT 3 M

NO.	FREQ. (MHz)	EMISSION LEVEL (dBuV/m)	LIMIT (dBuV/m)	MARGIN (dB)	ANTENNA HEIGHT (m)	TABLE ANGLE (Degree)	RAW VALUE (dBuV)	CORRECTION FACTOR (dB/m)
1	*5825.00	104.3 PK			1.39 H	234	97.28	6.98
2	*5825.00	94.5 AV			1.39 H	234	87.56	6.98
3	#5850.00	63.8 PK	74.0	-10.2	1.39 H	234	56.81	6.99
4	#5850.00	49.8 AV	54.0	-4.2	1.39 H	234	42.81	6.99
5	11650.00	58.1 PK	74.0	-15.9	1.15 H	307	43.17	14.97
6	11650.00	48.0 AV	54.0	-6.0	1.15 H	307	33.02	14.97

ANTENNA POLARITY & TEST DISTANCE: VERTICAL AT 3 M

NO.	FREQ. (MHz)	EMISSION LEVEL (dBuV/m)	LIMIT (dBuV/m)	MARGIN (dB)	ANTENNA HEIGHT (m)	TABLE ANGLE (Degree)	RAW VALUE (dBuV)	CORRECTION FACTOR (dB/m)
1	*5825.00	99.5 PK			1.02 V	199	92.53	6.98
2	*5825.00	89.8 AV			1.02 V	199	82.84	6.98
3	#5850.00	60.7 PK	74.0	-13.3	1.02 V	199	53.71	6.99
4	#5850.00	47.6 AV	54.0	-6.4	1.02 V	199	40.64	6.99
5	11650.00	57.1 PK	74.0	-16.9	1.41 V	257	42.13	14.97
6	11650.00	46.9 AV	54.0	-7.1	1.41 V	257	31.97	14.97

REMARKS:

- Emission Level(dBuV/m) = Raw Value(dBuV) + Correction Factor(dB/m)
- Correction Factor(dB/m) = Antenna Factor(dB/m) + Cable Factor(dB) – Pre-Amplifier Factor(dB)
- The other emission levels were very low against the limit.
- Margin value = Emission Level – Limit value
- " * ": Fundamental frequency.
- " # ": The radiated frequency is out of the restricted band.



802.11n (20MHz)

CHANNEL	TX Channel 36	DETECTOR FUNCTION	Peak (PK)
FREQUENCY RANGE	1GHz ~ 40GHz		Average (AV)

ANTENNA POLARITY & TEST DISTANCE: HORIZONTAL AT 3 M

NO.	FREQ. (MHz)	EMISSION LEVEL (dBuV/m)	LIMIT (dBuV/m)	MARGIN (dB)	ANTENNA HEIGHT (m)	TABLE ANGLE (Degree)	RAW VALUE (dBuV)	CORRECTION FACTOR (dB/m)
1	5150.00	60.9 PK	74.0	-13.1	1.01 H	217	55.12	5.82
2	5150.00	47.8 AV	54.0	-6.2	1.01 H	217	42.01	5.82
3	*5180.00	104.1 PK			1.01 H	217	98.38	5.75
4	*5180.00	94.5 AV			1.01 H	217	88.77	5.75
5	#10360.00	54.9 PK	74.0	-19.2	1.17 H	293	42.16	12.69
6	#10360.00	45.2 AV	54.0	-8.8	1.17 H	293	32.55	12.69

ANTENNA POLARITY & TEST DISTANCE: VERTICAL AT 3 M

NO.	FREQ. (MHz)	EMISSION LEVEL (dBuV/m)	LIMIT (dBuV/m)	MARGIN (dB)	ANTENNA HEIGHT (m)	TABLE ANGLE (Degree)	RAW VALUE (dBuV)	CORRECTION FACTOR (dB/m)
1	5150.00	57.0 PK	74.0	-17.0	1.25 V	211	51.14	5.82
2	5150.00	45.8 AV	54.0	-8.2	1.25 V	211	40.02	5.82
3	*5180.00	97.1 PK			1.25 V	211	91.34	5.75
4	*5180.00	87.5 AV			1.25 V	211	81.76	5.75
5	#10360.00	53.8 PK	74.0	-20.2	1.02 V	57	41.11	12.69
6	#10360.00	43.9 AV	54.0	-10.1	1.02 V	57	31.24	12.69

REMARKS:

- Emission Level(dBuV/m) = Raw Value(dBuV) + Correction Factor(dB/m)
- Correction Factor(dB/m) = Antenna Factor(dB/m) + Cable Factor(dB) – Pre-Amplifier Factor(dB)
- The other emission levels were very low against the limit.
- Margin value = Emission Level – Limit value
- " * ": Fundamental frequency.
- " # ": The radiated frequency is out of the restricted band.



CHANNEL	TX Channel 40	DETECTOR FUNCTION	Peak (PK)
FREQUENCY RANGE	1GHz ~ 40GHz		Average (AV)

ANTENNA POLARITY & TEST DISTANCE: HORIZONTAL AT 3 M								
NO.	FREQ. (MHz)	EMISSION LEVEL (dBuV/m)	LIMIT (dBuV/m)	MARGIN (dB)	ANTENNA HEIGHT (m)	TABLE ANGLE (Degree)	RAW VALUE (dBuV)	CORRECTION FACTOR (dB/m)
1	*5200.00	103.7 PK			1.13 H	212	97.96	5.70
2	*5200.00	94.7 AV			1.13 H	212	88.98	5.70
3	#10400.00	55.3 PK	74.0	-18.7	1.02 H	47	42.73	12.55
4	#10400.00	44.5 AV	54.0	-9.5	1.02 H	47	31.95	12.55

ANTENNA POLARITY & TEST DISTANCE: VERTICAL AT 3 M								
NO.	FREQ. (MHz)	EMISSION LEVEL (dBuV/m)	LIMIT (dBuV/m)	MARGIN (dB)	ANTENNA HEIGHT (m)	TABLE ANGLE (Degree)	RAW VALUE (dBuV)	CORRECTION FACTOR (dB/m)
1	*5200.00	95.3 PK			1.15 V	209	89.63	5.70
2	*5200.00	86.0 AV			1.15 V	209	80.29	5.70
3	#10400.00	53.9 PK	74.0	-20.1	1.00 V	329	41.37	12.55
4	#10400.00	43.5 AV	54.0	-10.5	1.00 V	329	30.98	12.55

REMARKS:

- Emission Level(dBuV/m) = Raw Value(dBuV) + Correction Factor(dB/m)
- Correction Factor(dB/m) = Antenna Factor(dB/m) + Cable Factor(dB) – Pre-Amplifier Factor(dB)
- The other emission levels were very low against the limit.
- Margin value = Emission Level – Limit value
- " * ": Fundamental frequency.
- " # ": The radiated frequency is out of the restricted band.



CHANNEL	TX Channel 48	DETECTOR FUNCTION	Peak (PK)
FREQUENCY RANGE	1GHz ~ 40GHz		Average (AV)

ANTENNA POLARITY & TEST DISTANCE: HORIZONTAL AT 3 M								
NO.	FREQ. (MHz)	EMISSION LEVEL (dBuV/m)	LIMIT (dBuV/m)	MARGIN (dB)	ANTENNA HEIGHT (m)	TABLE ANGLE (Degree)	RAW VALUE (dBuV)	CORRECTION FACTOR (dB/m)
1	*5240.00	104.4 PK			1.02 H	210	98.51	5.86
2	*5240.00	94.8 AV			1.02 H	210	88.97	5.86
3	5350.00	60.5 PK	74.0	-13.5	1.02 H	210	54.25	6.28
4	5350.00	46.6 AV	54.0	-7.4	1.02 H	210	40.31	6.28
5	#10480.00	55.6 PK	74.0	-18.4	1.09 H	254	42.51	13.09
6	#10480.00	45.1 AV	54.0	-8.9	1.09 H	254	31.97	13.09
ANTENNA POLARITY & TEST DISTANCE: VERTICAL AT 3 M								
NO.	FREQ. (MHz)	EMISSION LEVEL (dBuV/m)	LIMIT (dBuV/m)	MARGIN (dB)	ANTENNA HEIGHT (m)	TABLE ANGLE (Degree)	RAW VALUE (dBuV)	CORRECTION FACTOR (dB/m)
1	*5240.00	95.9 PK			1.01 V	212	90.04	5.86
2	*5240.00	86.1 AV			1.01 V	212	80.27	5.86
3	5350.00	59.2 PK	74.0	-14.8	1.01 V	212	52.88	6.28
4	5350.00	46.0 AV	54.0	-8.0	1.01 V	212	39.68	6.28
5	#10480.00	54.4 PK	74.0	-19.6	1.27 V	139	41.28	13.09
6	#10480.00	44.2 AV	54.0	-9.9	1.27 V	139	31.06	13.09

REMARKS:

- Emission Level(dBuV/m) = Raw Value(dBuV) + Correction Factor(dB/m)
- Correction Factor(dB/m) = Antenna Factor(dB/m) + Cable Factor(dB) – Pre-Amplifier Factor(dB)
- The other emission levels were very low against the limit.
- Margin value = Emission Level – Limit value
- " * ": Fundamental frequency.
- " # ": The radiated frequency is out of the restricted band.



CHANNEL	TX Channel 52	DETECTOR FUNCTION	Peak (PK)
FREQUENCY RANGE	1GHz ~ 40GHz		Average (AV)

ANTENNA POLARITY & TEST DISTANCE: HORIZONTAL AT 3 M

NO.	FREQ. (MHz)	EMISSION LEVEL (dBuV/m)	LIMIT (dBuV/m)	MARGIN (dB)	ANTENNA HEIGHT (m)	TABLE ANGLE (Degree)	RAW VALUE (dBuV)	CORRECTION FACTOR (dB/m)
1	5150.00	59.5 PK	74.0	-14.5	1.00 H	213	53.66	5.82
2	5150.00	46.8 AV	54.0	-7.2	1.00 H	213	40.97	5.82
3	*5260.00	104.3 PK			1.00 H	213	98.38	5.92
4	*5260.00	94.8 AV			1.00 H	213	88.86	5.92
5	#10520.00	55.4 PK	74.0	-18.6	1.20 H	345	42.09	13.27
6	#10520.00	45.4 AV	54.0	-8.6	1.20 H	345	32.11	13.27

ANTENNA POLARITY & TEST DISTANCE: VERTICAL AT 3 M

NO.	FREQ. (MHz)	EMISSION LEVEL (dBuV/m)	LIMIT (dBuV/m)	MARGIN (dB)	ANTENNA HEIGHT (m)	TABLE ANGLE (Degree)	RAW VALUE (dBuV)	CORRECTION FACTOR (dB/m)
1	5150.00	58.9 PK	74.0	-15.1	1.08 V	219	53.05	5.82
2	5150.00	45.7 AV	54.0	-8.3	1.08 V	219	39.86	5.82
3	*5260.00	94.7 PK			1.08 V	219	88.78	5.92
4	*5260.00	85.2 AV			1.08 V	219	79.24	5.92
5	#10520.00	54.3 PK	74.0	-19.7	1.36 V	29	41.01	13.27
6	#10520.00	44.2 AV	54.0	-9.8	1.36 V	29	30.97	13.27

REMARKS:

1. Emission Level(dBuV/m) = Raw Value(dBuV) + Correction Factor(dB/m)
2. Correction Factor(dB/m) = Antenna Factor(dB/m) + Cable Factor(dB) – Pre-Amplifier Factor(dB)
3. The other emission levels were very low against the limit.
4. Margin value = Emission Level – Limit value
5. " * ": Fundamental frequency.
6. " # ": The radiated frequency is out of the restricted band.



CHANNEL	TX Channel 60	DETECTOR FUNCTION	Peak (PK)
FREQUENCY RANGE	1GHz ~ 40GHz		Average (AV)

ANTENNA POLARITY & TEST DISTANCE: HORIZONTAL AT 3 M								
NO.	FREQ. (MHz)	EMISSION LEVEL (dBuV/m)	LIMIT (dBuV/m)	MARGIN (dB)	ANTENNA HEIGHT (m)	TABLE ANGLE (Degree)	RAW VALUE (dBuV)	CORRECTION FACTOR (dB/m)
1	*5300.00	102.9 PK			1.19 H	228	96.86	6.08
2	*5300.00	93.3 AV			1.19 H	228	87.25	6.08
3	10600.00	56.6 PK	74.0	-17.5	1.10 H	98	43.08	13.47
4	10600.00	46.0 AV	54.0	-8.0	1.10 H	98	32.51	13.47

ANTENNA POLARITY & TEST DISTANCE: VERTICAL AT 3 M								
NO.	FREQ. (MHz)	EMISSION LEVEL (dBuV/m)	LIMIT (dBuV/m)	MARGIN (dB)	ANTENNA HEIGHT (m)	TABLE ANGLE (Degree)	RAW VALUE (dBuV)	CORRECTION FACTOR (dB/m)
1	*5300.00	97.8 PK			1.16 V	251	91.72	6.08
2	*5300.00	88.0 AV			1.16 V	251	81.95	6.08
3	10600.00	55.3 PK	74.0	-18.7	1.02 V	107	41.81	13.47
4	10600.00	45.1 AV	54.0	-8.9	1.02 V	107	31.65	13.47

REMARKS:

1. Emission Level(dBuV/m) = Raw Value(dBuV) + Correction Factor(dB/m)
2. Correction Factor(dB/m) = Antenna Factor(dB/m) + Cable Factor(dB) – Pre-Amplifier Factor(dB)
3. The other emission levels were very low against the limit.
4. Margin value = Emission Level – Limit value
5. " * ": Fundamental frequency.



CHANNEL	TX Channel 64	DETECTOR FUNCTION	Peak (PK)
FREQUENCY RANGE	1GHz ~ 40GHz		Average (AV)

ANTENNA POLARITY & TEST DISTANCE: HORIZONTAL AT 3 M

NO.	FREQ. (MHz)	EMISSION LEVEL (dBuV/m)	LIMIT (dBuV/m)	MARGIN (dB)	ANTENNA HEIGHT (m)	TABLE ANGLE (Degree)	RAW VALUE (dBuV)	CORRECTION FACTOR (dB/m)
1	*5320.00	102.9 PK			1.19 H	224	96.77	6.16
2	*5320.00	93.5 AV			1.19 H	224	87.37	6.16
3	5350.00	59.5 PK	74.0	-14.5	1.19 H	224	53.19	6.28
4	5350.00	46.6 AV	54.0	-7.5	1.19 H	224	40.27	6.28
5	10640.00	56.2 PK	74.0	-17.8	1.05 H	310	42.63	13.60
6	10640.00	45.8 AV	54.0	-8.3	1.05 H	310	32.15	13.60

ANTENNA POLARITY & TEST DISTANCE: VERTICAL AT 3 M

NO.	FREQ. (MHz)	EMISSION LEVEL (dBuV/m)	LIMIT (dBuV/m)	MARGIN (dB)	ANTENNA HEIGHT (m)	TABLE ANGLE (Degree)	RAW VALUE (dBuV)	CORRECTION FACTOR (dB/m)
1	*5320.00	97.4 PK			1.04 V	242	91.28	6.16
2	*5320.00	87.9 AV			1.04 V	242	81.75	6.16
3	5350.00	56.8 PK	74.0	-17.2	1.04 V	242	50.54	6.28
4	5350.00	45.2 AV	54.0	-8.8	1.04 V	242	38.91	6.28
5	10640.00	55.1 PK	74.0	-18.9	1.16 V	115	41.52	13.60
6	10640.00	44.6 AV	54.0	-9.4	1.16 V	115	31.00	13.60

REMARKS:

1. Emission Level(dBuV/m) = Raw Value(dBuV) + Correction Factor(dB/m)
2. Correction Factor(dB/m) = Antenna Factor(dB/m) + Cable Factor(dB) – Pre-Amplifier Factor(dB)
3. The other emission levels were very low against the limit.
4. Margin value = Emission Level – Limit value
5. " * ": Fundamental frequency.



CHANNEL	TX Channel 100	DETECTOR FUNCTION	Peak (PK)
FREQUENCY RANGE	1GHz ~ 40GHz		Average (AV)

ANTENNA POLARITY & TEST DISTANCE: HORIZONTAL AT 3 M

NO.	FREQ. (MHz)	EMISSION LEVEL (dBuV/m)	LIMIT (dBuV/m)	MARGIN (dB)	ANTENNA HEIGHT (m)	TABLE ANGLE (Degree)	RAW VALUE (dBuV)	CORRECTION FACTOR (dB/m)
1	5460.00	57.3 PK	74.0	-16.7	1.47 H	229	50.67	6.63
2	5460.00	45.6 AV	54.0	-8.4	1.47 H	229	38.98	6.63
3	#5470.00	61.6 PK	74.0	-12.4	1.47 H	229	54.91	6.66
4	#5470.00	46.5 AV	54.0	-7.6	1.47 H	229	39.79	6.66
5	*5500.00	101.9 PK			1.47 H	229	95.17	6.74
6	*5500.00	92.3 AV			1.47 H	229	85.56	6.74
7	11000.00	55.5 PK	74.0	-18.5	1.00 H	197	41.98	13.54
8	11000.00	44.8 AV	54.0	-9.2	1.00 H	197	31.24	13.54

ANTENNA POLARITY & TEST DISTANCE: VERTICAL AT 3 M

NO.	FREQ. (MHz)	EMISSION LEVEL (dBuV/m)	LIMIT (dBuV/m)	MARGIN (dB)	ANTENNA HEIGHT (m)	TABLE ANGLE (Degree)	RAW VALUE (dBuV)	CORRECTION FACTOR (dB/m)
1	5460.00	57.0 PK	74.0	-17.0	1.37 V	231	50.38	6.63
2	5460.00	45.2 AV	54.0	-8.8	1.37 V	231	38.61	6.63
3	#5470.00	59.7 PK	74.0	-14.3	1.37 V	231	53.07	6.66
4	#5470.00	46.2 AV	54.0	-7.8	1.37 V	231	39.51	6.66
5	*5500.00	98.2 PK			1.37 V	231	91.43	6.74
6	*5500.00	88.6 AV			1.37 V	231	81.81	6.74
7	11000.00	54.6 PK	74.0	-19.4	1.11 V	277	41.10	13.54
8	11000.00	44.5 AV	54.0	-9.5	1.11 V	277	30.92	13.54

REMARKS:

1. Emission Level(dBuV/m) = Raw Value(dBuV) + Correction Factor(dB/m)
2. Correction Factor(dB/m) = Antenna Factor(dB/m) + Cable Factor(dB) – Pre-Amplifier Factor(dB)
3. The other emission levels were very low against the limit.
4. Margin value = Emission Level – Limit value
5. " * ": Fundamental frequency.
6. " # ": The radiated frequency is out of the restricted band.

CHANNEL	TX Channel 116	DETECTOR FUNCTION	Peak (PK)
FREQUENCY RANGE	1GHz ~ 40GHz		Average (AV)

ANTENNA POLARITY & TEST DISTANCE: HORIZONTAL AT 3 M

NO.	FREQ. (MHz)	EMISSION LEVEL (dBuV/m)	LIMIT (dBuV/m)	MARGIN (dB)	ANTENNA HEIGHT (m)	TABLE ANGLE (Degree)	RAW VALUE (dBuV)	CORRECTION FACTOR (dB/m)
1	*5580.00	103.2 PK			1.33 H	227	96.46	6.78
2	*5580.00	93.1 AV			1.33 H	227	86.33	6.78
3	11160.00	58.1 PK	74.0	-16.0	1.08 H	281	43.06	14.99
4	11160.00	46.3 AV	54.0	-7.7	1.08 H	281	31.29	14.99

ANTENNA POLARITY & TEST DISTANCE: VERTICAL AT 3 M

NO.	FREQ. (MHz)	EMISSION LEVEL (dBuV/m)	LIMIT (dBuV/m)	MARGIN (dB)	ANTENNA HEIGHT (m)	TABLE ANGLE (Degree)	RAW VALUE (dBuV)	CORRECTION FACTOR (dB/m)
1	*5580.00	97.5 PK			1.23 V	248	90.71	6.78
2	*5580.00	87.9 AV			1.23 V	248	81.15	6.78
3	11160.00	56.9 PK	74.0	-17.1	1.00 V	145	41.90	14.99
4	11160.00	46.0 AV	54.0	-8.0	1.00 V	145	31.02	14.99

REMARKS:

1. Emission Level(dBuV/m) = Raw Value(dBuV) + Correction Factor(dB/m)
2. Correction Factor(dB/m) = Antenna Factor(dB/m) + Cable Factor(dB) – Pre-Amplifier Factor(dB)
3. The other emission levels were very low against the limit.
4. Margin value = Emission Level – Limit value
5. " * ": Fundamental frequency.



CHANNEL	TX Channel 132	DETECTOR FUNCTION	Peak (PK)
FREQUENCY RANGE	1GHz ~ 40GHz		Average (AV)

ANTENNA POLARITY & TEST DISTANCE: HORIZONTAL AT 3 M

NO.	FREQ. (MHz)	EMISSION LEVEL (dBuV/m)	LIMIT (dBuV/m)	MARGIN (dB)	ANTENNA HEIGHT (m)	TABLE ANGLE (Degree)	RAW VALUE (dBuV)	CORRECTION FACTOR (dB/m)
1	*5660.00	103.0 PK			1.42 H	229	96.56	6.46
2	*5660.00	93.4 AV			1.42 H	229	86.94	6.46
3	11320.00	57.4 PK	74.0	-16.6	1.31 H	267	42.30	15.06
4	11320.00	46.2 AV	54.0	-7.8	1.31 H	267	31.12	15.06

ANTENNA POLARITY & TEST DISTANCE: VERTICAL AT 3 M

NO.	FREQ. (MHz)	EMISSION LEVEL (dBuV/m)	LIMIT (dBuV/m)	MARGIN (dB)	ANTENNA HEIGHT (m)	TABLE ANGLE (Degree)	RAW VALUE (dBuV)	CORRECTION FACTOR (dB/m)
1	*5660.00	98.6 PK			1.18 V	249	92.17	6.46
2	*5660.00	89.0 AV			1.18 V	249	82.54	6.46
3	11320.00	56.6 PK	74.0	-17.4	1.24 V	322	41.53	15.06
4	11320.00	45.9 AV	54.0	-8.1	1.24 V	322	30.88	15.06

REMARKS:

1. Emission Level(dBuV/m) = Raw Value(dBuV) + Correction Factor(dB/m)
2. Correction Factor(dB/m) = Antenna Factor(dB/m) + Cable Factor(dB) – Pre-Amplifier Factor(dB)
3. The other emission levels were very low against the limit.
4. Margin value = Emission Level – Limit value
5. " * ": Fundamental frequency.



CHANNEL	TX Channel 140	DETECTOR FUNCTION	Peak (PK)
FREQUENCY RANGE	1GHz ~ 40GHz		Average (AV)

ANTENNA POLARITY & TEST DISTANCE: HORIZONTAL AT 3 M								
NO.	FREQ. (MHz)	EMISSION LEVEL (dBuV/m)	LIMIT (dBuV/m)	MARGIN (dB)	ANTENNA HEIGHT (m)	TABLE ANGLE (Degree)	RAW VALUE (dBuV)	CORRECTION FACTOR (dB/m)
1	*5700.00	103.2 PK			1.43 H	231	96.98	6.24
2	*5700.00	92.9 AV			1.43 H	231	86.68	6.24
3	#5725.00	61.2 PK	74.0	-12.9	1.43 H	231	54.73	6.42
4	#5725.00	48.1 AV	54.0	-5.9	1.43 H	231	41.64	6.42
5	11400.00	57.8 PK	74.0	-16.2	1.16 H	297	42.83	14.95
6	11400.00	47.1 AV	54.0	-6.9	1.16 H	297	32.15	14.95
ANTENNA POLARITY & TEST DISTANCE: VERTICAL AT 3 M								
NO.	FREQ. (MHz)	EMISSION LEVEL (dBuV/m)	LIMIT (dBuV/m)	MARGIN (dB)	ANTENNA HEIGHT (m)	TABLE ANGLE (Degree)	RAW VALUE (dBuV)	CORRECTION FACTOR (dB/m)
1	*5700.00	99.0 PK			1.42 V	233	92.78	6.24
2	*5700.00	89.5 AV			1.42 V	233	83.22	6.24
3	#5725.00	59.6 PK	74.0	-14.4	1.42 V	233	53.17	6.42
4	#5725.00	46.6 AV	54.0	-7.4	1.42 V	233	40.16	6.42
5	11400.00	56.5 PK	74.0	-17.5	1.30 V	271	41.52	14.95
6	11400.00	46.6 AV	54.0	-7.4	1.30 V	271	31.69	14.95

REMARKS:

- Emission Level(dBuV/m) = Raw Value(dBuV) + Correction Factor(dB/m)
- Correction Factor(dB/m) = Antenna Factor(dB/m) + Cable Factor(dB) – Pre-Amplifier Factor(dB)
- The other emission levels were very low against the limit.
- Margin value = Emission Level – Limit value
- " * ": Fundamental frequency.
- " # ": The radiated frequency is out of the restricted band.



CHANNEL	TX Channel 149	DETECTOR FUNCTION	Peak (PK)
FREQUENCY RANGE	1GHz ~ 40GHz		Average (AV)

ANTENNA POLARITY & TEST DISTANCE: HORIZONTAL AT 3 M

NO.	FREQ. (MHz)	EMISSION LEVEL (dBuV/m)	LIMIT (dBuV/m)	MARGIN (dB)	ANTENNA HEIGHT (m)	TABLE ANGLE (Degree)	RAW VALUE (dBuV)	CORRECTION FACTOR (dB/m)
1	#5725.00	65.4 PK	74.0	-8.6	1.40 H	248	58.96	6.42
2	#5725.00	51.6 AV	54.0	-2.4	1.40 H	248	45.17	6.42
3	*5745.00	99.6 PK			1.40 H	248	93.04	6.57
4	*5745.00	90.4 AV			1.40 H	248	83.87	6.57
5	11490.00	57.8 PK	74.0	-16.2	1.00 H	319	42.20	15.60
6	11490.00	48.2 AV	54.0	-5.8	1.00 H	319	32.58	15.60

ANTENNA POLARITY & TEST DISTANCE: VERTICAL AT 3 M

NO.	FREQ. (MHz)	EMISSION LEVEL (dBuV/m)	LIMIT (dBuV/m)	MARGIN (dB)	ANTENNA HEIGHT (m)	TABLE ANGLE (Degree)	RAW VALUE (dBuV)	CORRECTION FACTOR (dB/m)
1	#5725.00	63.2 PK	74.0	-10.8	1.40 V	251	56.82	6.42
2	#5725.00	49.3 AV	54.0	-4.7	1.40 V	251	42.85	6.42
3	*5745.00	96.8 PK			1.40 V	251	90.24	6.57
4	*5745.00	87.5 AV			1.40 V	251	80.91	6.57
5	11490.00	57.0 PK	74.0	-17.0	1.08 V	175	41.38	15.60
6	11490.00	47.7 AV	54.0	-6.3	1.08 V	175	32.09	15.60

REMARKS:

- Emission Level(dBuV/m) = Raw Value(dBuV) + Correction Factor(dB/m)
- Correction Factor(dB/m) = Antenna Factor(dB/m) + Cable Factor(dB) – Pre-Amplifier Factor(dB)
- The other emission levels were very low against the limit.
- Margin value = Emission Level – Limit value
- " * ": Fundamental frequency.
- " # ": The radiated frequency is out of the restricted band.



CHANNEL	TX Channel 157	DETECTOR FUNCTION	Peak (PK)
FREQUENCY RANGE	1GHz ~ 40GHz		Average (AV)

ANTENNA POLARITY & TEST DISTANCE: HORIZONTAL AT 3 M								
NO.	FREQ. (MHz)	EMISSION LEVEL (dBuV/m)	LIMIT (dBuV/m)	MARGIN (dB)	ANTENNA HEIGHT (m)	TABLE ANGLE (Degree)	RAW VALUE (dBuV)	CORRECTION FACTOR (dB/m)
1	*5785.00	100.6 PK			1.19 H	231	93.78	6.85
2	*5785.00	91.0 AV			1.19 H	231	84.15	6.85
3	11570.00	58.3 PK	74.0	-15.7	1.07 H	259	43.31	14.97
4	11570.00	47.4 AV	54.0	-6.6	1.07 H	259	32.46	14.97

ANTENNA POLARITY & TEST DISTANCE: VERTICAL AT 3 M								
NO.	FREQ. (MHz)	EMISSION LEVEL (dBuV/m)	LIMIT (dBuV/m)	MARGIN (dB)	ANTENNA HEIGHT (m)	TABLE ANGLE (Degree)	RAW VALUE (dBuV)	CORRECTION FACTOR (dB/m)
1	*5785.00	95.3 PK			1.36 V	252	88.42	6.85
2	*5785.00	87.1 AV			1.36 V	252	80.26	6.85
3	11570.00	57.6 PK	74.0	-16.4	1.00 V	349	42.59	14.97
4	11570.00	46.9 AV	54.0	-7.1	1.00 V	349	31.89	14.97

REMARKS:

1. Emission Level(dBuV/m) = Raw Value(dBuV) + Correction Factor(dB/m)
2. Correction Factor(dB/m) = Antenna Factor(dB/m) + Cable Factor(dB) – Pre-Amplifier Factor(dB)
3. The other emission levels were very low against the limit.
4. Margin value = Emission Level – Limit value
5. " * ": Fundamental frequency.



CHANNEL	TX Channel 165	DETECTOR FUNCTION	Peak (PK)
FREQUENCY RANGE	1GHz ~ 40GHz		Average (AV)

ANTENNA POLARITY & TEST DISTANCE: HORIZONTAL AT 3 M								
NO.	FREQ. (MHz)	EMISSION LEVEL (dBuV/m)	LIMIT (dBuV/m)	MARGIN (dB)	ANTENNA HEIGHT (m)	TABLE ANGLE (Degree)	RAW VALUE (dBuV)	CORRECTION FACTOR (dB/m)
1	*5825.00	101.1 PK			1.17 H	248	94.07	6.98
2	*5825.00	91.4 AV			1.17 H	248	84.38	6.98
3	#5850.00	61.8 PK	74.0	-12.2	1.17 H	248	54.84	6.99
4	#5850.00	48.1 AV	54.0	-5.9	1.17 H	248	41.09	6.99
5	11650.00	58.0 PK	74.0	-16.0	1.05 H	291	42.99	14.97
6	11650.00	47.8 AV	54.0	-6.2	1.05 H	291	32.87	14.97
ANTENNA POLARITY & TEST DISTANCE: VERTICAL AT 3 M								
NO.	FREQ. (MHz)	EMISSION LEVEL (dBuV/m)	LIMIT (dBuV/m)	MARGIN (dB)	ANTENNA HEIGHT (m)	TABLE ANGLE (Degree)	RAW VALUE (dBuV)	CORRECTION FACTOR (dB/m)
1	*5825.00	98.3 PK			1.15 V	284	91.34	6.98
2	*5825.00	88.7 AV			1.15 V	284	81.72	6.98
3	#5850.00	61.4 PK	74.0	-12.6	1.15 V	284	54.41	6.99
4	#5850.00	47.8 AV	54.0	-6.2	1.15 V	284	40.84	6.99
5	11650.00	57.7 PK	74.0	-16.3	1.02 V	307	42.76	14.97
6	11650.00	47.3 AV	54.0	-6.7	1.02 V	307	32.31	14.97

REMARKS:

- Emission Level(dBuV/m) = Raw Value(dBuV) + Correction Factor(dB/m)
- Correction Factor(dB/m) = Antenna Factor(dB/m) + Cable Factor(dB) – Pre-Amplifier Factor(dB)
- The other emission levels were very low against the limit.
- Margin value = Emission Level – Limit value
- " * ": Fundamental frequency.
- " # ": The radiated frequency is out of the restricted band.

802.11n (40MHz)

CHANNEL	TX Channel 38	DETECTOR FUNCTION	Peak (PK)
FREQUENCY RANGE	1GHz ~ 40GHz		Average (AV)

ANTENNA POLARITY & TEST DISTANCE: HORIZONTAL AT 3 M

NO.	FREQ. (MHz)	EMISSION LEVEL (dBuV/m)	LIMIT (dBuV/m)	MARGIN (dB)	ANTENNA HEIGHT (m)	TABLE ANGLE (Degree)	RAW VALUE (dBuV)	CORRECTION FACTOR (dB/m)
1	5150.00	64.4 PK	74.0	-9.6	1.09 H	224	58.62	5.82
2	5150.00	51.0 AV	54.0	-3.1	1.09 H	224	45.13	5.82
3	*5190.00	100.0 PK			1.09 H	224	94.27	5.73
4	*5190.00	90.2 AV			1.09 H	224	84.46	5.73
5	#10380.00	55.5 PK	74.0	-18.5	1.00 H	193	42.87	12.62
6	#10380.00	45.2 AV	54.0	-8.8	1.00 H	193	32.56	12.62

ANTENNA POLARITY & TEST DISTANCE: VERTICAL AT 3 M

NO.	FREQ. (MHz)	EMISSION LEVEL (dBuV/m)	LIMIT (dBuV/m)	MARGIN (dB)	ANTENNA HEIGHT (m)	TABLE ANGLE (Degree)	RAW VALUE (dBuV)	CORRECTION FACTOR (dB/m)
1	5150.00	63.3 PK	74.0	-10.7	1.45 V	242	57.48	5.82
2	5150.00	49.9 AV	54.0	-4.1	1.45 V	242	44.09	5.82
3	*5190.00	95.3 PK			1.45 V	242	89.53	5.73
4	*5190.00	85.7 AV			1.45 V	242	80.01	5.73
5	#10380.00	54.2 PK	74.0	-19.8	1.37 V	226	41.61	12.62
6	#10380.00	44.6 AV	54.0	-9.4	1.37 V	226	31.98	12.62

REMARKS:

- Emission Level(dBuV/m) = Raw Value(dBuV) + Correction Factor(dB/m)
- Correction Factor(dB/m) = Antenna Factor(dB/m) + Cable Factor(dB) – Pre-Amplifier Factor(dB)
- The other emission levels were very low against the limit.
- Margin value = Emission Level – Limit value
- " * ": Fundamental frequency.
- " # ": The radiated frequency is out of the restricted band.



CHANNEL	TX Channel 46	DETECTOR FUNCTION	Peak (PK)
FREQUENCY RANGE	1GHz ~ 40GHz		Average (AV)

ANTENNA POLARITY & TEST DISTANCE: HORIZONTAL AT 3 M								
NO.	FREQ. (MHz)	EMISSION LEVEL (dBuV/m)	LIMIT (dBuV/m)	MARGIN (dB)	ANTENNA HEIGHT (m)	TABLE ANGLE (Degree)	RAW VALUE (dBuV)	CORRECTION FACTOR (dB/m)
1	*5230.00	102.5 PK			1.01 H	211	96.71	5.82
2	*5230.00	92.7 AV			1.01 H	211	86.92	5.82
3	5350.00	61.0 PK	74.0	-13.0	1.01 H	211	54.72	6.28
4	5350.00	47.7 AV	54.0	-6.3	1.01 H	211	41.38	6.28
5	#10460.00	55.8 PK	74.0	-18.2	1.37 H	239	42.88	12.96
6	#10460.00	45.9 AV	54.0	-8.1	1.37 H	239	32.91	12.96
ANTENNA POLARITY & TEST DISTANCE: VERTICAL AT 3 M								
NO.	FREQ. (MHz)	EMISSION LEVEL (dBuV/m)	LIMIT (dBuV/m)	MARGIN (dB)	ANTENNA HEIGHT (m)	TABLE ANGLE (Degree)	RAW VALUE (dBuV)	CORRECTION FACTOR (dB/m)
1	*5230.00	95.1 PK			1.43 V	244	89.28	5.82
2	*5230.00	85.5 AV			1.43 V	244	79.63	5.82
3	5350.00	59.7 PK	74.0	-14.3	1.43 V	244	53.38	6.28
4	5350.00	46.7 AV	54.0	-7.3	1.43 V	244	40.46	6.28
5	#10460.00	55.1 PK	74.0	-18.9	1.28 V	211	42.17	12.96
6	#10460.00	44.8 AV	54.0	-9.2	1.28 V	211	31.81	12.96

REMARKS:

- Emission Level(dBuV/m) = Raw Value(dBuV) + Correction Factor(dB/m)
- Correction Factor(dB/m) = Antenna Factor(dB/m) + Cable Factor(dB) – Pre-Amplifier Factor(dB)
- The other emission levels were very low against the limit.
- Margin value = Emission Level – Limit value
- " * ": Fundamental frequency.
- " # ": The radiated frequency is out of the restricted band.



CHANNEL	TX Channel 54	DETECTOR FUNCTION	Peak (PK)
FREQUENCY RANGE	1GHz ~ 40GHz		Average (AV)

ANTENNA POLARITY & TEST DISTANCE: HORIZONTAL AT 3 M								
NO.	FREQ. (MHz)	EMISSION LEVEL (dBuV/m)	LIMIT (dBuV/m)	MARGIN (dB)	ANTENNA HEIGHT (m)	TABLE ANGLE (Degree)	RAW VALUE (dBuV)	CORRECTION FACTOR (dB/m)
1	5150.00	59.2 PK	74.0	-14.8	1.12 H	211	53.38	5.82
2	5150.00	47.3 AV	54.0	-6.7	1.12 H	211	41.45	5.82
3	*5270.00	101.1 PK			1.12 H	211	95.16	5.96
4	*5270.00	91.9 AV			1.12 H	211	85.89	5.96
5	#10540.00	56.2 PK	74.0	-17.8	1.24 H	326	42.91	13.33
6	#10540.00	45.9 AV	54.0	-8.1	1.24 H	326	32.57	13.33

ANTENNA POLARITY & TEST DISTANCE: VERTICAL AT 3 M								
NO.	FREQ. (MHz)	EMISSION LEVEL (dBuV/m)	LIMIT (dBuV/m)	MARGIN (dB)	ANTENNA HEIGHT (m)	TABLE ANGLE (Degree)	RAW VALUE (dBuV)	CORRECTION FACTOR (dB/m)
1	5150.00	56.5 PK	74.0	-17.5	1.10 V	212	50.65	5.82
2	5150.00	45.6 AV	54.0	-8.4	1.10 V	212	39.78	5.82
3	*5270.00	94.0 PK			1.10 V	212	88.07	5.96
4	*5270.00	84.3 AV			1.10 V	212	78.31	5.96
5	#10540.00	56.1 PK	74.0	-17.9	1.08 V	264	42.73	13.33
6	#10540.00	45.0 AV	54.0	-9.0	1.08 V	264	31.67	13.33

REMARKS:

- Emission Level(dBuV/m) = Raw Value(dBuV) + Correction Factor(dB/m)
- Correction Factor(dB/m) = Antenna Factor(dB/m) + Cable Factor(dB) – Pre-Amplifier Factor(dB)
- The other emission levels were very low against the limit.
- Margin value = Emission Level – Limit value
- " * ": Fundamental frequency.
- " # ": The radiated frequency is out of the restricted band.



CHANNEL	TX Channel 62	DETECTOR FUNCTION	Peak (PK)
FREQUENCY RANGE	1GHz ~ 40GHz		Average (AV)

ANTENNA POLARITY & TEST DISTANCE: HORIZONTAL AT 3 M

NO.	FREQ. (MHz)	EMISSION LEVEL (dBuV/m)	LIMIT (dBuV/m)	MARGIN (dB)	ANTENNA HEIGHT (m)	TABLE ANGLE (Degree)	RAW VALUE (dBuV)	CORRECTION FACTOR (dB/m)
1	*5310.00	98.0 PK			1.00 H	254	94.04	3.91
2	*5310.00	88.5 AV			1.00 H	254	84.55	3.91
3	5350.00	66.2 PK	74.0	-7.8	1.00 H	254	62.11	4.05
4	5350.00	52.9 AV	54.0	-1.1	1.00 H	254	48.81	4.05
5	10620.00	58.1 PK	74.0	-15.9	1.08 H	297	43.17	14.92
6	10620.00	48.5 AV	54.0	-5.5	1.08 H	297	33.61	14.92

ANTENNA POLARITY & TEST DISTANCE: VERTICAL AT 3 M

NO.	FREQ. (MHz)	EMISSION LEVEL (dBuV/m)	LIMIT (dBuV/m)	MARGIN (dB)	ANTENNA HEIGHT (m)	TABLE ANGLE (Degree)	RAW VALUE (dBuV)	CORRECTION FACTOR (dB/m)
1	*5310.00	95.0 PK			1.02 V	205	91.05	3.91
2	*5310.00	85.2 AV			1.02 V	205	81.32	3.91
3	5350.00	60.9 PK	74.0	-13.1	1.02 V	205	56.89	4.05
4	5350.00	47.6 AV	54.0	-6.4	1.02 V	205	43.59	4.05
5	10620.00	57.0 PK	74.0	-17.0	1.26 V	197	42.11	14.92
6	10620.00	47.0 AV	54.0	-7.0	1.26 V	197	32.06	14.92

REMARKS:

1. Emission Level(dBuV/m) = Raw Value(dBuV) + Correction Factor(dB/m)
2. Correction Factor(dB/m) = Antenna Factor(dB/m) + Cable Factor(dB) – Pre-Amplifier Factor(dB)
3. The other emission levels were very low against the limit.
4. Margin value = Emission Level – Limit value
5. " * " : Fundamental frequency.



CHANNEL	TX Channel 102	DETECTOR FUNCTION	Peak (PK)
FREQUENCY RANGE	1GHz ~ 40GHz		Average (AV)

ANTENNA POLARITY & TEST DISTANCE: HORIZONTAL AT 3 M

NO.	FREQ. (MHz)	EMISSION LEVEL (dBuV/m)	LIMIT (dBuV/m)	MARGIN (dB)	ANTENNA HEIGHT (m)	TABLE ANGLE (Degree)	RAW VALUE (dBuV)	CORRECTION FACTOR (dB/m)
1	5460.00	60.0 PK	74.0	-14.0	1.09 H	198	53.35	6.63
2	5460.00	46.6 AV	54.0	-7.5	1.09 H	198	39.92	6.63
3	#5470.00	61.7 PK	74.0	-12.4	1.09 H	198	54.99	6.66
4	#5470.00	49.5 AV	54.0	-4.5	1.09 H	198	42.85	6.66
5	*5510.00	97.9 PK			1.09 H	198	91.13	6.74
6	*5510.00	88.0 AV			1.09 H	198	81.27	6.74
7	11020.00	56.9 PK	74.0	-17.1	1.00 H	243	43.17	13.72
8	11020.00	46.3 AV	54.0	-7.7	1.00 H	243	32.58	13.72

ANTENNA POLARITY & TEST DISTANCE: VERTICAL AT 3 M

NO.	FREQ. (MHz)	EMISSION LEVEL (dBuV/m)	LIMIT (dBuV/m)	MARGIN (dB)	ANTENNA HEIGHT (m)	TABLE ANGLE (Degree)	RAW VALUE (dBuV)	CORRECTION FACTOR (dB/m)
1	5460.00	59.0 PK	74.0	-15.0	1.11 V	247	52.33	6.63
2	5460.00	46.4 AV	54.0	-7.6	1.11 V	247	39.78	6.63
3	#5470.00	60.9 PK	74.0	-13.1	1.11 V	247	54.27	6.66
4	#5470.00	48.7 AV	54.0	-5.3	1.11 V	247	42.01	6.66
5	*5510.00	97.8 PK			1.11 V	247	91.07	6.74
6	*5510.00	87.9 AV			1.11 V	247	81.19	6.74
7	11020.00	56.6 PK	74.0	-17.5	1.24 V	217	42.83	13.72
8	11020.00	45.7 AV	54.0	-8.3	1.24 V	217	32.01	13.72

REMARKS:

- Emission Level(dBuV/m) = Raw Value(dBuV) + Correction Factor(dB/m)
- Correction Factor(dB/m) = Antenna Factor(dB/m) + Cable Factor(dB) – Pre-Amplifier Factor(dB)
- The other emission levels were very low against the limit.
- Margin value = Emission Level – Limit value
- " * ": Fundamental frequency.
- " # ": The radiated frequency is out of the restricted band.



CHANNEL	TX Channel 110	DETECTOR FUNCTION	Peak (PK)
FREQUENCY RANGE	1GHz ~ 40GHz		Average (AV)

ANTENNA POLARITY & TEST DISTANCE: HORIZONTAL AT 3 M

NO.	FREQ. (MHz)	EMISSION LEVEL (dBuV/m)	LIMIT (dBuV/m)	MARGIN (dB)	ANTENNA HEIGHT (m)	TABLE ANGLE (Degree)	RAW VALUE (dBuV)	CORRECTION FACTOR (dB/m)
1	*5550.00	101.6 PK			1.04 H	218	94.85	6.76
2	*5550.00	91.8 AV			1.04 H	218	85.08	6.76
3	11100.00	56.6 PK	74.0	-17.4	1.15 H	290	42.19	14.45
4	11100.00	46.4 AV	54.0	-7.6	1.15 H	290	31.94	14.45

ANTENNA POLARITY & TEST DISTANCE: VERTICAL AT 3 M

NO.	FREQ. (MHz)	EMISSION LEVEL (dBuV/m)	LIMIT (dBuV/m)	MARGIN (dB)	ANTENNA HEIGHT (m)	TABLE ANGLE (Degree)	RAW VALUE (dBuV)	CORRECTION FACTOR (dB/m)
1	*5550.00	98.5 PK			1.10 V	248	91.77	6.76
2	*5550.00	88.8 AV			1.10 V	248	82.03	6.76
3	11100.00	56.4 PK	74.0	-17.6	1.41 V	269	41.93	14.45
4	11100.00	46.5 AV	54.0	-7.5	1.41 V	269	32.08	14.45

REMARKS:

1. Emission Level(dBuV/m) = Raw Value(dBuV) + Correction Factor(dB/m)
2. Correction Factor(dB/m) = Antenna Factor(dB/m) + Cable Factor(dB) – Pre-Amplifier Factor(dB)
3. The other emission levels were very low against the limit.
4. Margin value = Emission Level – Limit value
5. " * ": Fundamental frequency.



CHANNEL	TX Channel 134	DETECTOR FUNCTION	Peak (PK)
FREQUENCY RANGE	1GHz ~ 40GHz		Average (AV)

ANTENNA POLARITY & TEST DISTANCE: HORIZONTAL AT 3 M								
NO.	FREQ. (MHz)	EMISSION LEVEL (dBuV/m)	LIMIT (dBuV/m)	MARGIN (dB)	ANTENNA HEIGHT (m)	TABLE ANGLE (Degree)	RAW VALUE (dBuV)	CORRECTION FACTOR (dB/m)
1	*5670.00	96.8 PK			1.04 H	220	90.39	6.41
2	*5670.00	88.1 AV			1.04 H	220	81.67	6.41
3	#5725.00	58.0 PK	74.0	-16.0	1.04 H	220	51.54	6.42
4	#5725.00	46.0 AV	54.0	-8.0	1.04 H	220	39.59	6.42
5	11340.00	58.6 PK	74.0	-15.4	1.21 H	247	43.58	15.04
6	11340.00	48.2 AV	54.0	-5.8	1.21 H	247	33.12	15.04

ANTENNA POLARITY & TEST DISTANCE: VERTICAL AT 3 M								
NO.	FREQ. (MHz)	EMISSION LEVEL (dBuV/m)	LIMIT (dBuV/m)	MARGIN (dB)	ANTENNA HEIGHT (m)	TABLE ANGLE (Degree)	RAW VALUE (dBuV)	CORRECTION FACTOR (dB/m)
1	*5670.00	93.2 PK			1.03 V	249	86.76	6.41
2	*5670.00	83.9 AV			1.03 V	249	77.53	6.41
3	#5725.00	57.4 PK	74.0	-16.6	1.03 V	249	50.94	6.42
4	#5725.00	45.5 AV	54.0	-8.5	1.03 V	249	39.10	6.42
5	11340.00	57.8 PK	74.0	-16.2	1.08 V	316	42.77	15.04
6	11340.00	47.2 AV	54.0	-6.8	1.08 V	316	32.13	15.04

REMARKS:

- Emission Level(dBuV/m) = Raw Value(dBuV) + Correction Factor(dB/m)
- Correction Factor(dB/m) = Antenna Factor(dB/m) + Cable Factor(dB) – Pre-Amplifier Factor(dB)
- The other emission levels were very low against the limit.
- Margin value = Emission Level – Limit value
- " * ": Fundamental frequency.
- " # ": The radiated frequency is out of the restricted band.



CHANNEL	TX Channel 151	DETECTOR FUNCTION	Peak (PK)
FREQUENCY RANGE	1GHz ~ 40GHz		Average (AV)

ANTENNA POLARITY & TEST DISTANCE: HORIZONTAL AT 3 M

NO.	FREQ. (MHz)	EMISSION LEVEL (dBuV/m)	LIMIT (dBuV/m)	MARGIN (dB)	ANTENNA HEIGHT (m)	TABLE ANGLE (Degree)	RAW VALUE (dBuV)	CORRECTION FACTOR (dB/m)
1	#5725.00	69.1 PK	78.2	-9.1	1.00 H	245	62.67	6.42
3	*5755.00	97.8 PK			1.00 H	245	91.17	6.63
4	*5755.00	88.3 AV			1.00 H	245	81.66	6.63
5	11510.00	58.5 PK	74.0	-15.5	1.18 H	237	42.91	15.58
6	11510.00	47.7 AV	54.0	-6.3	1.18 H	237	32.09	15.58

ANTENNA POLARITY & TEST DISTANCE: VERTICAL AT 3 M

NO.	FREQ. (MHz)	EMISSION LEVEL (dBuV/m)	LIMIT (dBuV/m)	MARGIN (dB)	ANTENNA HEIGHT (m)	TABLE ANGLE (Degree)	RAW VALUE (dBuV)	CORRECTION FACTOR (dB/m)
1	#5725.00	66.2 PK	78.2	-12.0	1.06 V	212	59.77	6.42
3	*5755.00	96.4 PK			1.06 V	212	89.79	6.63
4	*5755.00	86.9 AV			1.06 V	212	80.28	6.63
5	11510.00	57.6 PK	74.0	-16.4	1.24 V	308	42.03	15.58
6	11510.00	47.4 AV	54.0	-6.6	1.24 V	308	31.84	15.58

REMARKS:

1. Emission Level(dBuV/m) = Raw Value(dBuV) + Correction Factor(dB/m)
2. Correction Factor(dB/m) = Antenna Factor(dB/m) + Cable Factor(dB) – Pre-Amplifier Factor(dB)
3. The other emission levels were very low against the limit.
4. Margin value = Emission Level – Limit value
5. " * ": Fundamental frequency.
6. " # ": The radiated frequency is out of the restricted band.



CHANNEL	TX Channel 159	DETECTOR FUNCTION	Peak (PK)
FREQUENCY RANGE	1GHz ~ 40GHz		Average (AV)

ANTENNA POLARITY & TEST DISTANCE: HORIZONTAL AT 3 M								
NO.	FREQ. (MHz)	EMISSION LEVEL (dBuV/m)	LIMIT (dBuV/m)	MARGIN (dB)	ANTENNA HEIGHT (m)	TABLE ANGLE (Degree)	RAW VALUE (dBuV)	CORRECTION FACTOR (dB/m)
1	*5795.00	97.4 PK			1.40 H	248	90.43	6.93
2	*5795.00	87.8 AV			1.40 H	248	80.89	6.93
3	#5850.00	60.9 PK	74.0	-13.1	1.40 H	248	53.95	6.99
4	#5850.00	48.6 AV	54.0	-5.4	1.40 H	248	41.65	6.99
5	11590.00	57.6 PK	74.0	-16.4	1.03 H	284	42.88	14.76
6	11590.00	46.9 AV	54.0	-7.1	1.03 H	284	32.17	14.76
ANTENNA POLARITY & TEST DISTANCE: VERTICAL AT 3 M								
NO.	FREQ. (MHz)	EMISSION LEVEL (dBuV/m)	LIMIT (dBuV/m)	MARGIN (dB)	ANTENNA HEIGHT (m)	TABLE ANGLE (Degree)	RAW VALUE (dBuV)	CORRECTION FACTOR (dB/m)
1	*5795.00	93.7 PK			1.30 V	228	86.77	6.93
2	*5795.00	84.2 AV			1.30 V	228	77.26	6.93
3	#5850.00	57.6 PK	74.0	-16.5	1.30 V	228	50.56	6.99
4	#5850.00	46.0 AV	54.0	-8.0	1.30 V	228	39.01	6.99
5	11590.00	56.0 PK	74.0	-18.0	1.37 V	312	41.24	14.76
6	11590.00	46.3 AV	54.0	-7.7	1.37 V	312	31.57	14.76

REMARKS:

- Emission Level(dBuV/m) = Raw Value(dBuV) + Correction Factor(dB/m)
- Correction Factor(dB/m) = Antenna Factor(dB/m) + Cable Factor(dB) – Pre-Amplifier Factor(dB)
- The other emission levels were very low against the limit.
- Margin value = Emission Level – Limit value
- " * ": Fundamental frequency.
- " # ": The radiated frequency is out of the restricted band.

**BELOW 1GHz WORST-CASE DATA****802.11a**

CHANNEL	TX Channel 36	DETECTOR FUNCTION	Quasi-Peak (QP)
FREQUENCY RANGE	30MHz ~ 1GHz		

ANTENNA POLARITY & TEST DISTANCE: HORIZONTAL AT 3 M

NO.	FREQ. (MHz)	EMISSION LEVEL (dBuV/m)	LIMIT (dBuV/m)	MARGIN (dB)	ANTENNA HEIGHT (m)	TABLE ANGLE (Degree)	RAW VALUE (dBuV)	CORRECTION FACTOR (dB/m)
1	102.94	32.8 QP	43.5	-10.7	2.51 H	351	50.48	-17.67
2	148.97	41.5 QP	43.5	-2.1	2.26 H	185	54.97	-13.52
3	208.53	42.5 QP	43.5	-1.0	2.09 H	201	58.59	-16.06
4	294.96	43.5 QP	46.0	-2.5	2.41 H	128	55.70	-12.24
5	663.66	29.9 QP	46.0	-16.1	1.76 H	117	35.25	-5.32
6	811.04	39.9 QP	46.0	-6.1	1.00 H	211	42.69	-2.75

ANTENNA POLARITY & TEST DISTANCE: VERTICAL AT 3 M

NO.	FREQ. (MHz)	EMISSION LEVEL (dBuV/m)	LIMIT (dBuV/m)	MARGIN (dB)	ANTENNA HEIGHT (m)	TABLE ANGLE (Degree)	RAW VALUE (dBuV)	CORRECTION FACTOR (dB/m)
1	41.01	36.7 QP	40.0	-3.4	1.21 V	228	50.96	-14.31
2	149.02	37.3 QP	43.5	-6.2	1.00 V	292	50.76	-13.50
3	204.71	40.7 QP	43.5	-2.8	1.00 V	292	56.85	-16.17
4	294.96	33.6 QP	46.0	-12.4	1.65 V	85	45.87	-12.24
5	761.87	32.2 QP	46.0	-13.8	2.03 V	64	35.63	-3.46
6	811.04	33.1 QP	46.0	-12.9	2.73 V	255	35.89	-2.75

REMARKS:

1. Emission Level(dBuV/m) = Raw Value(dBuV) + Correction Factor(dB/m)
2. Correction Factor(dB/m) = Antenna Factor(dB/m) + Cable Factor(dB) – Pre-Amplifier Factor(dB)
3. The other emission levels were very low against the limit.
4. Margin value = Emission Level – Limit value



4.2 Conducted Emission Measurement

4.2.1 Limits of Conducted Emission Measurement

Frequency (MHz)	Conducted Limit (dBuV)	
	Quasi-peak	Average
0.15 - 0.5	66 - 56	56 - 46
0.50 - 5.0	56	46
5.0 - 30.0	60	50

Note: 1. The lower limit shall apply at the transition frequencies.

2. The limit decreases in line with the logarithm of the frequency in the range of 0.15 to 0.50MHz.

4.2.2 Test Instruments

Description & Manufacturer	Model No.	Serial No.	Cal. Date	Cal. Due
ROHDE & SCHWARZ TEST RECEIVER	ESCS 30	100290	Dec. 27, 2014	Dec. 26, 2015
ROHDE & SCHWARZ Artificial Mains Network (for EUT)	ESH2-Z5	100104	Dec. 07, 2015	Dec. 06, 2016
LISN With Adapter (for EUT)	AD10	C09Ada-001	Dec. 07, 2015	Dec. 06, 2016
ROHDE & SCHWARZ Artificial Mains Network (for peripherals)	ESH3-Z5	847265/023	Oct. 21, 2015	Oct. 20, 2016
SCHWARZBECK Artificial Mains Network (For EUT)	NNLK8129	8129229	May 06, 2015	May 05, 2016
Software	Cond_V7.3.7	NA	NA	NA
RF cable (JYEBAO) With 10dB PAD	5D-FB	Cable-C09.01	Feb. 24, 2015	Feb. 23, 2016
SUHNER Terminator (For ROHDE & SCHWARZ LISN)	65BNC-5001	E1-010789	May 19, 2015	May 18, 2016
ROHDE & SCHWARZ Artificial Mains Network (For TV EUT)	ESH3-Z5	100220	Nov. 13, 2015	Nov. 12, 2016
LISN With Adapter (for TV EUT)	100220	N/A	Nov. 13, 2015	Nov. 12, 2016

Notes: 1. The calibration interval of the above test instruments is 12 months and the calibrations are traceable to NML/ROC and NIST/USA.

2. The test was performed in Shielded Room No. 9.

3. The VCCI Site Registration No. C-1312.

4.2.3 Test Procedure

- The EUT was placed 0.4 meters from the conducting wall of the shielded room with EUT being connected to the power mains through a line impedance stabilization network (LISN). Other support units were connected to the power mains through another LISN. The two LISNs provide 50 ohm/ 50uH of coupling impedance for the measuring instrument.
- Both lines of the power mains connected to the EUT were checked for maximum conducted interference.
- The frequency range from 150kHz to 30MHz was searched. Emission levels under (Limit - 20dB) was not recorded.

NOTE: All modes of operation were investigated and the worst-case emissions are reported.

4.2.4 Deviation from Test Standard

No deviation.

4.2.5 Test Setup

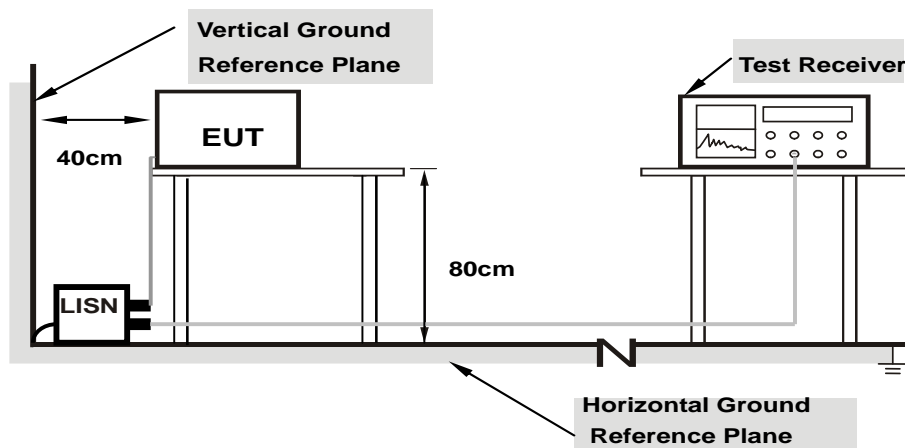

Note: Support units were connected to second LISN.

For the actual test configuration, please refer to the attached file (Test Setup Photo).

4.2.6 EUT Operating Condition

Same as item 4.1.6.

4.2.7 Test Results

Frequency Range	150kHz ~ 30MHz	Detector Function & Resolution Bandwidth	Quasi-Peak (QP) / Average (AV), 9kHz
------------------------	----------------	---	--------------------------------------

Phase Of Power : Line (L)										
No	Frequency (MHz)	Correction Factor (dB)	Reading Value (dBuV)		Emission Level (dBuV)		Limit (dBuV)		Margin (dB)	
			Q.P.	AV.	Q.P.	AV.	Q.P.	AV.	Q.P.	AV.
1	0.15000	0.16	41.68	22.03	41.84	22.19	66.00	56.00	-24.16	-33.81
2	0.33359	0.20	27.92	20.42	28.12	20.62	59.36	49.36	-31.24	-28.74
3	0.79063	0.26	17.76	11.41	18.02	11.67	56.00	46.00	-37.98	-34.33
4	1.92051	0.34	18.52	14.29	18.86	14.63	56.00	46.00	-37.14	-31.37
5	4.22522	0.43	22.03	20.16	22.46	20.59	56.00	46.00	-33.54	-25.41
6	13.44199	0.77	26.13	21.88	26.90	22.65	60.00	50.00	-33.10	-27.35

Remarks:

1. Q.P. and AV. are abbreviations of quasi-peak and average individually.
2. The emission levels of other frequencies were very low against the limit.
3. Margin value = Emission level – Limit value
4. Correction factor = Insertion loss + Cable loss
5. Emission Level = Correction Factor + Reading Value

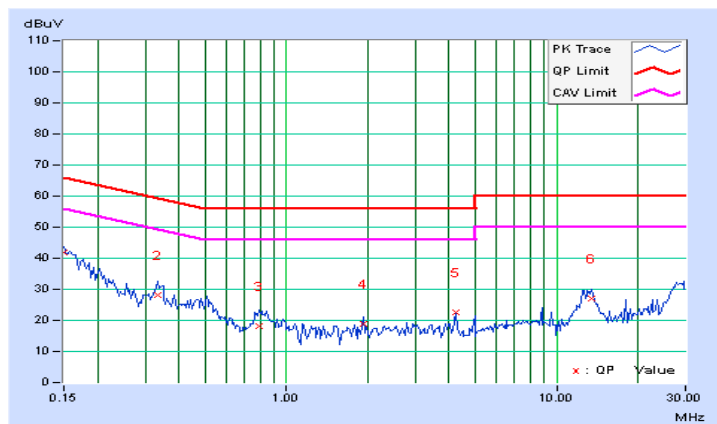

Frequency Range	150kHz ~ 30MHz	Detector Function & Resolution Bandwidth	Quasi-Peak (QP) / Average (AV), 9kHz
------------------------	----------------	---	--------------------------------------

Phase Of Power : Neutral (N)										
No	Frequency (MHz)	Correction Factor (dB)	Reading Value (dBuV)		Emission Level (dBuV)		Limit (dBuV)		Margin (dB)	
			Q.P.	AV.	Q.P.	AV.	Q.P.	AV.	Q.P.	AV.
1	0.15391	0.29	40.41	23.45	40.70	23.74	65.79	55.79	-25.08	-32.04
2	0.33750	0.35	30.75	23.12	31.10	23.47	59.26	49.26	-28.16	-25.79
3	0.81016	0.41	17.52	10.32	17.93	10.73	56.00	46.00	-38.07	-35.27
4	1.92188	0.48	17.71	13.84	18.19	14.32	56.00	46.00	-37.81	-31.68
5	4.22521	0.52	23.14	20.58	23.66	21.10	56.00	46.00	-32.34	-24.90
6	13.44141	0.62	26.56	22.27	27.18	22.89	60.00	50.00	-32.82	-27.11

Remarks:

1. Q.P. and AV. are abbreviations of quasi-peak and average individually.
2. The emission levels of other frequencies were very low against the limit.
3. Margin value = Emission level – Limit value
4. Correction factor = Insertion loss + Cable loss
5. Emission Level = Correction Factor + Reading Value

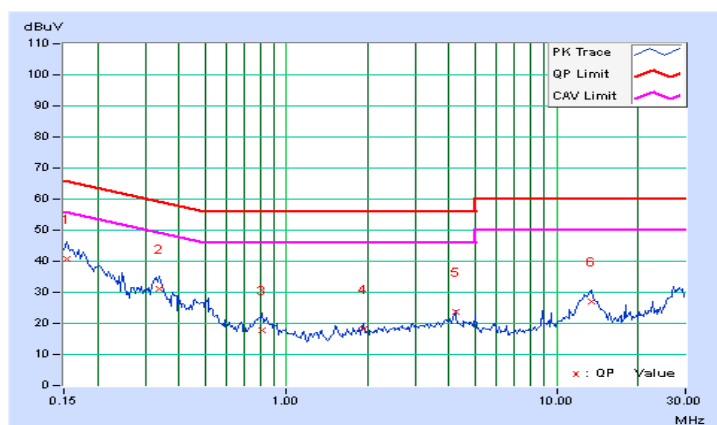

4.3 Transmit Power Measurement

4.3.1 Limits of Transmit Power Measurement

Operation Band	EUT Category		LIMIT
U-NII-1		Outdoor Access Point	1 Watt (30 dBm) (Max. e.i.r.p \leq 125mW(21 dBm) at any elevation angle above 30 degrees as measured from the horizon)
		Fixed point-to-point Access Point	1 Watt (30 dBm)
		Indoor Access Point	1 Watt (30 dBm)
	√	Mobile and Portable client device	250mW (24 dBm)
U-NII-2A		√	250mW (24 dBm) or 11 dBm+10 log B*
U-NII-2C		√	250mW (24 dBm) or 11 dBm+10 log B*
U-NII-3		√	1 Watt (30 dBm)

*B is the 26 dB emission bandwidth in megahertz

Per KDB 662911 Method of conducted output power measurement on IEEE 802.11 devices,

Array Gain = 0 dB (i.e., no array gain) for $N_{ANT} \leq 4$;

Array Gain = 0 dB (i.e., no array gain) for channel widths ≥ 40 MHz for any N_{ANT} ;

Array Gain = $5 \log(N_{ANT}/N_{SS})$ dB or 3 dB, whichever is less for 20-MHz channel widths with $N_{ANT} \geq 5$.

For power measurements on all other devices: Array Gain = $10 \log(N_{ANT}/N_{SS})$ dB.

4.3.2 Test Setup

FOR POWER OUTPUT MEASUREMENT

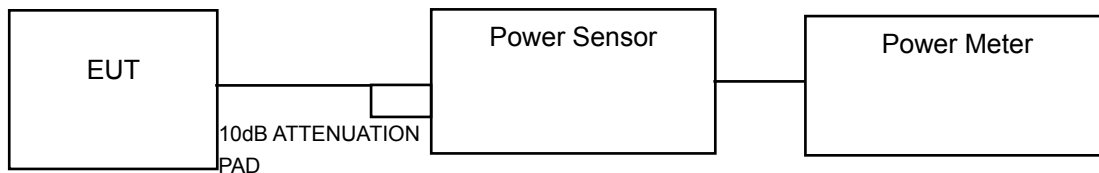

FOR 26dB & OCCUPIED BANDWIDTH

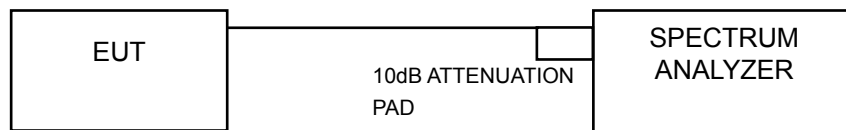

4.3.3 Test Instruments

Refer to section 4.1.2 to get information of above instrument.

4.3.4 Test Procedure

FOR AVERAGE POWER MEASUREMENT

Method PM is used to perform output power measurement, trigger and gating function of wide band power meter is enabled to measure max output power of TX on burst. Duty factor is not added to measured value.

FOR 26 BANDWIDTH

- 1) Set RBW = approximately 1% of the emission bandwidth.
- 2) Set the VBW > RBW.
- 3) Detector = Peak.
- 4) Trace mode = max hold.
- 5) Measure the maximum width of the emission that is 26 dB down from the peak of the emission. Compare this with the RBW setting of the analyzer. Readjust RBW and repeat measurement as needed until the RBW/EBW ratio is approximately 1%.

FOR OCCUPIED BANDWIDTH

The transmitter output was connected to the spectrum analyzer through an attenuator. The bandwidth of the fundamental frequency was measured by spectrum analyzer with resolution bandwidth in the range of 1% to 5% of the anticipated emission bandwidth, and a video bandwidth at least 3x the resolution bandwidth and set the detector to AVERAGE. The width of a frequency band such that, below the lower and above the upper frequency limits, the mean powers emitted are each equal to a specified percentage 0.5 % of the total mean power of a given emission.

4.3.5 Deviation from Test Standard

No deviation.

4.3.6 EUT Operating Condition

The software provided by client to enable the EUT under transmission condition continuously at lowest, middle and highest channel frequencies individually.

4.3.7 Test Result

POWER OUTPUT:

802.11a

CHAN.	FREQ. (MHz)	MAXIMUM CONDUCTED POWER (mW)	MAXIMUM CONDUCTED POWER (dBm)	POWER LIMIT (dBm)	PASS / FAIL
36	5180	22.0	13.42	24	PASS
40	5200	20.2	13.05	24	PASS
48	5240	20.5	13.11	24	PASS
52	5260	20.0	13.02	24	PASS
60	5300	20.4	13.09	24	PASS
64	5320	20.0	13.00	24	PASS
100	5500	20.1	13.04	24	PASS
116	5580	20.0	13.02	24	PASS
140	5700	20.0	13.00	24	PASS
149	5745	20.0	13.02	30	PASS
157	5785	20.8	13.18	30	PASS
165	5825	20.1	13.04	30	PASS

NOTE:

For U-NII-2A, U-NII-2C Band:

1. $11\text{dBm} + 10\log (25.36) = 25.04 > 24\text{dBm}$
2. $11\text{dBm} + 10\log (23.39) = 24.69 > 24\text{dBm}$
3. $11\text{dBm} + 10\log (23.00) = 24.62 > 24\text{dBm}$
4. $11\text{dBm} + 10\log (23.41) = 24.69 > 24\text{dBm}$
5. $11\text{dBm} + 10\log (25.57) = 25.08 > 24\text{dBm}$
6. $11\text{dBm} + 10\log (20.51) = 24.12 > 24\text{dBm}$

802.11n (20MHz)

CHAN.	FREQ. (MHz)	MAXIMUM CONDUCTED POWER (mW)	MAXIMUM CONDUCTED POWER (dBm)	POWER LIMIT (dBm)	PASS / FAIL
36	5180	13.6	11.33	24	PASS
40	5200	13.8	11.41	24	PASS
48	5240	14.3	11.54	24	PASS
52	5260	13.9	11.42	24	PASS
60	5300	14.0	11.45	24	PASS
64	5320	13.1	11.18	24	PASS
100	5500	13.3	11.24	24	PASS
116	5580	13.8	11.41	24	PASS
140	5700	12.6	11.02	24	PASS
149	5745	12.6	11.00	30	PASS
157	5785	13.2	11.22	30	PASS
165	5825	13.4	11.28	30	PASS

NOTE:
For U-NII-2A, U-NII-2C Band:

1. $11\text{dBm} + 10\log (25.67) = 25.09 > 24\text{dBm}$
2. $11\text{dBm} + 10\log (22.41) = 24.50 > 24\text{dBm}$
3. $11\text{dBm} + 10\log (20.79) = 24.18 > 24\text{dBm}$
4. $11\text{dBm} + 10\log (20.73) = 24.17 > 24\text{dBm}$
5. $11\text{dBm} + 10\log (20.94) = 24.21 > 24\text{dBm}$
6. $11\text{dBm} + 10\log (20.69) = 24.16 > 24\text{dBm}$

802.11n (40MHz)

CHAN.	FREQ. (MHz)	MAXIMUM CONDUCTED POWER (mW)	MAXIMUM CONDUCTED POWER (dBm)	POWER LIMIT (dBm)	PASS / FAIL
38	5190	12.8	11.08	24	PASS
46	5230	13.3	11.25	24	PASS
54	5270	13.2	11.21	24	PASS
62	5310	13.3	11.24	24	PASS
102	5510	12.6	11.02	24	PASS
110	5550	12.6	11.00	24	PASS
134	5670	12.7	11.05	24	PASS
151	5755	13.0	11.14	30	PASS
159	5795	12.6	11.02	30	PASS

NOTE:
For U-NII-2A, U-NII-2C Band:

1. $11\text{dBm} + 10\log (51.75) = 28.14 > 24\text{dBm}$
2. $11\text{dBm} + 10\log (42.47) = 27.28 > 24\text{dBm}$
3. $11\text{dBm} + 10\log (42.41) = 27.27 > 24\text{dBm}$
4. $11\text{dBm} + 10\log (42.30) = 27.26 > 24\text{dBm}$
5. $11\text{dBm} + 10\log (42.31) = 27.26 > 24\text{dBm}$

26dB BANDWIDTH:
802.11a

CHANNEL	CHANNEL FREQUENCY (MHz)	26dBc BANDWIDTH (MHz)	PASS / FAIL
52	5260	25.36	PASS
60	5300	23.39	PASS
64	5320	23.00	PASS
100	5500	23.41	PASS
116	5580	25.57	PASS
140	5700	20.51	PASS

802.11n (20MHz)

CHANNEL	CHANNEL FREQUENCY (MHz)	26dBc BANDWIDTH (MHz)	PASS / FAIL
52	5260	25.67	PASS
60	5300	22.41	PASS
64	5320	20.79	PASS
100	5500	20.73	PASS
116	5580	20.94	PASS
140	5700	20.69	PASS

802.11n (40MHz)

CHANNEL	CHANNEL FREQUENCY (MHz)	26dBc BANDWIDTH (MHz)	PASS / FAIL
54	5270	51.75	PASS
62	5310	42.47	PASS
102	5510	42.41	PASS
110	5550	42.30	PASS
134	5670	42.31	PASS

SPECTRUM PLOT OF WORST VALUE

802.11a

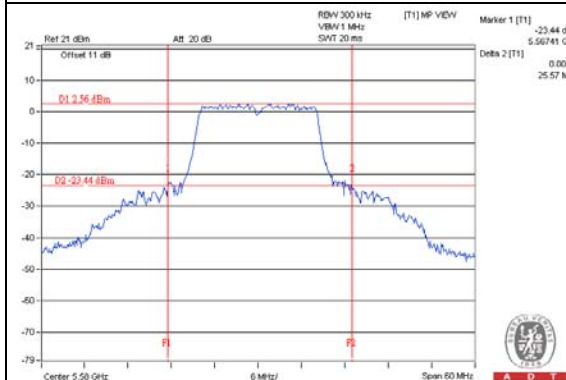

802.11n (20MHz)

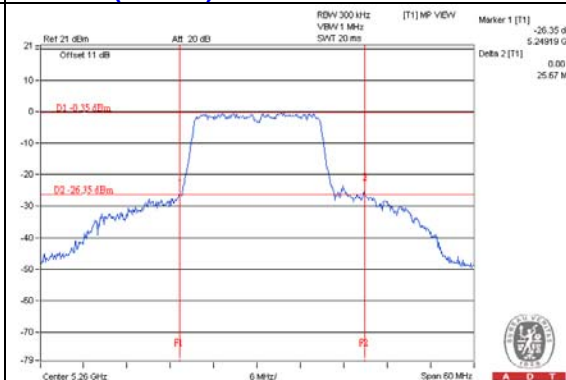

802.11n (40MHz)

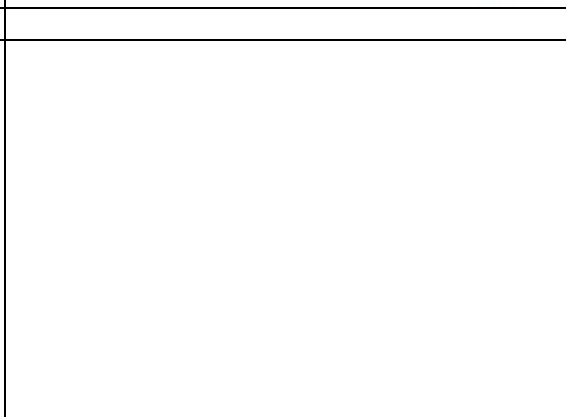
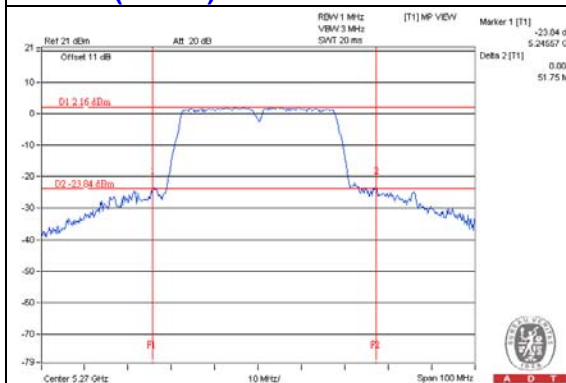

OCCUPIED BANDWIDTH:
802.11a

CHANNEL	CHANNEL FREQUENCY (MHz)	OCCUPIED BANDWIDTH (MHz)	PASS / FAIL
36	5180	16.92	PASS
40	5200	16.80	PASS
48	5240	16.92	PASS
52	5260	16.80	PASS
60	5300	16.80	PASS
64	5320	16.80	PASS
100	5500	16.92	PASS
116	5580	16.80	PASS
132	5660	16.68	PASS
140	5700	16.80	PASS
149	5745	16.80	PASS
157	5785	16.92	PASS
165	5825	16.92	PASS

802.11n (20MHz)

CHANNEL	CHANNEL FREQUENCY (MHz)	OCCUPIED BANDWIDTH (MHz)	PASS / FAIL
36	5180	18.00	PASS
40	5200	18.00	PASS
48	5240	18.00	PASS
52	5260	18.00	PASS
60	5300	18.12	PASS
64	5320	17.88	PASS
100	5500	17.88	PASS
116	5580	18.00	PASS
132	5660	18.00	PASS
140	5700	18.00	PASS
149	5745	18.00	PASS
157	5785	18.00	PASS
165	5825	17.88	PASS

802.11n (40MHz)

CHANNEL	CHANNEL FREQUENCY (MHz)	OCCUPIED BANDWIDTH (MHz)	PASS / FAIL
38	5190	36.80	PASS
46	5230	36.80	PASS
54	5270	36.80	PASS
62	5310	37.00	PASS
102	5510	37.00	PASS
110	5550	36.60	PASS
134	5670	36.80	PASS
151	5755	36.80	PASS
159	5795	37.00	PASS

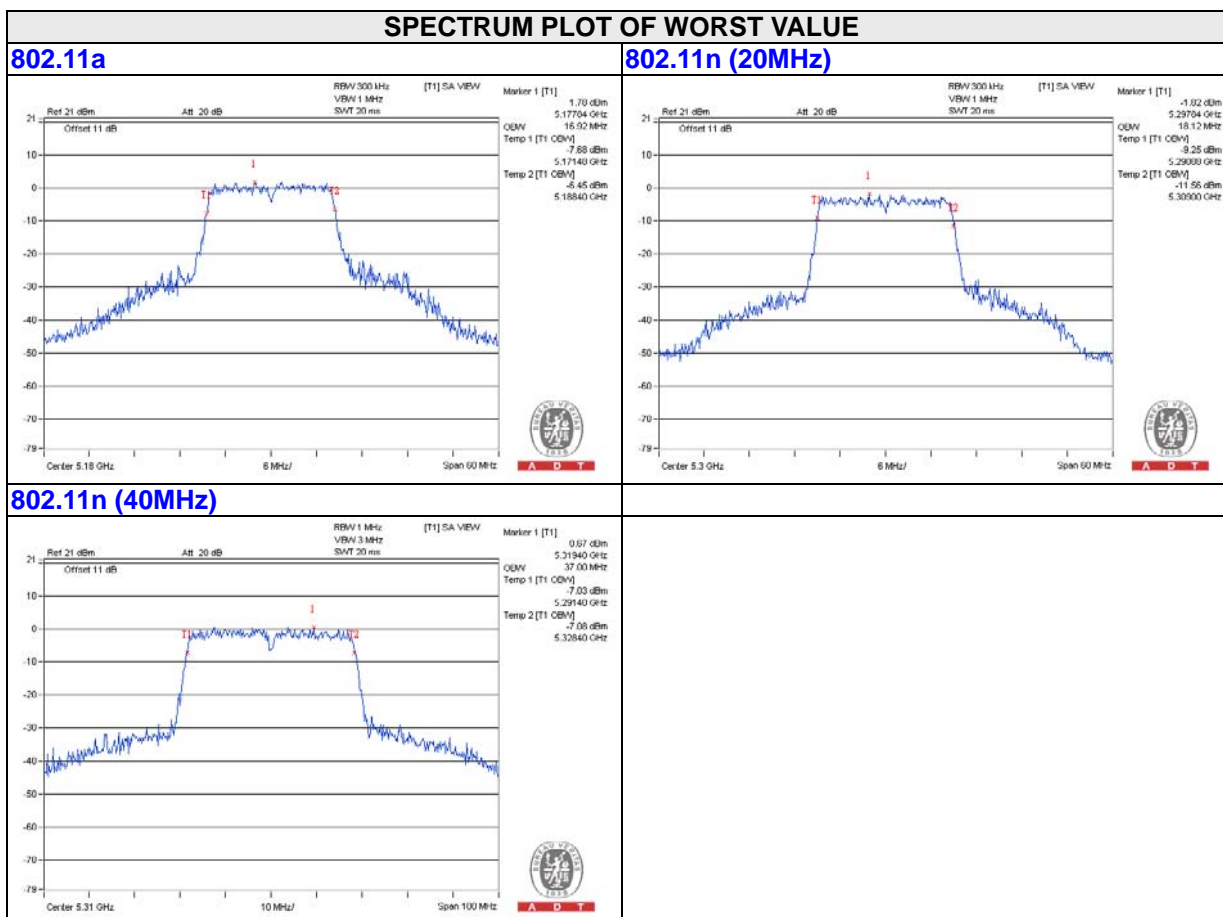

EUT MAXIMUM CONDUCTED POWER**802.11a**

FREQUENCY BAND (MHz)	MAX. POWER	
	OUTPUT POWER (mW)	OUTPUT POWER (dBm)
5250~5350	20.4	13.09
5470~5725	20.1	13.04

NOTE: Manufacturer provides Transmit Power Control description to meet this requirement.

802.11n (20MHz)

FREQUENCY BAND (MHz)	MAX. POWER	
	OUTPUT POWER (mW)	OUTPUT POWER (dBm)
5250~5350	14.0	11.45
5470~5725	13.8	11.41

NOTE: Manufacturer provides Transmit Power Control description to meet this requirement.

802.11n (40MHz)

FREQUENCY BAND (MHz)	MAX. POWER	
	OUTPUT POWER (mW)	OUTPUT POWER (dBm)
5250~5350	13.3	11.24
5470~5725	12.7	11.05

NOTE: Manufacturer provides Transmit Power Control description to meet this requirement.

4.4 Peak Power Spectral Density Measurement

4.4.1 Limits of Peak Power Spectral Density Measurement

Operation Band	EUT Category		LIMIT
U-NII-1		Outdoor Access Point	17dBm/ MHz
		Fixed point-to-point Access Point	
		Indoor Access Point	
	√	Mobile and Portable client device	11dBm/ MHz
U-NII-2A		√	11dBm/ MHz
U-NII-2C		√	11dBm/ MHz
U-NII-3		√	30dBm/ 500kHz

4.4.2 Test Setup

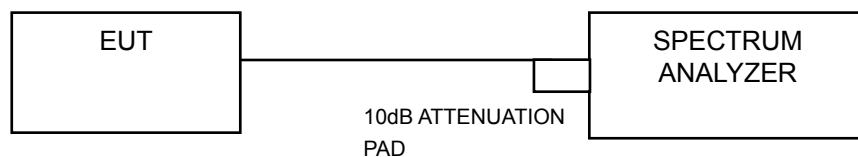

4.4.3 Test Instruments

Refer to section 4.1.2 to get information of above instrument.

4.4.4 Test Procedure

For U-NII-1, U-NII-2A, U-NII-2C band:

Using method SA-1

- 1) Set span to encompass the entire emission bandwidth (EBW) of the signal.
- 2) Set RBW = 1 MHz, Set VBW \geq 3 MHz, Detector = RMS
- 3) Sweep time = auto, trigger set to "free run".
- 4) Trace average at least 100 traces in power averaging mode.
- 5) Record the max value

For U-NII-3 band:

- 1) Set span to encompass the entire emission bandwidth (EBW) of the signal.
- 2) Set RBW = 500 kHz, Set VBW \geq 3 RBW, Detector = RMS
- 3) Sweep time = auto, trigger set to "free run".
- 4) Trace average at least 100 traces in power averaging mode.
- 5) Record the max value

4.4.5 Deviation from Test Standard

No deviation.

4.4.6 EUT Operating Condition

Same as Item 4.3.6.

4.4.7 Test Results

For U-NII-1, U-NII-2A, U-NII-2C Band

802.11a

CHANNEL	FREQUENCY (MHz)	PSD (dBm)	MAXIMUM LIMIT (dBm)	PASS/FAIL
36	5180	-1.58	11	PASS
40	5200	-2.64	11	PASS
48	5240	-2.17	11	PASS
52	5260	-1.77	11	PASS
60	5300	-1.29	11	PASS
64	5320	-1.81	11	PASS
100	5500	-1.64	11	PASS
116	5580	-1.04	11	PASS
140	5700	-2.52	11	PASS

802.11n (20MHz)

CHANNEL	FREQUENCY (MHz)	PSD (dBm)	MAXIMUM LIMIT (dBm)	PASS/FAIL
36	5180	-3.96	11	PASS
40	5200	-3.69	11	PASS
48	5240	-3.43	11	PASS
52	5260	-3.09	11	PASS
60	5300	-3.18	11	PASS
64	5320	-3.81	11	PASS
100	5500	-3.56	11	PASS
116	5580	-3.23	11	PASS
140	5700	-4.52	11	PASS

802.11n (40MHz)

CHANNEL	FREQUENCY (MHz)	PSD (dBm)	MAXIMUM LIMIT (dBm)	PASS/FAIL
38	5190	-6.71	11	PASS
46	5230	-6.39	11	PASS
54	5270	-6.37	11	PASS
62	5310	-6.81	11	PASS
102	5510	-6.95	11	PASS
110	5550	-6.66	11	PASS
134	5670	-7.77	11	PASS

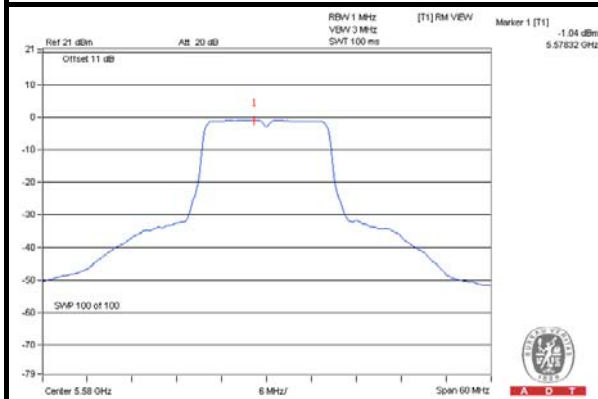
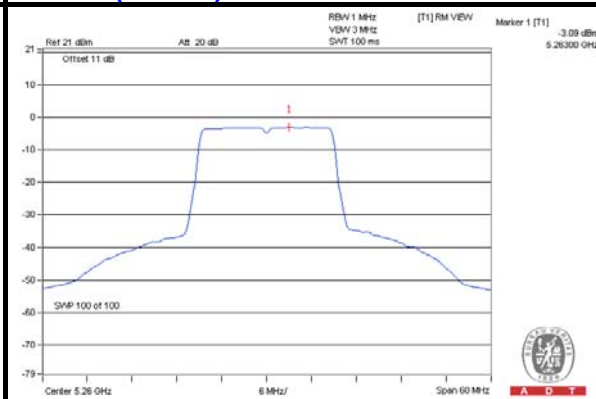
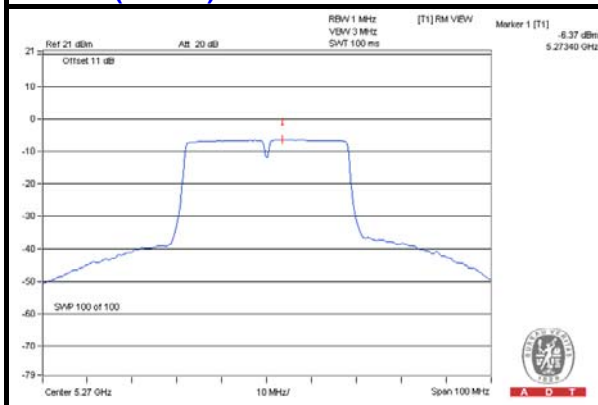
SPECTRUM PLOT OF WORST VALUE**802.11a****802.11n (20 MHz)****802.11n (40MHz)**

For U-NII-3 Band**802.11a**

Channel	Freq. (MHz)	PSD (dBm/500kHz)	Limit (dBm/500kHz)	PASS /FAIL
149	5745	3.85	30	PASS
157	5785	4.77	30	PASS
165	5825	4.25	30	PASS

802.11n (20MHz)

Channel	Freq. (MHz)	PSD (dBm/500kHz)	Limit (dBm/500kHz)	PASS /FAIL
149	5745	1.77	30	PASS
157	5785	2.74	30	PASS
165	5825	2.55	30	PASS

802.11n (40MHz)

Channel	Freq. (MHz)	PSD (dBm/500kHz)	Limit (dBm/500kHz)	PASS /FAIL
151	5755	-0.15	30	PASS
159	5795	-0.36	30	PASS

SPECTRUM PLOT OF WORST VALUE

802.11a

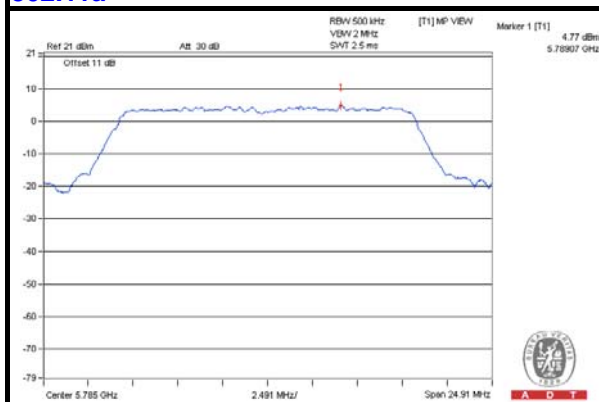

802.11n (20MHz)

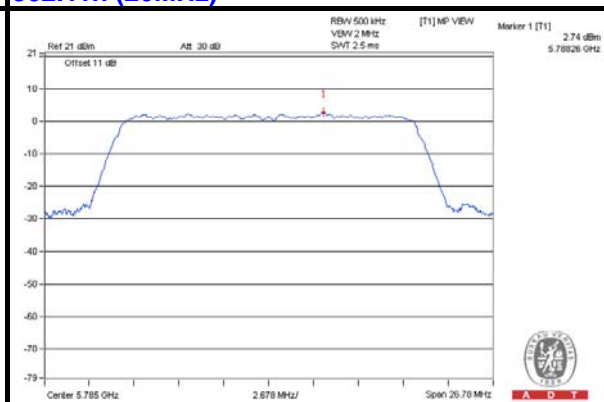

802.11n (40MHz)

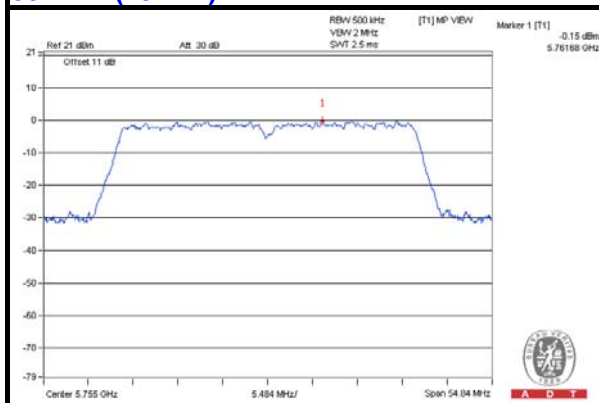

4.5 Frequency Stability Measurement

4.5.1 Limits of Frequency Stability Measurement

The frequency of the carrier signal shall be maintained within band of operation

4.5.2 Test Setup

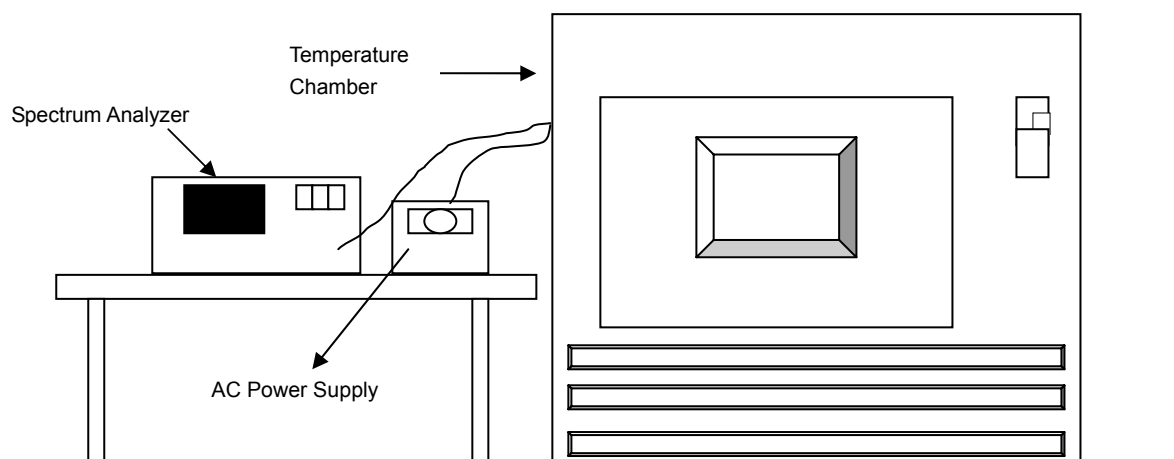

4.5.3 Test Instruments

Refer to section 4.1.2 to get information of above instrument.

4.5.4 Test Procedure

- The EUT was placed inside the environmental test chamber and powered by nominal AC voltage.
- Turn the EUT on and couple its output to a spectrum analyzer.
- Turn the EUT off and set the chamber to the highest temperature specified.
- Allow sufficient time (approximately 30 min) for the temperature of the chamber to stabilize, turn the EUT on and measure the operating frequency after 2, 5, and 10 minutes.
- Repeat step 2 and 3 with the temperature chamber set to the lowest temperature.
- The test chamber was allowed to stabilize at +20 degree C for a minimum of 30 minutes. The supply voltage was then adjusted on the EUT from 85% to 115% and the frequency record.

4.5.5 Deviation from Test Standard

No deviation.

4.5.6 EUT Operating Condition

Set the EUT transmit at un-modulation mode to test frequency stability.

4.5.7 Test Results

FREQUENCY STABILITY VERSUS TEMP.									
OPERATING FREQUENCY: 5180MHz									
TEMP. (°C)	POWER SUPPLY (Vac)	0 MINUTE		2 MINUTE		5 MINUTE		10 MINUTE	
		Measured Frequency (MHz)	Frequency Drift (ppm)	Measured Frequency (MHz)	Frequency Drift (ppm)	Measured Frequency (MHz)	Frequency Drift (ppm)	Measured Frequency (MHz)	Frequency Drift (ppm)
50	120	5180.042446	8.1942302	5180.042803	8.2630537	5180.042529	8.2102790	5180.042948	8.2911540
40	120	5180.042571	8.2183868	5180.042766	8.2559323	5180.042819	8.2661853	5180.042806	8.2637099
30	120	5180.042935	8.2885181	5180.042873	8.2765616	5180.042743	8.2514681	5180.0429	8.2818994
20	120	5180.042709	8.2449761	5180.042631	8.2298580	5180.042931	8.2878639	5180.042954	8.2923164
10	120	5180.043356	8.3699784	5180.04305	8.3108682	5180.042867	8.2755705	5180.043329	8.3647076
0	120	5180.042898	8.2813749	5180.043109	8.3222735	5180.042716	8.2463261	5180.042766	8.2560385
-10	120	5180.042577	8.2195410	5180.042726	8.2482636	5180.042412	8.1876281	5180.042599	8.2237507
-20	120	5180.042812	8.2649152	5180.043287	8.3566485	5180.042886	8.2792189	5180.043248	8.3490677

FREQUENCY STABILITY VERSUS VOLTAGE									
OPERATING FREQUENCY: 5180MHz									
TEMP. (°C)	POWER SUPPLY (Vac)	0 MINUTE		2 MINUTE		5 MINUTE		10 MINUTE	
		Measured Frequency (MHz)	Frequency Drift (ppm)	Measured Frequency (MHz)	Frequency Drift (ppm)	Measured Frequency (MHz)	Frequency Drift (ppm)	Measured Frequency (MHz)	Frequency Drift (ppm)
20	138	5180.042935	8.2886831	5180.042756	8.2540417	5180.042677	8.2388990	5180.042982	8.2977178
	120	5180.042709	8.2449761	5180.042631	8.2298580	5180.042931	8.2878639	5180.042954	8.2923164
	102	5180.043064	8.3134808	5180.042788	8.2602843	5180.042906	8.2830344	5180.042854	8.2730456

4.6 6dB Bandwidth Measurement

4.6.1 Limits of 6dB Bandwidth Measurement

The minimum of 6dB Bandwidth Measurement is 0.5MHz.

4.6.2 Test Setup

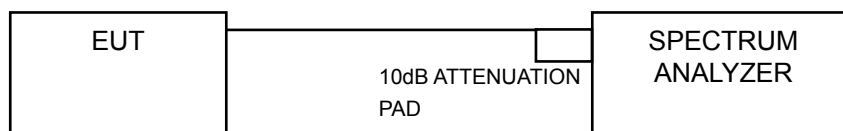

4.6.3 Test Instruments

Refer to section 4.1.2 to get information of above instrument.

4.6.4 Test Procedure

MEASUREMENT PROCEDURE REF

- Set resolution bandwidth (RBW) = 100kHz
- Set the video bandwidth (VBW) $\geq 3 \times$ RBW, Detector = Peak.
- Trace mode = max hold.
- Sweep = auto couple.
- Measure the maximum width of the emission that is constrained by the frequencies associated with the two amplitude points (upper and lower) that are attenuated by 6 dB relative to the maximum level measured in the fundamental emission

4.6.5 Deviation from Test Standard

No deviation.

4.6.6 EUT Operating Condition

The software provided by client to enable the EUT under transmission condition continuously at lowest, middle and highest channel frequencies individually.

4.6.7 Test Results

802.11a

CHANNEL	FREQUENCY (MHz)	6dB BANDWIDTH (MHz)	MINIMUM LIMIT (MHz)	PASS / FAIL
149	5745	16.62	0.5	PASS
157	5785	16.58	0.5	PASS
165	5825	16.59	0.5	PASS

802.11n (20MHz)

CHANNEL	FREQUENCY (MHz)	6dB BANDWIDTH (MHz)	MINIMUM LIMIT (MHz)	PASS / FAIL
149	5745	17.83	0.5	PASS
157	5785	17.88	0.5	PASS
165	5825	17.86	0.5	PASS

802.11n (40MHz)

CHANNEL	FREQUENCY (MHz)	6dB BANDWIDTH (MHz)	MINIMUM LIMIT (MHz)	PASS / FAIL
151	5755	36.63	0.5	PASS
159	5795	36.55	0.5	PASS

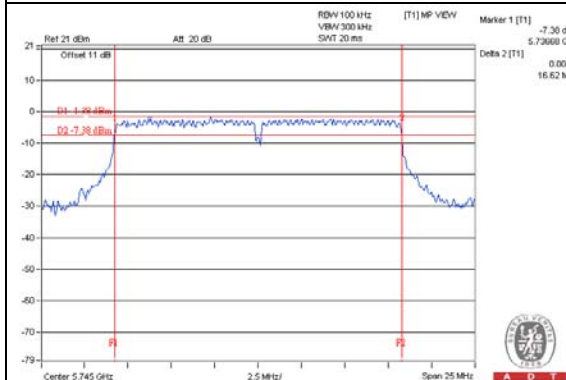
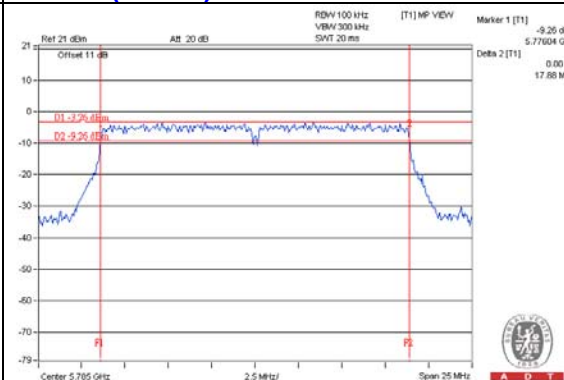
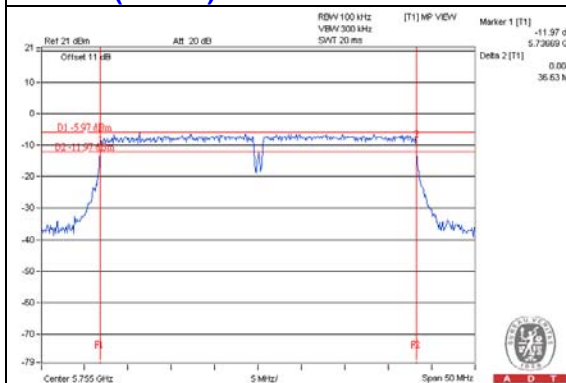
SPECTRUM PLOT OF WORST VALUE**802.11a****802.11n (20MHz)****802.11n (40MHz)**

5 Pictures of Test Arrangements

Please refer to the attached file (Test Setup Photo).





Appendix – Information on the Testing Laboratories

We, Bureau Veritas Consumer Products Services (H.K.) Ltd., Taoyuan Branch, were founded in 1988 to provide our best service in EMC, Radio, Telecom and Safety consultation. Our laboratories are accredited and approved according to ISO/IEC 17025.

If you have any comments, please feel free to contact us at the following:

Linko EMC/RF Lab

Tel: 886-2-26052180

Fax: 886-2-26051924

Hsin Chu EMC/RF Lab/Telecom Lab

Tel: 886-3-6668565

Fax: 886-3-6668323

Hwa Ya EMC/RF/Safety

Tel: 886-3-3183232

Fax: 886-3-3270892

Email: service.adt@tw.bureauveritas.com

Web Site: www.bureauveritas-adt.com

The address and road map of all our labs can be found in our web site also.

--- END ---