

## FCC Test Report

**Report No.:** RF140729D01A-1

**FCC ID:** WLQOMNISB1PLUSTX

**Test Model:** Omni SB1 Plus Soundbar

**Received Date:** Dec. 10, 2015

**Test Date:** Dec. 14 ~ 17, 2015

**Issued Date:** Dec. 22, 2015

**Applicant:** Polk Audio

**Address:** 5601 Metro Drive Baltimore Maryland 21215 United States

**Issued By:** Bureau Veritas Consumer Products Services (H.K.) Ltd., Taoyuan Branch

**Lab Address:** No. 47-2, 14th Ling, Chia Pau Vil., Lin Kou Dist., New Taipei City, Taiwan (R.O.C.)



This report is for your exclusive use. Any copying or replication of this report to or for any other person or entity, or use of our name or trademark, is permitted only with our prior written permission. This report sets forth our findings solely with respect to the test samples identified herein. The results set forth in this report are not indicative or representative of the quality or characteristics of the lot from which a test sample was taken or any similar or identical product unless specifically and expressly noted. Our report includes all of the tests requested by you and the results thereof based upon the information that you provided to us. You have 60 days from date of issuance of this report to notify us of any material error or omission caused by our negligence, provided, however, that such notice shall be in writing and shall specifically address the issue you wish to raise. A failure to raise such issue within the prescribed time shall constitute your unqualified acceptance of the completeness of this report, the tests conducted and the correctness of the report contents. Unless specific mention, the uncertainty of measurement has been explicitly taken into account to declare the compliance or non-compliance to the specification. The report must not be used by the client to claim product certification, approval, or endorsement by TAF or any government agencies.



## Table of Contents

<b>Release Control Record</b> .....	<b>4</b>
<b>1 Certificate of Conformity</b> .....	<b>5</b>
<b>2 Summary of Test Results</b> .....	<b>6</b>
2.1 Measurement Uncertainty .....	6
2.2 Modification Record .....	6
<b>3 General Information</b> .....	<b>7</b>
3.1 General Description of EUT .....	7
3.2 Description of Test Modes .....	8
3.2.1 Test Mode Applicability and Tested Channel Detail .....	9
3.3 Duty Cycle of Test Signal .....	10
3.4 Description of Support Units .....	11
3.4.1 Configuration of System under Test .....	11
3.5 General Description of Applied Standards .....	11
<b>4 Test Types and Results</b> .....	<b>12</b>
4.1 Radiated Emission and Bandedge Measurement.....	12
4.1.1 Limits of Radiated Emission and Bandedge Measurement .....	12
4.1.2 Test Instruments .....	13
4.1.3 Test Procedures.....	14
4.1.4 Deviation from Test Standard .....	14
4.1.5 Test Set Up .....	15
4.1.6 EUT Operating Conditions.....	15
4.1.7 Test Results .....	16
4.2 Conducted Emission Measurement .....	20
4.2.1 Limits of Conducted Emission Measurement .....	20
4.2.2 Test Instruments .....	20
4.2.3 Test Procedures.....	21
4.2.4 Deviation from Test Standard .....	21
4.2.5 Test Setup.....	21
4.2.6 EUT Operating Conditions.....	21
4.2.7 Test Results .....	22
4.3 6dB Bandwidth Measurement .....	24
4.3.1 Limits of 6dB Bandwidth Measurement .....	24
4.3.2 Test Setup.....	24
4.3.3 Test Instruments .....	24
4.3.4 Test Procedure .....	24
4.3.5 Deviation from Test Standard .....	24
4.3.6 EUT Operating Conditions.....	24
4.3.7 Test Result.....	25
4.4 Conducted Output Power Measurement.....	26
4.4.1 Limits of Conducted Output Power Measurement .....	26
4.4.2 Test Setup.....	26
4.4.3 Test Instruments .....	26
4.4.4 Test Procedures.....	26
4.4.5 Deviation from Test Standard .....	26
4.4.6 EUT Operating Conditions.....	26
4.4.7 Test Results .....	27
4.5 Power Spectral Density Measurement.....	28
4.5.1 Limits of Power Spectral Density Measurement.....	28
4.5.2 Test Setup.....	28
4.5.3 Test Instruments .....	28
4.5.4 Test Procedure .....	28



4.5.5	Deviation from Test Standard .....	28
4.5.6	EUT Operating Condition .....	28
4.5.7	Test Results .....	29
4.6	Conducted Out of Band Emission Measurement.....	30
4.6.1	Limits of Conducted Out of Band Emission Measurement.....	30
4.6.2	Test Setup.....	30
4.6.3	Test Instruments .....	30
4.6.4	Test Procedure .....	30
4.6.5	Deviation from Test Standard .....	30
4.6.6	EUT Operating Condition .....	30
4.6.7	Test Results .....	30
<b>5</b>	<b>Pictures of Test Arrangements.....</b>	<b>32</b>
	<b>Appendix – Information on the Testing Laboratories .....</b>	<b>33</b>



### Release Control Record

Issue No.	Description	Date Issued
RF140729D01A-1	Original release.	Dec. 22, 2015

## 1 Certificate of Conformity

**Product:** Soundbar

**Brand:**



**Test Model:** Omni SB1 Plus Soundbar

**Sample Status:** Engineering sample

**Applicant:** Polk Audio

**Test Date:** Dec. 14 ~ 17, 2015

**Standards:** 47 CFR FCC Part 15, Subpart C (Section 15.247)  
ANSI C63.10: 2013

The above equipment has been tested by **Bureau Veritas Consumer Products Services (H.K.) Ltd., Taoyuan Branch**, and found compliance with the requirement of the above standards. The test record, data evaluation & Equipment Under Test (EUT) configurations represented herein are true and accurate accounts of the measurements of the sample's EMC characteristics under the conditions specified in this report.

**Prepared by :**

*Annie Chang*

**Date:**

Dec. 22, 2015

Annie Chang / Senior Specialist

**Approved by :**

*Rex Lai*

**Date:**

Dec. 22, 2015

Rex Lai / Assistant Manager

## 2 Summary of Test Results

47 CFR FCC Part 15, Subpart C (SECTION 15.247)			
FCC Clause	Test Item	Result	Remarks
15.207	AC Power Conducted Emission	PASS	Meet the requirement of limit. Minimum passing margin is -24.16dB at 0.15000MHz.
15.205 & 15.209	Radiated Emissions	PASS	Meet the requirement of limit. Minimum passing margin is -3.1dB at 7431.90MHz.
15.247(d)	Band Edge Measurement	PASS	Meet the requirement of limit. Minimum passing margin is -10.2dB at 2400.0MHz.
15.247(d)	Antenna Port Emission	PASS	Meet the requirement of limit.
15.247(a)(2)	6dB bandwidth	PASS	Meet the requirement of limit.
15.247(b)	Conducted power	PASS	Meet the requirement of limit.
15.247(e)	Power Spectral Density	PASS	Meet the requirement of limit.
15.203	Antenna Requirement	PASS	No antenna connector is used.

### 2.1 Measurement Uncertainty

Where relevant, the following measurement uncertainty levels have been estimated for tests performed on the EUT as specified in CISPR 16-4-2:

Measurement	Frequency	Expanded Uncertainty (k=2) (±)
Conducted Emissions at mains ports	150kHz ~ 30MHz	2.78 dB
Radiated Emissions up to 1 GHz	30MHz ~ 1000MHz	4.00 dB
Radiated Emissions above 1 GHz	1GHz ~ 40GHz	3.36 dB

### 2.2 Modification Record

There were no modifications required for compliance.

### 3 General Information

#### 3.1 General Description of EUT

Product	Soundbar
Brand	
Test Model	Omni SB1 Plus Soundbar
Status of EUT	Engineering sample
Power Supply Rating	24Vdc from AC Adapter
Modulation Type	FSK
Transfer Rate	2Mbps
Operating Frequency	2403.5~ 2477.3MHz
Number of Channel	49
Output Power	3.6mW
Antenna Type	PIFA antenna with 1.82dBi gain
Antenna Connector	N/A
Accessory Device	Adapter
Data Cable Supplied	N/A

Note:

1. The EUT is a Soundbar.

2. The EUT consumes power from an AC adapter as follows:

Brand	Model No.	Spec.
polk	DYS602-240250W	AC I/P: 100-240Vac, 50/60Hz, 1.5A Max. DC O/P: 24Vdc, 2.5A Non-shielded AC cable (1.8m) 2 Pin Non-shielded DC cable with one core (1.8m)

3. The above EUT information is declared by manufacturer and for more detailed features description, please refer to the manufacturer's specifications or user's manual.

### 3.2 Description of Test Modes

49 channels are provided to this EUT:

Channel	Frequency	Channel	Frequency
1	2403.5 MHz	26	2442.0 MHz
2	2405.1 MHz	27	2443.5 MHz
3	2406.6 MHz	28	2445.0 MHz
4	2408.1 MHz	29	2446.6 MHz
5	2409.7 MHz	30	2448.1 MHz
6	2411.2 MHz	31	2449.6 MHz
7	2412.8 MHz	32	2451.2 MHz
8	2414.3 MHz	33	2452.7 MHz
9	2415.8 MHz	34	2454.3 MHz
10	2417.4 MHz	35	2455.8 MHz
11	2418.9 MHz	36	2457.3 MHz
12	2420.4 MHz	37	2458.9 MHz
13	2422.0 MHz	38	2460.4 MHz
14	2423.5 MHz	39	2461.9 MHz
15	2425.1 MHz	40	2463.5 MHz
16	2426.6 MHz	41	2465.0 MHz
17	2428.1 MHz	42	2466.6 MHz
18	2429.7 MHz	43	2468.1 MHz
19	2431.2 MHz	44	2469.6 MHz
20	2432.7 MHz	45	2471.2 MHz
21	2434.3 MHz	46	2472.7 MHz
22	2435.8 MHz	47	2474.2 MHz
23	2437.4 MHz	48	2475.8 MHz
24	2438.9 MHz	49	2477.3 MHz
25	2440.4 MHz		



### 3.2.1 Test Mode Applicability and Tested Channel Detail

EUT CONFIGURE MODE	APPLICABLE TO				DESCRIPTION
	RE $\geq$ 1G	RE<1G	PLC	APCM	
-	√	√	√	√	-

Where RE $\geq$ 1G: Radiated Emission above 1GHz & Bandedge Measurement  
 RE<1G: Radiated Emission below 1GHz  
 PLC: Power Line Conducted Emission  
 APCM: Antenna Port Conducted Measurement

#### **Radiated Emission Test (Above 1GHz):**

- Pre-Scan has been conducted to determine the worst-case mode from all possible combinations between available modulations, data rates and antenna ports (if EUT with antenna diversity architecture).
- Following channel(s) was (were) selected for the final test as listed below.

EUT CONFIGURE MODE	AVAILABLE CHANNEL	TESTED CHANNEL	MODULATION TYPE
-	1 to 49	1, 25, 49	FSK

#### **Radiated Emission Test (Below 1GHz):**

- Pre-Scan has been conducted to determine the worst-case mode from all possible combinations between available modulations, data rates and antenna ports (if EUT with antenna diversity architecture).
- Following channel(s) was (were) selected for the final test as listed below.

EUT CONFIGURE MODE	AVAILABLE CHANNEL	TESTED CHANNEL	MODULATION TYPE
-	1 to 49	25	FSK

#### **Power Line Conducted Emission Test:**

- Pre-Scan has been conducted to determine the worst-case mode from all possible combinations between available modulations, data rates and antenna ports (if EUT with antenna diversity architecture).
- Following channel(s) was (were) selected for the final test as listed below.

EUT CONFIGURE MODE	AVAILABLE CHANNEL	TESTED CHANNEL	MODULATION TYPE
-	1 to 49	25	FSK

#### **Antenna Port Conducted Measurement:**

- This item includes all test value of each mode, but only includes spectrum plot of worst value of each mode.
- Pre-Scan has been conducted to determine the worst-case mode from all possible combinations between available modulations, data rates and antenna ports (if EUT with antenna diversity architecture).
- Following channel(s) was (were) selected for the final test as listed below.

EUT CONFIGURE MODE	AVAILABLE CHANNEL	TESTED CHANNEL	MODULATION TYPE
-	1 to 49	1, 25, 49	FSK

**Test Condition:**

APPLICABLE TO	ENVIRONMENTAL CONDITIONS	INPUT POWER	TESTED BY
RE≥1G	27deg. C, 69% RH	120Vac, 60Hz	Aaron You
RE<1G	27deg. C, 69% RH	120Vac, 60Hz	Aaron You
PLC	25deg. C, 73% RH	120Vac, 60Hz	Dalen Dai
APCM	20deg. C, 70%RH	120Vac, 60Hz	Saxon Lee

**3.3 Duty Cycle of Test Signal**

Duty cycle of test signal is 100 %.

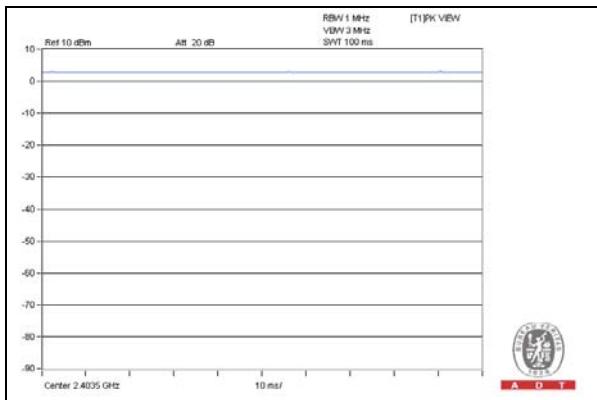

### 3.4 Description of Support Units

The EUT has been tested as an independent unit together with AC adapter.

#### 3.4.1 Configuration of System under Test

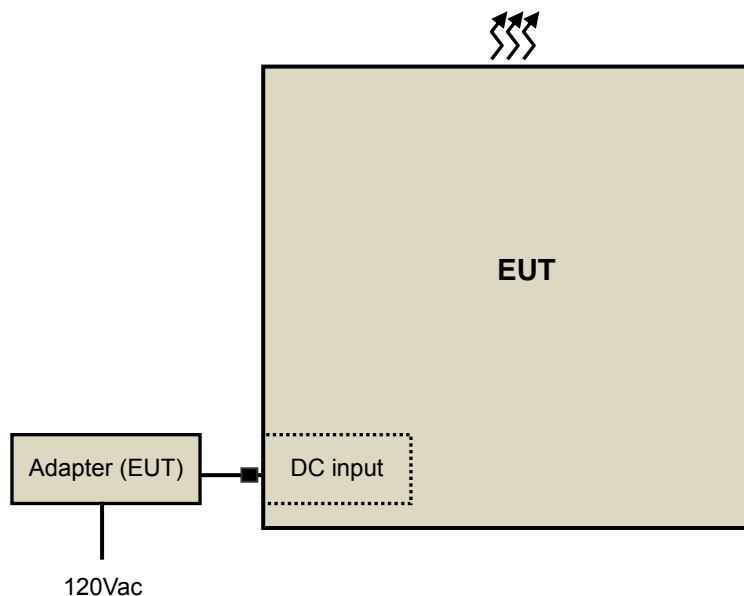

### 3.5 General Description of Applied Standards

The EUT is a RF Product. According to the specifications of the manufacturer, it must comply with the requirements of the following standards:

**FCC Part 15, Subpart C (15.247)**  
**558074 D01 DTS Meas Guidance v03r05**  
ANSI C63.10-2013

All test items have been performed and recorded as per the above standards.

## 4 Test Types and Results

### 4.1 Radiated Emission and Bandedge Measurement

#### 4.1.1 Limits of Radiated Emission and Bandedge Measurement

Radiated emissions which fall in the restricted bands must comply with the radiated emission limits specified as below table. Other emissions shall be at least 20dB below the highest level of the desired power:

Frequencies (MHz)	Field Strength (microvolts/meter)	Measurement Distance (meters)
0.009 ~ 0.490	2400/F(kHz)	300
0.490 ~ 1.705	24000/F(kHz)	30
1.705 ~ 30.0	30	30
30 ~ 88	100	3
88 ~ 216	150	3
216 ~ 960	200	3
Above 960	500	3

**NOTE:**

1. The lower limit shall apply at the transition frequencies.
2. Emission level (dBuV/m) = 20 log Emission level (uV/m).
3. For frequencies above 1000MHz, the field strength limits are based on average detector, however, the peak field strength of any emission shall not exceed the maximum permitted average limits, specified above by more than 20dB under any condition of modulation.



## 4.1.2 Test Instruments

DESCRIPTION & MANUFACTURER	MODEL NO.	SERIAL NO.	CALIBRATED DATE	CALIBRATED UNTIL
HP Preamplifier	8447D	2432A03504	Feb. 26, 2015	Feb. 25, 2016
HP Preamplifier	8449B	3008A01201	Feb. 26, 2015	Feb. 25, 2016
MITEQ Preamplifier	AMF-6F-260400-33-8P	892164	Mar. 01, 2015	Feb. 28, 2016
Agilent TEST RECEIVER	N9038A	MY51210129	Jan. 20, 2015	Jan. 19, 2016
Schwarzbeck Antenna	VULB 9168	139	Feb. 04, 2015	Feb. 03, 2016
Schwarzbeck Antenna	VHBA 9123	480	May 29, 2015	May 28, 2017
Schwarzbeck Horn Antenna	BBHA-9170	212	Feb. 09, 2015	Feb. 08, 2016
Schwarzbeck Horn Antenna	BBHA 9120-D1	D130	Feb. 10, 2015	Feb. 09, 2016
ADT. Turn Table	TT100	0306	NA	NA
ADT. Tower	AT100	0306	NA	NA
Software	Radiated_V7.6.15.9.4	NA	NA	NA
SUHNER RF cable With 4dB PAD	SF104	CABLE-CH6	Aug. 15, 2015	Aug. 14, 2016
SUHNER RF cable With 3dB PAD	SF102	Cable-CH8-3.6m	Aug. 15, 2015	Aug. 14, 2016
EMCO Horn Antenna	3115	00028257	Feb. 05, 2015	Feb. 04, 2016
Highpass filter Wainwright Instruments	WHK 3.1/18G-10SS	SN 8	NA	NA
ROHDE & SCHWARZ Spectrum Analyzer	FSV40	101042	Sep. 23, 2015	Sep. 22, 2016
Anritsu Power Sensor	MA2411B	0738404	Apr. 21, 2015	Apr. 20, 2016
Anritsu Power Meter	ML2495A	0842014	Apr. 21, 2015	Apr. 20, 2016

- NOTE:** 1. The calibration interval of the above test instruments is 12/24 months. And the calibrations are traceable to NML/ROC and NIST/USA.
2. The horn antenna and HP preamplifier (model: 8449B) are used only for the measurement of emission frequency above 1GHz if tested.
3. The test was performed in Chamber No. 6.
4. The Industry Canada Reference No. IC 7450E-6.
5. The FCC Site Registration No. is 447212.

#### 4.1.3 Test Procedures

- a. The EUT was placed on the top of a rotating table 0.8 meters (for below 1GHz) / 1.5 meters (for above 1GHz) above the ground at 3 meter chamber room for test. The table was rotated 360 degrees to determine the position of the highest radiation.
- b. The EUT was set 3 meters away from the interference-receiving antenna, which was mounted on the top of a variable-height antenna tower.
- c. The height of antenna is varied from one meter to four meters above the ground to determine the maximum value of the field strength. Both horizontal and vertical polarizations of the antenna are set to make the measurement.
- d. For each suspected emission, the EUT was arranged to its worst case and then the antenna was tuned to heights from 1 meter to 4 meters and the rotatable table was turned from 0 degrees to 360 degrees to find the maximum reading.
- e. The test-receiver system was set to quasi-peak detect function and specified bandwidth with maximum hold mode when the test frequency is below 1 GHz.
- f. The test-receiver system was set to peak and average detect function and specified bandwidth with maximum hold mode when the test frequency is above 1 GHz. If the peak reading value also meets average limit, measurement with the average detector is unnecessary.

#### Note:

1. The resolution bandwidth and video bandwidth of test receiver/spectrum analyzer is 120kHz for Quasi-peak detection (QP) at frequency below 1GHz.
2. The resolution bandwidth of test receiver/spectrum analyzer is 1 MHz and the video bandwidth is 3 MHz for Peak detection (PK) at frequency above 1GHz.
3. The resolution bandwidth of test receiver/spectrum analyzer is 1MHz and the video bandwidth is 3MHz for RMS Average (Duty cycle < 98%) for Average detection (AV) at frequency above 1GHz, then the measurement results was added to a correction factor ( $10 \log(1/\text{duty cycle})$ ).
4. The resolution bandwidth of test receiver/spectrum analyzer is 1MHz and the video bandwidth is 10Hz (Duty cycle  $\geq 98\%$ ) for Average detection (AV) at frequency above 1GHz.
5. All modes of operation were investigated and the worst-case emissions are reported.

#### 4.1.4 Deviation from Test Standard

No deviation.

4.1.5 Test Set Up

<Frequency Range below 1GHz>

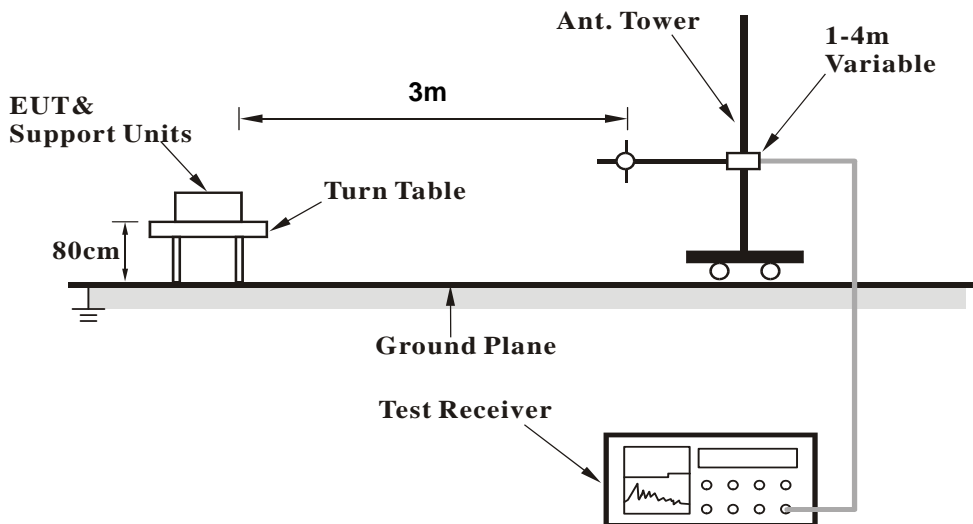

<Frequency Range above 1GHz>

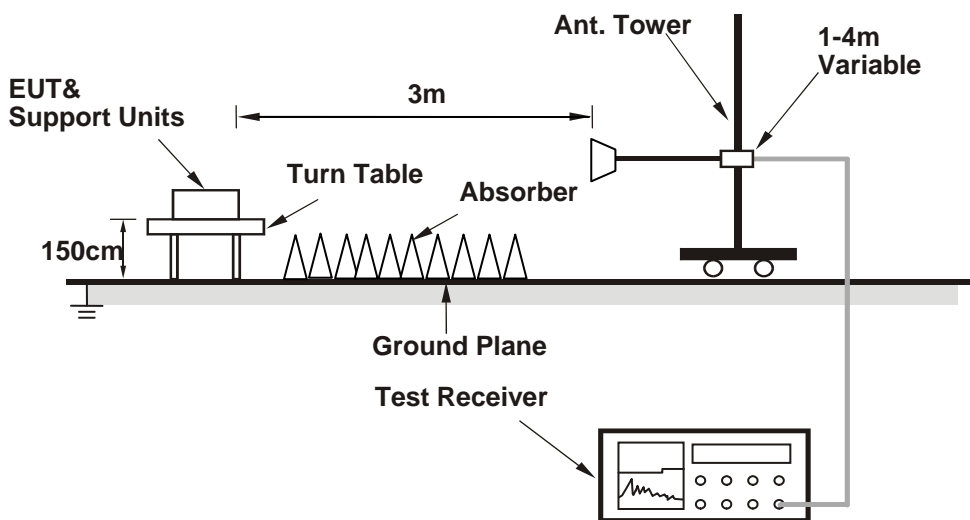

For the actual test configuration, please refer to the attached file (Test Setup Photo).

4.1.6 EUT Operating Conditions

- a. Turn on the power of all equipment.
- b. Set the EUT under transmitting condition.

#### 4.1.7 Test Results

#### Above 1GHz Data :

<b>CHANNEL</b>	TX Channel 1	<b>DETECTOR FUNCTION</b>	Peak (PK)
<b>FREQUENCY RANGE</b>	1GHz ~ 25GHz		Average (AV)

ANTENNA POLARITY & TEST DISTANCE: HORIZONTAL AT 3 M								
NO.	FREQ. (MHz)	EMISSION LEVEL (dBuV/m)	LIMIT (dBuV/m)	MARGIN (dB)	ANTENNA HEIGHT (m)	TABLE ANGLE (Degree)	RAW VALUE (dBuV)	CORRECTION FACTOR (dB/m)
1	2390.00	52.0 PK	74.0	-22.0	1.10 H	185	55.62	-3.58
2	2390.00	39.1 AV	54.0	-14.9	1.10 H	185	42.65	-3.58
3	2400.00	52.7 PK	74.0	-21.3	1.10 H	185	56.23	-3.54
4	2400.00	43.3 AV	54.0	-10.7	1.10 H	185	46.88	-3.54
5	*2403.50	84.5 PK			1.10 H	185	88.03	-3.53
6	*2403.50	83.3 AV			1.10 H	185	86.83	-3.53
7	4807.00	51.9 PK	74.0	-22.1	1.00 H	146	47.97	3.93
8	4807.00	44.5 AV	54.0	-9.5	1.00 H	146	40.53	3.93
9	7210.50	53.0 PK	74.0	-21.0	1.46 H	134	44.04	8.93
10	7210.50	41.1 AV	54.0	-13.0	1.46 H	134	32.12	8.93
11	9614.00	58.6 PK	74.0	-15.4	1.36 H	192	46.58	12.01
12	9614.00	47.7 AV	54.0	-6.3	1.36 H	192	35.73	12.01

ANTENNA POLARITY & TEST DISTANCE: VERTICAL AT 3 M								
NO.	FREQ. (MHz)	EMISSION LEVEL (dBuV/m)	LIMIT (dBuV/m)	MARGIN (dB)	ANTENNA HEIGHT (m)	TABLE ANGLE (Degree)	RAW VALUE (dBuV)	CORRECTION FACTOR (dB/m)
1	2390.00	52.9 PK	74.0	-21.2	1.06 V	275	56.43	-3.58
2	2390.00	39.3 AV	54.0	-14.7	1.06 V	275	42.89	-3.58
3	2400.00	54.8 PK	74.0	-19.2	1.06 V	275	58.31	-3.54
4	<b>2400.00</b>	<b>43.8 AV</b>	<b>54.0</b>	<b>-10.2</b>	<b>1.06 V</b>	<b>275</b>	<b>47.32</b>	<b>-3.54</b>
5	*2403.50	88.1 PK			1.06 V	275	91.58	-3.53
6	*2403.50	86.8 AV			1.06 V	275	90.31	-3.53
7	4807.00	53.1 PK	74.0	-20.9	1.11 V	206	49.16	3.93
8	4807.00	45.5 AV	54.0	-8.5	1.11 V	206	41.59	3.93
9	7210.50	53.1 PK	74.0	-21.0	1.29 V	230	44.12	8.93
10	7210.50	41.3 AV	54.0	-12.7	1.29 V	230	32.39	8.93
11	9614.00	58.7 PK	74.0	-15.3	1.26 V	78	46.68	12.01
12	9614.00	47.9 AV	54.0	-6.1	1.26 V	78	35.91	12.01

#### REMARKS:

1. Emission Level(dBuV/m) = Raw Value(dBuV) + Correction Factor(dB/m)
2. Correction Factor(dB/m) = Antenna Factor(dB/m) + Cable Factor(dB) – Pre-Amplifier Factor(dB)
3. The other emission levels were very low against the limit.
4. Margin value = Emission Level – Limit value
5. " \* " : Fundamental frequency.





<b>CHANNEL</b>	TX Channel 25	<b>DETECTOR FUNCTION</b>	Peak (PK)
<b>FREQUENCY RANGE</b>	1GHz ~ 25GHz		Average (AV)

**ANTENNA POLARITY & TEST DISTANCE: HORIZONTAL AT 3 M**

NO.	FREQ. (MHz)	EMISSION LEVEL (dBuV/m)	LIMIT (dBuV/m)	MARGIN (dB)	ANTENNA HEIGHT (m)	TABLE ANGLE (Degree)	RAW VALUE (dBuV)	CORRECTION FACTOR (dB/m)
1	*2440.40	86.6 PK			1.08 H	185	90.06	-3.42
2	*2440.40	85.4 AV			1.08 H	185	88.84	-3.42
3	4880.80	56.5 PK	74.0	-17.5	1.00 H	145	52.17	4.30
4	4880.80	49.6 AV	54.0	-4.4	1.00 H	145	45.30	4.30
5	7321.20	56.8 PK	74.0	-17.2	1.36 H	136	47.38	9.46
6	7321.20	47.3 AV	54.0	-6.7	1.36 H	136	37.87	9.46
7	9761.60	59.9 PK	74.0	-14.1	1.30 H	190	47.72	12.16
8	9761.60	50.3 AV	54.0	-3.7	1.30 H	190	38.14	12.16

**ANTENNA POLARITY & TEST DISTANCE: VERTICAL AT 3 M**

NO.	FREQ. (MHz)	EMISSION LEVEL (dBuV/m)	LIMIT (dBuV/m)	MARGIN (dB)	ANTENNA HEIGHT (m)	TABLE ANGLE (Degree)	RAW VALUE (dBuV)	CORRECTION FACTOR (dB/m)
1	*2440.40	87.9 PK			1.03 V	278	91.27	-3.42
2	*2440.40	87.5 AV			1.03 V	278	90.96	-3.42
3	4880.80	56.9 PK	74.0	-17.1	1.03 V	168	52.58	4.30
4	4880.80	50.7 AV	54.0	-3.3	1.03 V	168	46.36	4.30
5	7321.20	59.6 PK	74.0	-14.4	1.33 V	148	50.12	9.46
6	7321.20	50.1 AV	54.0	-3.9	1.33 V	148	40.63	9.46
7	9761.60	59.9 PK	74.0	-14.1	1.31 V	80	47.78	12.16
8	9761.60	50.4 AV	54.0	-3.6	1.31 V	80	38.26	12.16

**REMARKS:**

1. Emission Level(dBuV/m) = Raw Value(dBuV) + Correction Factor(dB/m)
2. Correction Factor(dB/m) = Antenna Factor(dB/m) + Cable Factor(dB) – Pre-Amplifier Factor(dB)
3. The other emission levels were very low against the limit.
4. Margin value = Emission Level – Limit value
5. " \* ": Fundamental frequency.



<b>CHANNEL</b>	TX Channel 49	<b>DETECTOR FUNCTION</b>	Peak (PK)
<b>FREQUENCY RANGE</b>	1GHz ~ 25GHz		Average (AV)

**ANTENNA POLARITY & TEST DISTANCE: HORIZONTAL AT 3 M**

NO.	FREQ. (MHz)	EMISSION LEVEL (dBuV/m)	LIMIT (dBuV/m)	MARGIN (dB)	ANTENNA HEIGHT (m)	TABLE ANGLE (Degree)	RAW VALUE (dBuV)	CORRECTION FACTOR (dB/m)
1	*2477.30	85.5 PK			1.06 H	186	88.85	-3.31
2	*2477.30	84.4 AV			1.06 H	186	87.68	-3.31
3	2483.50	52.3 PK	74.0	-21.7	1.06 H	186	55.63	-3.30
4	2483.50	38.7 AV	54.0	-15.4	1.06 H	186	41.95	-3.30
5	4954.60	54.1 PK	74.0	-19.9	1.00 H	147	49.59	4.52
6	4954.60	47.4 AV	54.0	-6.6	1.00 H	147	42.91	4.52
7	7431.90	59.1 PK	74.0	-14.9	1.51 H	134	49.64	9.46
8	7431.90	50.4 AV	54.0	-3.6	1.51 H	134	40.98	9.46
9	9909.20	60.4 PK	74.0	-13.7	1.33 H	188	48.31	12.04
10	9909.20	50.3 AV	54.0	-3.7	1.33 H	188	38.29	12.04

**ANTENNA POLARITY & TEST DISTANCE: VERTICAL AT 3 M**

NO.	FREQ. (MHz)	EMISSION LEVEL (dBuV/m)	LIMIT (dBuV/m)	MARGIN (dB)	ANTENNA HEIGHT (m)	TABLE ANGLE (Degree)	RAW VALUE (dBuV)	CORRECTION FACTOR (dB/m)
1	*2477.30	87.3 PK			1.02 V	278	90.56	-3.31
2	*2477.30	86.0 AV			1.02 V	278	89.31	-3.31
3	2483.50	52.9 PK	74.0	-21.1	1.02 V	278	56.19	-3.30
4	2483.50	39.1 AV	54.0	-14.9	1.02 V	278	42.41	-3.30
5	4954.60	55.1 PK	74.0	-18.9	1.28 V	168	50.57	4.52
6	4954.60	48.2 AV	54.0	-5.8	1.28 V	168	43.72	4.52
7	7431.90	59.6 PK	74.0	-14.4	1.48 V	189	50.17	9.46
<b>8</b>	<b>7431.90</b>	<b>50.9 AV</b>	<b>54.0</b>	<b>-3.1</b>	<b>1.48 V</b>	<b>189</b>	<b>41.45</b>	<b>9.46</b>
9	9909.20	61.0 PK	74.0	-13.0	1.39 V	136	48.94	12.04
10	9909.20	50.5 AV	54.0	-3.5	1.39 V	136	38.47	12.04

**REMARKS:**

- Emission Level(dBuV/m) = Raw Value(dBuV) + Correction Factor(dB/m)
- Correction Factor(dB/m) = Antenna Factor(dB/m) + Cable Factor(dB) – Pre-Amplifier Factor(dB)
- The other emission levels were very low against the limit.
- Margin value = Emission Level – Limit value
- " \* ": Fundamental frequency.

**Below 1GHz Worst-Case Data:**

<b>CHANNEL</b>	TX Channel 25	<b>DETECTOR FUNCTION</b>	Quasi-Peak (QP)
<b>FREQUENCY RANGE</b>	30MHz ~ 1GHz		

**ANTENNA POLARITY & TEST DISTANCE: HORIZONTAL AT 3 M**

NO.	FREQ. (MHz)	EMISSION LEVEL (dBuV/m)	LIMIT (dBuV/m)	MARGIN (dB)	ANTENNA HEIGHT (m)	TABLE ANGLE (Degree)	RAW VALUE (dBuV)	CORRECTION FACTOR (dB/m)
1	101.39	34.5 QP	43.5	-9.0	2.21 H	3	52.42	-17.88
2	144.42	39.3 QP	43.5	-4.2	2.00 H	195	53.09	-13.81
3	213.97	38.9 QP	43.5	-4.6	1.50 H	218	54.81	-15.94
4	294.91	36.9 QP	46.0	-9.1	1.37 H	230	49.10	-12.24
5	478.23	36.0 QP	46.0	-10.0	2.03 H	182	44.79	-8.76
6	638.04	40.9 QP	46.0	-5.2	1.15 H	352	46.50	-5.65
7	717.78	41.1 QP	46.0	-4.9	1.00 H	144	45.75	-4.63

**ANTENNA POLARITY & TEST DISTANCE: VERTICAL AT 3 M**

NO.	FREQ. (MHz)	EMISSION LEVEL (dBuV/m)	LIMIT (dBuV/m)	MARGIN (dB)	ANTENNA HEIGHT (m)	TABLE ANGLE (Degree)	RAW VALUE (dBuV)	CORRECTION FACTOR (dB/m)
1	41.59	33.5 QP	40.0	-6.5	1.32 V	360	47.73	-14.26
2	142.08	36.3 QP	43.5	-7.2	1.00 V	298	50.34	-14.08
3	209.31	35.6 QP	43.5	-7.9	1.00 V	107	51.59	-16.02
4	238.56	33.7 QP	46.0	-12.3	1.24 V	283	48.44	-14.71
5	380.22	32.1 QP	46.0	-13.9	1.69 V	126	42.63	-10.53
6	498.36	33.2 QP	46.0	-12.8	2.24 V	273	41.52	-8.36
7	682.23	34.6 QP	46.0	-11.4	2.73 V	236	39.64	-5.08
8	761.87	33.6 QP	46.0	-12.4	1.97 V	74	37.10	-3.46

**REMARKS:**

1. Emission Level(dBuV/m) = Raw Value(dBuV) + Correction Factor(dB/m)
2. Correction Factor(dB/m) = Antenna Factor(dB/m) + Cable Factor(dB) – Pre-Amplifier Factor(dB)
3. The other emission levels were very low against the limit.
4. Margin value = Emission Level – Limit value

## 4.2 Conducted Emission Measurement

### 4.2.1 Limits of Conducted Emission Measurement

Frequency (MHz)	Conducted Limit (dBuV)	
	Quasi-peak	Average
0.15 - 0.5	66 - 56	56 - 46
0.50 - 5.0	56	46
5.0 - 30.0	60	50

Note: 1. The lower limit shall apply at the transition frequencies.

2. The limit decreases in line with the logarithm of the frequency in the range of 0.15 to 0.50MHz.

### 4.2.2 Test Instruments

Description & Manufacturer	Model No.	Serial No.	Cal. Date	Cal. Due
ROHDE & SCHWARZ TEST RECEIVER	ESCS 30	100290	Dec. 27, 2014	Dec. 26, 2015
ROHDE & SCHWARZ Artificial Mains Network (for EUT)	ESH2-Z5	100104	Dec. 07, 2015	Dec. 06, 2016
LISN With Adapter (for EUT)	AD10	C09Ada-001	Dec. 07, 2015	Dec. 06, 2016
ROHDE & SCHWARZ Artificial Mains Network (for peripherals)	ESH3-Z5	847265/023	Oct. 21, 2015	Oct. 20, 2016
SCHWARZBECK Artificial Mains Network (For EUT)	NNLK8129	8129229	May 06, 2015	May 05, 2016
Software	Cond_V7.3.7	NA	NA	NA
RF cable (JYEBAO) With 10dB PAD	5D-FB	Cable-C09.01	Feb. 24, 2015	Feb. 23, 2016
SUHNER Terminator (For ROHDE & SCHWARZ LISN)	65BNC-5001	E1-010789	May 19, 2015	May 18, 2016
ROHDE & SCHWARZ Artificial Mains Network (For TV EUT)	ESH3-Z5	100220	Nov. 13, 2015	Nov. 12, 2016
LISN With Adapter (for TV EUT)	100220	N/A	Nov. 13, 2015	Nov. 12, 2016

Notes: 1. The calibration interval of the above test instruments is 12 months and the calibrations are traceable to NML/ROC and NIST/USA.

2. The test was performed in Shielded Room No. 9.

3. The VCCI Site Registration No. C-1312.

#### 4.2.3 Test Procedures

- a. The EUT was placed 0.4 meters from the conducting wall of the shielded room with EUT being connected to the power mains through a line impedance stabilization network (LISN). Other support units were connected to the power mains through another LISN. The two LISNs provide 50 ohm/ 50uH of coupling impedance for the measuring instrument.
- b. Both lines of the power mains connected to the EUT were checked for maximum conducted interference.
- c. The frequency range from 150kHz to 30MHz was searched. Emission levels under (Limit - 20dB) was not recorded.

**NOTE:** The resolution bandwidth and video bandwidth of test receiver is 9kHz for quasi-peak detection (QP) and average detection (AV) at frequency 0.15MHz-30MHz.

#### 4.2.4 Deviation from Test Standard

No deviation.

#### 4.2.5 Test Setup

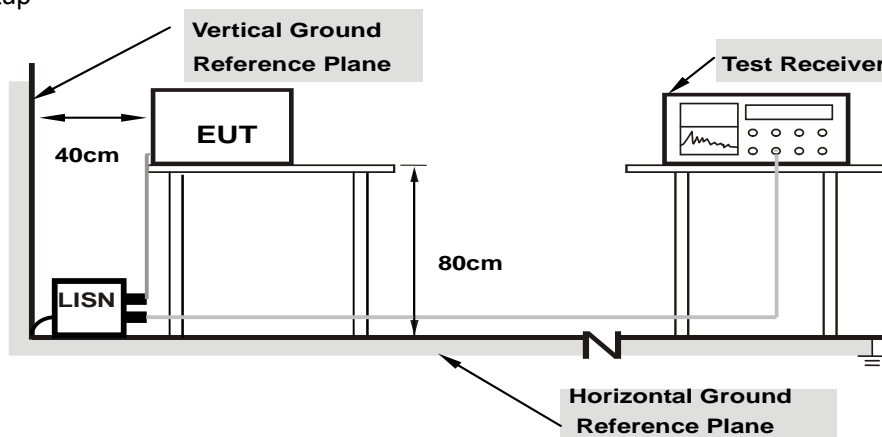

**Note:** Support units were connected to second LISN.

For the actual test configuration, please refer to the attached file (Test Setup Photo).

#### 4.2.6 EUT Operating Conditions

Same as item 4.1.6.

4.2.7 Test Results

<b>Frequency Range</b>	150kHz ~ 30MHz	<b>Detector Function &amp; Resolution Bandwidth</b>	Quasi-Peak (QP) / Average (AV), 9kHz
------------------------	----------------	---	--------------------------------------

Phase Of Power : Line (L)										
No	Frequency (MHz)	Correction Factor (dB)	Reading Value (dBuV)		Emission Level (dBuV)		Limit (dBuV)		Margin (dB)	
			Q.P.	AV.	Q.P.	AV.	Q.P.	AV.	Q.P.	AV.
1	0.15000	0.16	41.68	22.03	41.84	22.19	66.00	56.00	-24.16	-33.81
2	0.33359	0.20	27.92	20.42	28.12	20.62	59.36	49.36	-31.24	-28.74
3	0.79063	0.26	17.76	11.41	18.02	11.67	56.00	46.00	-37.98	-34.33
4	1.92051	0.34	18.52	14.29	18.86	14.63	56.00	46.00	-37.14	-31.37
5	4.22522	0.43	22.03	20.16	22.46	20.59	56.00	46.00	-33.54	-25.41
6	13.44199	0.77	26.13	21.88	26.90	22.65	60.00	50.00	-33.10	-27.35

Remarks:

1. Q.P. and AV. are abbreviations of quasi-peak and average individually.
2. The emission levels of other frequencies were very low against the limit.
3. Margin value = Emission level – Limit value
4. Correction factor = Insertion loss + Cable loss
5. Emission Level = Correction Factor + Reading Value

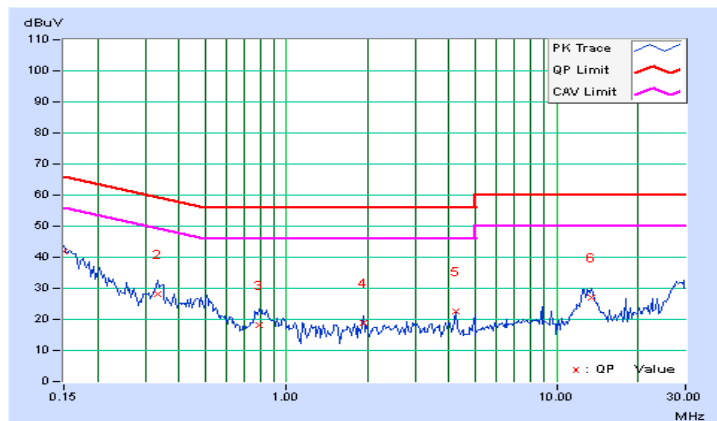

<b>Frequency Range</b>	150kHz ~ 30MHz	<b>Detector Function &amp; Resolution Bandwidth</b>	Quasi-Peak (QP) / Average (AV), 9kHz
------------------------	----------------	---	--------------------------------------

Phase Of Power : Neutral (N)										
No	Frequency (MHz)	Correction Factor (dB)	Reading Value (dBuV)		Emission Level (dBuV)		Limit (dBuV)		Margin (dB)	
			Q.P.	AV.	Q.P.	AV.	Q.P.	AV.	Q.P.	AV.
1	0.15391	0.29	40.41	23.45	40.70	23.74	65.79	55.79	-25.08	-32.04
2	0.33750	0.35	30.75	23.12	31.10	23.47	59.26	49.26	-28.16	-25.79
3	0.81016	0.41	17.52	10.32	17.93	10.73	56.00	46.00	-38.07	-35.27
4	1.92188	0.48	17.71	13.84	18.19	14.32	56.00	46.00	-37.81	-31.68
5	4.22521	0.52	23.14	20.58	23.66	21.10	56.00	46.00	-32.34	-24.90
6	13.44141	0.62	26.56	22.27	27.18	22.89	60.00	50.00	-32.82	-27.11

**Remarks:**

1. Q.P. and AV. are abbreviations of quasi-peak and average individually.
2. The emission levels of other frequencies were very low against the limit.
3. Margin value = Emission level – Limit value
4. Correction factor = Insertion loss + Cable loss
5. Emission Level = Correction Factor + Reading Value

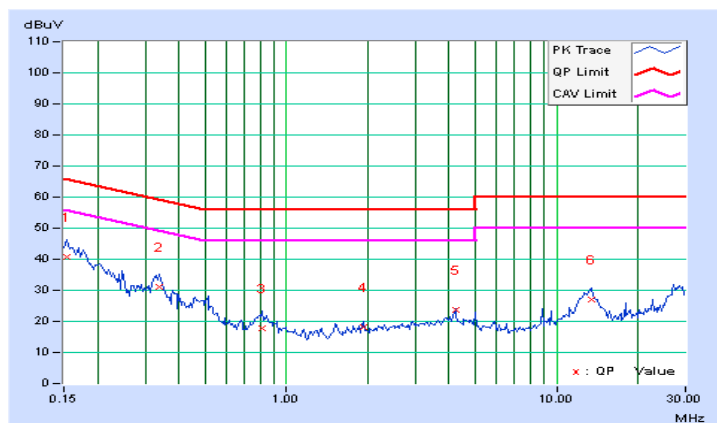

### 4.3 6dB Bandwidth Measurement

#### 4.3.1 Limits of 6dB Bandwidth Measurement

The minimum of 6dB Bandwidth Measurement is 0.5 MHz.

#### 4.3.2 Test Setup

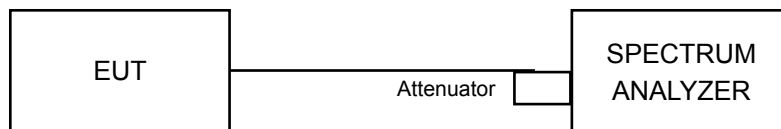

#### 4.3.3 Test Instruments

Refer to section 4.1.2 to get information of above instrument.

#### 4.3.4 Test Procedure

- a. Set resolution bandwidth (RBW) = 100kHz
- b. Set the video bandwidth (VBW)  $\geq 3 \times$  RBW, Detector = Peak.
- c. Trace mode = max hold.
- d. Sweep = auto couple.
- e. Measure the maximum width of the emission that is constrained by the frequencies associated with the two amplitude points (upper and lower) that are attenuated by 6 dB relative to the maximum level measured in the fundamental emission

#### 4.3.5 Deviation from Test Standard

No deviation.

#### 4.3.6 EUT Operating Conditions

The software provided by client to enable the EUT under transmission condition continuously at lowest, middle and highest channel frequencies individually.



### 4.3.7 Test Result

Channel	Frequency (MHz)	6dB Bandwidth (MHz)	Minimum Limit (MHz)	Pass / Fail
1	2403.5	1.14	0.5	PASS
25	2440.4	1.15	0.5	PASS
49	2477.3	1.13	0.5	PASS

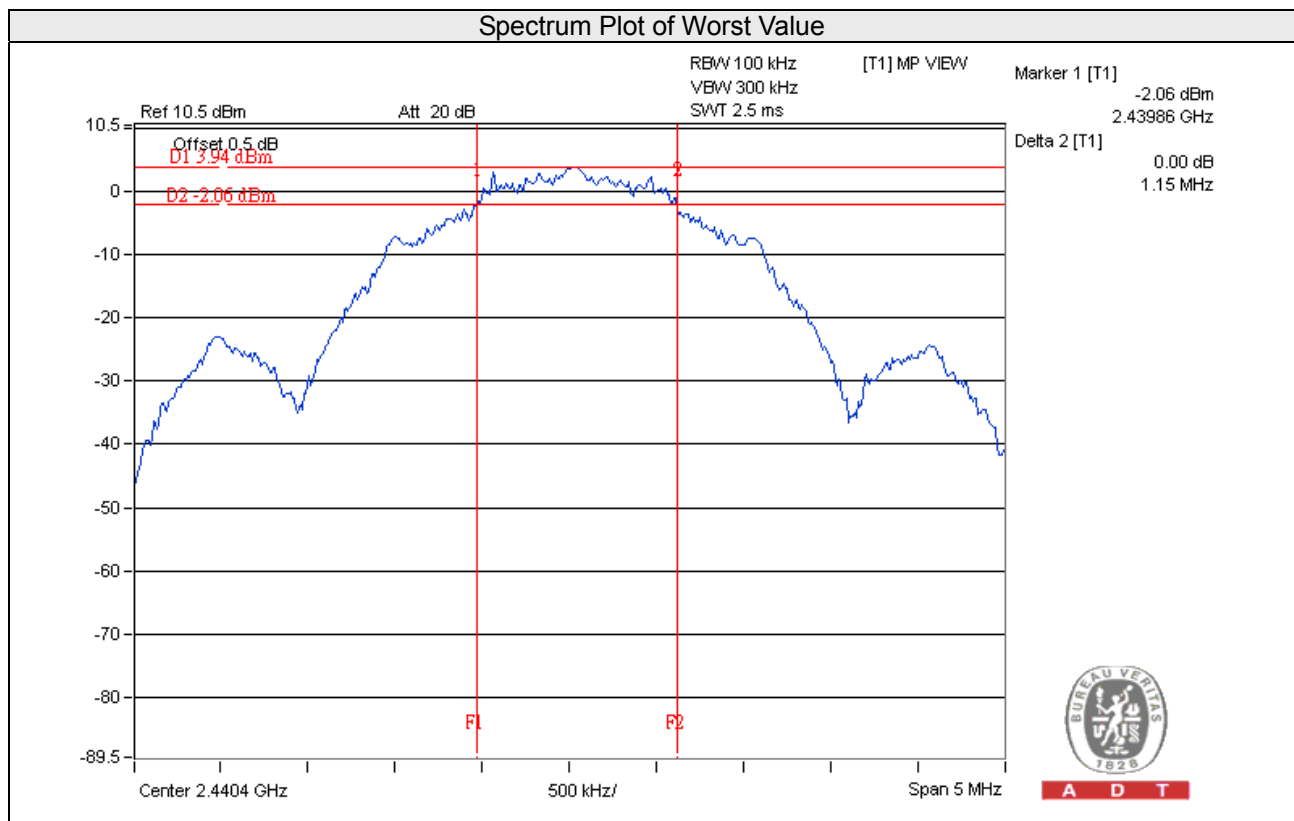

## 4.4 Conducted Output Power Measurement

### 4.4.1 Limits of Conducted Output Power Measurement

For systems using digital modulation in the 2400–2483.5 MHz bands: 1 Watt (30dBm)

### 4.4.2 Test Setup

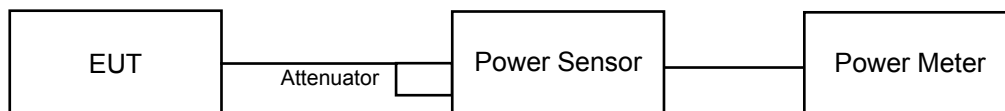

### 4.4.3 Test Instruments

Refer to section 4.1.2 to get information of above instrument.

### 4.4.4 Test Procedures

A peak / average power sensor was used on the output port of the EUT. A power meter was used to read the response of the peak / average power sensor. Record the power level.

### 4.4.5 Deviation from Test Standard

No deviation.

### 4.4.6 EUT Operating Conditions

Same as Item 4.3.6.

## 4.4.7 Test Results

## FOR PEAK POWER

Chan.	Freq. (MHz)	Peak Power (dBm)	Peak Power (mW)	Limit (dBm)	Pass / Fail
1	2403.5	5.50	3.5	30	Pass
25	2440.4	5.54	<b>3.6</b>	30	Pass
49	2477.3	5.37	3.4	30	Pass

## FOR AVERAGE POWER

Chan.	Frequency (MHz)	Avg. Power (dBm)
1	2403.5	5.41
25	2440.4	5.44
49	2477.3	5.28

## 4.5 Power Spectral Density Measurement

### 4.5.1 Limits of Power Spectral Density Measurement

The Maximum of Power Spectral Density Measurement is 8dBm.

### 4.5.2 Test Setup

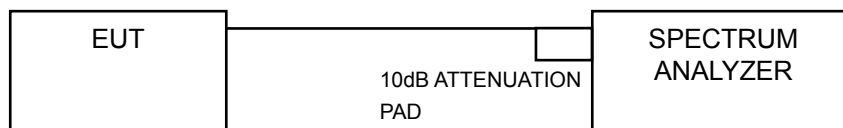

### 4.5.3 Test Instruments

Refer to section 4.1.2 to get information of above instrument.

### 4.5.4 Test Procedure

- Set analyzer center frequency to DTS channel center frequency.
- Set the span to 1.5 times the DTS bandwidth.
- Set the RBW to:  $3 \text{ kHz} \leq \text{RBW} \leq 100 \text{ kHz}$ .
- Set the VBW  $\geq 3 \times \text{RBW}$ .
- Detector = peak.
- Sweep time = auto couple.
- Trace mode = max hold.
- Allow trace to fully stabilize.
- Use the peak marker function to determine the maximum amplitude level within the RBW.

### 4.5.5 Deviation from Test Standard

No deviation.

### 4.5.6 EUT Operating Condition

Same as Item 4.3.6



## 4.6 Conducted Out of Band Emission Measurement

### 4.6.1 Limits of Conducted Out of Band Emission Measurement

Below 20dB of the highest emission level of operating band (in 100kHz Resolution Bandwidth).

### 4.6.2 Test Setup

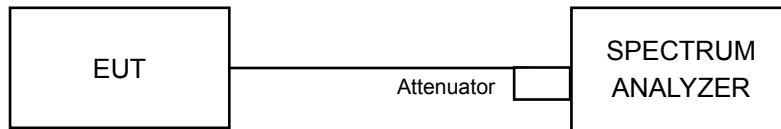

### 4.6.3 Test Instruments

Refer to section 4.1.2 to get information of above instrument.

### 4.6.4 Test Procedure

#### MEASUREMENT PROCEDURE REF

1. Set the RBW = 100 kHz.
2. Set the VBW  $\geq$  300 kHz.
3. Detector = peak.
4. Sweep time = auto couple.
5. Trace mode = max hold.
6. Allow trace to fully stabilize.
7. Use the peak marker function to determine the maximum power level in any 100 kHz band segment within the fundamental EBW.

#### MEASUREMENT PROCEDURE OOB

1. Set RBW = 100 kHz.
2. Set VBW  $\geq$  300 kHz.
3. Detector = peak.
4. Sweep = auto couple.
5. Trace Mode = max hold.
6. Allow trace to fully stabilize.
7. Use the peak marker function to determine the maximum amplitude level.

### 4.6.5 Deviation from Test Standard

No deviation.

### 4.6.6 EUT Operating Condition

Same as Item 4.3.6

### 4.6.7 Test Results

The spectrum plots are attached on the following pages. D1 line indicates the highest level, and D2 line indicates the 20dB offset below D1. It shows compliance with the requirement.

### CH 1

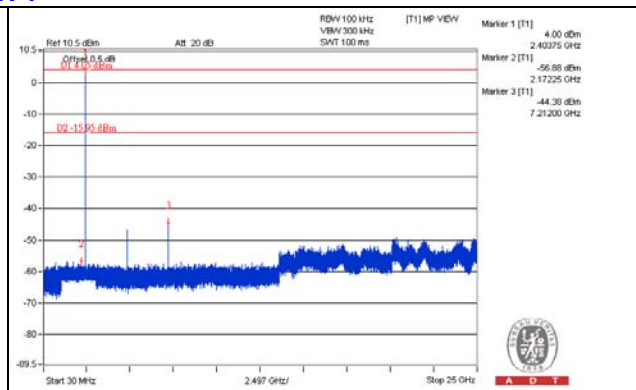
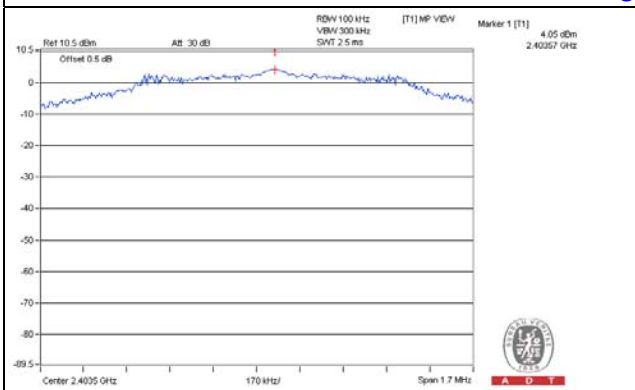

### CH 25

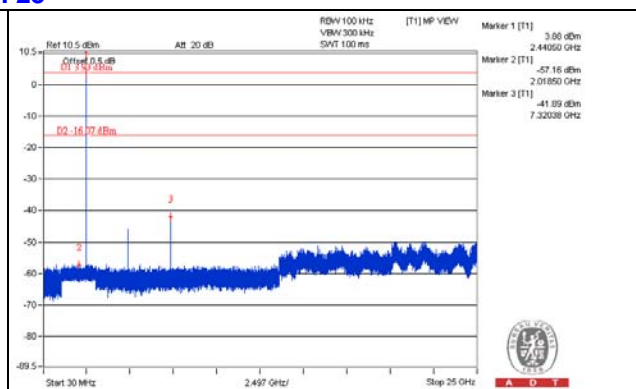
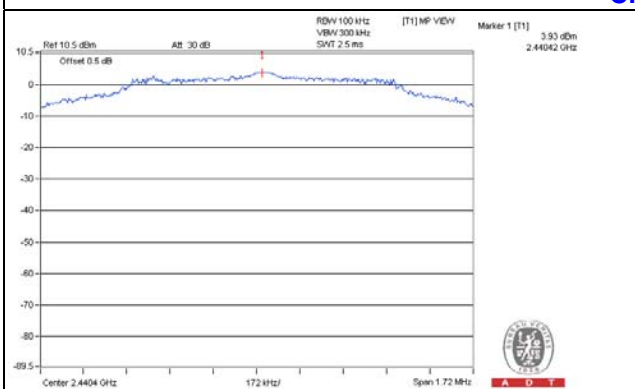

### CH 49

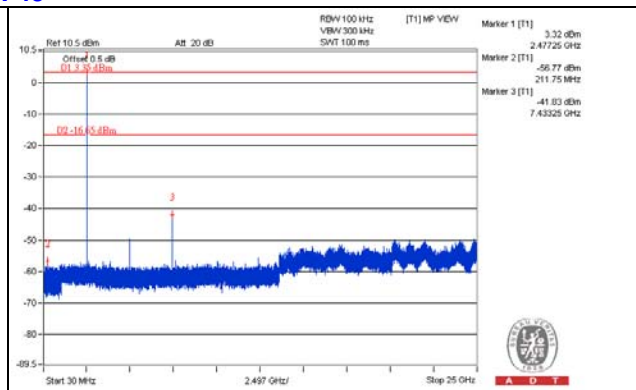
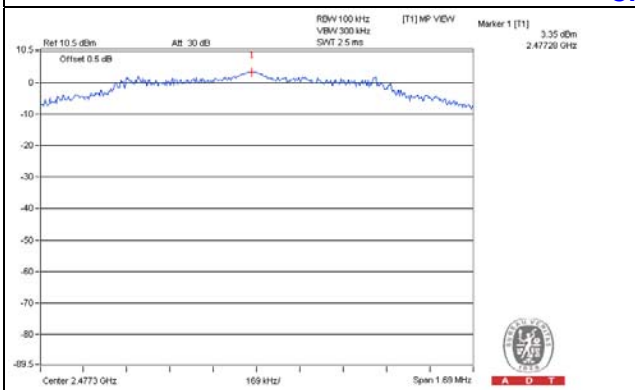

### CH 1 Band edge

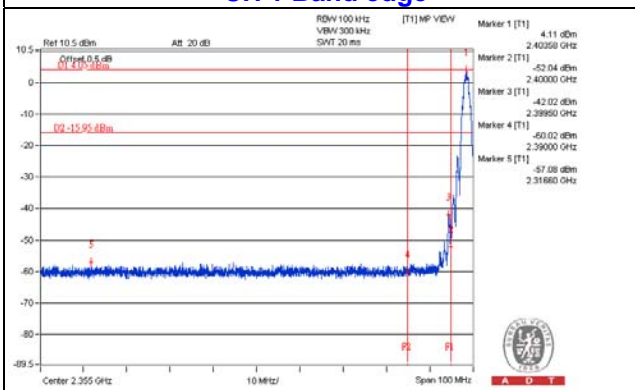

### CH 49 Band edge

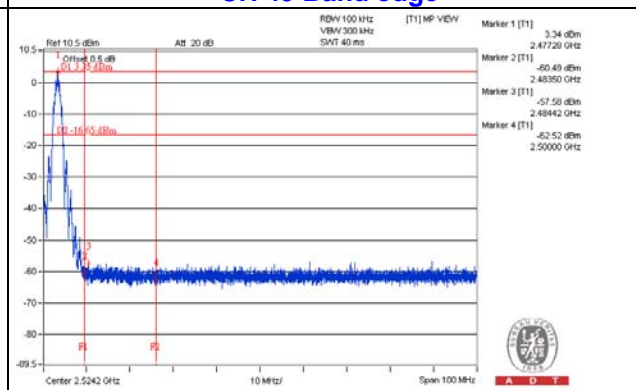

## 5 Pictures of Test Arrangements

Please refer to the attached file (Test Setup Photo).







## Appendix – Information on the Testing Laboratories

We, Bureau Veritas Consumer Products Services (H.K.) Ltd., Taoyuan Branch, were founded in 1988 to provide our best service in EMC, Radio, Telecom and Safety consultation. Our laboratories are accredited and approved according to ISO/IEC 17025.

If you have any comments, please feel free to contact us at the following:

**Linko EMC/RF Lab**

Tel: 886-2-26052180

Fax: 886-2-26051924

**Hsin Chu EMC/RF/Telecom Lab**

Tel: 886-3-6668565

Fax: 886-3-6668323

**Hwa Ya EMC/RF/Safety Lab**

Tel: 886-3-3183232

Fax: 886-3-3270892

**Email:** [service.adt@tw.bureauveritas.com](mailto:service.adt@tw.bureauveritas.com)

**Web Site:** [www.bureauveritas-adt.com](http://www.bureauveritas-adt.com)

The address and road map of all our labs can be found in our web site also.

--- END ---