

FCC 15.407 NII DFS Report

for

Elitegroup Computer Systems Co., Ltd.

**No. 239, Sec. 2, Ti Ding Blvd,
Taipei, Taiwan 11493**

Product Name : 7" Multi Function Pad
Model Name : mPAD2-7.....
Brand : ECS
FCC ID : WL6TC7A-W

**Prepared by: : AUDIX Technology Corporation,
EMC Department**



TABLE OF CONTENTS

Description	Page
TEST REPORT CERTIFICATION.....	4
1. REVISION RECORD OF TEST REPORT.....	4
2. SUMMARY OF TEST RESULTS.....	5
3. GENERAL INFORMATION.....	6
3.1. Description of Application.....	6
3.2. Description of EUT.....	7
3.3. EUT Specifications Assessed in Current Report.....	8
3.4. Antenna Information.....	10
3.5. Descriptions of Key Components.....	11
3.6. Test Configuration.....	12
3.7. Tested Supporting System List.....	13
3.8. Description of Test Facility.....	13
3.9. Measurement Uncertainty.....	13
4. MEASUREMENT EQUIPMENT LIST.....	14
5. WORKING MODES AND REQUIREMENT TEST ITEM.....	15
5.1. Applicability of DFS Requirements Prior To Use A Channel.....	15
5.2. Applicability of DFS Requirements During Normal Operation.....	15
6. DFS DETECTION THRESHOLOS AND RADAR TEST WAVEFORMS.....	16
6.1. Interference Threshold Value, Master or Client Incorporating In-Service Monitoring.....	16
6.2. Radar Test Waveform Minimum Step.....	16
6.3. Short Pulse Radar Test Waveforms.....	17
6.4. Long Pulse Radar Test Waveforms.....	18
6.5. Frequency Hopping Pulse Radar Test Waveforms.....	20
6.6. Conducted Calibration Setup.....	22
6.7. Radar Waveform Calibration Procedure.....	22
6.8. Calibration Deviation.....	22
6.9. Radar Waveform Calibration Result.....	23
7. TEST SETUP AND TEST RESULT.....	24
7.1. Test Setup.....	24
7.2. Channel Move Time, Channel Closing Transmission Time, Non-Occupancy Period, Non-Associated Client Beacon Measurement.....	26
8. PHOTOGRAPHS OF MEASUREMENT.....	37

TEST REPORT CERTIFICATION

Applicant : Elitegroup Computer Systems Co., Ltd.
EUT Description
(1) Product : 7" Multi Function Pad
(2) Model : mPAD2-7.....
(3) Brand : ECS

Applicable Standards:

47 CFR FCC Part 15 Subpart E
ANSI C63.10:2013
KDB 905462 D02 UNII DFS Compliance Procedures New Rules v02
KDB 905462 D03 UNII Clients Without Radar Detection New Rules v01r01

Audix Technology Corp. tested the equipment mentioned in accordance with the requirements set forth in the above standards. Test results indicate that the equipment tested is capable of demonstrating compliance with the requirements as documented within this report. **Audix Technology Corp.** does not assume responsibility for any conclusions and generalizations drawn from the test results with regard to other specimens and samples.

Date of Report: 2017. 03. 16

Reviewed by:  (Tina Huang/Administrator)

Approved by:  (Ben Cheng/Manager)

1. REVISION RECORD OF TEST REPORT

Edition No	Issued Data	Revision Summary	Report Number
0	2017. 03. 16	Original Report	EM-F170103

2. SUMMARY OF TEST RESULTS

Description	Results
Channel Availability Check Time	N/A
Channel Move Time	PASS
Non-Occupancy Period	PASS
Non-Associated Client Beacon	PASS
Channel Closing Transmission Time	PASS
U-NII Detection Bandwidth	N/A
N/A is an abbreviation for Not Applicable, since the product is client without radar detection function	

3. GENERAL INFORMATION

3.1. Description of Application

Applicant	Elitegroup Computer Systems Co., Ltd. No. 239, Sec. 2., TiDing Blvd., Taipei, Taiwan 11493
Product	7" Multi Function Pad
Model	mPAD2-7..... (The "." in the model name can be 0 to 9, A to Z, a to z, "-", "_", "\", "/" or blank for marketing use only)
Brand	ECS

3.2. Description of EUT

Test Model	mPAD2-7-CHT4-I	
Serial Number	N/A	
Power Rating	Refer to AC adapter rating.	
RF Features	WLAN:802.11a/b/g/n/ac Bluetooth: BT and BLE NFC, GPS	
Transmit Type	2.4 GHz	
	802.11b	2T2R
	802.11g	2T2R
	802.11n-HT20	2T2R
	802.11n-HT40	2T2R
	BT/BLE	1T1R
	UNII Bands	
	802.11a	2T2R
	802.11n-HT20/ 802.11ac-VHT20	2T2R
	802.11n-HT40/ 802.11ac-VHT40	2T2R
	802.11ac-VHT80	2T2R
	13.56MHz	
	NFC	1T1R
Device Category	<input type="checkbox"/> Outdoor Access Point <input type="checkbox"/> Fixed point-to-point Access Point <input type="checkbox"/> Indoor Access Point <input checked="" type="checkbox"/> Mobile and Portable client device	

Accessories	<ul style="list-style-type: none"> • Barcode Scanner mPAD (Option) • SCR mPAD (Option) • MSR Module (Option) • USB Ethernet mPAD (Option) • 7" Pad Docking (Option) • 30 Pin to USB Cable • 30 Pin to HDMI Cable • 30 Pin to DC Jack Cable • Power Adapter
Date of Receipt	2017. 01. 25
Date of Test	2017. 03.14

3.3. EUT Specifications Assessed in Current Report

Mode	UNII Band	Fundamental Range (MHz)	Channel Number
802.11a	II-2A	5260-5320	4
	II-2C	5500-5720	12
802.11n-HT20/ 802.11ac-VHT20	II-2A	5260-5320	4
	II-2C	5500-5720	12
802.11n-HT40/ 802.11ac-VHT40	II-2A	5270-5310	2
	II-2C	5510-5710	6
802.11ac-VHT80	II-2A	5290	1
	II-2C	5530-5690	3
Remark: UNII Band II (DFS Function, Slave/no In service monitor, no Ad-Hoc mode)			

Mode	Modulation	Data Rate (Mbps)
802.11a	OFDM (BPSK/QPSK/16QAM/64QAM)	Up to 54
802.11n-HT20	OFDM (BPSK/QPSK/16QAM/64QAM)	Up to 144.4
802.11n-HT40		Up to 300
802.11ac-HT20	OFDM (BPSK/QPSK/16QAM/64QAM/256QAM)	Up to 173.3
802.11ac-HT40		Up to 400
802.11ac-VHT80		Up to 866.7

Channel List					
802.11a/n-HT20/ac-VHT20					
UNII Band	Channel Number	Frequency (MHz)	UNII Band	Channel Number	Frequency (MHz)
II-2A	52	5260	II-2C	120	5600
	56	5280		124	5620
	60	5300		128	5640
	64	5320		132	5660
II-2C	120	5600		136	5680
	124	5620		140	5700
	128	5640		144	5720
	132	5660			
	136	5680			

Channel List					
802.11n-HT40/ac-VHT40					
UNII Band	Channel Number	Frequency (MHz)	UNII Band	Channel Number	Frequency (MHz)
II-2A	54	5270	II-2C	126	5630
	62	5310		134	5670
II-2C	102	5510		142	5710
	110	5550			
	118	5590			

Channel List					
802.11ac-VHT80					
UNII Band	Channel Number	Frequency (MHz)	UNII Band	Channel Number	Frequency (MHz)
II-2A	58	5290	II-2C	106	5530
				122	5610
				138	5690

Note 1: 802.11ac has similar modulation to 802.11n at 20 MHz and 40 MHz bandwidths, we assess the worst case to be the representative mode in this report.

2: Test modes are presented at section 3.6.

3.4. Antenna Information

GPS Antenna					
No.	Antenna Part Number	Manufacture	Antenna Type	Frequency (MHz)	Max Gain (dBi)
1	13-130-JC5150	Joinsoon Electronics MFG. CO.,LTD	PCB	1510 to 1602	4.62

2.4G Antenna					
No.	Antenna Part Number	Manufacture	Antenna Type	Frequency (MHz)	Max Gain (dBi)
1	13-130-002075 (Tx1 Antenna)	Joinsoon Electronics MFG. CO.,LTD	PIFA	2400 to 2500	-2.53
2	13-130-002076 (Tx2 Antenna)		PIFA	2400 to 2500	-1.15

5G Antenna					
No.	Antenna Part Number	Manufacture	Antenna Type	Frequency (MHz)	Max Gain (dBi)
1	13-130-002075 (Tx1 Antenna)	Joinsoon Electronics MFG. CO.,LTD	PIFA	5150 to 5350	-0.53
2				5470 to 5725	0.82
3				5725 to 5850	0.82
4	13-130-002076 (Tx2 Antenna)	Joinsoon Electronics MFG. CO.,LTD	PIFA	5150 to 5350	0.90
5				5470 to 5725	0.53
6				5725 to 5850	0.53

3.5. Descriptions of Key Components

3.5.1. For the All Component Lists

Item	Supplier	Model / Type	Character
Main Board	ECS	TC71A	---
CPU (Socket: BGA1380)	Intel	Z8550	1.44GHz, up to 2.4GHz
Memory (On Board)	SK hynix	H9CCNNNBPTBL	LPDDR3 1600MHz 4GB
7" LCD Panel	KD	KD070D30-31NB-A18	LCD.WXGA.7.800*1280
Touch Module	TOPGROUP EETI	ZC-122A-0776AT EXC3102	Support 10-points multi-touch(Capacitive)
Storage	SanDisk	SDINADF4-64G	64GB
	SanDisk	SDIN9DW4-32G	32GB
Front Camera	Broadsands	BLX2722E-TC7AW-F	Front Camera : 2.0M
Rear Camera	Broadsands	BLX8858E-TC7AW-CB	Rear Camera: 8.0M
Wi-Fi +BT Module	Qualcomm (Azurewave)	QCNFA324 (AW-CM217NF)	Wi-Fi 802.11 a/b/g/n/ac + BT 4.0
GPS	Boradcam	BCM4752	GPS&GLONASS
NFC	NXP	NPC100	---
Battery	Sunwoda	MICA-071	3.7Vdc,4100mAh / 15.17Wh
AC Adapter	Asian Power Devices Inc.	WA-36A12R (Wall-mount, 2C)	I/P: AC 100-240V, 50-60Hz, 0.9A Max. O/P: DC 12V, 3A
			DC Power Cord: Unshielded, Undetachable, 1.8m With one ferrite core
mPad Module (Option)	ECS	Barcode Scanner mPAD	Barcode Scanner
	ECS	SCR mPAD	Smart Card Reader (SCR)
	ECS	MSR mPAD	Magnetic Stripe Reader (MSR)
	ECS	USB Ethernet mPAD	Giga LAN Port
7" Pad Docking (Option)	ECS	DOCKING mPAD-7	Docking

Remark: For more detailed features description, please refer to the manufacturer's specifications or the user manual.

3.5.2. The EUT collocates with following worst components, which are used to establish a basic configuration of system during test:

Item	Supplier	Model / Type	Character
Main Board	ECS	TC71A	---
CPU (Socket: BGA1380)	Intel	Z8550	1.44GHz, up to 2.4GHz
Memory (On Board)	SK hynix	H9CCNNNBPTBL	LPDDR3 1600MHz 4GB
7" LCD Panel	KD	KD070D30-31NB-A18	LCD.WXGA.7.800*1280
Touch Module	TOPGROUP EETI	ZC-122A-0776AT EXC3102	Support 10-points multi-touch(Capacitive)
Storage	SanDisk	SDIN9DW4-32G	32GB
Front Camera	Brodsands	BLX2722E-TC7AW-F	Front Camera : 2.0M
Rear Camera	Brodsands	BLX8858E-TC7AW-CB	Rear Camera: 8.0M
Wi-Fi +BT Module	Qualcomm (Azurewave)	QCNFA324 (AW-CM217NF)	Wi-Fi 802.11 a/b/g/n/ac + BT 4.0
GPS	Boradcam	BCM4752	GPS&GLONASS
NFC	NXP	NPC100	---
Battery	Sunwoda	MICA-071	3.7Vdc,4100mAh / 15.17Wh
AC Adapter	Asian Power Devices Inc.	WA-36A12R (Wall-mount, 2C)	I/P: AC 100-240V, 50-60Hz, 0.9A Max. O/P: DC 12V, 3A
		DC Power Cord: Unshielded, Undetachable, 1.8m With one ferrite core	
mPad Module (Option)	ECS	Barcode Scanner mPAD	Barcode Scanner
7" Pad Docking (Option)	ECS	DOCKING mPAD-7	Docking

3.6. Test Configuration

Item	Bandwidth	Test Channel
Channel Move Time & Channel Closing Transmission Time	20MHz	52/100
	40MHz	54/102
	80MHz	58/106
Non-Occupancy Period & Non-associated Test	20MHz	52/100
	40MHz	54/102
	80MHz	58/106

3.7. Tested Supporting System List

Item	Manufacturer	Model	Remark
AP Server embedded with Wireless AC Module			
AP Server	TP-LINK	DIR-868L	FCC ID: KA2IR868LA1
Wireless AC Module	Aplpha	WMC-AC01	FCC ID: RRK2012060056-1

3.8. Description of Test Facility

Name of Test Firm	Audix Technology Corporation / EMC Department No. 53-11, Dingfu, Linkou Dist., New Taipei City 244, Taiwan Tel: +886-2-26092133 Fax: +886-2-26099303 Website : www.audixtech.com Contact e-mail: sales@audixtech.com
Accreditations	The laboratory is accredited by following organizations under ISO/IEC 17025:2005 (1) NVLAP(USA) NVLAP Lab Code 200077-0 (2) TAF(Taiwan) No. 1724 (3) FCC OET Designation No. TW1004 & TW1090
Test Facilities	(1) RF Test Room

3.9. Measurement Uncertainty

Test Item	Uncertainty
DFS Measurement	± 0.5 ms
Threshold	± 0.33 dB

4. MEASUREMENT EQUIPMENT LIST

Item	Type	Manufacturer	Model No.	Serial No.	Cal. Date	Cal. Due
1.	Vector Signal Generation	R&S	SMU200A	104893	2016. 07. 07	2017. 07. 06
2.	Spectrum Analyzer	Agilent	N9030A-544	US51350140	2016. 06. 07	2017. 06. 06
3.	Spectrum Analyzer	R&S	FSV30	101181	2016. 07. 14	2017. 07. 13
4.	Attenuator (10dB) X2	Worken	WK0602-10	0120A02208 001S	N.C.R	N.C.R
5.	Attenuator (30dB) X2	Worken	WK0602-30	0120A02208 002S	N.C.R	N.C.R

5. WORKING MODES AND REQUIREMENT TEST ITEM

5.1. Applicability of DFS Requirements Prior To Use A Channel

Requirement	Operational Mode		
	Master	Client without radar detection	Client with radar detection
Non-Occupancy Period	✓	Not required	✓
DFS Detection Threshold	✓	Not required	✓
Channel Availability Check Time	✓	Not required	Not required
Uniform Spreading	✓	Not required	Not required
U-NII Detection Bandwidth	✓	Not required	✓

5.2. Applicability of DFS Requirements During Normal Operation

Requirement	Operational Mode		
	Master	Client without radar detection	Client with radar detection
DFS Detection Threshold	✓	Not required	✓
Channel Closing Transmission Time	✓	✓	✓
Channel Move Time	✓	✓	✓
U-NII Detection Bandwidth	✓	Not required	✓

6. DFS DETECTION THRESHOLDS AND RADAR TEST

WAVEFORMS

6.1. Interference Threshold Value, Master or Client Incorporating In-Service Monitoring

Maximum Transmit Power	Value (See Notes 1 and 2)
≥ 200 milliwatt	-64dBm
< 200 milliwatt	-62dBm

Note 1: This is the level at the input of the receiver assuming a 0 dBi receive antenna.

Note 2: Throughout these test procedures an additional 1 dB has been added to the amplitude of the test transmission waveforms to account for variations in measurement equipment. This will ensure that the test signal is at or above the detection threshold level to trigger a DFS response.

The radar Detection Threshold, lowest antenna gain is the parameter of interference radar DFS detection threshold.

6.2. Radar Test Waveform Minimum Step

Step intervals of 0.1 microsecond for Pulse Width, 1 microsecond for PRI, 1MHz for chirp width and 1 for the number of pulses will be utilized for the random determination of specific test waveforms.

6.3. Short Pulse Radar Test Waveforms

Radar Type	Pulse Width (μsec)	PRI (μsec)	Number of Pulse	Minimum Percentage of Successful Detection	Minimum number of Trials
0	1	1428	18	See Note 1	See Note 1
1A	1	15 unique PRI in KDB 905462 D02 Table 5a	$\text{Roundup}\left\{\left(\frac{1}{360}\right) \times \left(\frac{19 \times 10^6}{PRI}\right)\right\}$	60%	15
1B	1	15 unique PRI within 518-3066, Excluding 1A PRI		60%	15
2	1-5	150-230	23-29	60%	30
3	6-10	200-500	16-18	60%	30
4	11-20	200-500	12-16	60%	30
Aggregate (Radar Types 1-4)				80%	120
Note 1: Short Pulse Radar Type 0 should be used for the detection bandwidth test, channel move time, and channel closing time tests.					

A minimum of 30 unique waveforms are required for each of the short pulse radar types 2 through 4. For short pulse radar type 1, the same waveform is used a minimum of 30 times. If more than 30 waveforms are used for short pulse radar types 2 through 4, then each additional waveform must also be unique and not repeated from the previous waveforms. The aggregate is the average of the percentage of successful detections of short pulse radar types 1-4.

FCC Radar Types (1~4) System Diagram

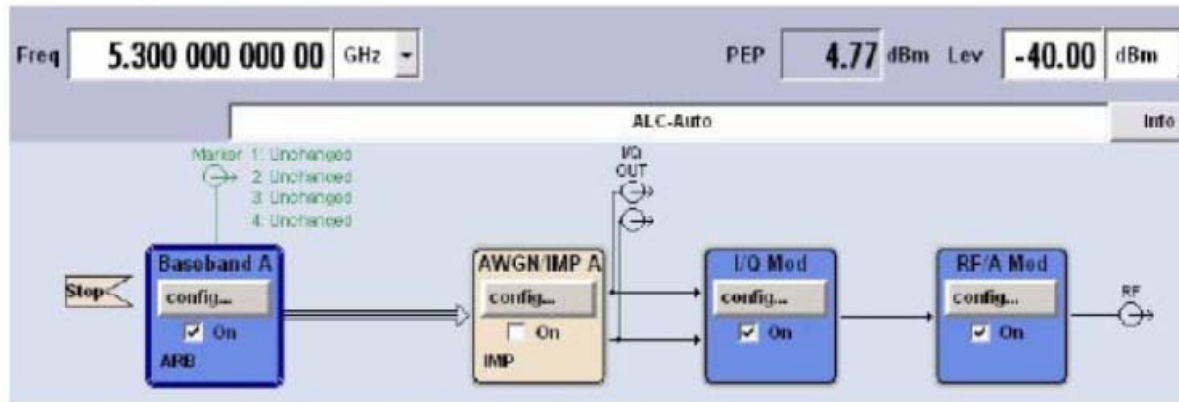

Used R&S SMU200A (Vector SG with two ARB)

B11: Base-band Generator with ARB (16M samples) and Digital Modulation

B13: Base-band Main Module

B106: frequency range (100 kHz to 6 GHz)

For selecting the waveform parameters from within the bounds of the signal type, system was random selection using uniform distribution.

6.4. Long Pulse Radar Test Waveforms

Radar Type	Pulse Width (µsec)	Chirp Width (MHz)	PRI (µsec)	Number of Pulse Per Burst	Number of Bursts	Minimum Percentage of Successful Detection	Minimum of Trials
5	50-100	5-20	1000-2000	1-3	8-20	80%	30

The parameters for this waveform are randomly chosen. Thirty unique waveforms are required for the Long Pulse radar test signal. If more 30 waveforms are used for the Long Pulse radar test signal, then each additional waveform must also be unique and not repeated from the previous waveforms. Each waveform is defined as following:

- (1) The transmission period for the Long Pulse Radar test signal is 12 seconds.
- (2) There are a total of 8 to 20 Bursts in the 12 second period, with the number of Bursts being randomly chosen. This number is Burst_Count.
- (3) Each Burst consists of 1 to 3 pulses, with the number of pulses being randomly chosen. Each Burst within the 12 second sequence may have a different number of pulses.
- (4) The pulse width is between 50 and 100 microseconds, with the pulse width being randomly chosen. Each pulse within a Burst will have the some pulse width. Pulses in different Bursts may have different pulse widths.

- (5) Each pulse has a linear FM chirp between 5 and 20MHz, with the chirp width being randomly chosen. Each pulse within a Burst will have the same chirp width. Pulses in different Burst may have different chirp widths. The chirp is centered on the pulse. For example, with a radar frequency of 5300MHz and a 20MHz chirped signal, the chirp starts at 5290MHz and ends at 5310MHz.
- (6) If more than one pulse is present in a Burst, the time between the pulses will be between 1000 and 2000 microseconds, with the time being randomly chosen. If three pulses are present in a Burst, the time between the first and second pulses is chosen independently of the time between the second and third pulses.
- (7) The 12 second transmission period is divided into even intervals. The number of intervals is equal to Burst_Count. Each interval is of length $(12000000/\text{Burst_Count})$ microseconds. Each interval contains one Burst. The start time for the Burst, relative to the beginning of the interval, is between 1 and $[(12000000/\text{Burst_Count}) - (\text{Total Burst length}) + (\text{One Random PRI interval})]$ microseconds, with the start time being randomly chosen. The step interval for the start time is 1 microsecond. The start time for each Burst is chosen independently.

A representative example of a Long Pulse radar test waveform:

- (1) The total test signal length is 12 seconds.
- (2) 8 Bursts are randomly generated for the Burst_Count.
- (3) Burst 1 has 2 randomly generated pulses.
- (4) The pulse width (for both pulses) is randomly selected to be 75 microseconds.
- (5) The PRI is randomly selected to be at 1213 microseconds.
- (6) Bursts 2 through 8 are generated using steps 3-5.
- (7) Each Burst is contained in even intervals of 1500000 microseconds. The starting location for Pulse 1. Burst 1 is randomly generated (1 to 1500000 minus the total Burst 1 length + 1 random PRI interval) at the 325001 microsecond step. Bursts 2 through 8 randomly fall in successive 1500000 microsecond intervals (i.e. Burst 2 falls in the 1500001-3000000 microsecond range).

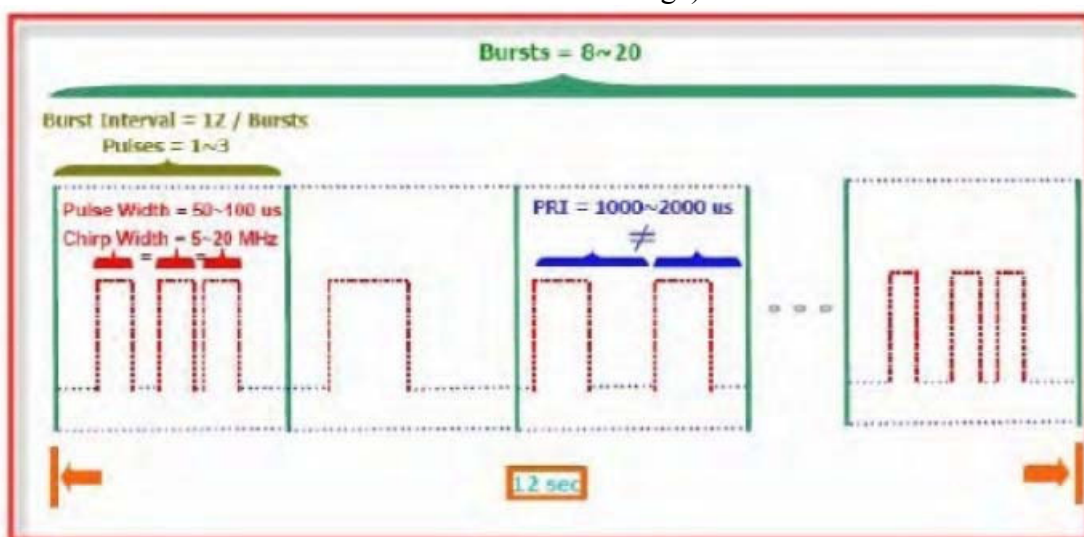

FCC Radar Types (5) System Diagram

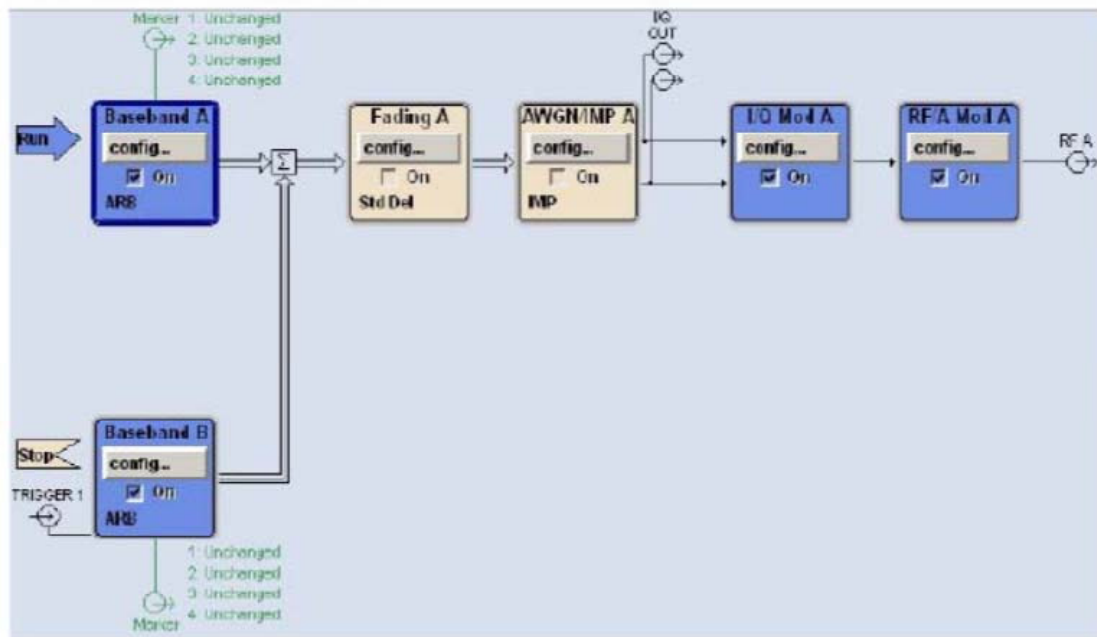

Used R&S SMU200A (Vector SG with two ARB)

Path A/Path B Two B11: Base-band Generator with ARB (16M samples) and Digital Modulation

B13: Base-band Main Module

B106: frequency range (100 kHz to 6 GHz)

For selecting the waveform parameters from within the bounds of the signal type, system was random selection using uniform distribution.

6.5. Frequency Hopping Pulse Radar Test Waveforms

Radar Type	Pulse Width (μsec)	PRI (μsec)	Pulses Per Hop	Hopping Rate (kHz)	Hopping Sequence Length (ms)	Minimum Percentage of Successful Detection	Minimum of Trials
6	1	333	9	0.333	300	70%	30

For the Frequency Hopping Radar Type, the same Burst parameters are used for each waveform. The hopping sequence is different for each waveform and a 100-length segment is selected from the hopping sequence defined by the following algorithm:

The first frequency in a hopping sequence is selected randomly from the group of 475 integer frequencies form 5250-5274MHz. Next, the frequency that was just chosen is removed from the group and a frequency is randomly selected from the remaining 474 frequencies in the group. This process continues until all 475 frequencies are chosen for the set. For selection of random frequency, the frequencies remaining within the group are always treated as equally likely.

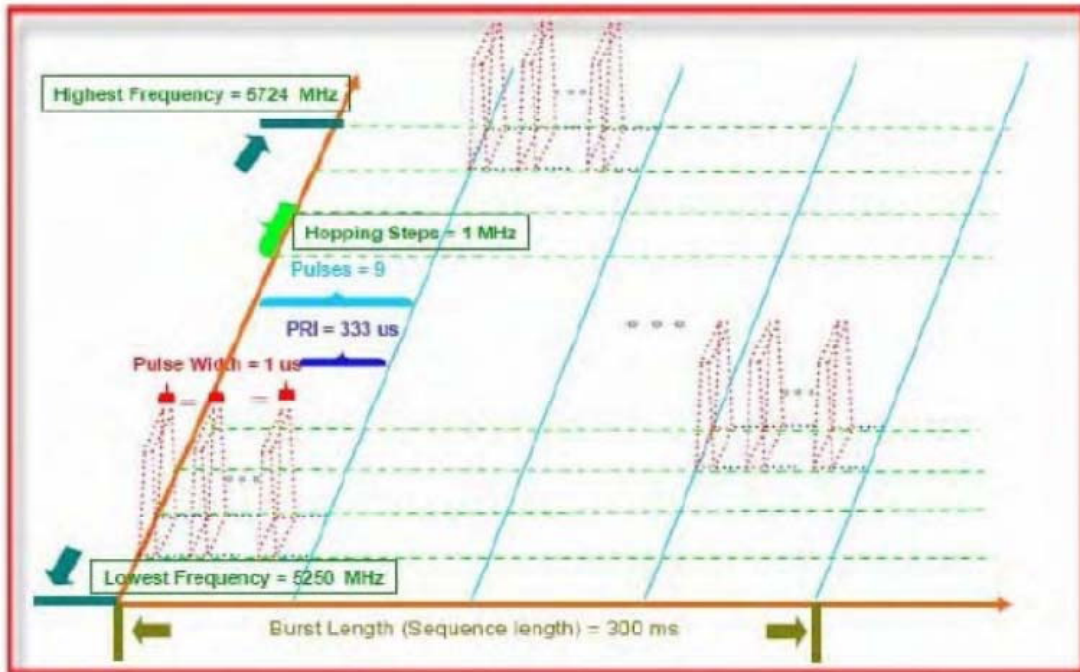

FCC Radar Types (6) System Diagram

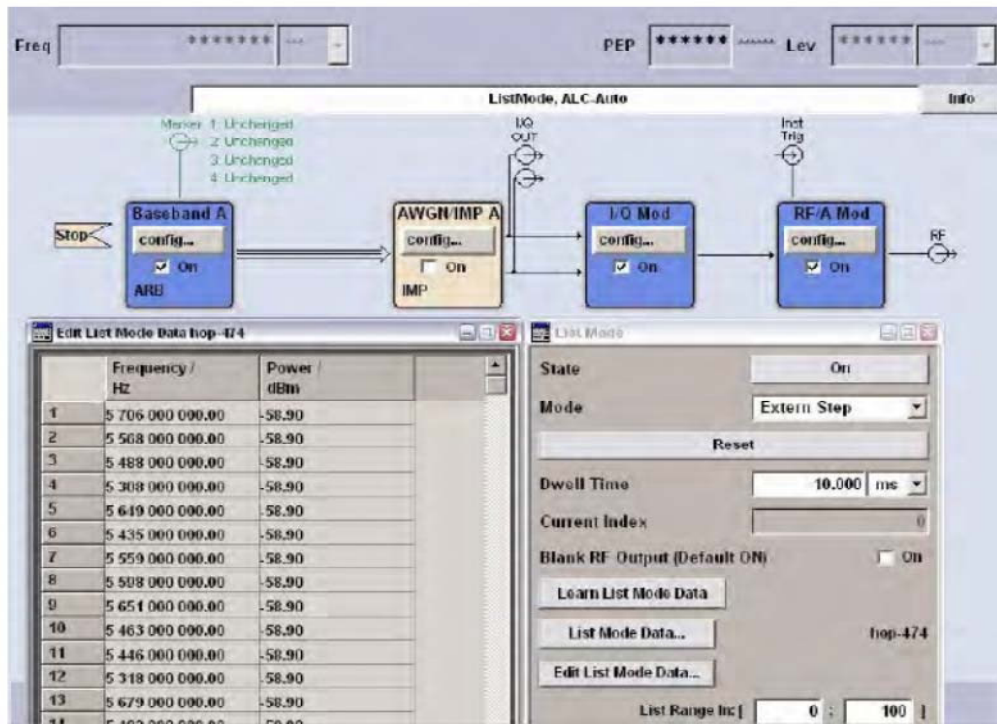

Used R&S SMU200A (Vector SG with two ARB)

B11: Base-band Generator with ARB (16M samples) and Digital Modulation

B13: Base-band Main Module

B106: frequency range (100 kHz to 6 GHz)

For selecting the waveform parameters from within the bounds of the signal type, system was random selection using uniform distribution.

6.6. Conducted Calibration Setup

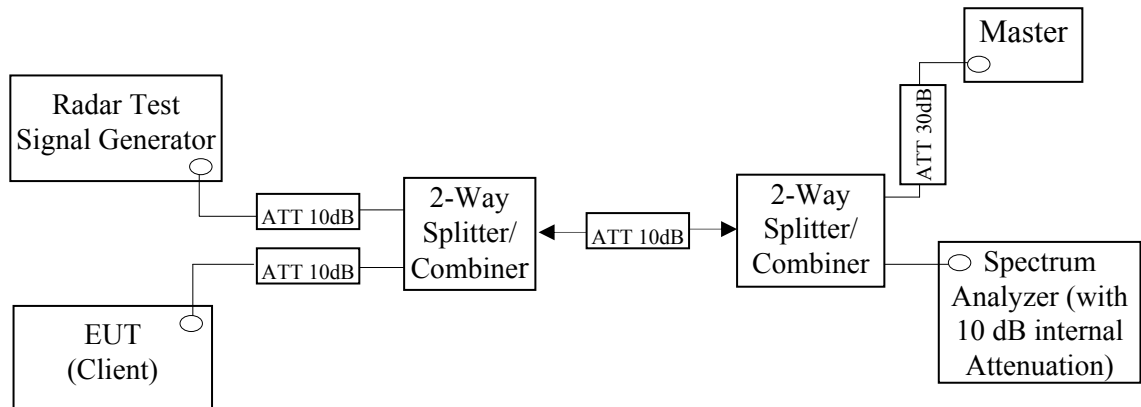

6.7. Radar Waveform Calibration Procedure

The measured frequency is 5500MHz, 5510MHz and 5530MHz. The radar signal was the same as transmitted channels, and injected into the antenna port of AP (master) or Client Device with Radar Detection, measured the channel closing transmission time and channel move time. The calibrated conducted detection threshold level is set to -62dBm. The tested level is lower than required level hence it provides margin to the limit.

6.8. Calibration Deviation

There is no deviation with the original standard.

6.9. Radar Waveform Calibration Result

DFS detection threshold level and the burst of pulses on the Channel frequency

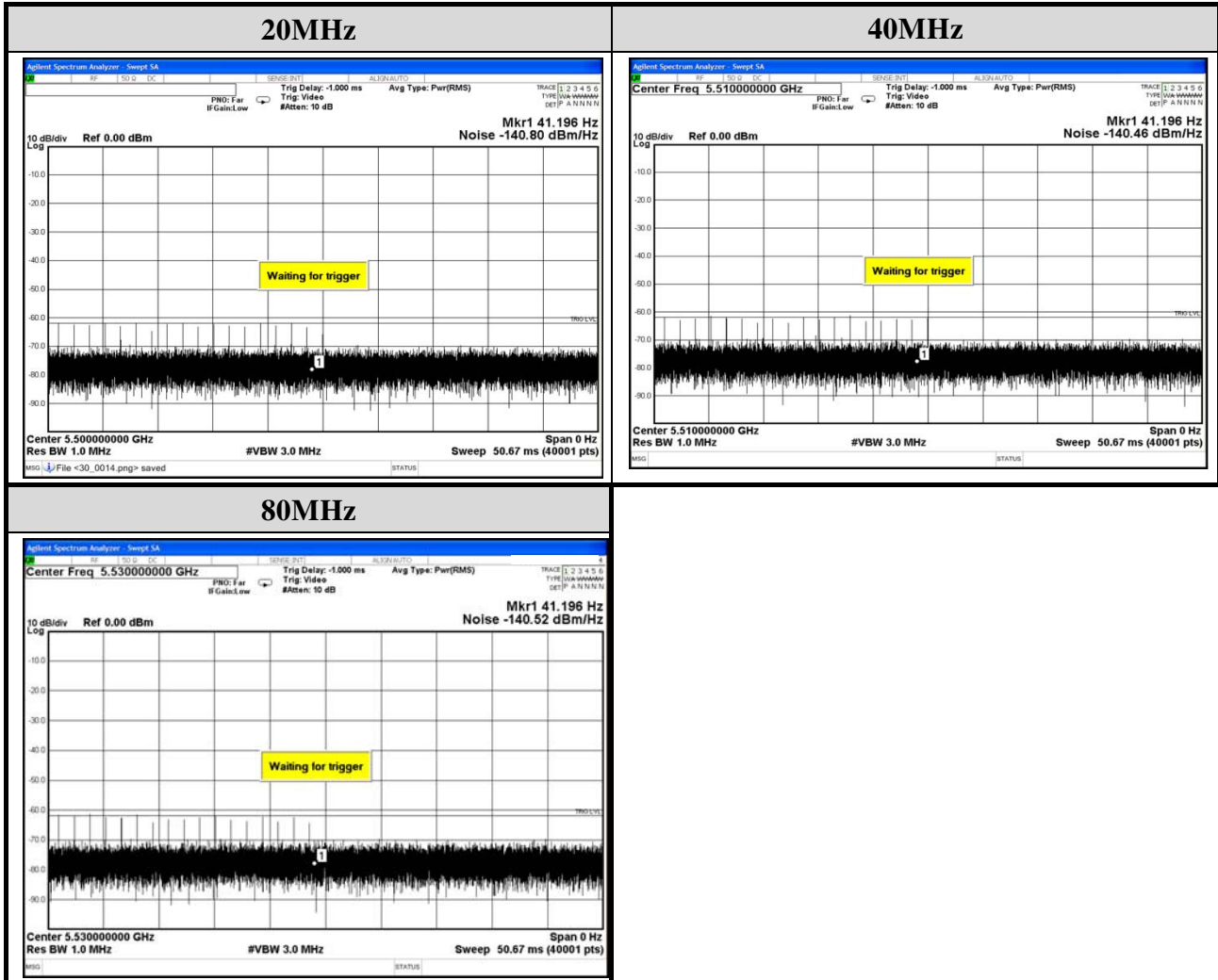

7. TEST SETUP AND TEST RESULT

7.1. Test Setup

7.1.1. Test Setup Diagram

Following is the test setup for generated the radar waveforms and used to monitor UNII device.

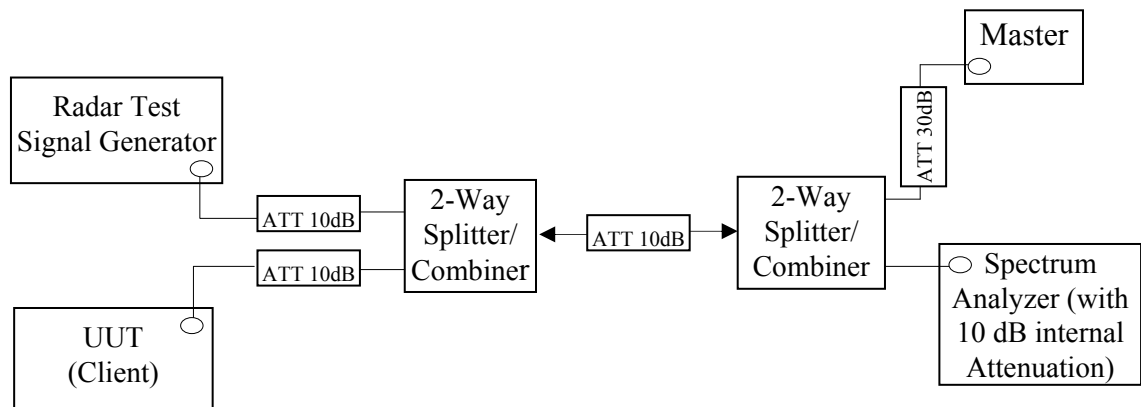

7.1.2. Test Setup Operation

System testing was performed with the designated MPEG test file that streams full motion video from the Access Point to Client in full motion video mode using the media player with the V2.61 Codec package. This file is used by IP and Frame based systems for loading the test channel during the in-service compliance testing of the U-NII device.

The waveform parameters from within the bounds of the signal type are selected randomly using uniform distribution.

A spectrum analyzer is used as a monitor to verify that the EUT has vacated the Channel within the (Channel Closing Transmission Time and Channel Move Time, and does not transmit on a Channel during the Non-Occupancy Period after the detection and Channel move. It is also used to monitor EUT transmissions during the Channel Availability Check Time.

7.1.3. Test Setup for Data Traffic Plot

Test Date	2017/03/14	Temp./Hum.	25°C/55%
-----------	------------	------------	----------

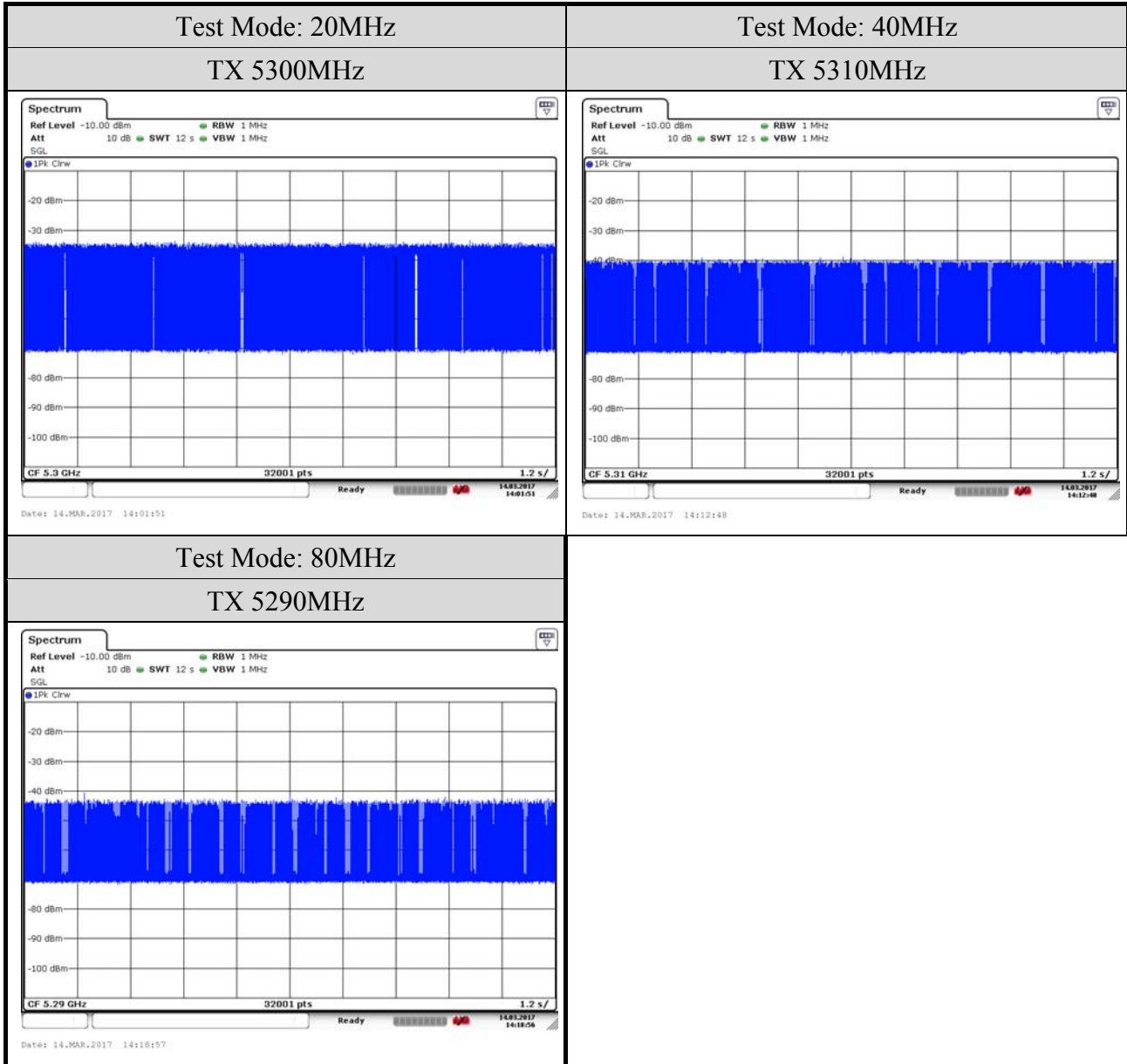

7.2. Channel Move Time, Channel Closing Transmission Time, Non-Occupancy Period, Non-Associated Client Beacon Measurement

7.2.1. Limit

Parameter	Value
Channel Move Time	10 seconds See Note 1.
Channel Closing Transmission Time	200 milliseconds + an aggregate of 60 milliseconds over remaining 10 second period. See Notes 1 and 2.
Non-Occupancy Period	Non-Occupancy Period time is 30 minute during which a Channel will not be utilized after a Radar Waveform is detected on that Channel
Non-Associated Client Beacon	The non-associated Client Beacon Test is during the 30 minutes observation time. The EUT should not make any transmissions in the DFS band after EUT power up.
<p>Note 1: The instant that the Channel Move Time and the Channel Closing Transmission Time begins is as follows:</p> <ol style="list-style-type: none">For the Short Pulse Radar Test Signals this instant is the end of the Burst.For the Frequency Hopping radar Test Signal, this instant is the end of the last radar Burst generated.For the Long Pulse Radar Test Signal this instant is the end of the 12 second period defining the Radar Waveform. <p>Note 2: The Channel Closing Transmission Time is comprised of 200 milliseconds starting at the beginning of the Channel Move Time plus any additional intermittent control signals required to facilitate a Channel move (an aggregate of 60 milliseconds) during the remainder of the 10 second period. The aggregate duration of control signals will not count quiet periods in between transmissions.</p>	

7.2.2. Test Procedures

- 7.2.2.1. When a radar Burst with a level equal to the DFS Detection Threshold + 1dB is generated on the operating channel of the U-NII device. A U-NII device operating as a Client Device will associate with the Master of channel. Stream the MPEG test file from the Master Device to the Client Device on the selected channel for entire period of the test. At time to the radar waveform generator sends a Burst of pulses for each of the radar types at Detection Threshold + 1dB.
- 7.2.2.2. Observe the transmissions of the EUT at the end of the radar Burst on the Operating channel. Measure and record the transmissions from the EUT during the observation time [Channel Move Time]. One 10 Second plot be reported for the short Pulse Radar type 1-4 and one for the Long Pulse Radar Type test in a 22 second plot. The plot for the Short Pulse Radar types start at the end of the radar burst. The Channel Move Time will be calculated based on the plot of the short Pulse Radar Type. The Long Pulse Radar Type plot show the device ceased transmissions within the 10 second window after detection has occurred. The plot for the Long Pulse Radar type should start at the beginning of the 12 second waveform.
- 7.2.2.3. Measure the EUT for more than 30 minutes following the channel close/move time to verify that the EUT does not resume only transmissions on this channel.

7.2.3. Test Result for Channel Closing Transmission Time & Channel Move Time

Test Date	2017/03/14	Temp./Hum.	25°C/55%
Test Mode	20MHz	Frequency	TX 5300MHz

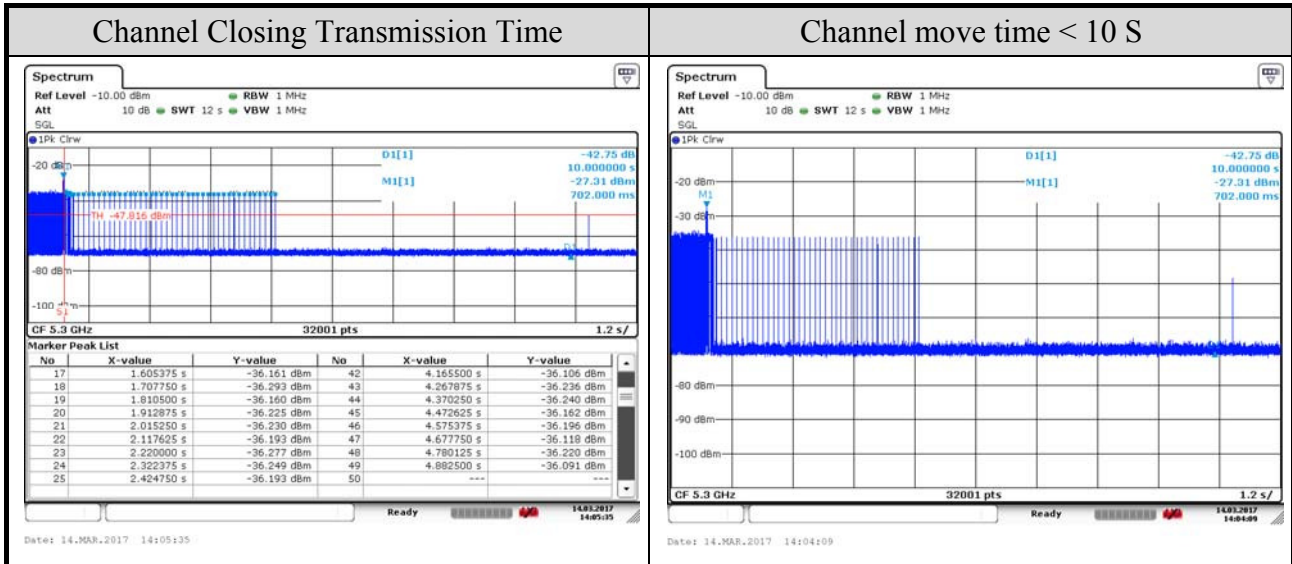

Channel Closing Transmission Time Calculated	
Sweep Time(S) sec	12
Sweep points (P)	32001
Number of Sweep points in 10 sec (N)	49
Channel Closing Time (C) ms	18.37

Channel closing time is calculated from $C=N * dwell$; where dwell is the occupancy time per sweep point calculated by the formula: $dwell=S/P$. N is the number of sweep points indicating transmission after S1; where S1 is the radar signal detected

Test Date	2017/03/14	Temp./Hum.	25°C/55%
Test Mode	20MHz	Frequency	TX 5500MHz

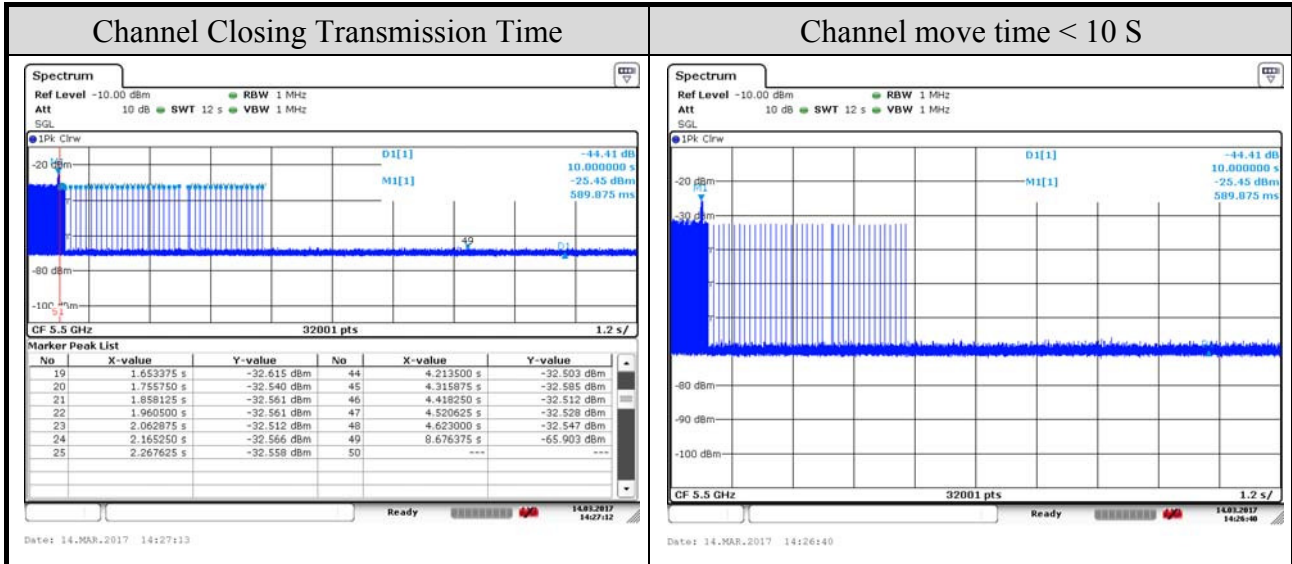

Channel Closing Transmission Time Calculated	
Sweep Time(S) sec	12
Sweep points (P)	32001
Number of Sweep points in 10 sec (N)	49
Channel Closing Time (C) ms	18.37

Channel closing time is calculated from $C=N * dwell$; where dwell is the occupancy time per sweep point calculated by the formula: $dwell=S/P$. N is the number of sweep points indicating transmission after S1; where S1 is the radar signal detected

Test Date	2017/03/14	Temp./Hum.	25°C/55%
Test Mode	40MHz	Frequency	TX 5310MHz

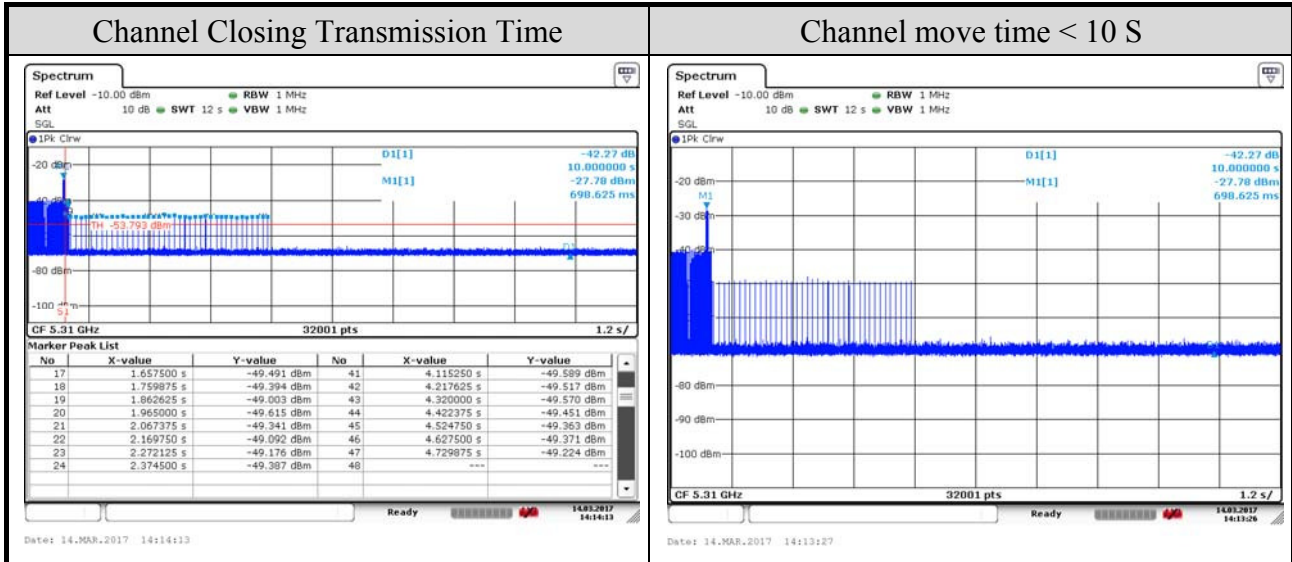

Channel Closing Transmission Time Calculated	
Sweep Time(S) sec	12
Sweep points (P)	32001
Number of Sweep points in 10 sec (N)	47
Channel Closing Time (C) ms	17.62

Channel closing time is calculated from $C=N * dwell$; where dwell is the occupancy time per sweep point calculated by the formula: $dwell=S/P$. N is the number of sweep points indicating transmission after S1; where S1 is the radar signal detected

Test Date	2017/03/14	Temp./Hum.	25°C/55%
Test Mode	40MHz	Frequency	TX 5510MHz

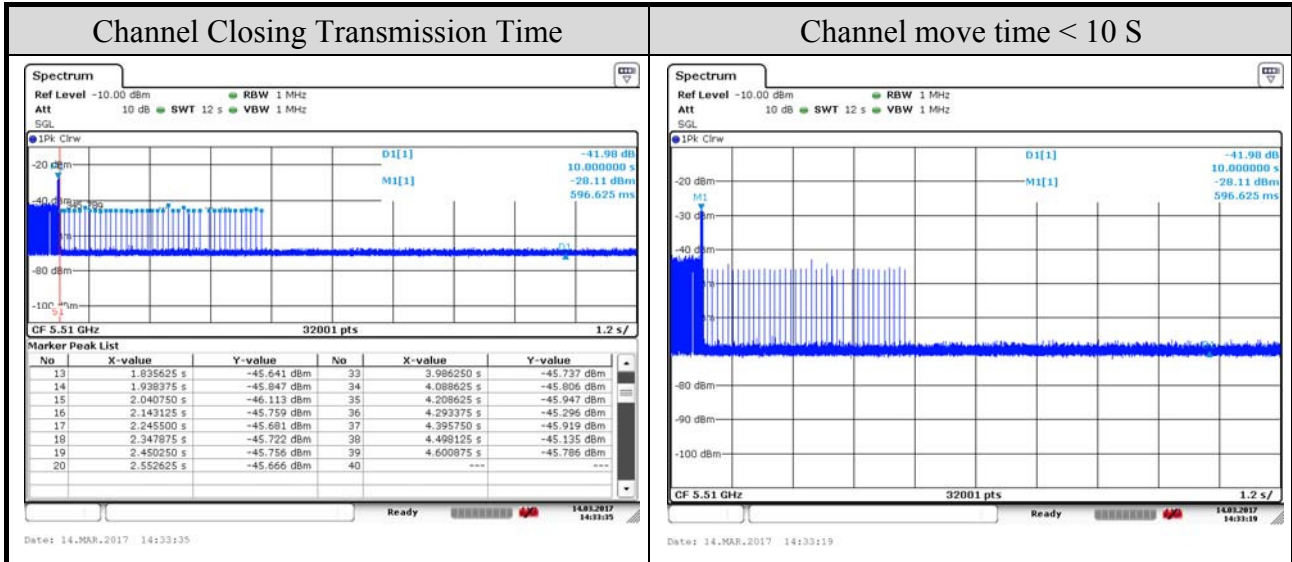

Channel Closing Transmission Time Calculated	
Sweep Time(S) sec	12
Sweep points (P)	32001
Number of Sweep points in 10 sec (N)	39
Channel Closing Time (C) ms	14.62

Channel closing time is calculated from $C=N * dwell$; where dwell is the occupancy time per sweep point calculated by the formula: $dwell=S/P$. N is the number of sweep points indicating transmission after S1; where S1 is the radar signal detected

Test Date	2017/03/14	Temp./Hum.	25°C/55%
Test Mode	80MHz	Frequency	TX 5290MHz

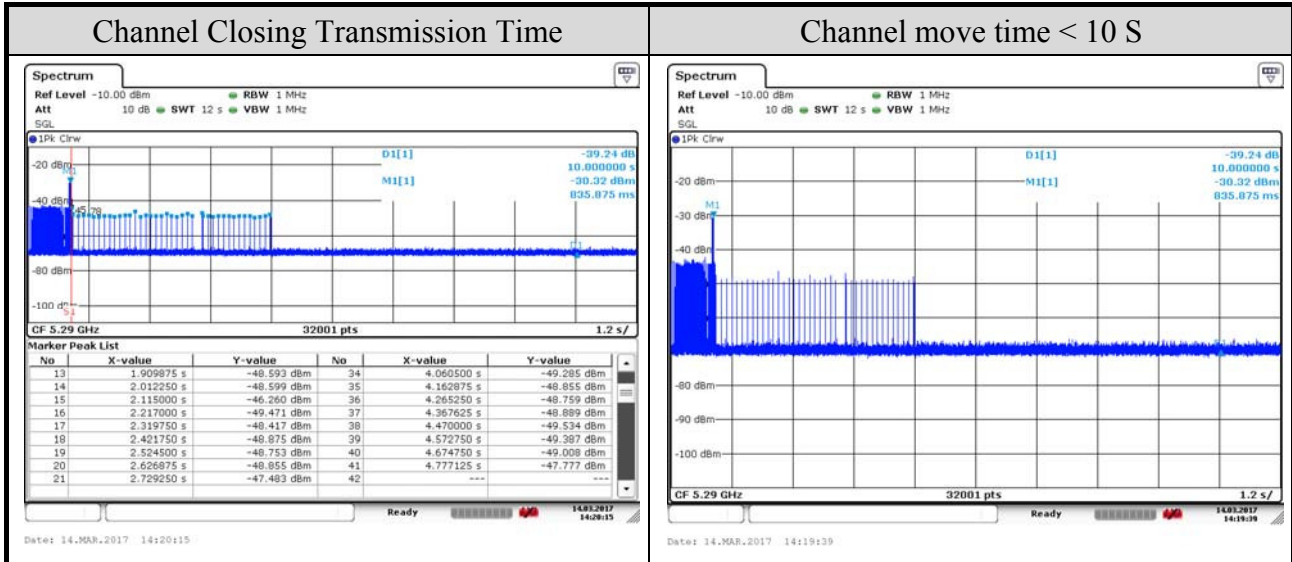

Channel Closing Transmission Time Calculated	
Sweep Time(S) sec	12
Sweep points (P)	32001
Number of Sweep points in 10 sec (N)	41
Channel Closing Time (C) ms	15.37

Channel closing time is calculated from $C=N * dwell$; where dwell is the occupancy time per sweep point calculated by the formula: $dwell=S/P$. N is the number of sweep points indicating transmission after S1; where S1 is the radar signal detected

Test Date	2017/03/14	Temp./Hum.	25°C/55%
Test Mode	80MHz	Frequency	TX 5530MHz

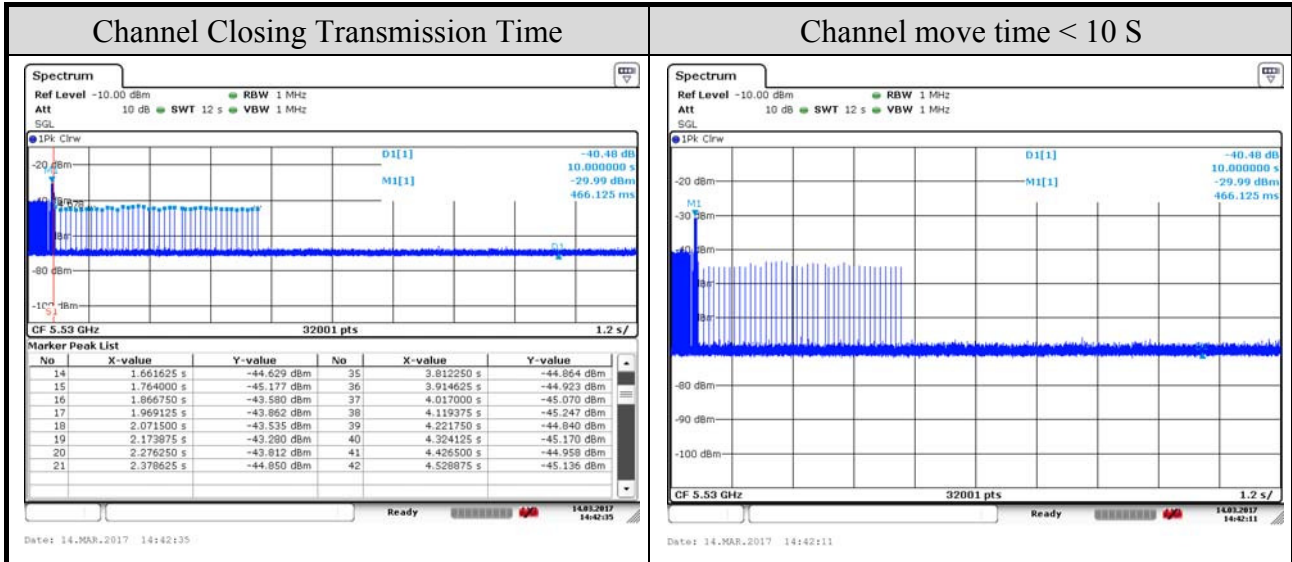

Channel Closing Transmission Time Calculated	
Sweep Time(S) sec	12
Sweep points (P)	32001
Number of Sweep points in 10 sec (N)	42
Channel Closing Time (C) ms	15.75

Channel closing time is calculated from $C=N * dwell$; where dwell is the occupancy time per sweep point calculated by the formula: $dwell=S/P$. N is the number of sweep points indicating transmission after S1; where S1 is the radar signal detected

7.2.4. Test Result for Non-Occupancy Period, Non-associated Test

Test Date	2017/03/14	Temp./Hum.	25°C/55%
-----------	------------	------------	----------

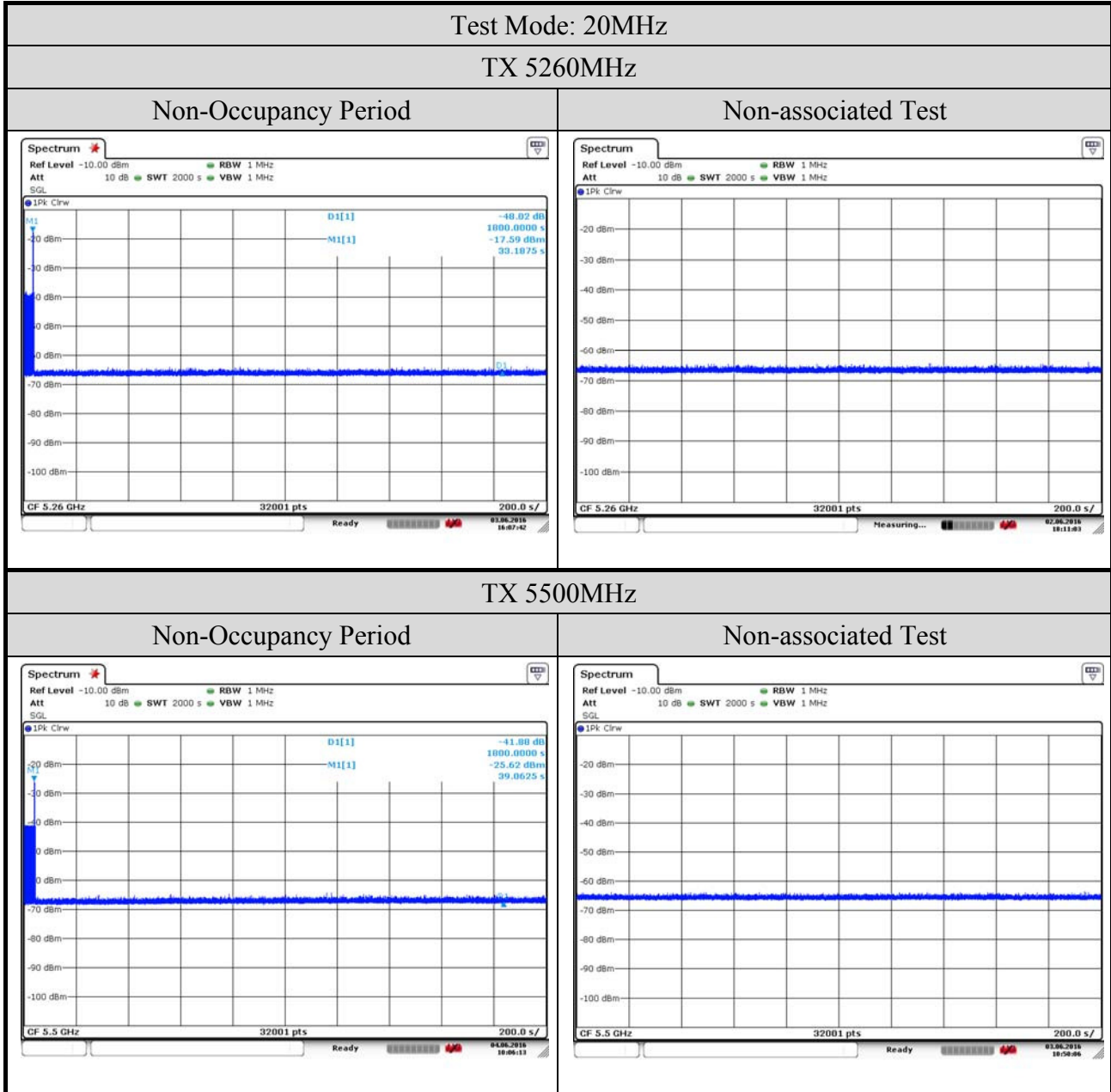

Test Date	2017/03/14	Temp./Hum.	25°C/55%
-----------	------------	------------	----------

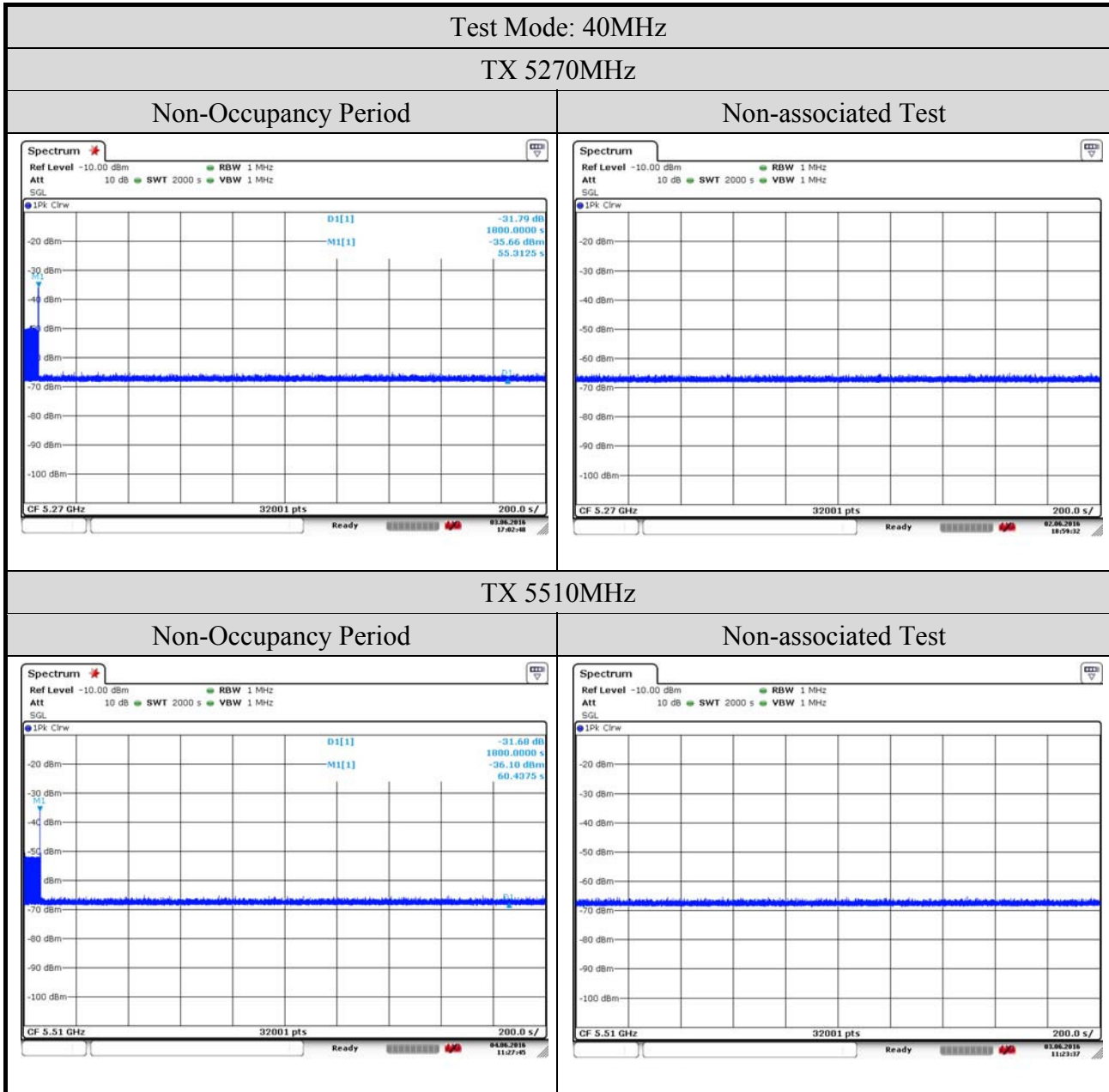

Test Date	2017/03/14	Temp./Hum.	25°C/55%
-----------	------------	------------	----------

