

APPLICATION FOR CERTIFICATION

On Behalf of

Elitegroup Computer Systems Co., Ltd.

7" Pocketable Pad

Model No. : (1)MICA-07..... (2)TABLET TB71.....

FCC ID : WL6TB71A-W

Brand: (1)ADVANTECH (2)ECS

Prepared for : Elitegroup Computer Systems Co., Ltd.  
No. 239, Sec. 2, Ti Ding Blvd.,  
Taipei, Taiwan

Prepared by : AUDIX Technology Corporation  
EMC Department  
No. 53-11, Dingfu, Linkou  
Dist., New Taipei City 244,  
Taiwan

Tel : (02) 2609-9301, 2609-2133  
Fax: (02) 2609-9303

File Number : C1S1404136  
Report Number : EM-F140296  
Date of Test : 2014. 05. 02~ 21  
Date of Report : 2014. 05. 23

# TABLE OF CONTENTS

Description	Page
TEST REPORT CERTIFICATION .....	4
<b>1. DESCRIPTION OF REVISION HISTORY .....</b>	<b>5</b>
<b>2. GENERAL INFORMATION .....</b>	<b>6</b>
2.1. Description of Device (EUT).....	6
2.2. Antenna Information.....	8
2.3. Description of Key Component Lists .....	9
2.4. Data Rate Relative to Output Power.....	10
2.5. Test Configuration for Each Test Item .....	10
2.6. Tested Supporting System Details.....	11
2.7. Description of Test Facility .....	12
2.8. Measurement Uncertainty.....	12
<b>3. CONDUCTED EMISSION MEASUREMENT.....</b>	<b>13</b>
3.1. Test Equipment.....	13
3.2. Block Diagram of Test Setup.....	13
3.3. Powerline Conducted Emission Limit (§15.207).....	13
3.4. Operating Condition of EUT .....	14
3.5. Test Procedure .....	14
3.6. Conducted Emission Measurement Results.....	14
<b>4. RADIATED EMISSION MEASUREMENT .....</b>	<b>17</b>
4.1. Test Equipment.....	17
4.2. Test Setup .....	17
4.3. Radiated Emission Limits (§15.209) .....	19
4.4. Operating Condition of EUT .....	19
4.5. Test Procedure .....	20
4.6. Test Results.....	21
<b>5. 6dB BANDWIDTH MEASUREMENT .....</b>	<b>45</b>
5.1. Test Equipment.....	45
5.2. Block Diagram of Test Setup.....	45
5.3. Specification Limits [§15.247(a)(2)] .....	45
5.4. Operating Condition of EUT .....	45
5.5. Test Procedure .....	45
5.6. Test Results.....	46
<b>6. MAXIMUM PEAK OUTPUT POWER MEASUREMENT .....</b>	<b>54</b>
6.1. Test Equipment.....	54
6.2. Block Diagram of Test Setup.....	54
6.3. Specification Limits (§15.247(b)-(3)).....	54
6.4. Operating Condition of EUT .....	54
6.5. Test Procedure .....	54
<b>7. EMISSION LIMITATIONS MEASUREMENT .....</b>	<b>56</b>
7.1. Test Equipment.....	56
7.2. Block Diagram of Test Setup.....	56
7.3. Specification Limits [§15.247(c)].....	56
7.4. Operating Condition of EUT .....	56
7.5. Test Procedure .....	56
7.6. Test Results.....	56
<b>8. BAND EDGES MEASUREMENT .....</b>	<b>81</b>
8.1. Test Equipment.....	81
8.2. Block Diagram of Test Setup.....	81

- 8.3. Specification Limits [§15.247(c)]..... 81
- 8.4. Operating Condition of EUT ..... 81
- 8.5. Test Procedure ..... 81
- 8.6. Test Results..... 81
- 9. POWER SPECTRAL DENSITY MEASUREMENT ..... 86**
- 9.1. Test Equipment..... 86
- 9.2. Block Diagram of Test Setup..... 86
- 9.3. Specification Limits [§15.247(d)]..... 86
- 9.4. Operating Condition of EUT ..... 86
- 9.5. Test Procedure ..... 86
- 9.6. Test Results..... 87
- 10. DEVIATION TO TEST SPECIFICATIONS..... 94**
- 11. PHOTOGRAPHS..... 95**
- 11.1. Photos of Conducted Disturbance Measurement ..... 95
- 11.2. Photos of Radiated Measurement at Semi-Anechoic Chamber ..... 96
- 11.3. Photo of Section RF Conducted Measurement ..... 100
- 11.4. Photo of Maximum Peak Output Power Measurement ..... 100



## **1. DESCRIPTION OF REVISION HISTORY**

Edition No.	Date of Revision	Revision Summary	Report Number
0	2014. 05. 23	Original Report.	EM-F140296

## 2. GENERAL INFORMATION

### 2.1. Description of Device (EUT)

Product	7" Pocketable Pad
Model Number	(1)MICA-07..... (2)TABLET TB71..... (The "." in the model name can be 0 to 9, A to Z, a to z, "-", "_", "\", "/" or blank, for marketing use only.) Above two models difference in brand and model name, others are the same. The model TABLET TB71A-W is test in this report
Serial Number	N/A
Brand Name	(1)ADVANTECH (2)ECS
Applicant	Elitegroup Computer Systems Co., Ltd. No. 239, Sec. 2, Ti Ding Blvd., Taipei, Taiwan
Manufacturer	Elitegroup Computer Systems Co., Ltd. No. 239, Sec. 2, Ti Ding Blvd., Taipei, Taiwan
FCC ID	WL6TB71A-W
Fundamental Range	802.11b/g/n-HT20: 2412MHz ~ 2462MHz 802.11a: 5180MHz ~ 5240MHz (UNII Band I) and 5260MHz ~ 5320MHz (UNII Band II-2A) and 5500MHz ~ 5700MHz (UNII Band II-2C) and 5745MHz ~ 5825MHz (UNII Band III) UNII Band II (DFS Function, Slave/no In service monitor, no Ad-Hoc mode) 802.11n-HT20: 2412MHz ~ 2462MHz and 5180MHz ~ 5240MHz (UNII Band I) and 5260MHz ~ 5320MHz (UNII Band II-2A) and 5500MHz ~ 5700MHz (UNII Band II-2C) and 5745MHz ~ 5825MHz (UNII Band III) UNII Band II (DFS Function, Slave/no In service monitor, no Ad-Hoc mode) 802.11n-HT40: 5190MHz ~ 5230MHz (UNII Band I) and 5270MHz ~ 5310MHz (UNII Band II-2A) and 5510MHz ~ 5670MHz (UNII Band II-2C) and 5755MHz ~ 5795MHz (UNII Band III) UNII Band II (DFS Function, Slave/no In service monitor, no Ad-Hoc mode) Bluetooth and BLE: 2402MHz ~ 2480MHz NFC: 13.56MHz GPS: 1575.42MHz

Frequency Channel	802.11b/g: 11 channels 802.11a: UNII Band I: 4 channels UNII Band II-2A: 4 channels UNII Band II-2C: 8 channels UNII Band III: 5 channels 802.11n-HT20: 2.4GHz: 11 channels 2.4G UNI Band I: 4channels UNII Band II-2A: 4 channels UNII Band II-2C: 8 channels UNII Band III: 5 channels 802.11n-HT40: UNII Band I: 2 channels UNII Band II-2A: 2 channels UNII Band II-2C: 3 channels UNII Band III: 2 channels Bluetooth: 79 channels BLE: 40 channels NFC: 1 Channel
Radio Technology	802.11b: DSSS Modulation (DBPSK/DQPSK/CCK) 802.11g: OFDM Modulation (BPSK/QPSK/16QAM/64QAM) 802.11a: OFDM Modulation (BPSK/QPSK/16QAM/64QAM) 802.11n: OFDM Modulation (MIMO) (BPSK/QPSK/16QAM/64QAM) Bluetooth: FHSS (GFSK, $\pi/4$ DQPSK, 8-DPSK) BLE: GFSK NFC: ASK
Data Transfer Rate	802.11b: 1/2/5.5/11Mbps 802.11a/g: 6/9/12/18/24/36/48/54Mbps 802.11n: up to 270Mbps BT: 1/2/3Mbps BLE: 1Mbps
Date of Receipt of Sample	2014. 04. 21
<p>Note: This EUT has 2.4GHz (WLAN, Bluetooth and BLE), 5GHz and NFC function. See below for related test reports based on radio functionality.</p> <ol style="list-style-type: none"> <li>1. The 2.4GHz (WLAN and BLE) function has been test in other report of EM-F140296.</li> <li>2. The 5GHz function has been test in other report of EM-F140297.</li> <li>3. The Bluetooth function has been test in other report of EM-F140298.</li> <li>4. The DFS function has been test in other report of EM-F140303.</li> <li>5. The NFC function has been test in other report of EM-F140299.</li> </ol>	

## 2.2. Antenna Information

Antenna Part Number	Manufacture	Antenna Type	Peak Gain W/ Cable loss (dBi)			
			Frequency (MHz)		Max Gain (Peak) (dBi)	
WLAN/BT Antenna: E22-003-007-037 -8014b (Main)	INNETECH (Tianjin) Electronics Co. Ltd.	PCB Antenna	2400	5180	1.33	-1.53
			2412	5190	1.92	-1.53
			2417	5310	2.07	0.66
			2422	5320	2.19	0.05
			2427	5500	2.44	-0.19
			2432	5510	2.59	-0.41
			2437	5670	2.78	-1.57
			2442	5700	2.83	-3.16
			2447	5745	2.87	-3.55
			2450	5765	2.78	-2.70
			2452	5785	2.76	-2.93
			2457	5805	2.68	-3.46
			2462	5825	2.47	-3.15
			2467		2.38	
			2472		2.52	
			2500		2.17	
WLAN Antenna: E22-003-007-037 -8014b (AUX)	INNETECH (Tianjin) Electronics Co. Ltd.	PCB Antenna	2400	5180	3.08	0.61
			2412	5190	3.43	0.39
			2417	5310	3.10	0.91
			2422	5320	3.07	0.14
			2427	5500	2.78	-0.35
			2432	5510	2.68	-0.40
			2437	5670	2.63	-0.62
			2442	5700	2.49	-1.25
			2447	5745	2.68	-1.02
			2450	5765	2.60	0.06
			2452	5785	2.77	-0.30
			2457	5805	2.75	-0.23
			2462	5825	2.82	-0.09
			2467		2.77	
			2472		2.68	
			2500		2.58	
GPS Antenna	INNETECH (Tianjin) Electronics Co. Ltd.	PCB Antenna	1565		-3.38	
			1575		-2.87	
			1585		-3.25	
			1597		-2.42	
			1602		-2.22	
			1606		-1.98	
			1616		-1.37	



### 2.3. Description of Key Component Lists

Item		Supplier	Description	Character
System		Microsoft	Windows 8	---
Main Board		ECS	TB71A-W	
LCD Module		CPTF	CLAT070WP0D	7 inch CPT 800x1280 -10 point touch
CPU		Intel	Intel® Atom™ Processor Bay Trail	T Z3770, 1.46GHz Burst frequency 2.39GHz (Socket: BGA1380)
GPU		Intel	---	HD Graphics
Memory		Hynix	H9CCNNN8KTMLBR-N TM	LP DDR3 2GB (up to 4G)
SSD		Sandisk	SDIN8DE4-32G	eMMC 32GB
Battery Pack		Sunwoda	MICA-071	3.7V / 4100 mAh /15.17Wh
Front Camera		LiteON	NL89A141	sensor Sony IMX175 .8MP
Rear Camera		LiteON	13P2SF206	sensor OV2722, 2MP
Barcode Scanner		Itermec	ED30	Decode Board + EA31 Imager
Touch Pad		CPTF	CLAA070WP03	--
WLAN+BT Combo Module		MITSUMI	DWM-W095A	WLAN: 2.412GHz to 2.472GHz 5.18GHz to 5.85GHz BT4.0+BLE: 2.402GHz to 2.480GHz
NFC		NXP	PN544PC	13.56MHz
GNSS		MITSUMI	SPG-SF102	GPS: 1575.42MHz GLONASS: 1598.0625 to 1605.375 MHz
WLAN/ BT Antenna	Main	INNETECH ELECTRONICS	e22-003-007-037-8014b	Laser Direct Structuring (LDS) Antenna on frame
	AUX	INNETECH ELECTRONICS	e22-003-007-037-8014b	Laser Direct Structuring (LDS) Antenna on frame
Stylus Pen		FO	BLACK/#8513.	CAPACITIVE TOUCH PEN
USB Charger		Chicony	W12-010N3A	I/P: 100-240V~, 50-60Hz, 0.3A O/P: 5V, 2A
Docking		AdvanTech	MICA-071-DCRE	DC 5V
		ECS	DOCKING TB71A-W	DC 5V
Docking Power Adapter		Asian	WA-20A05FU	I/P: 100-240V~, 0.6A, 50-60Hz O/P: 5V, 4A
		Power Cord: Non-Shielded, Undetached, 1.8m, Bonded a ferrite core		
USB Charge Docking Cable		Shielded, Detachable, 1.2m		
HDMI Docking Cable		Shielded, Detachable, 0.17m		
USB3.0 Docking Cable		Shielded, Detachable, 0.23m		

Remark: For a more detailed features description, please refer to the manufacturer's specifications or the user manual.

## 2.4. Data Rate Relative to Output Power

802.11b			
Channel	Modulation	Date Rate(Mbps)	Power(dBm)
1	DBPSK	1	<b>15.95</b>
1	DQPSK	2	<b>15.93</b>
1	CCK	5.5	<b>15.93</b>
1	CCK	11	<b>15.91</b>

802.11g			
Channel	Modulation	Date Rate (Mbps)	Power (dBm)
1	BPSK	MCS0	<b>12.51</b>
1	BPSK	MCS1	<b>12.48</b>
1	QPSK	MCS2	<b>12.47</b>
1	QPSK	MCS3	<b>12.45</b>
1	16-QAM	MCS4	<b>12.45</b>
1	16-QAM	MCS5	<b>12.41</b>
1	64-QAM	MCS6	<b>12.41</b>
1	64-QAM	MCS7	<b>12.40</b>

802.11n-HT20			
Channel	Modulation	Date Rate (Mbps)	Power (dBm)
1	BPSK	MCS0	<b>14.19</b>
1	QPSK	MCS1	<b>14.17</b>
1	QPSK	MCS2	<b>14.18</b>
1	16-QAM	MCS3	<b>14.15</b>
1	16-QAM	MCS4	<b>14.15</b>
1	64-QAM	MCS5	<b>14.13</b>
1	64-QAM	MCS6	<b>14.18</b>
1	64-QAM	MCS7	<b>14.16</b>

Note: This assessment is measured at main Ant.

## 2.5. Test Configuration for Each Test Item

Test Item	802.11b	802.11g	802.11n-HT20	802.11n-HT40
	Data Rate for Test(Mbps)			
6dB Bandwidth	1	6	6.5	13.5
Peak Power Spectral Density	1	6	6.5	13.5
Peak Output Power	1	6	6.5	13.5
Band Edge	1	6	6.5	13.5

## 2.6. Tested Supporting System Details

### 2.6.1. Support Peripheral Unit

No.	Product	Brand	Model No.	Serial No.	FCC ID
1.	LCD Monitor	PHILIPS	273P3L	AU5A1222002498	FCC DoC Approved
2.	USB Keyboard	LENOVO	SK-8825	0056462	FCC DoC Approved
3.	USB Mouse	LENOVO	M-U0025-0	N/A	FCC DoC Approved
4.	USB 3.0 Hard Drive	BUFFALO	HD-HX1.0TU3-AP	15564891205965	FCC DoC Approved
5.	I-POD Earphone	APPLE	N/A	N/A	N/A
6.	Power Socket	AUDIX	N/A	N/A	N/A
7.	Micro SD Card	Kingston	NSDC4/8GB	N/A	N/A

### 2.6.2. Cable Lists

No.	Signal Cable Description Of The Above Support Units
1.	HDMI Cable: Shielded, Detachable, 1.8m
2.	USB Cable: Shielded, Detachable, 1.8m
3.	USB Cable: Shielded, Detachable, 1.8m
4.	USB Cable: Shielded, Detachable, 1.0m
5.	Earphone Cable: Non-Shielded, Detachable, 0.9m
6.	N/A
7.	N/A

Note : 1. Support Unit 1 & 6: Power Cord: Non-Shielded, Detachable, 1.8m

2. Support Unit 4 AC Adapter: BUFFALO, M/N: WA-18H12, S/N: 219019279;  
AC Cord: Non-Shielded, Undetachable, 1.5m

## 2.7. Description of Test Facility

Name of Firm	:	<b>AUDIX Technology Corporation</b> <b>EMC Department</b> No. 53-11, Dingfu, Linkou Dist., New Taipei City 244, Taiwan
Test Location & Facility (C5/AC)	:	<b>No. 5 Shielded Room</b> No. 67-4, Dingfu, Linkou Dist., New Taipei City 244, Taiwan  <b>Semi-Anechoic Chamber</b> No. 53-11, Dingfu, Linkou Dist., New Taipei City 244, Taiwan May 11, 2012 File on Federal Communication Commission Registration Number: 90993
NVLAP Lab. Code	:	200077-0
TAF Accreditation No	:	1724

## 2.8. Measurement Uncertainty

Test Item	Frequency Range	Uncertainty
Conduction Test	150kHz~30MHz	±3.43dB
Radiation Test (Distance: 3m)	30MHz~300MHz	± 2.91dB
	300MHz~1000MHz	± 2.74dB
	Above 1GHz	± 5.02dB

Remark : Uncertainty =  $ku_c(y)$

Test Item	Uncertainty
6dB Bandwidth	± 0.05kHz
Maximum peak output power	± 0.33dBm
Band edges	± 0.13dB
Power spectral density	± 0.13dB
Emission Limitations	± 0.13dB

### 3. CONDUCTED EMISSION MEASUREMENT

#### 3.1. Test Equipment

The following test equipment was used during the conducted emission measurement : (No. 5 Shielded Room)

Item	Type	Manufacturer	Model No.	Serial No.	Cal. Due Date
1.	Test Receiver	R&S	ESCS30	100039	2014. 06. 18
2.	A.M.N.	R&S	ENV4200	100003	2014. 05. 30
3.	L.I.S.N.	Kyoritsu	KNW-407	8-1539-2	2015. 01. 07
4.	Pulse Limiter	R&S	ESH3-Z2	100355	2015. 01. 17

#### 3.2. Block Diagram of Test Setup

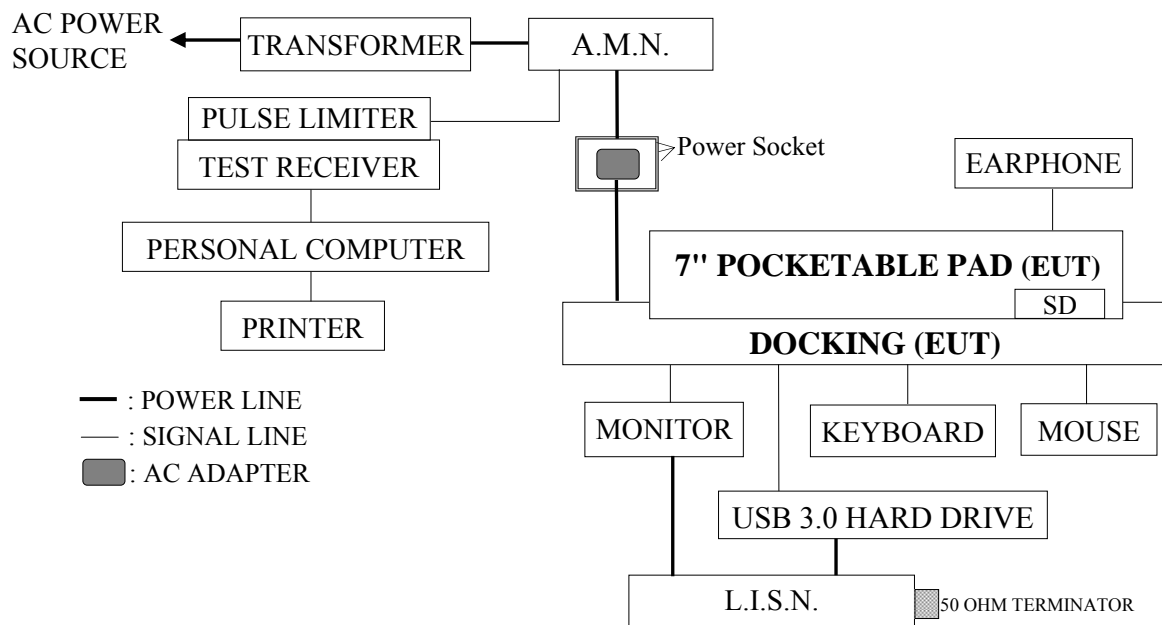

#### 3.3. Powerline Conducted Emission Limit (§15.207)

Frequency	Maximum RF Line Voltage	
	Quasi-Peak Level	Average Level
150kHz ~ 500kHz	66 ~ 56 dB $\mu$ V	56 ~ 46 dB $\mu$ V
500kHz ~ 5MHz	56 dB $\mu$ V	46 dB $\mu$ V
5MHz ~ 30MHz	60 dB $\mu$ V	50 dB $\mu$ V

Remark 1.: If the average limit is met when using a Quasi-Peak detector, the EUT shall be deemed to meet both limits and measurement with the average detector is unnecessary.

2.: The lower limit applies at the band edges.

### 3.4. Operating Condition of EUT

- 3.4.1. Setup the EUT and simulator as shown on 3.2.
- 3.4.2. Turn on the power of all equipment.
- 3.4.3. Set to EUT (7" Pocketable Pad) on transmitting and receiving during all testing.

### 3.5. Test Procedure

The EUT link to docking power adapter through docking was placed on the table which was above the ground by 80cm and adapter's power cord connected to the AC mains through an Artificial Mains Network (A.M.N.). This provided a 50 ohm coupling impedance for the measuring equipment. (Please refer to the block diagram of the test setup and photographs.)

Both sides of A.C. line were checked for maximum conducted interference. In order to find the maximum emission, the relative positions simulators of the interface cables should be manipulated according to ANSI C63.4-2003 regulation during conducted measurement.

The bandwidth of the R&S Test Receiver ESCS30 was set at 9kHz.

The frequency range from 150kHz to 30MHz was checked.

All the final readings from Test Receiver were measured with the Quasi-Peak detector and Average detector. Remark: If the Average limit is met when using a Quasi-Peak detector, the Average detector is unnecessary)

### 3.6. Conducted Emission Measurement Results

#### **PASSED.**

(All the emissions not reported below are too low against the prescribed limits.)

EUT was performed during this section testing and all the test results are attached in next pages.

EUT : 7" Pocketable Pad

M/N : TABLET TB71A-W

Test Date : 2014. 05. 05

Temperature : 22

Humidity : 52%

The details are as follows :

Mode	Reference Test Data	
	Neutral	Line
1.	# 2	# 1



AUDIX Technology Corp. EMC Department  
 No.53-11, Dingfu, Linkou Dist., New Taipei  
 City 244, Taiwan R.O.C.  
 Tel:+886-2-26092133 Fax:+886-2-26099303  
 Email:emc@audixtech.com.tw

Data: 2 File: D:\test-data\Report\EM103\C1S1404XXX\C1S1404136-C-D.EMI (12) Date: 2014-05-05

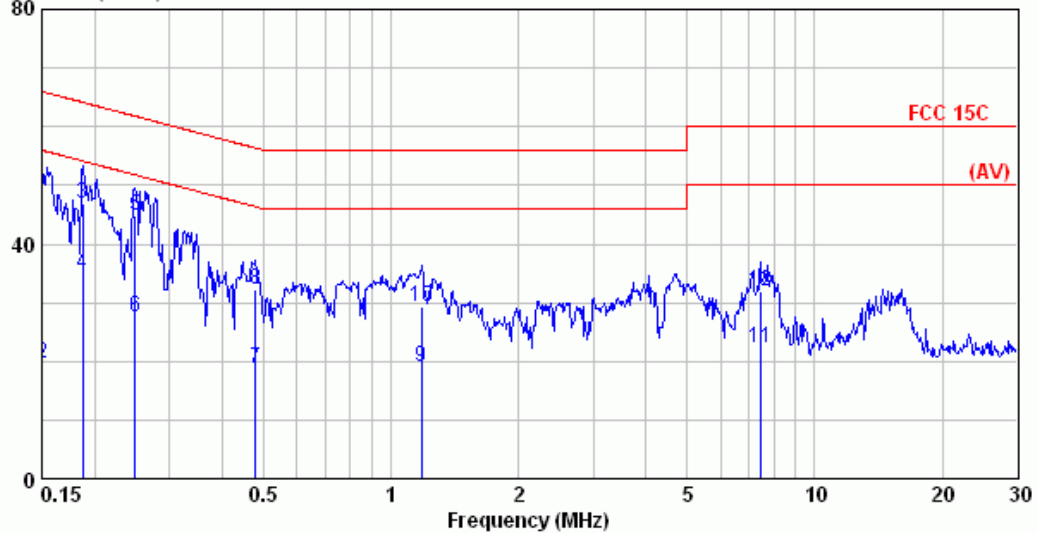

Site : No.5 Shielded Room Data : 2  
 Condition : ENV 4200 Phase : NEUTRAL  
 Limit : FCC 15C  
 Env. / Ins. : 22°C / 52% ESCS 30 (039) Engineer: Gary-Tsai  
 EUT : TB71A-W  
 Power Rating : 120Vac / 60Hz  
 Test Mode : Operating

	Freq. (MHz)	AMN Factor (dB)	Cable Loss (dB)	Reading (dBuV)	Emission Level (dBuV)	Limits (dBuV)	Margin (dB)	Remark
1	0.150	10.10	0.20	33.47	43.77	66.00	22.23	QP
2	0.150	10.10	0.20	9.39	19.69	56.00	36.31	AVERAGE
3	0.187	10.05	0.20	36.61	46.86	64.15	17.29	QP
4	0.187	10.05	0.20	24.76	35.01	54.15	19.14	AVERAGE
5	0.249	9.98	0.20	34.78	44.96	61.78	16.81	QP
6	0.249	9.98	0.20	17.32	27.51	51.78	24.27	AVERAGE
7	0.479	9.88	0.20	8.53	18.62	46.36	27.75	AVERAGE
8	0.479	9.88	0.20	22.28	32.37	56.36	24.00	QP
9	1.178	9.80	0.40	8.76	18.96	46.00	27.04	AVERAGE
10	1.178	9.80	0.40	19.10	29.30	56.00	26.70	QP
11	7.446	9.91	0.60	11.74	22.25	50.00	27.75	AVERAGE
12	7.446	9.91	0.60	21.30	31.81	60.00	28.19	QP

Remarks: 1. Emission Level= AMN Factor + Cable Loss + Reading.  
 2. If the average limit is met when using a quasi-peak detector, the EUT shall be deemed to meet both limits and measurement with average detector is unnecessary.



AUDIX Technology Corp. EMC Department  
 No.53-11, Dingfu, Linkou Dist., New Taipei  
 City 244, Taiwan R.O.C.  
 Tel:+886-2-26092133 Fax:+886-2-26099303  
 Email:emc@audixtech.com.tw

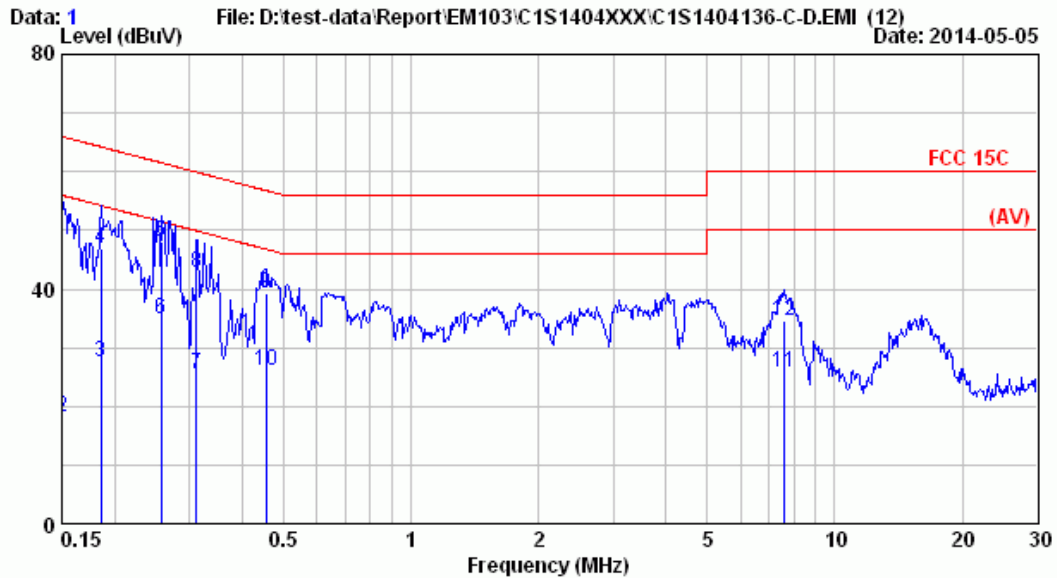

Site : No.5 Shielded Room Data : 1  
 Condition : ENV 4200 Phase : LINE  
 Limit : FCC 15C  
 Env. / Ins. : 22°C / 52% ESCS 30 (039) Engineer: Gary-Tsai  
 EUT : TB71A-W  
 Power Rating : 120Vac / 60Hz  
 Test Mode : Operating

	Freq. (MHz)	AMN Factor (dB)	Cable Loss (dB)	Reading (dBuV)	Emission Level (dBuV)	Limits (dBuV)	Margin (dB)	Remark
1	0.150	10.10	0.20	34.58	44.88	66.00	21.12	QP
2	0.150	10.10	0.20	7.99	18.29	56.00	37.71	AVERAGE
3	0.185	10.05	0.20	17.32	27.57	54.24	26.67	AVERAGE
4	0.185	10.05	0.20	36.49	46.74	64.24	17.50	QP
5	0.258	9.97	0.20	37.84	48.01	61.51	13.50	QP
6	0.258	9.97	0.20	24.68	34.85	51.51	16.66	AVERAGE
7	0.312	9.95	0.20	15.45	25.60	49.93	24.33	AVERAGE
8	0.312	9.95	0.20	32.77	42.92	59.93	17.01	QP
9	0.454	9.89	0.20	29.09	39.18	56.80	17.62	QP
10	0.454	9.89	0.20	16.11	26.20	46.80	20.60	AVERAGE
11	7.566	9.86	0.60	15.26	25.72	50.00	24.28	AVERAGE
12	7.566	9.86	0.60	24.11	34.57	60.00	25.43	QP

Remarks: 1. Emission Level= AMN Factor + Cable Loss + Reading.  
 2. If the average limit is met when using a quasi-peak detector, the EUT shall be deemed to meet both limits and measurement with average detector is unnecessary.



## 4. RADIATED EMISSION MEASUREMENT

### 4.1. Test Equipment

The following test equipment was used during the radiated emission measurement:

#### 4.1.1. For Frequency Range 30MHz~1000MHz (at Semi-Anechoic Chamber)

Item	Type	Manufacturer	Model No.	Serial No.	Cal. Due Date
1.	Spectrum Analyzer	Agilent	N9010A-526	MY53400071	2014. 09. 18
2.	Test Receiver	R & S	ESCS30	100338	2014. 06. 30
3.	Amplifier	HP	8447D	2944A06305	2015. 02. 17
4.	Bilog Antenna	TESEQ	CBL6112D	33821	2014. 08. 07

#### 4.1.2. For Frequency Above 1GHz (at Semi-Anechoic Chamber)

Item	Type	Manufacturer	Model No.	Serial No.	Cal. Due Date
1.	Spectrum Analyzer	Agilent	N9010A-526	MY53400071	2014. 09. 18
2.	Test Receiver	R & S	ESCS30	100338	2014. 06. 30
3.	Pre-Amplifier	HP	8449B	3008A00529	2015. 01. 23
4.	2.4GHz Notch Filter	K&L	7NSL10-2441.5E 130.5-00	1	2014. 06. 12
5.	3G High Pass Filter	Microwave Circuits	H3G018G1	484796	2014. 06. 12
6.	Horn Antenna	EMCO	3115	9609-4927	2014. 06. 16
7.	Horn Antenna	EMCO	3116	2653	2014. 10. 10

### 4.2. Test Setup

#### 4.2.1. Block Diagram of connection between EUT and simulators

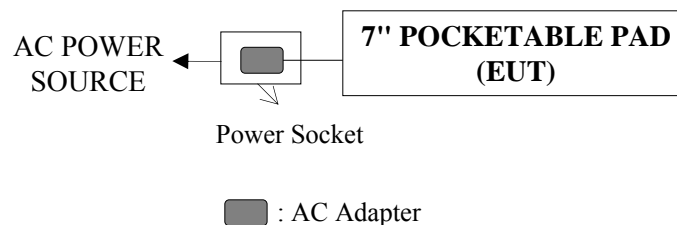

4.2.2. Semi-Anechoic Chamber (3m) Setup Diagram for 30-1000MHz

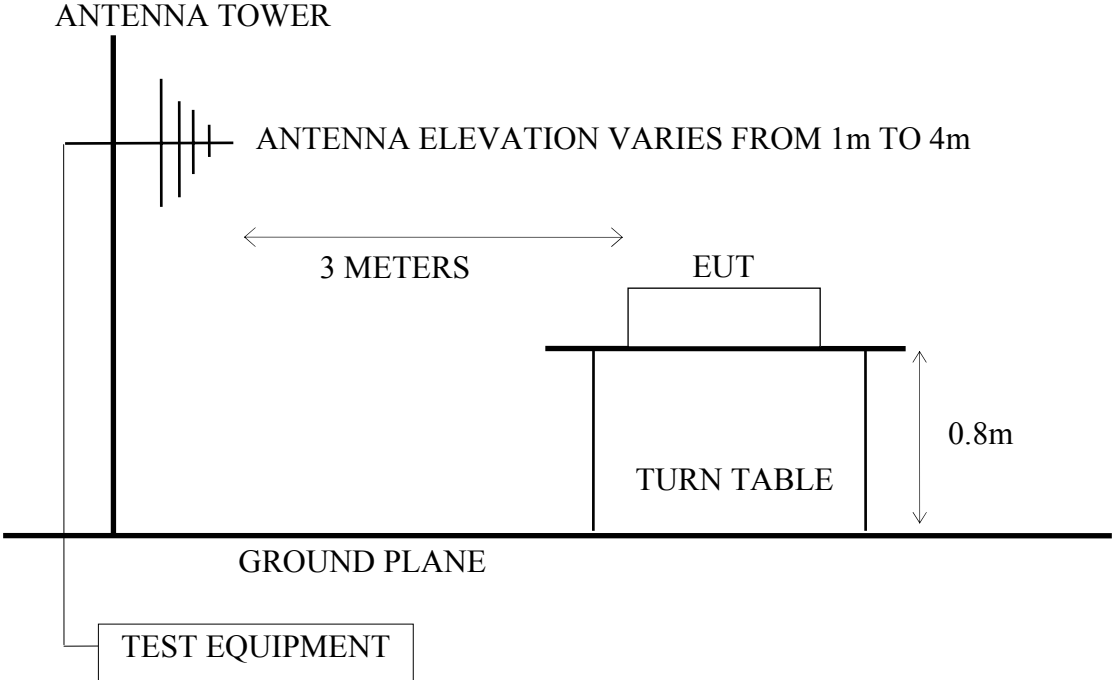

4.2.3. Semi-Anechoic Chamber (3m) Setup Diagram for above 1GHz

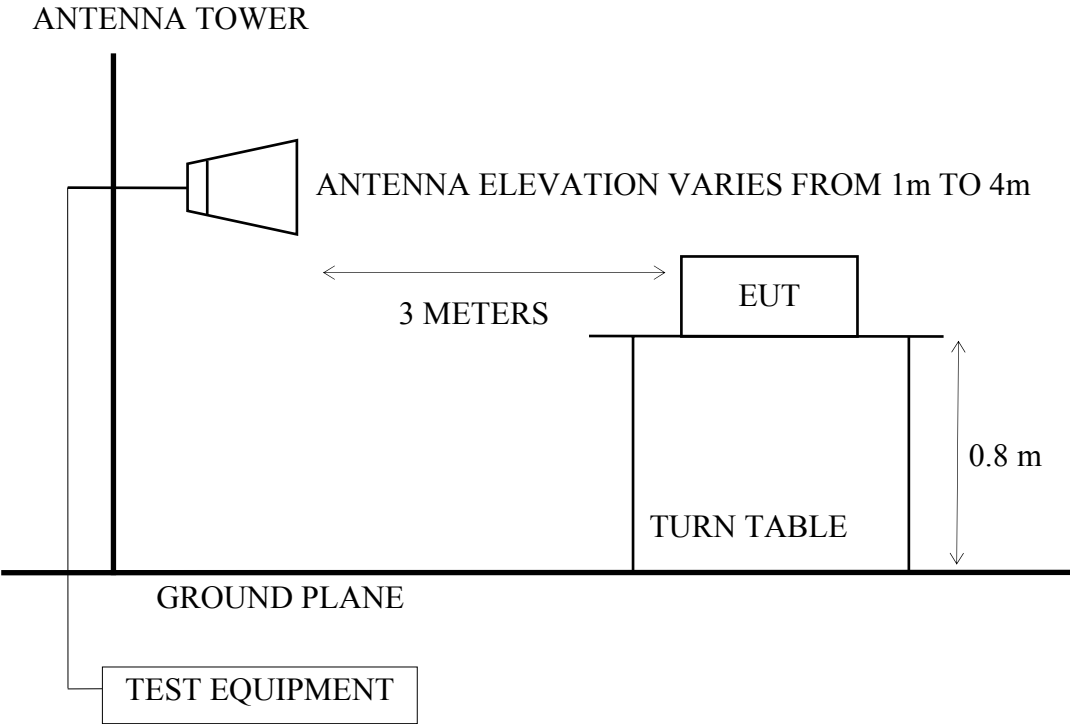

### 4.3. Radiated Emission Limits (§15.209)

FREQUENCY MHz	DISTANCE Meters	FIELD STRENGTHS LIMITS	
		$\mu\text{V/m}$	$\text{dB}\mu\text{V/m}$
30 ~ 88	3	100	40.0
88 ~ 216	3	150	43.5
216 ~ 960	3	200	46.0
Above 960	3	500	54.0
Above 1000	3	74.0 $\text{dB}\mu\text{V/m}$ (Peak) 54.0 $\text{dB}\mu\text{V/m}$ (Average)	

- Remark :
- (1) Emission level ( $\text{dB}\mu\text{V/m}$ ) = 20 log Emission level ( $\mu\text{V/m}$ )
  - (2) The tighter limit applies at the edge between two frequency bands.
  - (3) Distance refers to the distance in meters between the measuring instrument antenna and the closed point of any part of the device or system.
  - (4) The limits in this table are based on CFR 47 Part 15.205(a)(b) and Part 15.209 (a).
  - (5) The over 1GHz limit, FCC limit is used based on CFR 47 Part 15.35(b) and Part 15.205(b) & Part 15.209(e) and Part 15.207(c).

### 4.4. Operating Condition of EUT

- 4.4.1. Set up the EUT (7" Pocketable Pad) and simulator as shown on 4.2.
- 4.4.2. To turn on the power of all equipments.
- 4.4.3. The EUT was set the Notebook PC using test program "WL Command" for WLAN test and test program "Blue Tool" for BLE test.
- 4.4.4. The EUT supports 802.11a/b/g/n-HT20/n-HT40 and BLE modes, we performed pre-scan high, middle, low channels for each mode for spurious emission and listed the worst channel of each mode in test report.

The worst channel of each mode as following:

Mode	Type of Network	Channel
1.	802.11b	CH 11
2.	802.11g	CH 11
4.	802.11n-HT20	CH 11
3.	BLE	CH 0
4.	BLE	CH 19
5.	BLE	CH 39

#### 4.5. Test Procedure

The EUT and its simulators were placed on a turn table which was 0.8 meter above the ground. The turn table rotated 360 degrees to determine the position of the maximum emission level. EUT was set 3 meters away from the receiving antenna which was mounted on an antenna tower. The antenna moved up and down between 1 to 4 meters to find out the maximum emission level. Broadband antenna such as calibrated biconical and log-periodical antenna or horn antenna were used as a receiving antenna. Both horizontal and vertical polarization of the antenna were set on measurement. In order to find the maximum emission, all of the interface cables were manipulated according to ANSI C63.4-2003 regulation.

The bandwidth of the R&S Test Receiver was set at 120kHz. (For 30MHz to 1000MHz)

The resolution bandwidth and video bandwidth of test spectrum analyzer is 1MHz for peak detection (PK) at frequency above 1GHz.

The resolution bandwidth of test spectrum analyzer is 1MHz and the video bandwidth is 10Hz for average detection (AV) at frequency above 1GHz.

The frequency range from 30MHz to 25GHz (Up to 10<sup>th</sup> harmonics from fundamental frequency) was checked. 30MHz to 1000MHz was measured with Quasi-Peak detector.

Above 1GHz was measured with peak and average detector. For frequency from 1GHz to 25GHz, we checked it in 1 meter distance and with a shorter cable 2 meter instead of original's. There is no signal exist.

Pursuant to ANSI C63.4 8.3.1.2, when peak value complies with the average limit, we didn't perform measurement in average detector.

#### 4.6. Test Results

##### **PASSED.**

(All emissions not reported below are too low against the prescribed limits.)

EUT : 7" Pocketable Pad                      M/N : TABLET TB71A-W

Test Date : 2014. 05. 13    Temperature : 26            Humidity : 43%

##### 4.6.1. For WLAN Function

##### **For Frequency Range 30MHz~1000MHz:**

The EUT emitted the fundamental frequency with data code at the stand, side and lying conditions.

The EUT select **worst position "lying"** and link AC adapter and with following test modes was performed during this section testing and all the test results are listed in section 4.6.1.1.

Mode	Type of Network	Channel	Frequency	Test Mode	Reference Test Data	
					Horizontal	Vertical
1.	802.11b	CH 11	2462MHz	Transmit	# 1	# 2
2.	802.11g	CH 11	2462MHz		# 1	# 2
3.	802.11n-HT20	CH 11	2462MHz		# 1	# 2

\* Above all final readings were measured with Quasi-Peak detector.

##### **Frequency above 1GHz:**

The emissions (up to 25GHz) not reported are too low to be measured.

##### **For Restricted Bands:**

The EUT select **worst position "lying"** and link AC adapter and with following test modes was performed during this section testing and all the test results are listed in section 4.6.1.2. (The restricted bands defined in part 15.205(a))

Mode	Type of Network	Channel	Frequency	Test Mode	Reference Test Data	
					Horizontal	Vertical
1.	802.11b	CH 6	2412MHz	Transmit	# 11, # 12	# 9, # 10
2.		CH 11	2462MHz		# 15, # 16	# 13, # 14
3.	802.11g	CH 6	2412MHz	Transmit	# 3, # 4	# 1, # 2
4.		CH 11	2462MHz		# 7, # 8	# 5, # 6
5.	802.11n-HT20	CH 6	2412MHz	Transmit	# 9, # 10	# 11, # 12
6.		CH 11	2462MHz		# 15, # 16	# 13, # 14



**802.11g, Transmit, Frequency: 2462MHz**

Site no. : Audix NO.1 Chamber                      Data no. : 1  
 Dis. / Ant. : 3m CBL6112D 33821                      Ant. pol. : HORIZONTAL  
 Limit : 30M-1G  
 Env. / Ins. : 26\*C / 43% N9010A                      Engineer : Wenbin\_Yang  
 EUT : TB71A-W  
 Power Rating : DC5V  
 Test Mode : TX2462

	Freq. (MHz)	Ant. Factor (dB/m)	Cable Loss (dB)	Reading (dB $\mu$ V)	Emission Level (dB $\mu$ V/m)	Limits (dB $\mu$ V/m)	Margin (dB)	Remark
1	236.61	11.83	3.40	24.78	40.01	46.00	5.99	QP
2	354.95	15.42	4.37	15.80	35.59	46.00	10.41	QP
3	831.22	20.98	7.10	7.88	35.96	46.00	10.04	QP

Remarks: 1. Emission Level= Antenna Factor + Cable Loss + Reading  
 2. The emission levels that are 20dB below the official limit are not reported.

Site no. : Audix NO.1 Chamber                      Data no. : 2  
 Dis. / Ant. : 3m CBL6112D 33821                      Ant. pol. : VERTICAL  
 Limit : 30M-1G  
 Env. / Ins. : 26\*C / 43% N9010A                      Engineer : Wenbin\_Yang  
 EUT : TB71A-W  
 Power Rating : DC5V  
 Test Mode : TX2462

	Freq. (MHz)	Ant. Factor (dB/m)	Cable Loss (dB)	Reading (dB $\mu$ V)	Emission Level (dB $\mu$ V/m)	Limits (dB $\mu$ V/m)	Margin (dB)	Remark
1	252.13	13.22	3.59	14.06	30.87	46.00	15.13	QP
2	512.09	17.96	6.80	12.39	37.15	46.00	8.85	QP
3	830.25	20.96	7.10	2.01	30.07	46.00	15.93	QP

Remarks: 1. Emission Level= Antenna Factor + Cable Loss + Reading  
 2. The emission levels that are 20dB below the official limit are not reported.





4.6.1.2. Restricted Bands Measurement Results

Date of Test : 2014. 05. 13 Temperature : 26

EUT : 7" Pocketable Pad Humidity : 43%

Test Mode : 802.11b, Transmit, Channel: 01, Frequency: 2412MHz

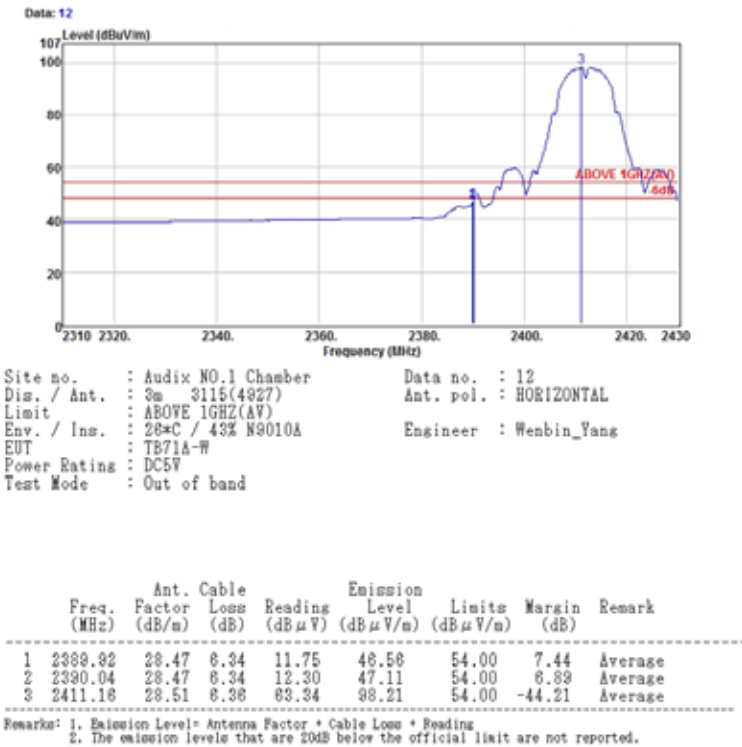
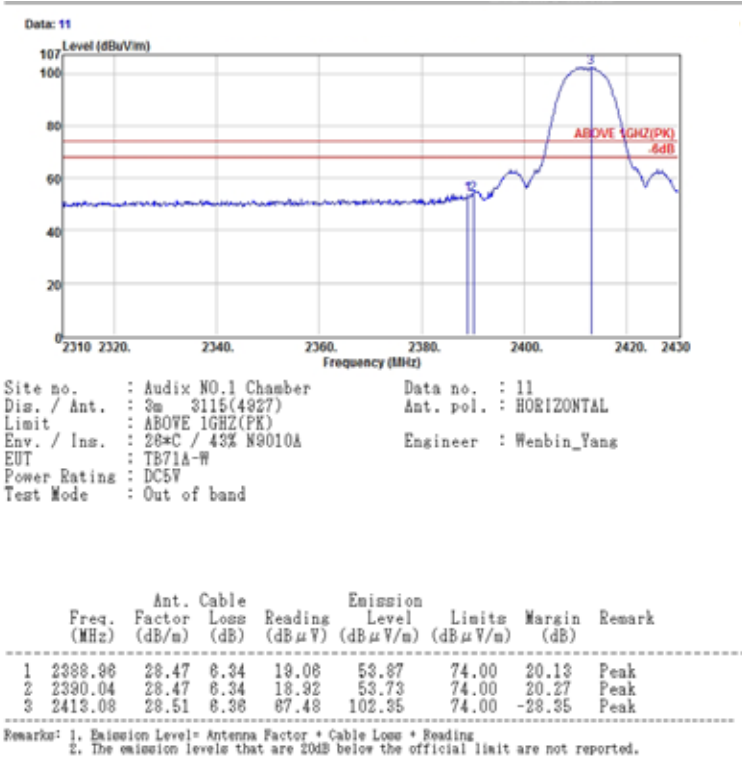

Date of Test : 2014. 05. 13 Temperature : 26

EUT : 7" Pocketable Pad Humidity : 43%

Test Mode : 802.11b, Transmit, Channel: 01, Frequency: 2412MHz

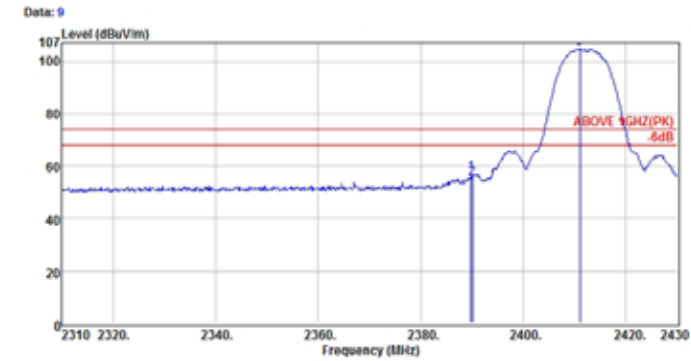

Site no. : Audix NO.1 Chamber Data no. : 9  
 Dis. / Ant. : 3m 3115(4927) Ant. pol. : VERTICAL  
 Limit : ABOVE 1GHZ(PK)  
 Env. / Ins. : 28°C / 43% N9010A Engineer : Wenbin\_Yang  
 EUT : TB71A-W  
 Power Ratings : DC5V  
 Test Mode : Out of band

	Freq. (MHz)	Ant. Factor (dB/m)	Cable Loss (dB)	Reading (dBμV)	Emission Level (dBμV/m)	Limit (dBμV/m)	Margin (dB)	Remark
1	2389.90	28.47	6.34	22.43	57.24	74.00	16.76	Peak
2	2390.04	28.47	6.34	20.67	55.48	74.00	18.52	Peak
3	2411.04	28.51	6.36	69.99	104.86	74.00	-30.86	Peak

Remarks: 1. Emission Level= Antenna Factor + Cable Loss + Reading  
 2. The emission levels that are 20dB below the official limit are not reported.

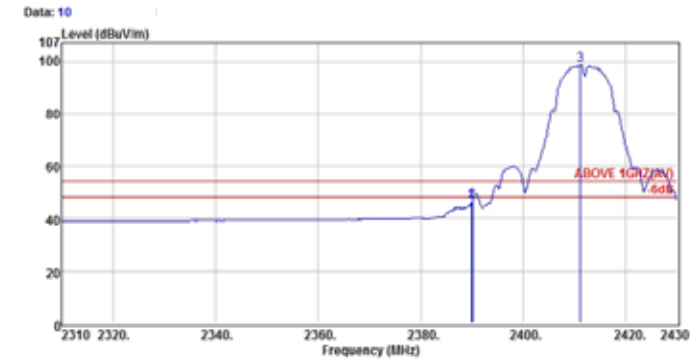

Site no. : Audix NO.1 Chamber Data no. : 10  
 Dis. / Ant. : 3m 3115(4927) Ant. pol. : VERTICAL  
 Limit : ABOVE 1GHZ(AV)  
 Env. / Ins. : 28°C / 43% N9010A Engineer : Wenbin\_Yang  
 EUT : TB71A-W  
 Power Ratings : DC5V  
 Test Mode : Out of band

	Freq. (MHz)	Ant. Factor (dB/m)	Cable Loss (dB)	Reading (dBμV)	Emission Level (dBμV/m)	Limit (dBμV/m)	Margin (dB)	Remark
1	2389.92	28.47	6.34	11.28	46.09	54.00	7.91	Average
2	2390.04	28.47	6.34	11.85	46.66	54.00	7.34	Average
3	2411.18	28.51	6.36	63.79	98.66	54.00	-44.66	Average

Remarks: 1. Emission Level= Antenna Factor + Cable Loss + Reading  
 2. The emission levels that are 20dB below the official limit are not reported.

Date of Test : 2014. 05. 13 Temperature : 26  
 EUT : 7" Pocketable Pad Humidity : 43%  
 Test Mode : 802.11b, Transmit, Channel: 11, Frequency: 2462MHz

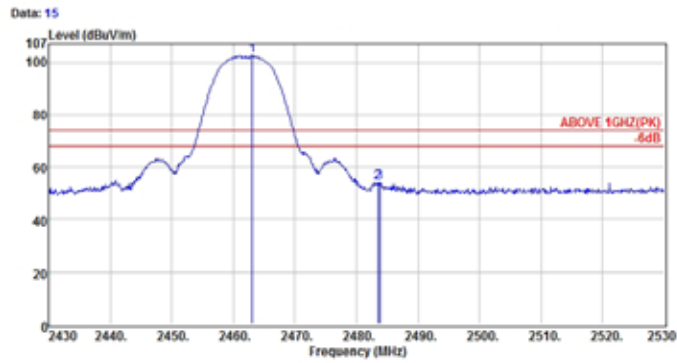

Site no. : Audix NO.1 Chamber Data no. : 15  
 Dis. / Ant. : 3m 3115(4927) Ant. pol. : HORIZONTAL  
 Limit : ABOVE 1GHZ(PK)  
 Env. / Ins. : 28°C / 43% N9010A Engineer : Wenbin\_Yang  
 EUT : TB71A-W  
 Power Rating : DC5V  
 Test Mode : Out of band

	Freq. (MHz)	Ant. Factor (dB/m)	Cable Loss (dB)	Reading (dBμV)	Emission Level (dBμV/m)	Limit (dBμV/m)	Margin (dB)	Remark
1	2462.10	28.82	6.42	67.54	102.58	74.00	-28.58	Peak
2	2483.50	28.88	6.45	18.81	53.92	74.00	20.08	Peak
3	2483.80	28.88	6.45	18.98	54.09	74.00	19.91	Peak

Remarks: 1. Emission Level= Antenna Factor + Cable Loss + Reading  
 2. The emission levels that are 20dB below the official limit are not reported.

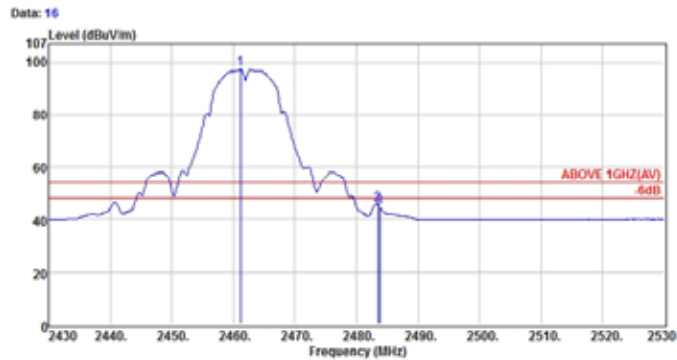

Site no. : Audix NO.1 Chamber Data no. : 16  
 Dis. / Ant. : 3m 3115(4927) Ant. pol. : HORIZONTAL  
 Limit : ABOVE 1GHZ(AV)  
 Env. / Ins. : 28°C / 43% N9010A Engineer : Wenbin\_Yang  
 EUT : TB71A-W  
 Power Rating : DC5V  
 Test Mode : Out of band

	Freq. (MHz)	Ant. Factor (dB/m)	Cable Loss (dB)	Reading (dBμV)	Emission Level (dBμV/m)	Limit (dBμV/m)	Margin (dB)	Remark
1	2461.20	28.82	6.42	62.39	97.43	54.00	-43.43	Average
2	2483.50	28.88	6.45	10.82	45.73	54.00	8.27	Average
3	2483.80	28.88	6.45	9.82	44.73	54.00	9.27	Average

Remarks: 1. Emission Level= Antenna Factor + Cable Loss + Reading  
 2. The emission levels that are 20dB below the official limit are not reported.

Date of Test : 2014. 05. 13 Temperature : 26

EUT : 7" Pocketable Pad Humidity : 43%

Test Mode : 802.11b, Transmit, Channel: 11, Frequency: 2462MHz

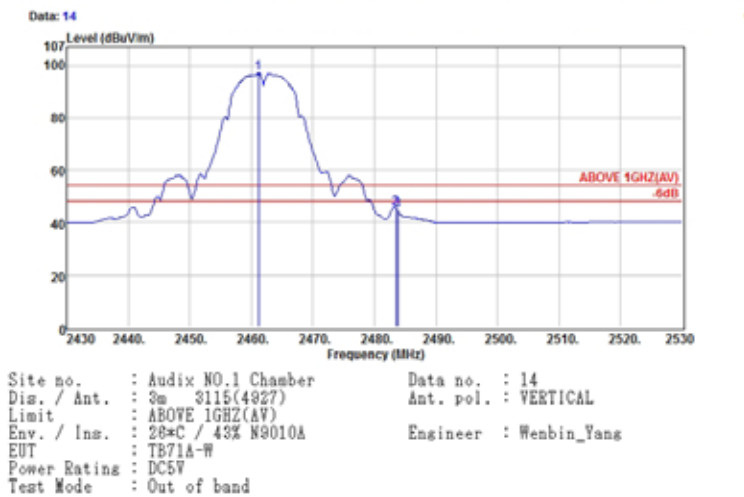
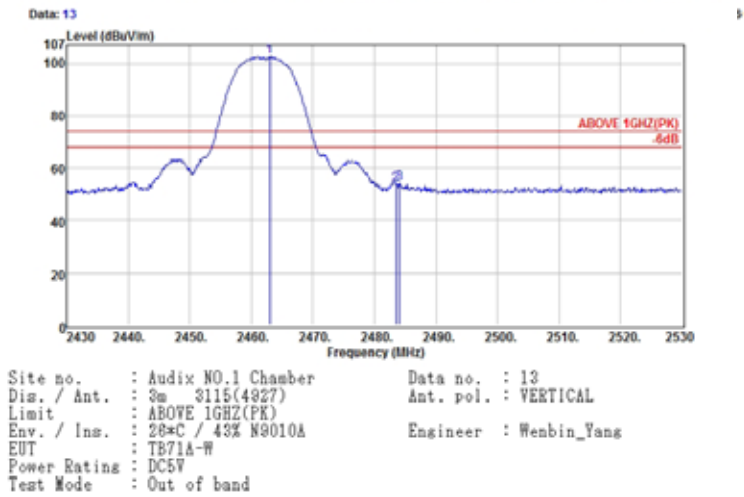

Date of Test : 2014. 05. 13 Temperature : 26

EUT : 7" Pocketable Pad Humidity : 43%

Test Mode : 802.11g, Transmit, Channel: 01, Frequency: 2412MHz

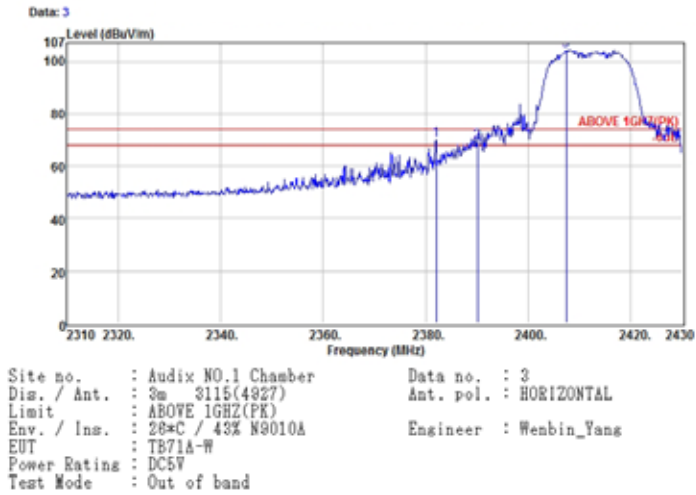

	Freq. (MHz)	Ant. Factor (dB/m)	Cable Loss (dB)	Reading (dBμV)	Emission Level (dBμV/m)	Limit (dBμV/m)	Margin (dB)	Remark
1	2392.00	28.43	6.33	35.18	69.84	74.00	4.06	Peak
2	2390.04	28.47	6.34	34.26	69.07	74.00	4.93	Peak
3	2407.44	28.51	6.36	69.31	104.18	74.00	-30.18	Peak

Remarks: 1. Emission Level= Antenna Factor + Cable Loss + Reading  
 2. The emission levels that are 20dB below the official limit are not reported.

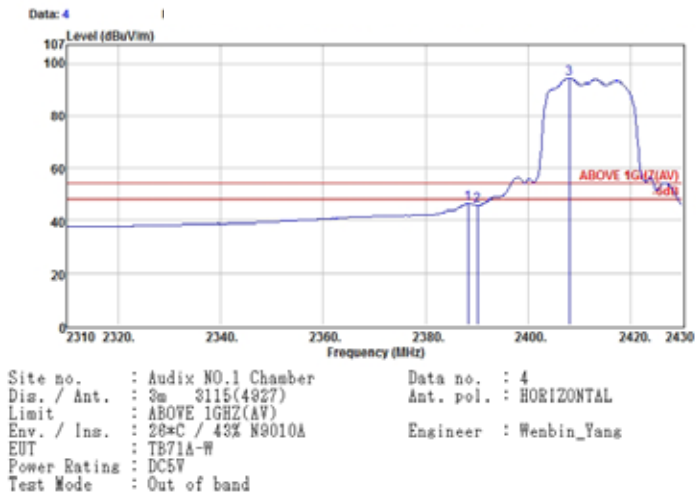

	Freq. (MHz)	Ant. Factor (dB/m)	Cable Loss (dB)	Reading (dBμV)	Emission Level (dBμV/m)	Limit (dBμV/m)	Margin (dB)	Remark
1	2398.24	28.47	6.34	11.82	46.43	54.00	7.57	Average
2	2390.04	28.47	6.34	11.00	45.81	54.00	8.19	Average
3	2408.04	28.51	6.36	59.42	94.29	54.00	-40.29	Average

Remarks: 1. Emission Level= Antenna Factor + Cable Loss + Reading  
 2. The emission levels that are 20dB below the official limit are not reported.

Date of Test : 2014. 05. 13 Temperature : 26

EUT : 7" Pocketable Pad Humidity : 43%

Test Mode : 802.11g, Transmit, Channel: 01, Frequency: 2412MHz

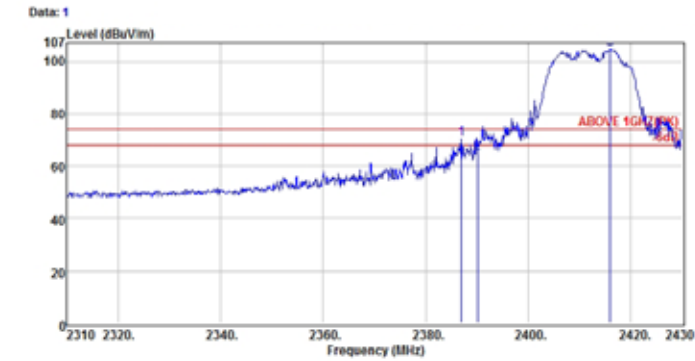

Site no. : Audix NO.1 Chamber Data no. : 1  
 Dis. / Ant. : 3m 3115(4927) Ant. pol. : VERTICAL  
 Limit : ABOVE 1GHZ(PK)  
 Env. / Ins. : 28°C / 43% N9010A Engineer : Wenbin\_Yang  
 EUT : TB71A-W  
 Power Ratings : DC5V  
 Test Mode : Out of band

	Freq. (MHz)	Ant. Factor (dB/m)	Cable Loss (dB)	Reading (dBμV)	Emission Level (dBμV/m)	Limit (dBμV/m)	Margin (dB)	Remark
1	2386.92	28.47	6.33	35.89	70.49	74.00	3.51	Peak
2	2390.04	28.47	6.34	29.86	64.67	74.00	9.33	Peak
3	2415.96	28.51	6.36	69.56	104.43	74.00	-30.43	Peak

Remarks: 1. Emission Level= Antenna Factor + Cable Loss + Reading  
 2. The emission levels that are 20dB below the official limit are not reported.

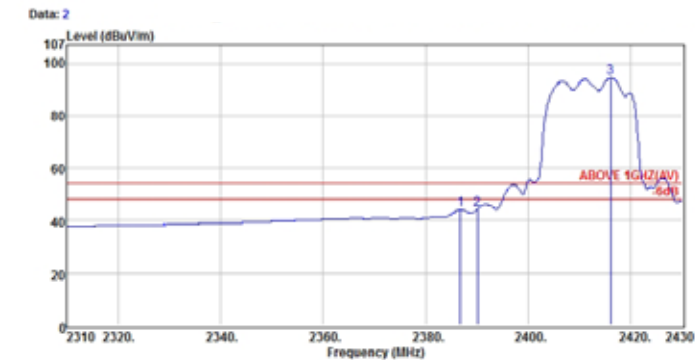

Site no. : Audix NO.1 Chamber Data no. : 2  
 Dis. / Ant. : 3m 3115(4927) Ant. pol. : VERTICAL  
 Limit : ABOVE 1GHZ(AV)  
 Env. / Ins. : 28°C / 43% N9010A Engineer : Wenbin\_Yang  
 EUT : TB71A-W  
 Power Ratings : DC5V  
 Test Mode : Out of band

	Freq. (MHz)	Ant. Factor (dB/m)	Cable Loss (dB)	Reading (dBμV)	Emission Level (dBμV/m)	Limit (dBμV/m)	Margin (dB)	Remark
1	2386.80	28.47	6.33	9.34	44.14	54.00	9.86	Average
2	2390.04	28.47	6.34	9.48	44.29	54.00	9.71	Average
3	2415.08	28.51	6.36	59.72	94.59	54.00	-40.59	Average

Remarks: 1. Emission Level= Antenna Factor + Cable Loss + Reading  
 2. The emission levels that are 20dB below the official limit are not reported.

Date of Test : 2014. 05. 13 Temperature : 26

EUT : 7" Pocketable Pad Humidity : 43%

Test Mode : 802.11g, Transmit, Channel: 11, Frequency: 2462MHz

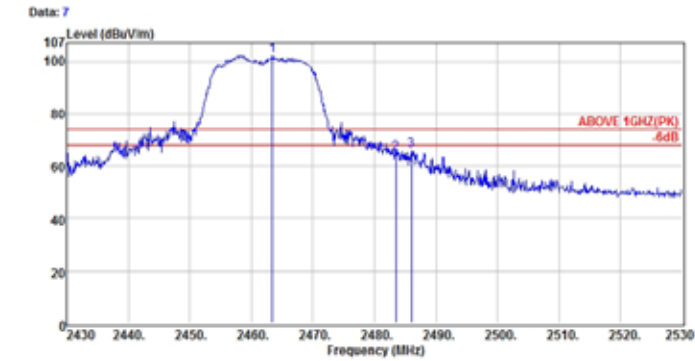

Site no. : Audix NO.1 Chamber Data no. : 7  
 Dis. / Ant. : 3m 3115(4927) Ant. pol. : HORIZONTAL  
 Limit : ABOVE 1GHZ(PK)  
 Env. / Ins. : 28°C / 43% N9010A Engineer : Wenbin\_Yang  
 EUT : TB71A-W  
 Power Rating : DC5V  
 Test Mode : Out of band

	Freq. (MHz)	Ant. Factor (dB/m)	Cable Loss (dB)	Reading (dBμV)	Emission Level (dBμV/m)	Limit (dBμV/m)	Margin (dB)	Remark
1	2463.40	28.82	6.42	67.23	102.27	74.00	-28.27	Peak
2	2483.50	28.88	6.45	29.71	64.82	74.00	3.18	Peak
3	2488.00	28.88	6.45	30.92	68.03	74.00	7.97	Peak

Remarks: 1. Emission Level= Antenna Factor + Cable Loss + Reading  
 2. The emission levels that are 20dB below the official limit are not reported.

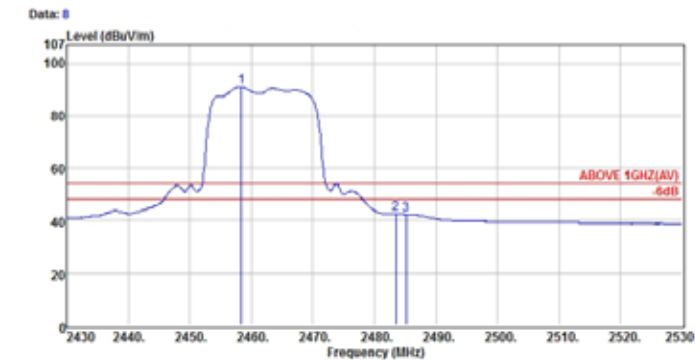

Site no. : Audix NO.1 Chamber Data no. : 8  
 Dis. / Ant. : 3m 3115(4927) Ant. pol. : HORIZONTAL  
 Limit : ABOVE 1GHZ(AV)  
 Env. / Ins. : 28°C / 43% N9010A Engineer : Wenbin\_Yang  
 EUT : TB71A-W  
 Power Rating : DC5V  
 Test Mode : Out of band

	Freq. (MHz)	Ant. Factor (dB/m)	Cable Loss (dB)	Reading (dBμV)	Emission Level (dBμV/m)	Limit (dBμV/m)	Margin (dB)	Remark
1	2458.40	28.82	6.42	58.12	91.18	54.00	-37.18	Average
2	2483.50	28.88	6.45	7.37	42.48	54.00	11.52	Average
3	2488.20	28.88	6.45	7.22	42.33	54.00	11.87	Average

Remarks: 1. Emission Level= Antenna Factor + Cable Loss + Reading  
 2. The emission levels that are 20dB below the official limit are not reported.

Date of Test : 2014. 05. 13 Temperature : 26

EUT : 7" Pocketable Pad Humidity : 43%

Test Mode : 802.11g, Transmit, Channel: 11, Frequency: 2462MHz

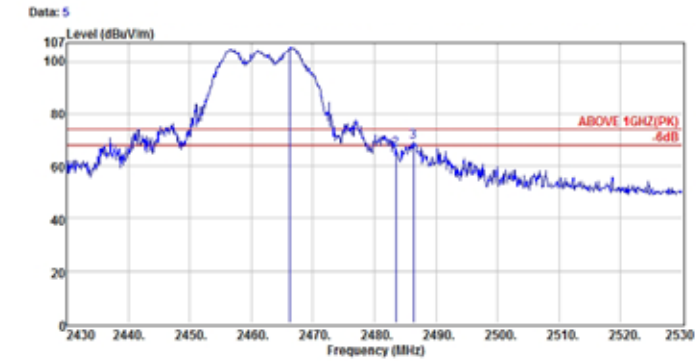

Site no. : Audix NO.1 Chamber Data no. : 5  
 Dis. / Ant. : 3m 3115(4927) Ant. pol. : VERTICAL  
 Limit : ABOVE 1GHZ(PK)  
 Env. / Ins. : 28°C / 43% N9010A Engineer : Wenbin\_Yang  
 EUT : TB71A-W  
 Power Ratings : DC5V  
 Test Mode : Out of band

	Freq. (MHz)	Ant. Factor (dB/m)	Cable Loss (dB)	Reading (dBμV)	Emission Level (dBμV/m)	Limit (dBμV/m)	Margin (dB)	Remark
1	2488.30	28.82	8.42	70.38	105.40	74.00	-31.40	Peak
2	2483.50	28.88	8.45	31.48	88.57	74.00	7.43	Peak
3	2488.30	28.88	8.45	34.24	89.35	74.00	4.85	Peak

Remarks: 1. Emission Level= Antenna Factor + Cable Loss + Reading  
 2. The emission levels that are 20dB below the official limit are not reported.

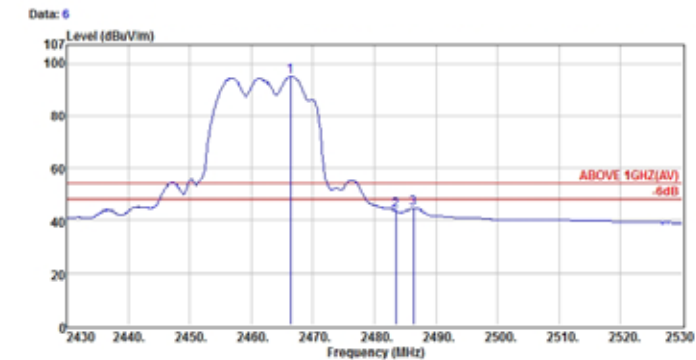

Site no. : Audix NO.1 Chamber Data no. : 6  
 Dis. / Ant. : 3m 3115(4927) Ant. pol. : VERTICAL  
 Limit : ABOVE 1GHZ(AV)  
 Env. / Ins. : 28°C / 43% N9010A Engineer : Wenbin\_Yang  
 EUT : TB71A-W  
 Power Ratings : DC5V  
 Test Mode : Out of band

	Freq. (MHz)	Ant. Factor (dB/m)	Cable Loss (dB)	Reading (dBμV)	Emission Level (dBμV/m)	Limit (dBμV/m)	Margin (dB)	Remark
1	2488.40	28.82	8.42	80.01	95.05	54.00	-41.05	Average
2	2483.50	28.88	8.45	8.80	43.71	54.00	10.29	Average
3	2488.30	28.88	8.45	9.58	44.89	54.00	9.31	Average

Remarks: 1. Emission Level= Antenna Factor + Cable Loss + Reading  
 2. The emission levels that are 20dB below the official limit are not reported.



Date of Test : 2014. 05. 13 Temperature : 26

EUT : 7" Pocketable Pad Humidity : 43%

Test Mode : 802.11n-HT20, Transmit, Channel: 01, Frequency: 2412MHz

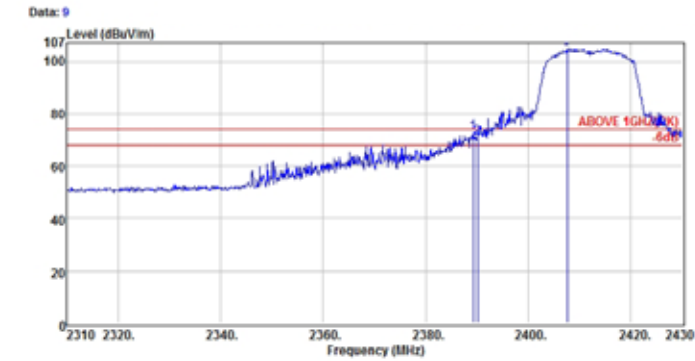

Site no. : Audix NO.1 Chamber Data no. : 9  
 Dis. / Ant. : 3m 3115(4927) Ant. pol. : HORIZONTAL  
 Limit : ABOVE 1GHZ(PK)  
 Env. / Ins. : 28°C / 43% N9010A Engineer : Wenbin\_Yang  
 EUT : TB71A-W  
 Power Ratings : DC5V  
 Test Mode : Out of band

	Freq. (MHz)	Ant. Factor (dB/m)	Cable Loss (dB)	Reading (dBμV)	Emission Level (dBμV/m)	Limit (dBμV/m)	Margin (dB)	Remark
1	2389.32	28.47	6.34	38.00	72.81	74.00	1.19	Peak
2	2390.04	28.47	6.34	36.17	70.98	74.00	3.02	Peak
3	2407.56	28.51	6.36	70.11	104.98	74.00	-30.98	Peak

Remarks: 1. Emission Level= Antenna Factor + Cable Loss + Reading  
 2. The emission levels that are 20dB below the official limit are not reported.

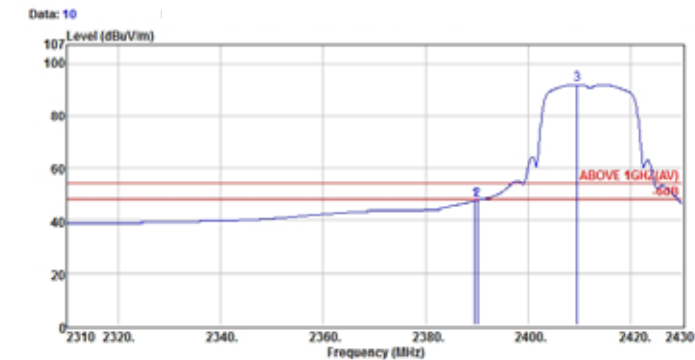

Site no. : Audix NO.1 Chamber Data no. : 10  
 Dis. / Ant. : 3m 3115(4927) Ant. pol. : HORIZONTAL  
 Limit : ABOVE 1GHZ(AV)  
 Env. / Ins. : 28°C / 43% N9010A Engineer : Wenbin\_Yang  
 EUT : TB71A-W  
 Power Ratings : DC5V  
 Test Mode : Out of band

	Freq. (MHz)	Ant. Factor (dB/m)	Cable Loss (dB)	Reading (dBμV)	Emission Level (dBμV/m)	Limit (dBμV/m)	Margin (dB)	Remark
1	2389.56	28.47	6.34	12.77	47.58	54.00	6.42	Average
2	2390.04	28.47	6.34	12.34	47.75	54.00	6.25	Average
3	2409.48	28.51	6.36	57.21	92.08	54.00	-38.08	Average

Remarks: 1. Emission Level= Antenna Factor + Cable Loss + Reading  
 2. The emission levels that are 20dB below the official limit are not reported.

Date of Test : 2014. 05. 13 Temperature : 26

EUT : 7" Pocketable Pad Humidity : 43%

Test Mode : 802.11n-HT20, Transmit, Channel: 01, Frequency: 2412MHz

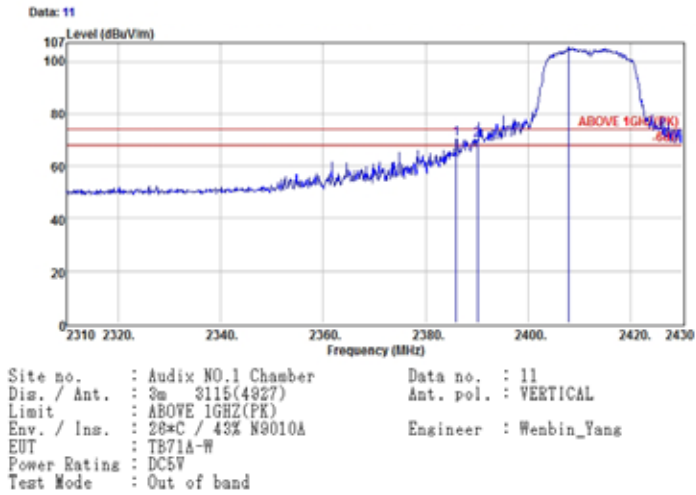

	Freq. (MHz)	Ant. Factor (dB/m)	Cable Loss (dB)	Reading (dBμV)	Emission Level (dBμV/m)	Limit (dBμV/m)	Margin (dB)	Remark
1	2385.96	28.47	6.33	35.71	70.51	74.00	3.49	Peak
2	2390.04	28.47	6.34	35.29	70.10	74.00	3.90	Peak
3	2407.80	28.51	6.36	70.94	105.81	74.00	-31.81	Peak

Remarks: 1. Emission Level= Antenna Factor + Cable Loss + Reading  
 2. The emission levels that are 20dB below the official limit are not reported.

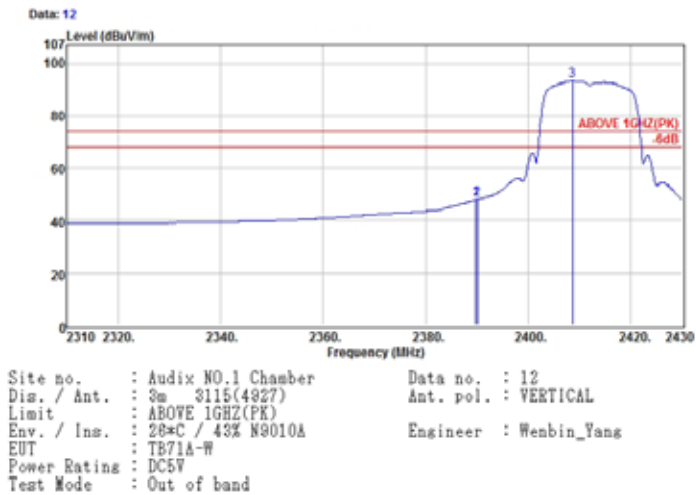

	Freq. (MHz)	Ant. Factor (dB/m)	Cable Loss (dB)	Reading (dBμV)	Emission Level (dBμV/m)	Limit (dBμV/m)	Margin (dB)	Remark
1	2389.80	28.47	6.34	13.13	47.94	74.00	26.06	Average
2	2390.04	28.47	6.34	13.24	48.05	74.00	25.95	Average
3	2408.84	28.51	6.36	58.44	93.31	74.00	-19.31	Average

Remarks: 1. Emission Level= Antenna Factor + Cable Loss + Reading  
 2. The emission levels that are 20dB below the official limit are not reported.

Date of Test : 2014. 05. 13 Temperature : 26

EUT : 7" Pocketable Pad Humidity : 43%

Test Mode : 802.11n-HT20, Transmit, Channel: 11, Frequency: 2462MHz

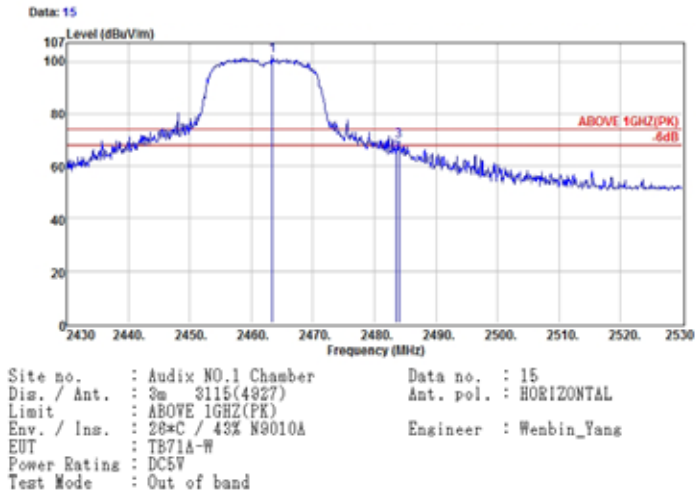

	Freq. (MHz)	Ant. Factor (dB/m)	Cable Loss (dB)	Reading (dBμV)	Emission Level (dBμV/m)	Limit (dBμV/m)	Margin (dB)	Remark
1	2462.40	28.82	6.42	67.17	102.21	74.00	-28.21	QP Peak
2	2483.50	28.86	6.45	29.77	64.88	74.00	9.12	QP Peak
3	2484.00	28.88	6.45	34.54	69.65	74.00	4.35	QP Peak

Remarks: 1. Emission Level= Antenna Factor + Cable Loss + Reading  
 2. The emission levels that are 20dB below the official limit are not reported.

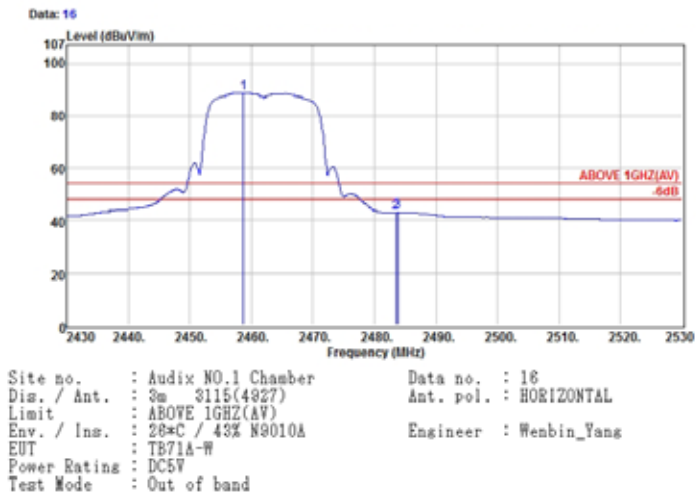

	Freq. (MHz)	Ant. Factor (dB/m)	Cable Loss (dB)	Reading (dBμV)	Emission Level (dBμV/m)	Limit (dBμV/m)	Margin (dB)	Remark
1	2462.70	28.82	6.42	53.84	68.88	54.00	-34.88	Average
2	2483.50	28.86	6.45	8.02	43.13	54.00	10.87	Average
3	2483.80	28.88	6.45	8.05	43.16	54.00	10.84	Average

Remarks: 1. Emission Level= Antenna Factor + Cable Loss + Reading  
 2. The emission levels that are 20dB below the official limit are not reported.

Date of Test : 2014. 05. 13 Temperature : 26

EUT : 7" Pocketable Pad Humidity : 43%

Test Mode : 802.11n-HT20, Transmit, Channel: 11, Frequency: 2462MHz

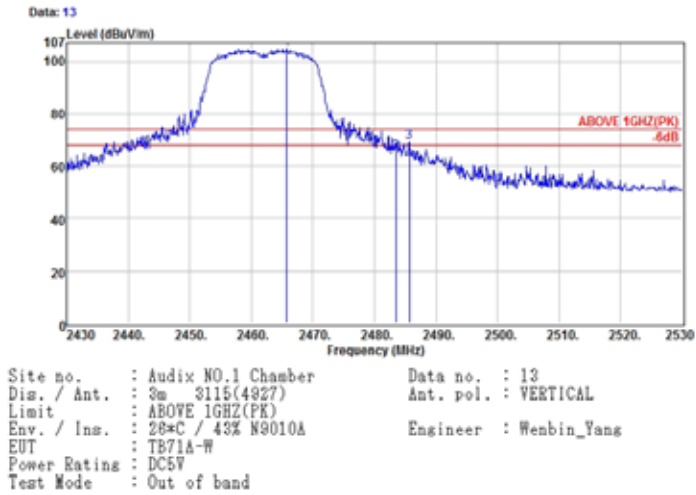

	Freq. (MHz)	Ant. Factor (dB/m)	Cable Loss (dB)	Reading (dBμV)	Emission Level (dBμV/m)	Limit (dBμV/m)	Margin (dB)	Remark
1	2465.90	28.82	6.42	69.81	104.85	74.00	-30.85	Peak
2	2483.50	28.86	6.45	30.32	65.43	74.00	8.57	Peak
3	2485.70	28.88	6.45	34.30	69.41	74.00	4.59	Peak

Remarks: 1. Emission Level= Antenna Factor + Cable Loss + Reading  
 2. The emission levels that are 20dB below the official limit are not reported.

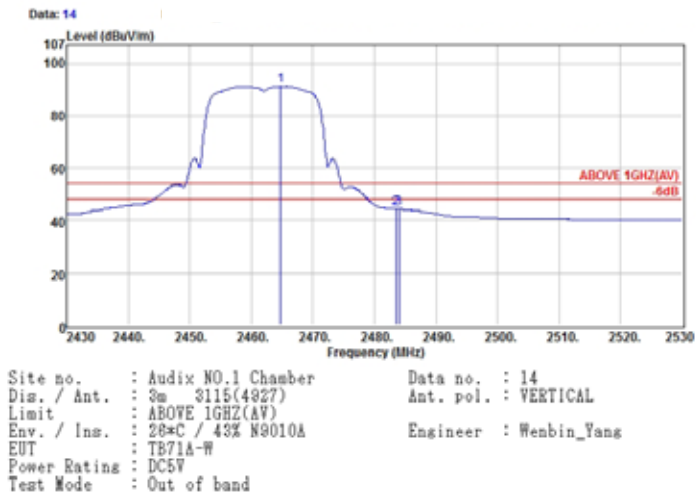

	Freq. (MHz)	Ant. Factor (dB/m)	Cable Loss (dB)	Reading (dBμV)	Emission Level (dBμV/m)	Limit (dBμV/m)	Margin (dB)	Remark
1	2464.80	28.82	6.42	56.27	91.31	54.00	-37.31	Average
2	2483.50	28.86	6.45	9.48	44.57	54.00	9.43	Average
3	2484.00	28.88	6.45	9.43	44.54	54.00	9.48	Average

Remarks: 1. Emission Level= Antenna Factor + Cable Loss + Reading  
 2. The emission levels that are 20dB below the official limit are not reported.

## 4.6.2. For BLE Function

**For Frequency Range 30MHz~1000MHz:**

The EUT emitted the fundamental frequency with data code at the stand, side and lying conditions.

The EUT select **worst position “lying”** and link AC adapter and with following test modes was performed during this section testing and all the test results are listed in section 4.6.2.1.

Mode	Type of Network	Channel	Frequency	Test Mode	Reference Test Data	
					Horizontal	Vertical
1.	BLE	CH 0	2402MHz	Transmit	# 2	# 1
2.	BLE	CH 19	2440MHz		# 2	# 1
3.	BLE	CH 39	2480MHz		# 2	# 1

\* Above all final readings were measured with Peak detector.

**2.4GHz for Frequency above 1GHz:**

The emissions (up to 25GHz) not reported are too low to be measured.

**For Restricted Bands:**

The EUT select **worst position “lying”** land ink AC adapter and with following test modes was performed during this section testing and all the test results are listed in section 4.6.2.2. (The restricted bands defined in part 15.205(a))

Mode	Type of Network	Channel	Frequency	Test Mode	Reference Test Data	
					Horizontal	Vertical
1.	BLE	CH 0	2402MHz	Transmit	# 3, # 4	# 1, # 2
2.		CH 39	2480MHz		# 7, # 8	# 5, # 6









4.6.2.2. Restricted Bands Measurement Results

Date of Test : 2014. 05. 13 Temperature : 26

EUT : 7" Pocketable Pad Humidity : 43%

Test Mode : BLE, Transmit, Channel: 0, Frequency: 2402MHz

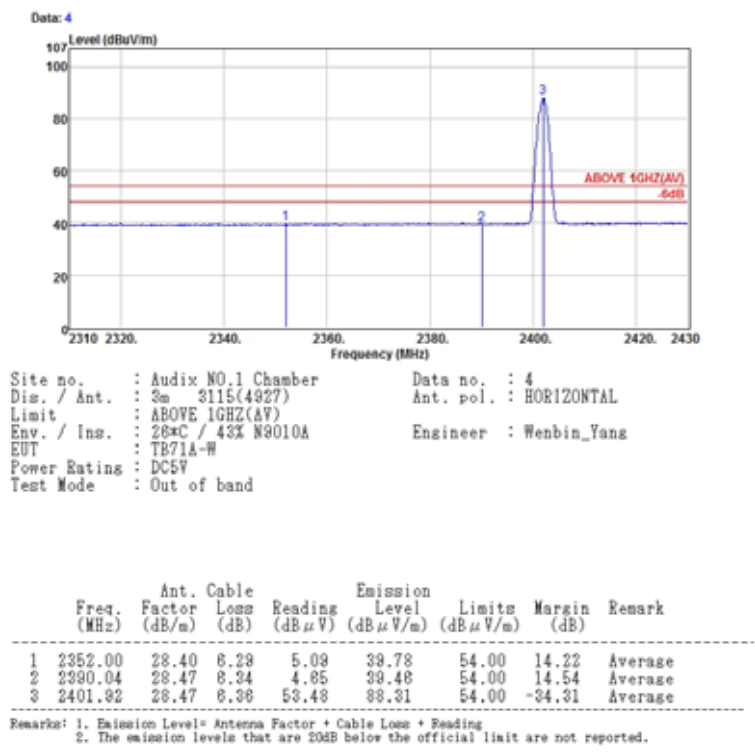
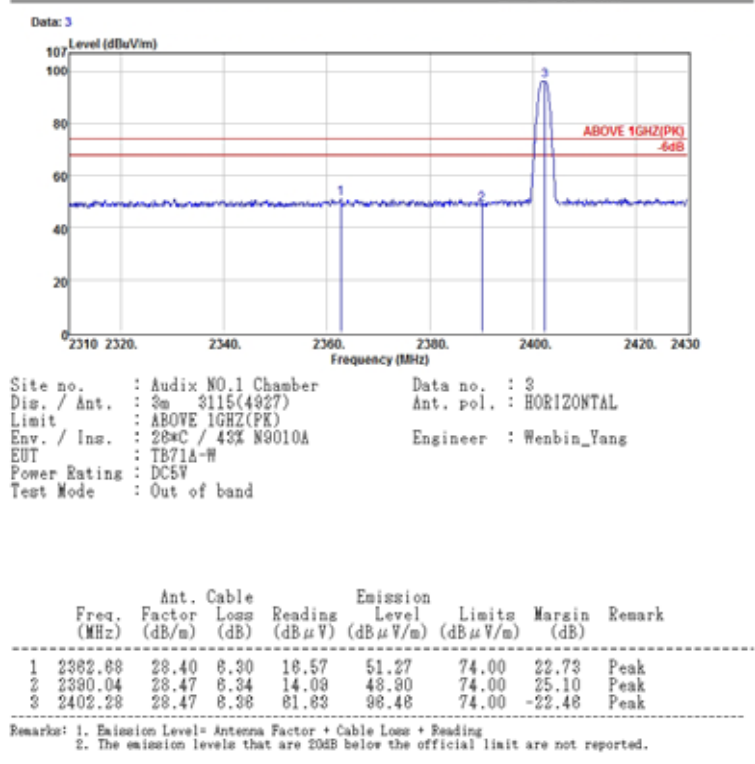

Date of Test : 2014. 05. 13 Temperature : 26

EUT : 7" Pocketable Pad Humidity : 43%

Test Mode : BLE, Transmit, Channel: 0, Frequency: 2402MHz

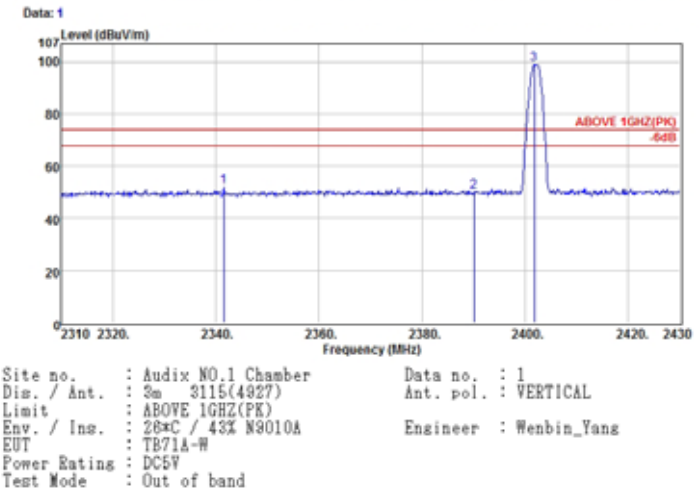

	Freq. (MHz)	Ant. Factor (dB/m)	Cable Loss (dB)	Reading (dB μV)	Emission Level (dB μV/m)	Limit (dB μV/m)	Margin (dB)	Remark
1	2341.56	28.38	8.28	17.31	51.95	74.00	22.05	Peak
2	2390.04	28.47	8.34	15.43	50.24	74.00	23.78	Peak
3	2401.80	28.47	8.35	64.11	89.93	74.00	-24.93	Peak

Remarks: 1. Emission Level= Antenna Factor + Cable Loss + Reading  
2. The emission levels that are 20dB below the official limit are not reported.

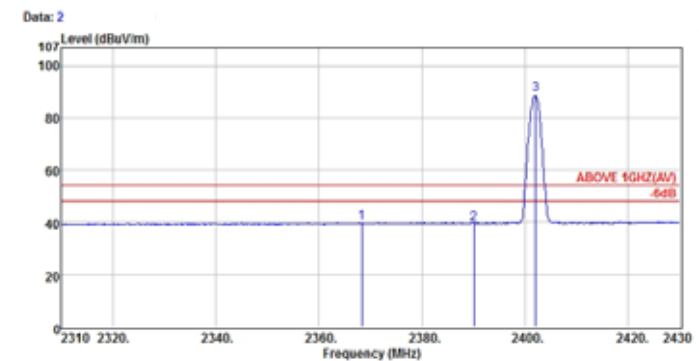

	Freq. (MHz)	Ant. Factor (dB/m)	Cable Loss (dB)	Reading (dB μV)	Emission Level (dB μV/m)	Limit (dB μV/m)	Margin (dB)	Remark
1	2388.32	28.40	6.31	5.01	39.72	54.00	14.28	Average
2	2390.04	28.47	8.34	4.51	39.32	54.00	14.88	Average
3	2402.04	28.47	8.38	54.34	89.17	54.00	-35.17	Average

Remarks: 1. Emission Level= Antenna Factor + Cable Loss + Reading  
2. The emission levels that are 20dB below the official limit are not reported.

Date of Test : 2014. 05. 13 Temperature : 26

EUT : 7" Pocketable Pad Humidity : 43%

Test Mode : BLE, Transmit, Channel: 39, Frequency: 2480MHz

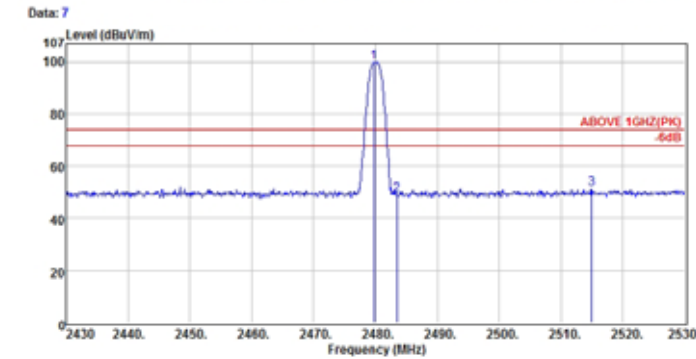

Site no. : Audix NO.1 Chamber Data no. : 7  
 Dis. / Ant. : 3m 3115(4927) Ant. pol. : HORIZONTAL  
 Limit : ABOVE 1GHZ(PK)  
 Env. / Ins. : 28°C / 43% N9010A Engineer : Wenbin\_Yang  
 EUT : TB71A-W  
 Power Rating : DC5V  
 Test Mode : Out of band

	Freq. (MHz)	Ant. Factor (dB/m)	Cable Loss (dB)	Reading (dB μV)	Emission Level (dB μV/m)	Limit (dB μV/m)	Margin (dB)	Remark
1	2479.80	28.88	6.44	64.79	89.89	74.00	-25.89	Peak
2	2480.50	28.88	6.45	13.72	48.93	74.00	25.17	Peak
3	2514.90	28.76	6.49	16.08	51.34	74.00	22.66	Peak

Remarks: 1. Emission Level= Antenna Factor + Cable Loss + Reading  
 2. The emission levels that are 20dB below the official limit are not reported.

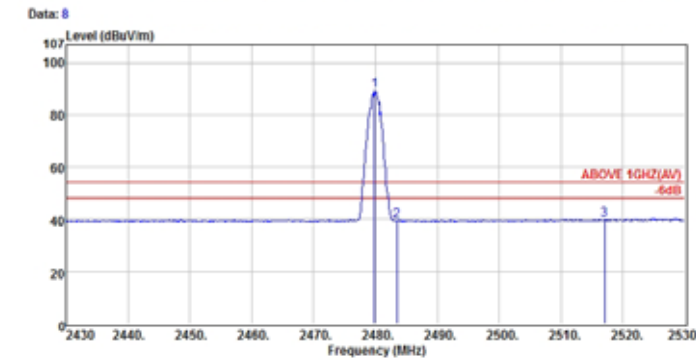

Site no. : Audix NO.1 Chamber Data no. : 8  
 Dis. / Ant. : 3m 3115(4927) Ant. pol. : HORIZONTAL  
 Limit : ABOVE 1GHZ(AV)  
 Env. / Ins. : 28°C / 43% N9010A Engineer : Wenbin\_Yang  
 EUT : TB71A-W  
 Power Rating : DC5V  
 Test Mode : Out of band

	Freq. (MHz)	Ant. Factor (dB/m)	Cable Loss (dB)	Reading (dB μV)	Emission Level (dB μV/m)	Limit (dB μV/m)	Margin (dB)	Remark
1	2479.90	28.88	6.44	54.33	89.43	54.00	-35.43	Average
2	2480.50	28.88	6.45	4.22	39.33	54.00	14.87	Average
3	2517.00	28.76	6.49	4.68	39.93	54.00	14.07	Average

Remarks: 1. Emission Level= Antenna Factor + Cable Loss + Reading  
 2. The emission levels that are 20dB below the official limit are not reported.

Date of Test : 2014. 05. 13 Temperature : 26

EUT : 7" Pocketable Pad Humidity : 43%

Test Mode : BLE, Transmit, Channel: 39, Frequency: 2480MHz

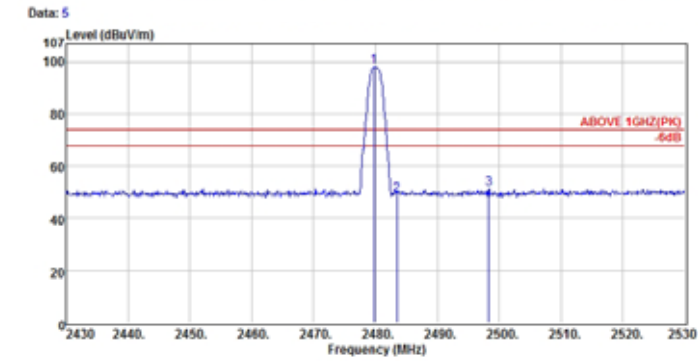

Site no. : Audix NO.1 Chamber Data no. : 5  
 Dis. / Ant. : 3m 3115(4927) Ant. pol. : VERTICAL  
 Limit : ABOVE 1GHZ(PK)  
 Env. / Ins. : 28°C / 43% N9010A Engineer : Wenbin\_Yang  
 EUT : TB71A-W  
 Power Rating : DC5V  
 Test Mode : Out of band

	Freq. (MHz)	Ant. Factor (dB/m)	Cable Loss (dB)	Reading (dB μV)	Emission Level (dB μV/m)	Limit (dB μV/m)	Margin (dB)	Remark
1	2479.80	28.88	6.44	63.01	98.11	74.00	-24.11	Peak
2	2493.50	28.88	6.45	13.98	49.07	74.00	24.93	Peak
3	2498.30	28.70	6.47	16.08	51.26	74.00	22.74	Peak

Remarks: 1. Emission Level= Antenna Factor + Cable Loss + Reading  
 2. The emission levels that are 20dB below the official limit are not reported.

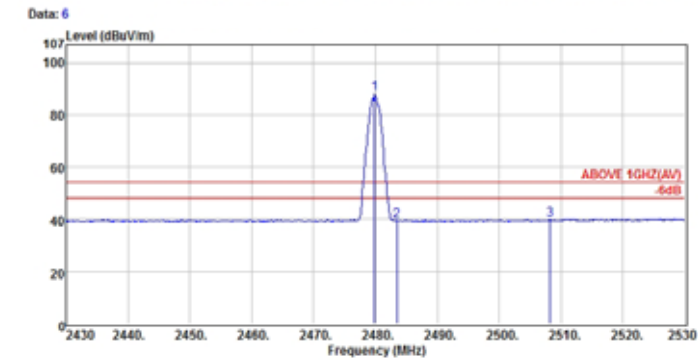

Site no. : Audix NO.1 Chamber Data no. : 6  
 Dis. / Ant. : 3m 3115(4927) Ant. pol. : VERTICAL  
 Limit : ABOVE 1GHZ(AV)  
 Env. / Ins. : 28°C / 43% N9010A Engineer : Wenbin\_Yang  
 EUT : TB71A-W  
 Power Rating : DC5V  
 Test Mode : Out of band

	Freq. (MHz)	Ant. Factor (dB/m)	Cable Loss (dB)	Reading (dB μV)	Emission Level (dB μV/m)	Limit (dB μV/m)	Margin (dB)	Remark
1	2479.90	28.88	6.44	53.06	88.16	54.00	-34.16	Average
2	2493.50	28.88	6.45	4.31	39.42	54.00	14.58	Average
3	2508.20	28.78	6.48	4.71	39.95	54.00	14.05	Average

Remarks: 1. Emission Level= Antenna Factor + Cable Loss + Reading  
 2. The emission levels that are 20dB below the official limit are not reported.

## 5. 6dB BANDWIDTH MEASUREMENT

### 5.1. Test Equipment

The following test equipment was used during the Emission Bandwidth measurement:

Item	Type	Manufacturer	Model No.	Serial No.	Cal. Due Date
1.	Spectrum Analyzer	Agilent	N9030A-544	US51350140	2014. 07. 30

### 5.2. Block Diagram of Test Setup

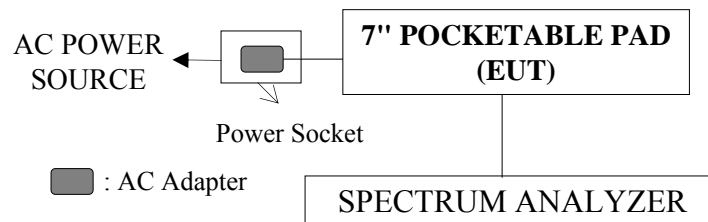

### 5.3. Specification Limits [§15.247(a)(2)]

The minimum 6dB bandwidth shall be at least 500kHz.

### 5.4. Operating Condition of EUT

The test program "WL command" for WLAN and test program "Blue tool" for BLE was used to enable the EUT to transmit data at different channel frequency individually.

### 5.5. Test Procedure

The transmitter output was connected to the spectrum analyzer. The bandwidth of the fundamental frequency was measure by spectrum analyzer with 1.5% EBW,  $VBW \geq 3 \times RBW$ . The 6dB bandwidth is defined as the total spectrum the power of which is higher than peak power minus 6dB.

The measurement guideline was according to 558074 D01 DTS Meas Guidance v03r01

## 5.6. Test Results

**PASSED.** All the test results are attached in next pages.

### 5.6.1. WLAN Function

Test Date : 2014. 05. 02    Temperature : 26    Humidity : 50%

Mode	Type of Network	Channel	Frequency	6dB Bandwidth (MHz)
1.	802.11b	CH 1	2412MHz	<b>9.00</b>
2.		CH 6	2437MHz	<b>9.00</b>
3.		CH 11	2462MHz	<b>9.00</b>
4.	802.11g	CH 1	2412MHz	<b>16.00</b>
5.		CH 6	2437MHz	<b>16.00</b>
6.		CH 11	2462MHz	<b>16.00</b>
7.	802.11n-HT20	CH 1	2412MHz	<b>16.00</b>
8.		CH 6	2437MHz	<b>16.00</b>
9.		CH 11	2462MHz	<b>16.00</b>

[Limit: least 500kHz]

### 802.11b, Frequency: 2412MHz



### 802.11b, Frequency: 2437MHz



802.11b, Frequency: 2462MHz



802.11g, Frequency: 2412MHz





802.11g, Frequency: 2437MHz



802.11g, Frequency: 2462MHz



### 802.11n-HT20, Frequency: 2412MHz

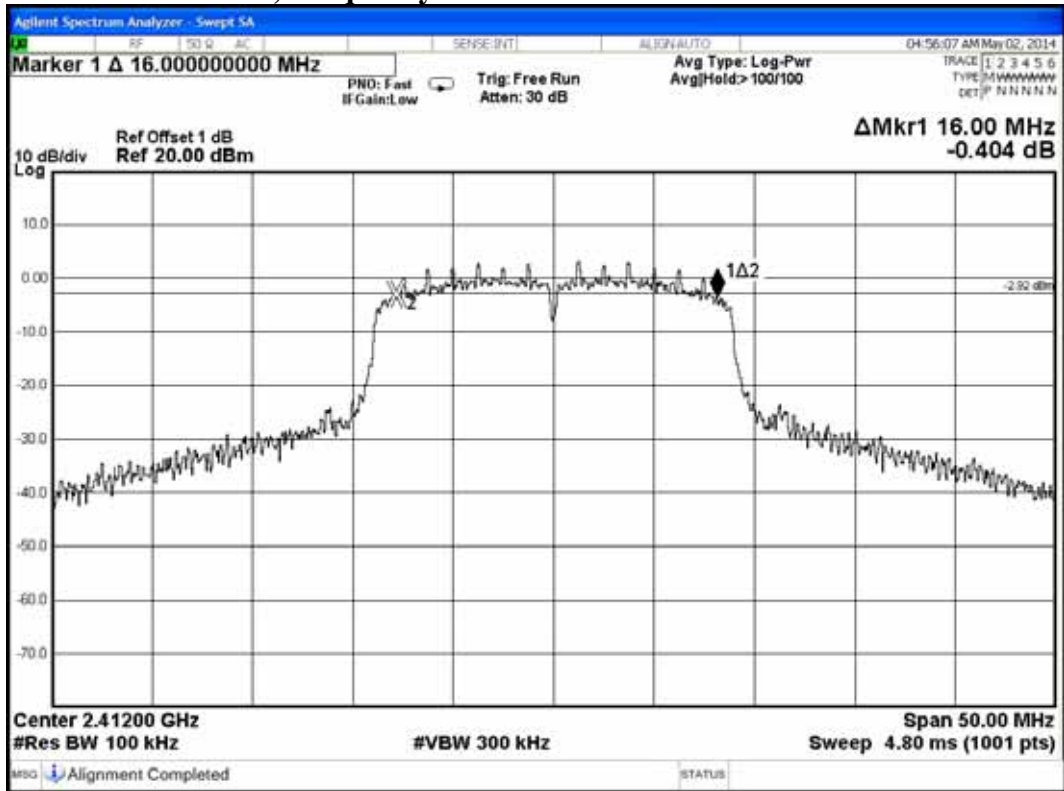

### 802.11n-HT20, Frequency: 2437MHz

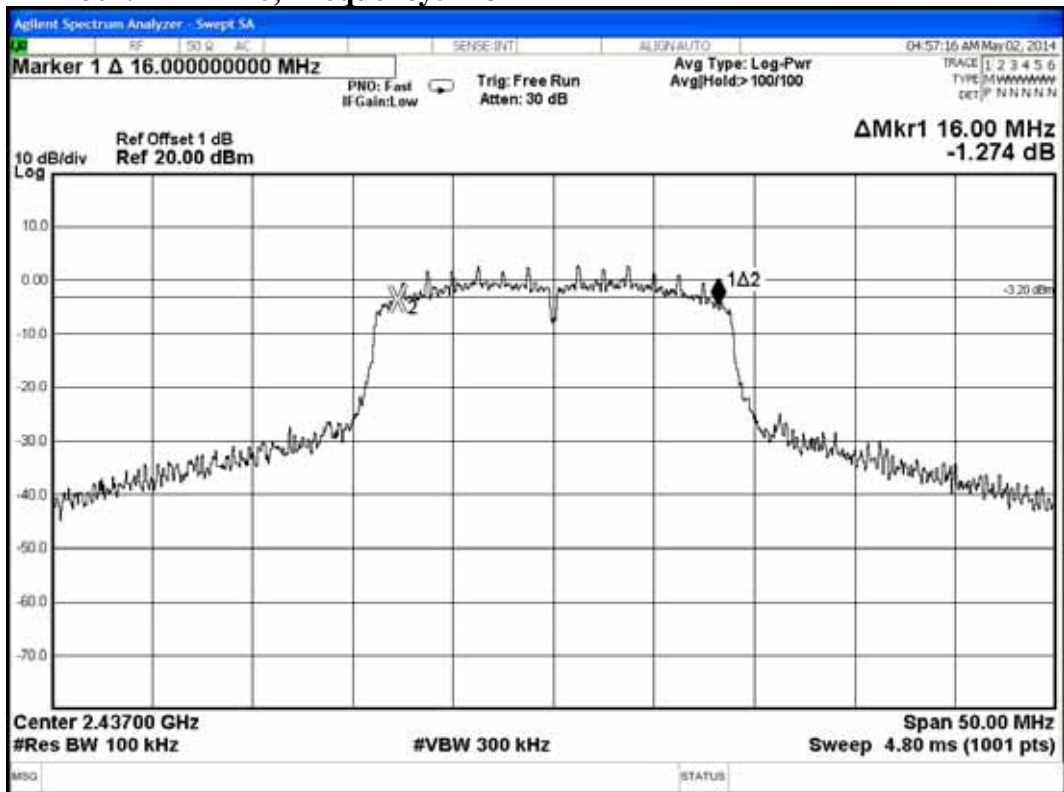

802.11n-HT20, Frequency: 2462MHz



5.6.2. BT Function

Test Date : 2014. 05. 02    Temperature : 26    Humidity : 50%  
Test Date : 2014. 05. 21    Temperature : 25    Humidity : 48%

Mode	Channel	Frequency	6dB Bandwidth (kHz)
1.	CH 0	2402MHz	523
2.	CH 19	2440MHz	525
3.	CH 39	2480MHz	510

[Limit: least 500kHz]

BLE, Frequency: 2402MHz





## 6. MAXIMUM PEAK OUTPUT POWER MEASUREMENT

### 6.1. Test Equipment

The following test equipment was used during the maximum peak output power measurement:

Item	Type	Manufacturer	Model No.	Serial No.	Cal. Due Date
1.	Power Meter	Anritsu	ML2495A	1145008	2014. 10. 22
2.	Power Sensor	Anritsu	MA2411B	1126096	2014. 10. 22

### 6.2. Block Diagram of Test Setup

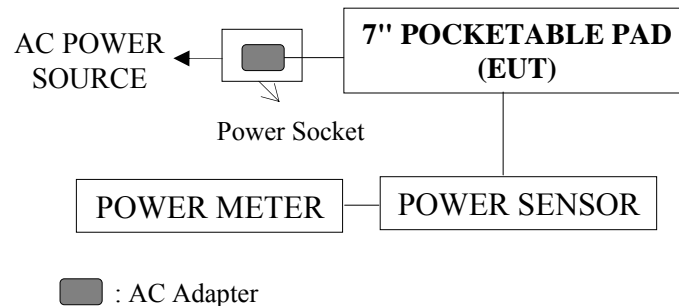

### 6.3. Specification Limits (§15.247(b)-(3))

The Limits of maximum Peak Output Power for digital modulation in 2400-2483.5MHz & 5725-5850MHz is : 1Watt. (30dBm)

### 6.4. Operating Condition of EUT

The test program “WL command” for WLAN and test program “Blue tool” for BLE was used to enable the EUT to transmit data at different channel frequency individually.

### 6.5. Test Procedure

The transmitter output was connected to the power sensor and record the reading of power meter.

The measurement guideline was according to 558074 D01 DTS Meas Guidance v03r01.

Pursuant to KDB 662911, we executed conducted test for chain 0 as worse performance, and a factor  $10\log(N)$  shall be added, where N is the number of output.

## Test Results

**PASSED.** All the test results are listed below.

## 6.5.1. WLAN Function

Test Date: 2014. 05. 02 Temperature: 26 Humidity: 50%

Mode	Type of Network	Channel	Frequency	Peak Output Power (dBm)		Total Peak Output Power (dBm)	Power Setting
				Main (Chain 0)	AUX (Chain 1)		
1.	802.11b	CH 1	2412MHz	15.95	---	<b>15.28</b>	62
2.		CH 6	2437MHz	15.94	---	<b>15.31</b>	62
3.		CH 11	2462MHz	15.98	---	<b>15.71</b>	61
4.	802.11g	CH 1	2412MHz	12.51	12.65	<b>15.59</b>	47
5.		CH 6	2437MHz	14.10	14.33	<b>17.23</b>	52
6.		CH 11	2462MHz	13.90	14.25	<b>17.09</b>	52
7.	802.11n-HT20	CH 1	2412MHz	14.19	13.55	<b>16.89</b>	54
8.		CH 6	2437MHz	14.25	13.57	<b>16.93</b>	52
9.		CH 11	2462MHz	13.40	13.14	<b>16.28</b>	50

[Limit: 1Watt. (30dBm)]

## 6.5.2. BLE Function

Test Date: 2014. 05. 02 Temperature: 26 Humidity: 50%

Mode	Channel	Frequency	Peak Output Power (dBm)
1.	CH 0	2402MHz	<b>3.05</b>
2.	CH 19	2440MHz	<b>3.03</b>
3.	CH 39	2480MHz	<b>3.14</b>

[Limit: 1Watt. (30dBm)]

## 7. EMISSION LIMITATIONS MEASUREMENT

### 7.1. Test Equipment

The following test equipment was used during the emission limitations test :

Item	Type	Manufacturer	Model No.	Serial No.	Cal. Due Date
1.	Spectrum Analyzer	Agilent	N9030A-544	US51350140	2014. 07. 30

### 7.2. Block Diagram of Test Setup

The same as section.5.2

### 7.3. Specification Limits [§15.247(c)]

7.3.1. In any 100kHz bandwidth outside the frequency band in which the spread spectrum or digitally modulated intentional radiator is operating, the radio frequency power that is produced by the intentional radiator shall be at least 20dB below that in the 100kHz bandwidth within the band that contains the highest level of the desired power, based on either an RF conducted or a radiated measurement. Attenuation below the general limits specified in Section 15.209(a) is not required. In addition, radiated emissions which fall in restricted bands, as defined in Section 15.205(a), must also comply with the radiated emission limits specified in Section 15.209(a) (See Section 15.205(c)).( This test result attaching to §4.6.1.2 and §4.6.2.2)

7.3.2. The reference level for determining limit of emission limitations is according to the value measured indicated in plots at section 9.6.

### 7.4. Operating Condition of EUT

Test program RF Test is used for enabling the EUT transmitting continuing.

### 7.5. Test Procedure

The RF output of EUT was connected to the spectrum analyzer. The bandwidth of the fundamental frequency was measure by spectrum analyzer with 100kHz RBW and 300kHz VBW.

The measurement guideline was according to 558074 D01 DTS Meas Guidance v03r01.

Pursuant to KDB 662911, we executed conducted test for chain 0 as worse performance, and a factor  $10\log(N)$  shall be added, where N is the number of output.

### 7.6. Test Results

**PASSED.** The testing data was attached in the next pages.

Test Date : 2014. 05. 16    Temperature : 25            Humidity : 60%

Test Date : 2014. 05. 21    Temperature : 25            Humidity : 48%



7.6.1. WLAN Function

802.11b, Frequency: 2412MHz

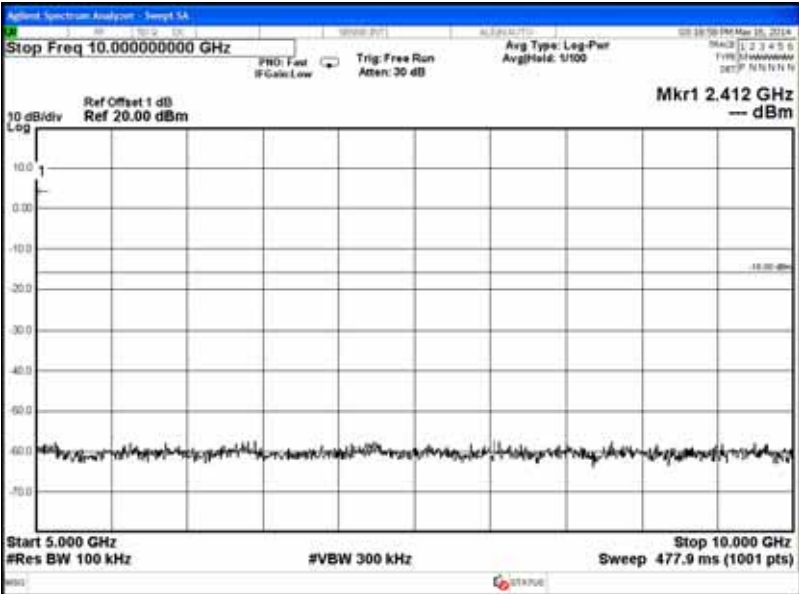
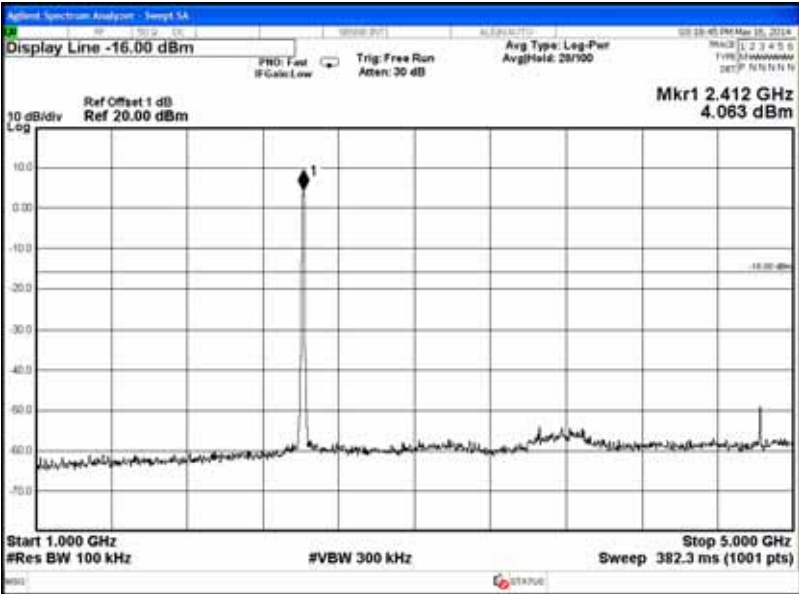
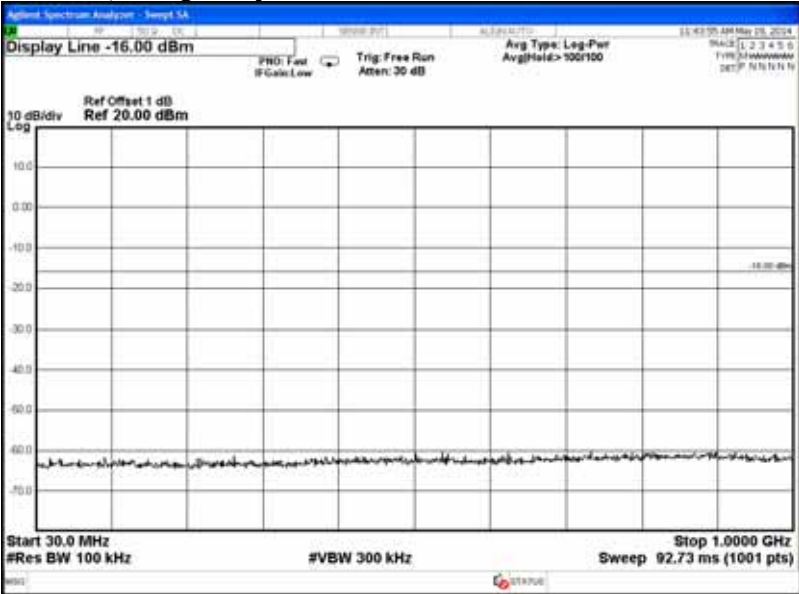

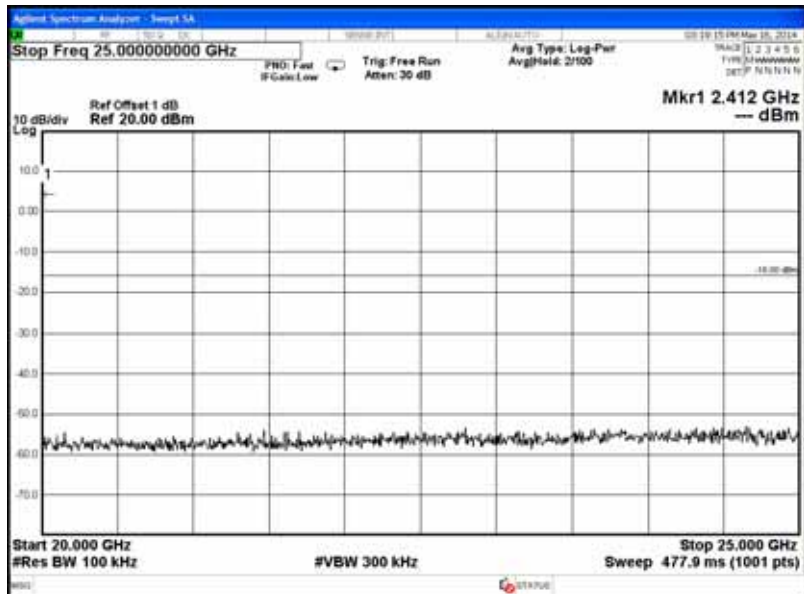
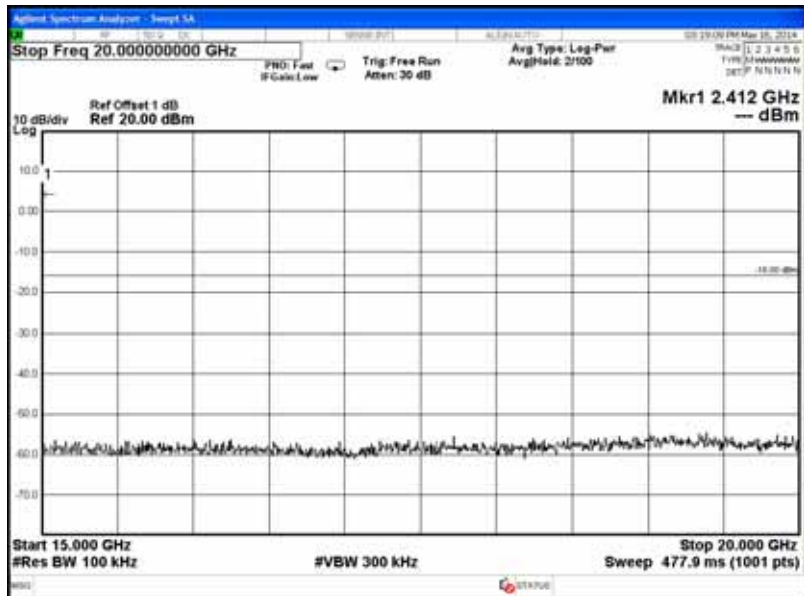
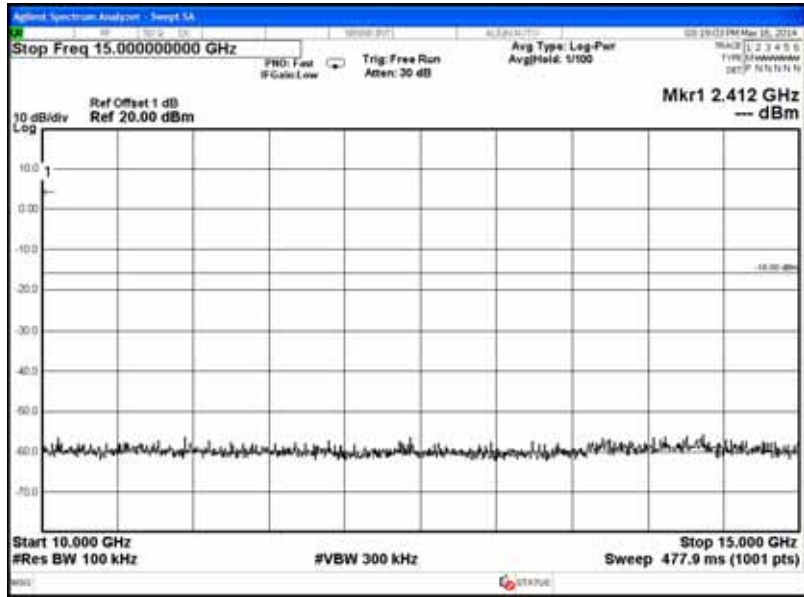

### 802.11b, Frequency: 2437MHz

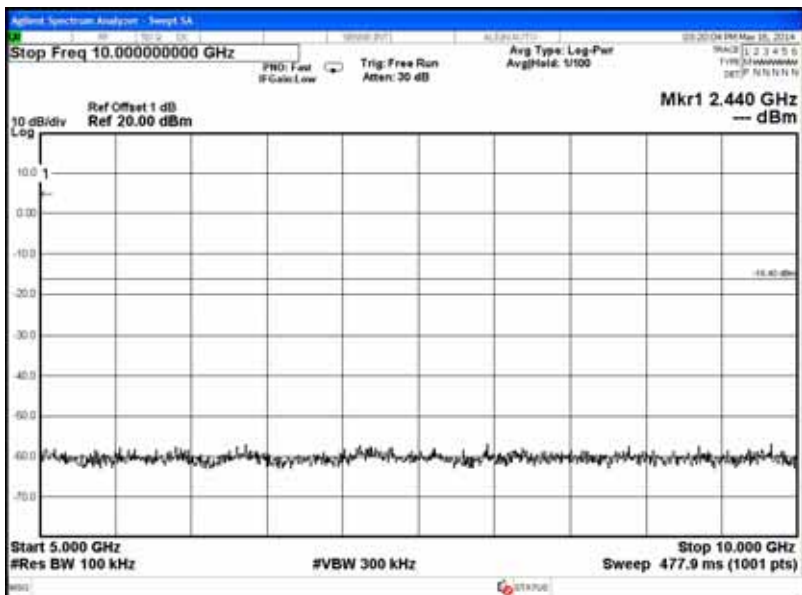
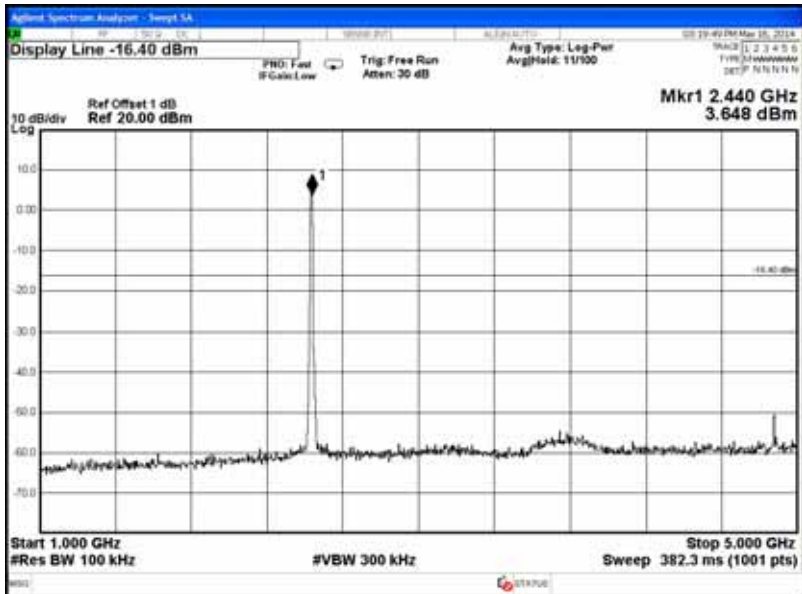

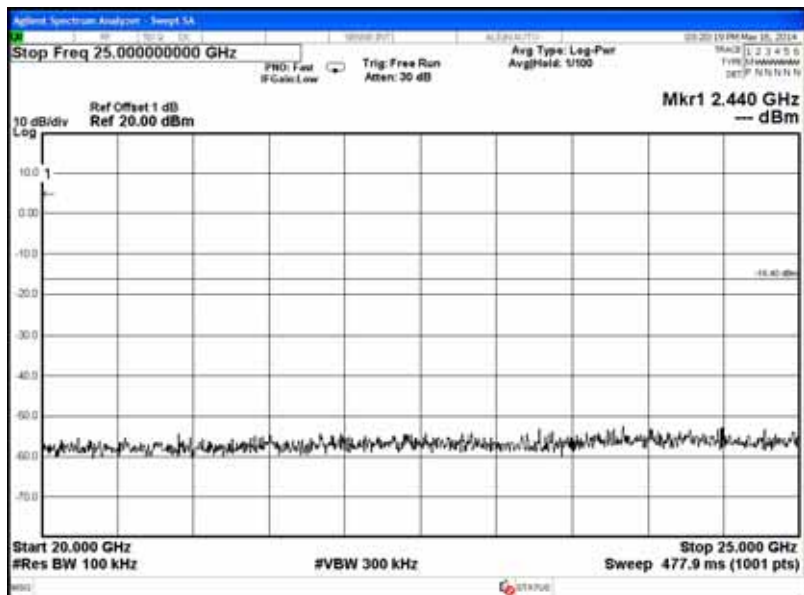
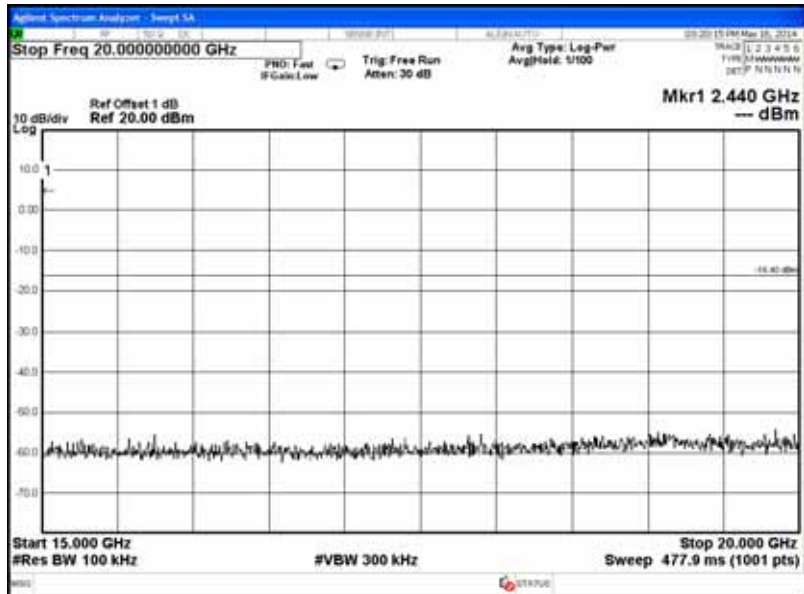
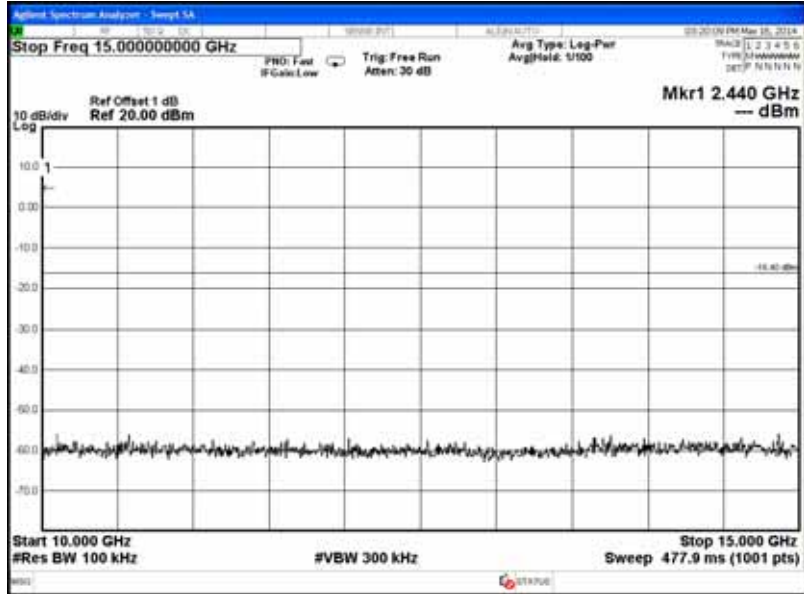

### 802.11b, Frequency: 2462MHz

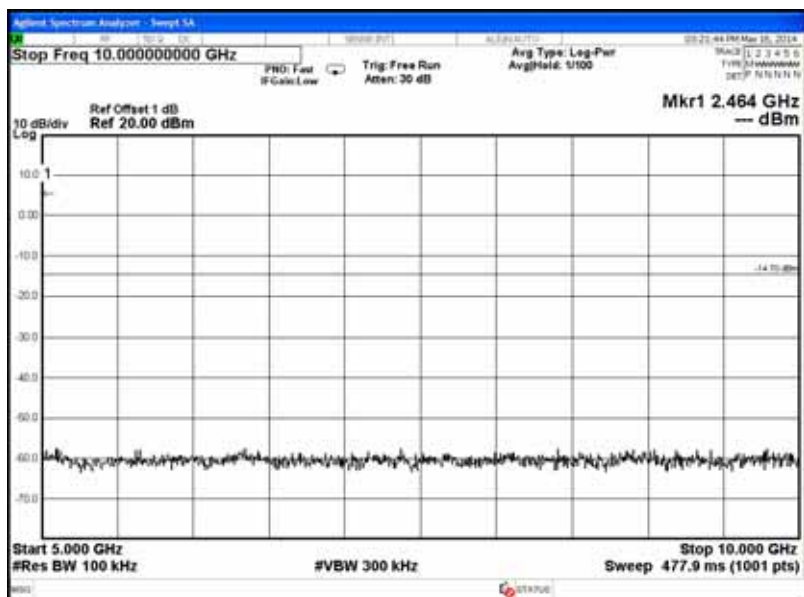
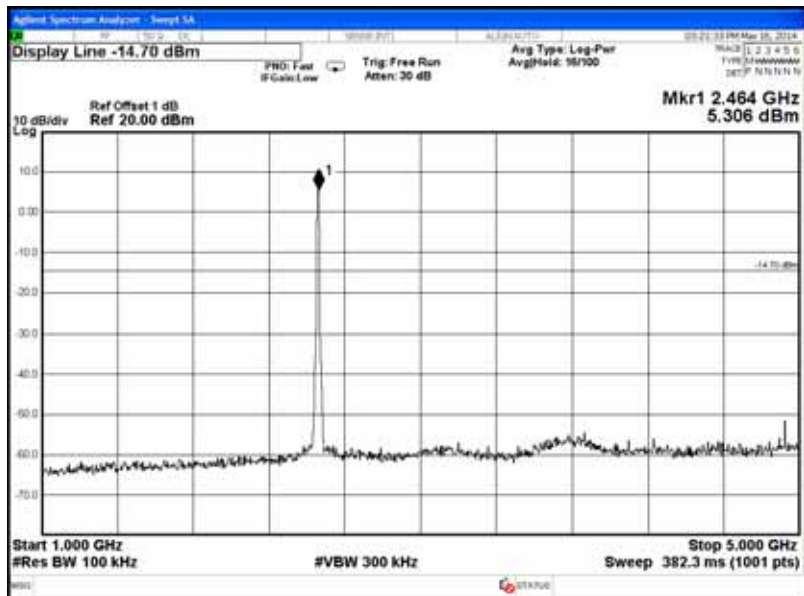

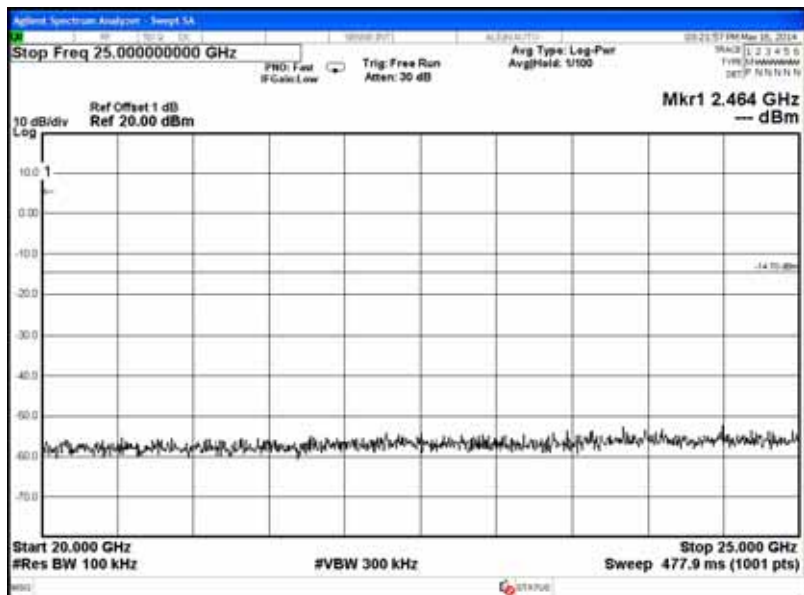
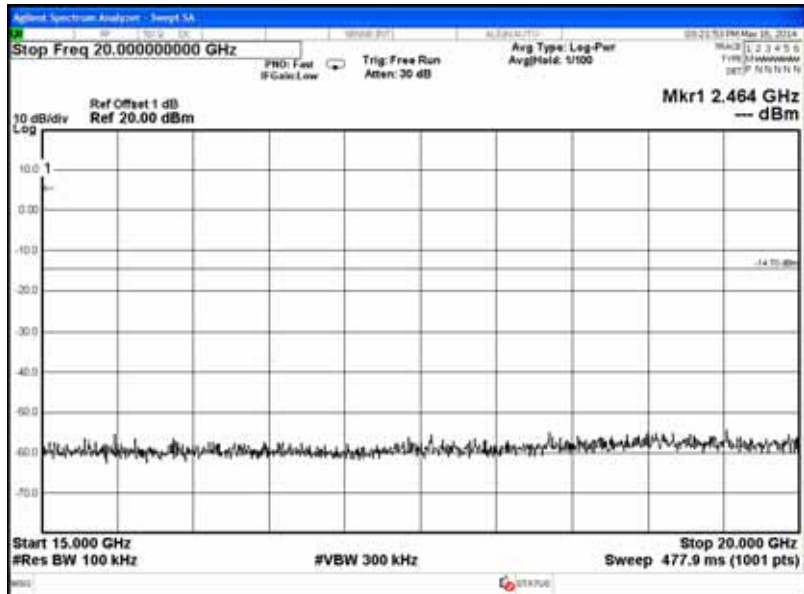
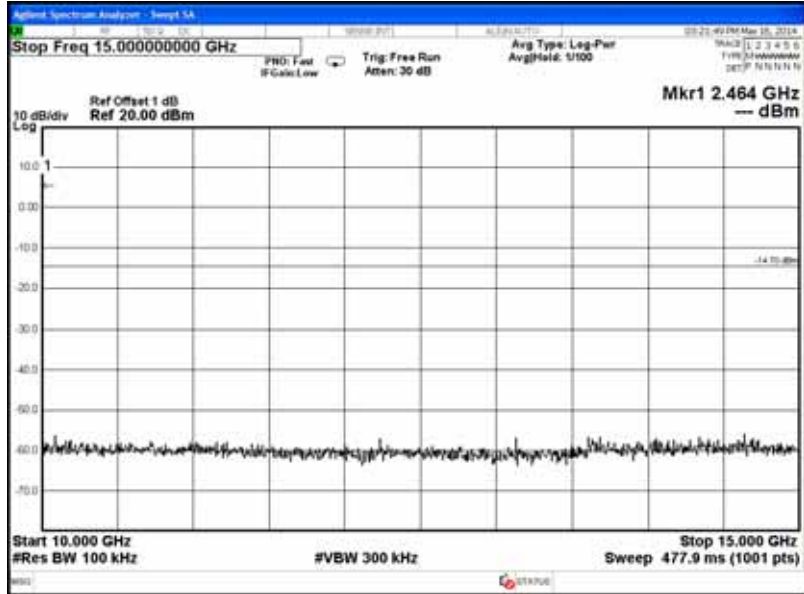

### 802.11g, Frequency: 2412MHz

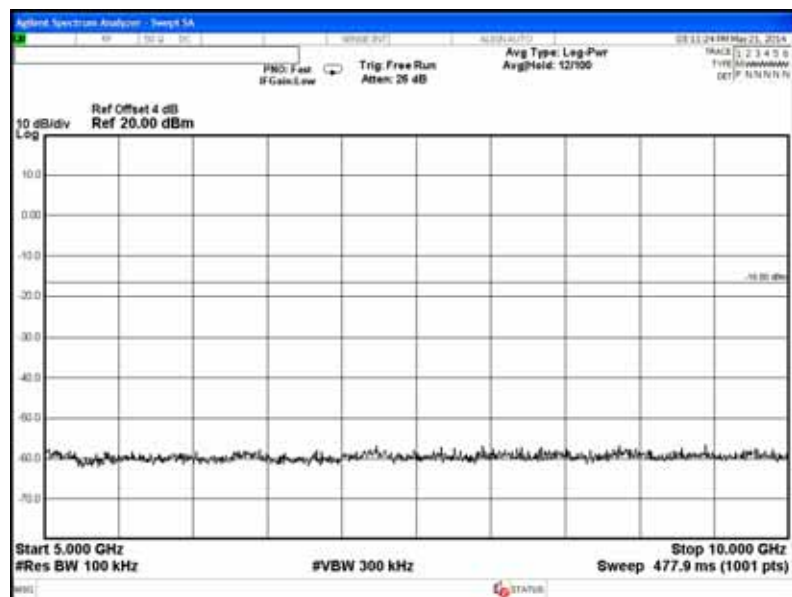
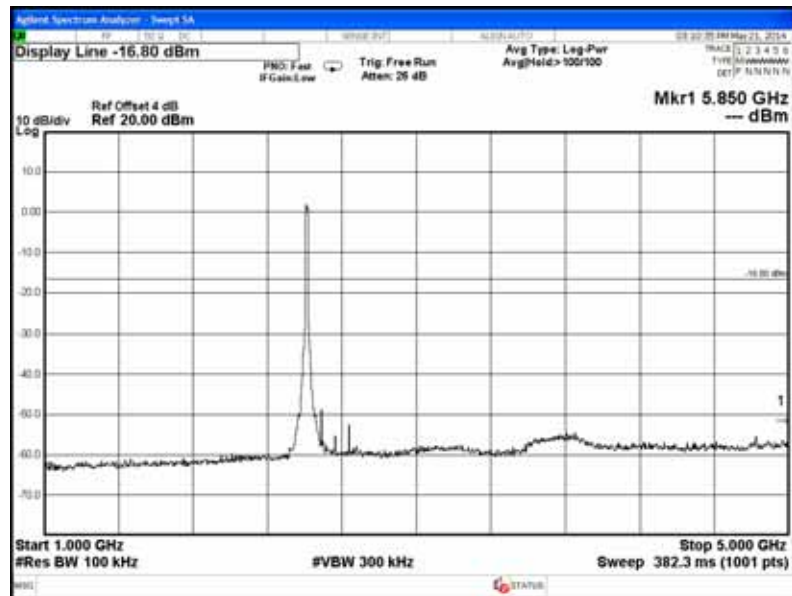
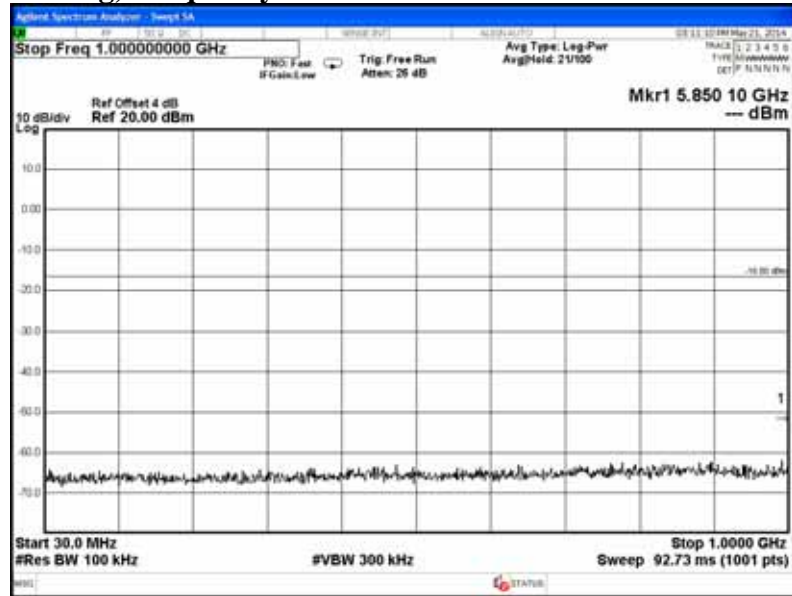

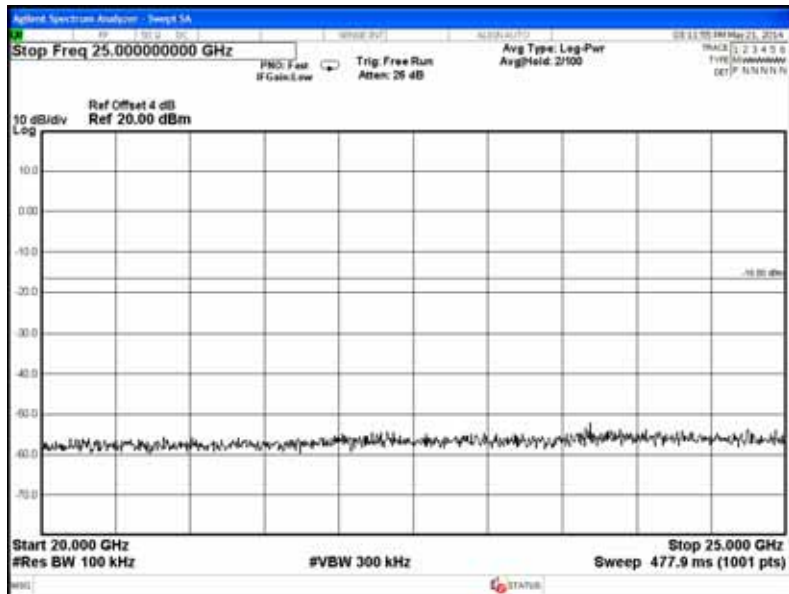
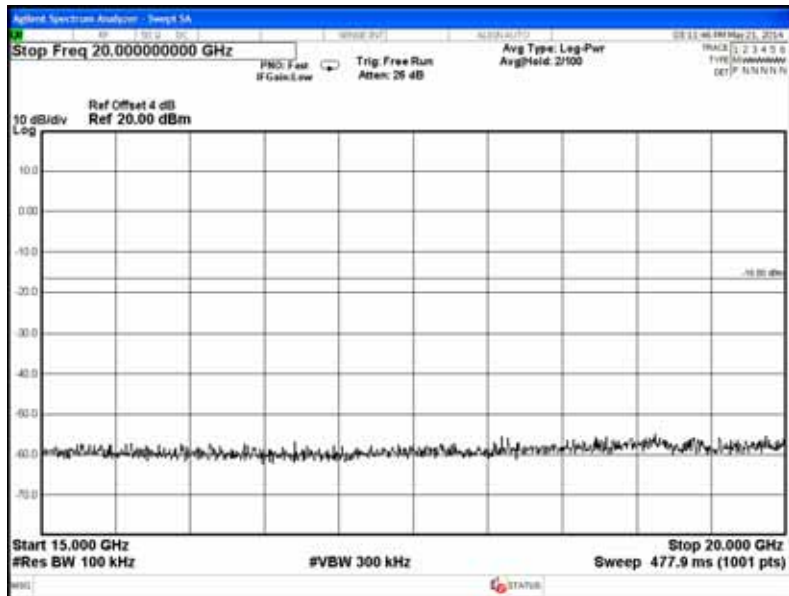
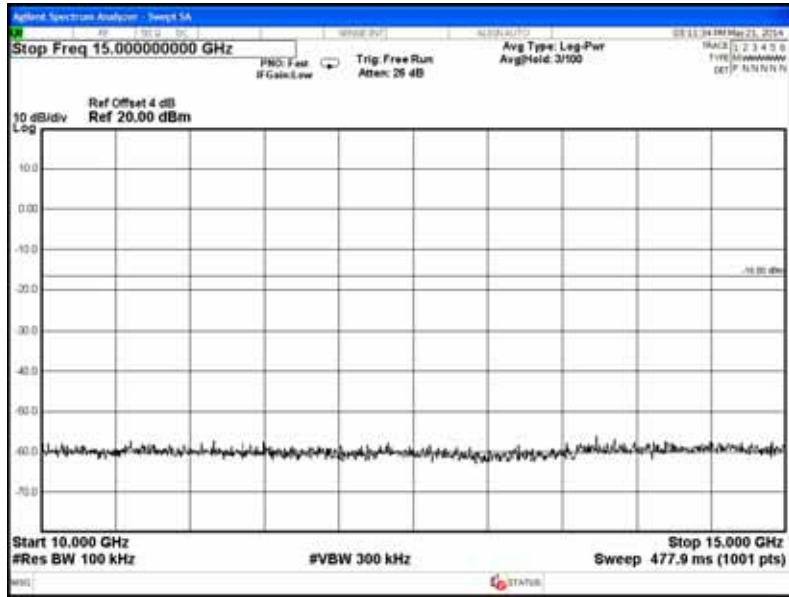



802.11g, Frequency: 2437MHz

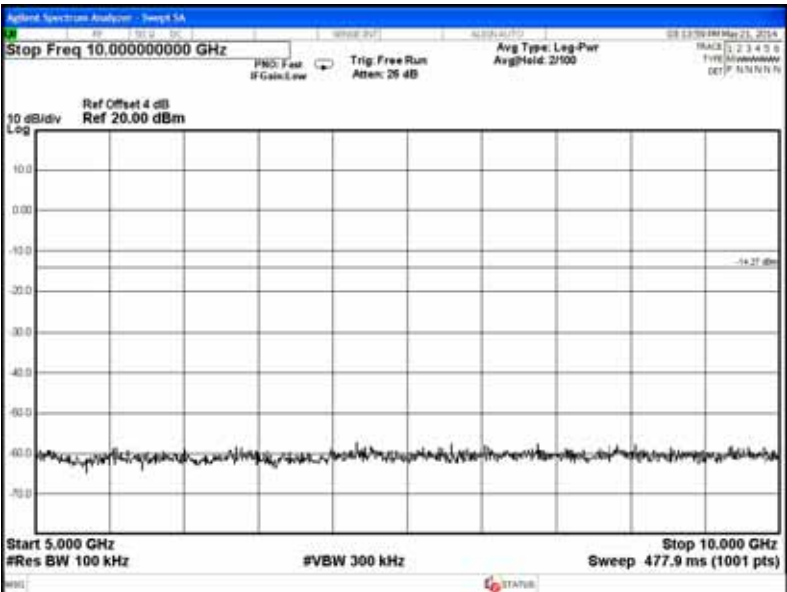
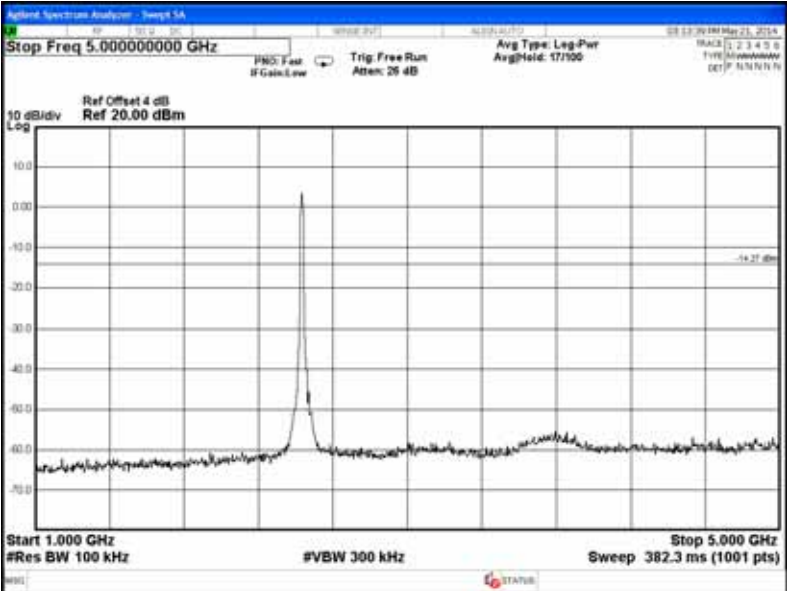
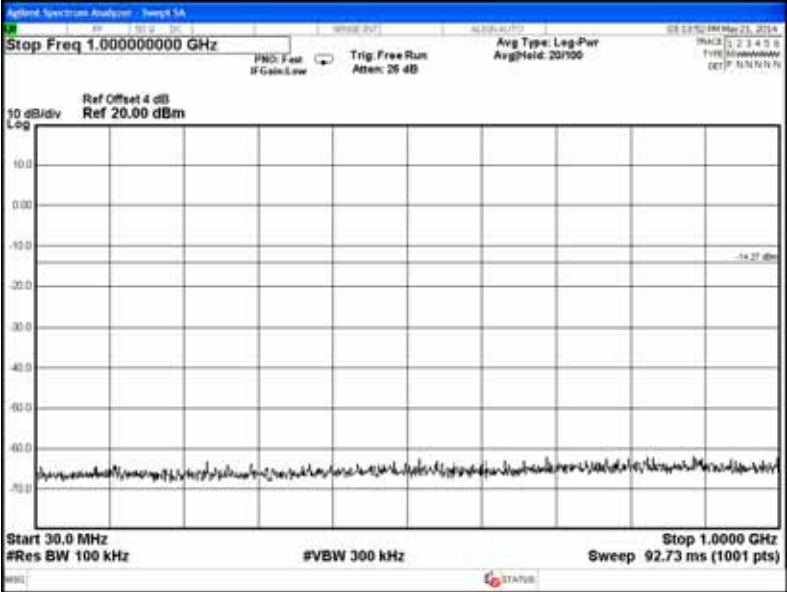

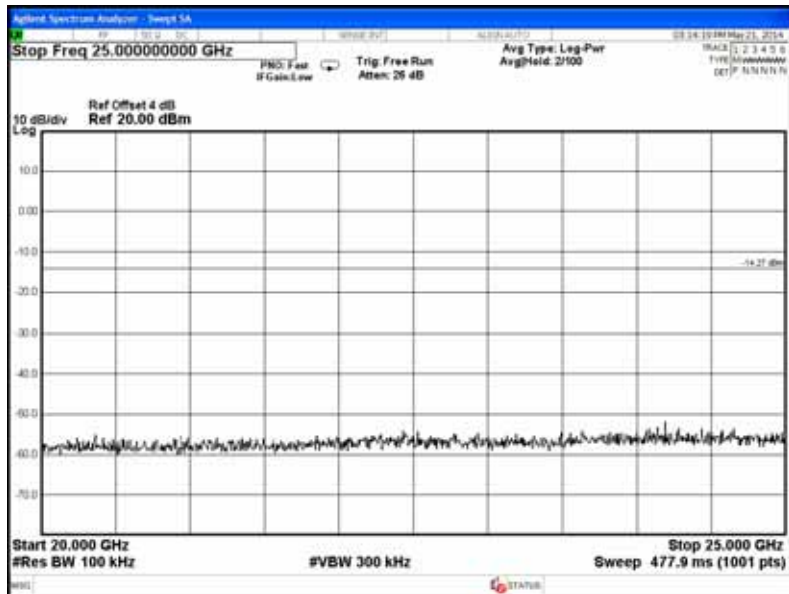
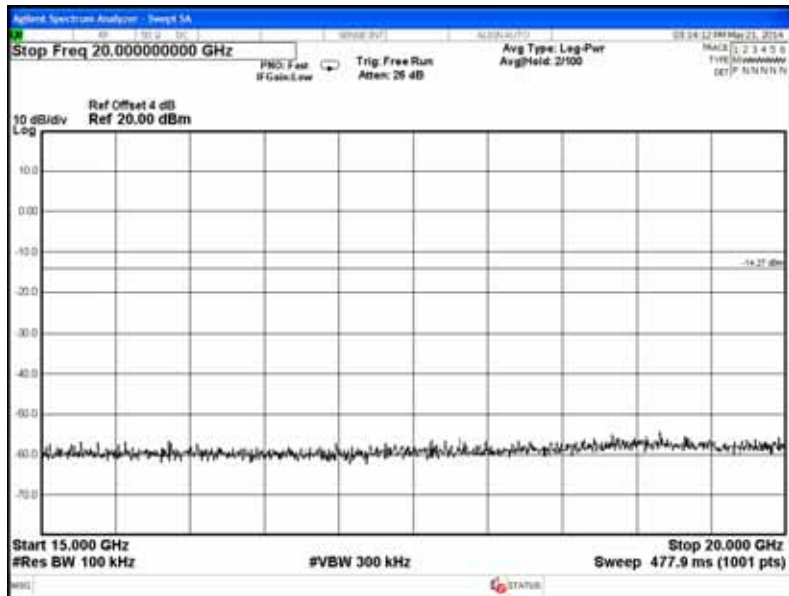
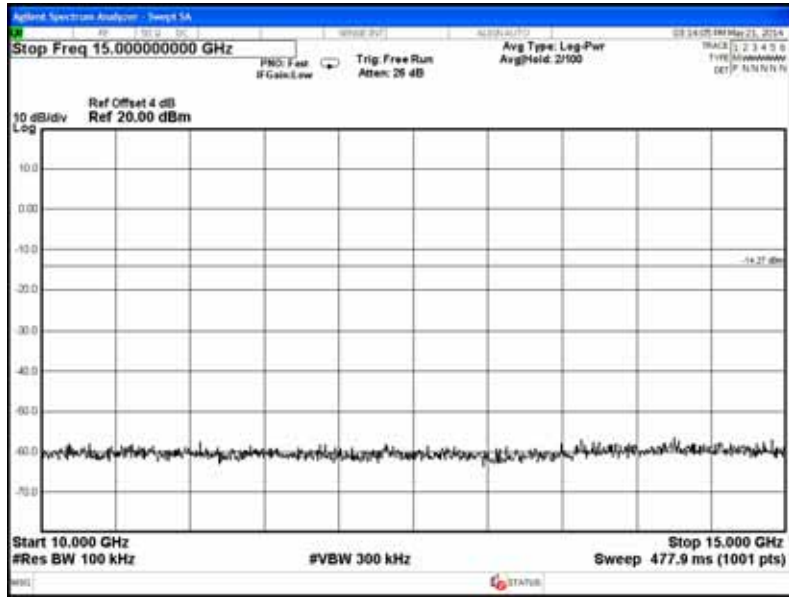

802.11g, Frequency: 2462MHz

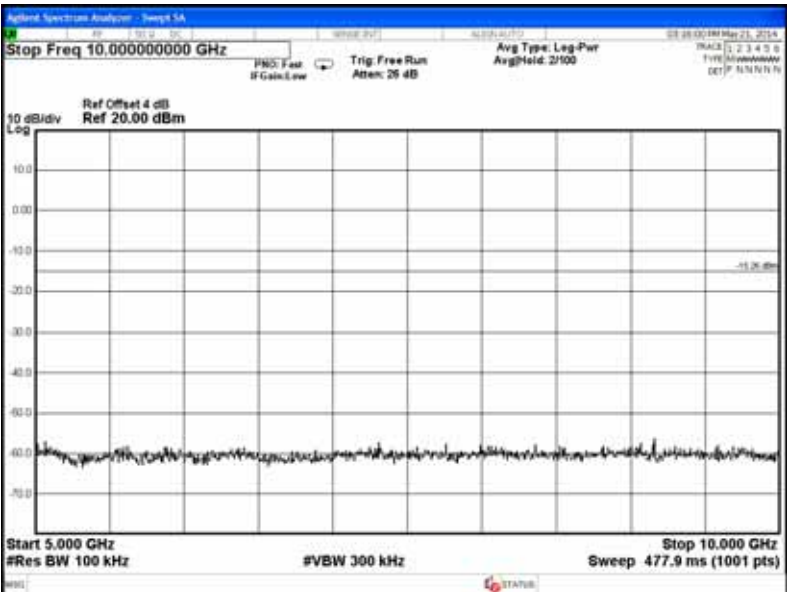
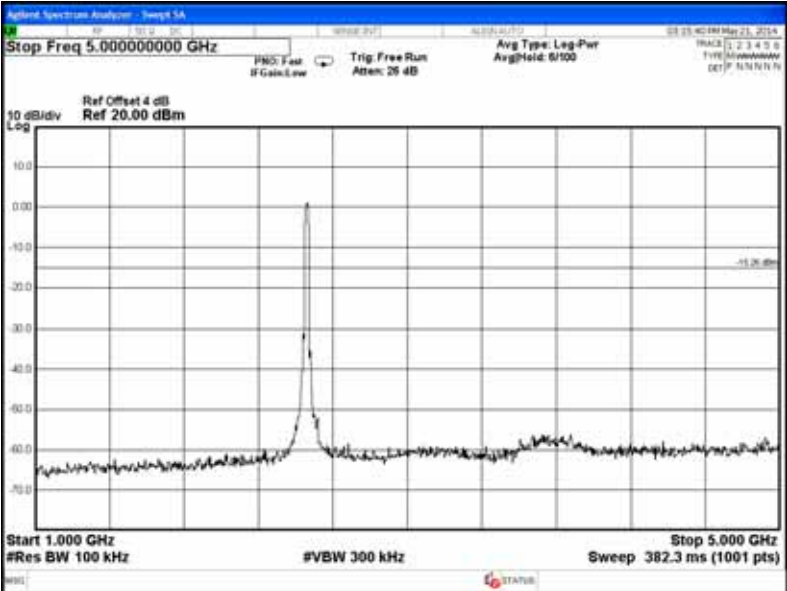
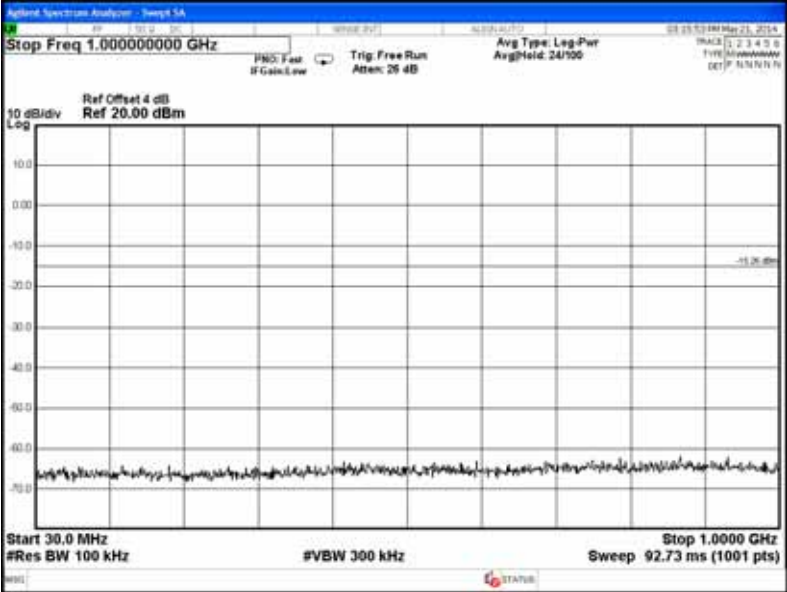

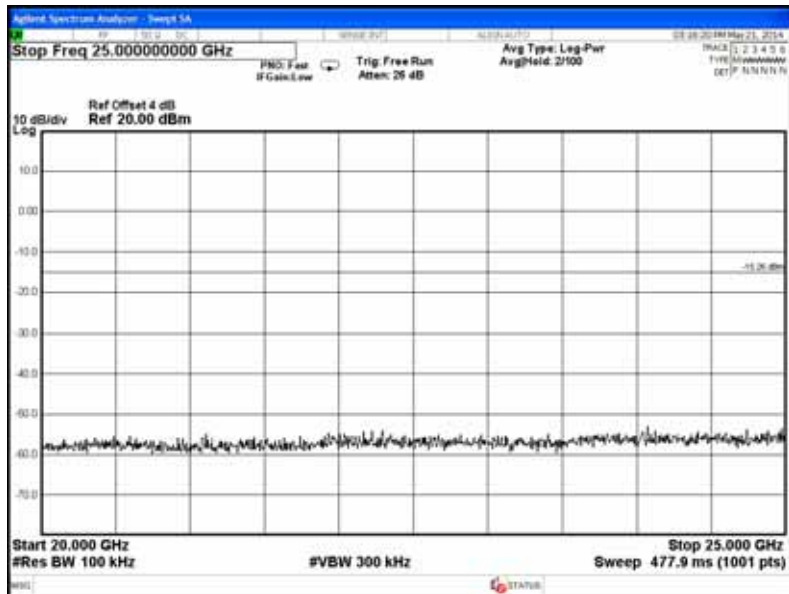
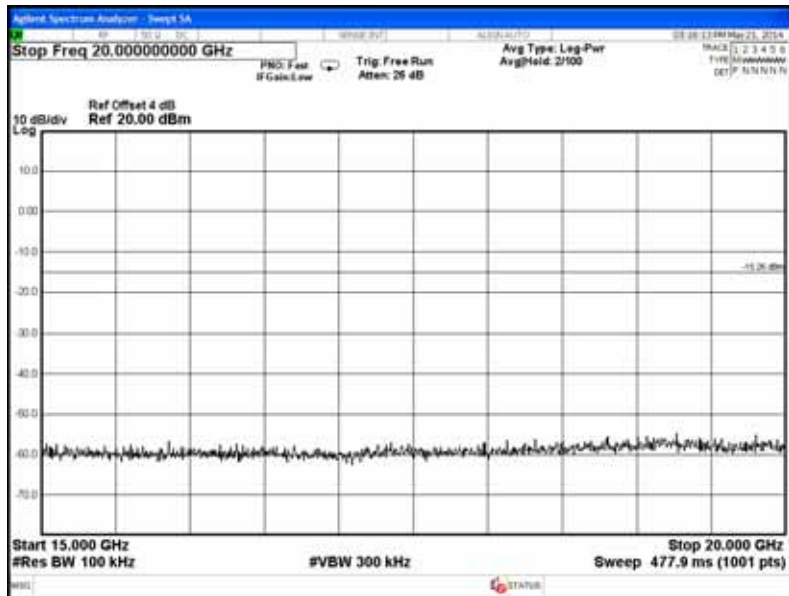
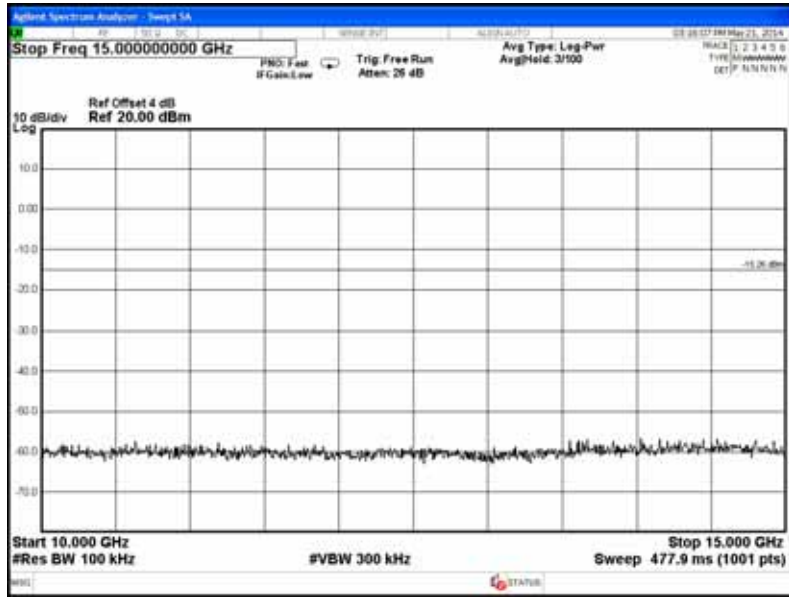

802.11n-HT20, Frequency: 2412MHz

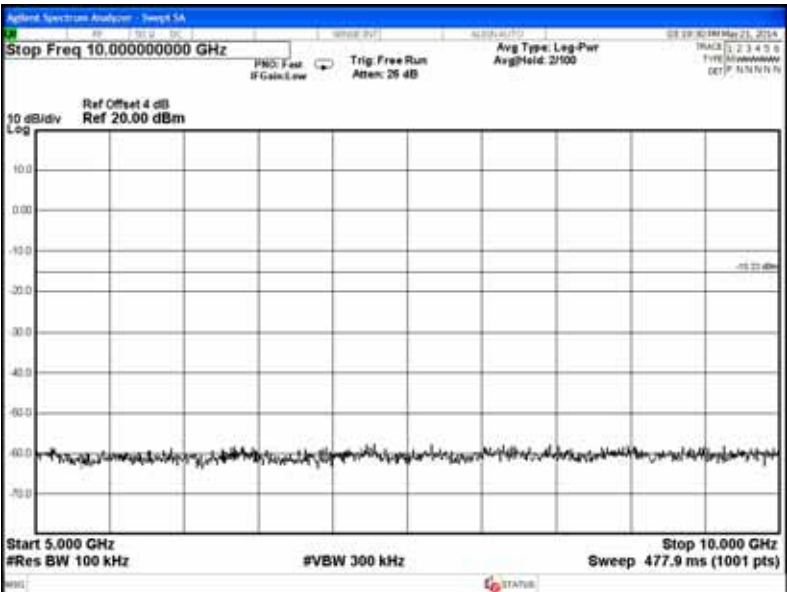
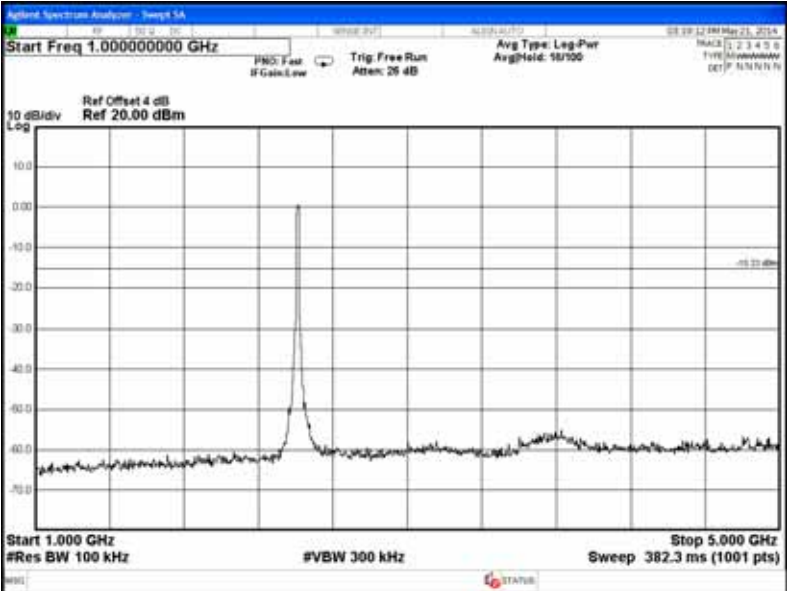
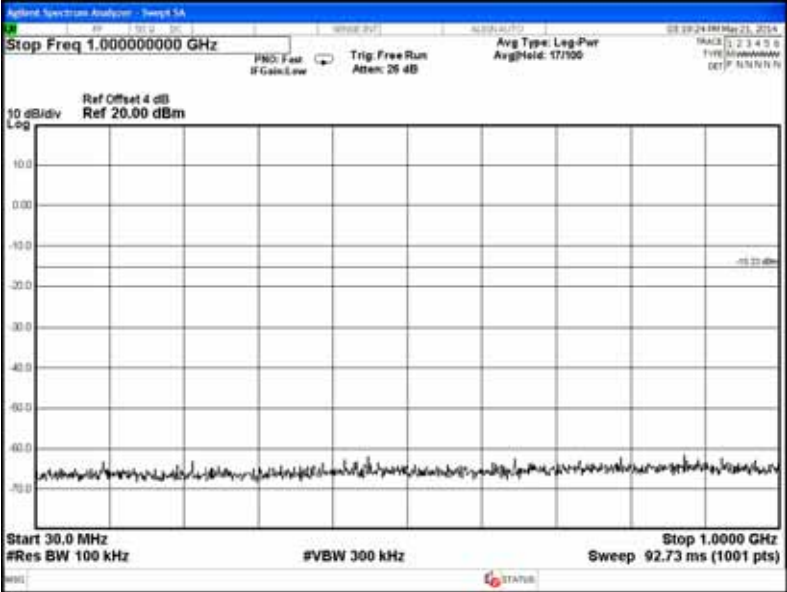

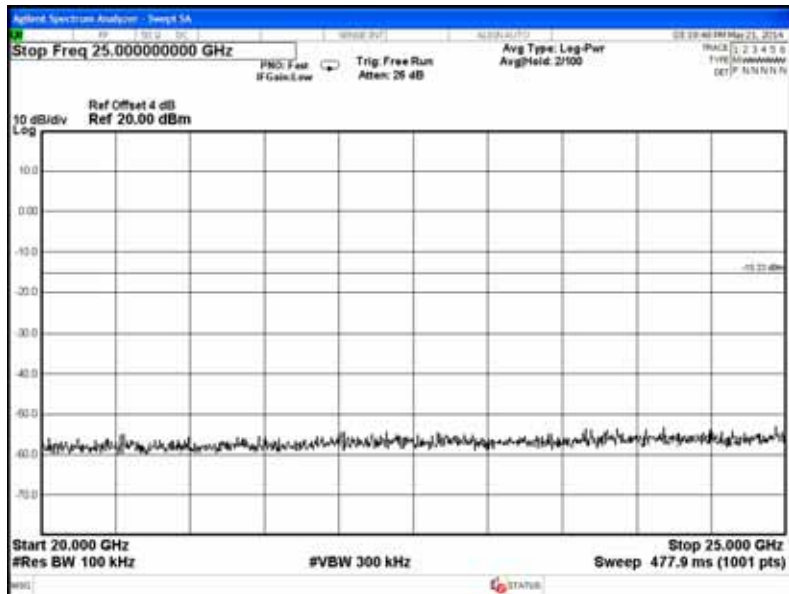
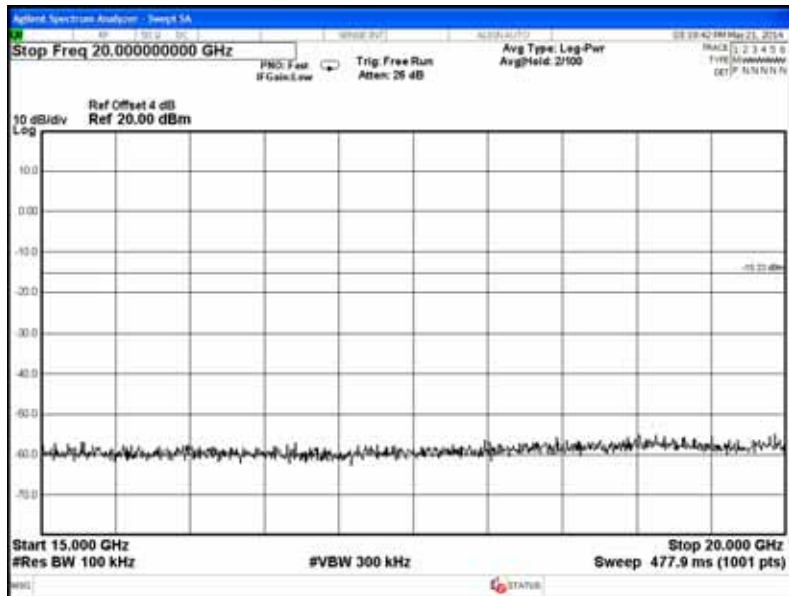
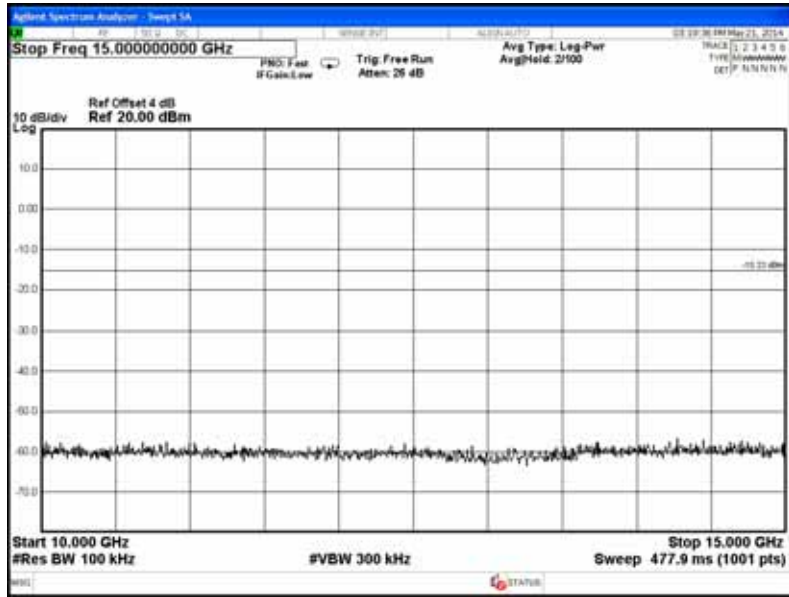

### 802.11n-HT20, Frequency: 2437MHz

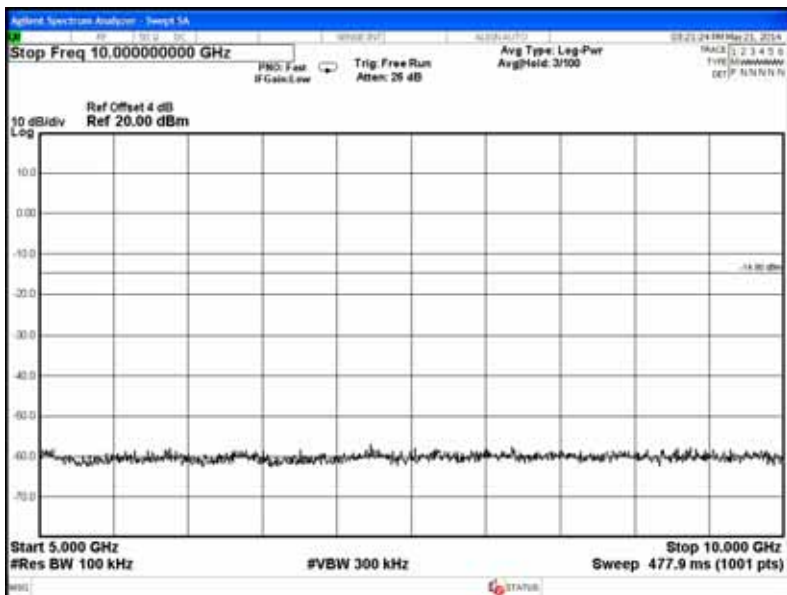
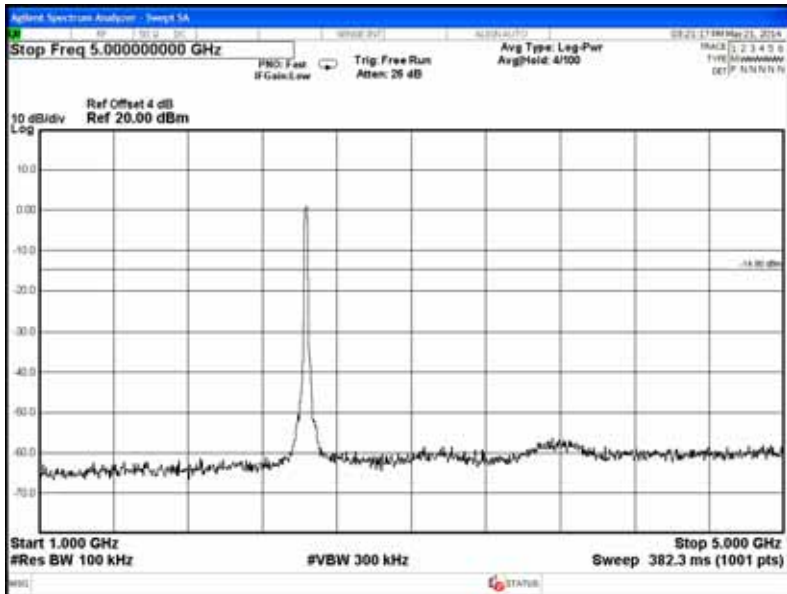
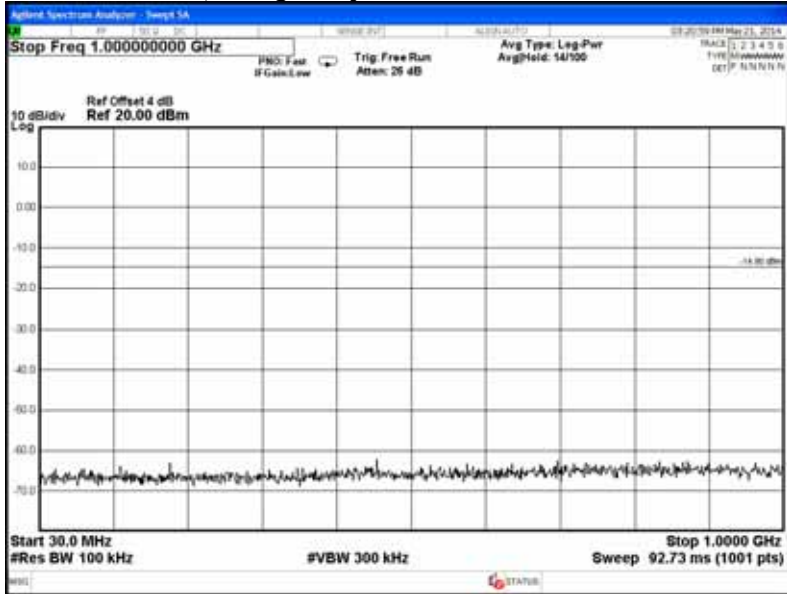

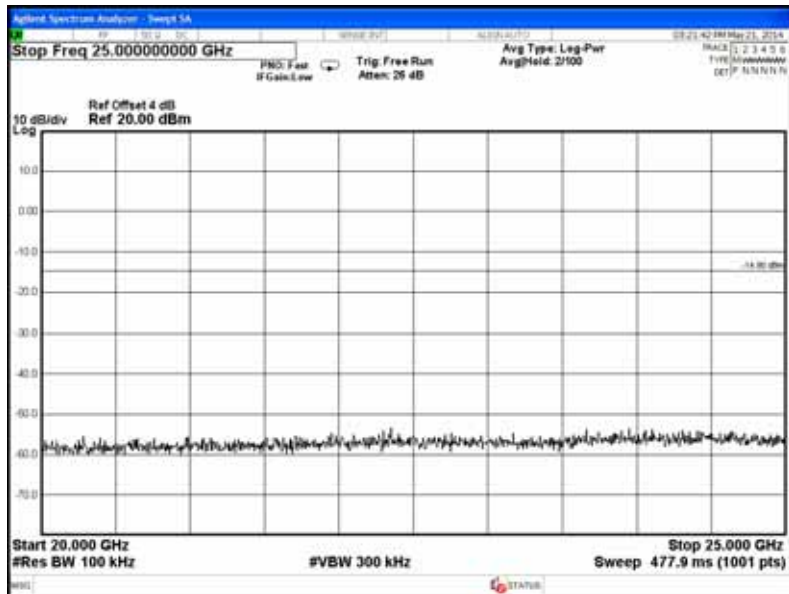
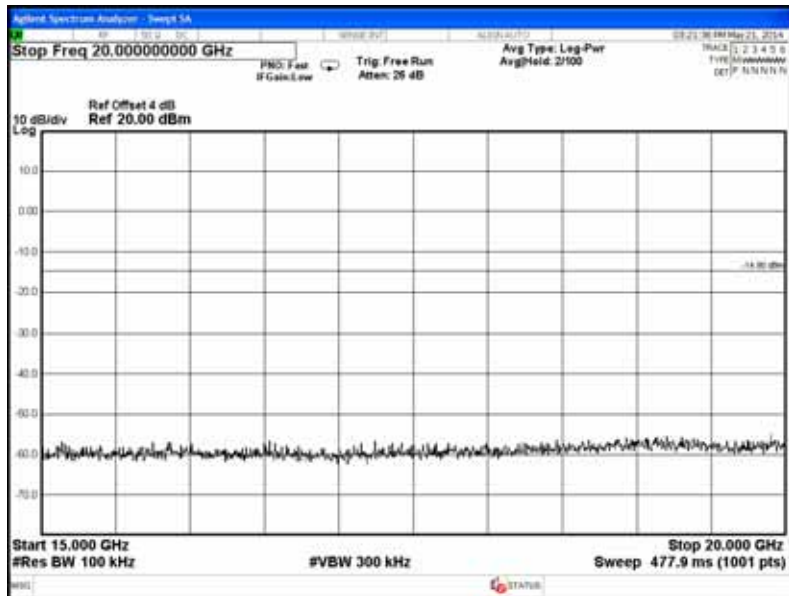
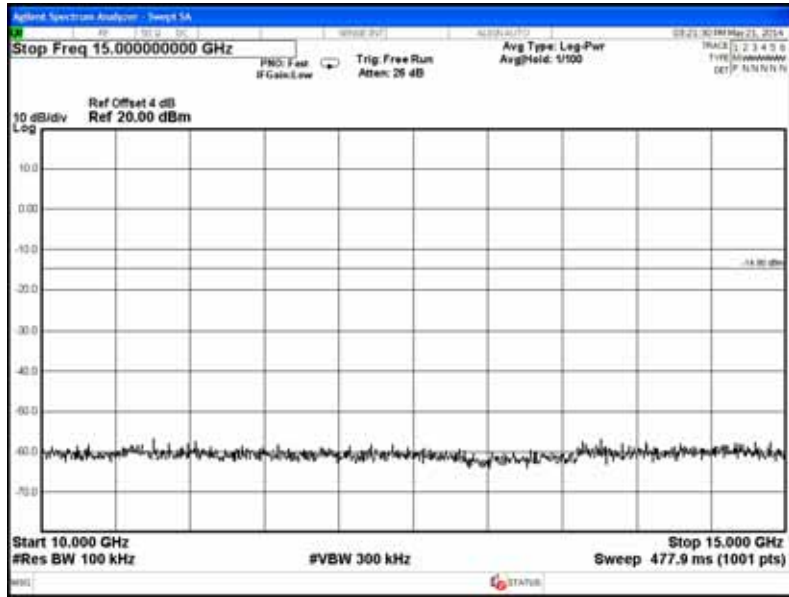



### 802.11n-HT20, Frequency: 2462MHz

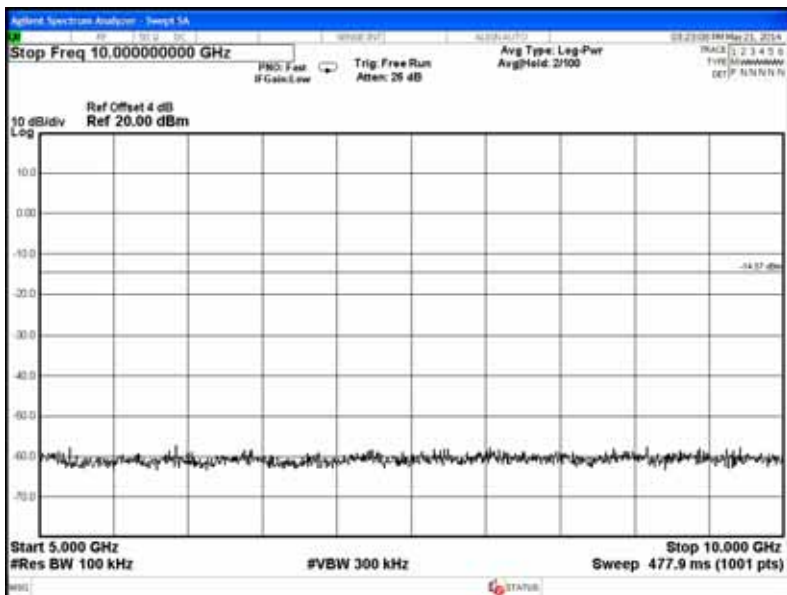
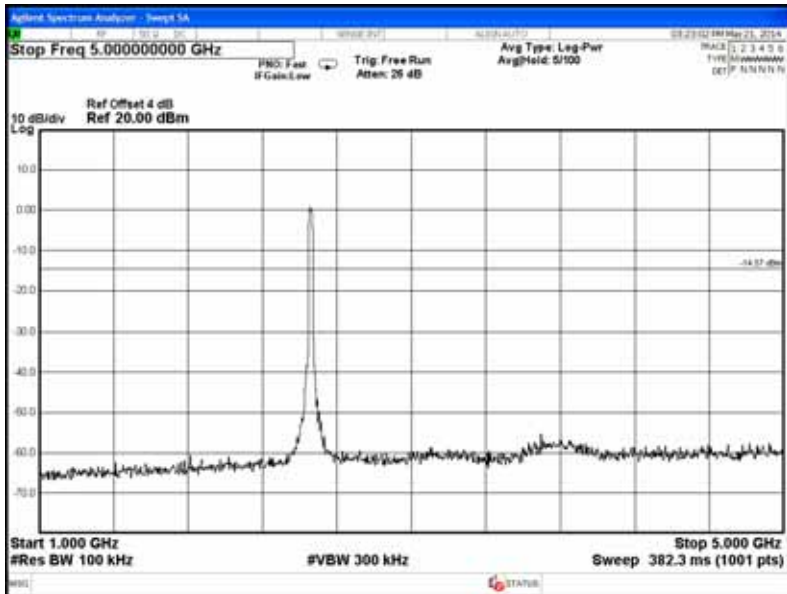
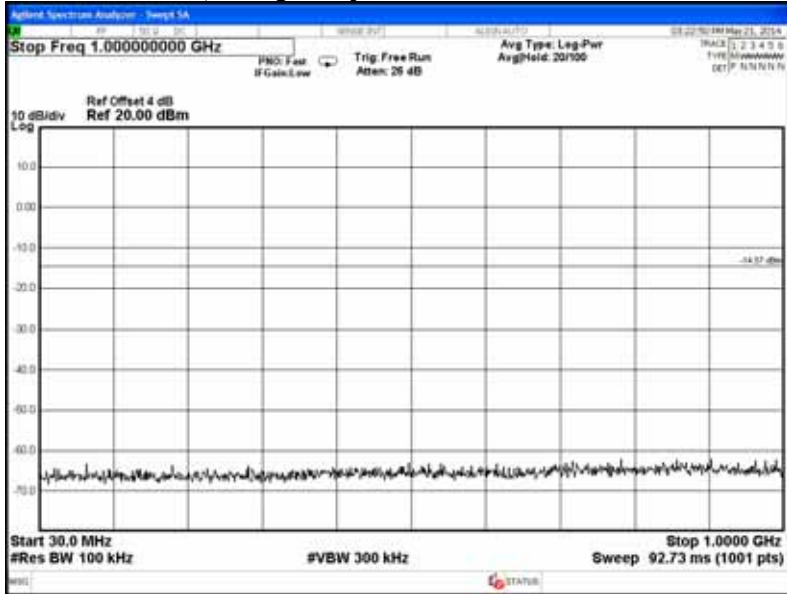

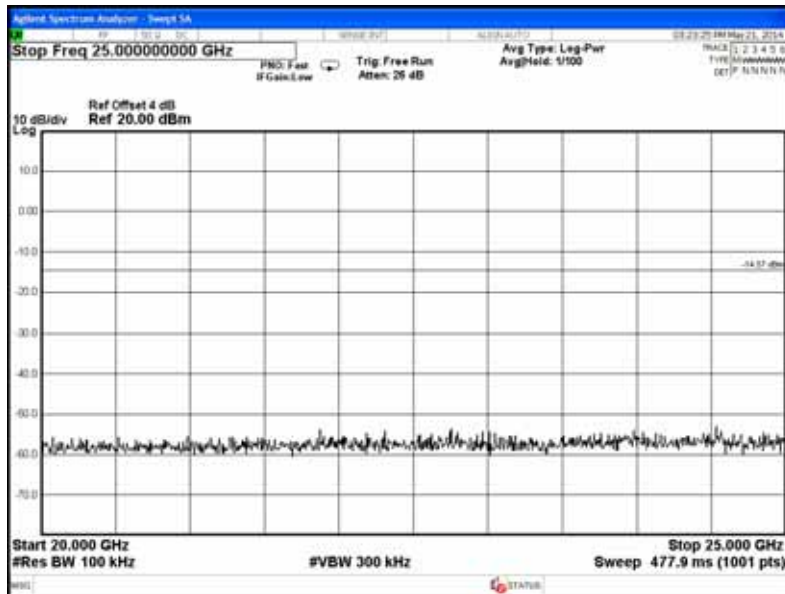
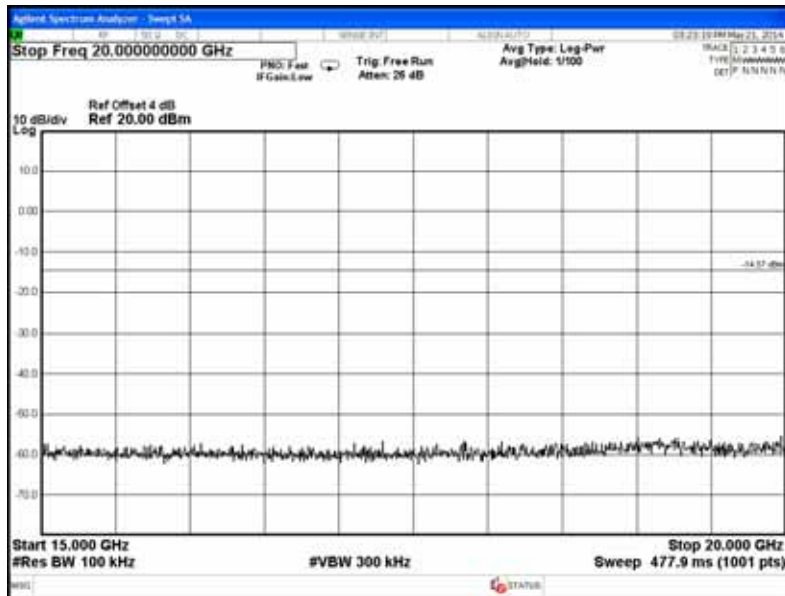
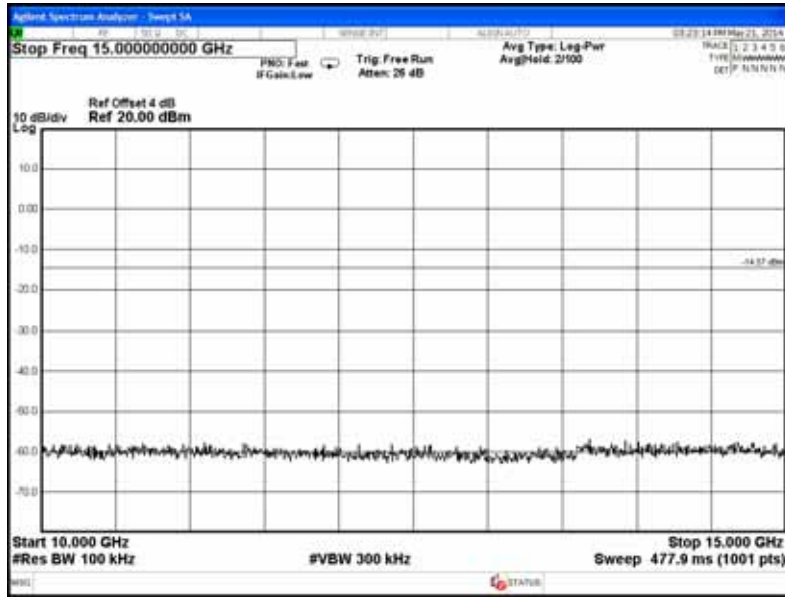

### 7.6.2. BT Function

Test Date : 2014. 05. 19    Temperature : 24    Humidity : 46%  
BLE, Frequency: 2402MHz

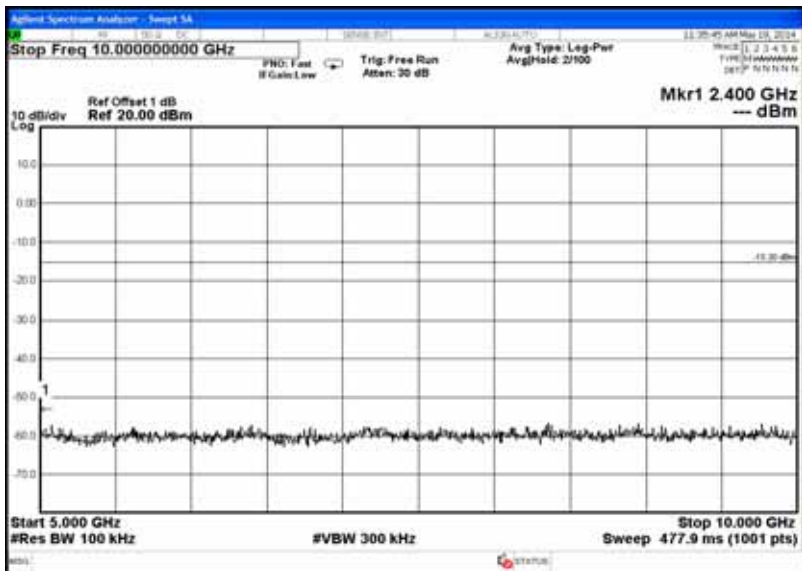
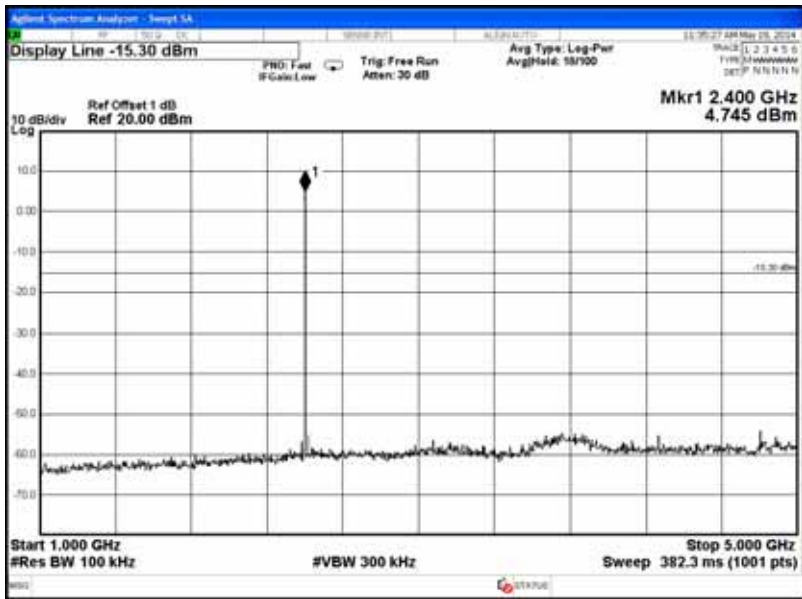
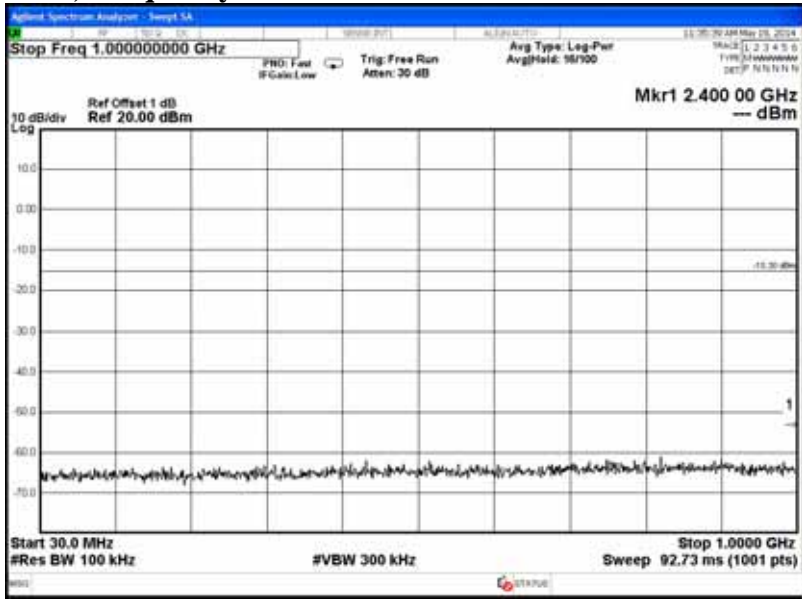

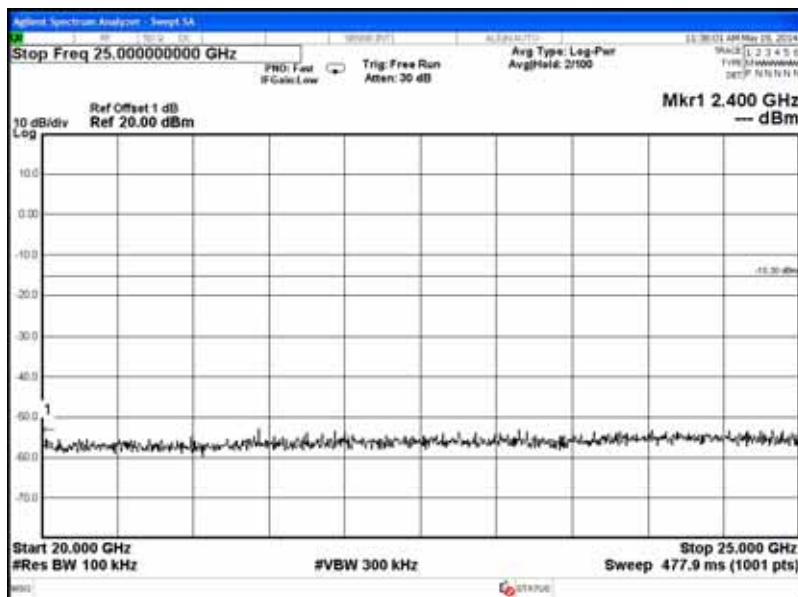
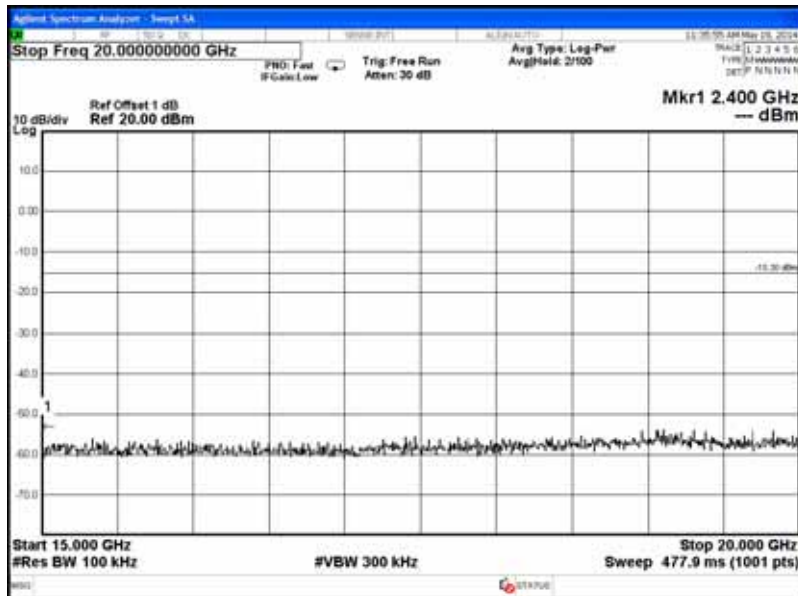
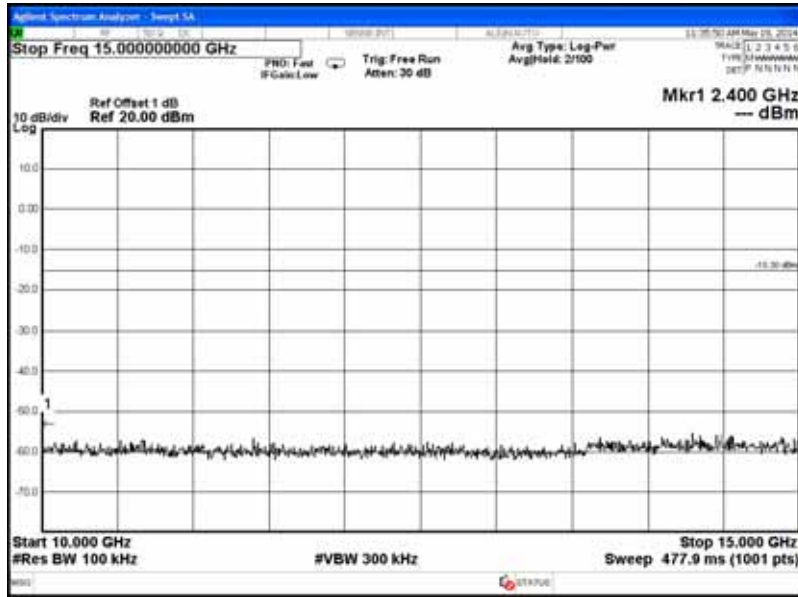

### BLE, Frequency: 2440MHz

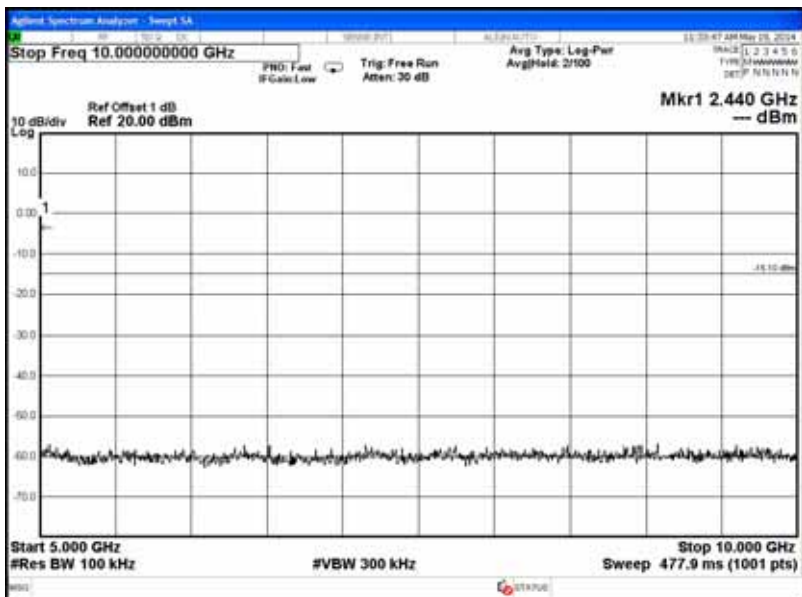
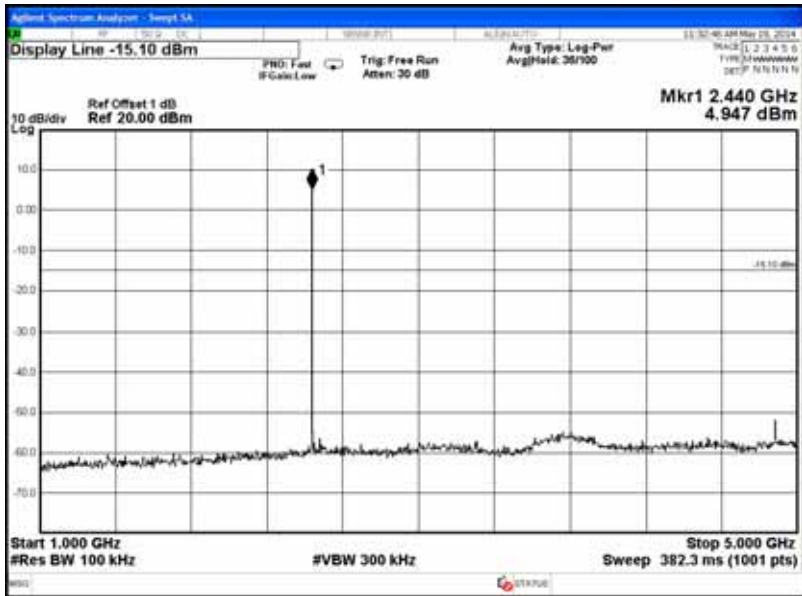
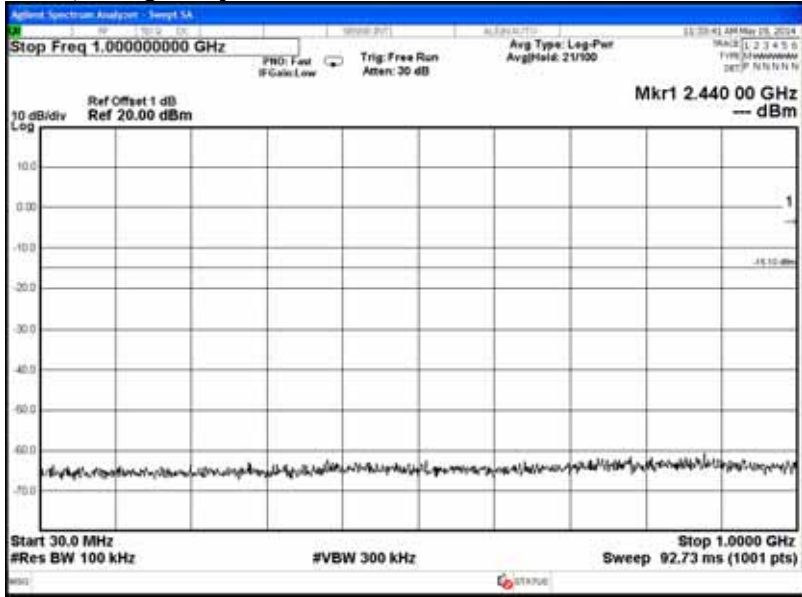

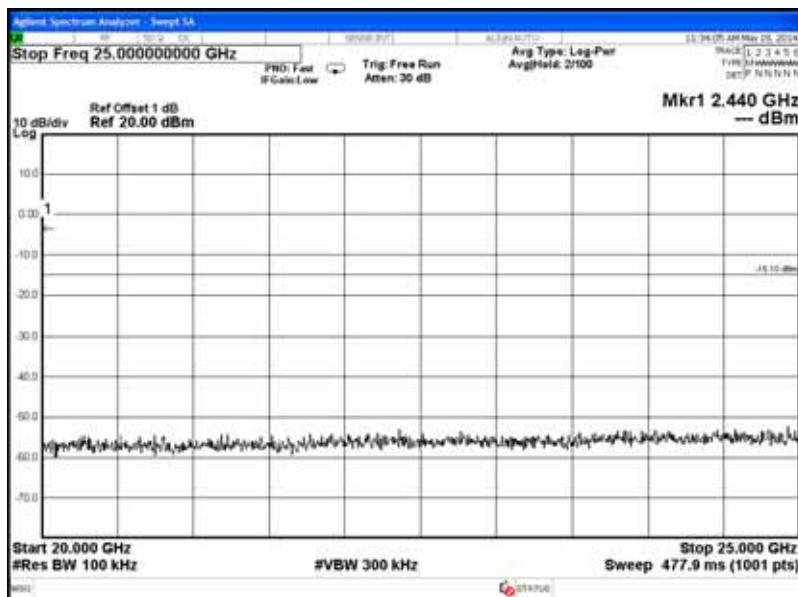
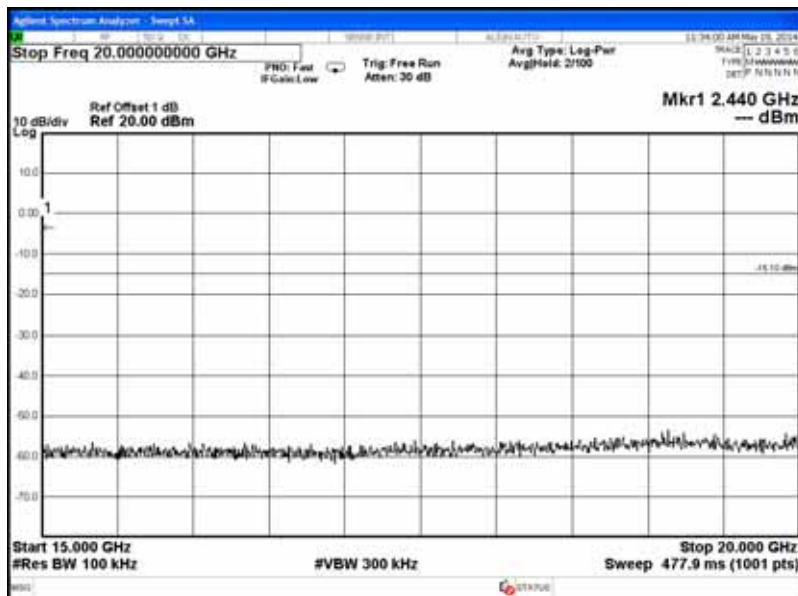
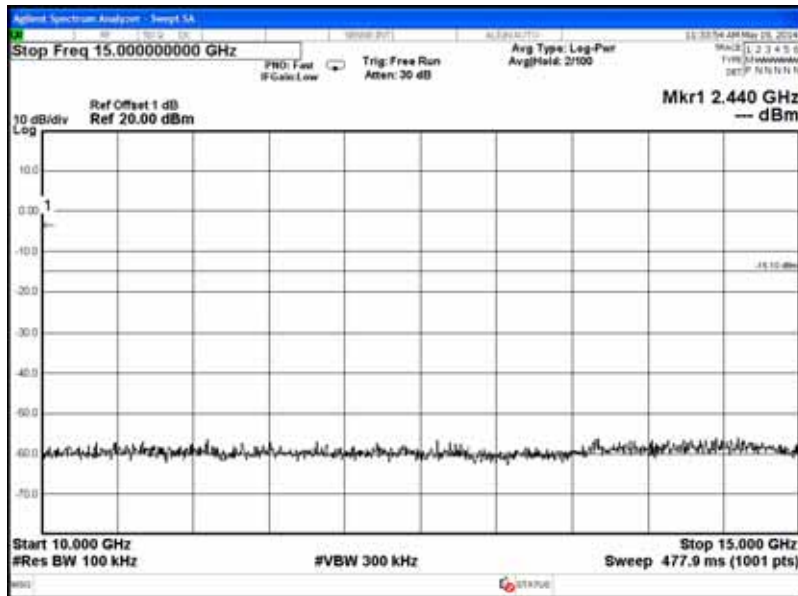

### BLE, Frequency: 2480MHz

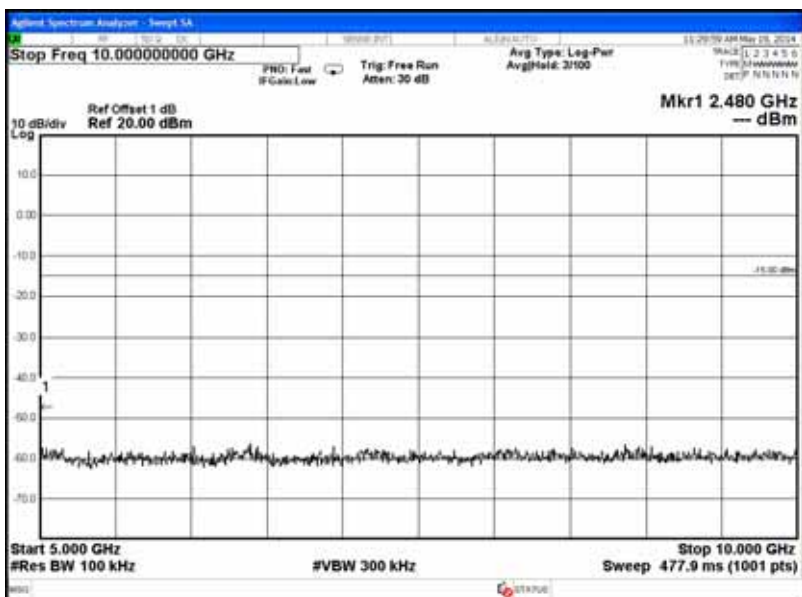
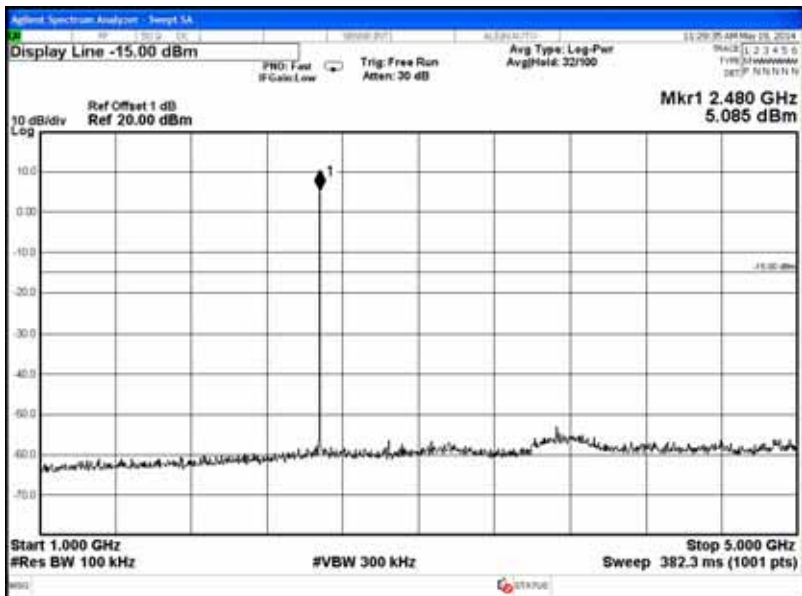
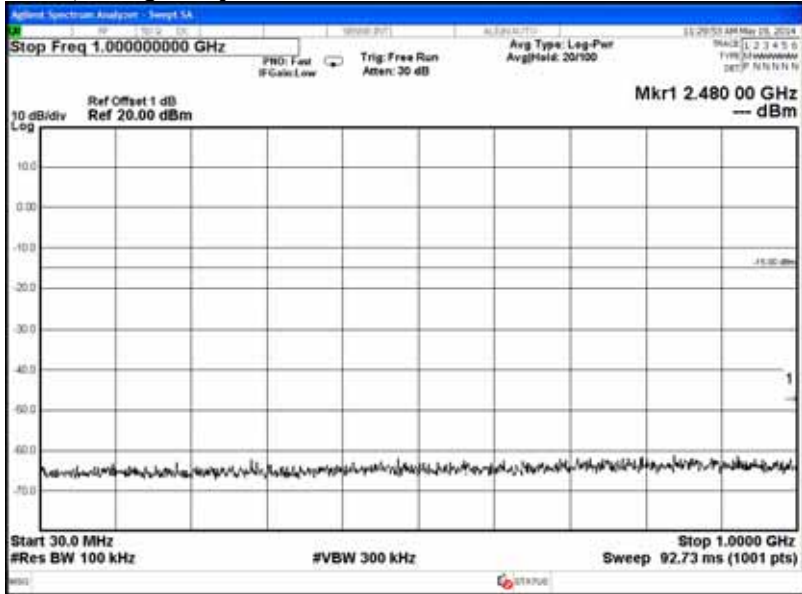

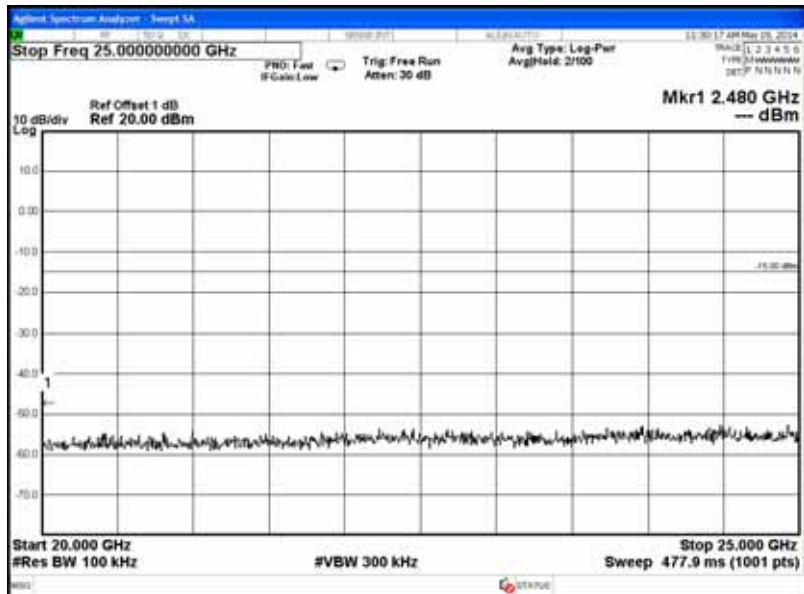
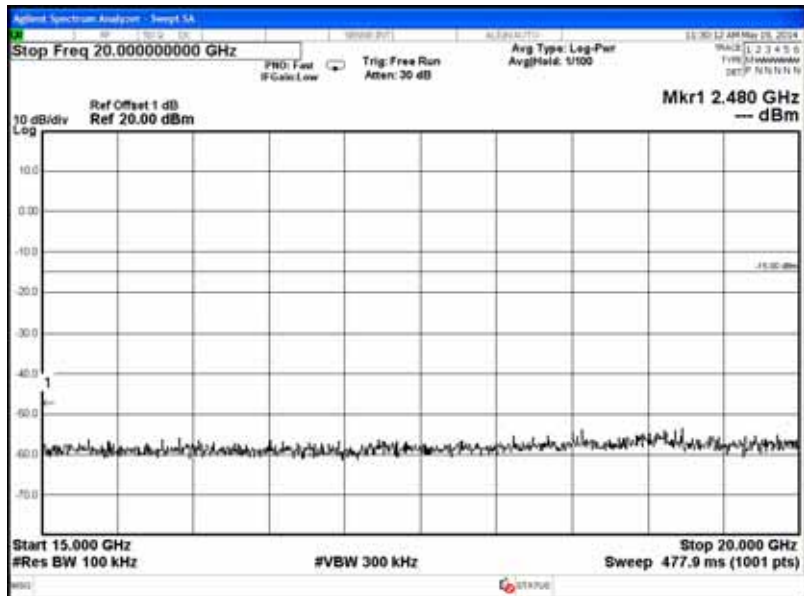
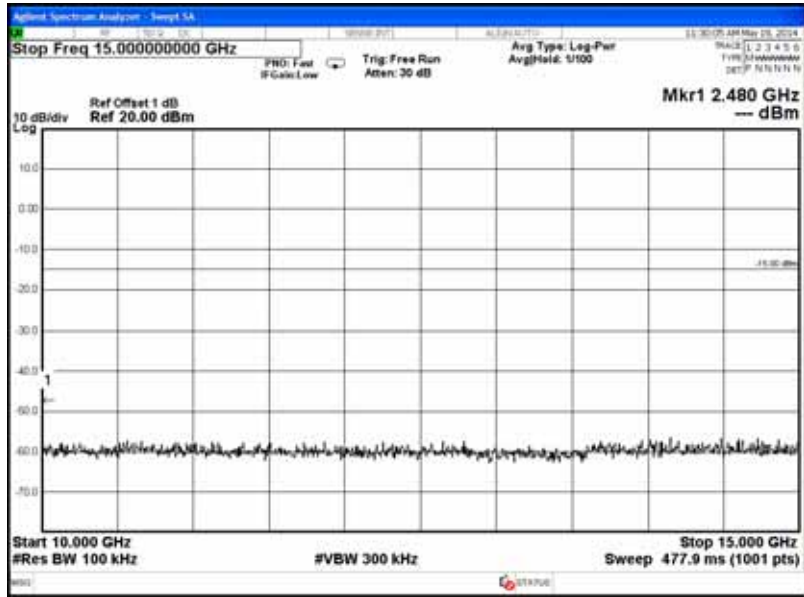



## 8. BAND EDGES MEASUREMENT

### 8.1. Test Equipment

The following test equipment was used during the band edges measurement:

Item	Type	Manufacturer	Model No.	Serial No.	Cal. Due Date
1.	Spectrum Analyzer	Agilent	N9030A-544	US51350140	2014. 07. 30

### 8.2. Block Diagram of Test Setup

The same as section.4.2.

### 8.3. Specification Limits [§15.247(c)]

The highest level should be at least 20 dB below reference level as measured in section 9.6.

### 8.4. Operating Condition of EUT

The test program “WL command” for WLAN and test program “Blue tool” for BLE was used to enable the EUT to transmit data at different channel frequency individually.

### 8.5. Test Procedure

The transmitter output was connected to the spectrum analyzer. Set both RBW=100 kHz and VBW to 300kHz with suitable frequency span including 100kHz bandwidth from band edge.

The measurement guideline was according to 558074 D01 DTS Meas Guidance v03r01.

### 8.6. Test Results

**PASSED.** All the test results are attached in next pages.

#### 8.6.1. WLAN Function

Test Date : 2014. 05. 02      Temperature : 26      Humidity : 50%

Test Date : 2014. 05. 06      Temperature : 23      Humidity : 48%

Test Date : 2014. 05. 21      Temperature : 25      Humidity : 48%

### 802.11b Below Band edge

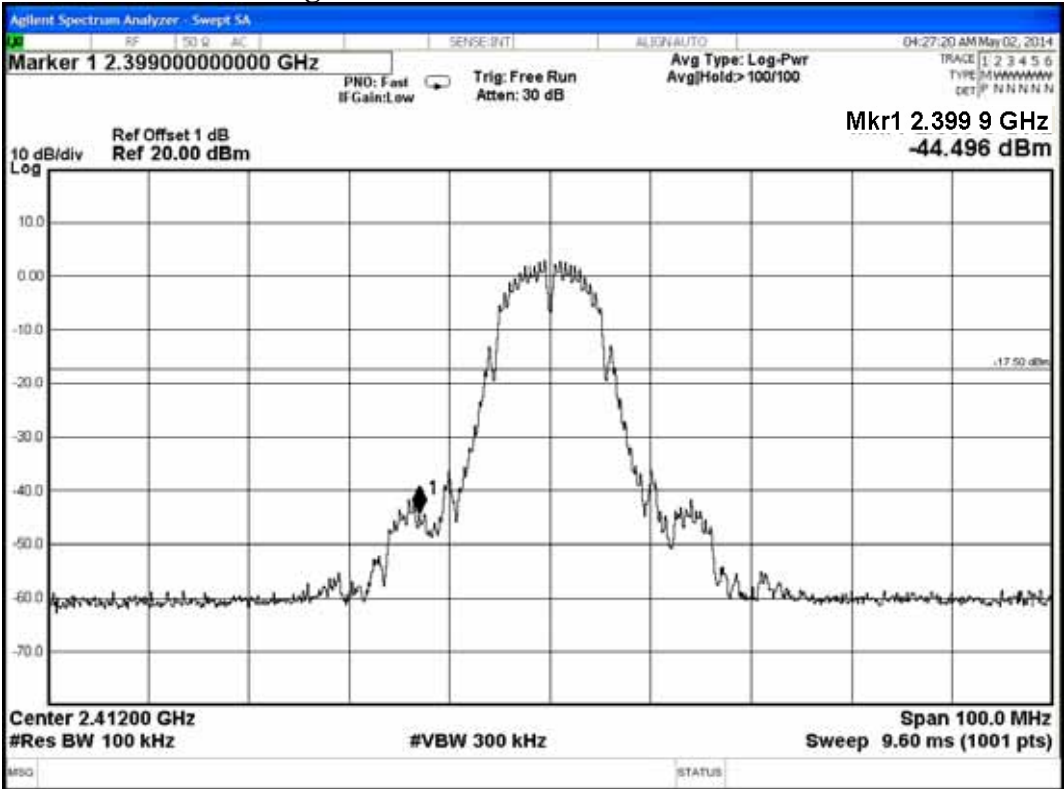

### Upper Band edge



### 802.11g Below Band edge

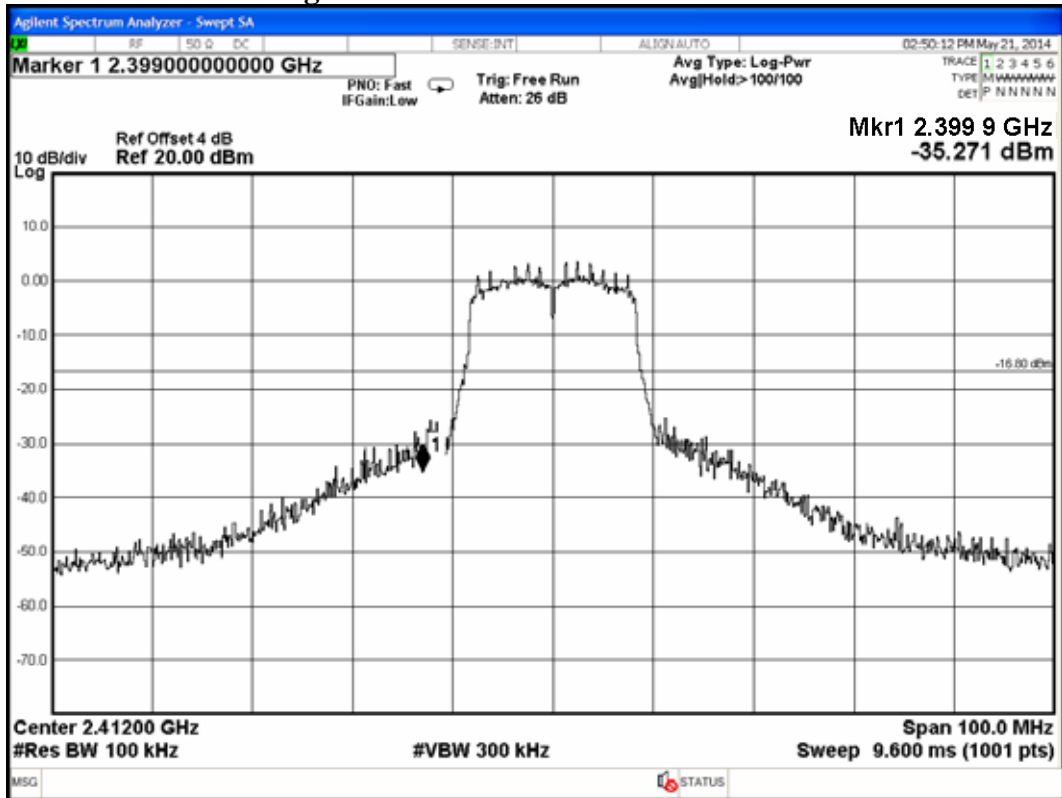

### Upper Band edge

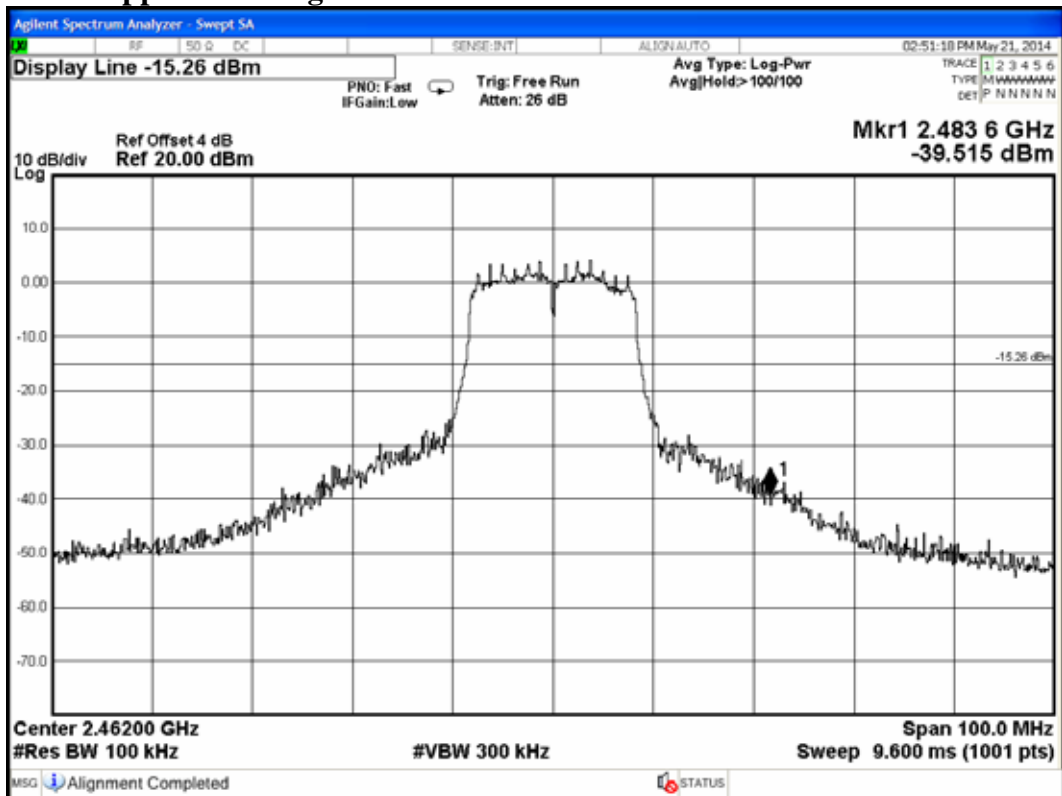

### 802.11n-HT20 Below Band edge

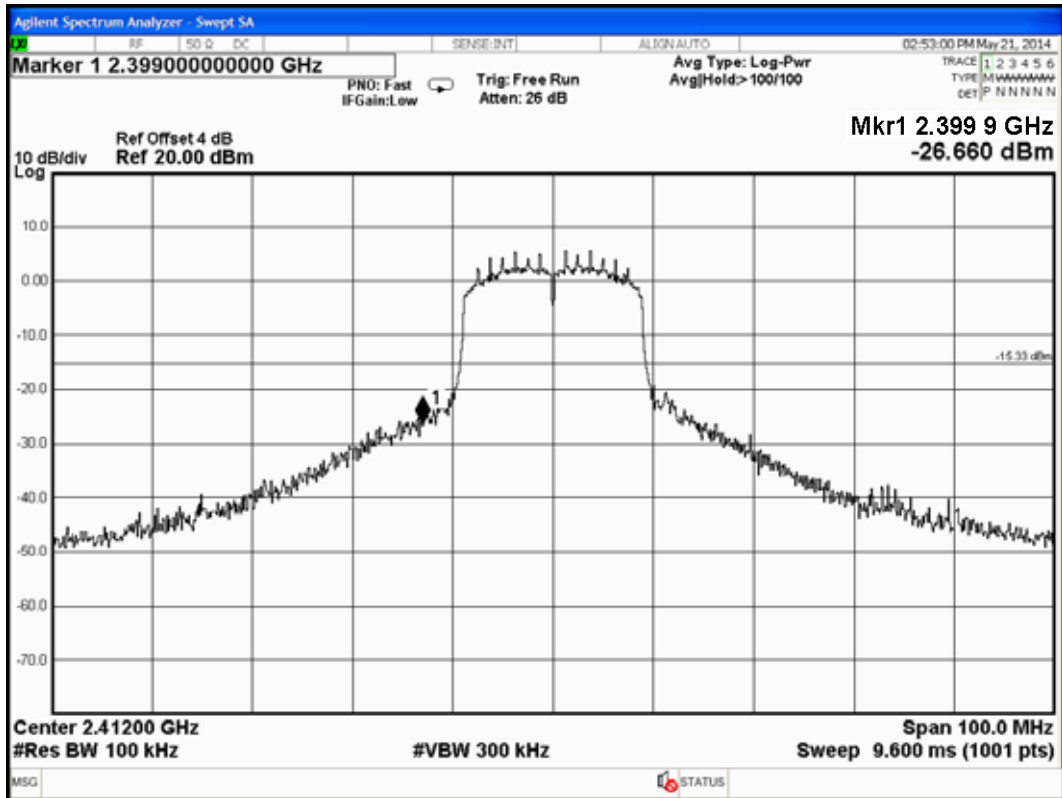

### Upper Band edge

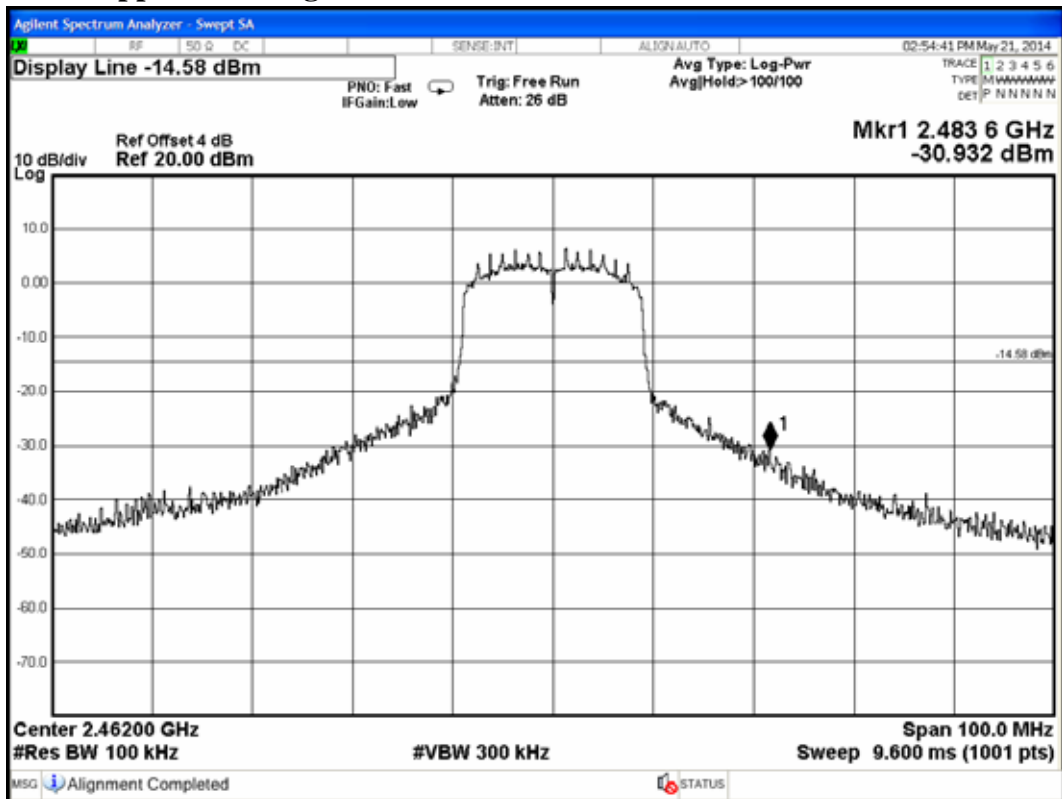

8.6.2. BLE Function

Test Date : 2014. 05. 05    Temperature : 24    Humidity : 48%

**Below Band edge**

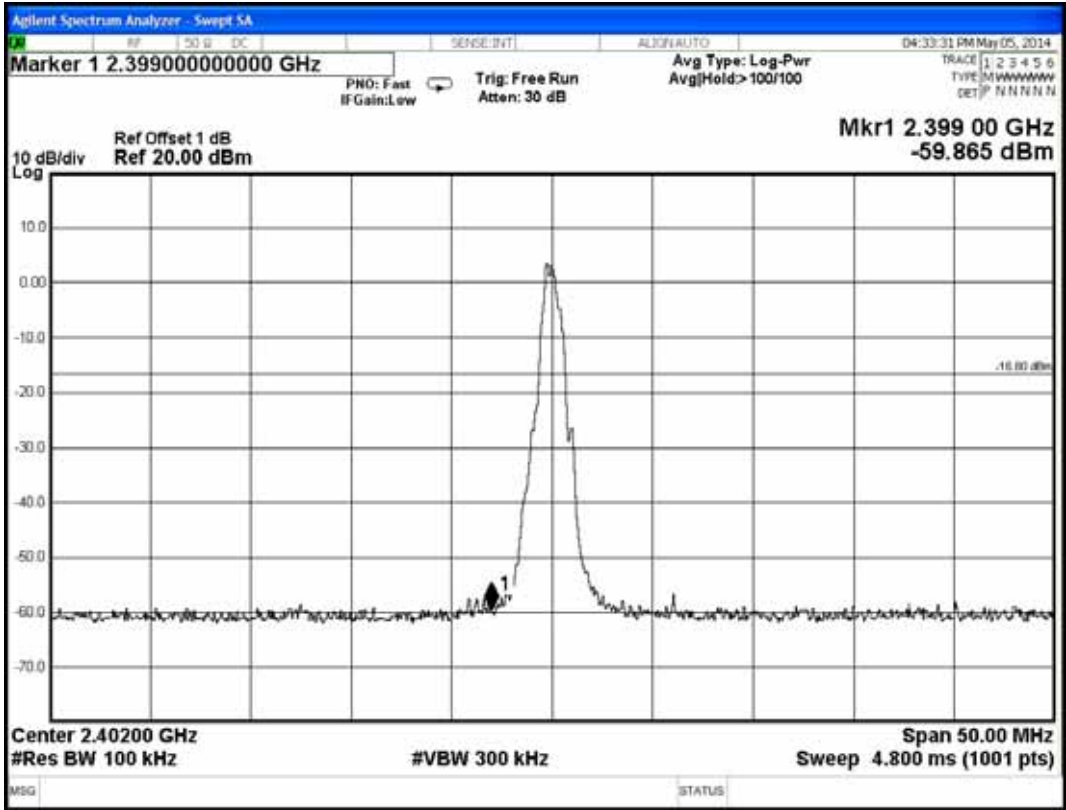

**Upper Band edge**

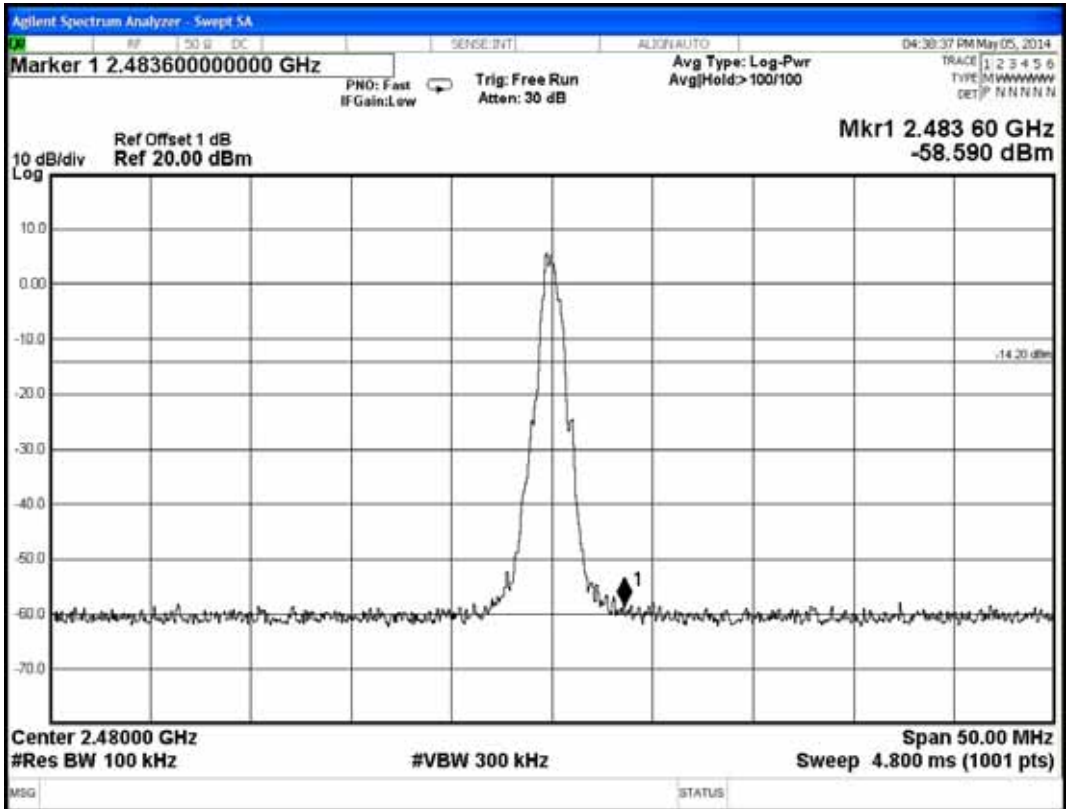

## 9. POWER SPECTRAL DENSITY MEASUREMENT

### 9.1. Test Equipment

The following test equipment was used during the power spectral density measurement:

Item	Type	Manufacturer	Model No.	Serial No.	Cal. Due Date
1.	Spectrum Analyzer	Agilent	N9030A-544	US51350140	2014. 07. 30

### 9.2. Block Diagram of Test Setup

The same as section.4.2.

### 9.3. Specification Limits [§15.247(d)]

The peak power spectral density conducted from the intentional radiator to the antenna shall not be greater than 8dBm in any 3kHz band.

### 9.4. Operating Condition of EUT

The test program “WL command” for WLAN and test program “Blue tool” for BLE was used to enable the EUT to transmit data at different channel frequency individually.

### 9.5. Test Procedure

The transmitter output was connected to the spectrum analyzer. The bandwidth of the fundamental frequency was measured with the spectrum analyzer using 100kHz RBW and  $\geq 300$ kHz VBW, set sweep time = Auto.

The measurement guideline was according to KDB 558074 D01 DTS Meas Guidance is v03r01.

Pursuant to KDB 662911, we executed conducted test for chain 0 as worse performance, and a factor  $10\log(N)$  shall be added, where N is the number of output.

9.6. Test Results

**PASSED.** All the test results are attached in next pages.

9.6.1. WLAN Function

Test Date : 2014. 05. 02    Temperature : 26    Humidity : 50%  
 Test Date : 2014. 05. 19    Temperature : 24    Humidity : 46%

Mode	Type of Network	Channel	Frequency	Power Spectral Density (dBm)	Antenna Factor	Test Result (dBm) <sub>Note</sub>
1.	802.11b	CH 1	2412MHz	6.986	0	<b>6.986</b>
2.		CH 6	2437MHz	7.343		<b>7.343</b>
3.		CH 11	2462MHz	7.259		<b>7.259</b>
4.	802.11g	CH 1	2412MHz	0.204	3	<b>3.204</b>
5.		CH 6	2437MHz	2.731		<b>6.731</b>
6.		CH 11	2462MHz	1.743		<b>4.743</b>
7.	802.11n-HT20	CH 1	2412MHz	1.670	3	<b>4.670</b>
8.		CH 6	2437MHz	2.099		<b>5.099</b>
9.		CH 11	2462MHz	2.423		<b>5.423</b>

[Limit: 8dBm]

- Note: 1. 802.11b antenna factor doesn't support simultaneously transmit, thus MIMO factor is unnecessary.
- 2. Test Result=Power Spectral Density+Factor (Factor=10log(N), N=MIMO number)

**802.11b, Frequency: 2412MHz**



### 802.11b, Frequency: 2437MHz

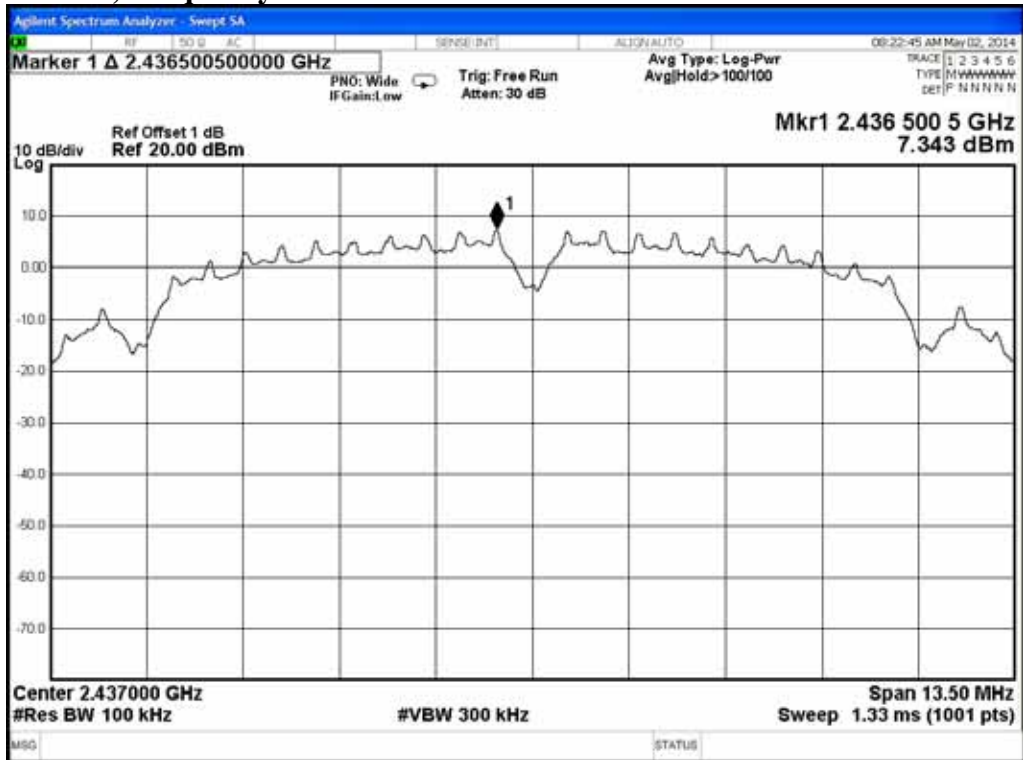

### 802.11b, Frequency: 2462MHz

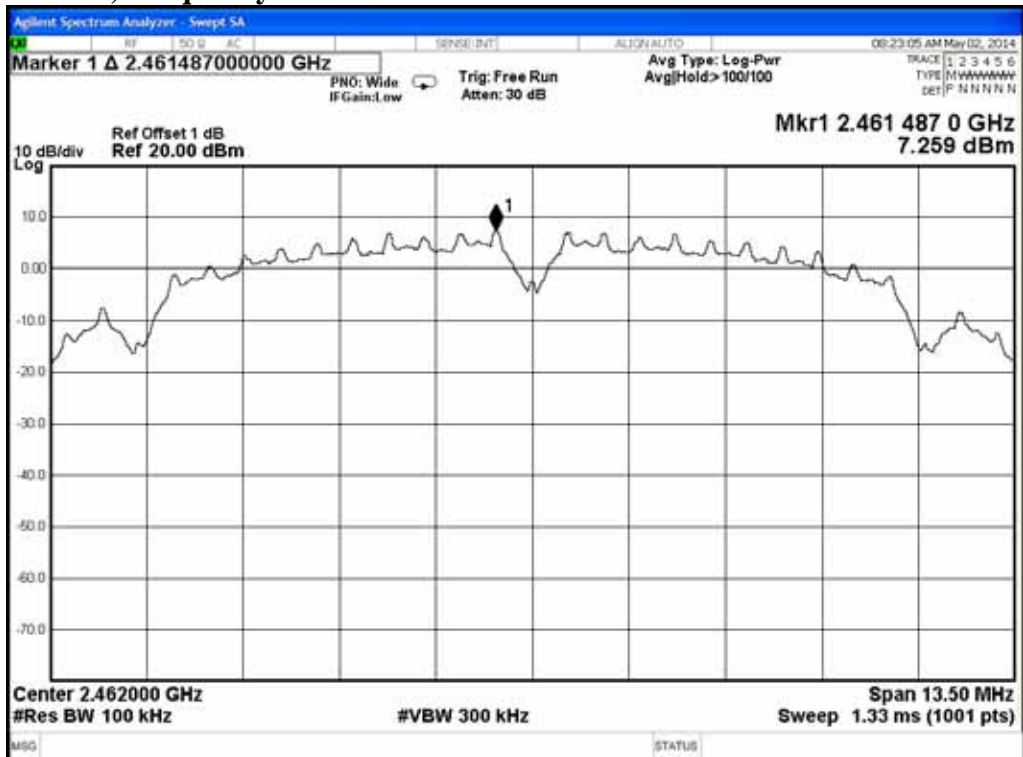



### 802.11g, Frequency: 2412MHz

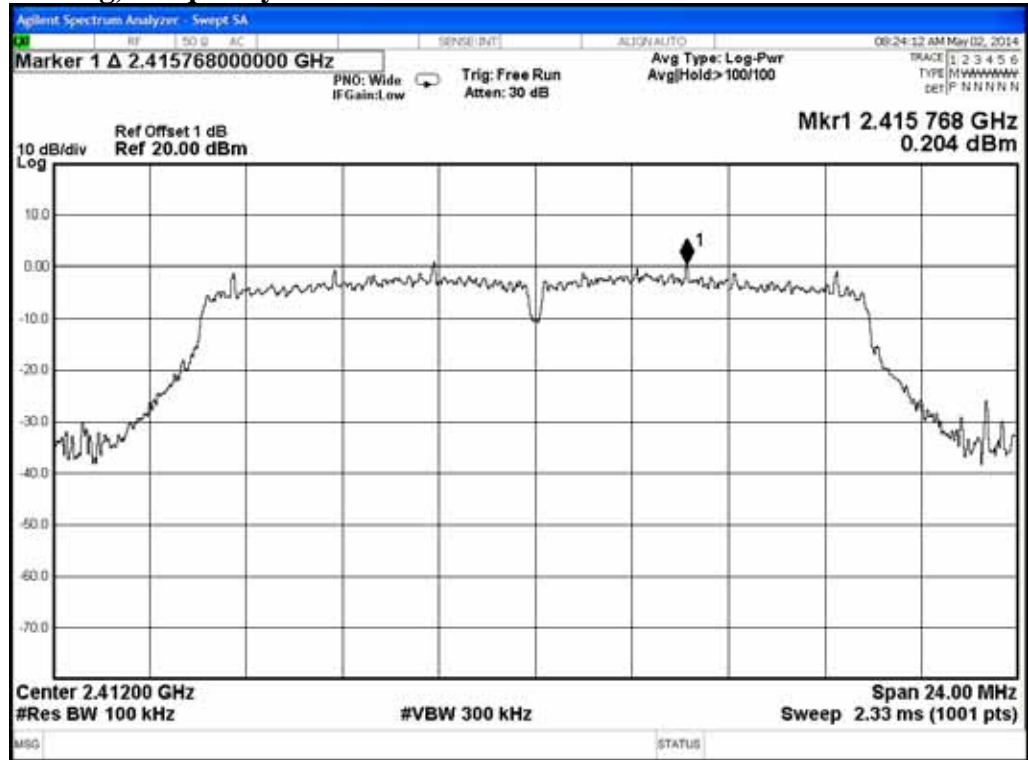

### 802.11g, Frequency: 2437MHz

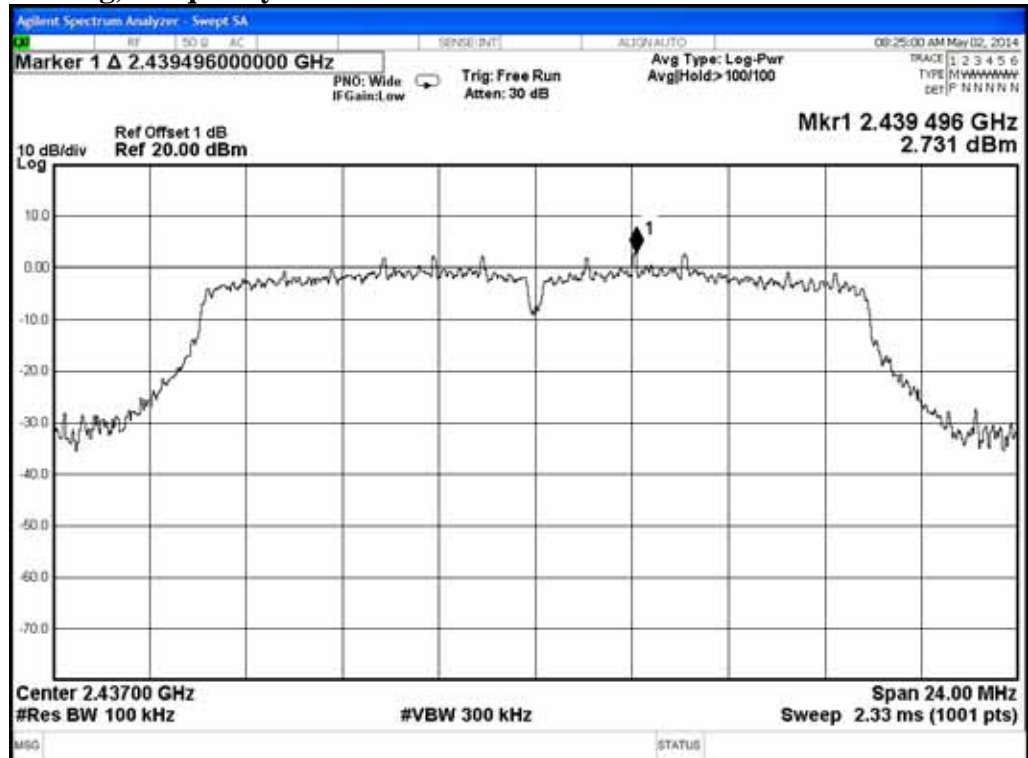

### 802.11g, Frequency: 2462MHz

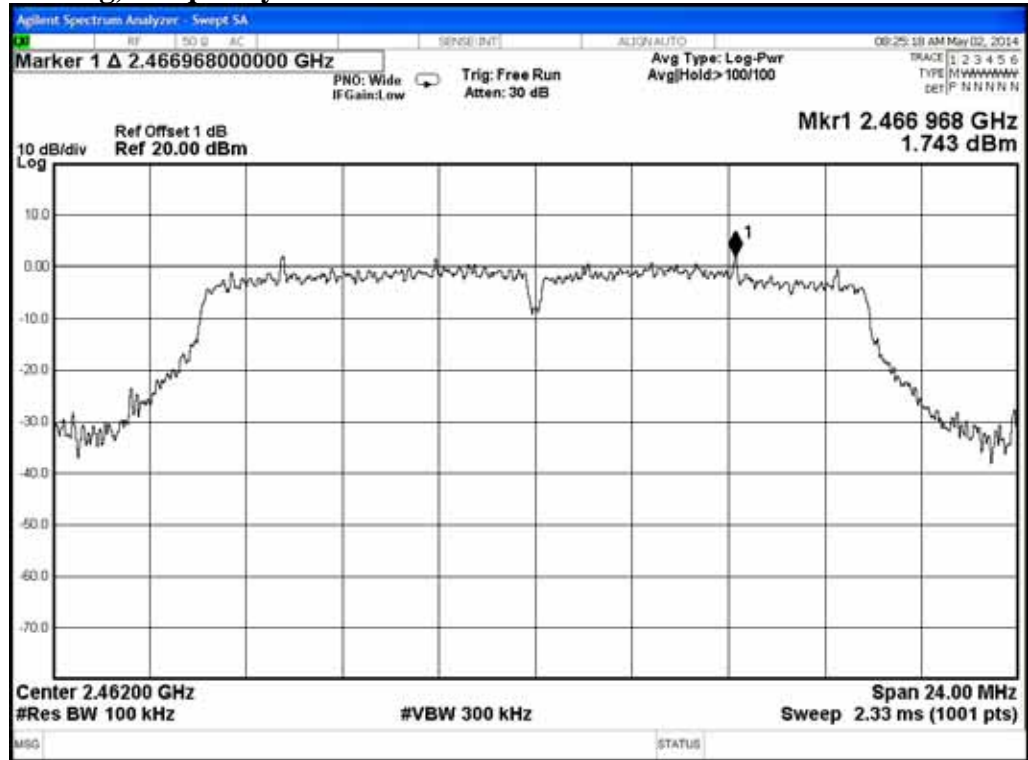

### 802.11n-HT20, Frequency: 2412MHz



### 802.11n-HT20, Frequency: 2437MHz



### 802.11n-HT20, Frequency: 2462MHz

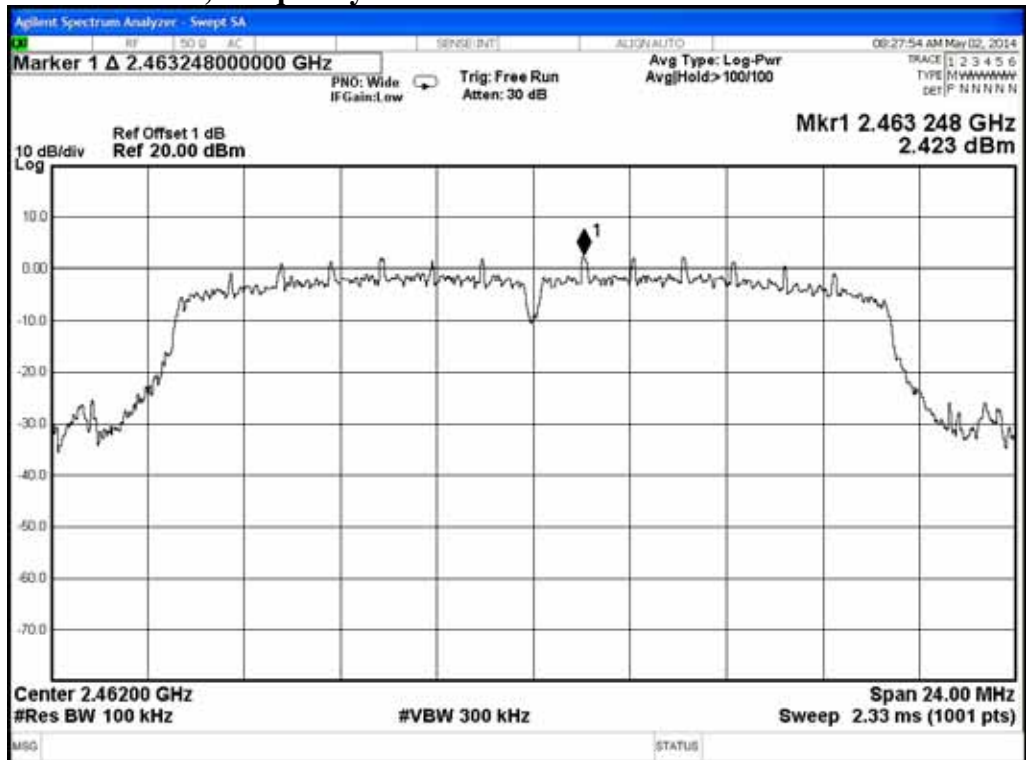

9.6.2. BT Function

Test Date : 2014. 05. 05    Temperature : 24    Humidity : 48%

Mode	Channel	Frequency	Power Spectral Density (dBm)
1.	CH 0	2402MHz	3.788
2.	CH 19	2440MHz	4.888
3.	CH 39	2480MHz	5.538

[Limit: 8dBm]

**BLE, Frequency: 2402MHz**

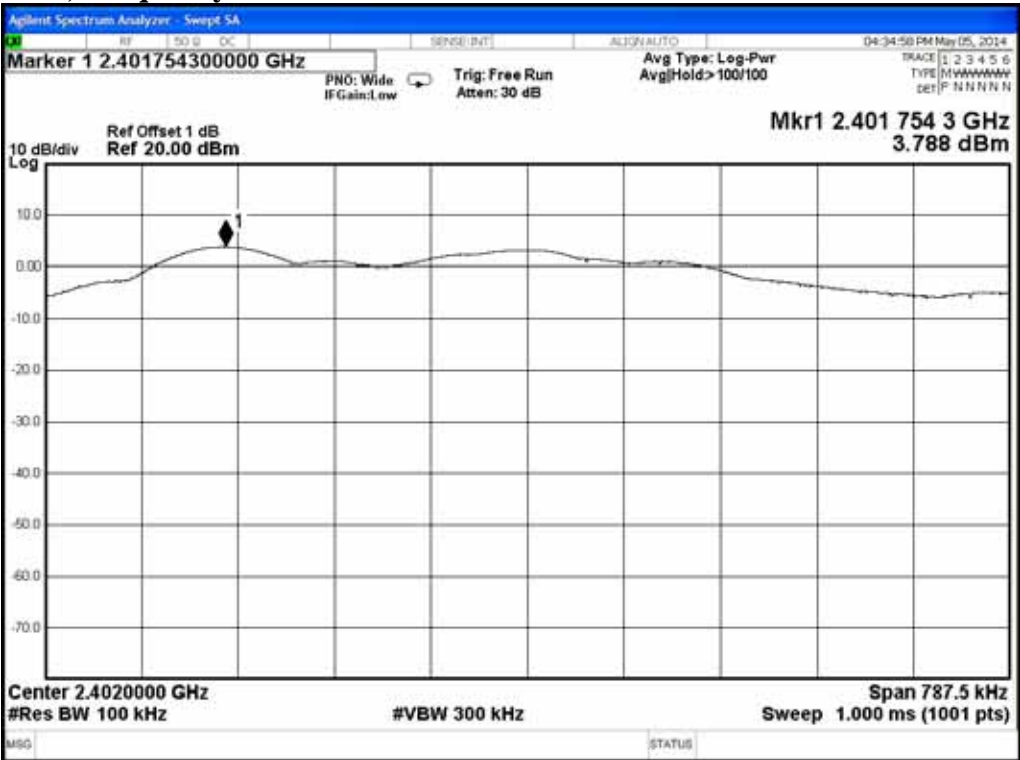

### BLE, Frequency: 2440MHz



### BLE, Frequency: 2480MHz



## **10.DEVIATION TO TEST SPECIFICATIONS**

**【NONE】**