



A Test Lab Techno Corp.

Changan Lab : No. 140 -1, Changan Street, Bade City, Taoyuan County, Taiwan R.O.C.
Tel : 886-3-271-0188 / Fax : 886-3-271-0190

P22 & P24 Test Report



Test Report No.	: 0905FR15-03
Applicant	: Elitegroup Computer Systems Co., LTD.
Manufacturer	: Elitegroup Computer Systems Co., LTD.
Model Name	: HSDPA mini-PCIe Modem Module
Trade Mark	:  ELITEGROUP
Model Number	: M320
Family Model Number	: M320A/M320B
FCC ID	: WL6M320
Dates of Test	: May 21 ~ Jun. 25, 2009
Test Specification	: 47 CFR Part 22H & 24E and Part 2 ANSI/TIA-603-C-2004 FCC KDB 941225 D01 SAR for 3G devices v02
Location of Test Lab.	: Chang-an Lab.

1. The test operations have to be performed with cautious behavior, the test results are as attached.
2. The test results are under chamber environment of A Test Lab Techno Corp. A Test Lab Techno Corp. does not assume responsibility for any conclusions and generalizations drawn from the test results with regard to other specimens or samples.
3. The measurement report has to be written approval of A Test Lab Techno Corp. It may only be reproduced or published in full. This report shall not be reproduced except in full, without the written approval of A Test Lab Techno Corp.
4. This document may be altered or revised by A Test Lab Techno. Corp. personnel only, and shall be noted in the revision section of the document

Kevin Wang 20090626
Approve Signer

John Cheng 20090626
Testing Engineer



Contents

1. General Information	3
2. Test Configuration of Equipment under Test	5
2.1 Test Manner	5
2.2 Test Mode	5
2.3 Connection Diagram of Test System	8
2.4 Ancillary Equipment List	8
3. General Information of Test Site	9
3.1 Test Voltage	9
3.2 Test in Compliance with	9
3.3 Frequency Range Investigated	9
3.4 Test Distance	9
4. Test Data and Test Result	10
4.1 List of Measurements and Examinations	10
4.2 RF Output Power	11
4.3 ERP / EIRP Measurement	14
4.4 Occupied Bandwidth and Band Edge Measurement	21
4.5 Conducted Emission	54
4.6 Field Strength of Spurious Radiation	114
4.7 Frequency Stability (Temperature Variation)	140
4.8 Frequency Stability (Voltage Variation)	143
4.9 AC Power Conducted Emissions Requirements	145
5. List of Measurement Equipments	147
6. Uncertainty Evaluation	148



1. General Information

Applicant :

Elitegroup Computer Systems Co., LTD.
No. 239, Sec. 2, Ti Ding Blvd., Taipei, Taiwan

Manufacturer	:	Elitegroup Computer Systems Co., LTD. No. 239, Sec. 2, Ti Ding Blvd., Taipei, Taiwan		
Product Name	:	HSDPA mini-PCle Modem Module		
Trade Mark	:	ECS ELITEGROUP		
Model Number	:	M320		
Family Model Number	:	M320A/M320B		
FCC ID	:	WL6M320		
IMEI No	:	353936030000046 --M320 356215030000016 --M320A		
Hardware Version	:	M320-FTA-- for M320 M320A-FTA--for M320A M320B-FTA--for M320B		
Software Version	:	M320-01.08.03		
Antenna Type	:	External		
Antenna Gain	:	1.78 dBi(GSM/GPRS/EDGE 850) 1.92 dBi(GSM/GPRS/EDGE 1900) 1.78 dBi(WCDMA Band V) 1.92 dBi(WCDMA Band II)		
TX Frequency	:	824.2 - 848.8	MHz	(GSM/GPRS/EDGE 850)
		1850.2 - 1909.8	MHz	(GSM/GPRS/EDGE 1900)
		826.4 - 846.4	MHz	(WCDMA/HSDPA Band V)
		1852.4 - 1907.6	MHz	(WCDMA/HSDPA Band II)
RX Frequency	:	869.2 - 893.8	MHz	(GSM/GPRS/EDGE 850)
		1930.2 - 1989.8	MHz	(GSM/GPRS/EDGE 1900)
		871.4 - 891.6	MHz	(WCDMA/HSDPA Band V)
		1932.4 - 1987.6	MHz	(WCDMA/HSDPA Band II)



Maximum Output Power to Antenna (Conducted)	: 31.40 dBm (GSM/GPRS 850) 27.20 dBm (EDGE 850) 28.90 dBm (GSM/GPRS 1900) 26.30 dBm (EDGE 1900) 23.87 dBm (WCDMA/HSDPA Band V) 23.81 dBm (WCDMA/HSDPA Band II)
Max. ERP/EIRP Power	: 0.995 W / 29.98 dBm ERP (GSM/GPRS 850) 0.371 W / 25.69 dBm ERP (EDGE 850) 0.953 W / 29.79 dBm EIRP (GSM/GPRS 1900) 0.494 W / 26.94 dBm EIRP (EDGE 1900) 0.145 W / 21.61 dBm ERP (WCDMA/HSDPA Band V) 0.226 W / 23.55 dBm EIRP (WCDMA/HSDPA Band II)
Type of Emission	: GSM 850 : 245KGXW EDGE 850 : 249KG7W GSM 1900 : 245KGXW EDGE 1900 : 246KG7W WCDMA Band V : 4M16F9W WCDMA Band II : 4M14F9W
Power Rating (DC , Voltage and Current of RF element or PA)	: DC Power Supply DC 3.3 V, 750 mA
Digital Modulation Emission	: GMSK(GSM/GPRS) 8PSK(EDGE) QPSK(WCDMA) QPSK/16QAM (HSDPA)
Power Supply Type	: Powered by DC Power Supply
DUT Stage	: Production Unit

1.1 Series Application Description

Model Name	Application	Differences Description
M320	Basic model	-----
M320A	Family model	M320 combines the SIM pin and changes the model number to be M320A with FPC and SIM holder.
M320B	Family model	M320 adds a connector and changes the model number.



2. Test Configuration of Equipment under Test

2.1 Test Manner

1. The spurious emission measurements were carried out in semi-anechoic chamber with 3-meter test range.
2. During all testing, EUT is in link mode with base station emulator at maximum power level. (PCL=5 for GSM 850 or PCL=0 for GSM 1900)
3. Frequency range investigated: radiated emission 30 MHz to 9000 MHz for GSM850; 30MHz to 19000 MHz for GSM 1900.

2.2 Test Mode

Preliminary tests were performed in different data mode to find the worst case. The data mode shown in the table below is the worst-case rate (Blue color). Investigation has been done on all the possible configurations for searching the worst cases. The following table is a list of the test modes shown in this test report.

Output power (Peak Power)					
Band	Data Rate	Channel	Frequency (MHz)	Conducted Power (dBm)	Worst Case
GSM 850	-	Lowest 128	824.20	31.40	<input checked="" type="checkbox"/>
		Middle 190	836.40	31.20	<input type="checkbox"/>
		Highest 251	848.80	31.10	<input type="checkbox"/>
GPRS 850	3Down2Up	Lowest 128	824.20	30.60	<input type="checkbox"/>
		Middle 190	836.40	30.50	<input type="checkbox"/>
		Highest 251	848.80	30.30	<input type="checkbox"/>
EDGE 850	3Down2Up	Lowest 128	824.20	27.10	<input type="checkbox"/>
		Middle 190	836.40	27.20	<input type="checkbox"/>
		Highest 251	848.80	27.20	<input type="checkbox"/>



Output power (Peak Power)					
Band	Data Rate	Channel	Frequency (MHz)	Conducted Power (dBm)	Worst Case
GSM 1900	-	Lowest 512	1850.20	28.90	<input checked="" type="checkbox"/>
		Middle 661	1880.00	28.60	<input type="checkbox"/>
		Highest 810	1909.80	28.80	<input type="checkbox"/>
EDGE 1900	3Down2Up	Lowest 512	1850.20	27.90	<input type="checkbox"/>
		Middle 661	1880.00	27.60	<input type="checkbox"/>
		Highest 810	1909.80	27.50	<input type="checkbox"/>
GPRS 1900	3Down2Up	Lowest 512	1850.20	26.30	<input type="checkbox"/>
		Middle 661	1880.00	26.10	<input type="checkbox"/>
		Highest 810	1909.80	26.00	<input type="checkbox"/>

Output power (Peak Power)					
Band	Sub-Test	Channel	Frequency (MHz)	Conducted Power (dBm)	Worst Case
WCDMA Band V	-	Lowest 4132	826.40	23.87	<input checked="" type="checkbox"/>
		Middle 4182	836.40	23.62	<input type="checkbox"/>
		Highest 4233	846.40	23.71	<input type="checkbox"/>
HSDPA Band V	1	Lowest 4132	826.40	23.35	<input type="checkbox"/>
		Middle 4182	836.40	23.14	<input type="checkbox"/>
		Highest 4233	846.40	23.19	<input type="checkbox"/>
	2	Lowest 4132	826.40	23.40	<input type="checkbox"/>
		Middle 4182	836.40	23.15	<input type="checkbox"/>
		Highest 4233	846.40	23.24	<input type="checkbox"/>
	3	Lowest 4132	826.40	23.85	<input type="checkbox"/>
		Middle 4182	836.40	23.68	<input type="checkbox"/>
		Highest 4233	846.40	23.70	<input type="checkbox"/>
	4	Lowest 4132	826.40	23.86	<input type="checkbox"/>
		Middle 4182	836.40	23.67	<input type="checkbox"/>
		Highest 4233	846.40	23.71	<input type="checkbox"/>



Output power (Peak Power)					
Band	Sub-Test	Channel	Frequency (MHz)	Conducted Power (dBm)	Worst Case
WCDMA Band II	-	Lowest 9262	1852.40	22.54	<input type="checkbox"/>
		Middle 9400	1880.00	22.59	<input type="checkbox"/>
		Highest 9538	1907.60	23.01	<input type="checkbox"/>
HSDPA Band II	1	Lowest 9262	1852.40	22.72	<input type="checkbox"/>
		Middle 9400	1880.00	22.49	<input type="checkbox"/>
		Highest 9538	1907.60	23.26	<input type="checkbox"/>
	2	Lowest 9262	1852.40	22.70	<input type="checkbox"/>
		Middle 9400	1880.00	22.51	<input type="checkbox"/>
		Highest 9538	1907.60	23.24	<input type="checkbox"/>
	3	Lowest 9262	1852.40	23.25	<input type="checkbox"/>
		Middle 9400	1880.00	23.01	<input type="checkbox"/>
		Highest 9538	1907.60	23.81	<input checked="" type="checkbox"/>
	4	Lowest 9262	1852.40	23.22	<input type="checkbox"/>
		Middle 9400	1880.00	22.99	<input type="checkbox"/>
		Highest 9538	1907.60	23.79	<input type="checkbox"/>

2.3 Connection Diagram of Test System

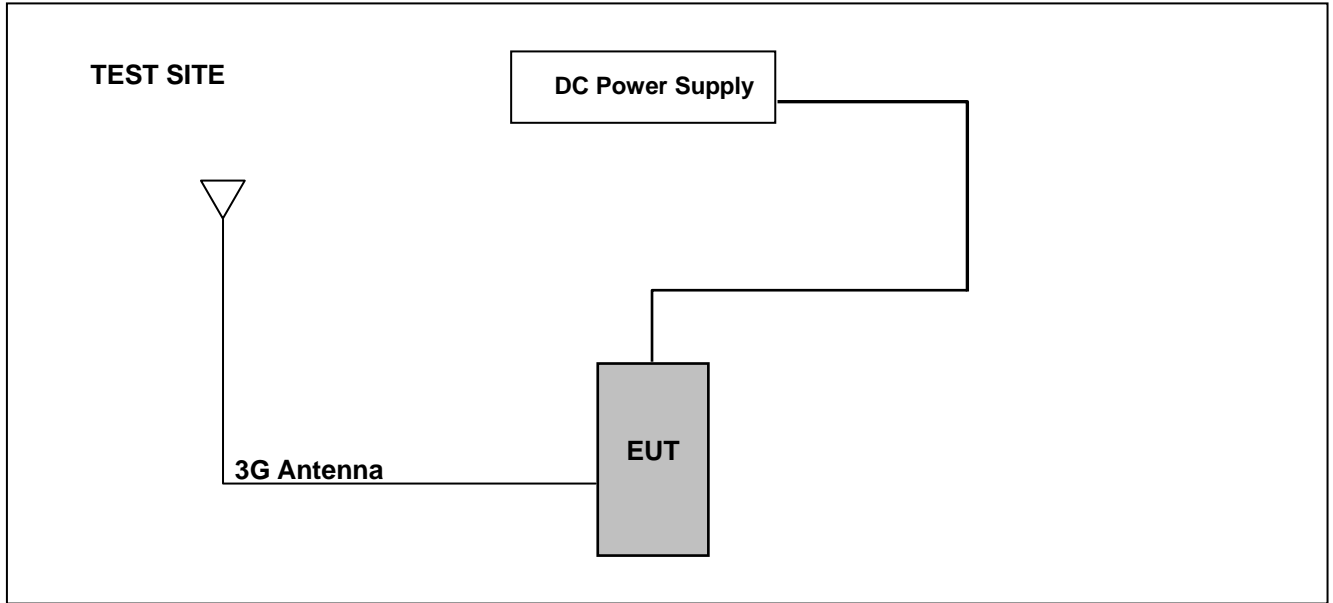

During testing (LINK) the EUT (M320)'s antenna port was connected to 3G Antenna. EUT's Power Port was connected to DC Power Supply.

2.4 Ancillary Equipment List

1. Base Station(R&S) CMU200 106656
2. DC Power Supply (HOLA) DP-30032



3. General Information of Test Site

Test Site Location: No. 140 -1, Changan Street, Bade City, Taoyuan County, Taiwan R.O.C.
TEL: 886-3-271-0188 FAX: 886-3-271-0190

Registration Number : 854525
Designation Number : TW1330

The chamber meets the characteristics of ANSI C63.4-2006. This site is on file with the FCC.

3.1 Test Voltage

DC Power Supply DC 5V

3.2 Test in Compliance with

47 CFR Part 22H, 24E and Part 2, ANSI/TIA-603-C-2004

3.3 Frequency Range Investigated

1. Radiation: from 30 MHz to 9000 MHz for GSM 850.
2. Radiation: from 30 MHz to 19000 MHz for GSM 1900.
3. Radiation: from 30 MHz to 9000 MHz for WCDMA Band V.
4. Radiation: from 30 MHz to 19000 MHz for WCDMA Band II.

3.4 Test Distance

The test distance of radiated emission from antenna to EUT is 3 m.



4. Test Data and Test Result

4.1 List of Measurements and Examinations

FCC Rule	DESCRIPTION OF TEST	Result	Section
§ 2.1046	RF Output Power	Passed	4.2
§ 22.913 § 24.232	ERP / EIRP	Passed	4.3
§ 2.1049 § 22.917 § 24.238(b)	Occupied Bandwidth & Band Edge Measurement	Passed	4.4
§ 2.1051	Conducted Emission	Passed	4.5
§ 2.1053	Field Strength of Spurious Radiation	Passed	4.6
§ 2.1055 § 22.355 § 24.235	Frequency Stability vs. Temperature	Passed	4.7
§ 2.1055 § 22.355 § 24.235	Frequency Stability vs. Voltage	Passed	4.8
§ 15.207	AC Power Conducted Emissions Requirements	Passed	4.9



4.2 RF Output Power

4.2.1 Measurement Instruments :

As described in chapter 5 of this test report.

4.2.2 Test Procedure :

The measurement is made according to ANSI/TIA-603-C-2004 as follows:

1. The transmitter output was connected to power meter and base station through power divider.
2. Set base station for EUT at GSM 850: PCL=5 and GSM 1900: PCL=0.
3. Set base station for EUT at WCDMA Band V and WCDMA Band II, power level was set to maximum.
4. Set base station for EUT at HSDPA Band V and HSDPA Band II,
RF Output Power Results for HSDPA Rel5

The following Sub-Tests were completed according to the test requirements outlined in section 5.2A of the 3GPP Ts34.121-1 V8.6.0 specification. All TX RMS for Power class 3 were met according to table 5.2AA.5 and achieved through the outlined test procedure in section 5.2AA.4.2. All UE channels and power ratio's are set according to table C10.1.4 in the 3GPP TS34.121-1 V8.6.0 specification. A summary of these settings are illustrated below:

Sub-test	Mode	Call Type	RMC (kbps)	HSDPA FRC	Power Class 3 Max Limit dBm	Bc/βd	Bhs	CM (dB)	MPR
1	HSDPA	PS	12.2	H-Set 1 QPSK	24 (+1.7/3.7db)	2/15	4/15	0.0	0.0
2	HSDPA	PS	12.2	H-Set 1 QPSK	24 (+1.7/3.7db)	12/15 ⁽³⁾	24/15	1.0	0.0
3	HSDPA	PS	12.2	H-Set 1 QPSK	23.5 (+2.2/3.7db)	15/8	30/15	1.5	0.5
4	HSDPA	PS	12.2	H-Set 1 QPSK	23.5 (+2.2/3.7db)	15/4	30/15	1.5	0.5

5. Select lowest, middle, and highest channels for each band.

4.2.3 Test Setup Layout :

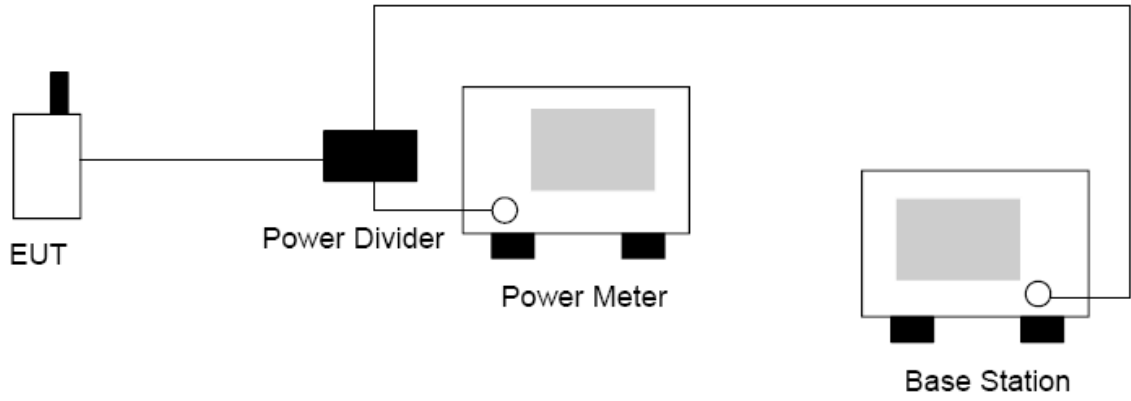



4.2.4 Test Result :

Bands	Channel	Frequency (MHz)		Conducted Power (dBm)	Conducted Power (Watts)
GSM 850	128	Low	824.2	31.40	1.380
	190	Mid	836.4	31.20	1.318
	251	High	848.8	31.10	1.288
GPRS 850	128	Low	824.2	30.60	1.148
	190	Mid	836.4	30.50	1.122
	251	High	848.8	30.30	1.072
EDGE 850	128	Low	824.2	27.10	0.513
	190	Mid	836.4	27.20	0.525
	251	High	848.8	27.20	0.525

Note: The testing result was used peak detector.

Bands	Channel	Frequency (MHz)		Conducted Power (dBm)	Conducted Power (Watts)
GSM 1900	512	Low	1850.2	28.90	0.776
	661	Mid	1880.0	28.60	0.724
	810	High	1909.8	28.80	0.759
GPRS 1900	512	Low	1850.2	27.90	0.617
	661	Mid	1880.0	27.60	0.575
	810	High	1909.8	27.50	0.562
EDGE 1900	512	Low	1850.2	26.30	0.427
	661	Mid	1880.0	26.10	0.407
	810	High	1909.8	26.00	0.398

Note: The testing result was used peak detector.



Bands	Channel	Frequency (MHz)		Conducted Power (dBm)	Conducted Power (Watts)
WCDMA Band V	4132	Low	826.4	23.87	0.244
	4182	Mid	836.4	23.62	0.230
	4233	High	846.4	23.71	0.235

Note: The testing result was used peak detector.

Bands	Channel	Frequency (MHz)		Conducted Power (dBm)	Conducted Power (Watts)
HSDPA Band II	9262	Low	1852.4	23.25	0.211
	9400	Mid	1880.0	23.01	0.200
	9538	High	1907.6	23.81	0.240

Note: The testing result was used peak detector.



4.3 ERP / EIRP Measurement

Equivalent isotropic radiated power measurements by substitution method according to ANSI/TIA/EIA-603-B-2002.

4.3.1 Measurement Instruments

As described in chapter 5 of this test report.

4.3.2 Test Procedure

The phone was tested in an anechoic chamber with a 3-axis position system that permits taking complete spherical scans of the EUT's 3-axis radiation patterns. For all tests, the phone was supported in a free space type environment, vertically oriented in the chamber. Tests were done for GSM 850 three frequencies (824.2, 836.6 and 848.8 MHz) and GSM 1900 three frequencies (1850.2, 1880.00, and 1909.80 MHz).

GSM measurements were made with the phone placed in a call using the CMU200 mobile station test set. The phone was weakly coupled to the test set and configured to transmit in full data rate mode.

The radiated power was measured using ETS-LINDGREN OTA Chamber in "Peak" mode. From these measurements, the software calculates the angle at which maximum radiated power occurs for each case, and the radiated power at this angle was extracted from the data.

Each individual data point in a radiated power or sensitivity measurement is referred to as the effective isotropic radiated power or effective isotropic sensitivity. That is, the desired information is how the measured quantity relates to the same quantity from an isotropic radiator. Thus, the reference measurement must relate the power received or transmitted at the EUT test equipment (spectrum analyzer or communication tester) back to the power transmitted or received at a theoretical isotropic radiator. The total path loss then, is just the difference in dB between the power transmitted or received at the isotropic radiator and that seen at the test equipment (see follow Figure 1).

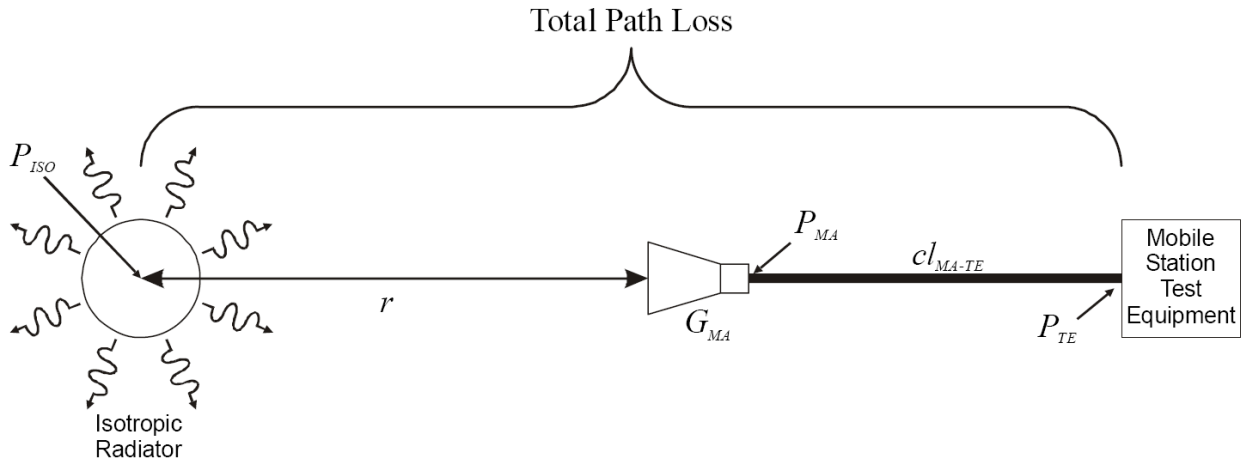

Figure 1. THEORETICAL CASE FOR DETERMINING PATH LOSS

In equation form, this becomes:

Equation 1

$$PL = P_{ISO} - P_{TE},$$

where PL is the total path loss, P_{ISO} is the power radiated by the theoretical isotropic radiator, and P_{TE} is the power received at the test equipment port. As can be seen in Figure 1, this quantity includes the range path loss due to the range length r , the gain of the measurement antenna, and any loss terms associated with the cabling, connections, amplifiers, splitters, etc. between the measurement antenna and the test equipment port.

Figure 2 shows a typical real world configuration for measuring the path loss. In this case, a reference antenna with known gain is used in place of the theoretical isotropic source. The path loss may then be determined from the power into the reference antenna by adding the gain of the reference antenna.

That is:

Equation 2

$$P_{ISO} = P_{RA} + G_{RA},$$

where P_{RA} is the power radiated by reference antenna, and G_{RA} is the gain of the reference antenna, so that:

Equation 3

$$PL = P_{RA} + G_{RA} - P_{TE},$$

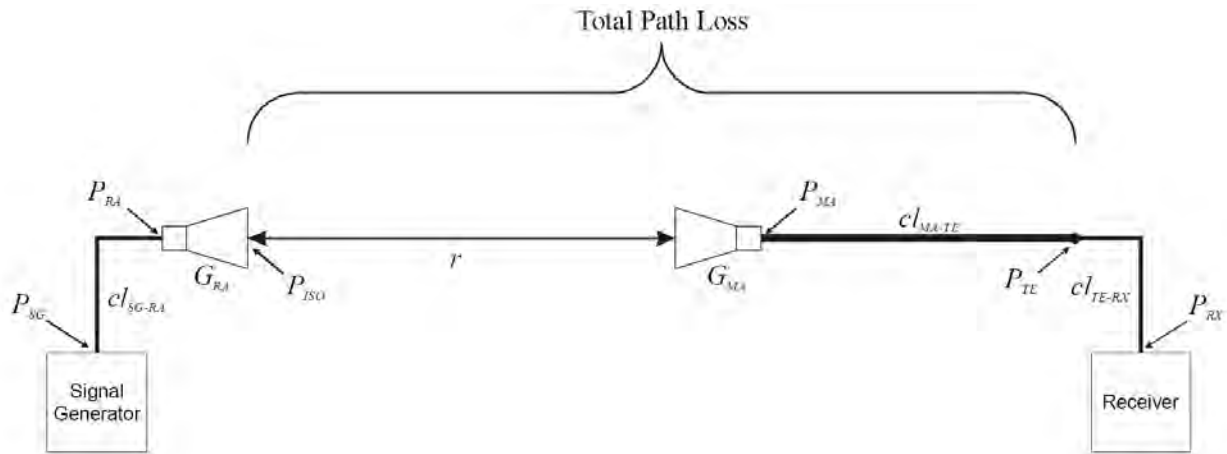

Figure 2. TYPICAL CONFIGURATION FOR MEASURING PATH LOSS

In order to determine P_{RA} , it is necessary to perform a cable reference measurement to remove the effects of the cable loss between signal generator and reference antenna, and between the test equipment port and the receiver. This establishes a reference point at the input to the reference antenna. Figure 3 illustrates the cable reference measurement configuration. Assuming the power level at the signal generator is fixed, it is easy to show that the difference between P_{RA} and P_{TE} in Figure 2 is given by:

Equation 4

$$P_{RA} - P_{TE} = P_{RX}' - P_{RX},$$

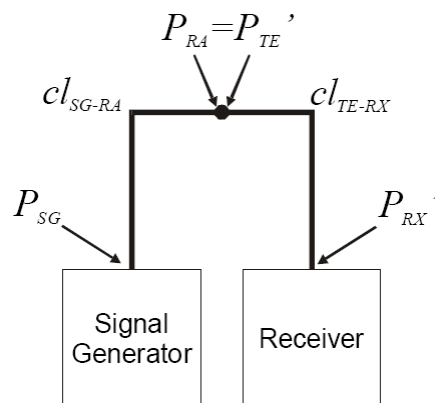

Figure 3. CABLE REFERENCE CALIBRATION CONFIGURATION

Where P_{RX} is the power measured at the receiver during the cable reference test, and P_{RX} is the power measured at the receiver during the range path loss measurement in Figure 2. Thus, the path loss is then just given by:

Equation 5

$$PL = G_{RA} + P_{RX}' - P_{RX}$$

$$EIRP = P_t + P_L$$

P_t = Often referred to as antenna output power

4.3.3 Test Setup Layout of ERP/EIRP

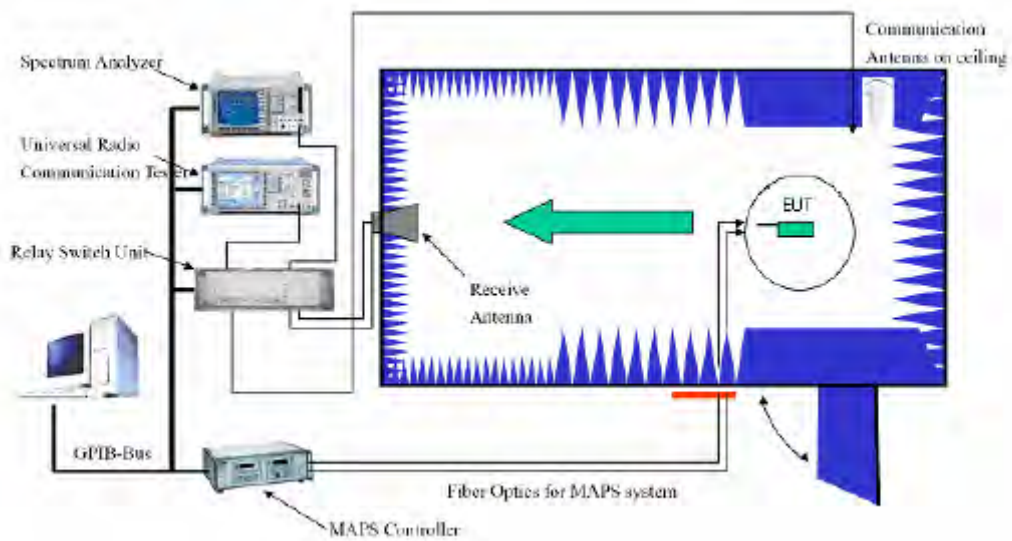



4.3.4 Test Result

GSM 850 Radiated Power ERP				
Maximum Output Power				
Frequency (MHz)	Read Level (dBm)	Correction factor (dBm)	ERP (dBm)	ERP (W)
824.20	78.97	-49.50	29.47	0.885
836.40	79.68	-49.70	29.98	0.995
848.80	79.56	-49.70	29.86	0.968

EDGE 850 Radiated Power ERP				
Maximum Output Power				
Frequency (MHz)	Read Level (dBm)	Correction factor (dBm)	ERP (dBm)	ERP (W)
824.20	75.00	-49.50	25.50	0.355
836.40	75.39	-49.70	25.69	0.371
848.80	75.31	-49.70	25.61	0.364

GSM 1900 Radiated Power EIRP				
Maximum Output Power				
Frequency (MHz)	Read Level (dBm)	Correction factor (dBm)	EIRP (dBm)	EIRP (W)
1850.20	84.88	-55.40	29.48	0.887
1880.00	84.93	-55.60	29.33	0.857
1909.80	85.49	-55.70	29.79	0.953

EDGE 1900 Radiated Power EIRP				
Maximum Output Power				
Frequency (MHz)	Read Level (dBm)	Correction factor (dBm)	EIRP (dBm)	EIRP (W)
1850.20	82.34	-55.40	26.94	0.494
1880.00	82.37	-55.60	26.77	0.475
1909.80	82.23	-55.70	26.53	0.450

Note:

1. ERP/EIRP = Read Level + Correction factor.
2. For CDMA signals, a peak detector is used, with RBW = VBW = 3 MHz.
3. For WCDMA signals, a peak detector is used with RBW = VBW = 5MHz.
4. For AMPS, GSM, and NADC TDMA signals, a peak detector is used, with RBW = VBW= 1 MHz.



WCDMA Band V Radiated Power ERP				
Maximum Output Power				
Frequency (MHz)	Read Level (dBm)	Correction factor (dBm)	ERP (dBm)	ERP (W)
826.40	70.36	-48.80	21.56	0.143
836.40	70.18	-48.80	21.38	0.137
846.60	70.41	-48.80	21.61	0.145

WCDMA Band II Radiated Power EIRP				
Maximum Output Power				
Frequency (MHz)	Read Level (dBm)	Correction factor (dBm)	EIRP (dBm)	EIRP (W)
1852.40	77.55	-54.00	23.55	0.226
1880.00	78.78	-55.60	23.18	0.208
1907.60	80.35	-56.90	23.45	0.221

Note:

1. ERP/EIRP = Read Level + Correction factor.
2. For CDMA signals, a peak detector is used, with RBW = VBW = 3 MHz.
3. For WCDMA signals, a peak detector is used with RBW = VBW = 5MHz.
4. For AMPS, GSM, and NADC TDMA signals, a peak detector is used, with RBW = VBW= 1 MHz.

4.4 Occupied Bandwidth and Band Edge Measurement

4.4.1 Measurement Instruments

As described in chapter 5 of this test report.

4.4.2 Test Procedure

The measurement is made according to FCC rules part 22 and 24:

1. The EUT was connected to Spectrum Analyzer and Base Station via power divider.
2. The occupied bandwidth of middle channel for the highest and lowest RF powers was measured.
3. The band edge of low and high channels for the highest RF powers within the transmitting frequency band were measured. Setting RBW as roughly BW/100.
4. The band edge setting:
 - a. RB=3 kHz; VB=3 kHz for GSM 850 and GSM 1900.
 - b. RB=100 kHz; VB=100 kHz for WCDMA Band V and WCDMA Band II.

4.4.3 Test Setup Layout

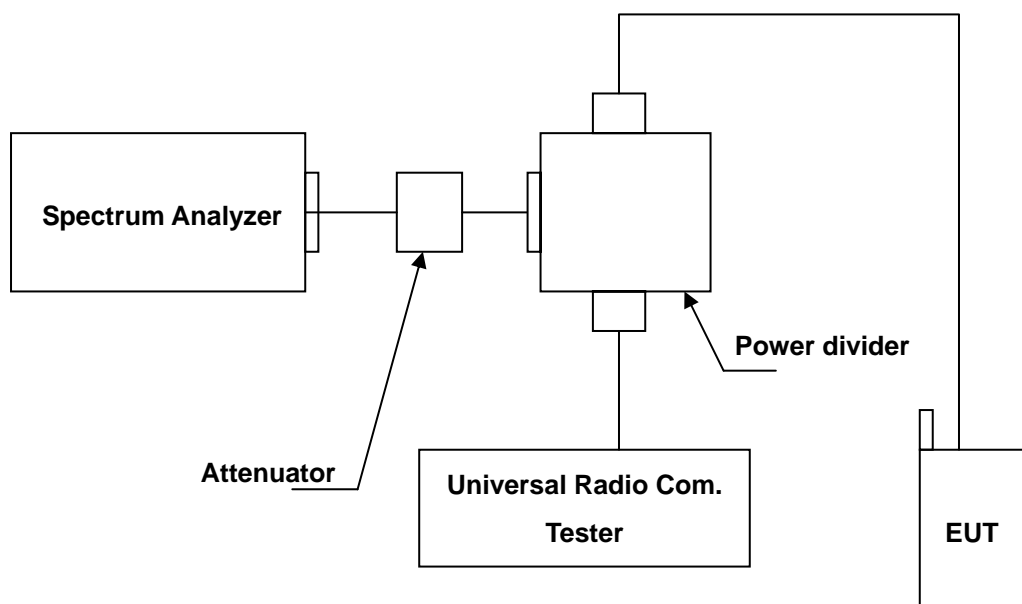



4.4.4 Occupied Bandwidth Test Result

GSM 850		
Channel	Frequency (MHz)	Output Power - 26 dBc Bandwidth (kHz)
128	824.2	245.7620
190	836.6	244.1257
251	848.8	244.0880
RB:3KHz , VBW:10KHz		

EDGE 850		
Channel	Frequency (MHz)	Output Power - 26 dBc Bandwidth (kHz)
128	824.2	246.7085
190	836.6	245.7960
251	848.8	249.0008
RB:3KHz , VBW:10KHz		

GSM 1900		
Channel	Frequency (MHz)	Output Power - 26 dBc Bandwidth (kHz)
512	1850.2	243.8790
661	1880.0	244.8384
810	1909.8	244.9727
RB:3KHz , VBW:10KHz		

EDGE 1900		
Channel	Frequency (MHz)	Output Power - 26 dBc Bandwidth (kHz)
512	1850.2	246.2613
661	1880.0	245.1591
810	1909.8	245.9430
RB:3KHz , VBW:10KHz		



WCDMA Band V		
Channel	Frequency (MHz)	Output Power - 26 dBc Bandwidth (MHz)
4132	826.4	4.1304
4182	836.4	4.1432
4233	846.6	4.1652
RB:30KHz , VBW:300KHz		

WCDMA Band II		
Channel	Frequency (MHz)	Output Power - 26 dBc Bandwidth (MHz)
9262	1852.4	4.1254
9400	1880.0	4.1435
9538	1907.6	4.1314
RB:30KHz , VBW:300KHz		



Test Mode: GSM 850 CH128 99% Occupied Bandwidth

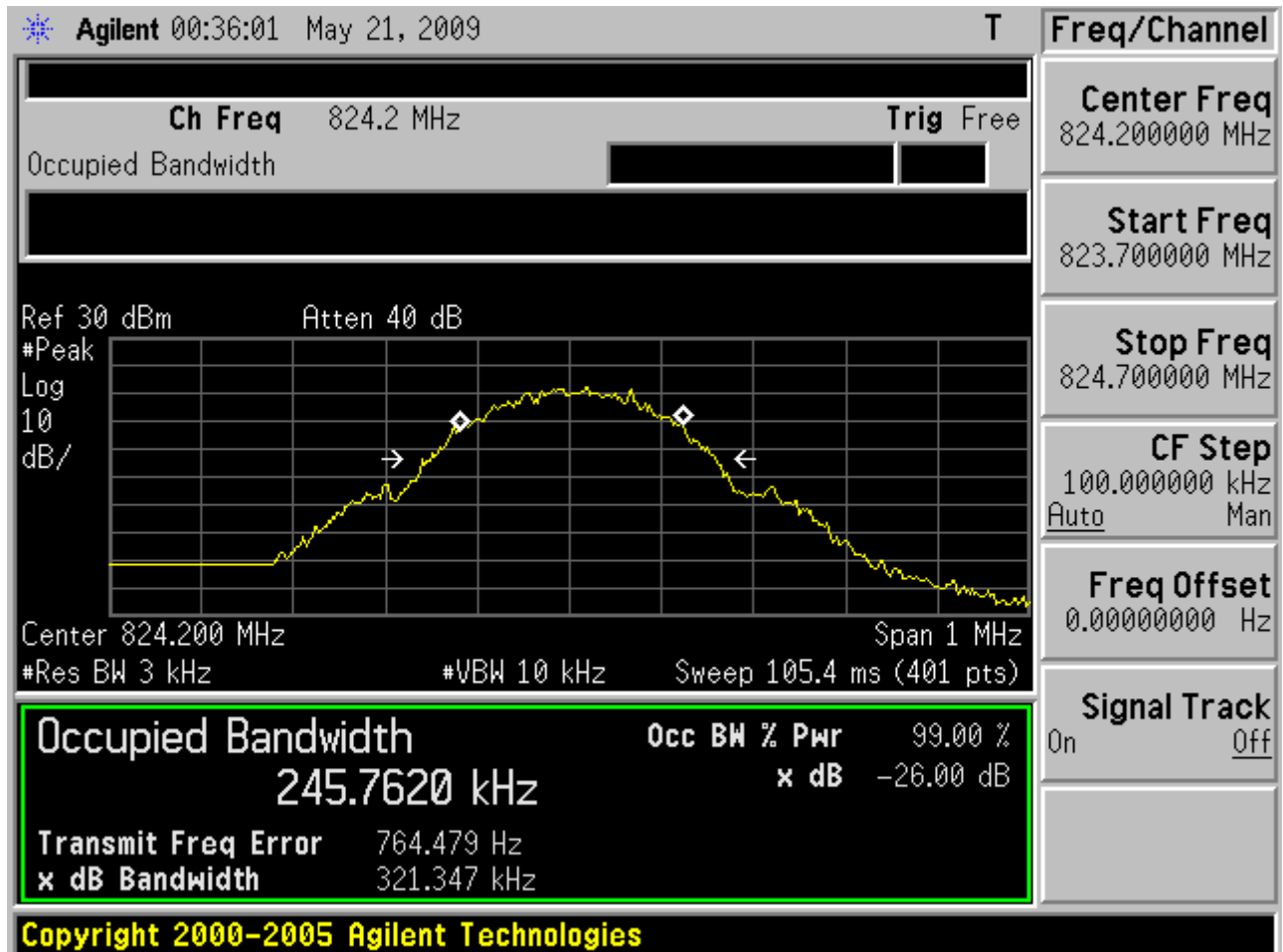



Test Mode: GSM 850 CH190 99% Occupied Bandwidth

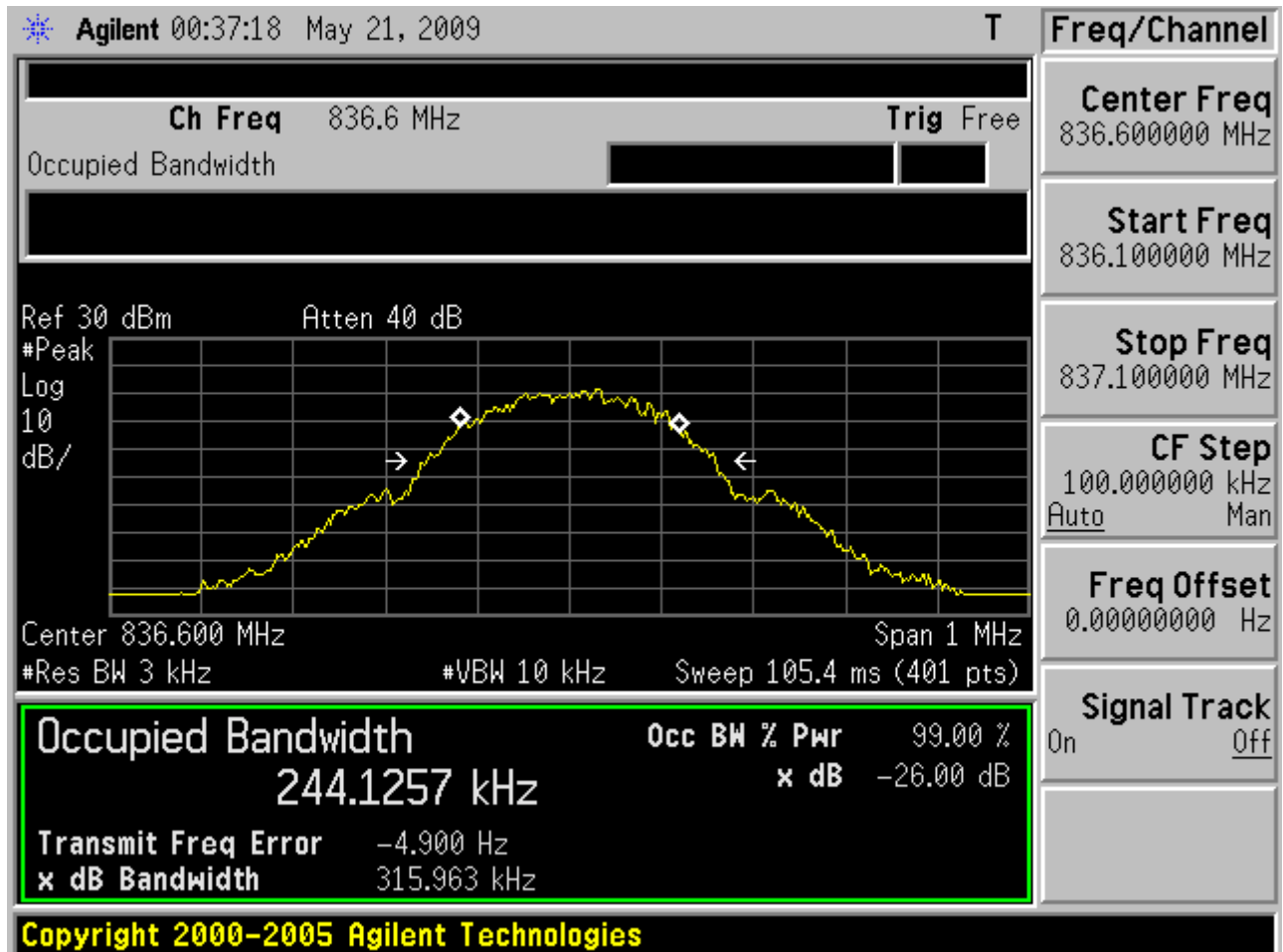



Test Mode: GSM 850 CH251 99% Occupied Bandwidth

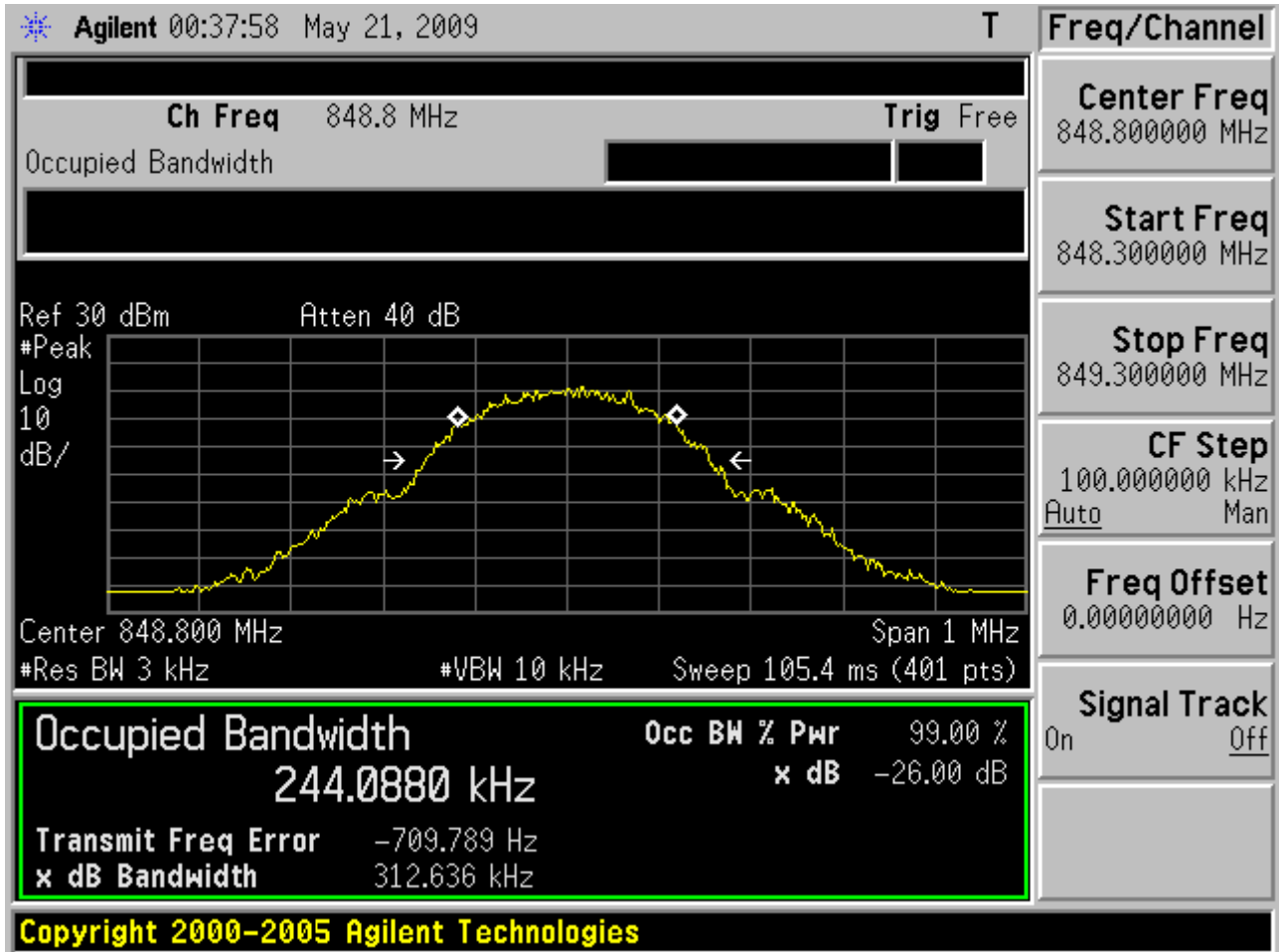



Test Mode: EDGE 850 CH128 99% Occupied Bandwidth

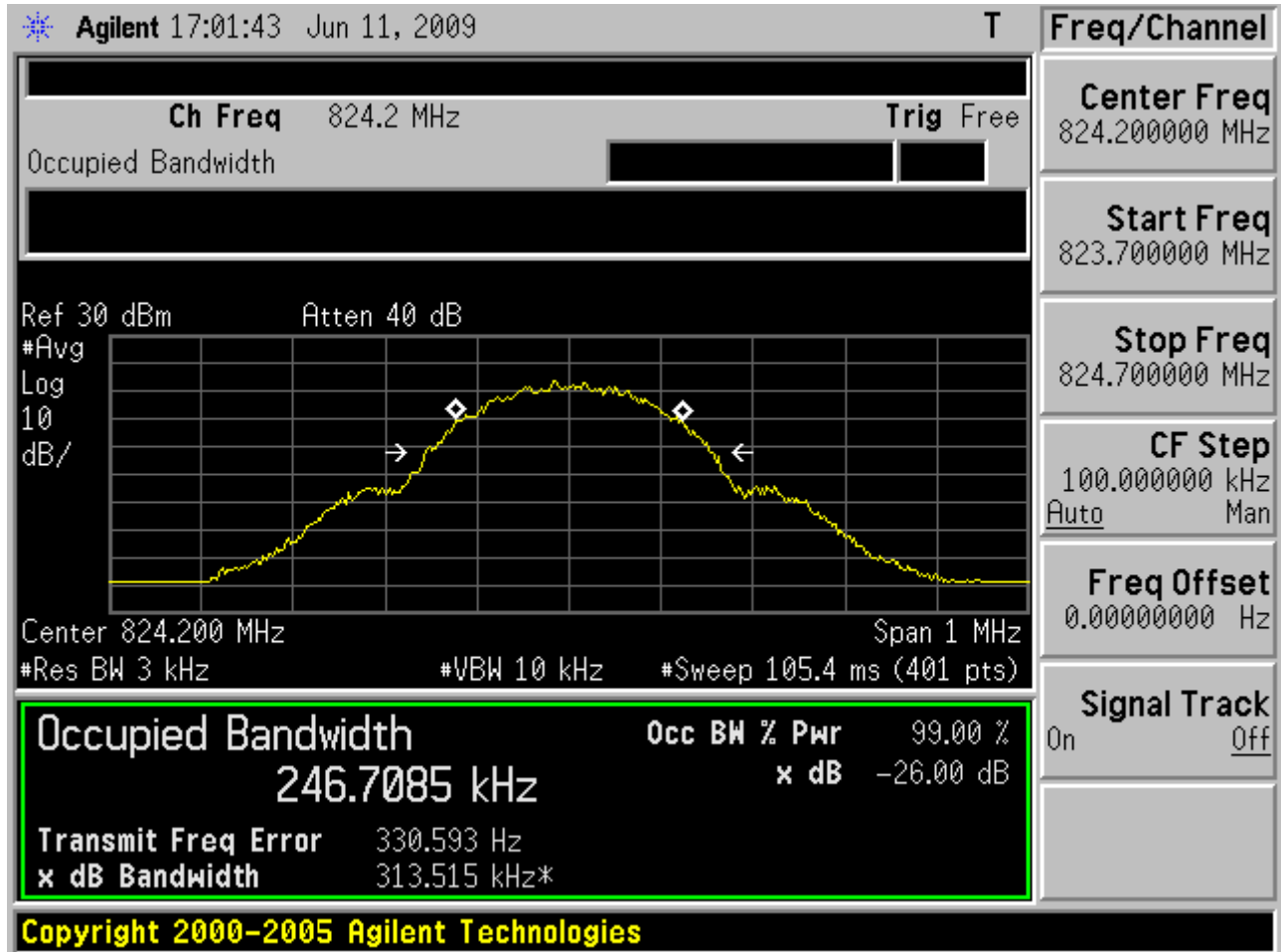



Test Mode: EDGE CH190 99% Occupied Bandwidth





Test Mode: EDGE 850 CH251 99% Occupied Bandwidth

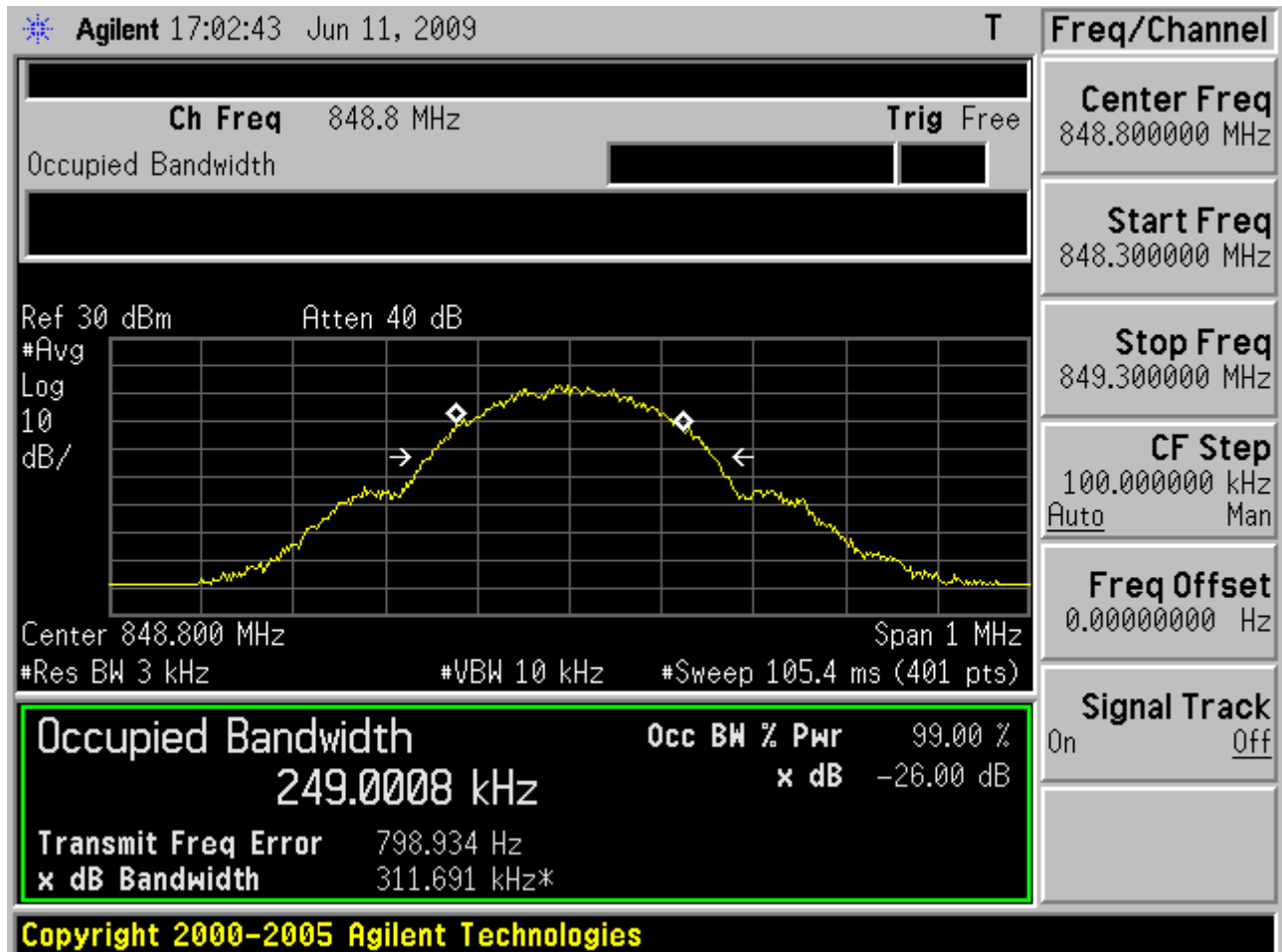



Test Mode: GSM 1900 CH512 99% Occupied Bandwidth

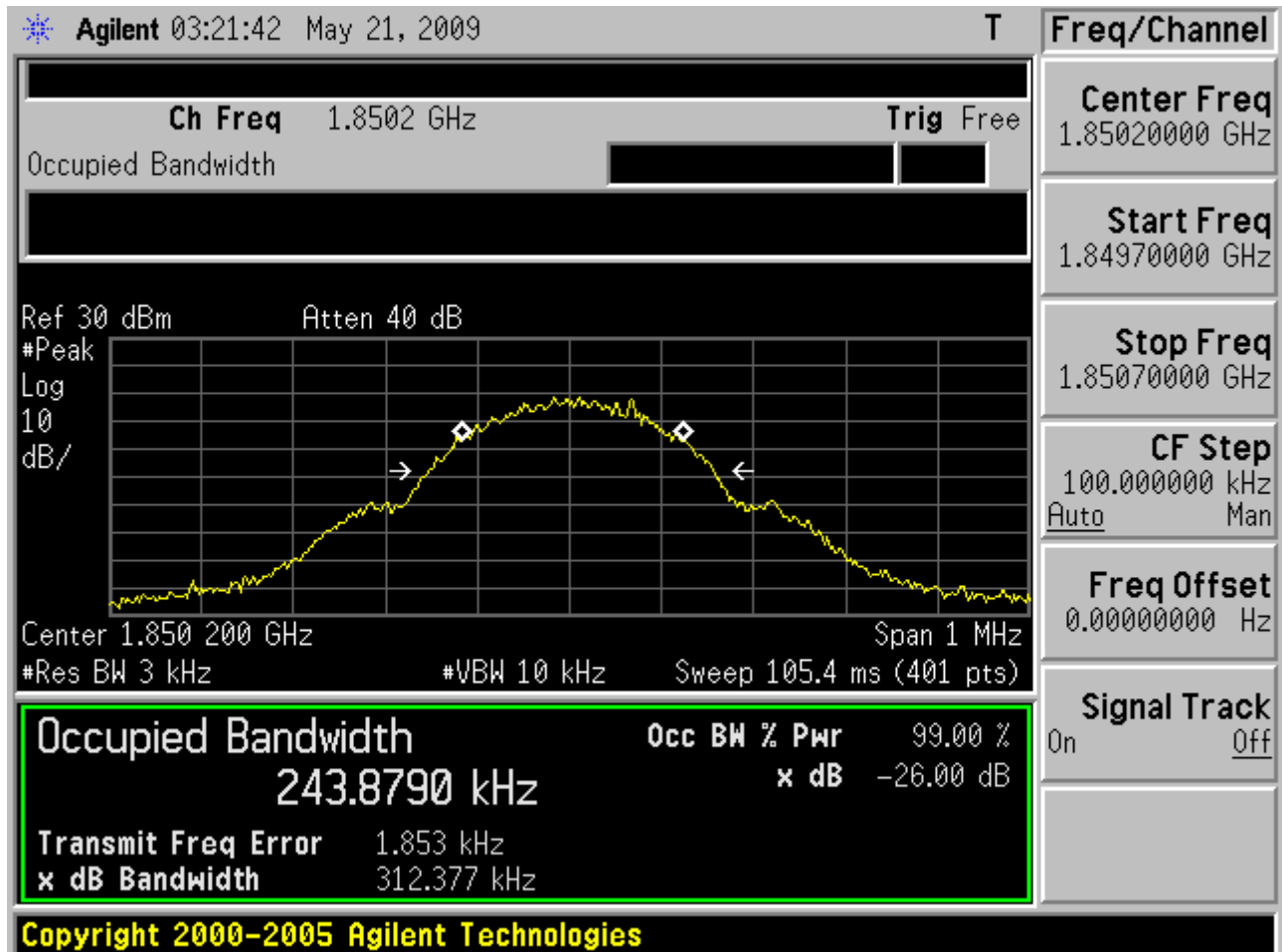



Test Mode: GSM 1900 CH661 99% Occupied Bandwidth

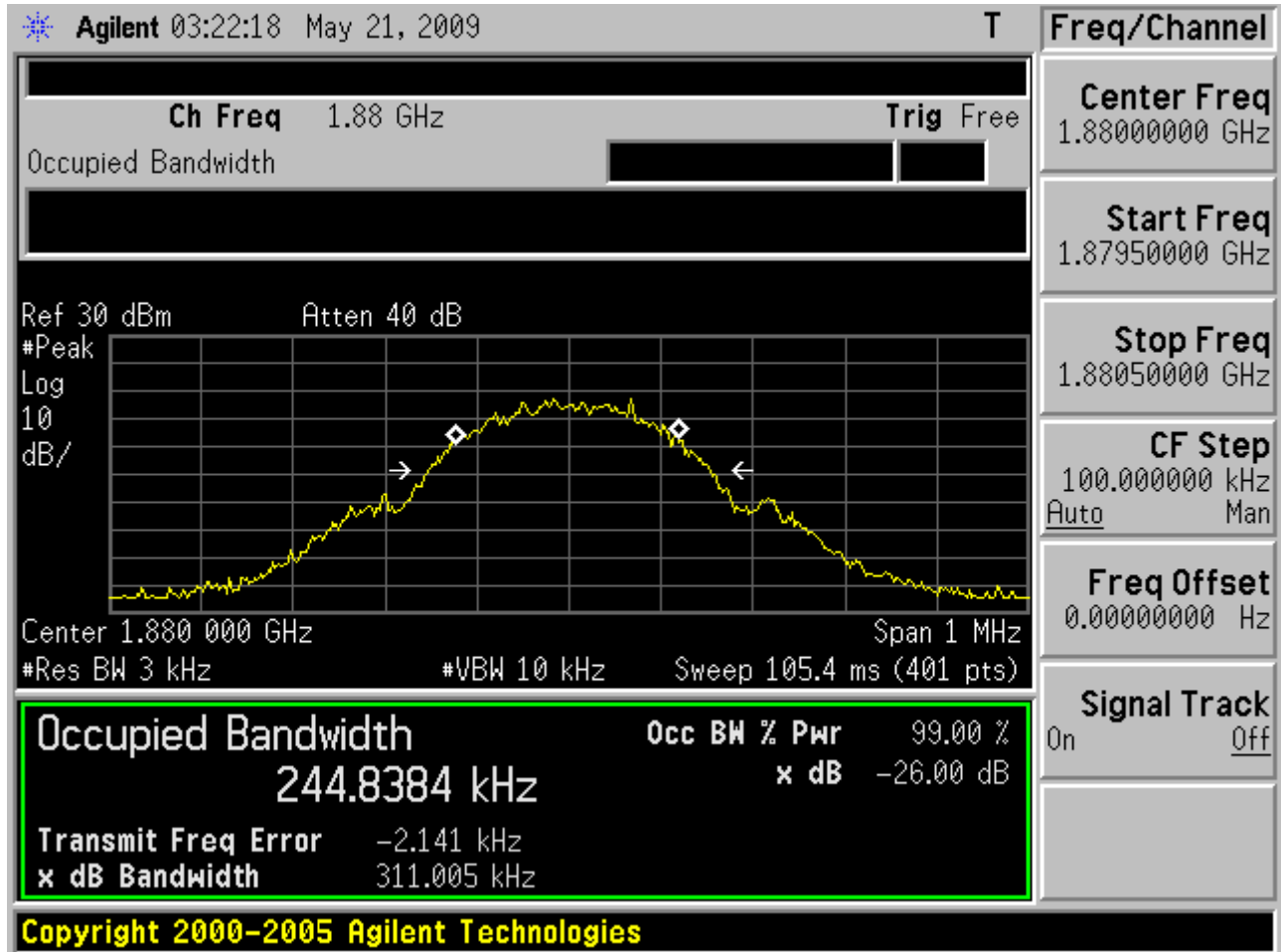



Test Mode: GSM 1900 CH810 99% Occupied Bandwidth

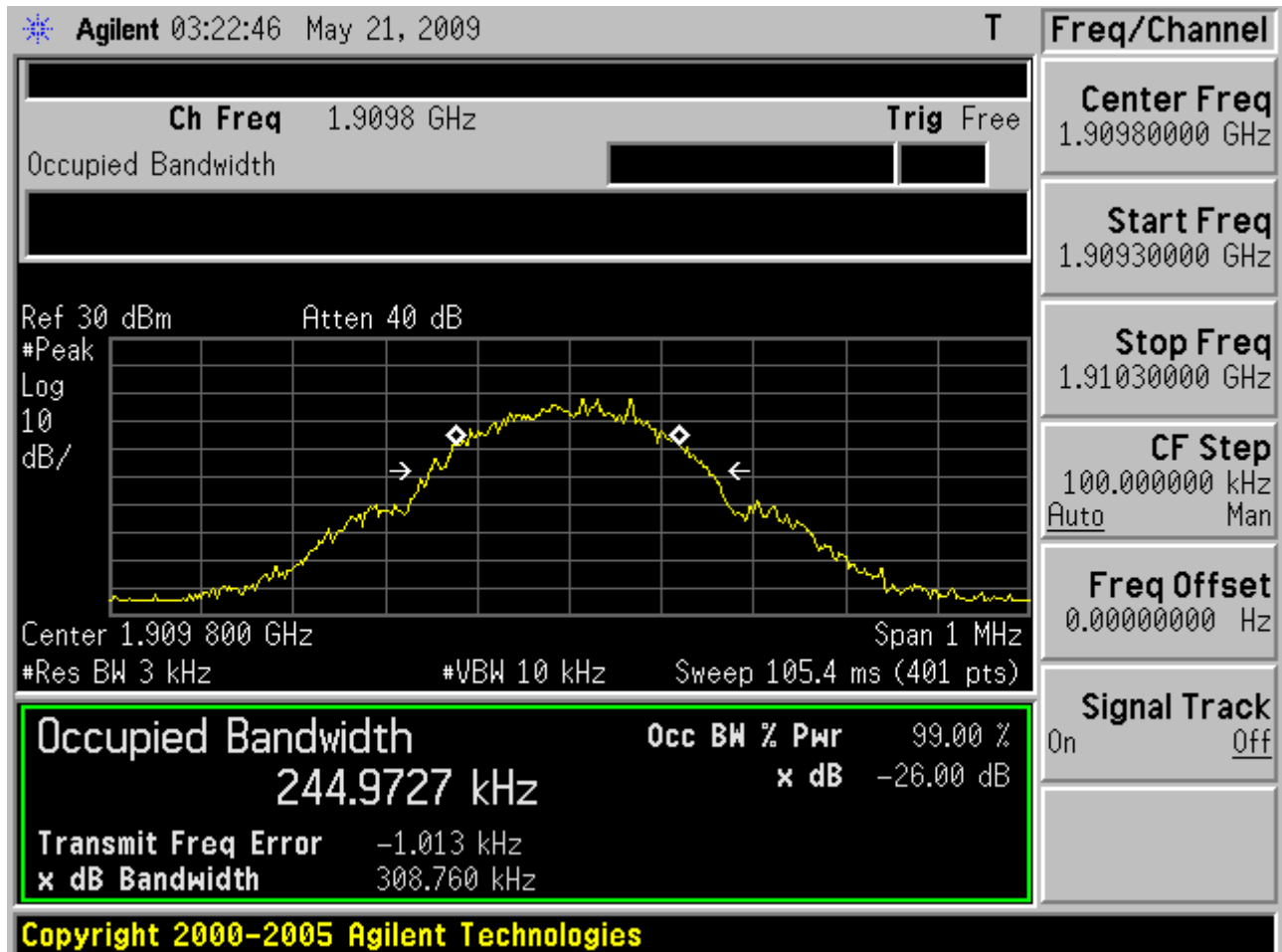



Test Mode: EDGE 1900 CH512 99% Occupied Bandwidth





Test Mode: EDGE 1900 CH661 99% Occupied Bandwidth

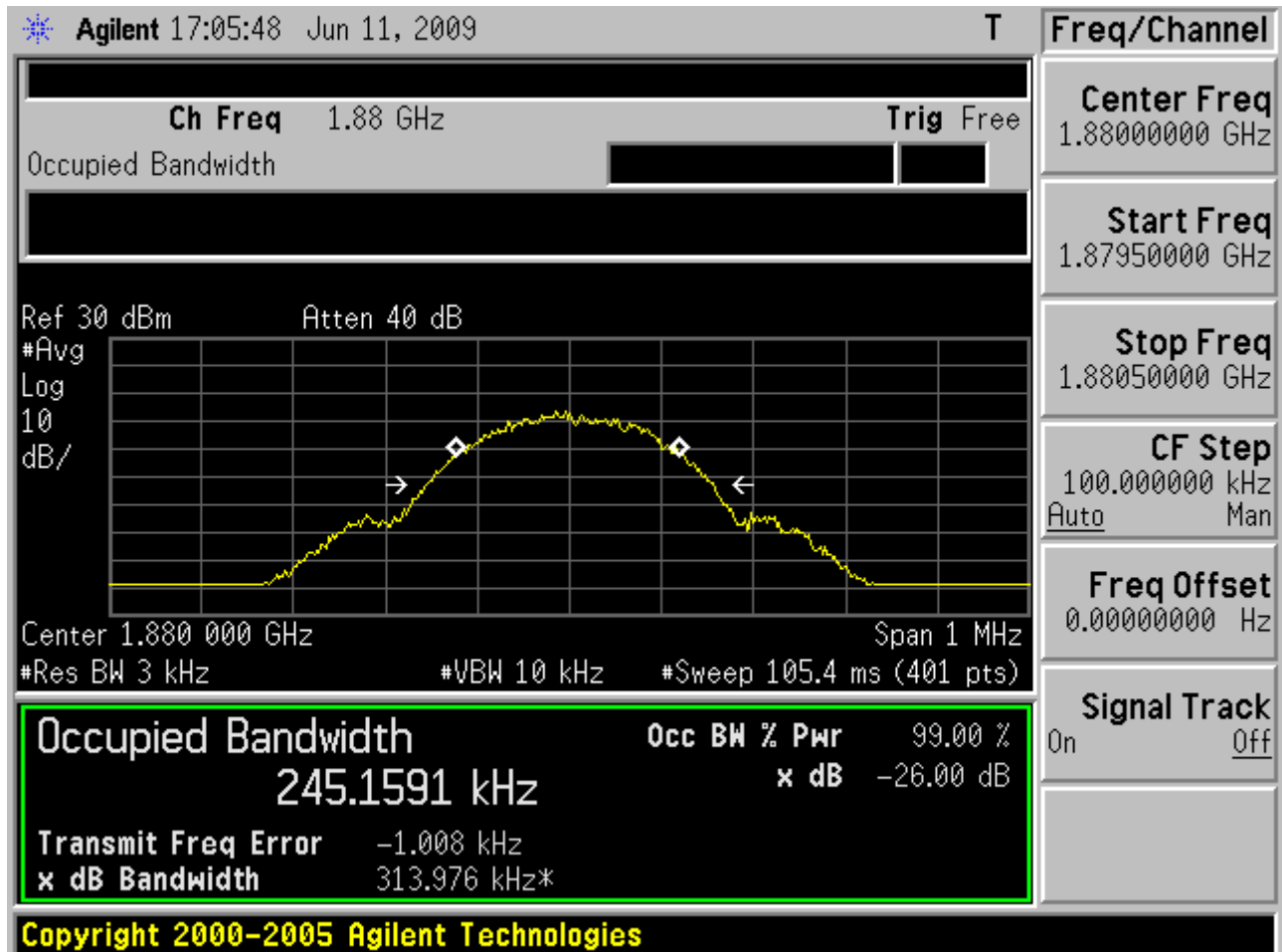



Test Mode: EDGE 1900 CH810 99% Occupied Bandwidth

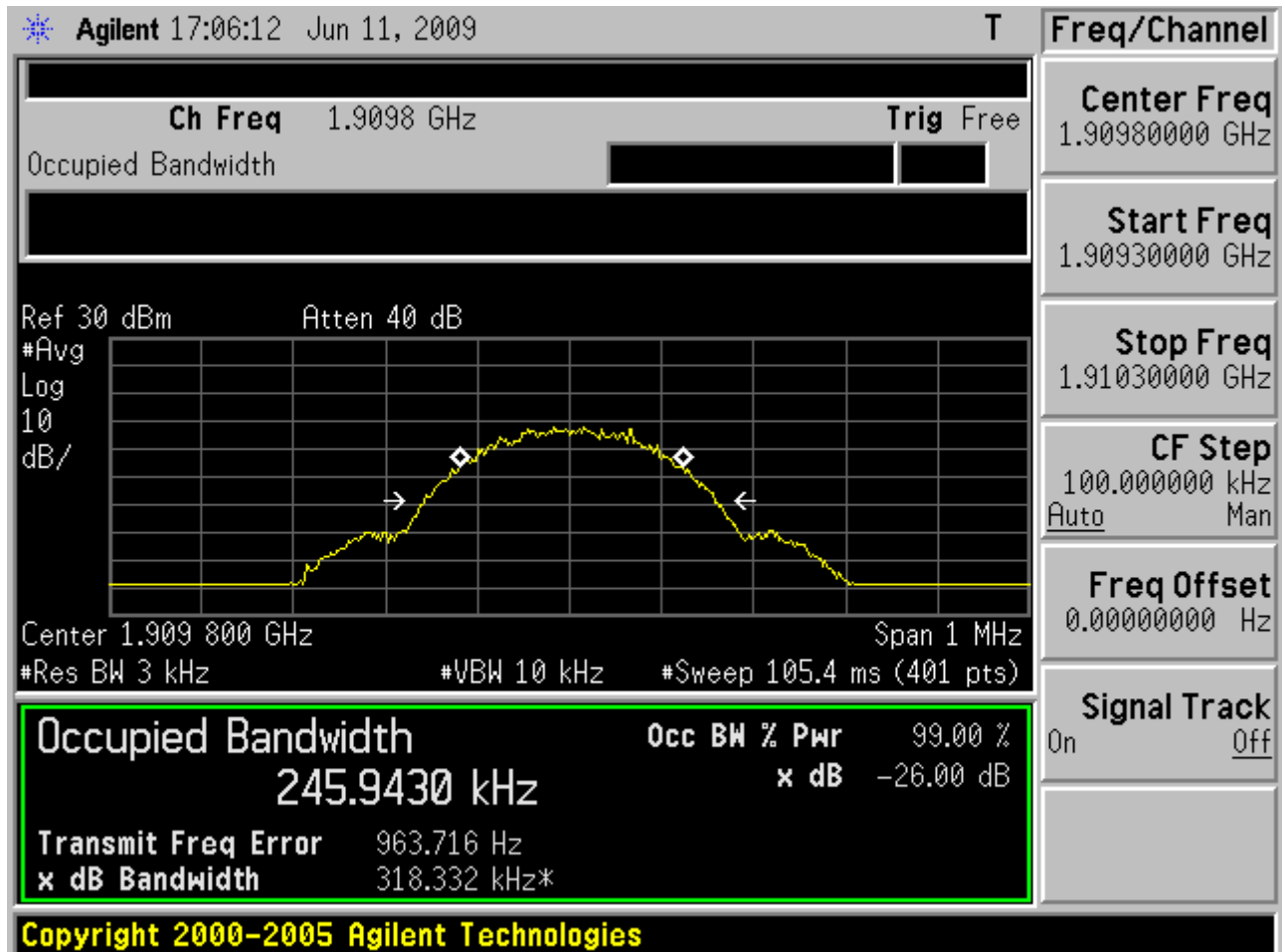



Test Mode: WCDMA Band V CH4132 99% Occupied Bandwidth

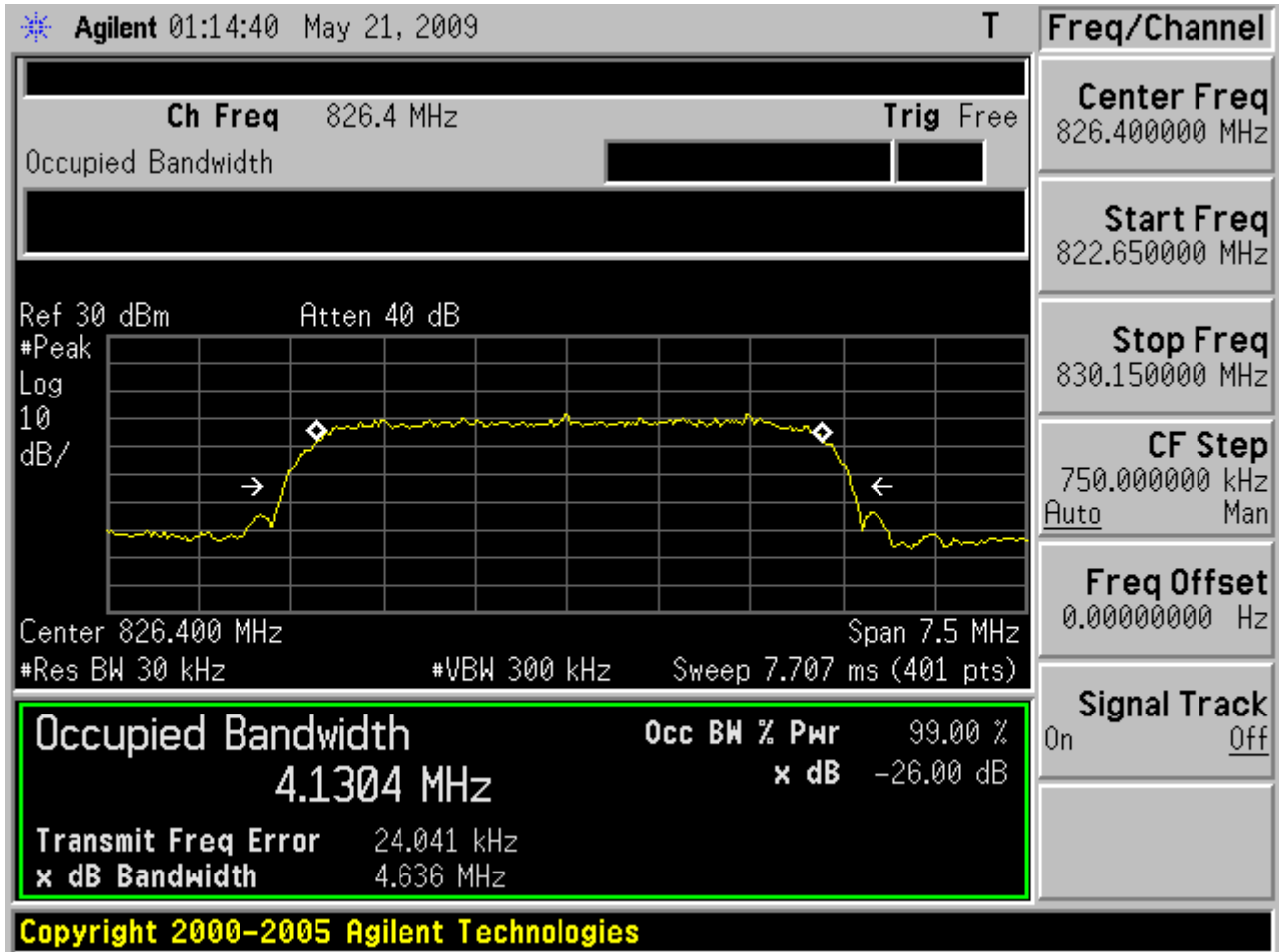



Test Mode: WCDMA Band V CH4182 99% Occupied Bandwidth

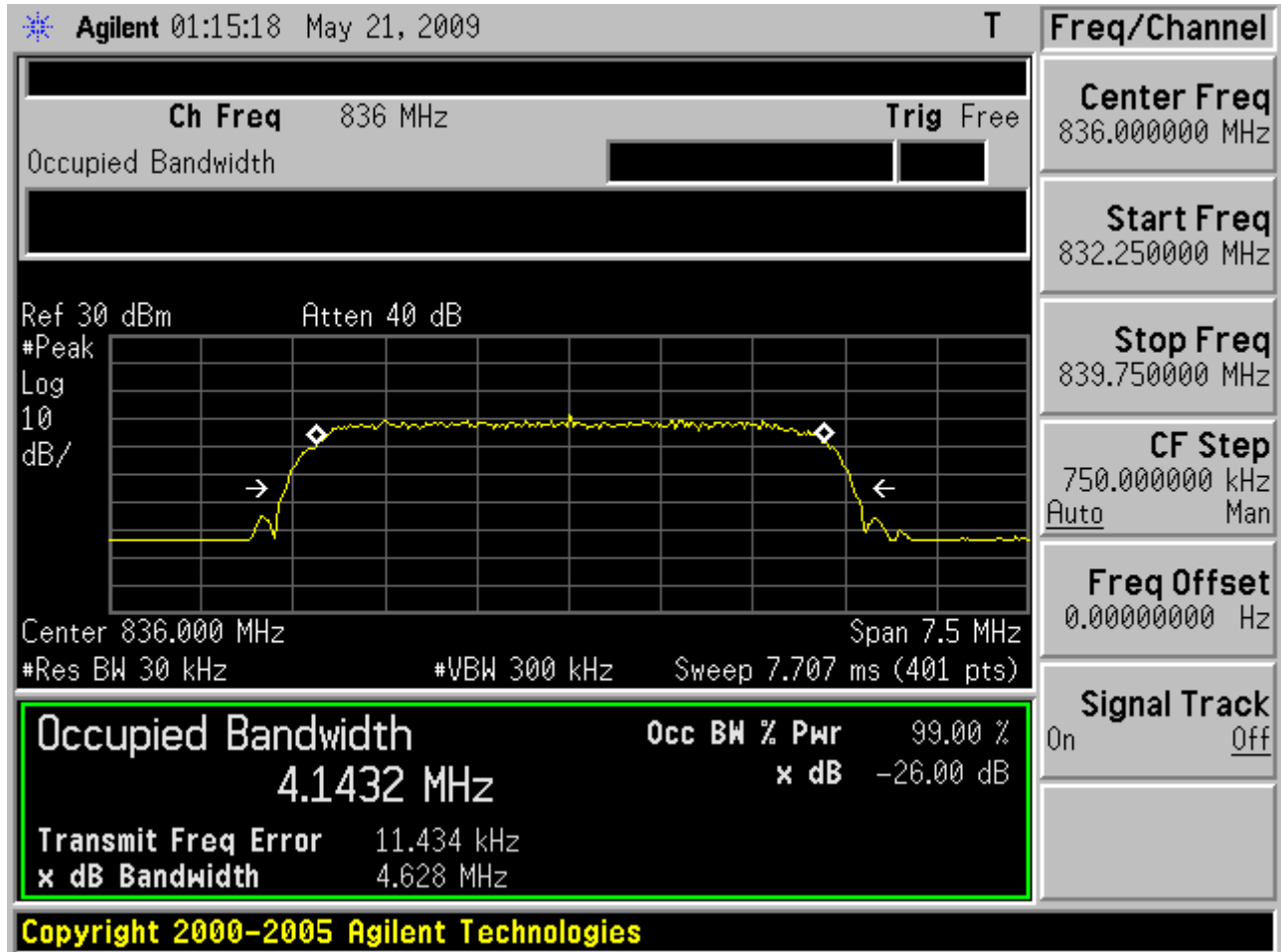



Test Mode: WCDMA Band V CH4233 99% Occupied Bandwidth

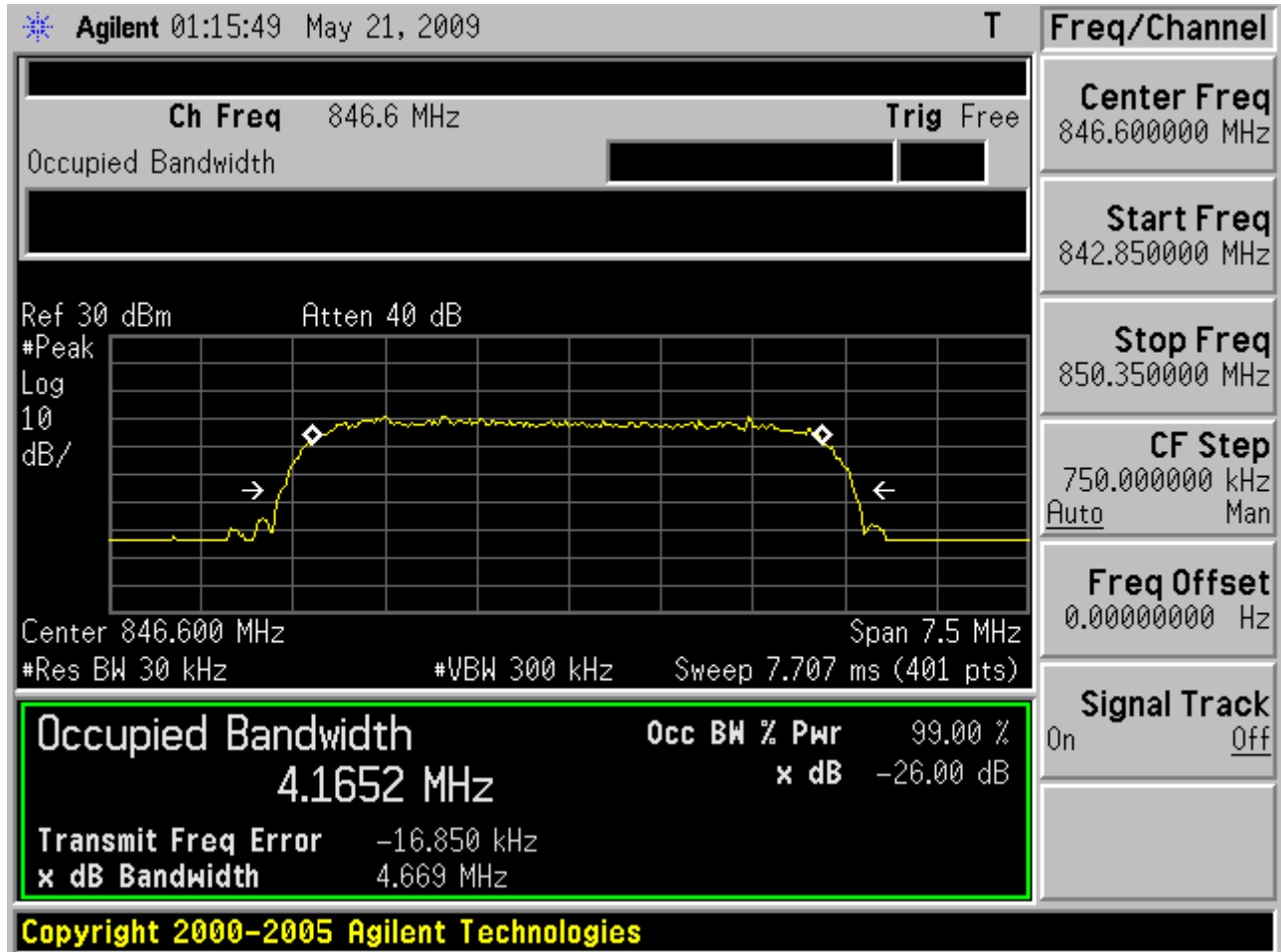



Test Mode: WCDMA Band II CH9262 99% Occupied Bandwidth

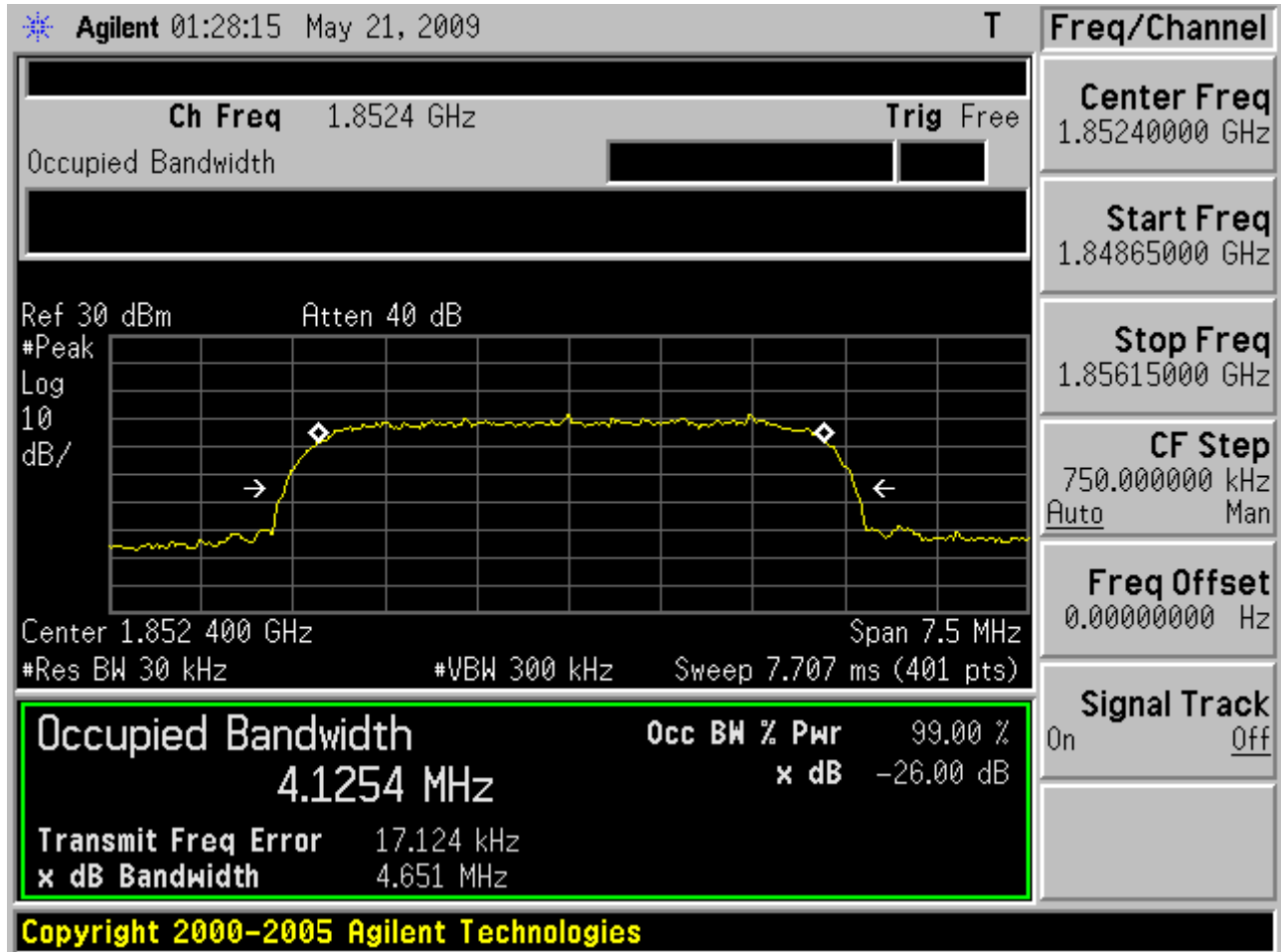



Test Mode: WCDMA Band II CH9400 99% Occupied Bandwidth

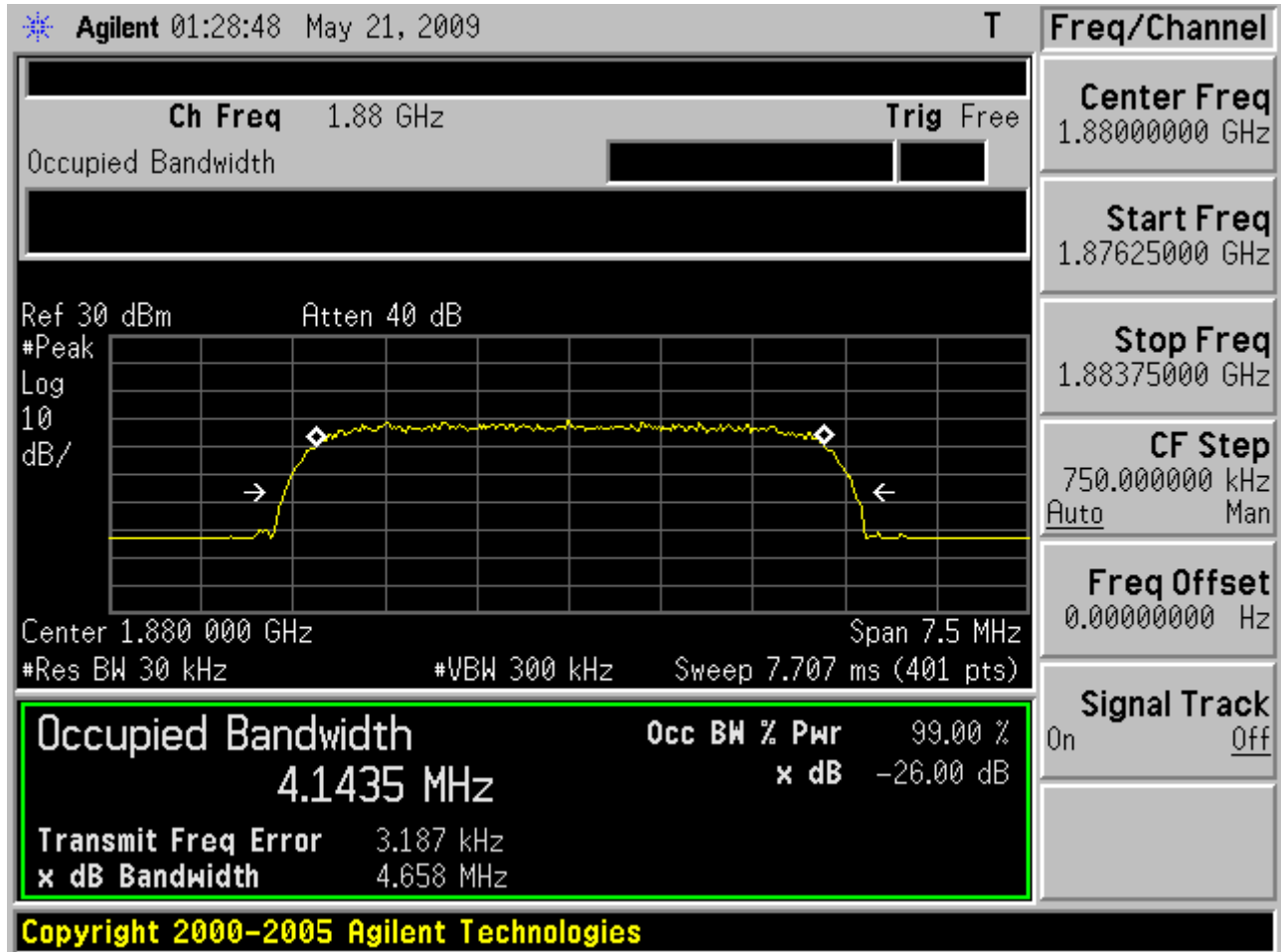



Test Mode: WCDMA Band II CH9538 99% Occupied Bandwidth

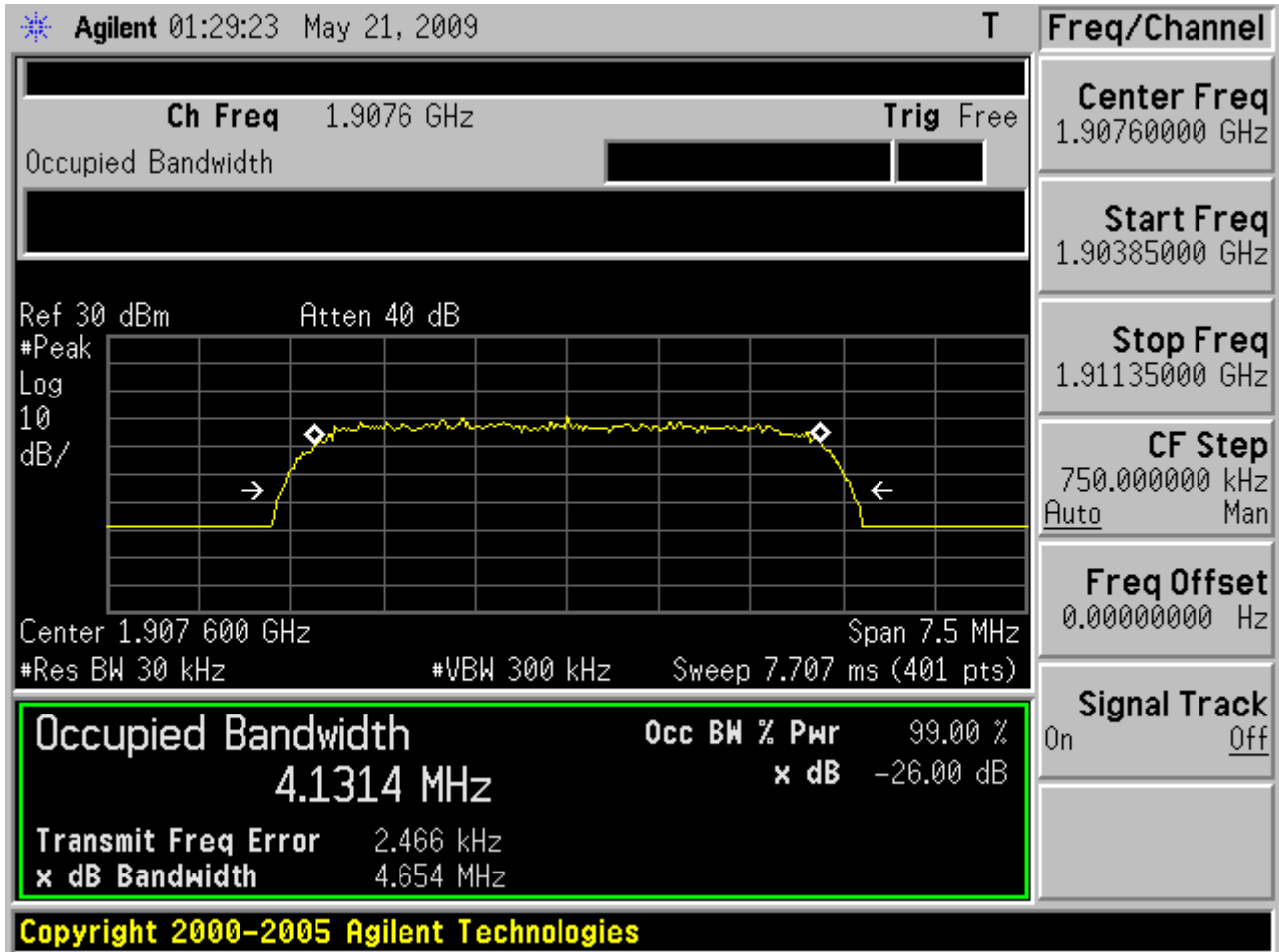



4.4.5 Band Edge Test Result

GSM 850				
Band	Channel	Frequency (MHz)	Band Edge (dBm)	Limit (dBm)
Lower	128	823.9974	-17.54	-13
Higher	251	849.0225	-17.20	-13

Please refer to next pager of detail testing data.



Conducted Emission Measurement

File:M320(CH128)

Data :#1

Date: 2009/5/21

Time: 上午 01:00:59

30.0 dBm

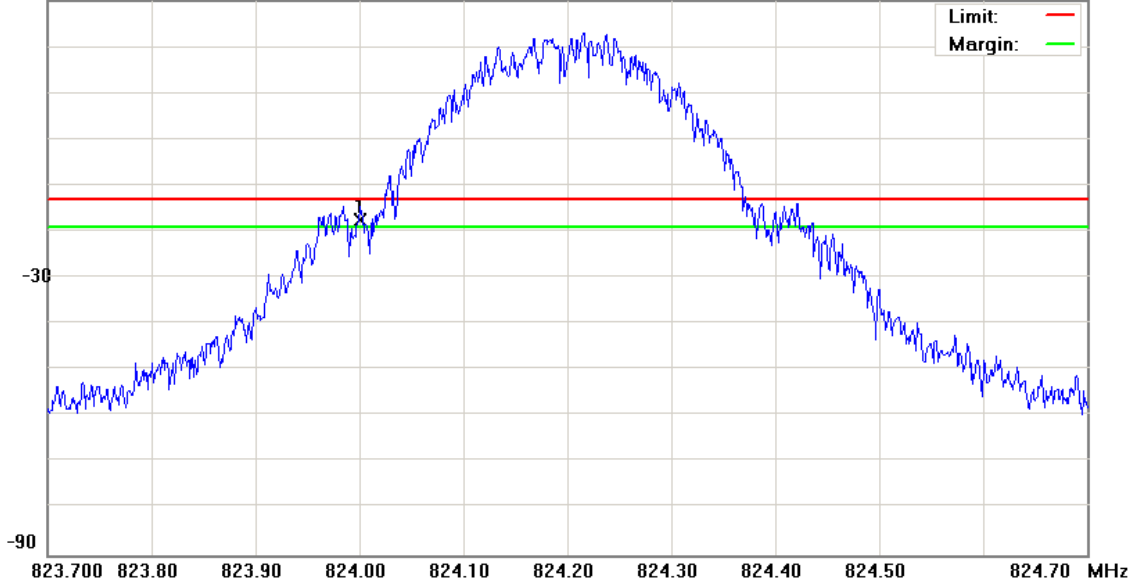

Site site #1 Phase: **Conducted po** Temperature: 26 °C
 Limit: FCC Part 22 conducted(9k-12.75G) Power: AC 110V/60Hz Humidity: 55 %
 EUT:
 M/N: 09-0088-EO
 Mode: GSM850
 Note: CH128
 加10db衰减器

No.	Mk.	Freq.	Reading Level	Correct Factor	Measurement	Limit	Over	Detector	Comment
		MHz	dBm	dB	dBm	dBm	dB		
1	*	824.0000	-30.72	13.18	-17.54	-13.00	-4.54	peak	

*:Maximum data x:Over limit !:over margin



Conducted Emission Measurement

File:M320(CH251)

Data :#1

Date: 2009/5/21

Time: 上午 12:58:50

30.0 dBm

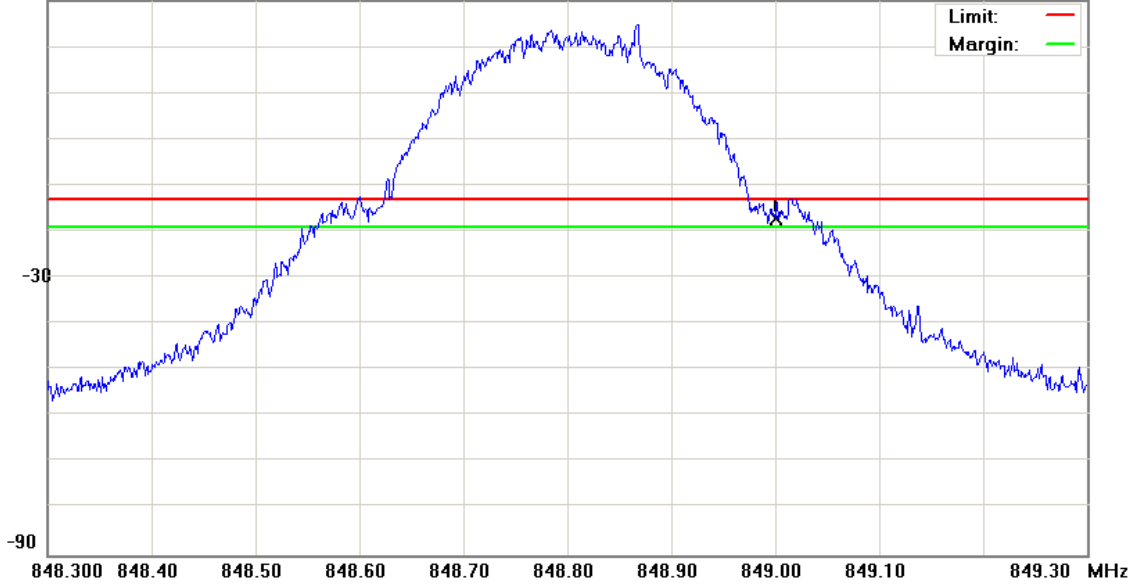

Site site #1 Phase: **Conducted po** Temperature: 26 °C
 Limit: FCC Part 22 conducted(9k-12.75G) Power: AC 110V/60Hz Humidity: 55 %
 EUT:
 M/N: 09-0088-EO
 Mode: GSM850
 Note: CH251
 加10db衰减器

No.	Mk.	Freq.	Reading Level	Correct Factor	Measurement	Limit	Over	Detector	Comment
		MHz	dBm	dB	dBm	dBm	dB		
1	*	849.0000	-30.45	13.25	-17.20	-13.00	-4.20	peak	

*:Maximum data x:Over limit !:over margin



GSM 1900				
Band	Channel	Frequency (MHz)	Band Edge (dBm)	Limit (dBm)
Lower	512	1849.980	-16.82	-13
Higher	810	1910.020	-20.77	-13

Please refer to next pager of detail testing data.



Conducted Emission Measurement

File:M320(CH512)

Data :#1

Date: 2009/5/21

Time: 上午 02:04:32

30.0 dBm

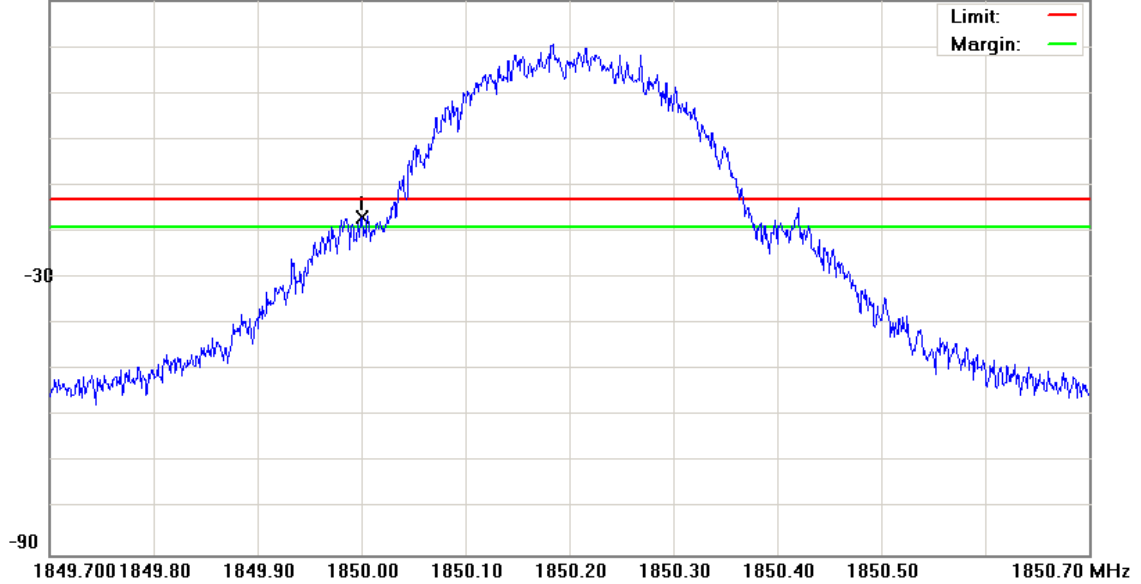

Site site #1 Phase: **Conducted po** Temperature: 26 °C
 Limit: FCC Part 24 conducted(9k-12.75G) Power: AC 110V/60Hz Humidity: 55 %
 EUT:
 M/N: 09-0088-EO
 Mode: PCS1900
 Note: CH512
 加10db衰减器

No.	Mk.	Freq. MHz	Reading Level dBm	Correct Factor dB	Measure- ment dBm	Limit dBm	Over dB	Detector	Comment
1	*	1850.000	-21.08	4.26	-16.82	-13.00	-3.82	peak	

*:Maximum data x:Over limit !:over margin



Conducted Emission Measurement

File:M320(CH810)

Data :#1

Date: 2009/5/21

Time: 上午 02:05:58

30.0 dBm

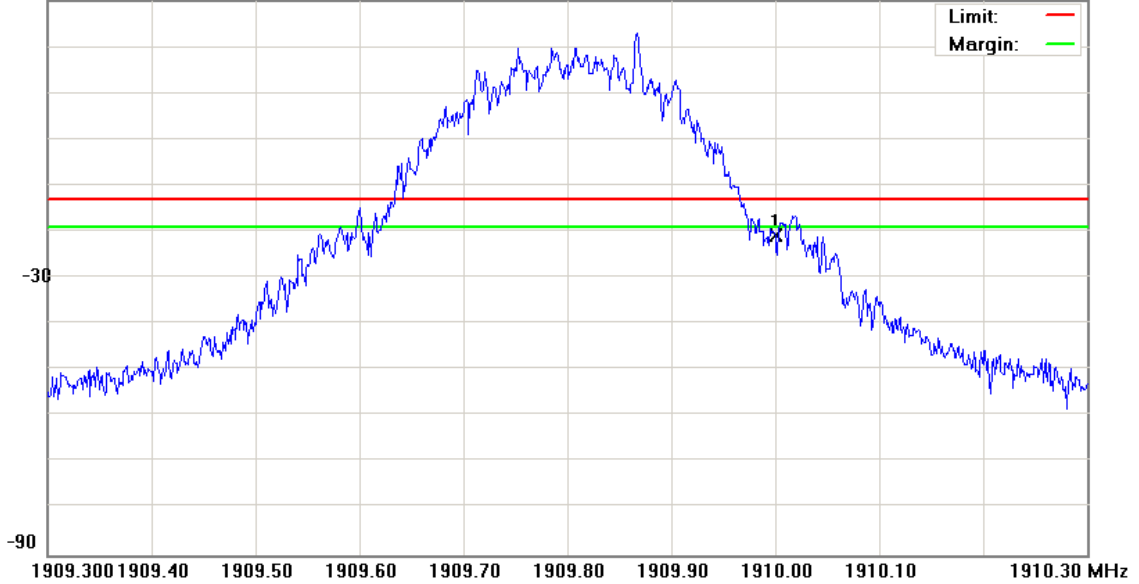

Site site #1 Phase: **Conducted po** Temperature: 26 °C
 Limit: FCC Part 24 conducted(9k-12.75G) Power: AC 110V/60Hz Humidity: 55 %
 EUT:
 M/N: 09-0088-EO
 Mode: PCS1900
 Note: CH810
 加10db衰减器

No.	Mk.	Freq.	Reading Level	Correct Factor	Measurement	Limit	Over	Detector	Comment
		MHz	dBm	dB	dBm	dBm	dB		
1	*	1910.000	-26.48	5.71	-20.77	-13.00	-7.77	peak	

*:Maximum data x:Over limit !:over margin



WCDMA Band V				
Band	Channel	Frequency (MHz)	Band Edge (dBm)	Limit (dBm)
Lower	4132	824.000	-36.02	-13
Higher	4233	849.000	-37.63	-13

Please refer to next pager of detail testing data.



Conducted Emission Measurement

File:M320(CH9262)

Data :#1

Date: 2009/5/21

Time: 上午 02:00:25

30.0 dBm

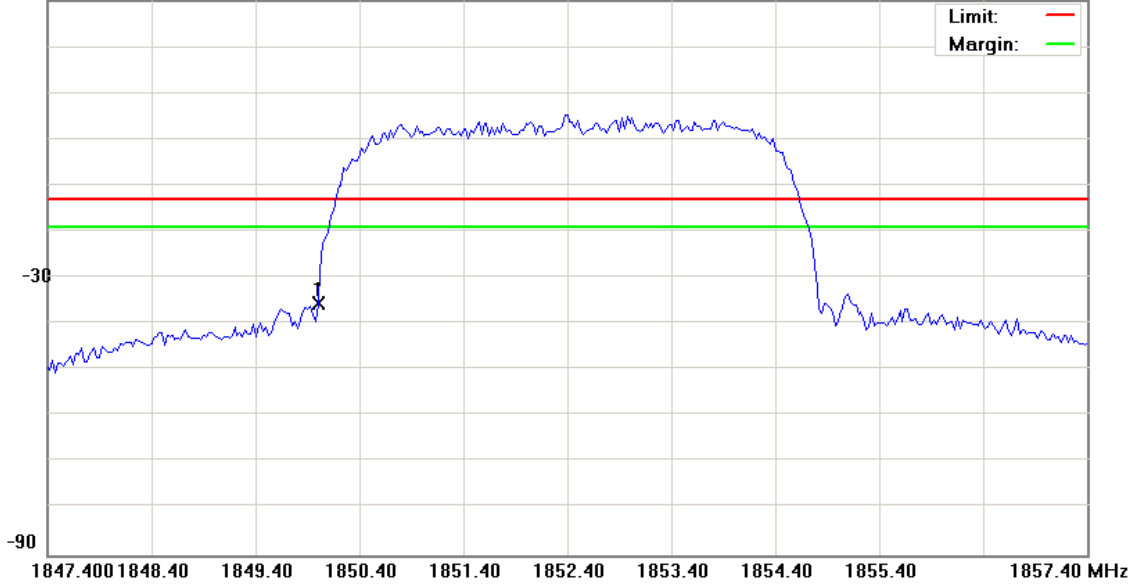

Site site #1 Phase: **Conducted po** Temperature: 26 °C
 Limit: FCC Part 24 conducted(9k-12.75G) Power: AC 110V/60Hz Humidity: 55 %
 EUT:
 M/N: 09-0088-EO
 Mode: BAND II
 Note: CH9262
 加10db衰减器

No.	Mk.	Freq.	Reading Level	Correct Factor	Measurement	Limit	Over	Detector	Comment
		MHz	dBm	dB	dBm	dBm	dB		
1	*	1850.000	-39.85	4.26	-35.59	-13.00	-22.59	peak	

*:Maximum data x:Over limit !:over margin



Conducted Emission Measurement

File:M320(CH9538)

Data :#1

Date: 2009/5/21

Time: 上午 02:02:04

30.0 dBm

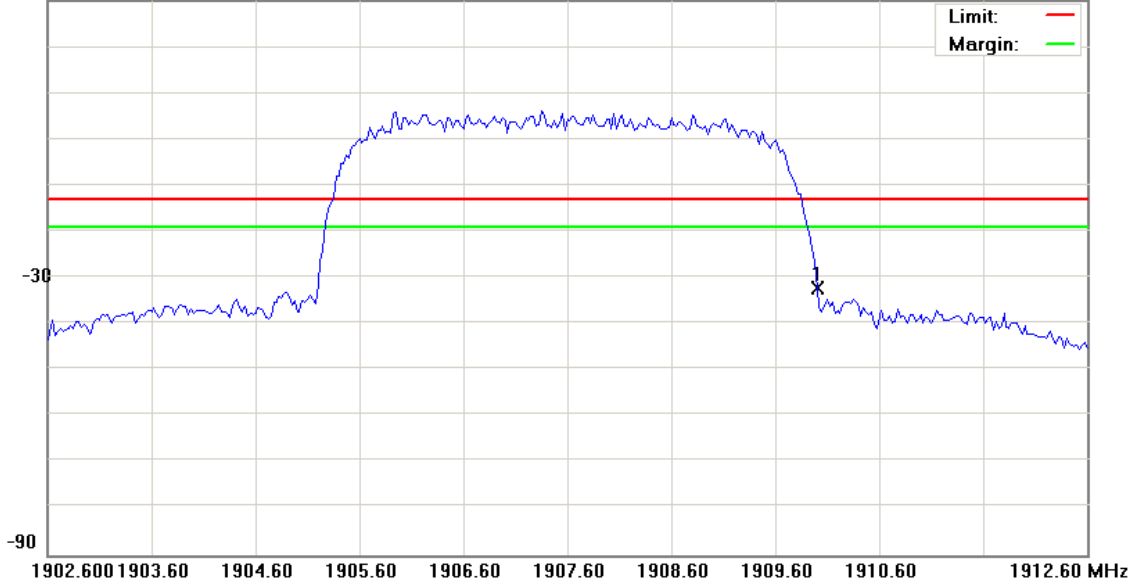

Site site #1 Phase: **Conducted po** Temperature: 26 °C
 Limit: FCC Part 24 conducted(9k-12.75G) Power: AC 110V/60Hz Humidity: 55 %
 EUT:
 M/N: 09-0088-EO
 Mode: BAND II
 Note: CH9538
 加10db衰减器

No.	Mk.	Freq. MHz	Reading Level dBm	Correct Factor dB	Measure- ment dBm	Limit dBm	Over dB	Detector	Comment
1	*	1910.000	-38.07	5.71	-32.36	-13.00	-19.36	peak	

*:Maximum data x:Over limit !:over margin



WCDMA Band II				
Band	Channel	Frequency (MHz)	Band Edge (dBm)	Limit (dBm)
Lower	9262	1850.000	-35.59	-13
Higher	9538	1910.000	-32.36	-13

Please refer to next pager of detail testing data.



Conducted Emission Measurement

File:M320(CH4132)

Data :#1

Date: 2009/5/21

Time: 上午 01:18:47

30.0 dBm

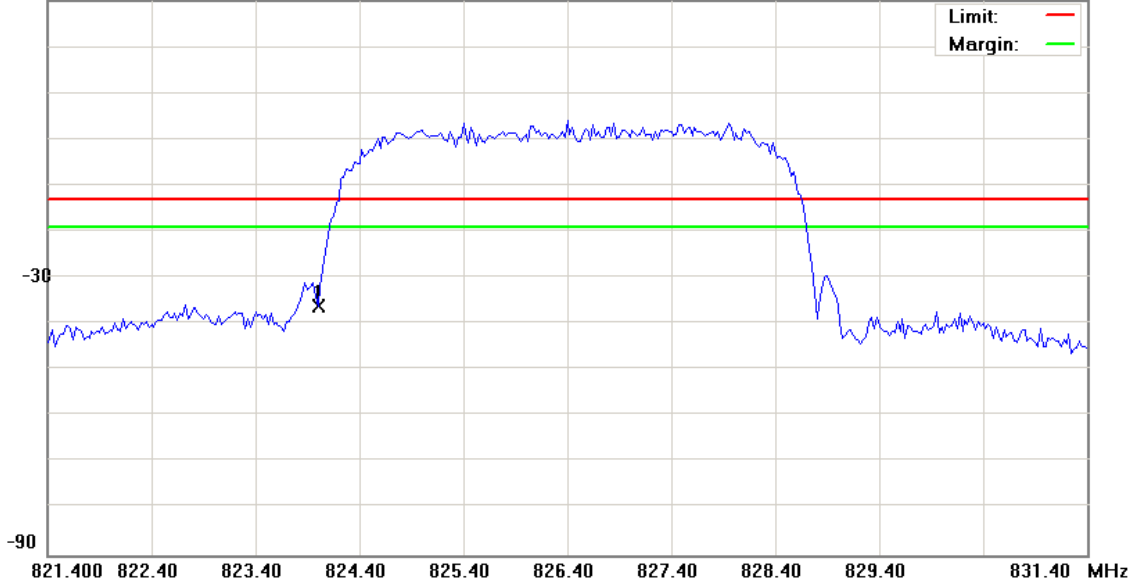

Site site #1 Phase: **Conducted po** Temperature: 26 °C
 Limit: FCC Part 22 conducted(9k-12.75G) Power: AC 110V/60Hz Humidity: 55 %
 EUT:
 M/N: 09-0088-EO
 Mode: BAND V
 Note: CH4132
 加10db衰减器

No.	Mk.	Freq.	Reading Level	Correct Factor	Measurement	Limit	Over	Detector	Comment
		MHz	dBm	dB	dBm	dBm	dB		
1	*	824.0000	-49.20	13.18	-36.02	-13.00	-23.02	peak	

*:Maximum data x:Over limit !:over margin



Conducted Emission Measurement

File:M320(CH4233)

Data :#1

Date: 2009/5/21

Time: 上午 01:20:48

30.0 dBm

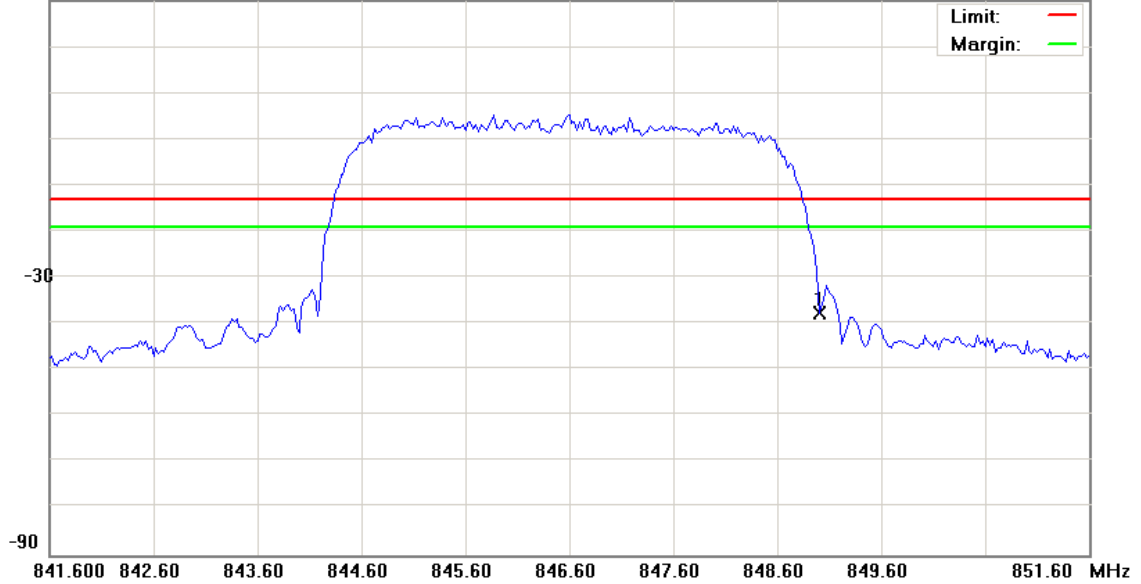

Site site #1 Phase: **Conducted po** Temperature: 26 °C
 Limit: FCC Part 22 conducted(9k-12.75G) Power: AC 110V/60Hz Humidity: 55 %
 EUT:
 M/N: 09-0088-EO
 Mode: BAND V
 Note: CH4233
 加10db衰减器

No.	Mk.	Freq. MHz	Reading Level dBm	Correct Factor dB	Measure- ment dBm	Limit dBm	Over dB	Detector	Comment
1	*	849.0000	-50.88	13.25	-37.63	-13.00	-24.63	peak	

*:Maximum data x:Over limit !:over margin

4.5 Conducted Emission

4.5.1 Measurement Instruments

As described in chapter 5 of this test report.

4.5.2 Test Procedure

1. The EUT was connected to Spectrum Analyzer and Base Station via power divider.
2. The middle channel for the highest RF power within the transmitting frequency was measured.
3. The conducted spurious emission for the whole frequency range was taken.
4. Test setting at GSM 850 RB>100 kHz, VB>100 kHz; GSM 1900 RB>1MHz, VB>1MHz.

4.5.3 Test Setup Layout

Below 2.8GHz

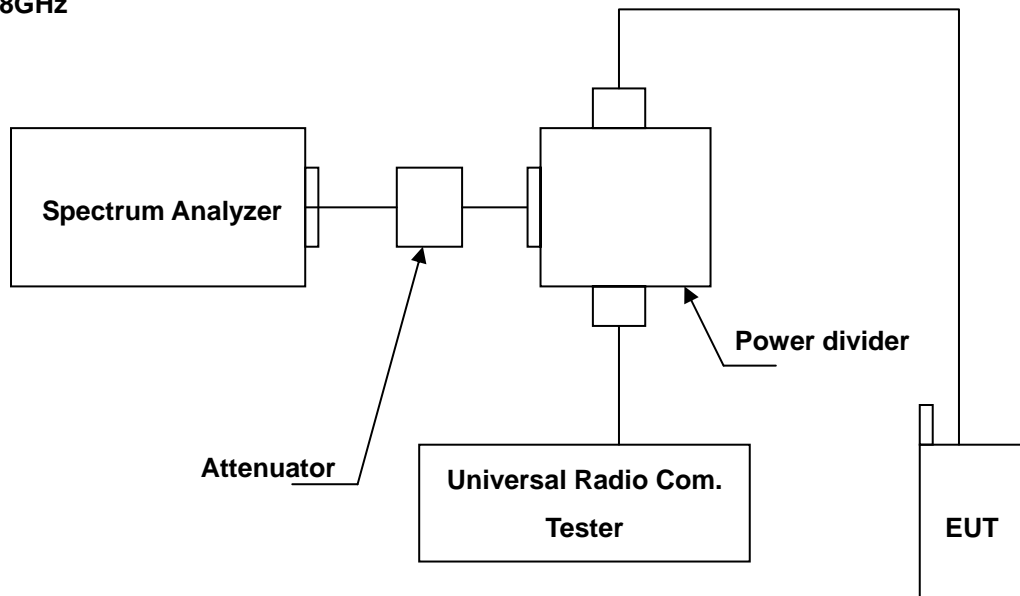

Above 2.8GHz

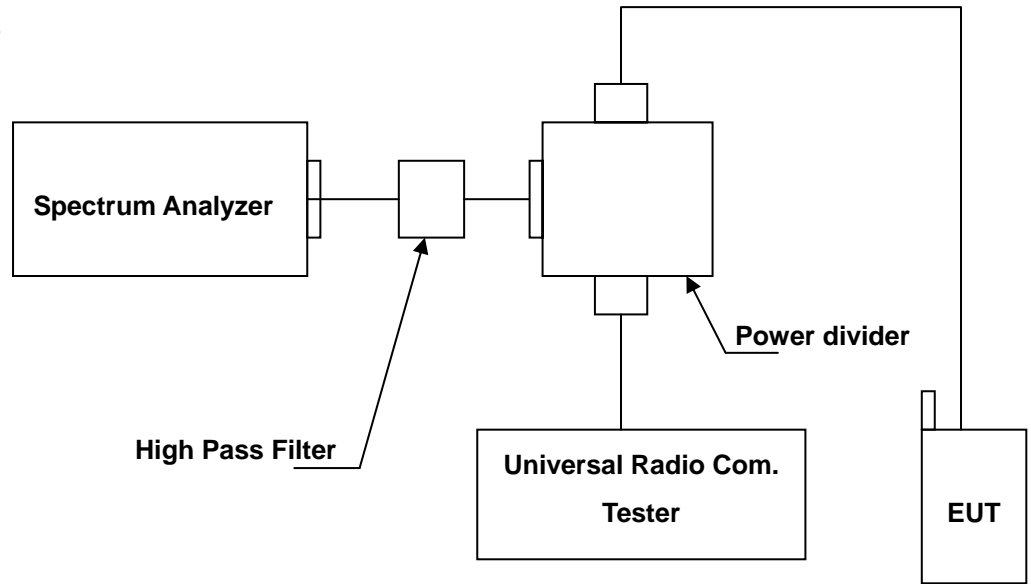



4.5.4 Test Result

4.5.4.1 GSM 850 Test Result

Applicant : Elitegroup Computer Systems Co., LTD.
Model No : M320/M320A/M320B
EUT : HSDPA mini-PCle Modem Module
Test Mode : GSM 850 (Low CH128 / Middle CH190 / High CH 251)
Test Date : 05/21/2009

Please refer to next pager of detail testing data.

Note: Amplitude= Reading Amplitude + Factor (Cable loss + Filter Amplitude= Insertion loss)
(Auto calculate in spectrum analyzer)



Conducted Emission Measurement

File :M320(CH128)

Data :#1

Date: 2009/5/21

Time: 上午 02:09:46

10.0 dBm

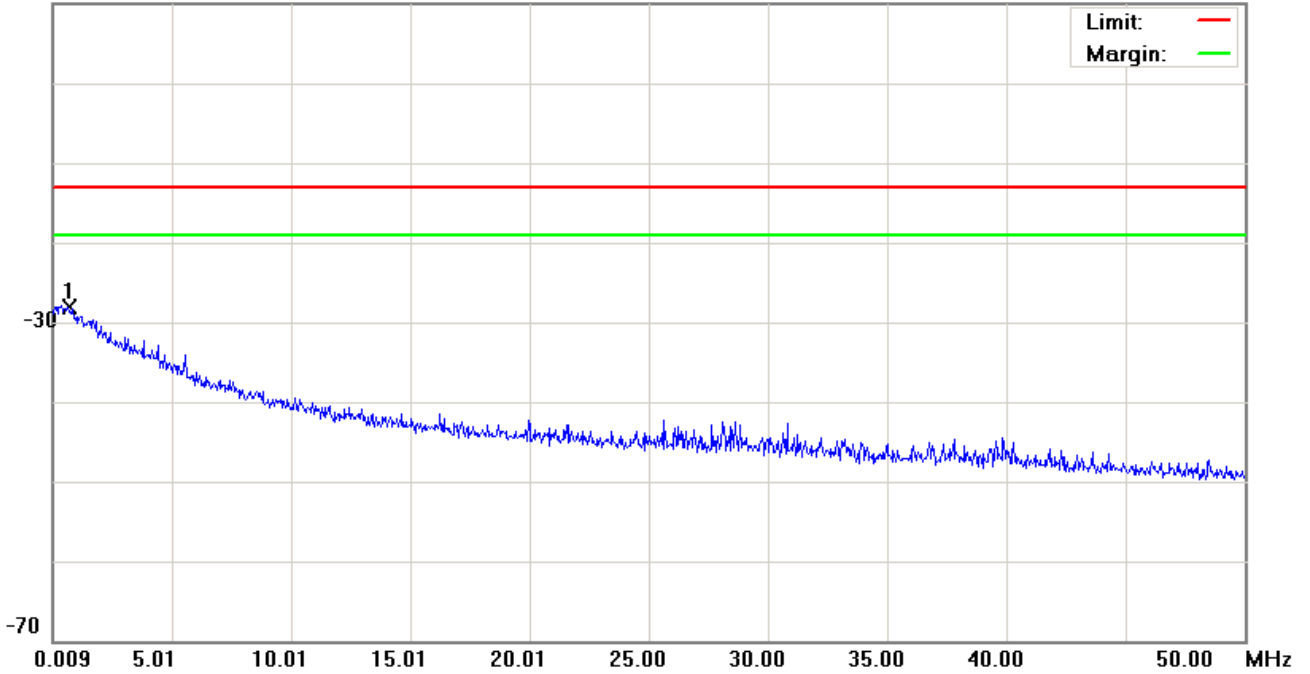

Site site #1

Phase: **Conducted po**

Temperature: 26 °C

Limit: FCC Part 22 conducted(9k-12.75G)

Power: AC 110V/60Hz

Humidity: 55 %

EUT:

M/N: 09-0088-EO

Mode: GSM850

Note: CH128

加Notch(3TNF-800)

No.	Mk.	Freq. MHz	Reading Level dBm	Correct Factor dB	Measure- ment dBm	Limit dBm	Over dB	Detector	Comment
1	*	0.6590	-59.91	31.89	-28.02	-13.00	-15.02	peak	

*:Maximum data x:Over limit !:over margin



Conducted Emission Measurement

File :M320(CH128)

Data :#2

Date: 2009/5/21

Time: 上午 02:10:11

20.0 dBm

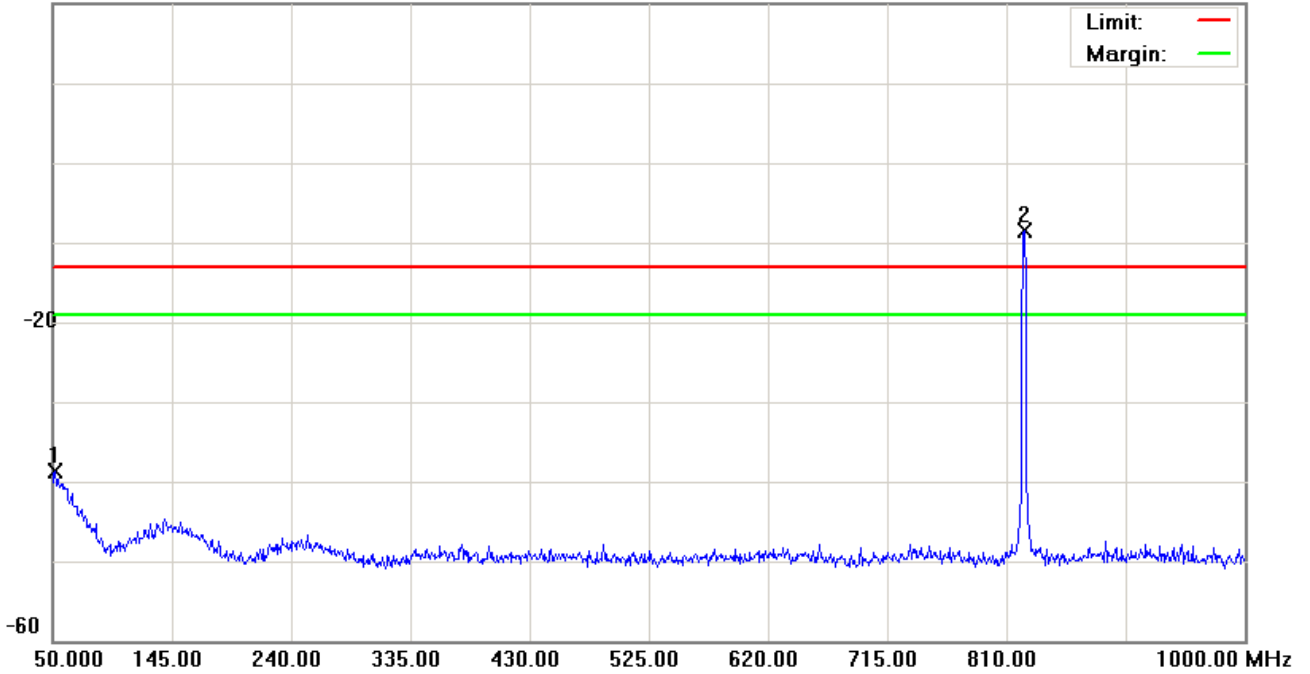

Site site #1

Phase: **Conducted po**

Temperature: 26 °C

Limit: FCC Part 22 conducted(9k-12.75G)

Power: AC 110V/60Hz

Humidity: 55 %

EUT:

M/N: 09-0088-EO

Mode: GSM850

Note: CH128

加Notch(3TNF-800)

No.	Mk.	Freq. MHz	Reading Level dBm	Correct Factor dB	Measure- ment dBm	Limit dBm	Over dB	Detector	Comment
1		51.9000	-53.03	14.36	-38.67	-13.00	-25.67	peak	
2	*	824.2500	-12.26	3.84	-8.42	-13.00	4.58	peak	Main Frequency

*:Maximum data x:Over limit !:over margin



Conducted Emission Measurement

File :M320(CH128)

Data :#3

Date: 2009/5/21

Time: 上午 02:37:51

20.0 dBm

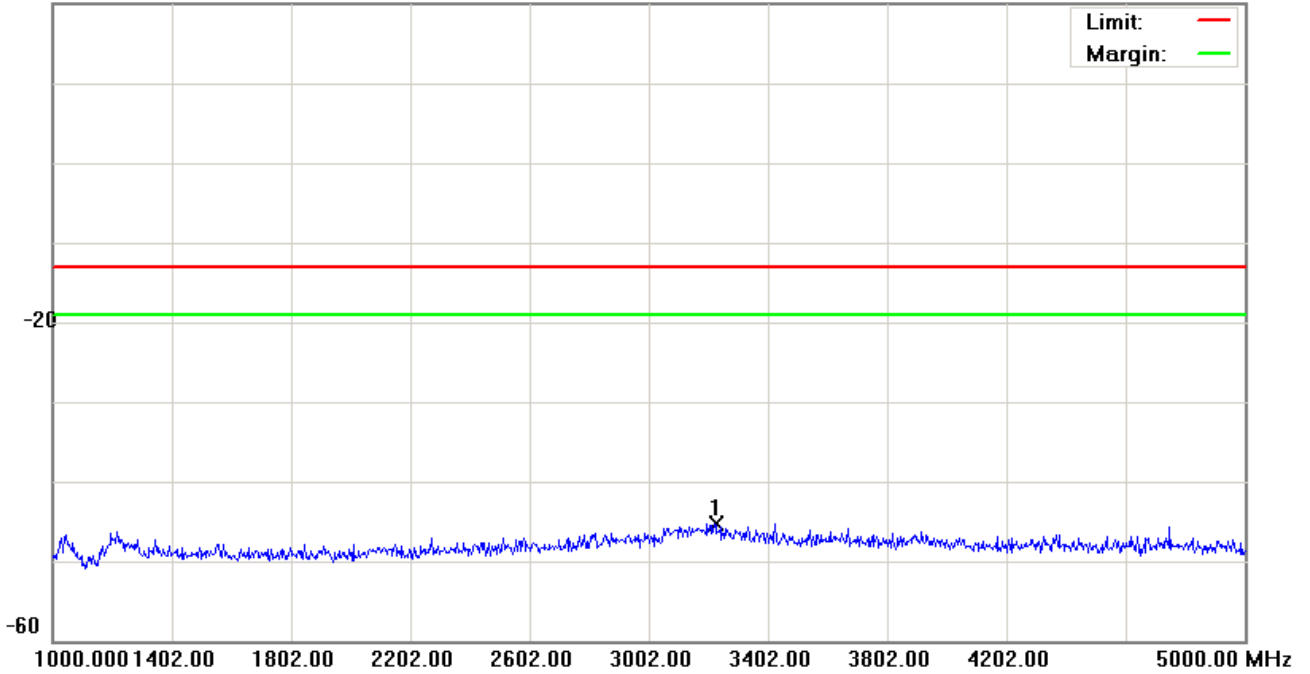

Site site #1

Phase: **Conducted po**

Temperature: 26 °C

Limit: FCC Part 22 conducted(9k-12.75G)

Power: AC 110V/60Hz

Humidity: 55 %

EUT:

M/N: 09-0088-EO

Mode: GSM850

Note: CH128

No.	Mk.	Freq. MHz	Reading Level dBm	Correct Factor dB	Measure- ment dBm	Limit dBm	Over dB	Detector	Comment
1	*	3222.000	-49.90	4.68	-45.22	-13.00	-32.22	peak	

*:Maximum data x:Over limit !:over margin



Conducted Emission Measurement

File :M320(CH128)

Data :#4

Date: 2009/5/21

Time: 上午 02:38:14

20.0 dBm

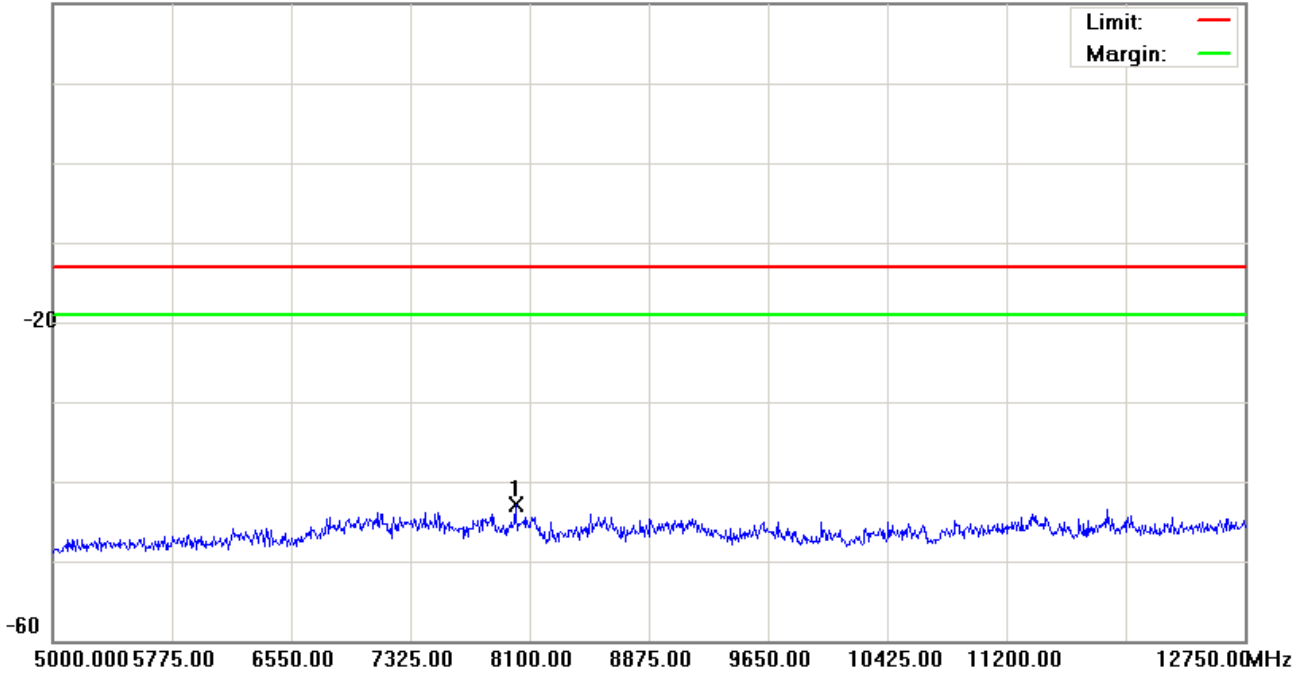

Site site #1

Phase: **Conducted po**

Temperature: 26 °C

Limit: FCC Part 22 conducted(9k-12.75G)

Power: AC 110V/60Hz

Humidity: 55 %

EUT:

M/N: 09-0088-EO

Mode: GSM850

Note: CH128

No.	Mk.	Freq. MHz	Reading Level dBm	Correct Factor dB	Measure- ment dBm	Limit dBm	Over dB	Detector	Comment
1	*	8007.000	-48.34	5.53	-42.81	-13.00	-29.81	peak	

*:Maximum data x:Over limit !:over margin



Conducted Emission Measurement

File :M320(CH190)

Data :#1

Date: 2009/5/21

Time: 上午 02:12:15

10.0 dBm

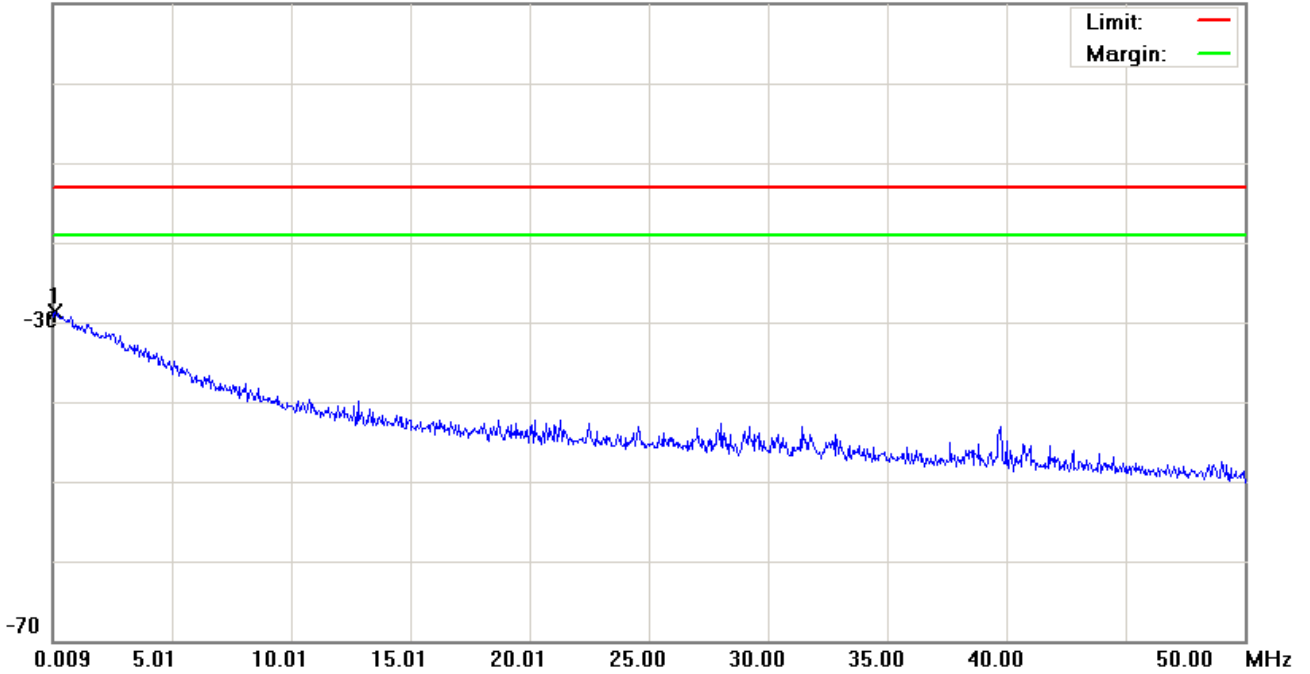

Site site #1

Phase: **Conducted po**

Temperature: 26 °C

Limit: FCC Part 22 conducted(9k-12.75G)

Power: AC 110V/60Hz

Humidity: 55 %

EUT:

M/N: 09-0088-EO

Mode: GSM850

Note: CH190

加Notch(3TNF-800)

No.	Mk.	Freq. MHz	Reading Level dBm	Correct Factor dB	Measure- ment dBm	Limit dBm	Over dB	Detector	Comment
1	*	0.1090	-58.95	30.17	-28.78	-13.00	-15.78	peak	

*:Maximum data x:Over limit !:over margin



Conducted Emission Measurement

File :M320(CH190)

Data :#2

Date: 2009/5/21

Time: 上午 02:12:40

20.0 dBm

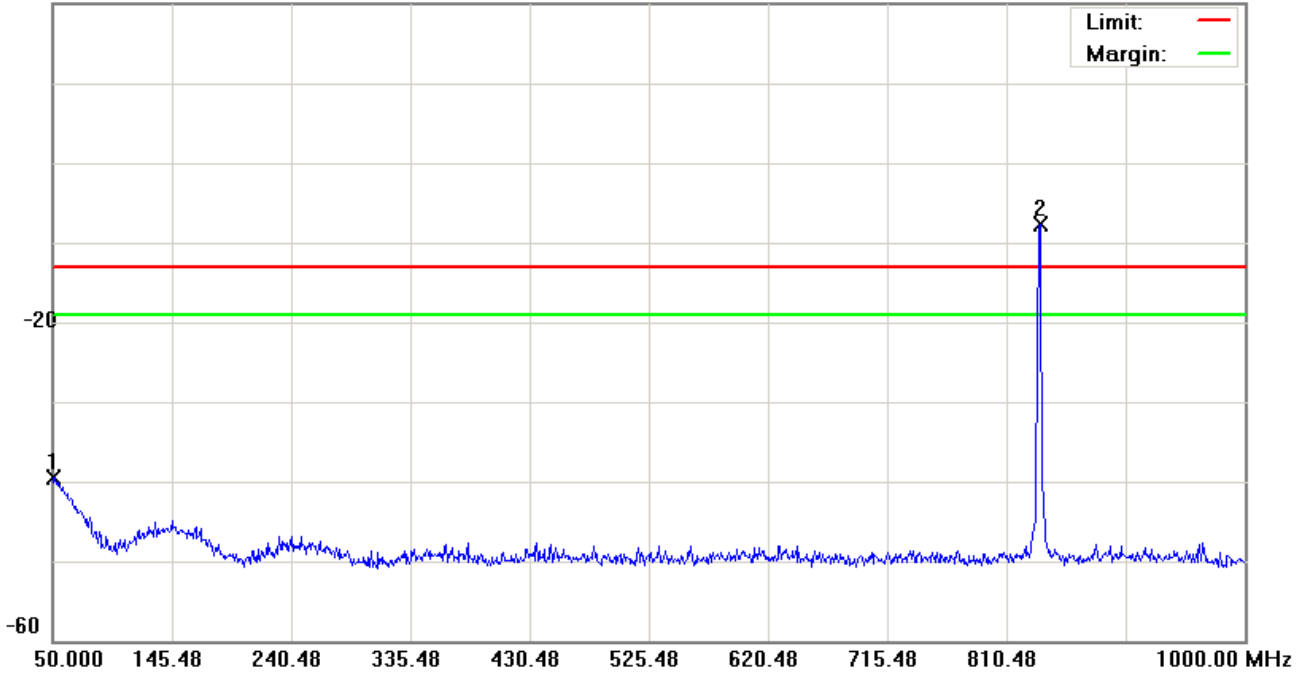

Site site #1

Phase: **Conducted po**

Temperature: 26 °C

Limit: FCC Part 22 conducted(9k-12.75G)

Power: AC 110V/60Hz

Humidity: 55 %

EUT:

M/N: 09-0088-EO

Mode: GSM850

Note: CH190

加Notch(3TNF-800)

No.	Mk.	Freq. MHz	Reading Level dBm	Correct Factor dB	Measure- ment dBm	Limit dBm	Over dB	Detector	Comment
1		50.4750	-54.07	14.61	-39.46	-13.00	-26.46	peak	
2	*	836.6000	-11.71	3.96	-7.75	-13.00	5.25	peak	Main Frequency

*:Maximum data x:Over limit !:over margin



Conducted Emission Measurement

File :M320(CH190)

Data :#3

Date: 2009/5/21

Time: 上午 02:38:56

20.0 dBm

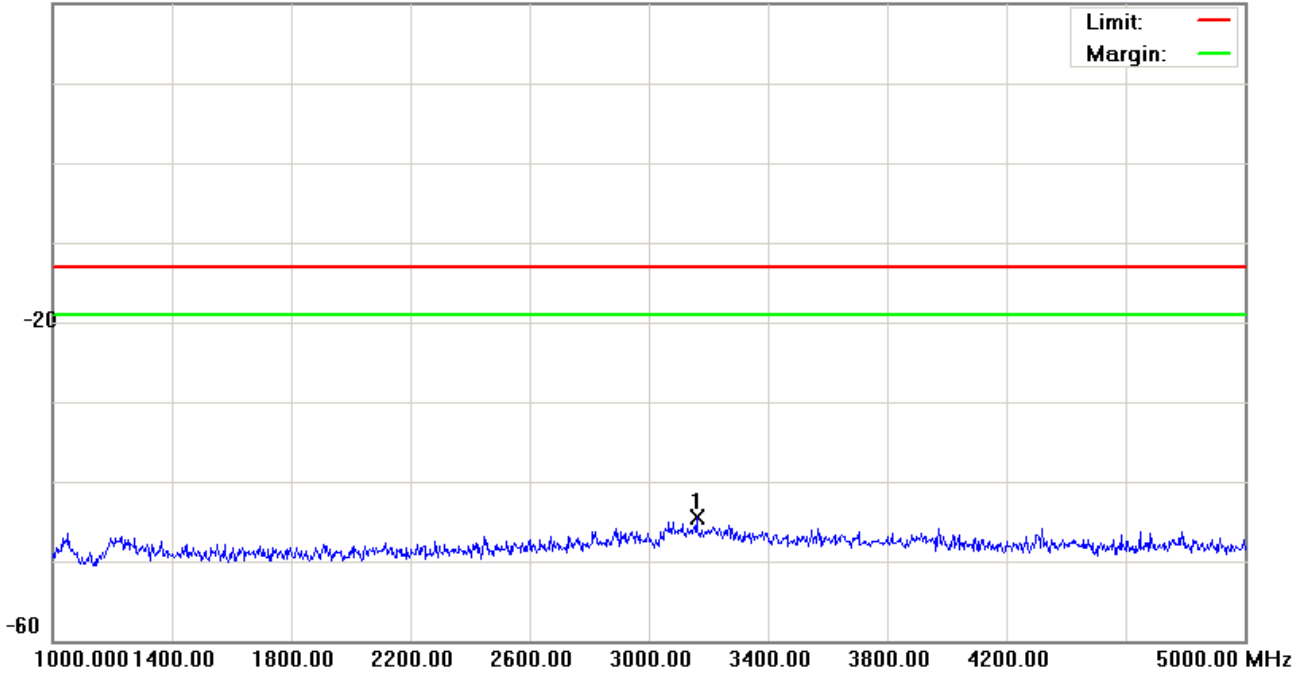

Site site #1

Phase: **Conducted po**

Temperature: 26 °C

Limit: FCC Part 22 conducted(9k-12.75G)

Power: AC 110V/60Hz

Humidity: 55 %

EUT:

M/N: 09-0088-EO

Mode: GSM850

Note: CH190

No.	Mk.	Freq. MHz	Reading Level dBm	Correct Factor dB	Measure- ment dBm	Limit dBm	Over dB	Detector	Comment
1	*	3162.000	-49.06	4.58	-44.48	-13.00	-31.48	peak	

*:Maximum data x:Over limit !:over margin



Conducted Emission Measurement

File :M320(CH190)

Data :#4

Date: 2009/5/21

Time: 上午 02:39:20

20.0 dBm

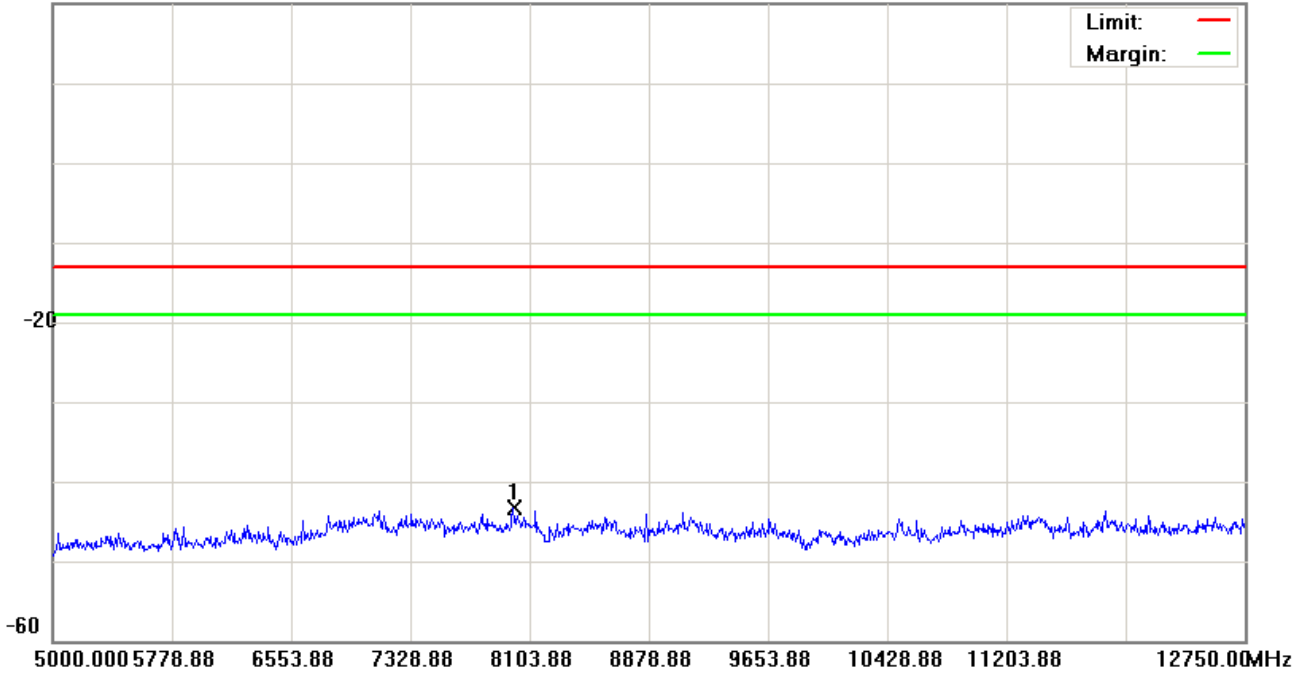

Site site #1

Phase: **Conducted po**

Temperature: 26 °C

Limit: FCC Part 22 conducted(9k-12.75G)

Power: AC 110V/60Hz

Humidity: 55 %

EUT:

M/N: 09-0088-EO

Mode: GSM850

Note: CH190

No.	Mk.	Freq. MHz	Reading Level dBm	Correct Factor dB	Measure- ment dBm	Limit dBm	Over dB	Detector	Comment
1	*	7995.375	-48.85	5.53	-43.32	-13.00	-30.32	peak	

*:Maximum data x:Over limit !:over margin



Conducted Emission Measurement

File :M320(CH251)

Data :#1

Date: 2009/5/21

Time: 上午 02:17:01

10.0 dBm

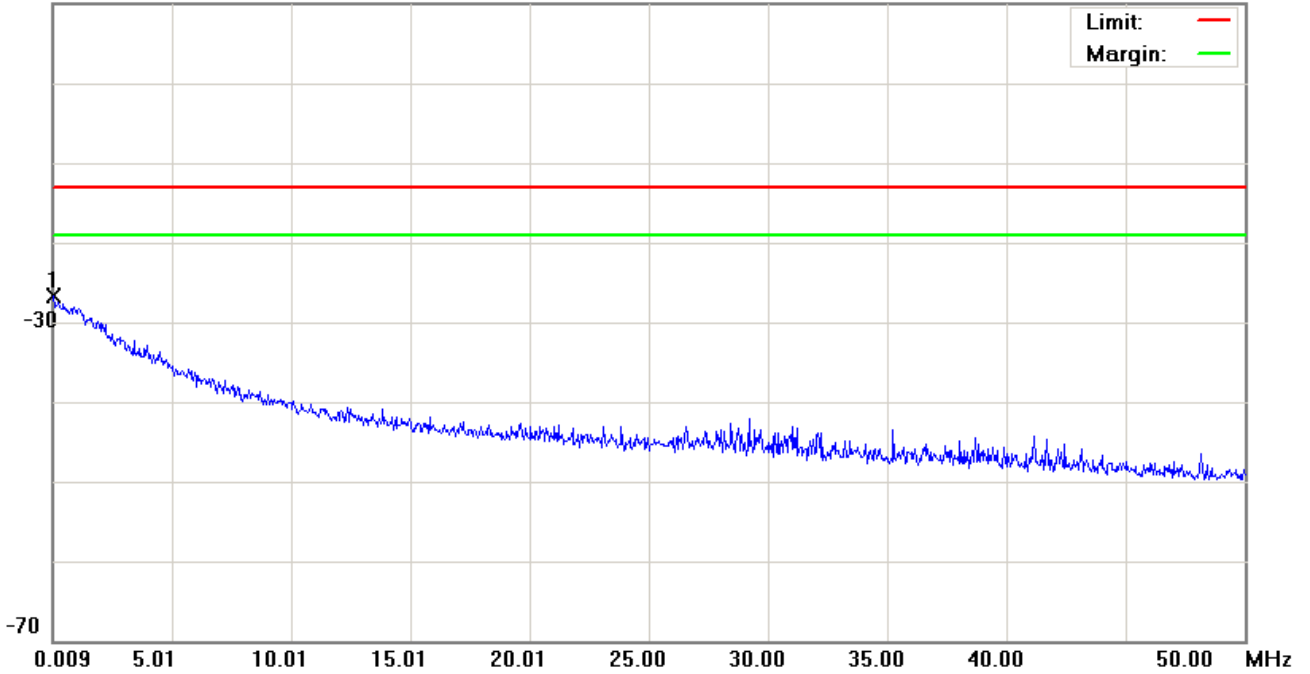

Site site #1

Phase: **Conducted po**

Temperature: 26 °C

Limit: FCC Part 22 conducted(9k-12.75G)

Power: AC 110V/60Hz

Humidity: 55 %

EUT:

M/N: 09-0088-EO

Mode: GSM850

Note: CH251

加Notch(3TNF-800)

No.	Mk.	Freq. MHz	Reading Level dBm	Correct Factor dB	Measure- ment dBm	Limit dBm	Over dB	Detector	Comment
1	*	0.0590	-57.12	30.37	-26.75	-13.00	-13.75	peak	

*:Maximum data x:Over limit !:over margin



Conducted Emission Measurement

File :M320(CH251)

Data :#2

Date: 2009/5/21

Time: 上午 02:17:25

20.0 dBm

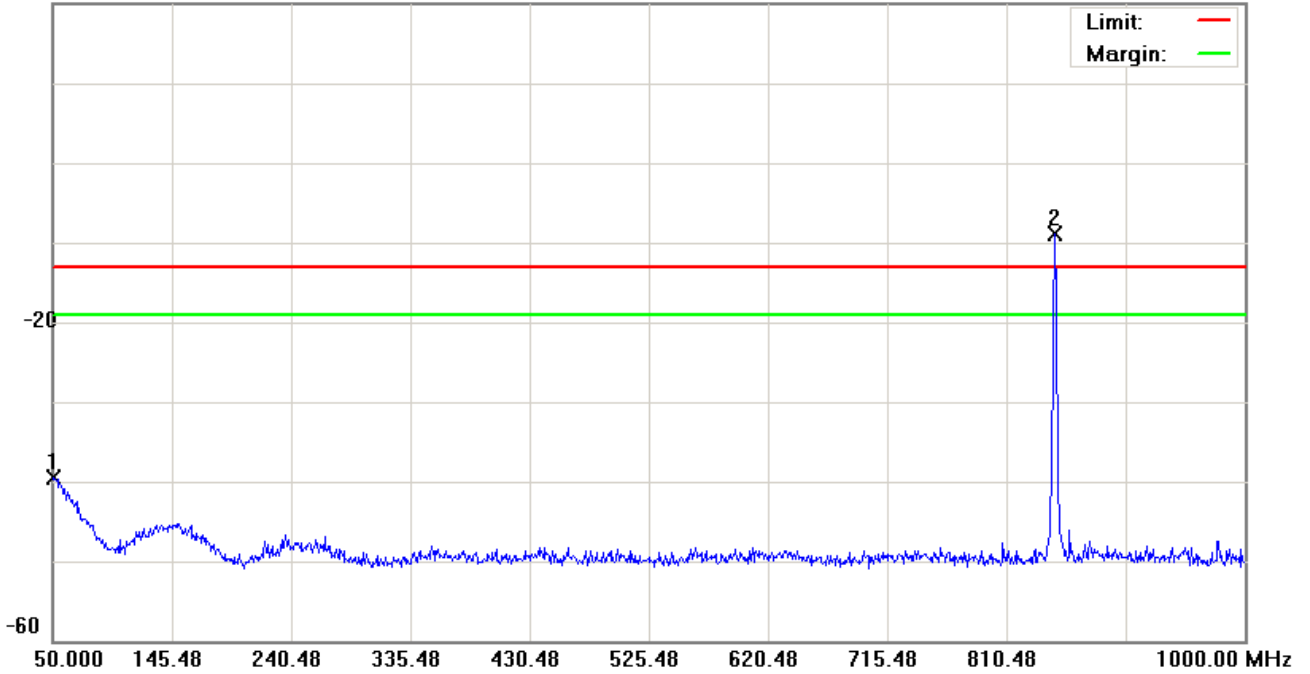

Site site #1

Phase: **Conducted po**

Temperature: 26 °C

Limit: FCC Part 22 conducted(9k-12.75G)

Power: AC 110V/60Hz

Humidity: 55 %

EUT:

M/N: 09-0088-EO

Mode: GSM850

Note: CH251

加Notch(3TNF-800)

No.	Mk.	Freq. MHz	Reading Level dBm	Correct Factor dB	Measure- ment dBm	Limit dBm	Over dB	Detector	Comment
1		50.4750	-54.19	14.61	-39.58	-13.00	-26.58	peak	
2	*	848.9500	-12.79	3.98	-8.81	-13.00	4.19	peak	Main Frequency

*:Maximum data x:Over limit !:over margin



Conducted Emission Measurement

File :M320(CH251)

Data :#3

Date: 2009/5/21

Time: 上午 02:40:27

20.0 dBm

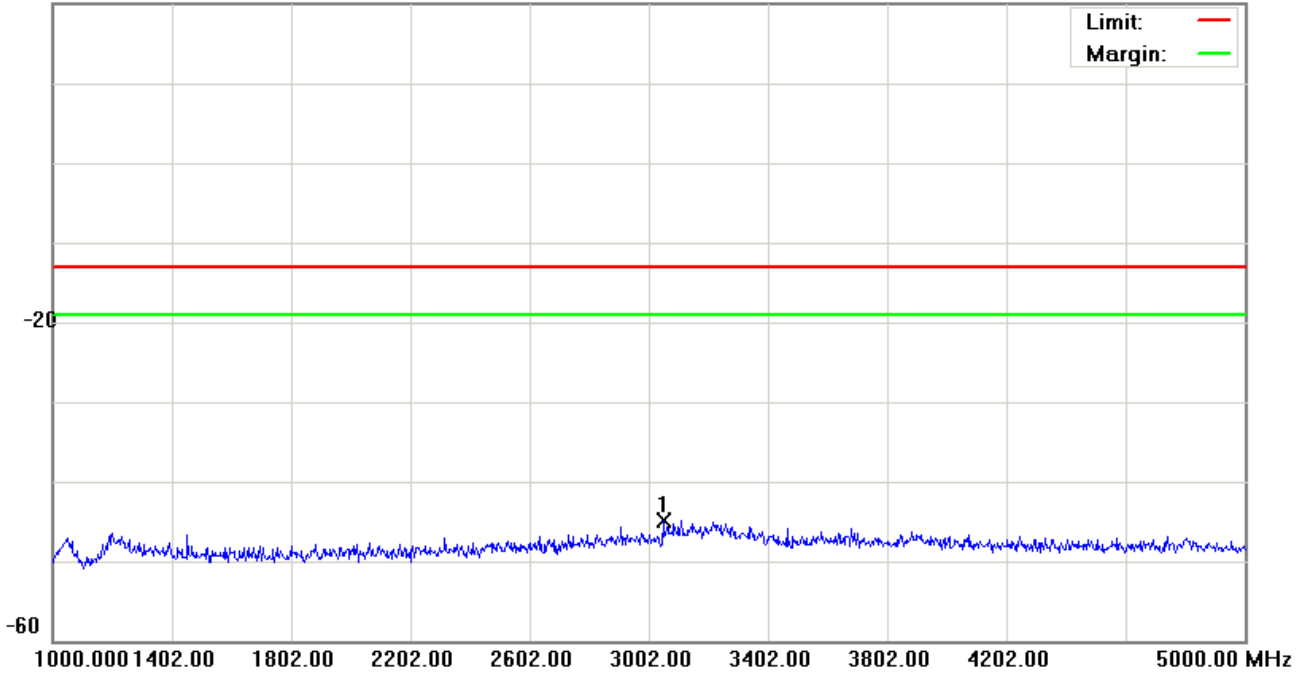

Site site #1

Phase: **Conducted po**

Temperature: 26 °C

Limit: FCC Part 22 conducted(9k-12.75G)

Power: AC 110V/60Hz

Humidity: 55 %

EUT:

M/N: 09-0088-EO

Mode: GSM850

Note: CH251

No.	Mk.	Freq. MHz	Reading Level dBm	Correct Factor dB	Measure- ment dBm	Limit dBm	Over dB	Detector	Comment
1	*	3050.000	-49.28	4.31	-44.97	-13.00	-31.97	peak	

*:Maximum data x:Over limit !:over margin



Conducted Emission Measurement

File :M320(CH251)

Data :#4

Date: 2009/5/21

Time: 上午 02:40:51

20.0 dBm

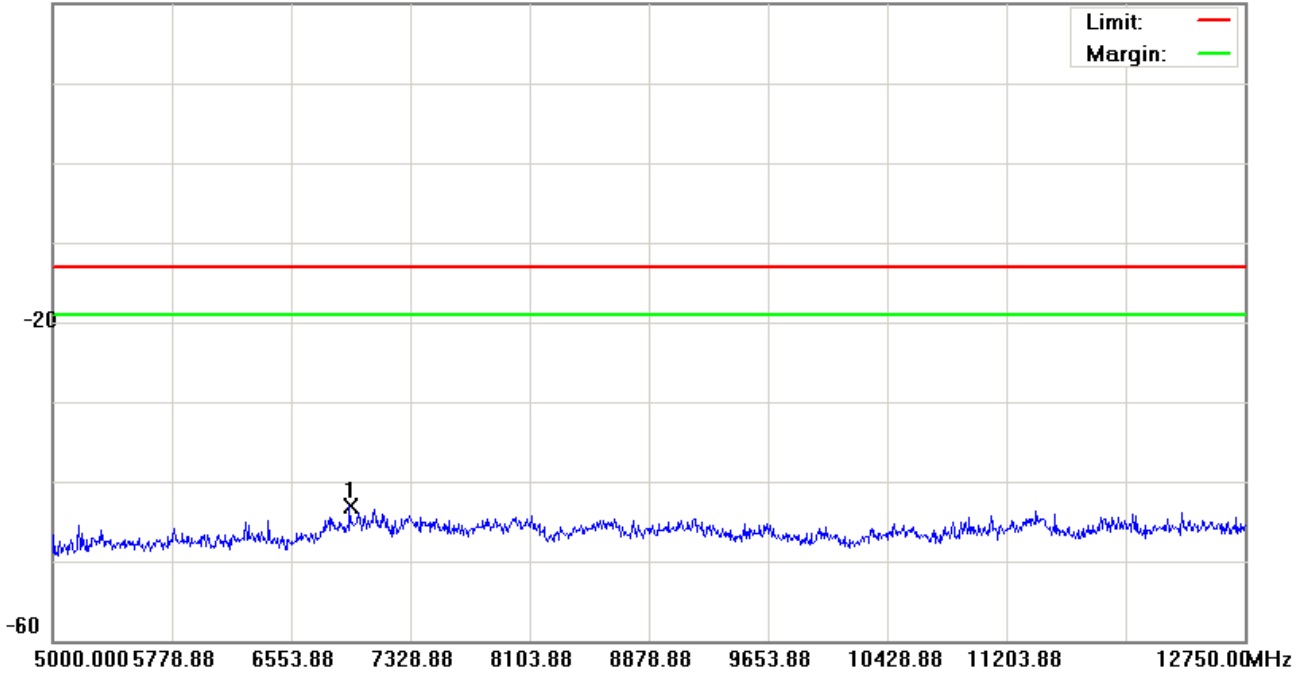

Site site #1

Phase: **Conducted po**

Temperature: 26 °C

Limit: FCC Part 22 conducted(9k-12.75G)

Power: AC 110V/60Hz

Humidity: 55 %

EUT:

M/N: 09-0088-EO

Mode: GSM850

Note: CH251

No.	Mk.	Freq. MHz	Reading Level dBm	Correct Factor dB	Measure- ment dBm	Limit dBm	Over dB	Detector	Comment
1	*	6933.625	-48.28	5.09	-43.19	-13.00	-30.19	peak	

*:Maximum data x:Over limit !:over margin



4.5.4.2 GSM 1900 Test Result

Applicant : Elitegroup Computer Systems Co., LTD.
Model No : M320/M320A/M320B
EUT : HSDPA mini-PCle Modem Module
Test Mode : GSM 1900 (Low CH512 / Middle CH661 / High CH 810)
Test Date : 05/21/2009

Please refer to next pager of detail testing data.

Note: Amplitude= Reading Amplitude + Factor (Cable loss + Filter Amplitude= Insertion loss)
(Auto calculate in spectrum analyzer)



Conducted Emission Measurement

File :M320(CH512)

Data :#1

Date: 2009/5/21

Time: 上午 01:40:23

10.0 dBm

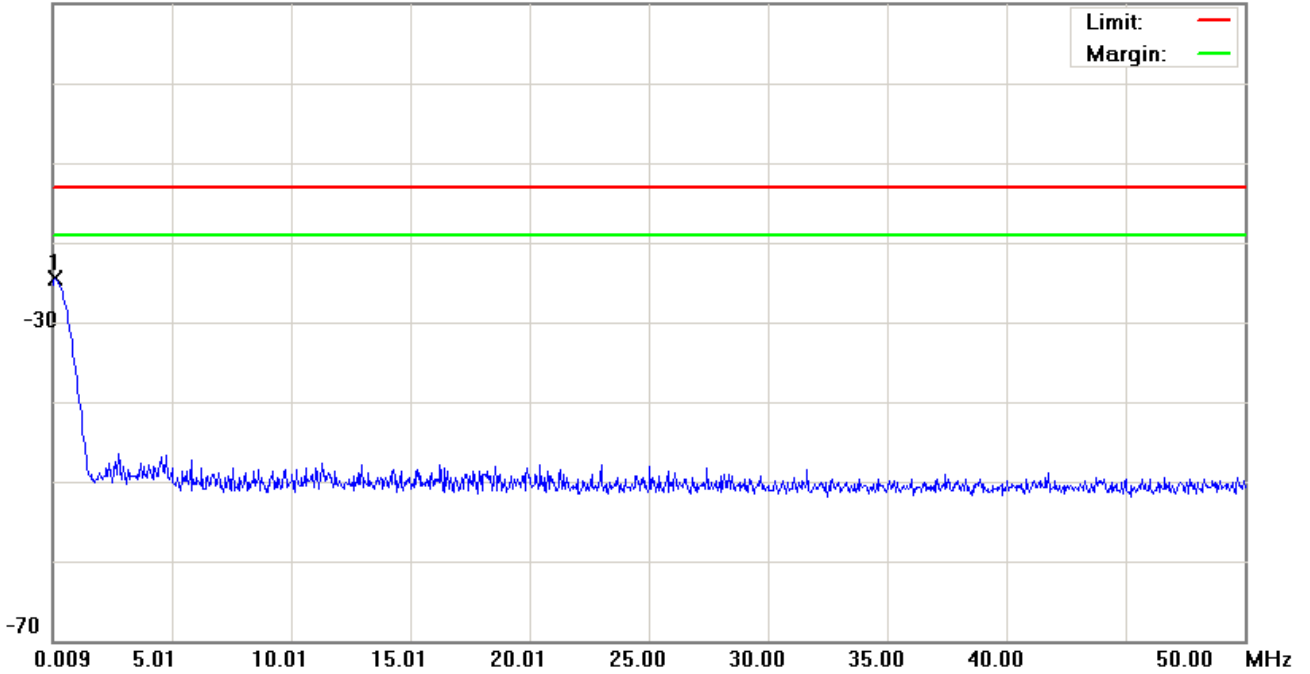

Site site #1

Phase: **Conducted po**

Temperature: 26 °C

Limit: FCC Part 24 conducted(9k-12.75G)

Power: AC 110V/60Hz

Humidity: 55 %

EUT:

M/N: 09-0088-EO

Mode: PCS1900

Note: CH512

加10db衰減器

No.	Mk.	Freq. MHz	Reading Level dBm	Correct Factor dB	Measure- ment dBm	Limit dBm	Over dB	Detector	Comment
1	*	0.1090	-37.04	12.49	-24.55	-13.00	-11.55	peak	

*:Maximum data x:Over limit !:over margin



Conducted Emission Measurement

File :M320(CH512)

Data :#2

Date: 2009/5/21

Time: 上午 01:40:47

20.0 dBm

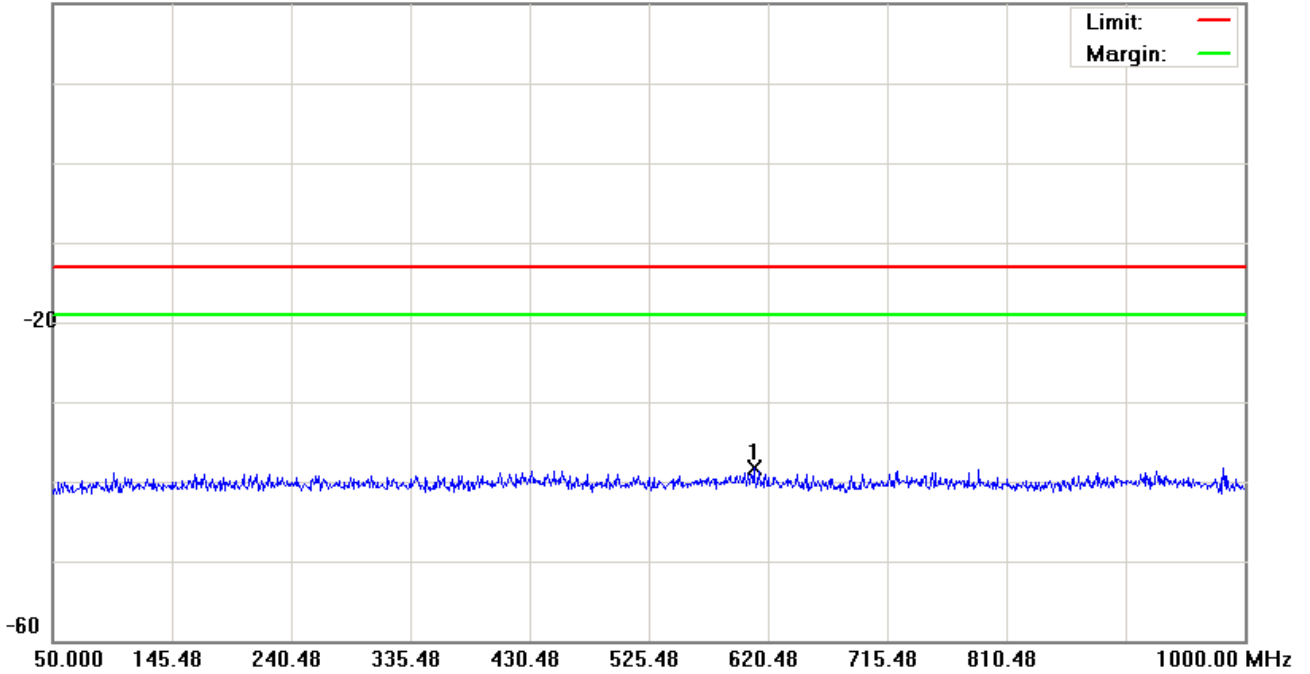

Site site #1

Phase: **Conducted po**

Temperature: 26 °C

Limit: FCC Part 24 conducted(9k-12.75G)

Power: AC 110V/60Hz

Humidity: 55 %

EUT:

M/N: 09-0088-EO

Mode: PCS1900

Note: CH512

加10db衰減器

No.	Mk.	Freq. MHz	Reading Level dBm	Correct Factor dB	Measure- ment dBm	Limit dBm	Over dB	Detector	Comment
1	*	608.6000	-51.41	13.17	-38.24	-13.00	-25.24	peak	

*:Maximum data x:Over limit !:over margin



Conducted Emission Measurement

File :M320(CH512)

Data :#3

Date: 2009/5/21

Time: 上午 03:05:28

20.0 dBm

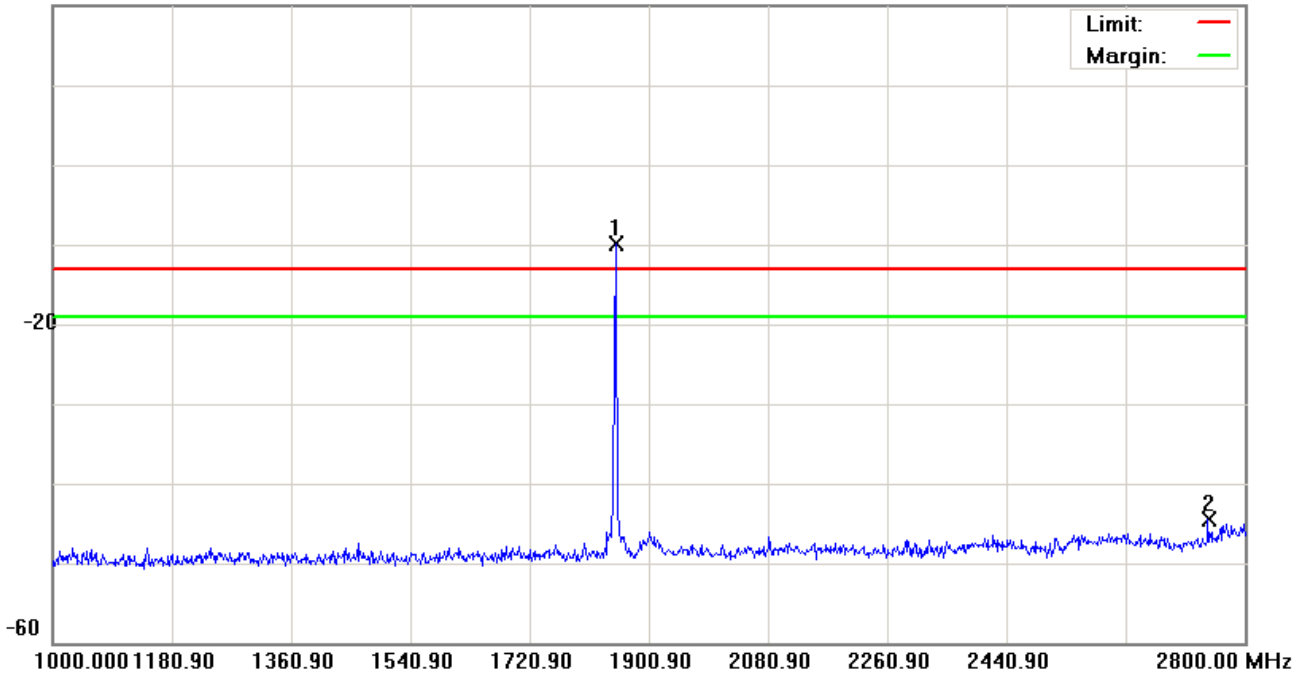

Site site #1

Phase: **Conducted po**

Temperature: 26 °C

Limit: FCC Part 24 conducted(9k-12.75G)

Power: AC 110V/60Hz

Humidity: 55 %

EUT:

M/N: 09-0088-EO

Mode: PCS1900

Note: CH512

加Notch(5TNF-1700)

No.	Mk.	Freq. MHz	Reading Level dBm	Correct Factor dB	Measure- ment dBm	Limit dBm	Over dB	Detector	Comment
1	*	1850.500	-14.25	4.26	-9.99	-13.00	3.01	peak	Main Frequency
2		2745.100	-49.67	5.26	-44.41	-13.00	-31.41	peak	

*:Maximum data x:Over limit !:over margin



Conducted Emission Measurement

File :M320(CH512)

Data :#4

Date: 2009/5/21

Time: 上午 02:53:19

20.0 dBm

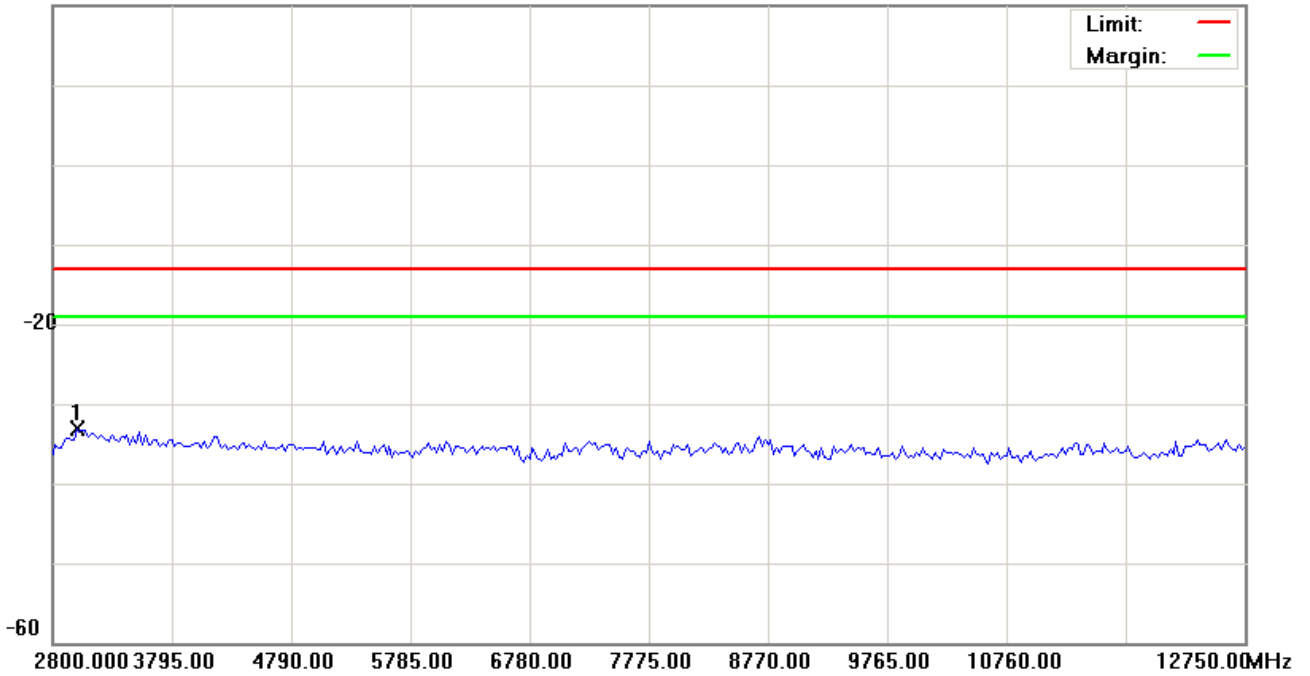

Site site #1

Phase: **Conducted po**

Temperature: 26 °C

Limit: FCC Part 24 conducted(9k-12.75G)

Power: AC 110V/60Hz

Humidity: 55 %

EUT:

M/N: 09-0088-EO

Mode: PCS1900

Note: CH512

No.	Mk.	Freq. MHz	Reading Level dBm	Correct Factor dB	Measure- ment dBm	Limit dBm	Over dB	Detector	Comment
1	*	2999.000	-38.60	5.48	-33.12	-13.00	-20.12	peak	

*:Maximum data x:Over limit !:over margin



Conducted Emission Measurement

File :M320(CH512)

Data :#5

Date: 2009/5/21

Time: 上午 02:53:40

20.0 dBm

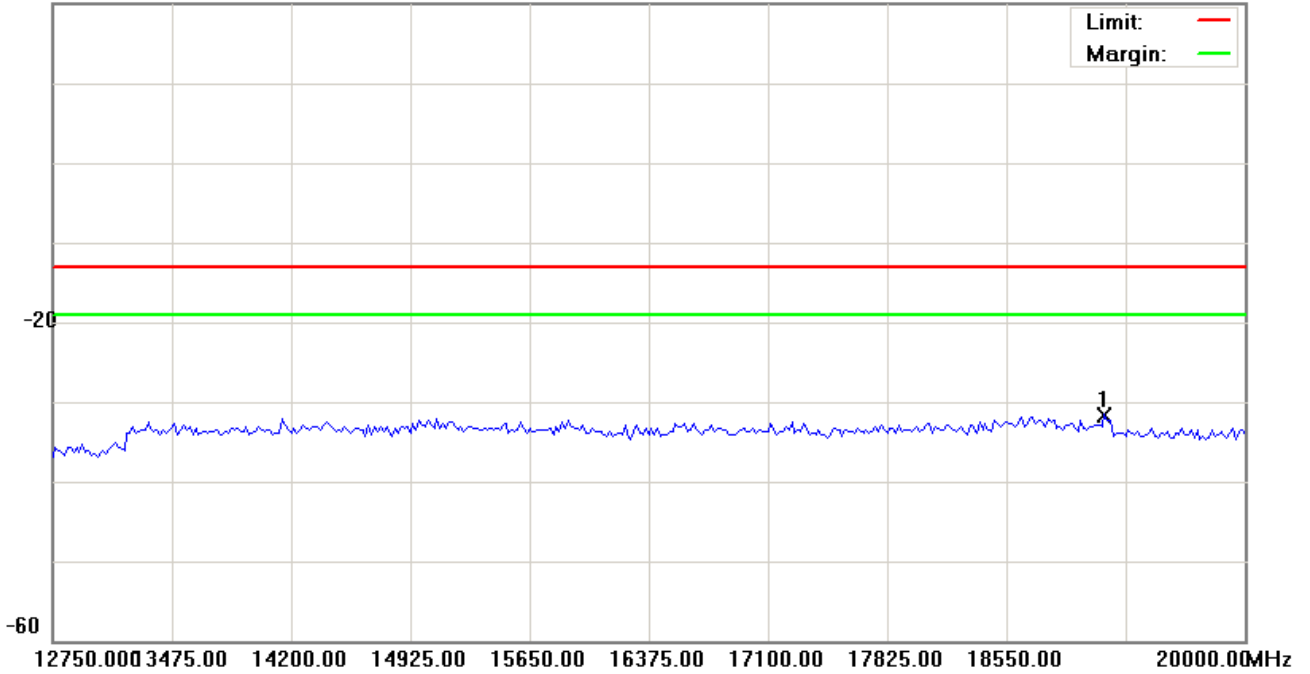

Site site #1

Phase: **Conducted po**

Temperature: 26 °C

Limit: FCC Part 24 conducted(9k-12.75G)

Power: AC 110V/60Hz

Humidity: 55 %

EUT:

M/N: 09-0088-EO

Mode: PCS1900

Note: CH512

No.	Mk.	Freq. MHz	Reading Level dBm	Correct Factor dB	Measure- ment dBm	Limit dBm	Over dB	Detector	Comment
1	*	19148.12	-38.80	7.20	-31.60	-13.00	-18.60	peak	

*:Maximum data x:Over limit !:over margin



Conducted Emission Measurement

File :M320(CH610)

Data :#1

Date: 2009/5/21

Time: 上午 01:41:56

10.0 dBm

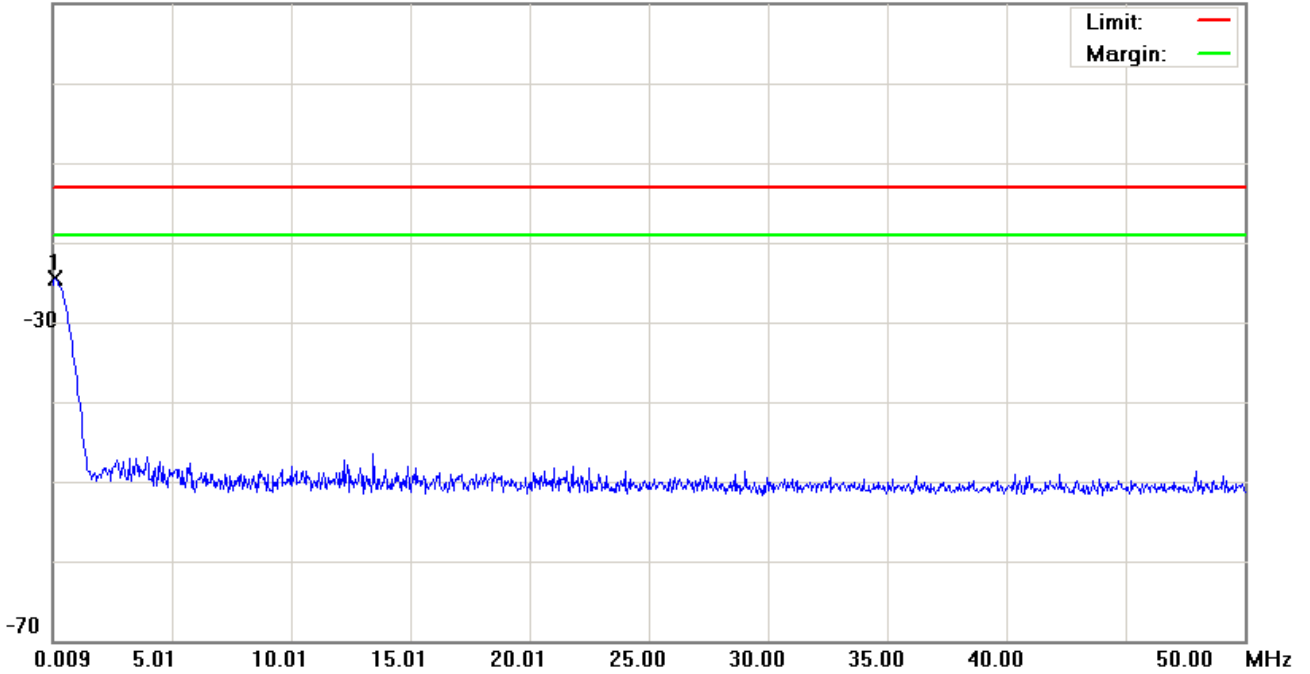

Site site #1

Phase: **Conducted po**

Temperature: 26 °C

Limit: FCC Part 24 conducted(9k-12.75G)

Power: AC 110V/60Hz

Humidity: 55 %

EUT:

M/N: 09-0088-EO

Mode: PCS1900

Note: CH610

加10db衰減器

No.	Mk.	Freq. MHz	Reading Level dBm	Correct Factor dB	Measure- ment dBm	Limit dBm	Over dB	Detector	Comment
1	*	0.1090	-37.05	12.49	-24.56	-13.00	-11.56	peak	

*:Maximum data x:Over limit !:over margin



Conducted Emission Measurement

File :M320(CH610)

Data :#2

Date: 2009/5/21

Time: 上午 01:42:21

20.0 dBm

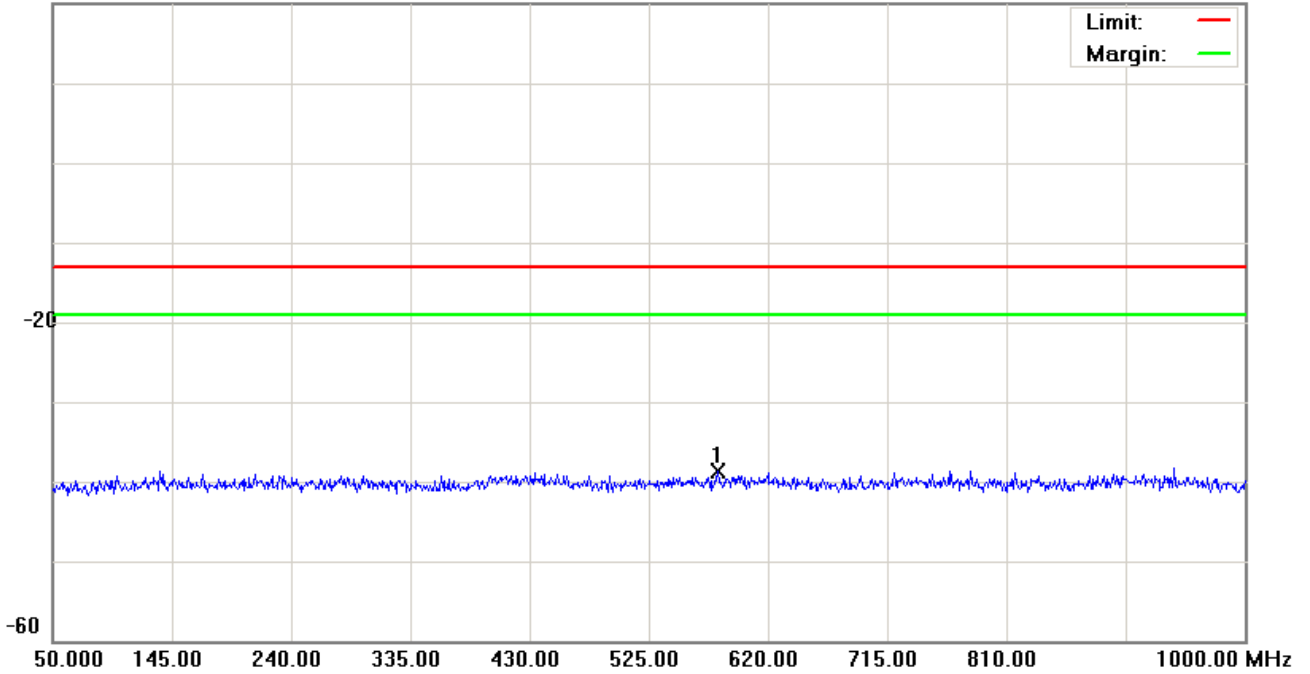

Site site #1

Phase: **Conducted po**

Temperature: 26 °C

Limit: FCC Part 24 conducted(9k-12.75G)

Power: AC 110V/60Hz

Humidity: 55 %

EUT:

M/N: 09-0088-EO

Mode: PCS1900

Note: CH610

加10db衰減器

No.	Mk.	Freq. MHz	Reading Level dBm	Correct Factor dB	Measure- ment dBm	Limit dBm	Over dB	Detector	Comment
1	*	580.1000	-51.85	13.16	-38.69	-13.00	-25.69	peak	

*:Maximum data x:Over limit !:over margin



Conducted Emission Measurement

File :M320(CH610)

Data :#3

Date: 2009/5/21

Time: 上午 03:06:46

20.0 dBm

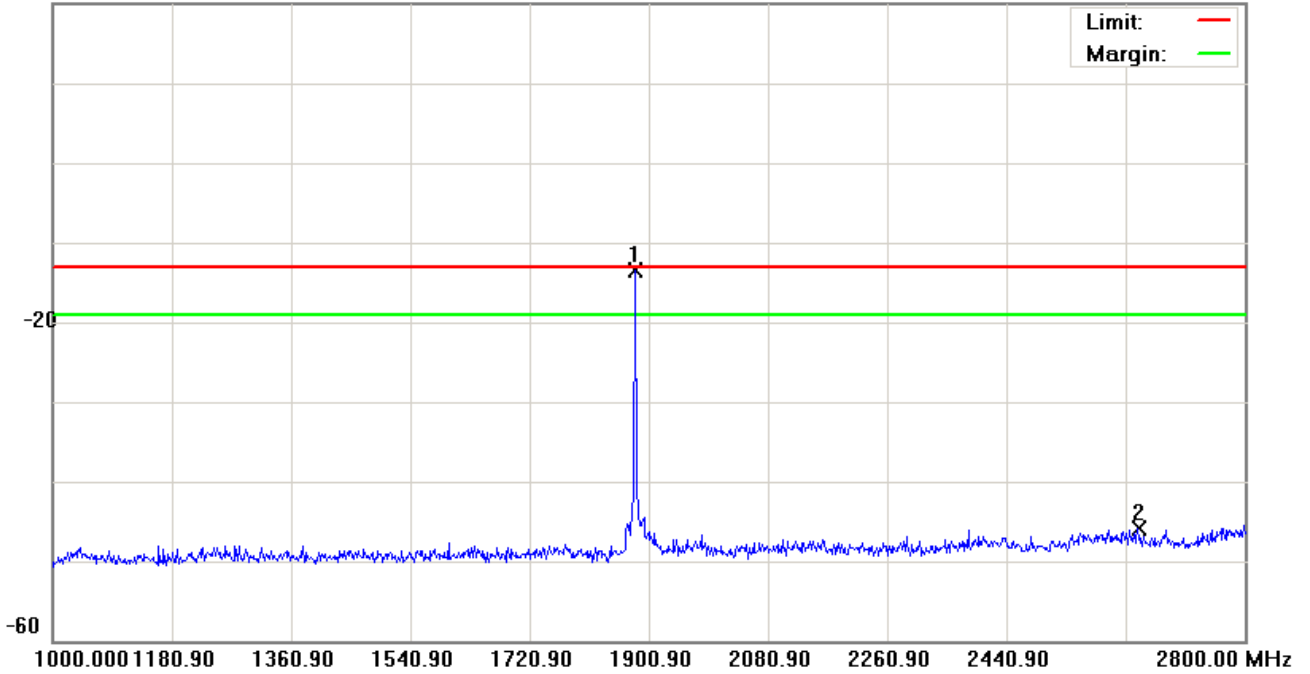

Site site #1

Phase: **Conducted po**

Temperature: 26 °C

Limit: FCC Part 24 conducted(9k-12.75G)

Power: AC 110V/60Hz

Humidity: 55 %

EUT:

M/N: 09-0088-EO

Mode: PCS1900

Note: CH610

加Notch(5TNF-1700)

No.	Mk.	Freq. MHz	Reading Level dBm	Correct Factor dB	Measure- ment dBm	Limit dBm	Over dB	Detector	Comment
1	*	1880.200	-18.24	4.65	-13.59	-13.00	-0.59	peak	Main Frequency
2		2638.900	-50.84	4.99	-45.85	-13.00	-32.85	peak	

*:Maximum data x:Over limit !:over margin



Conducted Emission Measurement

File :M320(CH610)

Data :#4

Date: 2009/5/21

Time: 上午 02:54:18

20.0 dBm

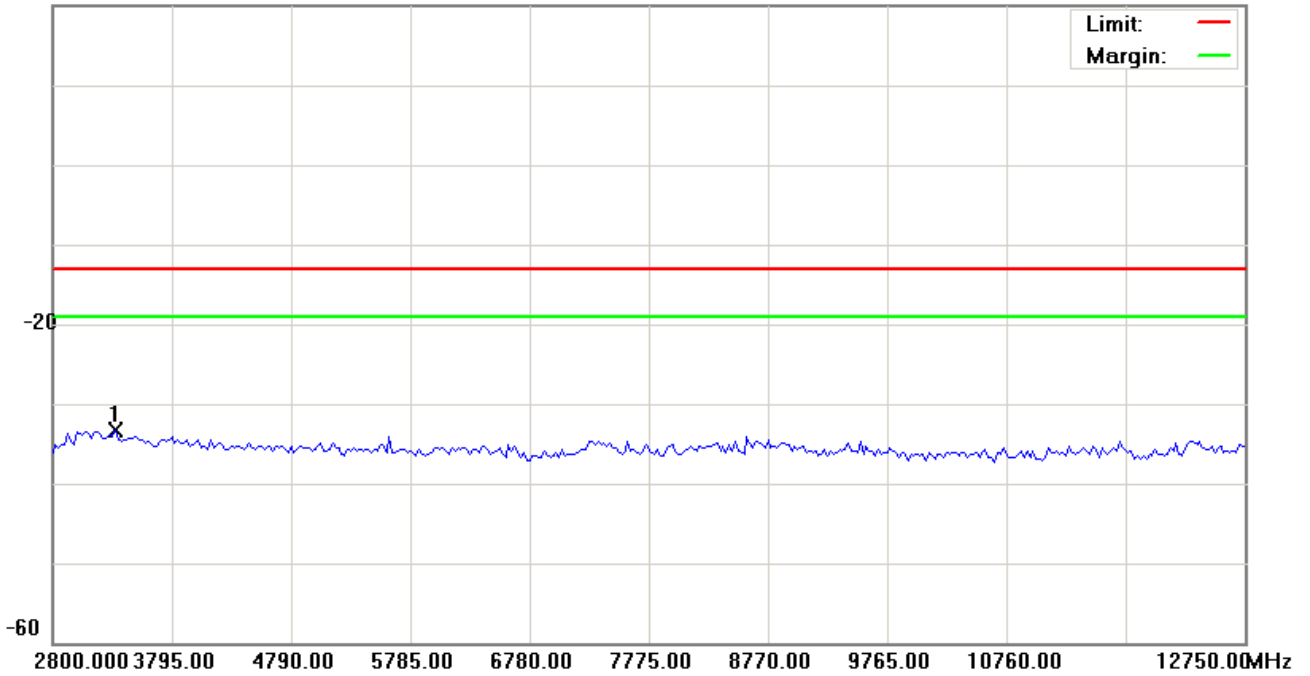

Site site #1

Phase: **Conducted po**

Temperature: 26 °C

Limit: FCC Part 24 conducted(9k-12.75G)

Power: AC 110V/60Hz

Humidity: 55 %

EUT:

M/N: 09-0088-EO

Mode: PCS1900

Note: CH610

No.	Mk.	Freq. MHz	Reading Level dBm	Correct Factor dB	Measure- ment dBm	Limit dBm	Over dB	Detector	Comment
1	*	3322.375	-38.52	5.16	-33.36	-13.00	-20.36	peak	

*:Maximum data x:Over limit !:over margin



Conducted Emission Measurement

File :M320(CH610)

Data :#5

Date: 2009/5/21

Time: 上午 02:54:39

20.0 dBm

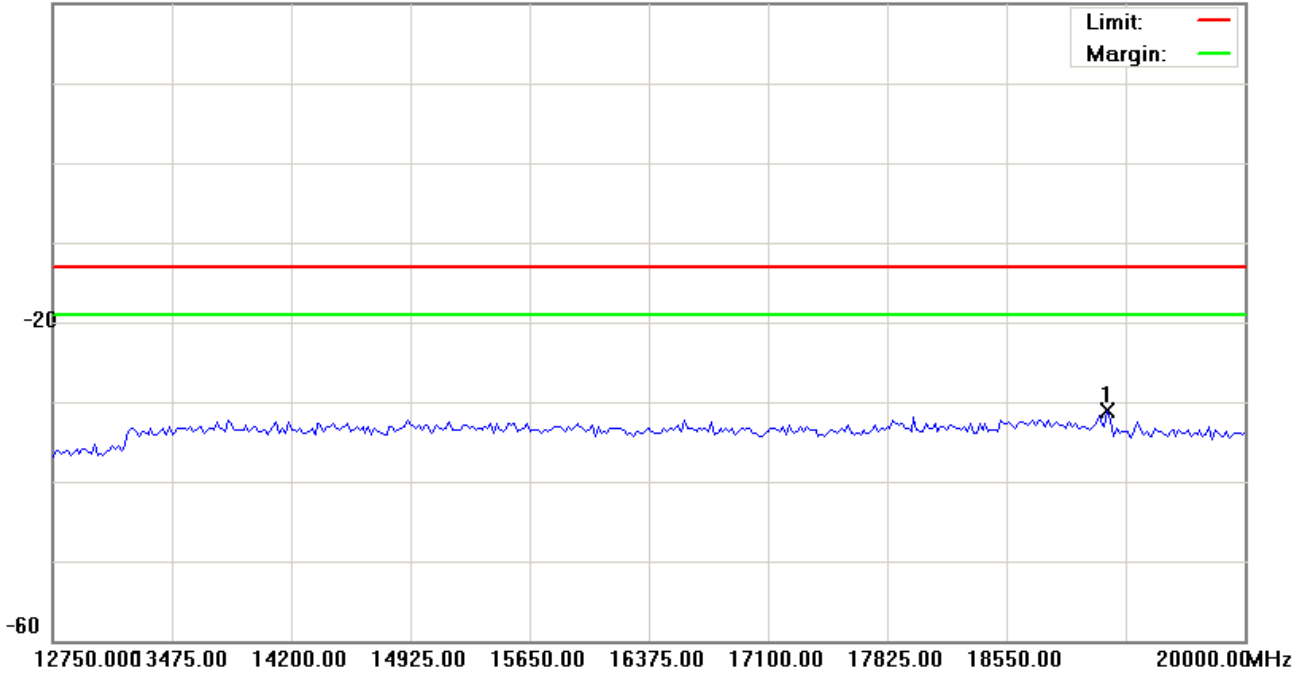

Site site #1

Phase: **Conducted po**

Temperature: 26 °C

Limit: FCC Part 24 conducted(9k-12.75G)

Power: AC 110V/60Hz

Humidity: 55 %

EUT:

M/N: 09-0088-EO

Mode: PCS1900

Note: CH610

No.	Mk.	Freq. MHz	Reading Level dBm	Correct Factor dB	Measure- ment dBm	Limit dBm	Over dB	Detector	Comment
1	*	19166.25	-38.26	7.20	-31.06	-13.00	-18.06	peak	

*:Maximum data x:Over limit !:over margin



Conducted Emission Measurement

File :M320(CH810)

Data :#1

Date: 2009/5/21

Time: 上午 01:43:04

10.0 dBm

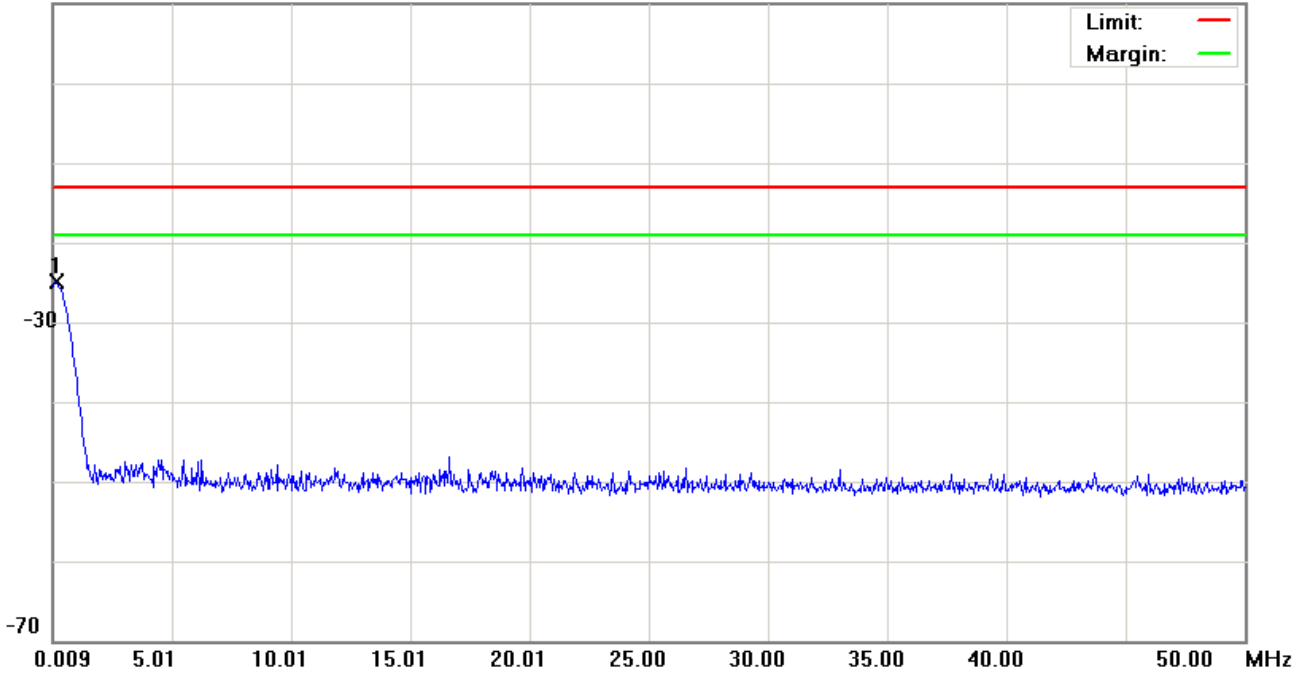

Site site #1

Phase: **Conducted po**

Temperature: 26 °C

Limit: FCC Part 24 conducted(9k-12.75G)

Power: AC 110V/60Hz

Humidity: 55 %

EUT:

M/N: 09-0088-EO

Mode: PCS1900

Note: CH810

加10db衰減器

No.	Mk.	Freq. MHz	Reading Level dBm	Correct Factor dB	Measure- ment dBm	Limit dBm	Over dB	Detector	Comment
1	*	0.1340	-37.35	12.48	-24.87	-13.00	-11.87	peak	

*:Maximum data x:Over limit !:over margin



Conducted Emission Measurement

File :M320(CH810)

Data :#2

Date: 2009/5/21

Time: 上午 01:43:28

20.0 dBm

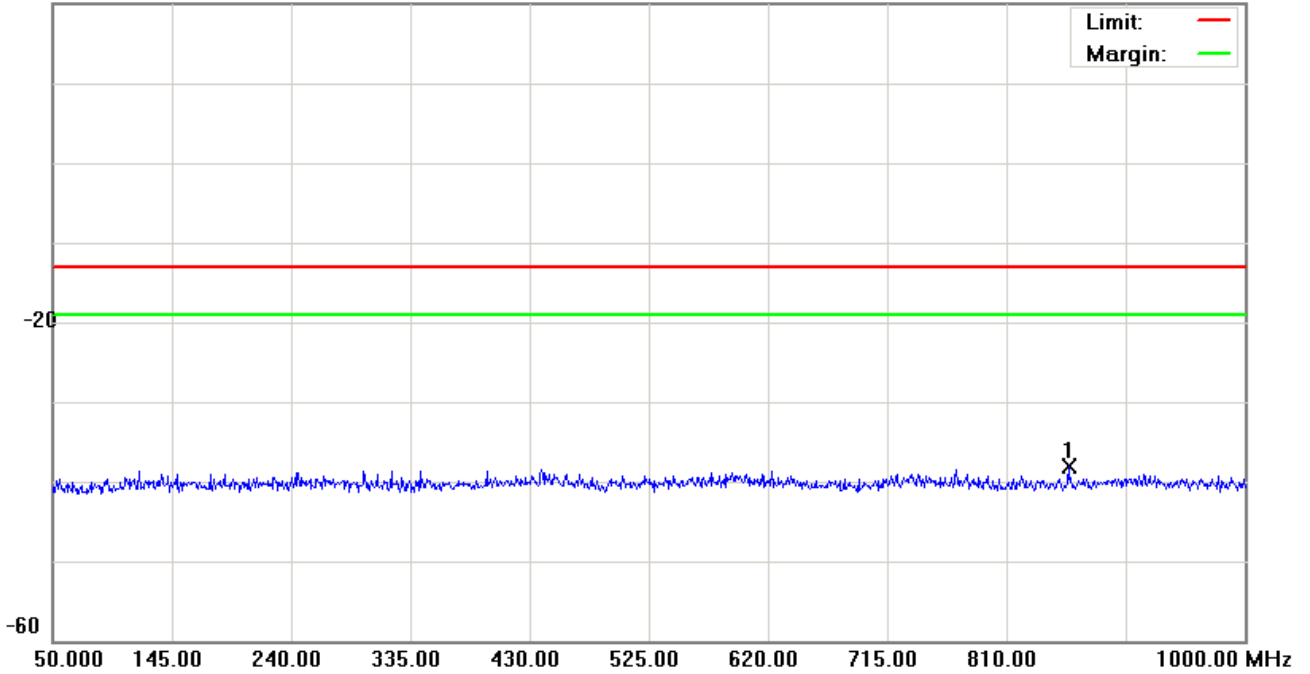

Site site #1

Phase: **Conducted po**

Temperature: 26 °C

Limit: FCC Part 24 conducted(9k-12.75G)

Power: AC 110V/60Hz

Humidity: 55 %

EUT:

M/N: 09-0088-EO

Mode: PCS1900

Note: CH810

加10db衰減器

No.	Mk.	Freq. MHz	Reading Level dBm	Correct Factor dB	Measure- ment dBm	Limit dBm	Over dB	Detector	Comment
1	*	859.8750	-51.42	13.28	-38.14	-13.00	-25.14	peak	

*:Maximum data x:Over limit !:over margin



Conducted Emission Measurement

File :M320(CH810)

Data :#3

Date: 2009/5/21

Time: 上午 03:08:01

20.0 dBm

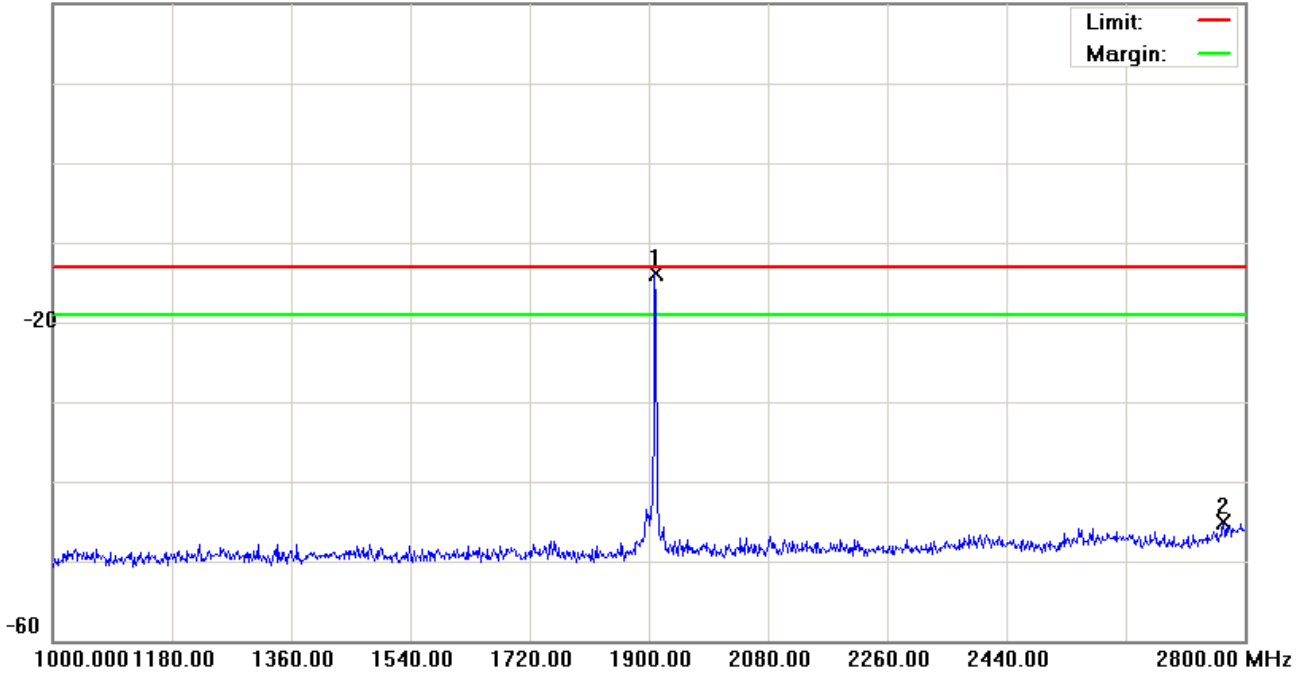

Site site #1

Phase: **Conducted po**

Temperature: 26 °C

Limit: FCC Part 24 conducted(9k-12.75G)

Power: AC 110V/60Hz

Humidity: 55 %

EUT:

M/N: 09-0088-EO

Mode: PCS1900

Note: CH810

加Notch(5TNF-1700)

No.	Mk.	Freq. MHz	Reading Level dBm	Correct Factor dB	Measure- ment dBm	Limit dBm	Over dB	Detector	Comment
1	*	1909.900	-19.56	5.71	-13.85	-13.00	-0.85	peak	Main Frequency
2		2767.600	-50.87	5.71	-45.16	-13.00	-32.16	peak	

*:Maximum data x:Over limit !:over margin



Conducted Emission Measurement

File :M320(CH810)

Data :#4

Date: 2009/5/21

Time: 上午 02:55:15

20.0 dBm

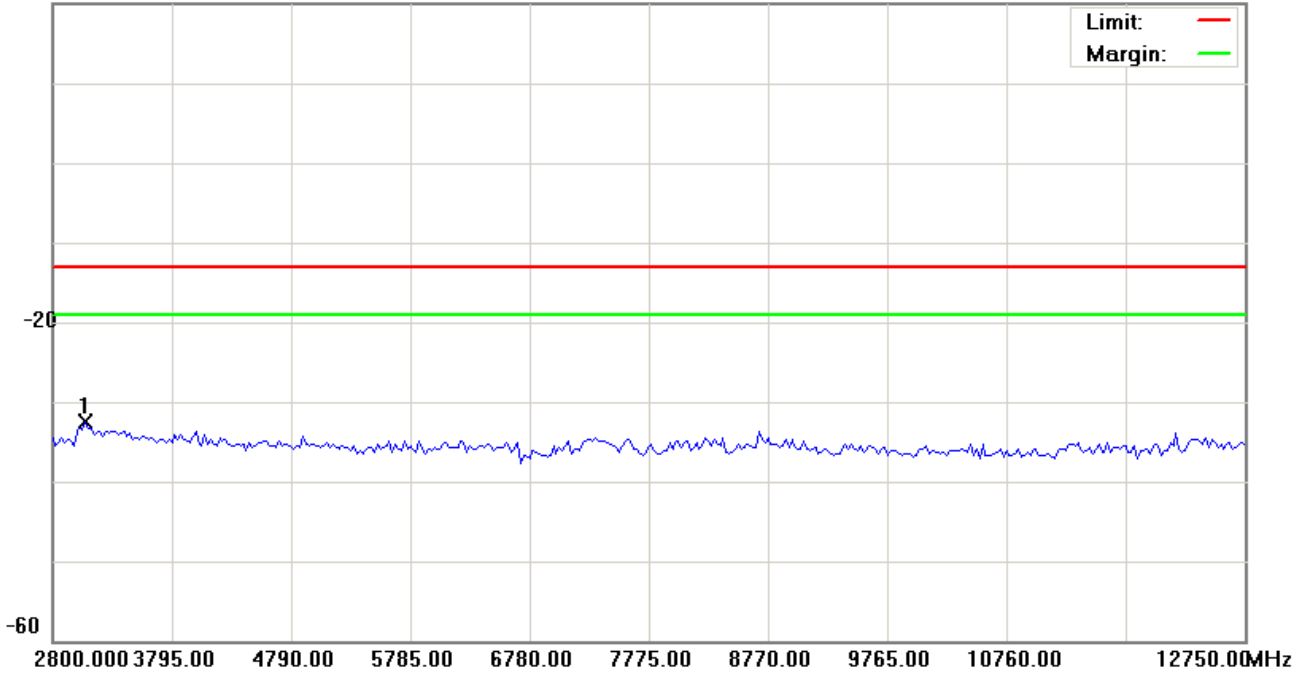

Site site #1

Phase: **Conducted po**

Temperature: 26 °C

Limit: FCC Part 24 conducted(9k-12.75G)

Power: AC 110V/60Hz

Humidity: 55 %

EUT:

M/N: 09-0088-EO

Mode: PCS1900

Note: CH810

No.	Mk.	Freq. MHz	Reading Level dBm	Correct Factor dB	Measure- ment dBm	Limit dBm	Over dB	Detector	Comment
1	*	3073.625	-37.98	5.40	-32.58	-13.00	-19.58	peak	

*:Maximum data x:Over limit !:over margin



Conducted Emission Measurement

File :M320(CH810)

Data :#5

Date: 2009/5/21

Time: 上午 02:55:36

20.0 dBm

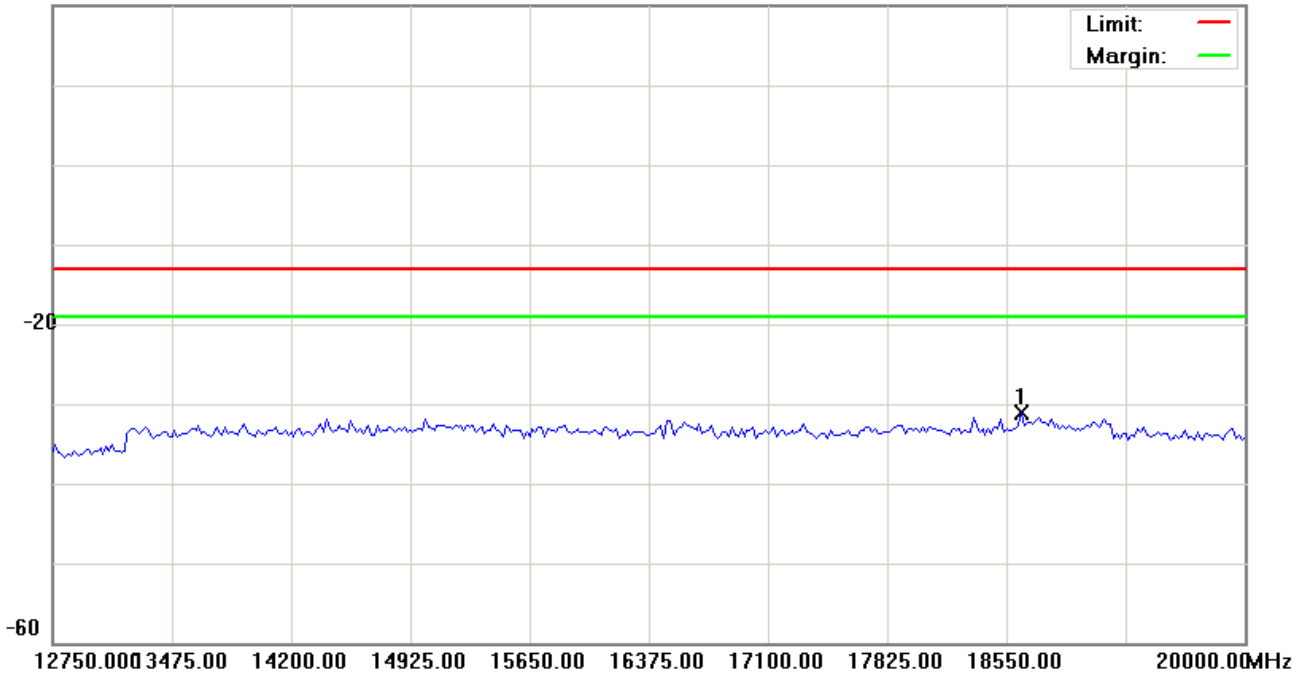

Site site #1

Phase: **Conducted po**

Temperature: 26 °C

Limit: FCC Part 24 conducted(9k-12.75G)

Power: AC 110V/60Hz

Humidity: 55 %

EUT:

M/N: 09-0088-EO

Mode: PCS1900

Note: CH810

No.	Mk.	Freq. MHz	Reading Level dBm	Correct Factor dB	Measure- ment dBm	Limit dBm	Over dB	Detector	Comment
1	*	18640.62	-38.24	7.05	-31.19	-13.00	-18.19	peak	

*:Maximum data x:Over limit !:over margin



4.5.4.3 WCDMA Band V Test Result

Applicant : Elitegroup Computer Systems Co., LTD.

Model No : M320/M320A/M320B

EUT : HSDPA mini-PCle Modem Module

Test Mode : WCDMA Band V (Low CH4132 / Middle CH4182 / High CH 4233)

Test Date : 05/21/2009

Please refer to next pager of detail testing data.

Note: Amplitude= Reading Amplitude + Factor (Cable loss + Filter Amplitude= Insertion loss)

(Auto calculate in spectrum analyzer)



Conducted Emission Measurement

File :M320(CH4132)

Data :#1

Date: 2009/5/21

Time: 上午 02:25:26

10.0 dBm

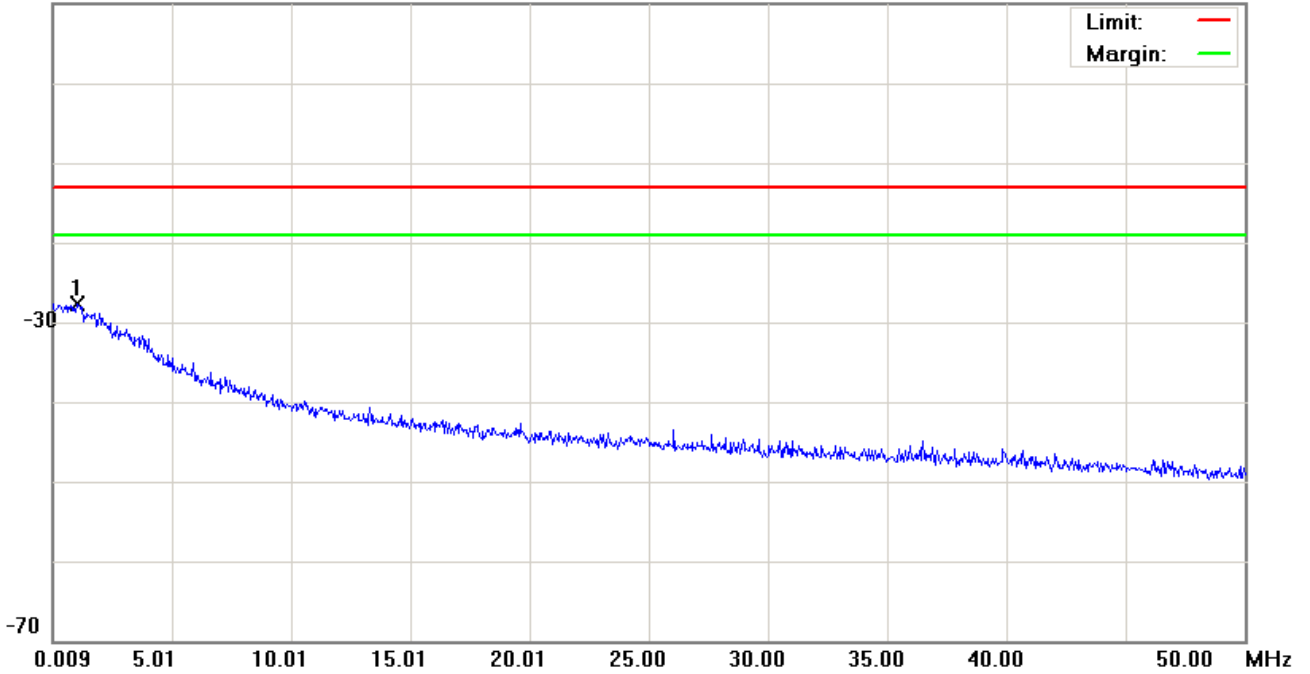

Site site #1

Phase: **Conducted po**

Temperature: 26 °C

Limit: FCC Part 22 conducted(9k-12.75G)

Power: AC 110V/60Hz

Humidity: 55 %

EUT:

M/N: 09-0088-EO

Mode: BAND V

Note: CH4132

加Notch(3TNF-800)

No.	Mk.	Freq. MHz	Reading Level dBm	Correct Factor dB	Measure- ment dBm	Limit dBm	Over dB	Detector	Comment
1	*	1.0084	-59.69	31.98	-27.71	-13.00	-14.71	peak	

*:Maximum data x:Over limit !:over margin



Conducted Emission Measurement

File :M320(CH4132)

Data :#2

Date: 2009/5/21

Time: 上午 02:25:50

20.0 dBm

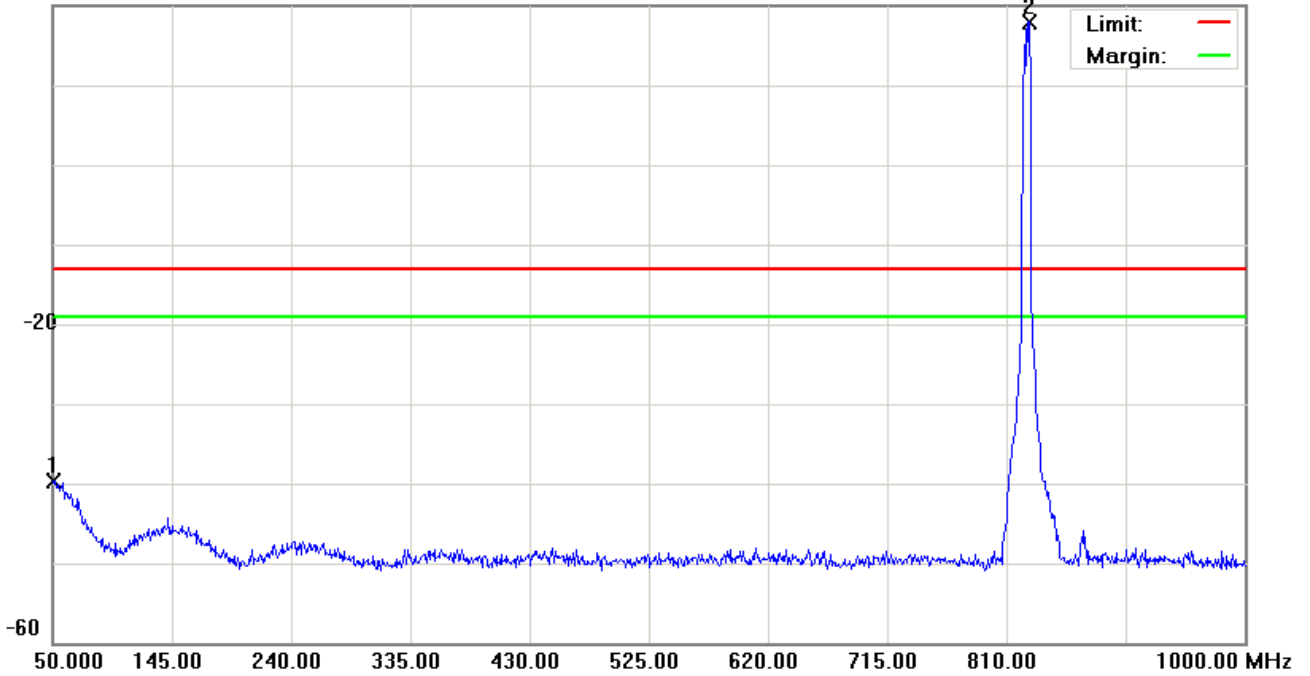

Site site #1

Phase: **Conducted po**

Temperature: 26 °C

Limit: FCC Part 22 conducted(9k-12.75G)

Power: AC 110V/60Hz

Humidity: 55 %

EUT:

M/N: 09-0088-EO

Mode: BAND V

Note: CH4132

加Notch(3TNF-800)

No.	Mk.	Freq. MHz	Reading Level dBm	Correct Factor dB	Measure- ment dBm	Limit dBm	Over dB	Detector	Comment
1		50.9500	-54.22	14.52	-39.70	-13.00	-26.70	peak	
2	*	827.5750	14.13	3.87	18.00	-13.00	31.00	peak	Main Frequency

*:Maximum data x:Over limit !:over margin



Conducted Emission Measurement

File :M320(CH4132)

Data :#3

Date: 2009/5/21

Time: 上午 02:33:35

20.0 dBm

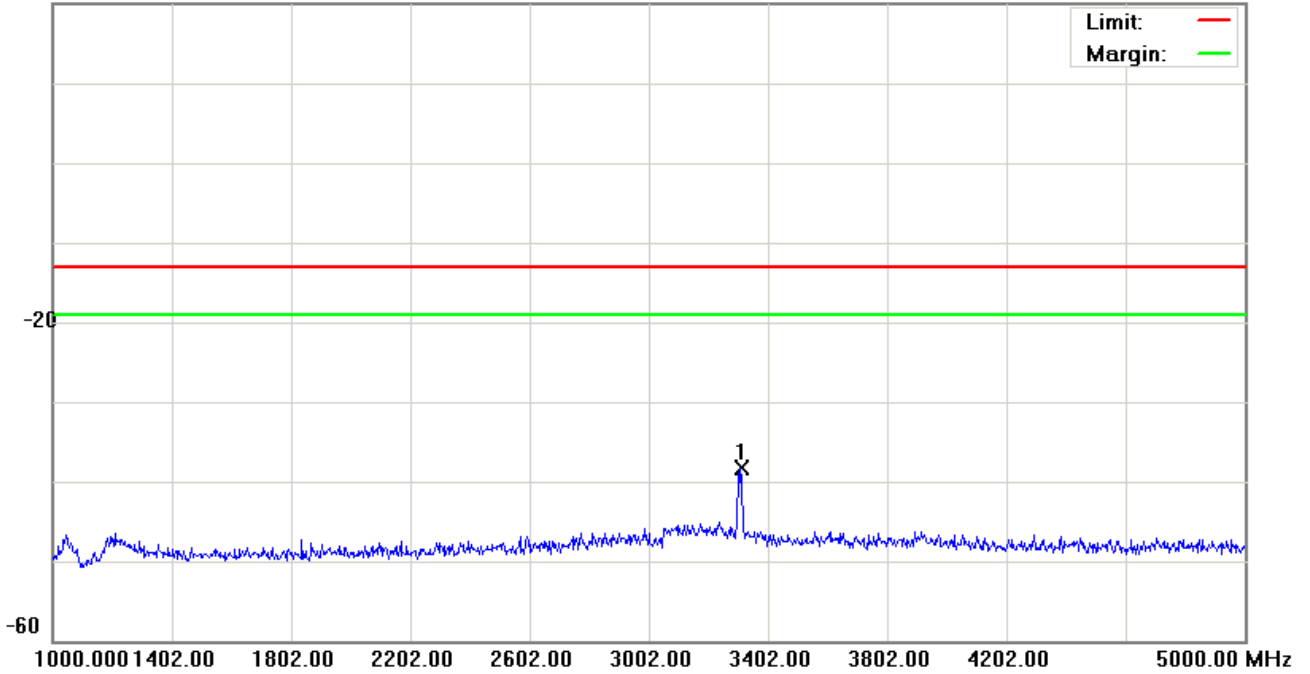

Site site #1

Phase: **Conducted po**

Temperature: 26 °C

Limit: FCC Part 22 conducted(9k-12.75G)

Power: AC 110V/60Hz

Humidity: 55 %

EUT:

M/N: 09-0088-EO

Mode: BAND V

Note: CH4132

No.	Mk.	Freq. MHz	Reading Level dBm	Correct Factor dB	Measure- ment dBm	Limit dBm	Over dB	Detector	Comment
1	*	3310.000	-42.71	4.44	-38.27	-13.00	-25.27	peak	

*:Maximum data x:Over limit !:over margin



Conducted Emission Measurement

File :M320(CH4132)

Data :#4

Date: 2009/5/21

Time: 上午 02:33:58

20.0 dBm

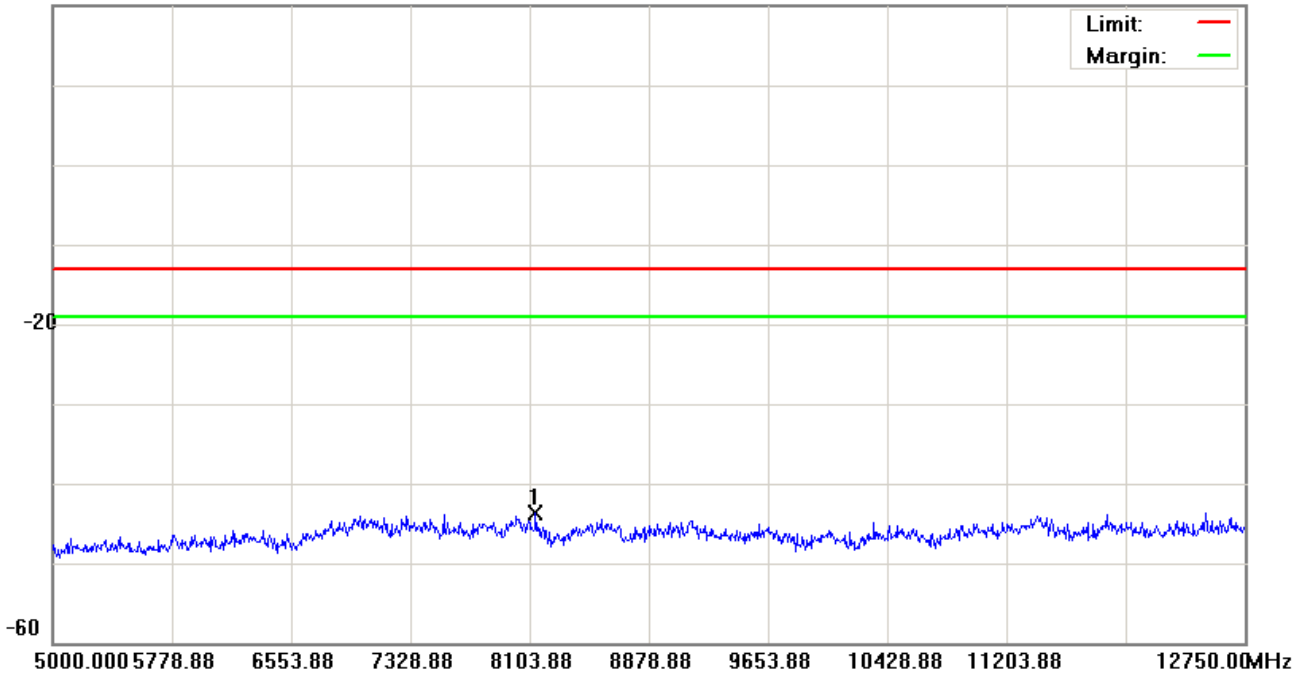

Site site #1

Phase: **Conducted po**

Temperature: 26 °C

Limit: FCC Part 22 conducted(9k-12.75G)

Power: AC 110V/60Hz

Humidity: 55 %

EUT:

M/N: 09-0088-EO

Mode: BAND V

Note: CH4132

No.	Mk.	Freq. MHz	Reading Level dBm	Correct Factor dB	Measure- ment dBm	Limit dBm	Over dB	Detector	Comment
1	*	8138.750	-49.53	5.80	-43.73	-13.00	-30.73	peak	

*:Maximum data x:Over limit !:over margin



Conducted Emission Measurement

File :M320(CH4180)

Data :#1

Date: 2009/5/21

Time: 上午 02:27:23

10.0 dBm

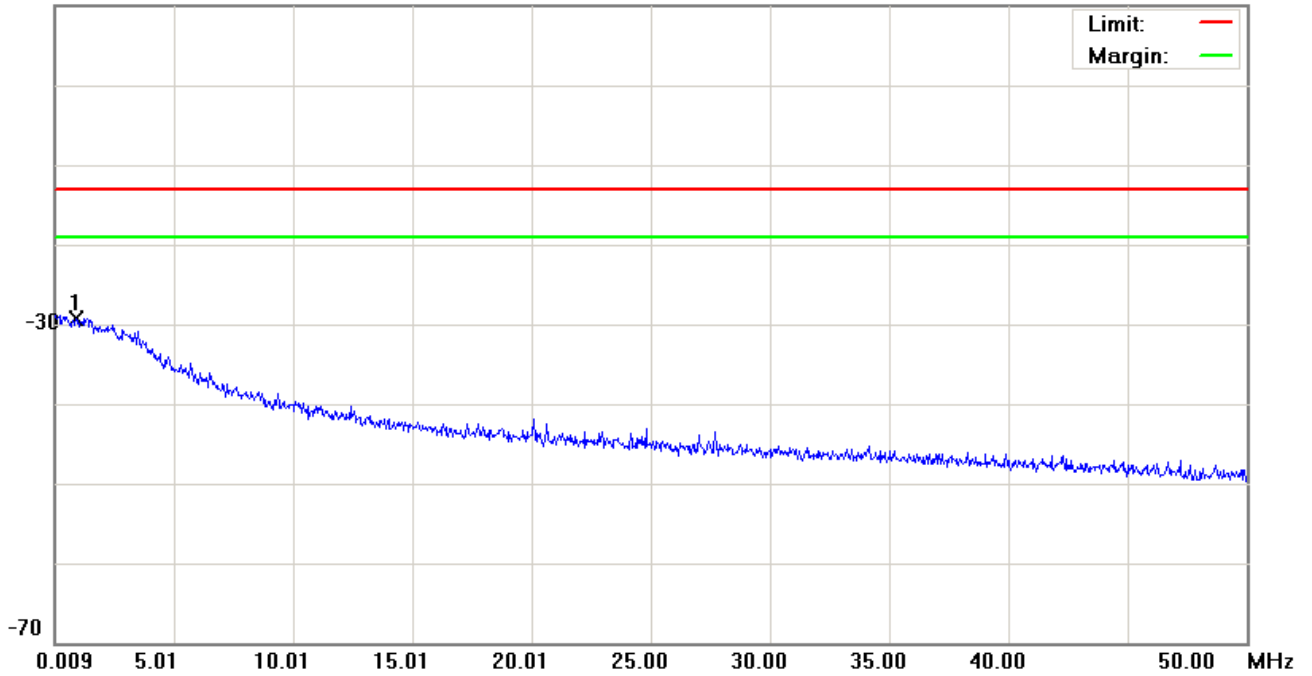

Site site #1

Phase: **Conducted po**

Temperature: 26 °C

Limit: FCC Part 22 conducted(9k-12.75G)

Power: AC 110V/60Hz

Humidity: 55 %

EUT:

M/N: 09-0088-EO

Mode: BAND V

Note: CH4180

加Notch(3TNF-800)

No.	Mk.	Freq. MHz	Reading Level dBm	Correct Factor dB	Measure- ment dBm	Limit dBm	Over dB	Detector	Comment
1	*	0.9088	-61.31	32.00	-29.31	-13.00	-16.31	peak	

*:Maximum data x:Over limit !:over margin



Conducted Emission Measurement

File :M320(CH4180)
20.0 dBm

Data :#2

Date: 2009/5/21

Time: 上午 02:27:48

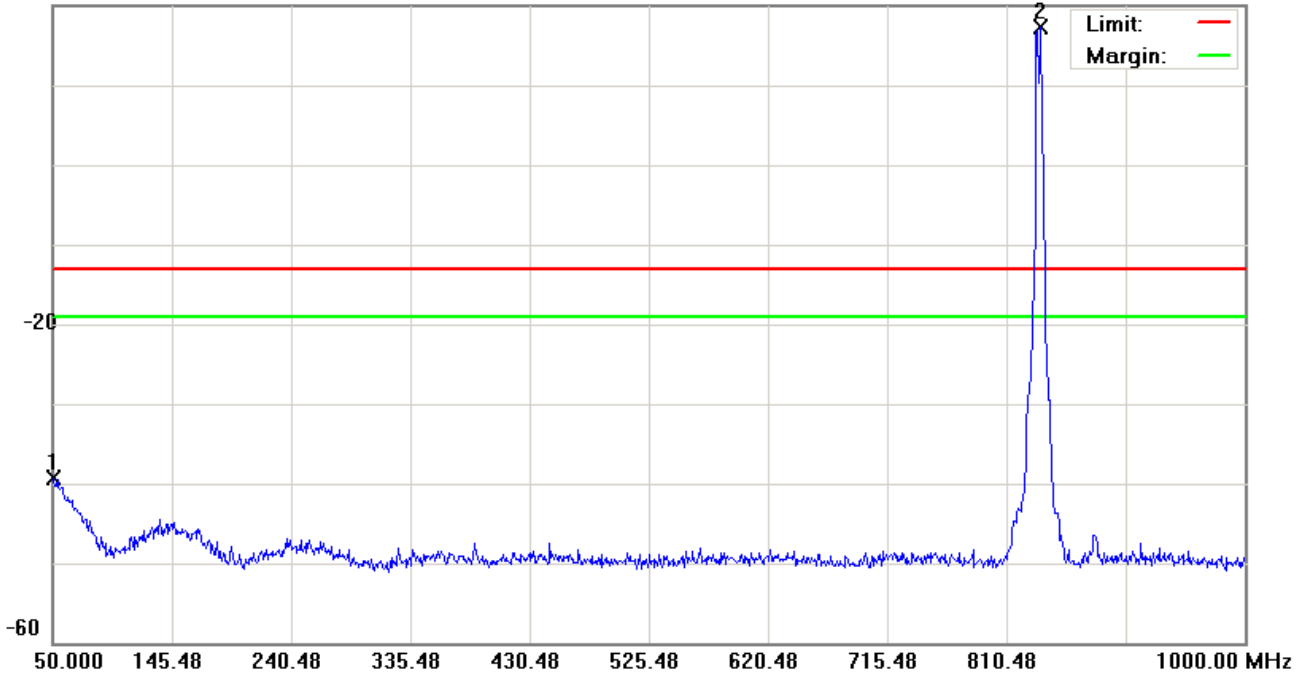

Site site #1 Phase: **Conducted po** Temperature: 26 °C
 Limit: FCC Part 22 conducted(9k-12.75G) Power: AC 110V/60Hz Humidity: 55 %
 EUT:
 M/N: 09-0088-EO
 Mode: BAND V
 Note: CH4180
 加Notch(3TNF-800)

No.	Mk.	Freq. MHz	Reading Level dBm	Correct Factor dB	Measure- ment dBm	Limit dBm	Over dB	Detector	Comment
1		50.4750	-53.88	14.61	-39.27	-13.00	-26.27	peak	
2	*	837.0750	13.29	3.96	17.25	-13.00	30.25	peak	Main Frequency

*:Maximum data x:Over limit !:over margin



Conducted Emission Measurement

File :M320(CH4180)

Data :#3

Date: 2009/5/21

Time: 上午 02:35:00

20.0 dBm

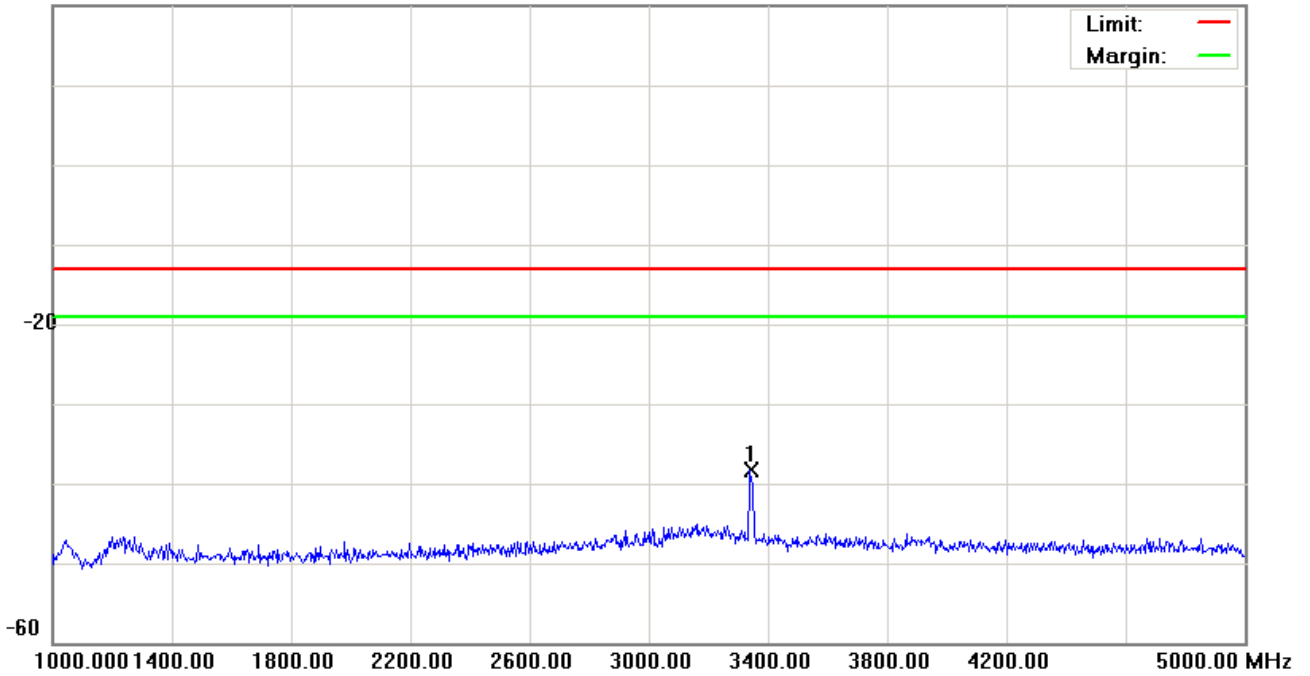

Site site #1

Phase: **Conducted po**

Temperature: 26 °C

Limit: FCC Part 22 conducted(9k-12.75G)

Power: AC 110V/60Hz

Humidity: 55 %

EUT:

M/N: 09-0088-EO

Mode: BAND V

Note: CH4180

No.	Mk.	Freq. MHz	Reading Level dBm	Correct Factor dB	Measure- ment dBm	Limit dBm	Over dB	Detector	Comment
1	*	3342.000	-42.89	4.50	-38.39	-13.00	-25.39	peak	

*:Maximum data x:Over limit !:over margin



Conducted Emission Measurement

File :M320(CH4180)

Data :#4

Date: 2009/5/21

Time: 上午 02:35:23

20.0 dBm

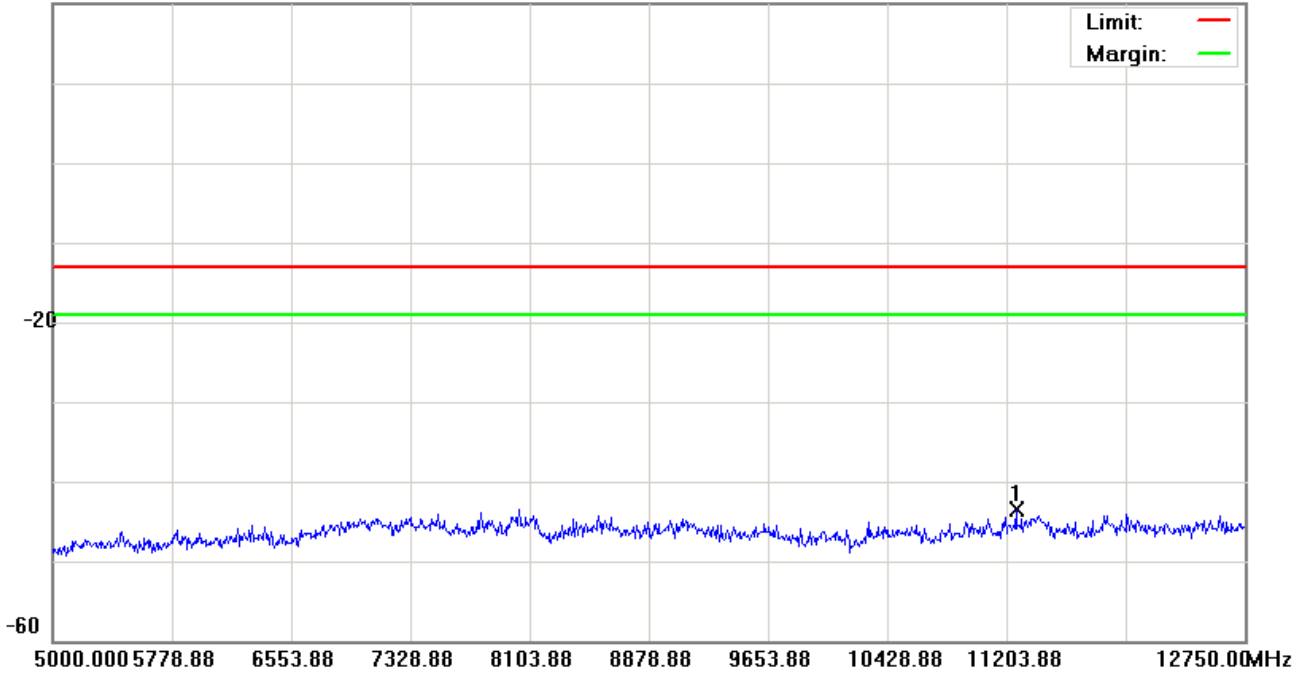

Site site #1

Phase: **Conducted po**

Temperature: 26 °C

Limit: FCC Part 22 conducted(9k-12.75G)

Power: AC 110V/60Hz

Humidity: 55 %

EUT:

M/N: 09-0088-EO

Mode: BAND V

Note: CH4180

No.	Mk.	Freq. MHz	Reading Level dBm	Correct Factor dB	Measure- ment dBm	Limit dBm	Over dB	Detector	Comment
1	*	11262.00	-48.62	5.12	-43.50	-13.00	-30.50	peak	

*:Maximum data x:Over limit !:over margin



Conducted Emission Measurement

File :M320(CH4233)

Data :#1

Date: 2009/5/21

Time: 上午 02:29:56

10.0 dBm

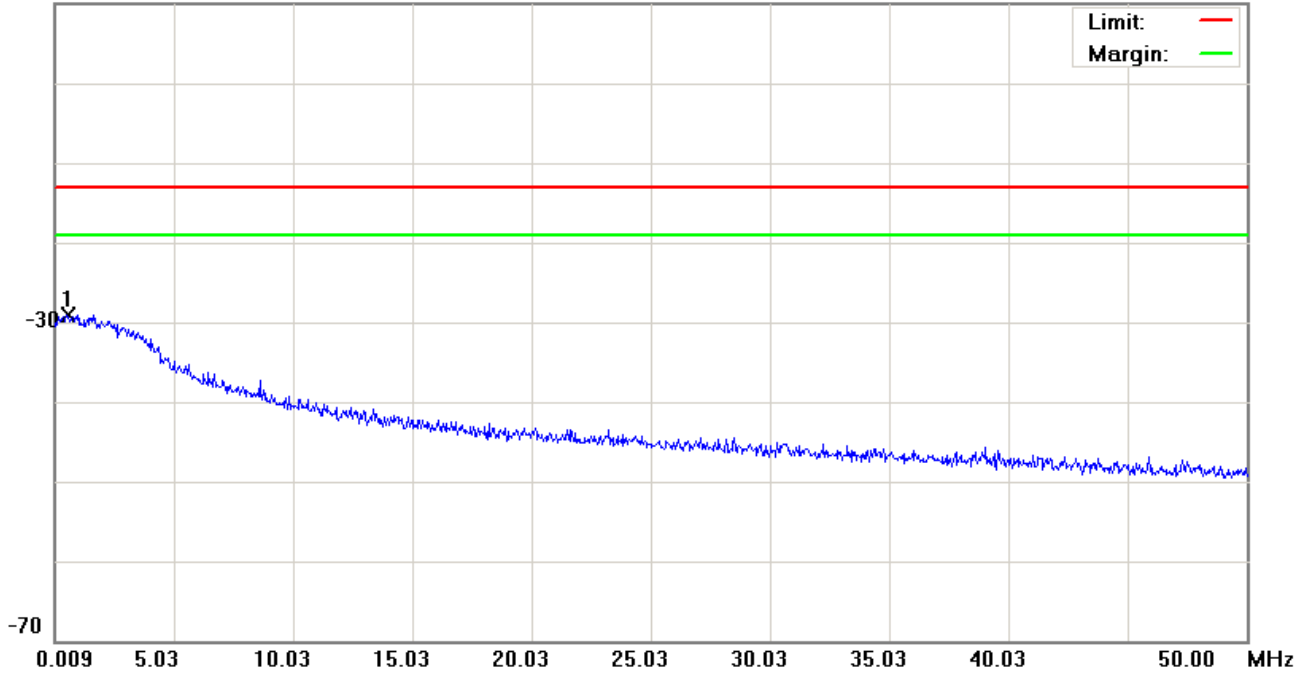

Site site #1

Phase: **Conducted po**

Temperature: 26 °C

Limit: FCC Part 22 conducted(9k-12.75G)

Power: AC 110V/60Hz

Humidity: 55 %

EUT:

M/N: 09-0088-EO

Mode: BAND V

Note: CH4233

加Notch(3TNF-800)

No.	Mk.	Freq. MHz	Reading Level dBm	Correct Factor dB	Measure- ment dBm	Limit dBm	Over dB	Detector	Comment
1	*	0.5090	-61.03	32.02	-29.01	-13.00	-16.01	peak	

*:Maximum data x:Over limit !:over margin



Conducted Emission Measurement

File :M320(CH4233)

Data :#2

Date: 2009/5/21

Time: 上午 02:30:20

20.0 dBm

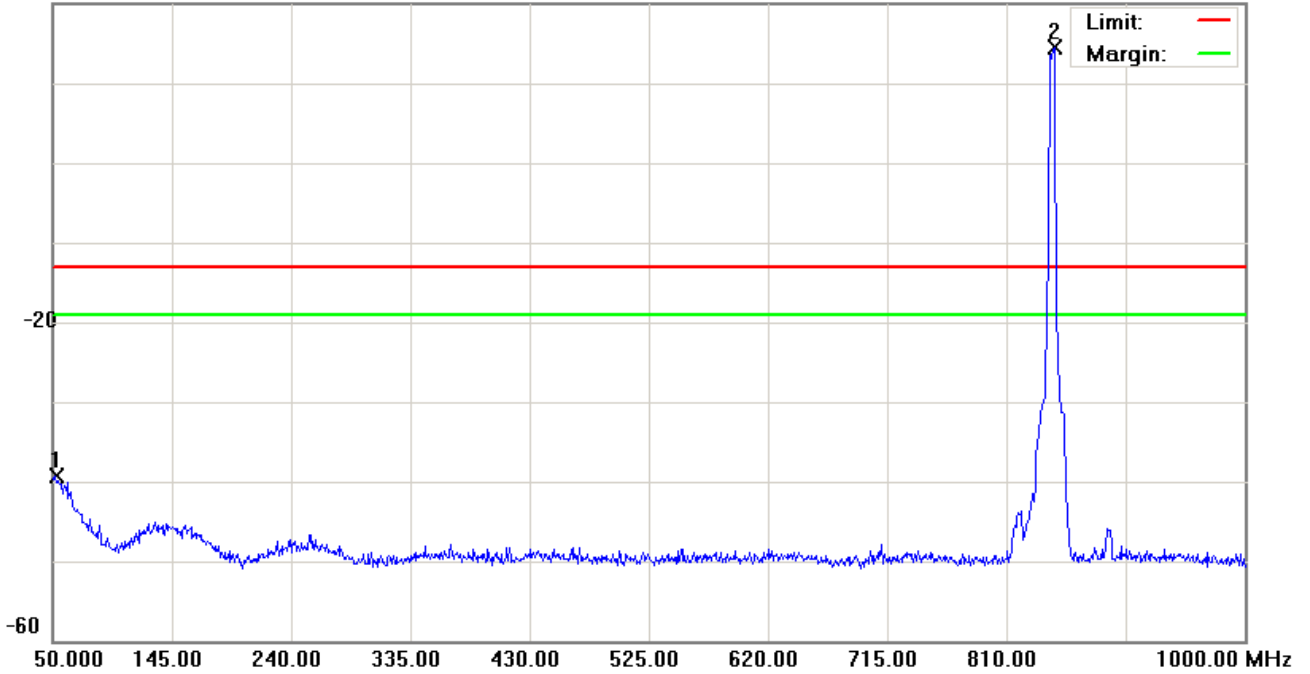

Site site #1

Phase: **Conducted po**

Temperature: 26 °C

Limit: FCC Part 22 conducted(9k-12.75G)

Power: AC 110V/60Hz

Humidity: 55 %

EUT:

M/N: 09-0088-EO

Mode: BAND V

Note: CH4233

加Notch(3TNF-800)

No.	Mk.	Freq. MHz	Reading Level dBm	Correct Factor dB	Measure- ment dBm	Limit dBm	Over dB	Detector	Comment
1		52.3750	-53.57	14.27	-39.30	-13.00	-26.30	peak	
2	*	848.0000	10.54	3.98	14.52	-13.00	27.52	peak	Main Frequency

*:Maximum data x:Over limit !:over margin



Conducted Emission Measurement

File :M320(CH4233)
20.0 dBm

Data :#3

Date: 2009/5/21

Time: 上午 02:36:11

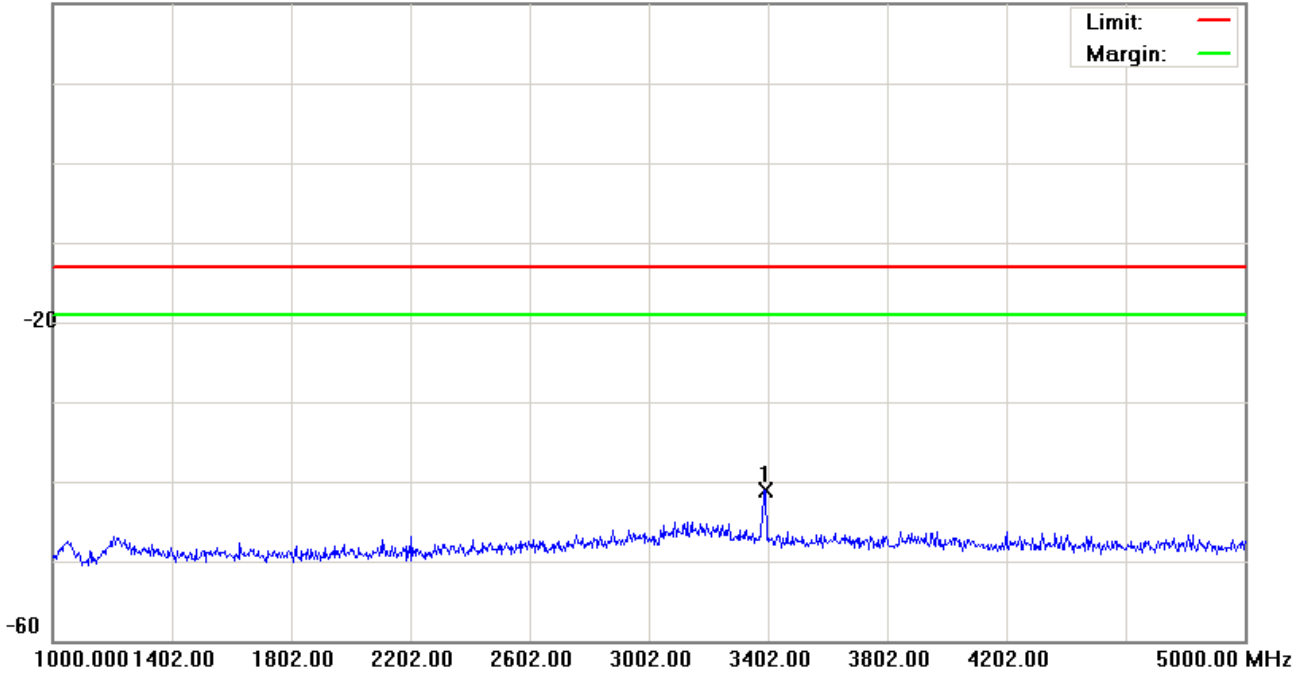

Site site #1 Phase: **Conducted po** Temperature: 26 °C
 Limit: FCC Part 22 conducted(9k-12.75G) Power: AC 110V/60Hz Humidity: 55 %
 EUT:
 M/N: 09-0088-EO
 Mode: BAND V
 Note: CH4233

No.	Mk.	Freq. MHz	Reading Level dBm	Correct Factor dB	Measure- ment dBm	Limit dBm	Over dB	Detector	Comment
1	*	3392.000	-45.57	4.47	-41.10	-13.00	-28.10	peak	

*:Maximum data x:Over limit !:over margin



Conducted Emission Measurement

File :M320(CH4233)

Data :#4

Date: 2009/5/21

Time: 上午 02:36:34

20.0 dBm

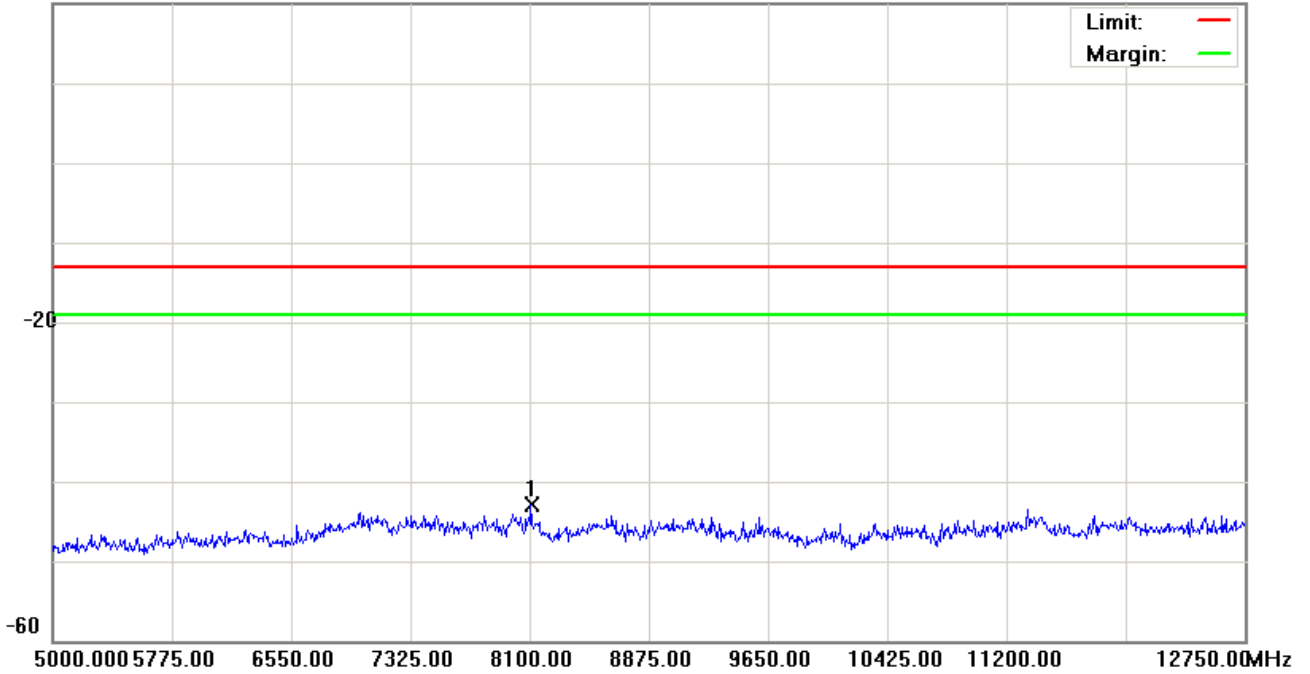

Site site #1

Phase: **Conducted po**

Temperature: 26 °C

Limit: FCC Part 22 conducted(9k-12.75G)

Power: AC 110V/60Hz

Humidity: 55 %

EUT:

M/N: 09-0088-EO

Mode: BAND V

Note: CH4233

No.	Mk.	Freq. MHz	Reading Level dBm	Correct Factor dB	Measure- ment dBm	Limit dBm	Over dB	Detector	Comment
1	*	8111.625	-48.73	5.74	-42.99	-13.00	-29.99	peak	

*:Maximum data x:Over limit !:over margin



4.5.4.4 WCDMA Band II Test Result

Applicant : Elitegroup Computer Systems Co., LTD.
Model No : M320/M320A/M320B
EUT : HSDPA mini-PCle Modem Module
Test Mode : WCDMA Band II (Low CH9262 / Middle CH9400 / High CH 9536)
Test Date : 05/21/2009

Please refer to next pager of detail testing data.

Note: Amplitude= Reading Amplitude + Factor (Cable loss + Filter Amplitude= Insertion loss)
(Auto calculate in spectrum analyzer)



Conducted Emission Measurement

File :M320(CH9262)

Data :#1

Date: 2009/5/21

Time: 上午 01:45:53

10.0 dBm

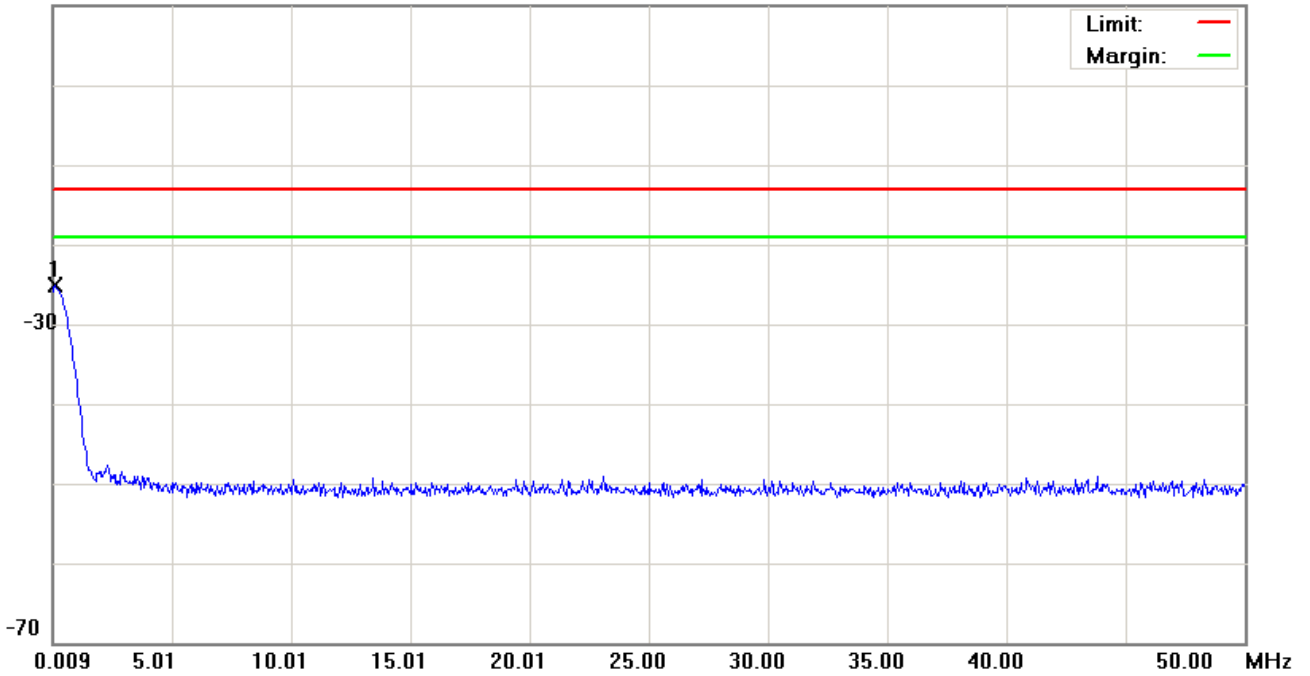

Site site #1

Phase: **Conducted po**

Temperature: 26 °C

Limit: FCC Part 24 conducted(9k-12.75G)

Power: AC 110V/60Hz

Humidity: 55 %

EUT:

M/N: 09-0088-EO

Mode: BAND II

Note: CH9262

加10db衰減器

No.	Mk.	Freq. MHz	Reading Level dBm	Correct Factor dB	Measure- ment dBm	Limit dBm	Over dB	Detector	Comment
1	*	0.1090	-37.61	12.49	-25.12	-13.00	-12.12	peak	

*:Maximum data x:Over limit !:over margin



Conducted Emission Measurement

File :M320(CH9262)

Data :#2

Date: 2009/5/21

Time: 上午 01:46:17

20.0 dBm

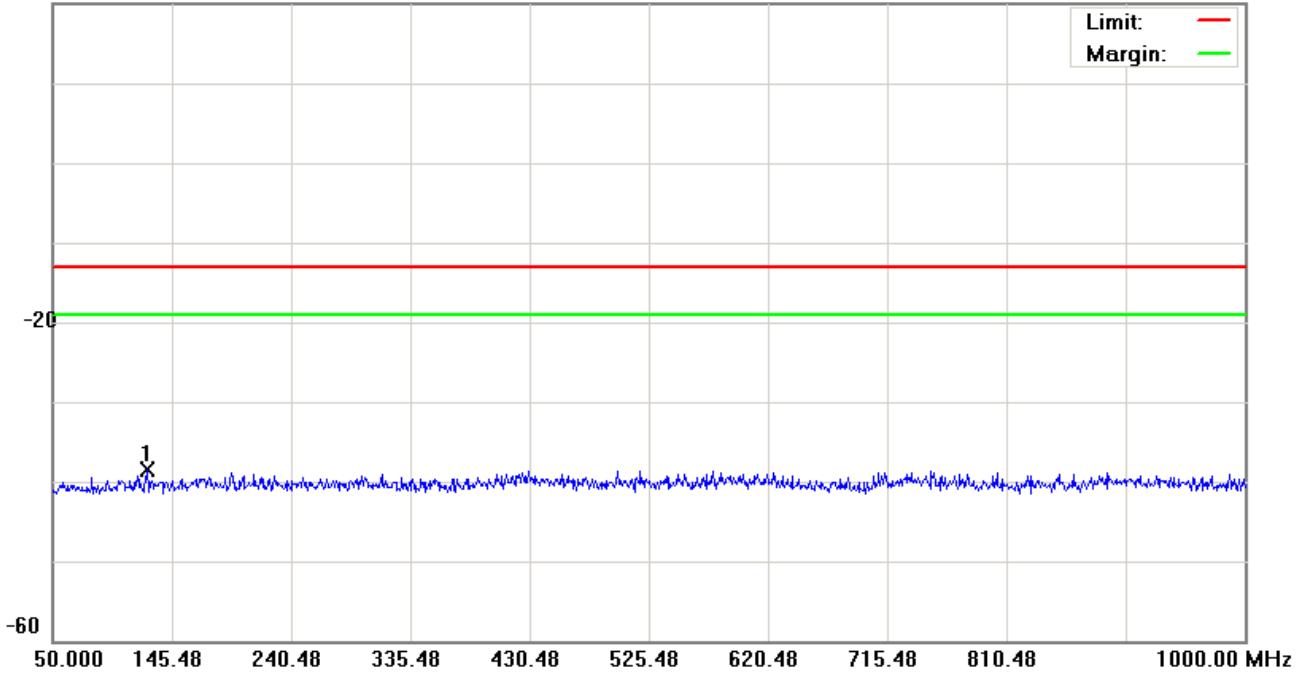

Site site #1

Phase: **Conducted po**

Temperature: 26 °C

Limit: FCC Part 24 conducted(9k-12.75G)

Power: AC 110V/60Hz

Humidity: 55 %

EUT:

M/N: 09-0088-EO

Mode: BAND II

Note: CH9262

加10db衰減器

No.	Mk.	Freq. MHz	Reading Level dBm	Correct Factor dB	Measure- ment dBm	Limit dBm	Over dB	Detector	Comment
1	*	125.0500	-51.90	13.34	-38.56	-13.00	-25.56	peak	

*:Maximum data x:Over limit !:over margin



Conducted Emission Measurement

File :M320(CH9262)

Data :#3

Date: 2009/5/21

Time: 上午 01:54:49

20.0 dBm

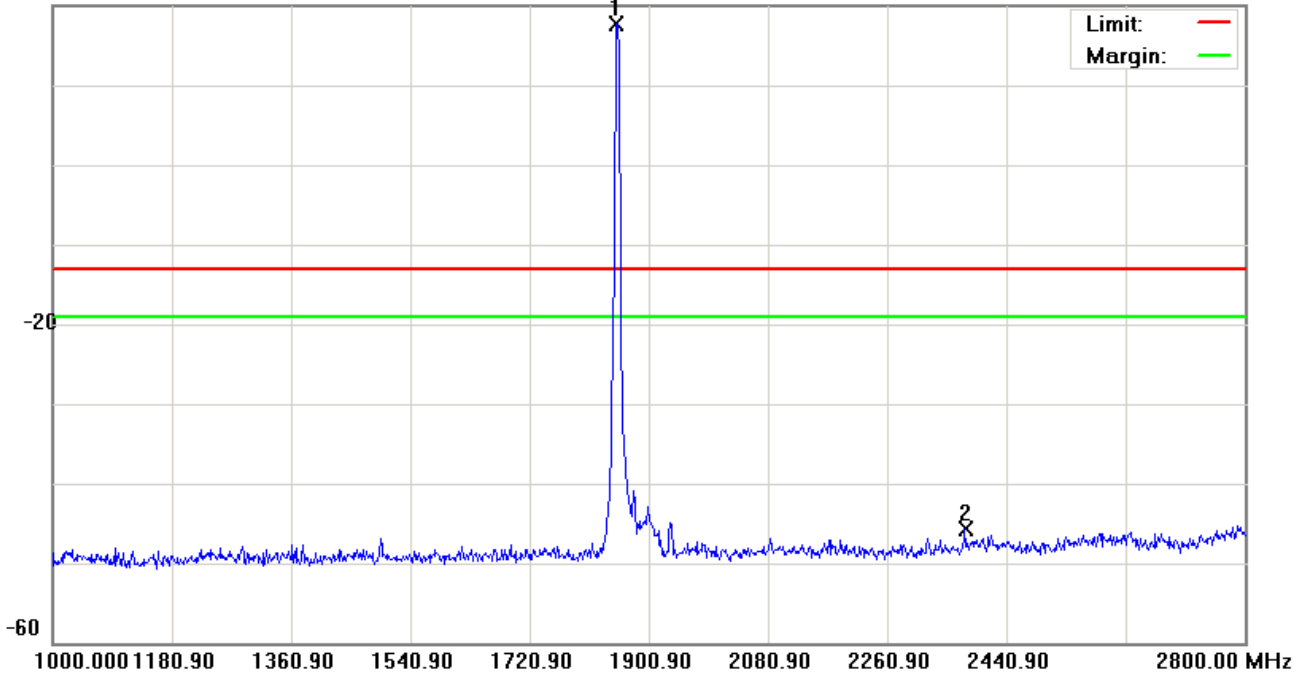

Site site #1

Phase: **Conducted po**

Temperature: 26 °C

Limit: FCC Part 24 conducted(9k-12.75G)

Power: AC 110V/60Hz

Humidity: 55 %

EUT:

M/N: 09-0088-EO

Mode: BAND II

Note: CH9262

加Notch(5TNF-1700)

No.	Mk.	Freq. MHz	Reading Level dBm	Correct Factor dB	Measure- ment dBm	Limit dBm	Over dB	Detector	Comment
1	*	1850.500	13.37	4.26	17.63	-13.00	30.63	peak	Main Frequency
2		2377.900	-50.63	4.87	-45.76	-13.00	-32.76	peak	

*:Maximum data x:Over limit !:over margin



Conducted Emission Measurement

File :M320(CH9262)

Data :#4

Date: 2009/5/21

Time: 上午 02:57:52

20.0 dBm

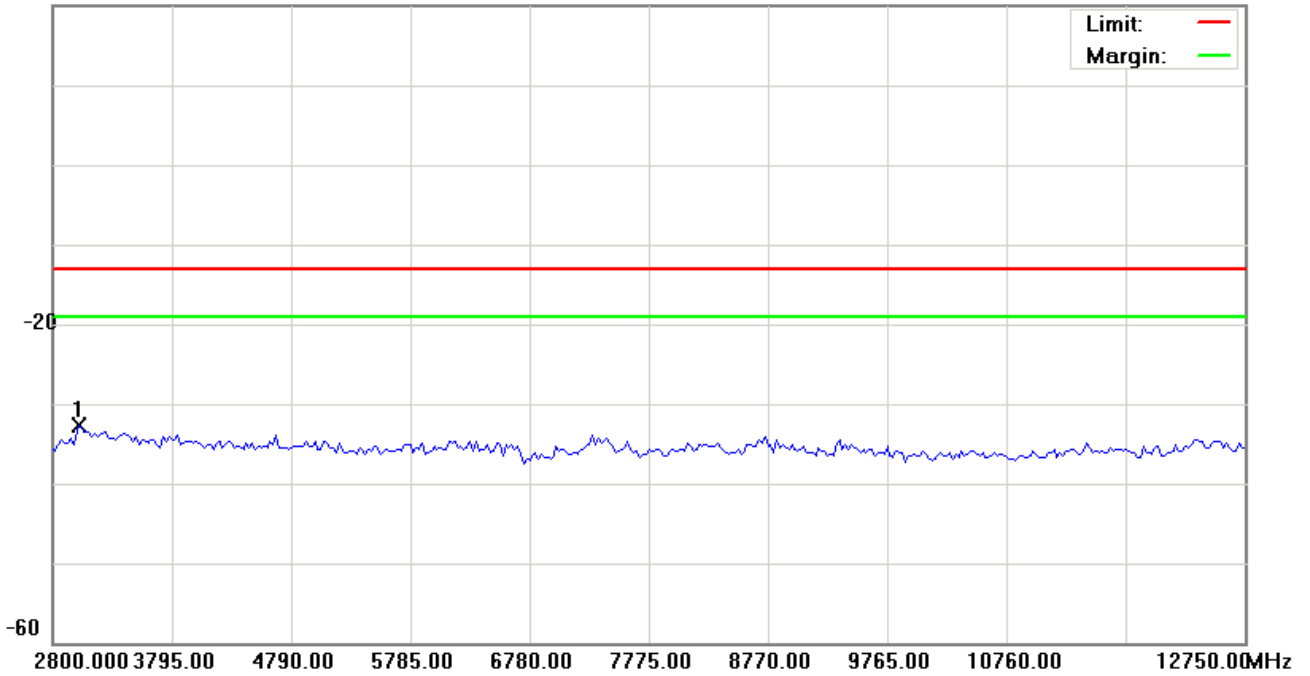

Site site #1

Phase: **Conducted po**

Temperature: 26 °C

Limit: FCC Part 24 conducted(9k-12.75G)

Power: AC 110V/60Hz

Humidity: 55 %

EUT:

M/N: 09-0088-EO

Mode: BAND II

Note: CH9262

No.	Mk.	Freq. MHz	Reading Level dBm	Correct Factor dB	Measure- ment dBm	Limit dBm	Over dB	Detector	Comment
1	*	3023.875	-38.19	5.48	-32.71	-13.00	-19.71	peak	

*:Maximum data x:Over limit !:over margin



Conducted Emission Measurement

File :M320(CH9262)

Data :#5

Date: 2009/5/21

Time: 上午 02:58:13

20.0 dBm

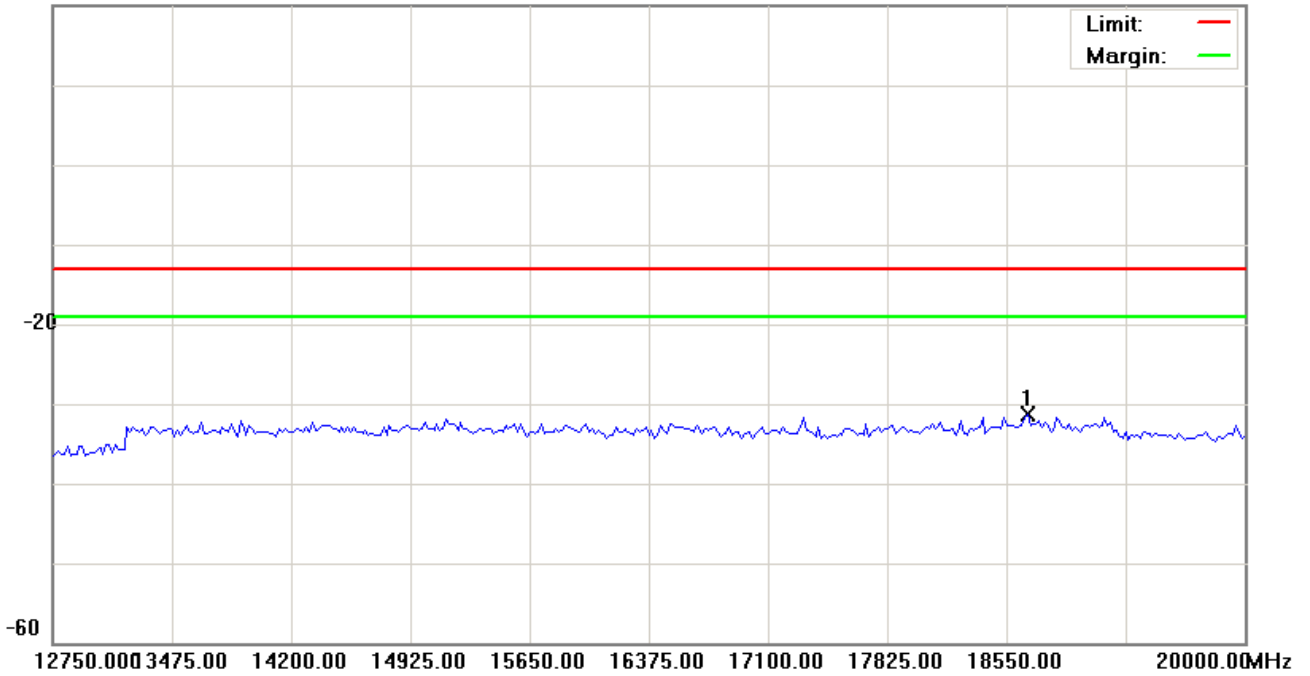

Site site #1

Phase: **Conducted po**

Temperature: 26 °C

Limit: FCC Part 24 conducted(9k-12.75G)

Power: AC 110V/60Hz

Humidity: 55 %

EUT:

M/N: 09-0088-EO

Mode: BAND II

Note: CH9262

No.	Mk.	Freq. MHz	Reading Level dBm	Correct Factor dB	Measure- ment dBm	Limit dBm	Over dB	Detector	Comment
1	*	18676.87	-38.45	7.06	-31.39	-13.00	-18.39	peak	

*:Maximum data x:Over limit !:over margin



Conducted Emission Measurement

File :M320(CH9400)

Data :#1

Date: 2009/5/21

Time: 上午 01:47:08

10.0 dBm

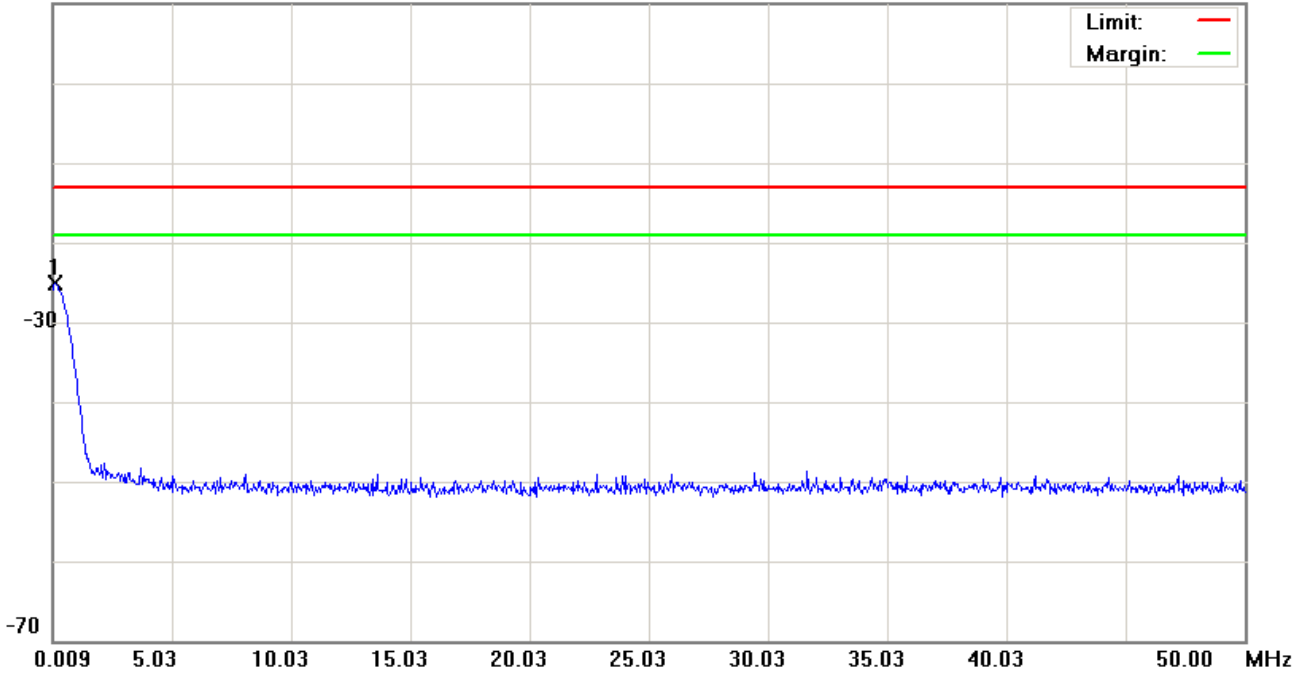

Site site #1

Phase: **Conducted po**

Temperature: 26 °C

Limit: FCC Part 24 conducted(9k-12.75G)

Power: AC 110V/60Hz

Humidity: 55 %

EUT:

M/N: 09-0088-EO

Mode: BAND II

Note: CH9400

加10db衰減器

No.	Mk.	Freq. MHz	Reading Level dBm	Correct Factor dB	Measure- ment dBm	Limit dBm	Over dB	Detector	Comment
1	*	0.1090	-37.63	12.49	-25.14	-13.00	-12.14	peak	

*:Maximum data x:Over limit !:over margin



Conducted Emission Measurement

File :M320(CH9400)

Data :#2

Date: 2009/5/21

Time: 上午 01:47:32

20.0 dBm

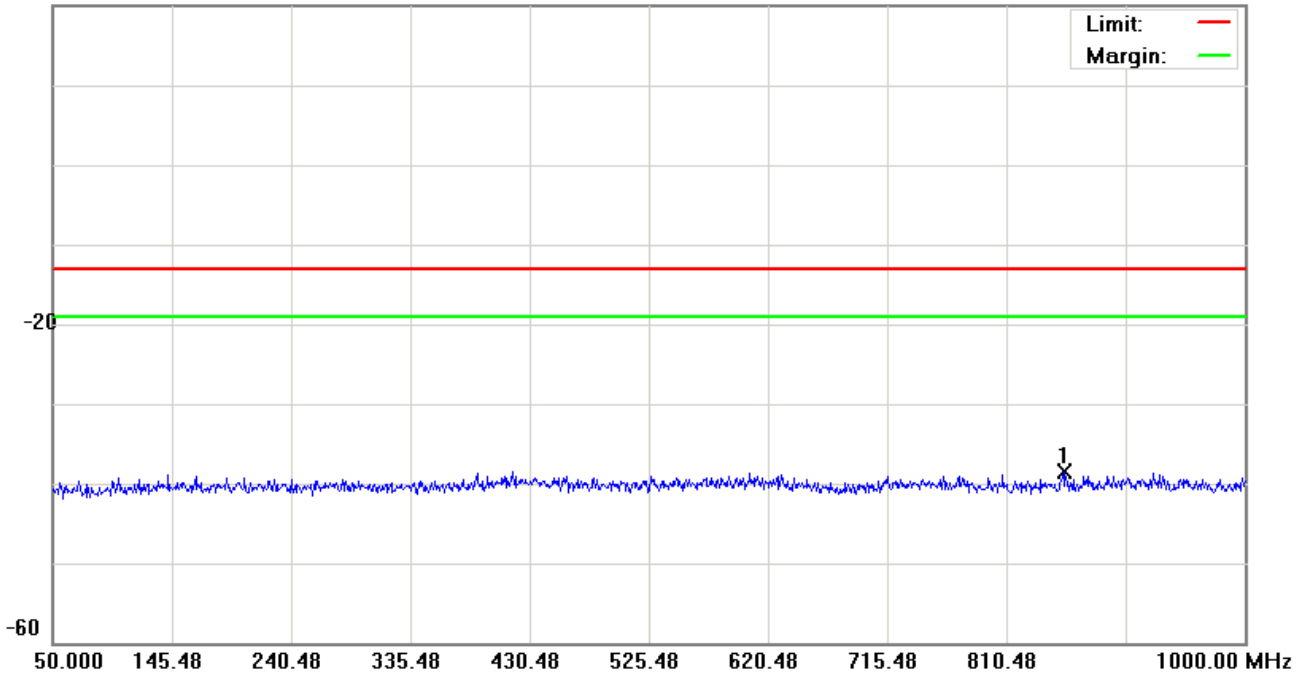

Site site #1

Phase: **Conducted po**

Temperature: 26 °C

Limit: FCC Part 24 conducted(9k-12.75G)

Power: AC 110V/60Hz

Humidity: 55 %

EUT:

M/N: 09-0088-EO

Mode: BAND II

Note: CH9400

加10db衰減器

No.	Mk.	Freq. MHz	Reading Level dBm	Correct Factor dB	Measure- ment dBm	Limit dBm	Over dB	Detector	Comment
1	*	855.6000	-51.75	13.24	-38.51	-13.00	-25.51	peak	

*:Maximum data x:Over limit !:over margin



Conducted Emission Measurement

File :M320(CH9400)

Data :#3

Date: 2009/5/21

Time: 上午 01:55:54

20.0 dBm

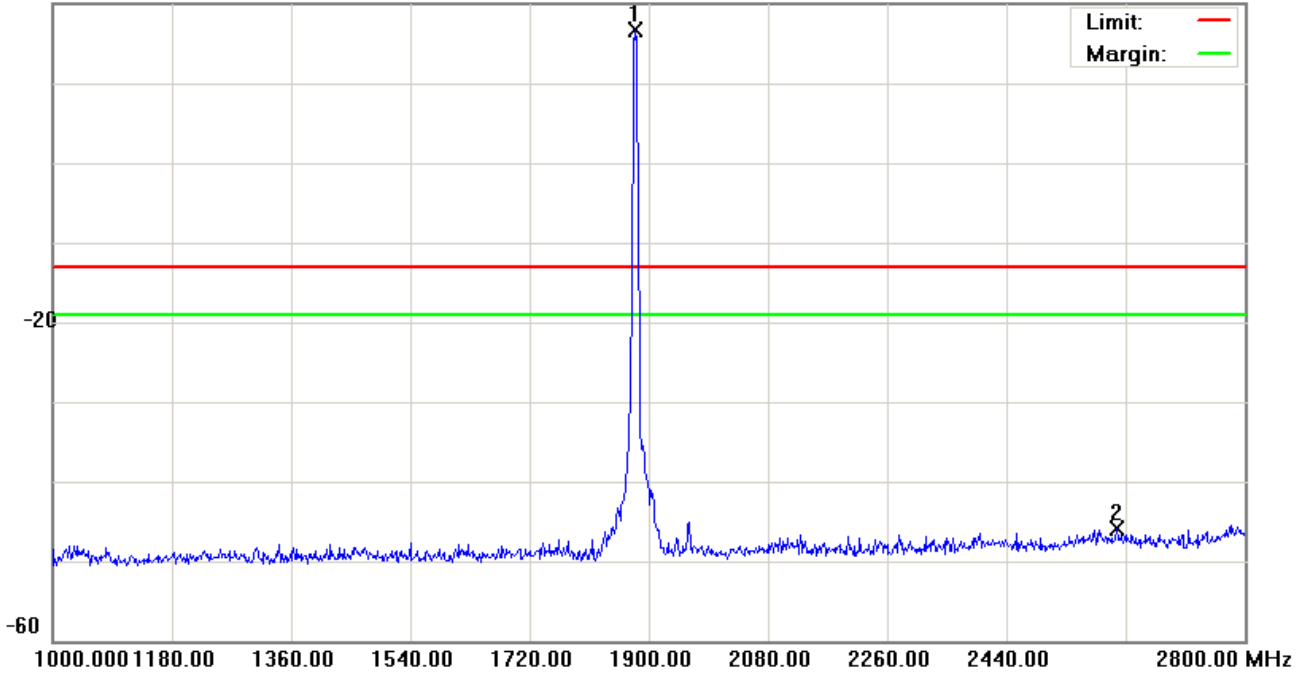

Site site #1

Phase: **Conducted po**

Temperature: 26 °C

Limit: FCC Part 24 conducted(9k-12.75G)

Power: AC 110V/60Hz

Humidity: 55 %

EUT:

M/N: 09-0088-EO

Mode: BAND II

Note: CH9400

加Notch(5TNF-1700)

No.	Mk.	Freq. MHz	Reading Level dBm	Correct Factor dB	Measure- ment dBm	Limit dBm	Over dB	Detector	Comment
1	*	1878.400	12.05	4.61	16.66	-13.00	29.66	peak	Main Frequency
2		2607.400	-51.41	5.45	-45.96	-13.00	-32.96	peak	

*:Maximum data x:Over limit !:over margin



Conducted Emission Measurement

File :M320(CH9400)

Data :#4

Date: 2009/5/21

Time: 上午 02:58:56

20.0 dBm

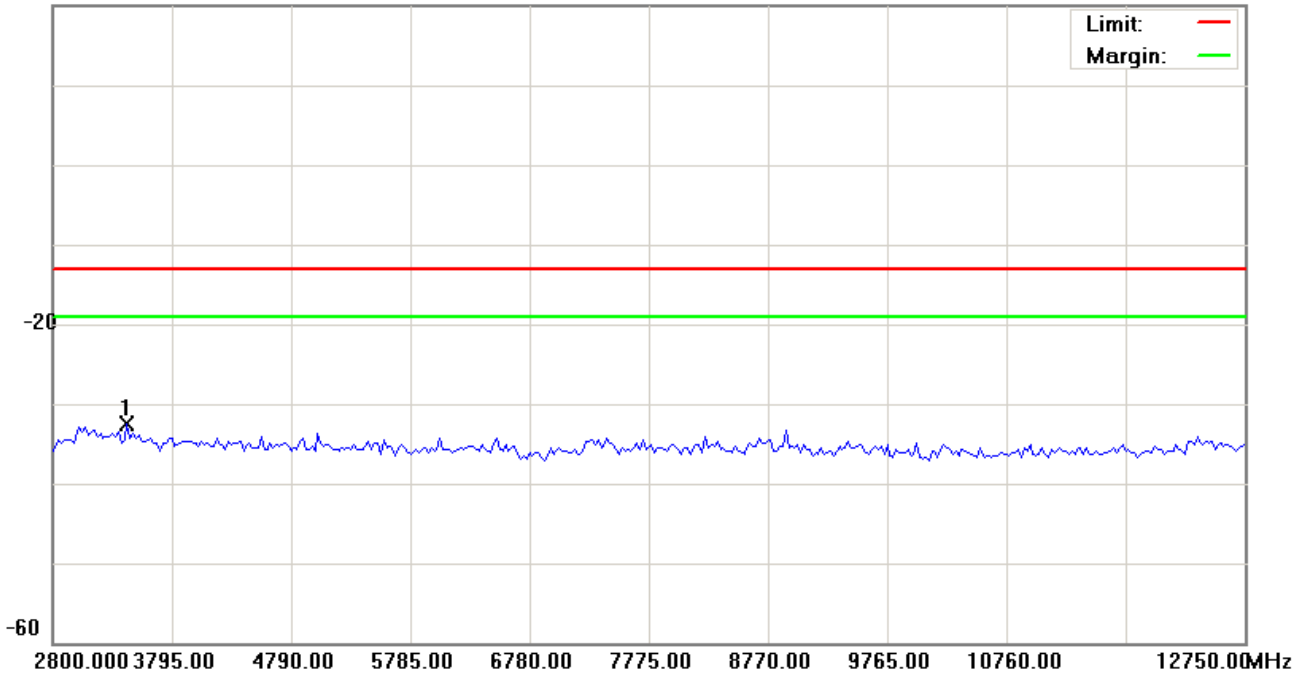

Site site #1

Phase: **Conducted po**

Temperature: 26 °C

Limit: FCC Part 24 conducted(9k-12.75G)

Power: AC 110V/60Hz

Humidity: 55 %

EUT:

M/N: 09-0088-EO

Mode: BAND II

Note: CH9400

No.	Mk.	Freq. MHz	Reading Level dBm	Correct Factor dB	Measure- ment dBm	Limit dBm	Over dB	Detector	Comment
1	*	3421.875	-37.60	5.06	-32.54	-13.00	-19.54	peak	

*:Maximum data x:Over limit !:over margin



Conducted Emission Measurement

File :M320(CH9400)

Data :#5

Date: 2009/5/21

Time: 上午 02:59:17

20.0 dBm

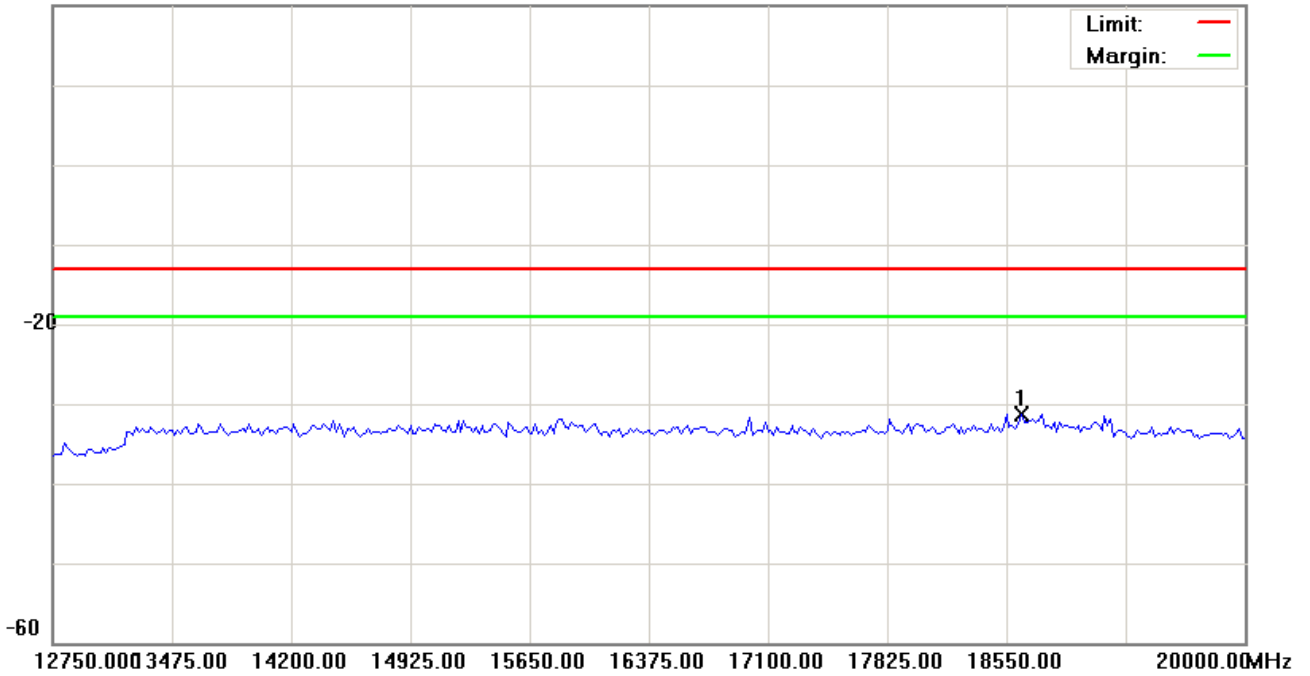

Site site #1

Phase: **Conducted po**

Temperature: 26 °C

Limit: FCC Part 24 conducted(9k-12.75G)

Power: AC 110V/60Hz

Humidity: 55 %

EUT:

M/N: 09-0088-EO

Mode: BAND II

Note: CH9400

No.	Mk.	Freq. MHz	Reading Level dBm	Correct Factor dB	Measure- ment dBm	Limit dBm	Over dB	Detector	Comment
1	*	18640.62	-38.34	7.05	-31.29	-13.00	-18.29	peak	

*:Maximum data x:Over limit !:over margin



Conducted Emission Measurement

File :M320(CH9538)

Data :#1

Date: 2009/5/21

Time: 上午 01:48:22

10.0 dBm

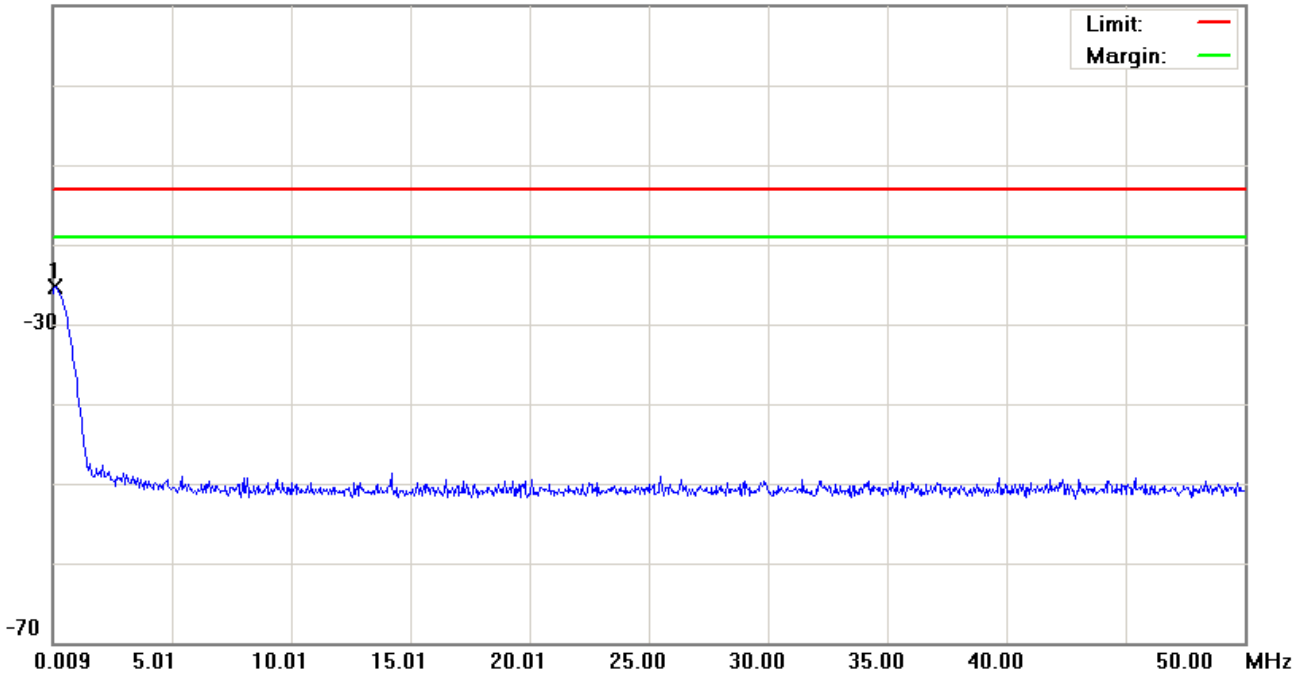

Site site #1

Phase: **Conducted po**

Temperature: 26 °C

Limit: FCC Part 24 conducted(9k-12.75G)

Power: AC 110V/60Hz

Humidity: 55 %

EUT:

M/N: 09-0088-EO

Mode: BAND II

Note: CH9538

加10db衰減器

No.	Mk.	Freq. MHz	Reading Level dBm	Correct Factor dB	Measure- ment dBm	Limit dBm	Over dB	Detector	Comment
1	*	0.1090	-37.72	12.49	-25.23	-13.00	-12.23	peak	

*:Maximum data x:Over limit !:over margin



Conducted Emission Measurement

File :M320(CH9538)

Data :#2

Date: 2009/5/21

Time: 上午 01:48:46

20.0 dBm

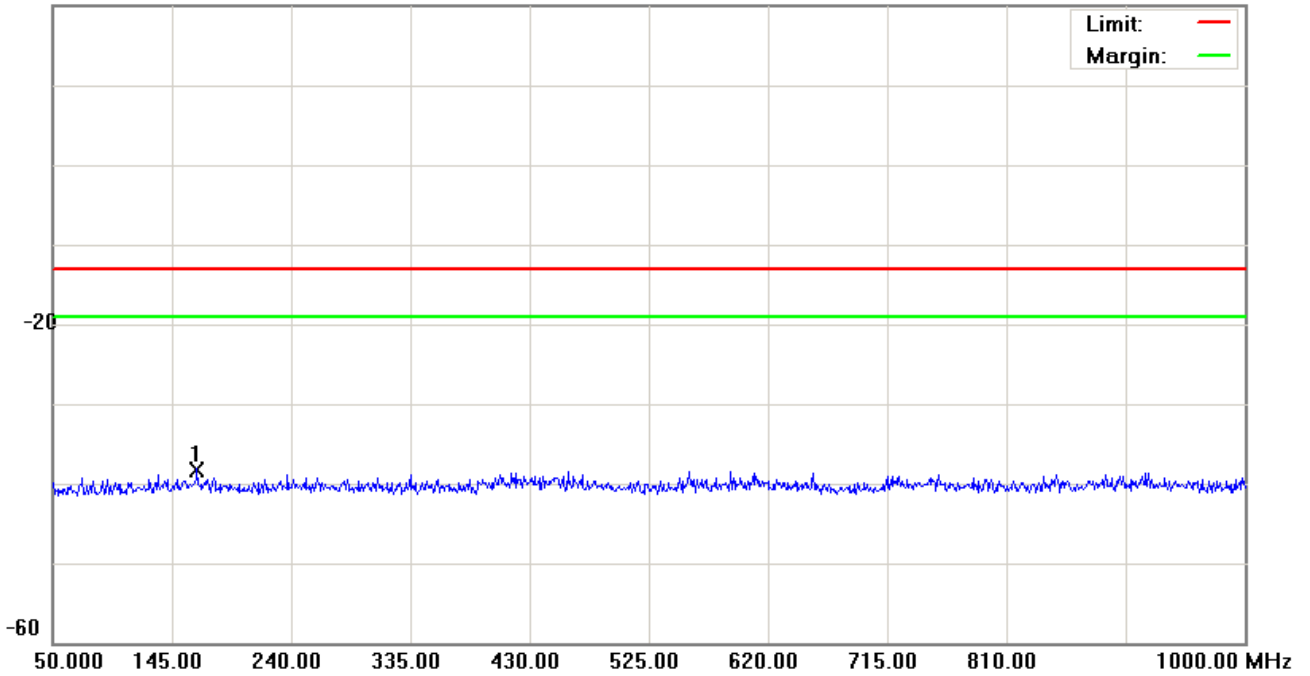

Site site #1

Phase: **Conducted po**

Temperature: 26 °C

Limit: FCC Part 24 conducted(9k-12.75G)

Power: AC 110V/60Hz

Humidity: 55 %

EUT:

M/N: 09-0088-EO

Mode: BAND II

Note: CH9538

加10db衰減器

No.	Mk.	Freq. MHz	Reading Level dBm	Correct Factor dB	Measure- ment dBm	Limit dBm	Over dB	Detector	Comment
1	*	164.9500	-51.55	13.35	-38.20	-13.00	-25.20	peak	

*:Maximum data x:Over limit !:over margin



Conducted Emission Measurement

File :M320(CH9538)
20.0 dBm

Data :#3

Date: 2009/5/21

Time: 上午 01:57:07

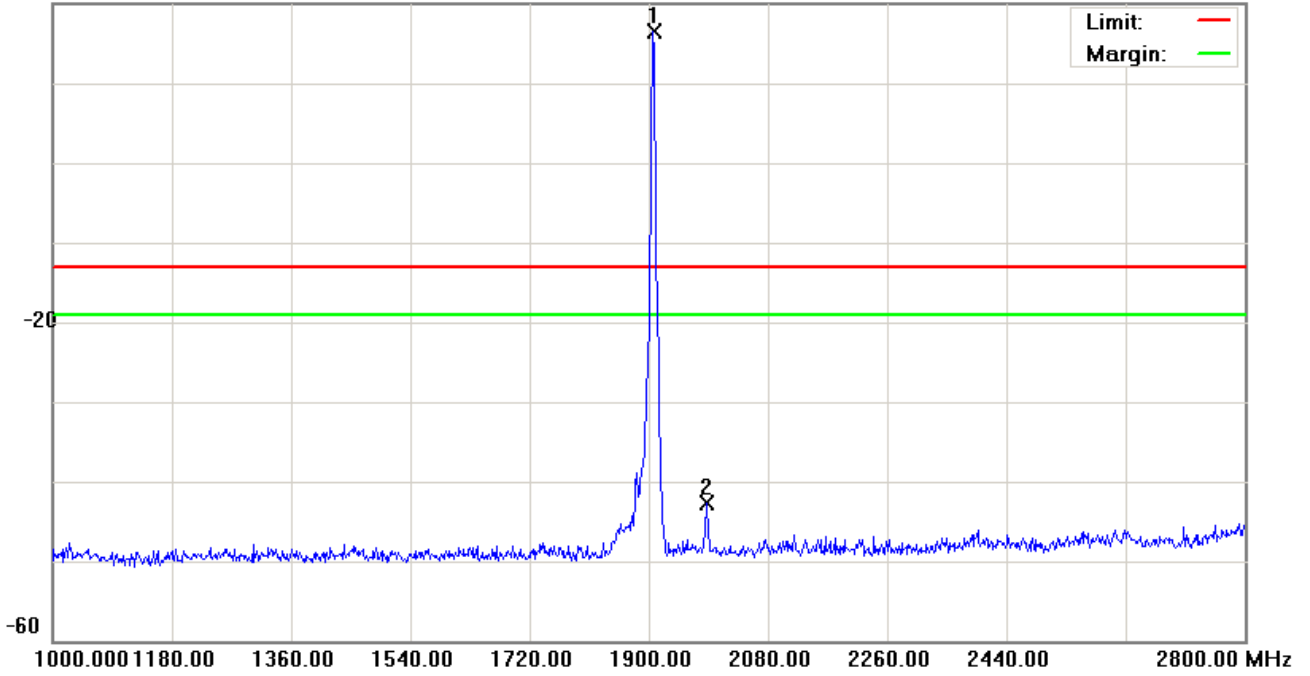

Site site #1

Phase: **Conducted po**

Temperature: 26 °C

Limit: FCC Part 24 conducted(9k-12.75G)

Power: AC 110V/60Hz

Humidity: 55 %

EUT:

M/N: 09-0088-EO

Mode: BAND II

Note: CH9538

加Notch(5TNF-1700)

No.	Mk.	Freq. MHz	Reading Level dBm	Correct Factor dB	Measure- ment dBm	Limit dBm	Over dB	Detector	Comment
1	*	1906.300	10.52	6.05	16.57	-13.00	29.57	peak	Main Frequency
2		1987.300	-47.46	4.67	-42.79	-13.00	-29.79	peak	

*:Maximum data x:Over limit !:over margin



Conducted Emission Measurement

File :M320(CH9538)

Data :#4

Date: 2009/5/21

Time: 上午 02:59:53

20.0 dBm

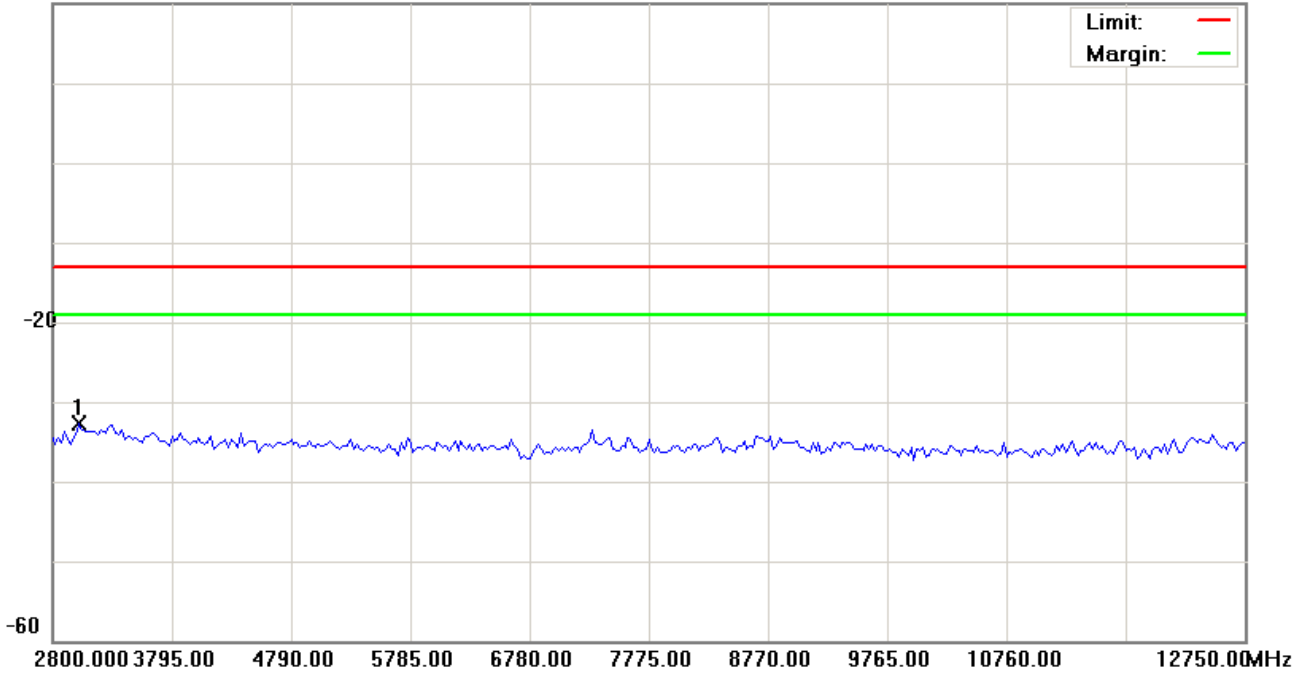

Site site #1

Phase: **Conducted po**

Temperature: 26 °C

Limit: FCC Part 24 conducted(9k-12.75G)

Power: AC 110V/60Hz

Humidity: 55 %

EUT:

M/N: 09-0088-EO

Mode: BAND II

Note: CH9538

No.	Mk.	Freq. MHz	Reading Level dBm	Correct Factor dB	Measure- ment dBm	Limit dBm	Over dB	Detector	Comment
1	*	3023.875	-38.24	5.48	-32.76	-13.00	-19.76	peak	

*:Maximum data x:Over limit !:over margin



Conducted Emission Measurement

File :M320(CH9538)

Data :#5

Date: 2009/5/21

Time: 上午 03:00:15

20.0 dBm

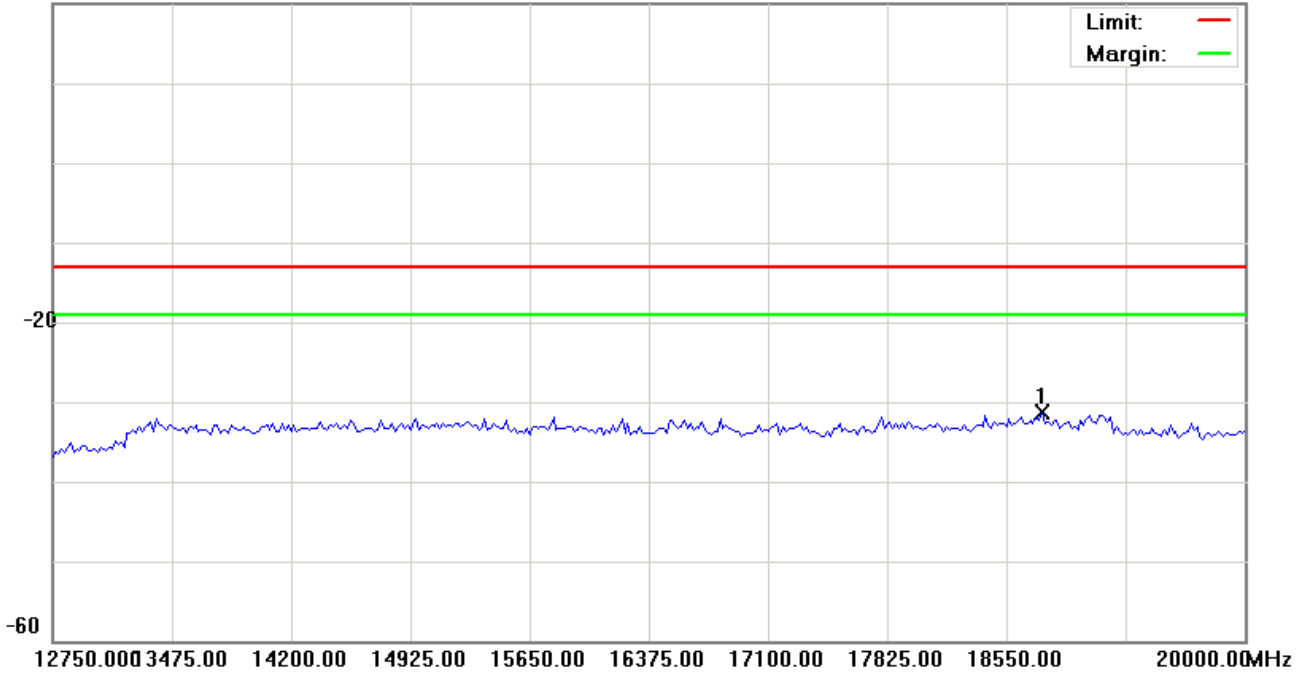

Site site #1

Phase: **Conducted po**

Temperature: 26 °C

Limit: FCC Part 24 conducted(9k-12.75G)

Power: AC 110V/60Hz

Humidity: 55 %

EUT:

M/N: 09-0088-EO

Mode: BAND II

Note: CH9538

No.	Mk.	Freq. MHz	Reading Level dBm	Correct Factor dB	Measure- ment dBm	Limit dBm	Over dB	Detector	Comment
1	*	18767.50	-38.47	7.09	-31.38	-13.00	-18.38	peak	

*:Maximum data x:Over limit !:over margin



4.6 Field Strength of Spurious Radiation

Equivalent isotropic radiated Power Measurements by substitution method according to ANSI/TIA/EIA-603-A.

4.6.1 Measurement Instruments

As described in chapter 5 of this test report.

4.6.2 Test Procedure

The measurement is made according to ANSI/TIA-603-C-2004 as follows:

The equipment under test is placed inside the semi-anechoic chamber on a wooden table at the turntable center. For each spurious frequency, the antenna mast is raised and lowered from 1 to 4 meters and the turntable is rotated 360 degrees to obtain a maximum reading on the spectrum analyzer. This is repeated for both horizontal and vertical polarizations of the receive antenna.

The equipment under test is then replaced with a substitution antenna fed by a signal generator. With the signal generator tuned to a particular spurious frequency, the antenna mast is raised and lowered from 1 to 4 meters to obtain a maximum reading at the spectrum analyzer. The output of the signal generator is then adjusted until a reading identical to that obtained with the actual transmitter is achieved.

The power in dBm of each spurious emission is calculated by correcting the signal generator level for cable loss and gain of the substitution antenna referenced to a dipole. A fully charged battery was used for the supply voltage.

The settings of the receiver were as follows:

Units	dBm
Resolution Bandwidth	1 MHz
Video Bandwidth	Auto
Sweep Time	Auto

4.6.3 Test Setup Layout

Substituted Method Test Set-up

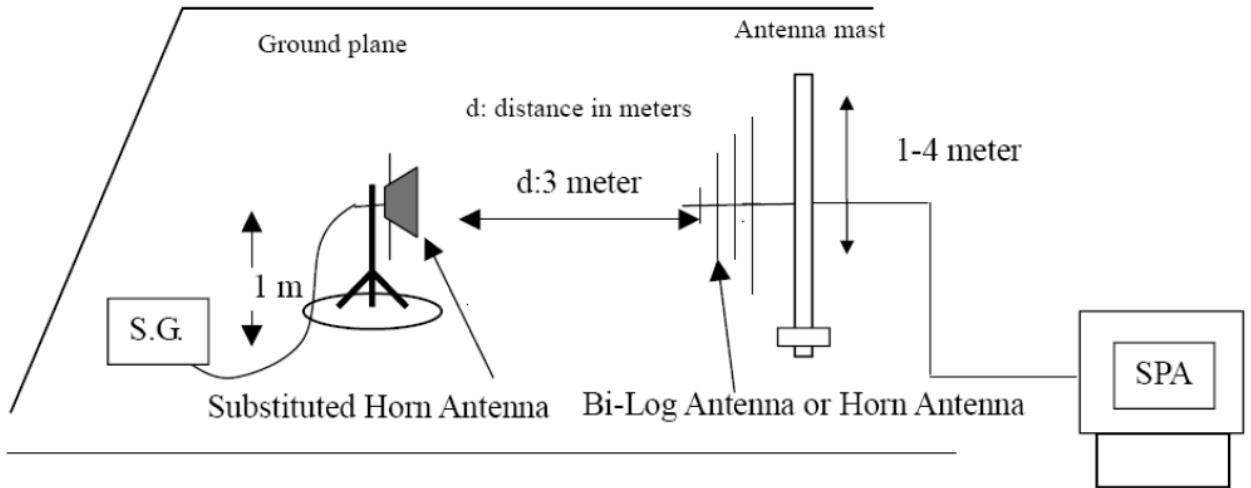



4.6.4 Test Result (Original test)

4.6.4.1 GSM 850 Test Result

Applicant : Elitegroup Computer Systems Co., LTD.
 Model No : M320/M320A/M320B
 EUT : HSDPA mini-PCle Modem Module
 Test Mode : GSM 850 (Low CH128)
 Test Date : 05/21/2009

Harmonic	Frequency (MHz)	Polarization	FCC Max. Limit	S.G Power	Substitution Antenna Gain	Cable Loss	Peak Output Power
			(dBm)	(dBm)	(dBi)	(dBm)	(dBm)
2nd	1648.8	V	-13	-47.01	10.72	0.56	-36.85
3rd	2473.2	V	-13	-45.98	10.66	0.62	-35.94
4th	3297.6	V	-13	-39.01	10.78	0.74	-28.97
5th	4122.0	V	-13	*	*	*	*
6th	4946.4	V	-13	*	*	*	*
7th	5770.8	V	-13	*	*	*	*
8th	6595.2	V	-13	*	*	*	*
9th	7419.6	V	-13	*	*	*	*
10th	8244.0	V	-13	*	*	*	*
2nd	1648.8	H	-13	-54.65	10.72	0.56	-44.49
3rd	2473.2	H	-13	-51.07	10.66	0.62	-41.03
4th	3297.6	H	-13	-38.46	10.78	0.74	-28.42
5th	4122.0	H	-13	*	*	*	*
6th	4946.4	H	-13	*	*	*	*
7th	5770.8	H	-13	*	*	*	*
8th	6595.2	H	-13	*	*	*	*
9th	7419.6	H	-13	*	*	*	*
10th	8244.0	H	-13	*	*	*	*

Notes:

- * Indicates the spurious emission could not be detected due to noise limitations or ambients.
- Each emission reported reflects the highest absolute level at the specific harmonic for the low, mid, and high channels at maximum power.
- The Spectrum was investigated from 30 MHz to the tenth harmonic of the fundamental.
- ERP = S.G Power (dBm) + Substitution Antenna Gain (dBd) - Cable Loss (dB)
 ERP = S.G Power (dBm) + Substitution Antenna Gain (dBi) - Cable Loss (dB)

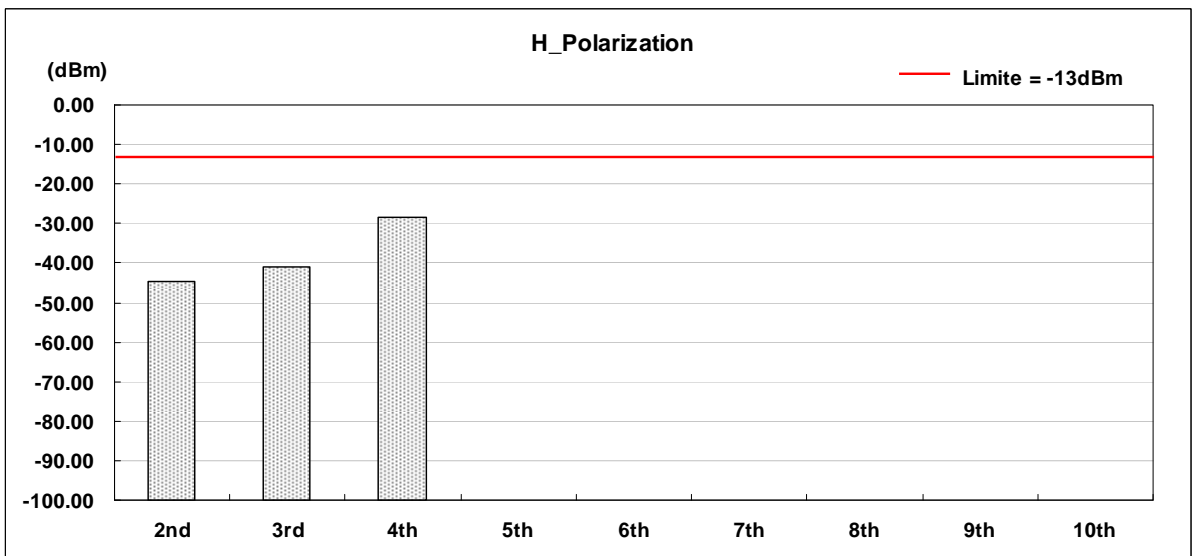
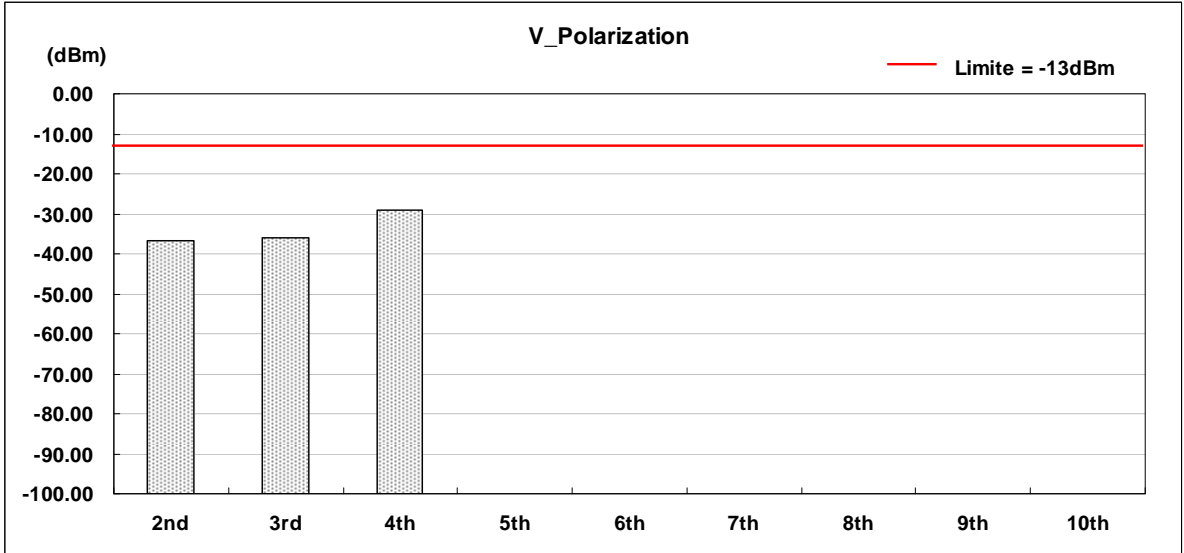



Applicant : Elitegroup Computer Systems Co., LTD.
 Model No : M320/M320A/M320B
 EUT : HSDPA mini-PCle Modem Module
 Test Mode : GSM 850 (Middle CH190)
 Test Date : 05/21/2009

Harmonic	Frequency (MHz)	Polarization	FCC Max. Limit	S.G Power	Substitution Antenna Gain	Cable Loss	Peak Output Power
			(dBm)	(dBm)	(dBi)	(dBm)	(dBm)
2nd	1673.2	V	-13	-50.20	10.72	0.56	-40.04
3rd	2509.8	V	-13	-47.71	10.66	0.62	-37.67
4th	3346.4	V	-13	-39.21	10.78	0.74	-29.17
5th	4183.0	V	-13	*	*	*	*
6th	5019.6	V	-13	*	*	*	*
7th	5856.2	V	-13	*	*	*	*
8th	6692.8	V	-13	*	*	*	*
9th	7529.4	V	-13	*	*	*	*
10th	8366.0	V	-13	*	*	*	*
2nd	1673.2	H	-13	-49.54	10.72	0.56	-39.38
3rd	2509.8	H	-13	-46.12	10.66	0.62	-36.08
4th	3346.4	H	-13	-39.49	10.78	0.74	-29.45
5th	4183.0	H	-13	*	*	*	*
6th	5019.6	H	-13	*	*	*	*
7th	5856.2	H	-13	*	*	*	*
8th	6692.8	H	-13	*	*	*	*
9th	7529.4	H	-13	*	*	*	*
10th	8366.0	H	-13	*	*	*	*

Notes:

- * Indicates the spurious emission could not be detected due to noise limitations or ambients.
- Each emission reported reflects the highest absolute level at the specific harmonic for the low, mid, and high channels at maximum power.
- The Spectrum was investigated from 30 MHz to the tenth harmonic of the fundamental.
- ERP = S.G Power (dBm) + Substitution Antenna Gain (dBd) - Cable Loss (dB)
 ERP = S.G Power (dBm) + Substitution Antenna Gain (dBi) - Cable Loss (dB)

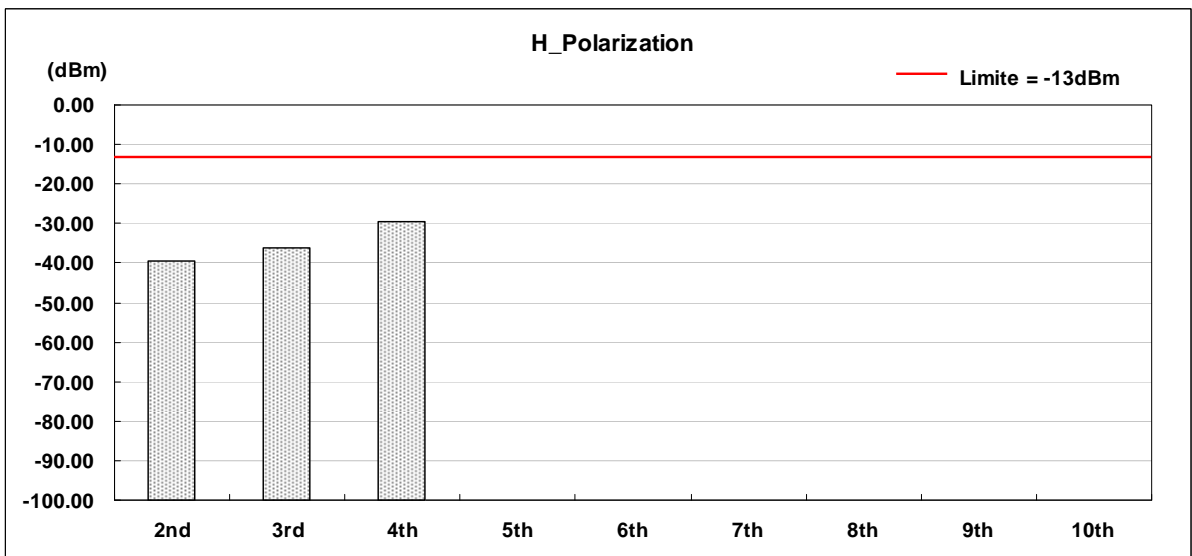
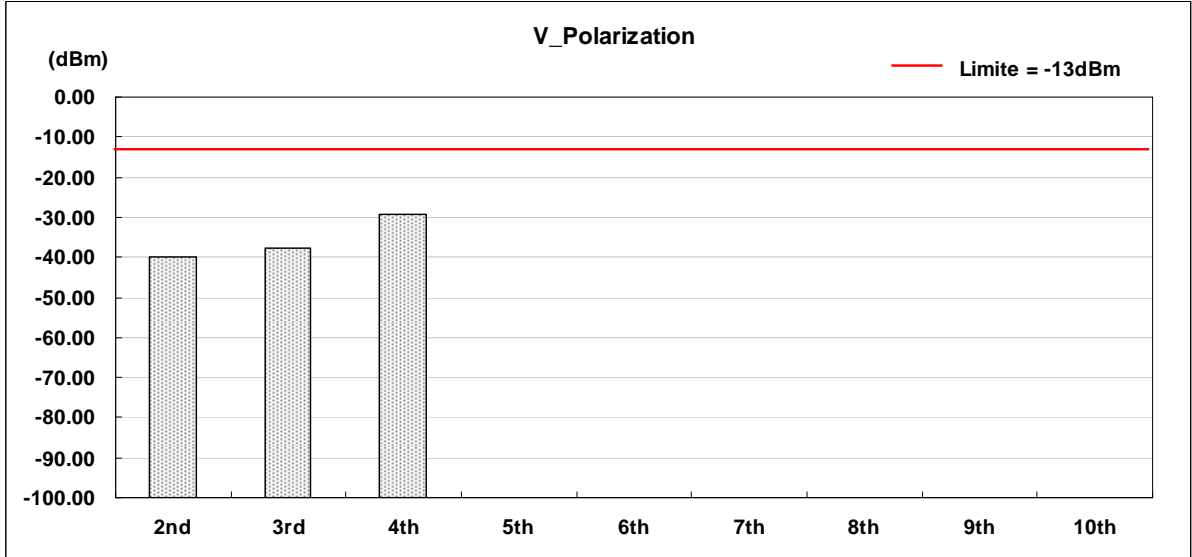



Applicant : Elitegroup Computer Systems Co., LTD.
 Model No : M320/M320A/M320B
 EUT : HSDPA mini-PCle Modem Module
 Test Mode : GSM 850 (High CH 251)
 Test Date : 05/21/2009

Harmonic	Frequency (MHz)	Polarization	FCC Max. Limit	S.G Power	Substitution Antenna Gain	Cable Loss	Peak Output Power
			(dBm)	(dBm)	(dBi)	(dBm)	(dBm)
2nd	1697.6	V	-13	-47.17	10.72	0.56	-37.01
3rd	2546.4	V	-13	-39.95	10.66	0.62	-29.91
4th	3395.2	V	-13	-38.69	10.78	0.74	-28.65
5th	4244.0	V	-13	*	*	*	*
6th	5092.8	V	-13	*	*	*	*
7th	5941.6	V	-13	*	*	*	*
8th	6790.4	V	-13	*	*	*	*
9th	7639.2	V	-13	*	*	*	*
10th	8488.0	V	-13	*	*	*	*
2nd	1697.6	H	-13	-54.10	10.72	0.56	-43.94
3rd	2546.4	H	-13	-47.65	10.66	0.62	-37.61
4th	3395.2	H	-13	-38.78	10.78	0.74	-28.74
5th	4244.0	H	-13	*	*	*	*
6th	5092.8	H	-13	*	*	*	*
7th	5941.6	H	-13	*	*	*	*
8th	6790.4	H	-13	*	*	*	*
9th	7639.2	H	-13	*	*	*	*
10th	8488.0	H	-13	*	*	*	*

Notes:

- * Indicates the spurious emission could not be detected due to noise limitations or ambients.
- Each emission reported reflects the highest absolute level at the specific harmonic for the low, mid, and high channels at maximum power.
- The Spectrum was investigated from 30 MHz to the tenth harmonic of the fundamental.
- ERP = S.G Power (dBm) + Substitution Antenna Gain (dBd) - Cable Loss (dB)
 ERP = S.G Power (dBm) + Substitution Antenna Gain (dBi) - Cable Loss (dB)

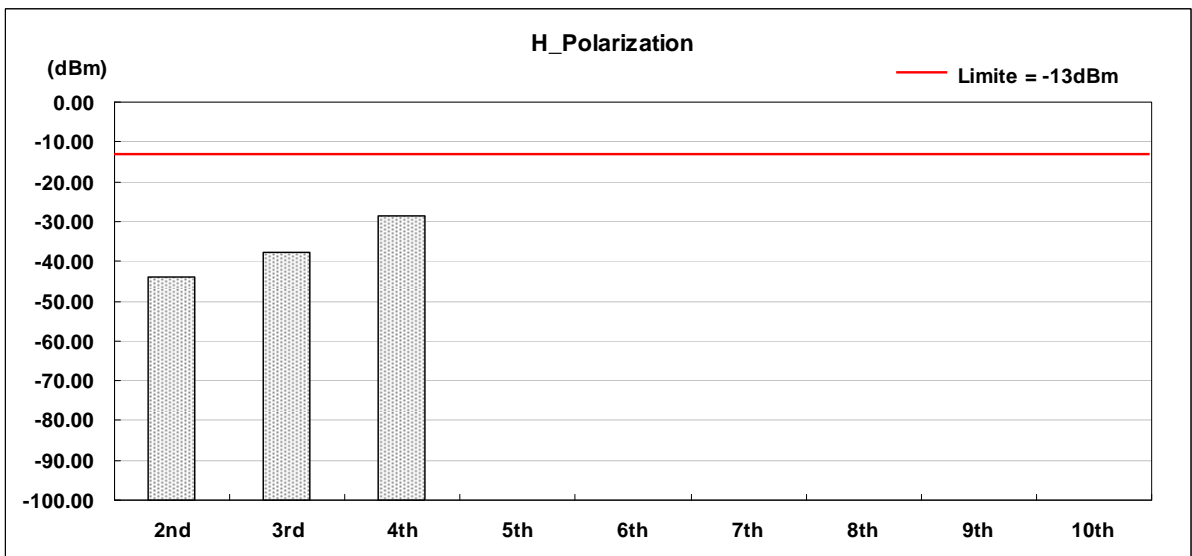
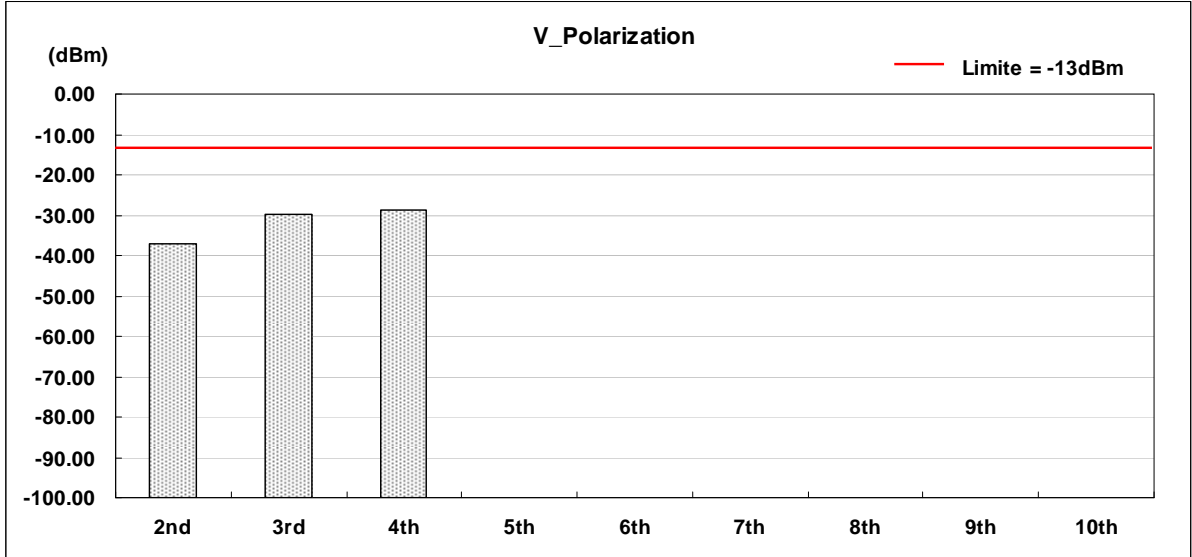



4.6.4.2 GSM 1900 Test Result

Applicant : Elitegroup Computer Systems Co., LTD.
 Model No : M320/M320A/M320B
 EUT : HSDPA mini-PCle Modem Module
 Test Mode : GSM 1900 (Low CH512)
 Test Date : 05/21/2009

Harmonic	Frequency (MHz)	Polarization	FCC Max. Limit	S.G Power	Substitution Antenna Gain	Cable Loss	Peak Output Power
			(dBm)	(dBm)	(dBi)	(dBm)	(dBm)
2nd	3700.4	V	-13	-44.16	10.72	0.56	-34.00
3rd	5550.6	V	-13	-37.94	10.66	0.62	-27.90
4th	7400.8	V	-13	-27.92	10.78	0.74	-17.88
5th	9251.0	V	-13	*	*	*	*
6th	11101.2	V	-13	*	*	*	*
7th	12951.4	V	-13	*	*	*	*
8th	14801.6	V	-13	*	*	*	*
9th	16651.8	V	-13	*	*	*	*
10th	18502.0	V	-13	*	*	*	*
2nd	3700.4	H	-13	-49.42	10.72	0.56	-39.26
3rd	5550.6	H	-13	-38.38	10.66	0.62	-28.34
4th	7400.8	H	-13	-28.39	10.78	0.74	-18.35
5th	9251.0	H	-13	*	*	*	*
6th	11101.2	H	-13	*	*	*	*
7th	12951.4	H	-13	*	*	*	*
8th	14801.6	H	-13	*	*	*	*
9th	16651.8	H	-13	*	*	*	*
10th	18502.0	H	-13	*	*	*	*

Notes:

- * Indicates the spurious emission could not be detected due to noise limitations or ambients.
- Each emission reported reflects the highest absolute level at the specific harmonic for the low, mid, and high channels at maximum power.
- The Spectrum was investigated from 30 MHz to the tenth harmonic of the fundamental.
- ERP = S.G Power (dBm) + Substitution Antenna Gain (dBd) - Cable Loss (dB)
 ERP = S.G Power (dBm) + Substitution Antenna Gain (dBi) - Cable Loss (dB)

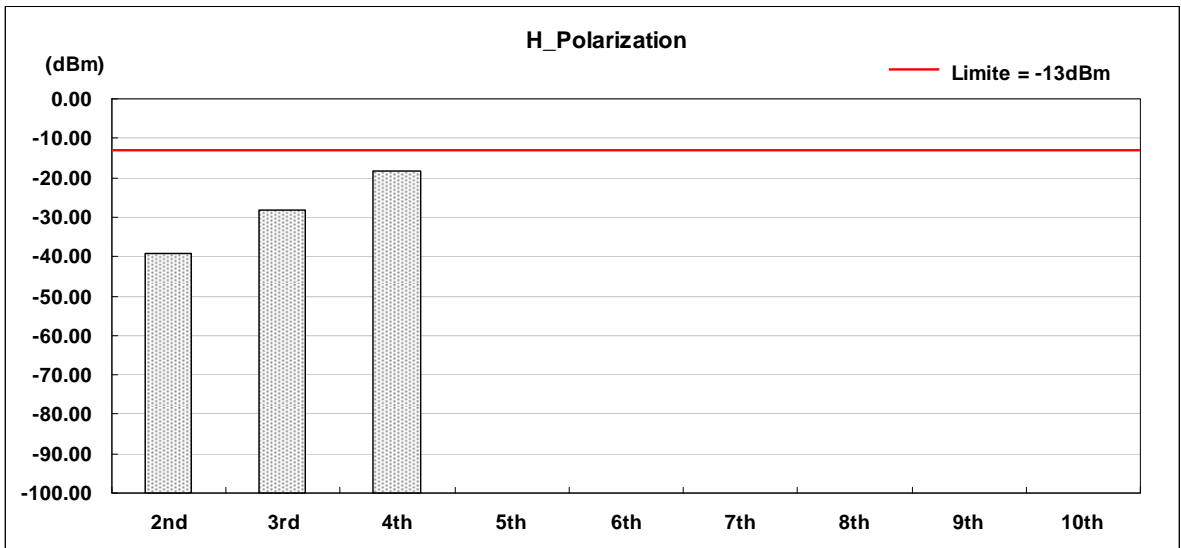
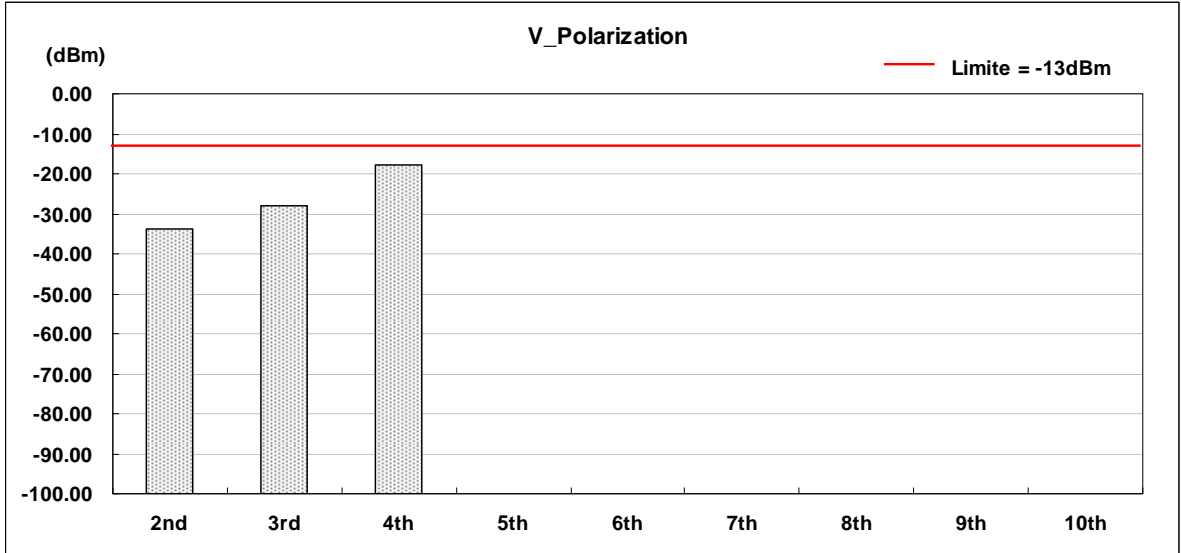



Applicant : Elitegroup Computer Systems Co., LTD.
 Model No : M320/M320A/M320B
 EUT : HSDPA mini-PCle Modem Module
 Test Mode : GSM 1900 (Middle CH661)
 Test Date : 05/21/2009

Harmonic	Frequency (MHz)	Polarization	FCC Max. Limit	S.G Power	Substitution Antenna Gain	Cable Loss	Peak Output Power
			(dBm)	(dBm)	(dBi)	(dBm)	(dBm)
2nd	3760.0	V	-13	-45.34	10.72	0.56	-35.18
3rd	5640.0	V	-13	-38.61	10.66	0.62	-28.57
4th	7520.0	V	-13	-27.76	10.78	0.74	-17.72
5th	9400.0	V	-13	*	*	*	*
6th	11280.0	V	-13	*	*	*	*
7th	13160.0	V	-13	*	*	*	*
8th	15040.0	V	-13	*	*	*	*
9th	16920.0	V	-13	*	*	*	*
10th	18800.0	V	-13	*	*	*	*
2nd	3760.0	H	-13	-52.59	10.72	0.56	-42.43
3rd	5640.0	H	-13	-38.29	10.66	0.62	-28.25
4th	7520.0	H	-13	-28.13	10.78	0.74	-18.09
5th	9400.0	H	-13	*	*	*	*
6th	11280.0	H	-13	*	*	*	*
7th	13160.0	H	-13	*	*	*	*
8th	15040.0	H	-13	*	*	*	*
9th	16920.0	H	-13	*	*	*	*
10th	18800.0	H	-13	*	*	*	*

Notes:

- * Indicates the spurious emission could not be detected due to noise limitations or ambients.
- Each emission reported reflects the highest absolute level at the specific harmonic for the low, mid, and high channels at maximum power.
- The Spectrum was investigated from 30 MHz to the tenth harmonic of the fundamental.
- ERP = S.G Power (dBm) + Substitution Antenna Gain (dBd) - Cable Loss (dB)
 ERP = S.G Power (dBm) + Substitution Antenna Gain (dBi) - Cable Loss (dB)

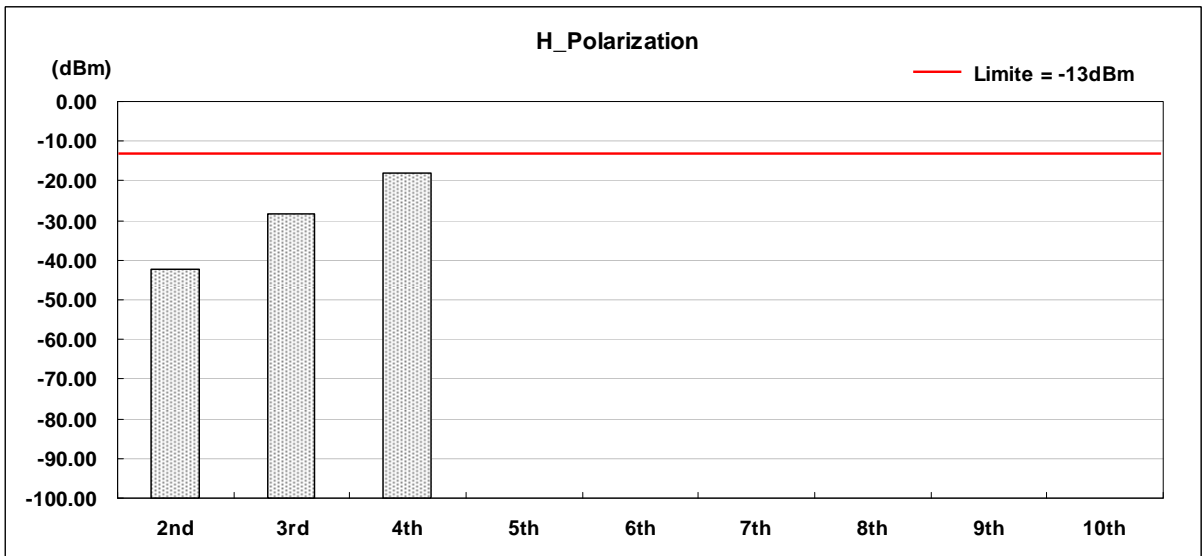
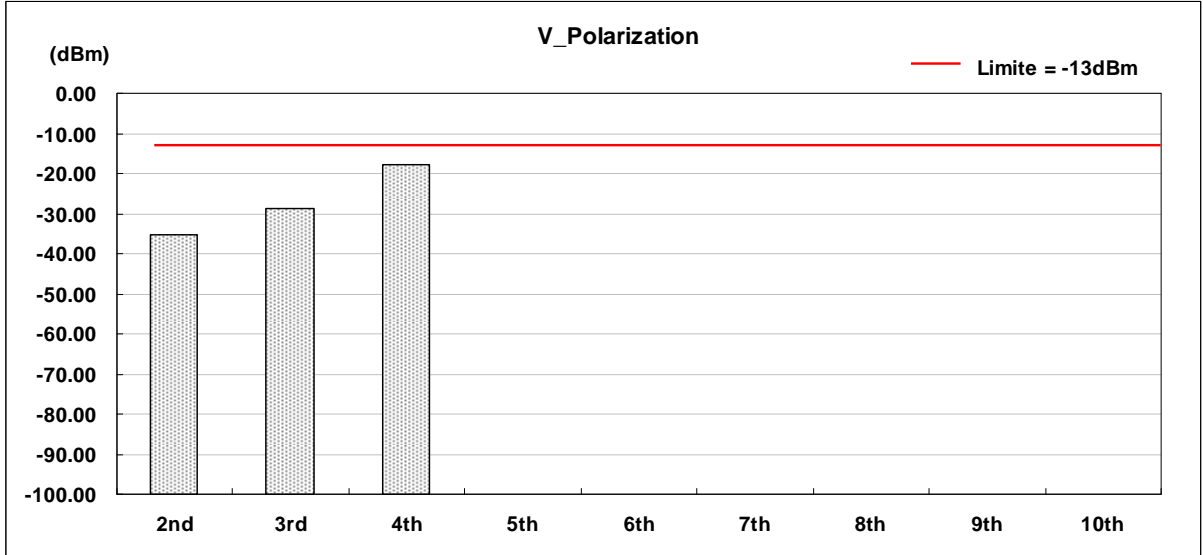



Applicant : Elitegroup Computer Systems Co., LTD.
 Model No : M320/M320A/M320B
 EUT : HSDPA mini-PCle Modem Module
 Test Mode : GSM 1900 (High CH 810)
 Test Date : 05/21/2009

Harmonic	Frequency (MHz)	Polarization	FCC Max. Limit	S.G Power	Substitution Antenna Gain	Cable Loss	Peak Output Power
			(dBm)	(dBm)	(dBi)	(dBm)	(dBm)
2nd	3819.6	V	-13	-47.51	10.72	0.56	-37.35
3rd	5729.4	V	-13	-38.52	10.66	0.62	-28.48
4th	7639.2	V	-13	-27.96	10.78	0.74	-17.92
5th	9549.0	V	-13	*	*	*	*
6th	11458.8	V	-13	*	*	*	*
7th	13368.6	V	-13	*	*	*	*
8th	15278.4	V	-13	*	*	*	*
9th	17188.2	V	-13	*	*	*	*
10th	19098.0	V	-13	*	*	*	*
2nd	3819.6	H	-13	-52.77	10.72	0.56	-42.61
3rd	5729.4	H	-13	-38.46	10.66	0.62	-28.42
4th	7639.2	H	-13	-27.80	10.78	0.74	-17.76
5th	9549.0	H	-13	*	*	*	*
6th	11458.8	H	-13	*	*	*	*
7th	13368.6	H	-13	*	*	*	*
8th	15278.4	H	-13	*	*	*	*
9th	17188.2	H	-13	*	*	*	*
10th	19098.0	H	-13	*	*	*	*

Notes:

- * Indicates the spurious emission could not be detected due to noise limitations or ambients.
- Each emission reported reflects the highest absolute level at the specific harmonic for the low, mid, and high channels at maximum power.
- The Spectrum was investigated from 30 MHz to the tenth harmonic of the fundamental.
- ERP = S.G Power (dBm) + Substitution Antenna Gain (dBd) - Cable Loss (dB)
 ERP = S.G Power (dBm) + Substitution Antenna Gain (dBi) - Cable Loss (dB)

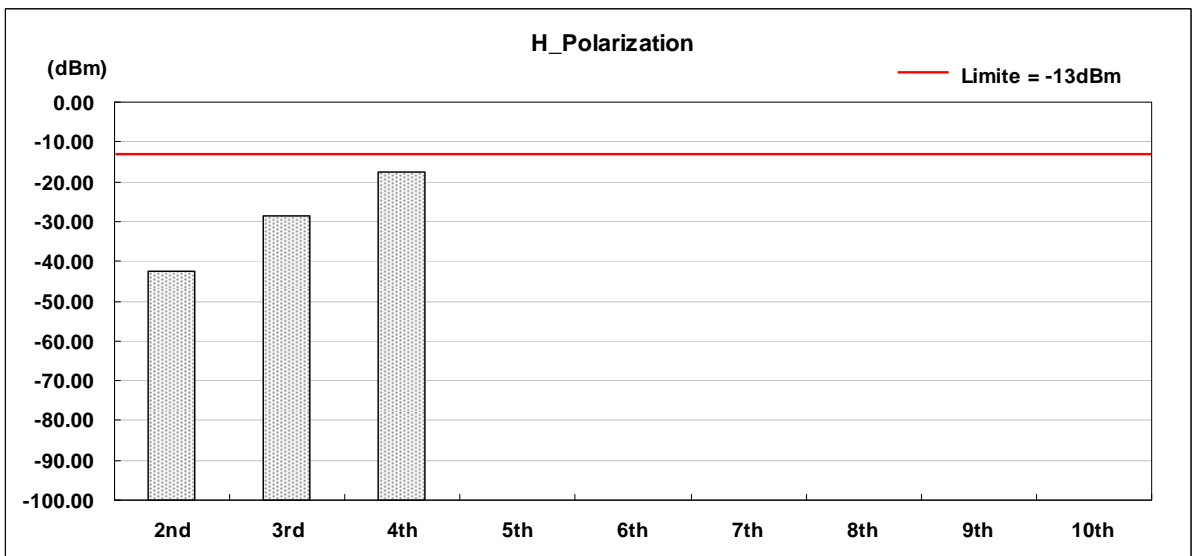
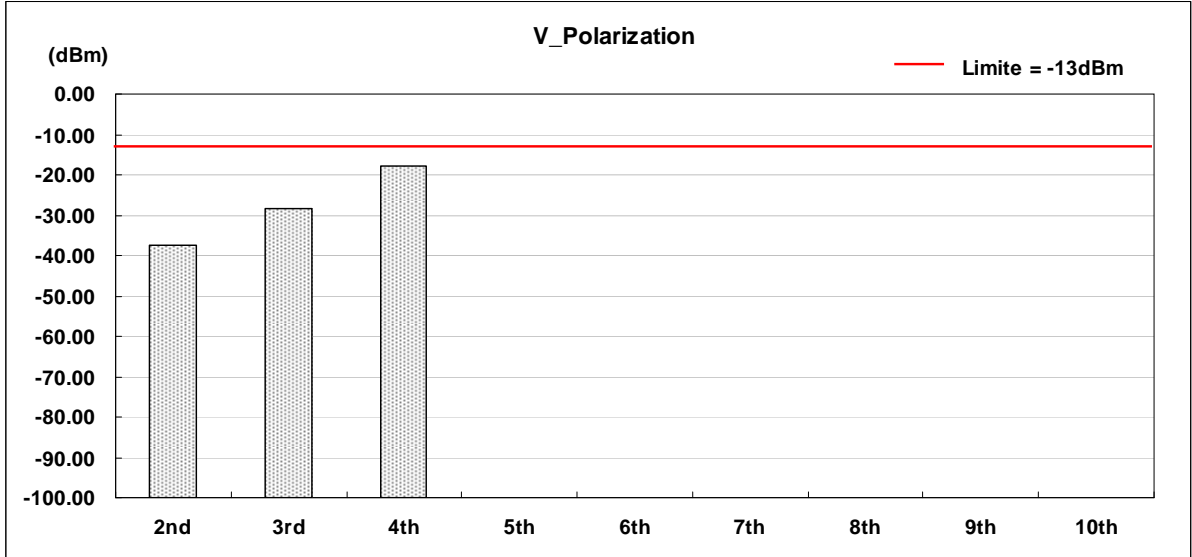



4.6.4.3 WCDMA Band V Test Result

Applicant : Elitegroup Computer Systems Co., LTD.
 Model No : M320/M320A/M320B
 EUT : HSDPA mini-PCle Modem Module
 Test Mode : WCDMA Band V (Low CH4132)
 Test Date : 05/21/2009

Harmonic	Frequency (MHz)	Polarization	FCC Max. Limit	S.G Power	Substitution Antenna Gain	Cable Loss	Peak Output Power
			(dBm)	(dBm)	(dBi)	(dBm)	(dBm)
2nd	1652.8	V	-13	-45.70	10.74	0.59	-35.55
3rd	2479.2	V	-13	-49.42	10.68	0.63	-39.37
4th	3305.6	V	-13	-38.54	10.80	0.78	-28.52
5th	4132.0	V	-13	*	*	*	*
6th	4958.4	V	-13	*	*	*	*
7th	5784.8	V	-13	*	*	*	*
8th	6611.2	V	-13	*	*	*	*
9th	7437.6	V	-13	*	*	*	*
10th	8264.0	V	-13	*	*	*	*
2nd	1652.8	H	-13	-53.71	10.74	0.59	-43.56
3rd	2479.2	H	-13	-54.32	10.68	0.63	-44.27
4th	3305.6	H	-13	-38.68	10.80	0.78	-28.66
5th	4132.0	H	-13	*	*	*	*
6th	4958.4	H	-13	*	*	*	*
7th	5784.8	H	-13	*	*	*	*
8th	6611.2	H	-13	*	*	*	*
9th	7437.6	H	-13	*	*	*	*
10th	8264.0	H	-13	*	*	*	*

Notes:

- * Indicates the spurious emission could not be detected due to noise limitations or ambients.
- Each emission reported reflects the highest absolute level at the specific harmonic for the low, mid, and high channels at maximum power.
- The Spectrum was investigated from 30 MHz to the tenth harmonic of the fundamental.
- ERP = S.G Power (dBm) + Substitution Antenna Gain (dBd) - Cable Loss (dB)
 ERP = S.G Power (dBm) + Substitution Antenna Gain (dBi) - Cable Loss (dB)

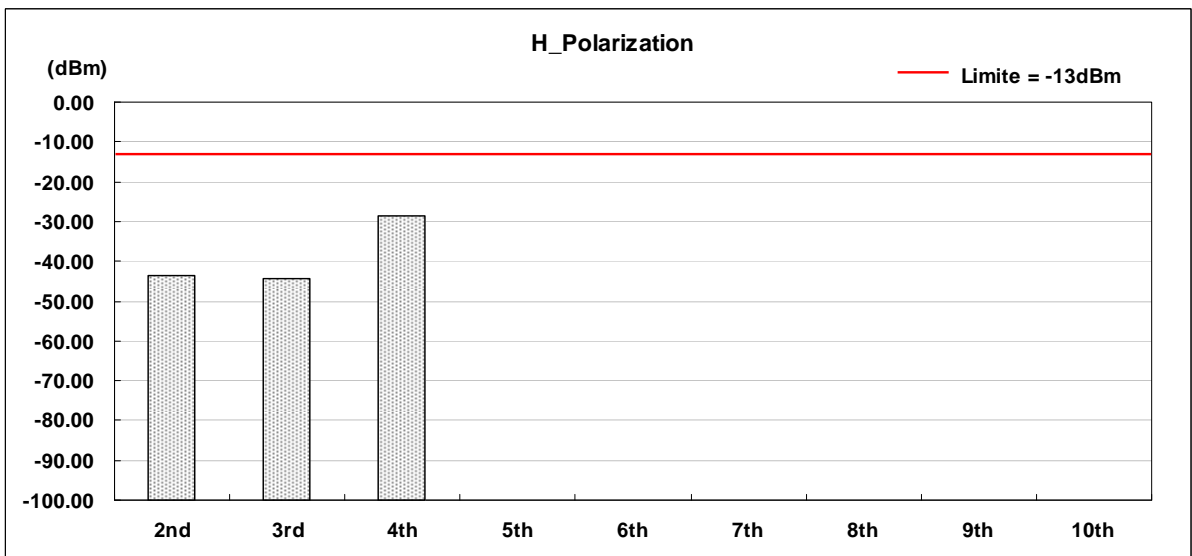
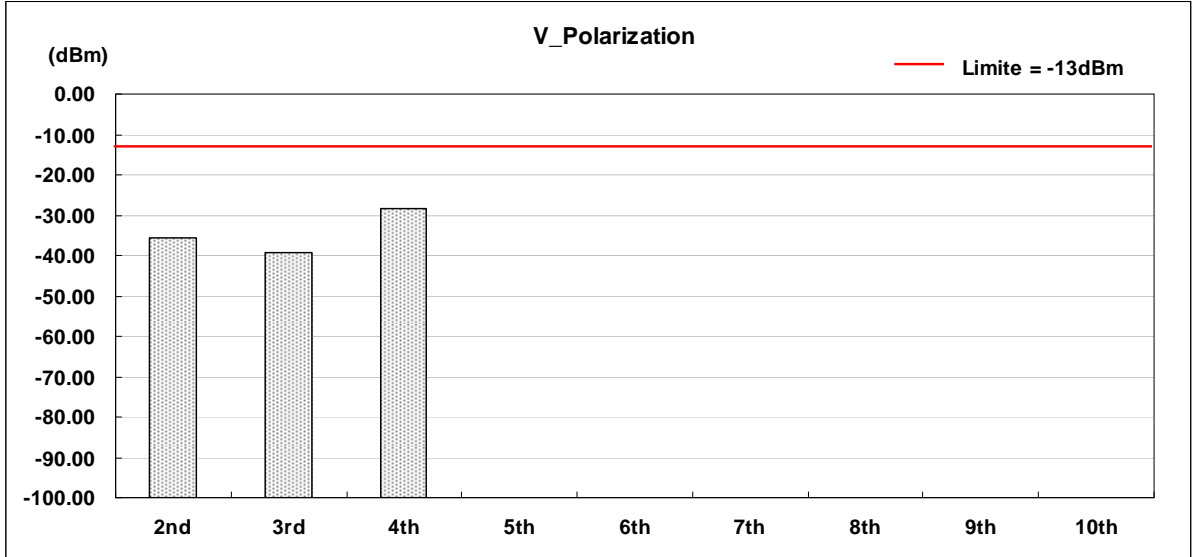



Applicant : Elitegroup Computer Systems Co., LTD.
 Model No : M320/M320A/M320B
 EUT : HSDPA mini-PCIe Modem Module
 Test Mode : WCDMA Band V (Middle CH4182)
 Test Date : 05/21/2009

Harmonic	Frequency (MHz)	Polarization	FCC Max. Limit	S.G Power	Substitution Antenna Gain	Cable Loss	Peak Output Power
			(dBm)	(dBm)	(dBi)	(dBm)	(dBm)
2nd	1693.2	V	-13	-46.65	10.74	0.59	-36.50
3rd	2539.8	V	-13	-48.09	10.68	0.63	-38.04
4th	3386.4	V	-13	-38.94	10.80	0.78	-28.92
5th	4233.0	V	-13	*	*	*	*
6th	5079.6	V	-13	*	*	*	*
7th	5926.2	V	-13	*	*	*	*
8th	6772.8	V	-13	*	*	*	*
9th	7619.4	V	-13	*	*	*	*
10th	8466.0	V	-13	*	*	*	*
2nd	1693.2	H	-13	-52.88	10.74	0.59	-42.73
3rd	2539.8	H	-13	-53.04	10.68	0.63	-42.99
4th	3386.4	H	-13	-38.47	10.80	0.78	-28.45
5th	4233.0	H	-13	*	*	*	*
6th	5079.6	H	-13	*	*	*	*
7th	5926.2	H	-13	*	*	*	*
8th	6772.8	H	-13	*	*	*	*
9th	7619.4	H	-13	*	*	*	*
10th	8466.0	H	-13	*	*	*	*

Notes:

- * Indicates the spurious emission could not be detected due to noise limitations or ambients.
- Each emission reported reflects the highest absolute level at the specific harmonic for the low, mid, and high channels at maximum power.
- The Spectrum was investigated from 30 MHz to the tenth harmonic of the fundamental.
- ERP = S.G Power (dBm) + Substitution Antenna Gain (dBd) - Cable Loss (dB)
 ERP = S.G Power (dBm) + Substitution Antenna Gain (dBi) - Cable Loss (dB)

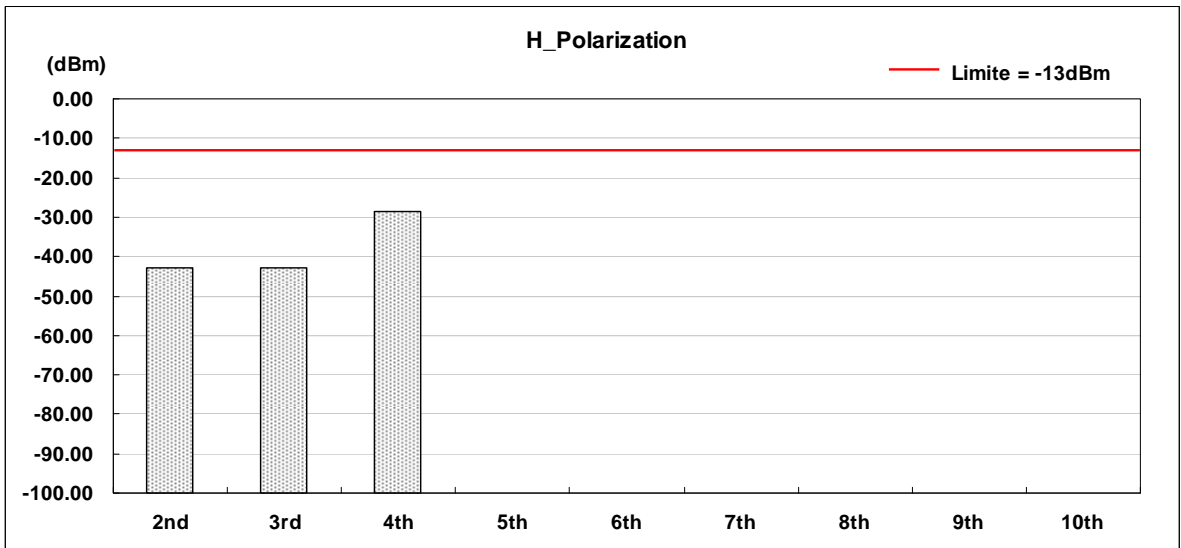
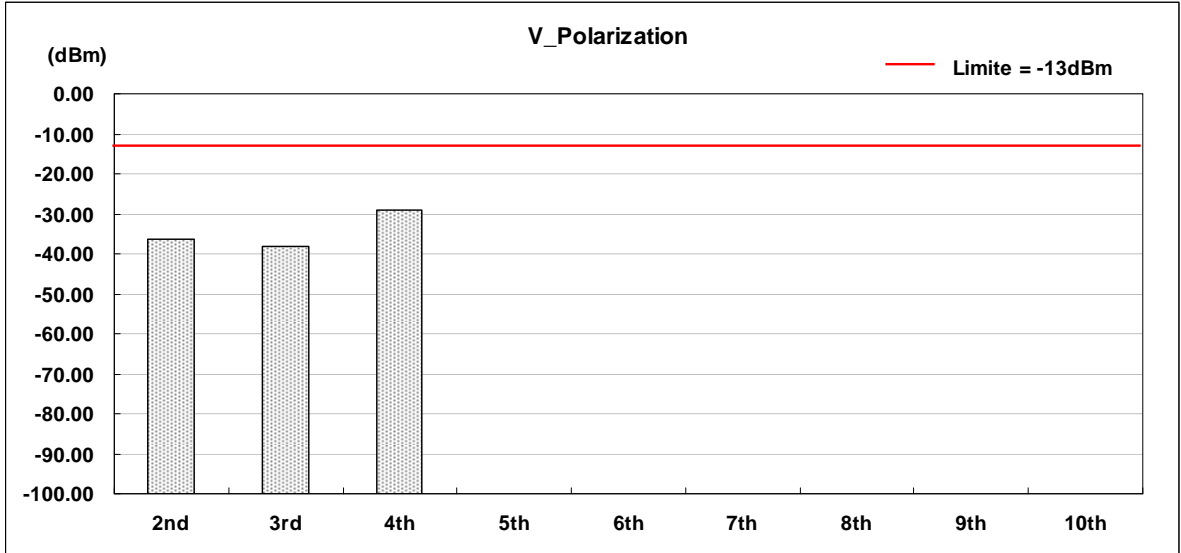



Applicant : Elitegroup Computer Systems Co., LTD.
 Model No : M320/M320A/M320B
 EUT : HSDPA mini-PCIe Modem Module
 Test Mode : WCDMA Band V (High CH 4233)
 Test Date : 05/21/2009

Harmonic	Frequency (MHz)	Polarization	FCC Max. Limit	S.G Power	Substitution Antenna Gain	Cable Loss	Peak Output Power
			(dBm)	(dBm)	(dBi)	(dBm)	(dBm)
2nd	1693.2	V	-13	-47.86	10.74	0.59	-37.71
3rd	2539.8	V	-13	-55.09	10.68	0.63	-45.04
4th	3386.4	V	-13	-39.17	10.80	0.78	-29.15
5th	4233.0	V	-13	*	*	*	*
6th	5079.6	V	-13	*	*	*	*
7th	5926.2	V	-13	*	*	*	*
8th	6772.8	V	-13	*	*	*	*
9th	7619.4	V	-13	*	*	*	*
10th	8466.0	V	-13	*	*	*	*
2nd	1693.2	H	-13	-54.21	10.74	0.59	-44.06
3rd	2539.8	H	-13	-55.59	10.68	0.63	-45.54
4th	3386.4	H	-13	-39.07	10.80	0.78	-29.05
5th	4233.0	H	-13	*	*	*	*
6th	5079.6	H	-13	*	*	*	*
7th	5926.2	H	-13	*	*	*	*
8th	6772.8	H	-13	*	*	*	*
9th	7619.4	H	-13	*	*	*	*
10th	8466.0	H	-13	*	*	*	*

Notes:

- * Indicates the spurious emission could not be detected due to noise limitations or ambients.
- Each emission reported reflects the highest absolute level at the specific harmonic for the low, mid, and high channels at maximum power.
- The Spectrum was investigated from 30 MHz to the tenth harmonic of the fundamental.
- ERP = S.G Power (dBm) + Substitution Antenna Gain (dBd) - Cable Loss (dB)
 ERP = S.G Power (dBm) + Substitution Antenna Gain (dBi) - Cable Loss (dB)

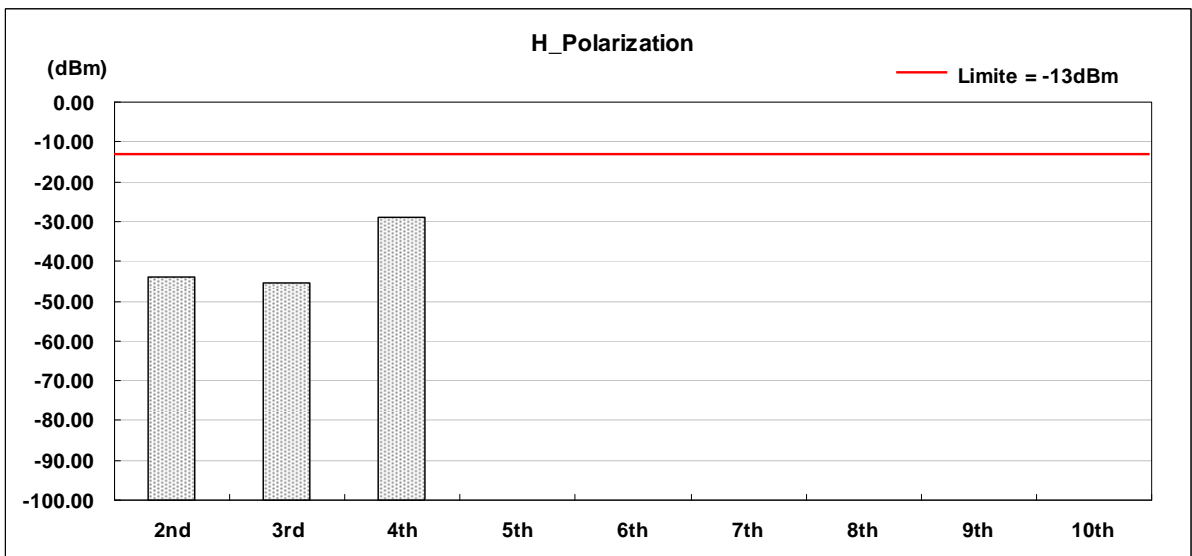
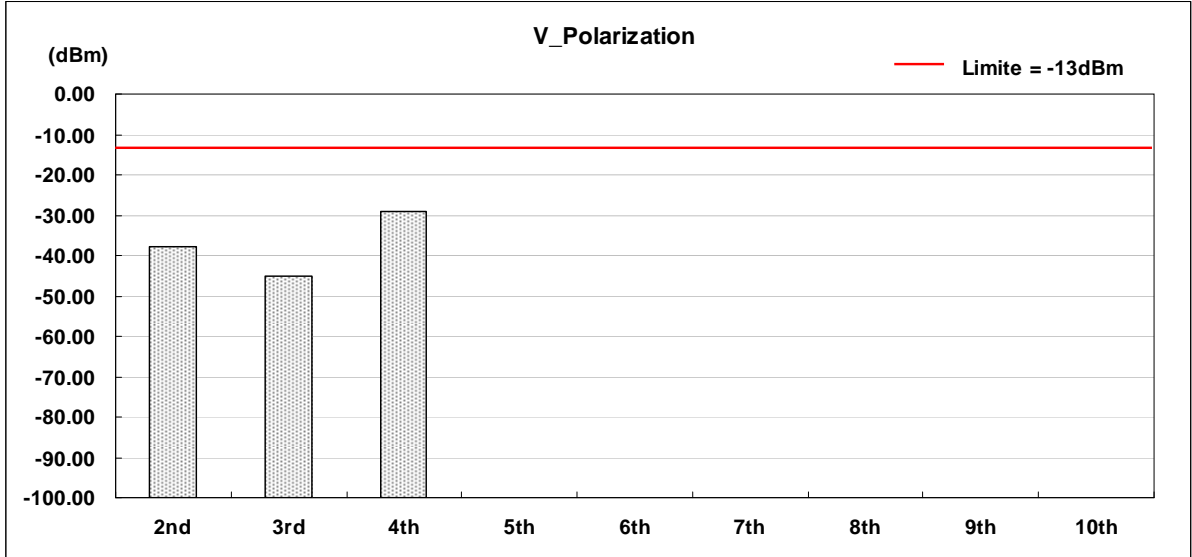



4.6.4.4 WCDMA Band II Test Result

Applicant : Elitegroup Computer Systems Co., LTD.
 Model No : M320/M320A/M320B
 EUT : HSDPA mini-PCle Modem Module
 Test Mode : WCDMA Band II (Low CH9262)
 Test Date : 05/21/2009

Harmonic	Frequency (MHz)	Polarization	FCC Max. Limit	S.G Power	Substitution Antenna Gain	Cable Loss	Peak Output Power
			(dBm)	(dBm)	(dBi)	(dBm)	(dBm)
2nd	3704.8	V	-13	-47.50	10.79	0.58	-37.29
3rd	5557.2	V	-13	-38.64	10.71	0.63	-28.56
4th	7409.6	V	-13	-28.07	10.81	0.78	-18.04
5th	9262.0	V	-13	*	*	*	*
6th	11114.4	V	-13	*	*	*	*
7th	12966.8	V	-13	*	*	*	*
8th	14819.2	V	-13	*	*	*	*
9th	16671.6	V	-13	*	*	*	*
10th	18524.0	V	-13	*	*	*	*
2nd	3704.8	H	-13	-45.36	10.79	0.58	-35.15
3rd	5557.2	H	-13	-38.72	10.71	0.63	-28.64
4th	7409.6	H	-13	-27.86	10.81	0.78	-17.83
5th	9262.0	H	-13	*	*	*	*
6th	11114.4	H	-13	*	*	*	*
7th	12966.8	H	-13	*	*	*	*
8th	14819.2	H	-13	*	*	*	*
9th	16671.6	H	-13	*	*	*	*
10th	18524.0	H	-13	*	*	*	*

Notes:

- * Indicates the spurious emission could not be detected due to noise limitations or ambients.
- Each emission reported reflects the highest absolute level at the specific harmonic for the low, mid, and high channels at maximum power.
- The Spectrum was investigated from 30 MHz to the tenth harmonic of the fundamental.
- ERP = S.G Power (dBm) + Substitution Antenna Gain (dBd) - Cable Loss (dB)
 ERP = S.G Power (dBm) + Substitution Antenna Gain (dBi) - Cable Loss (dB)

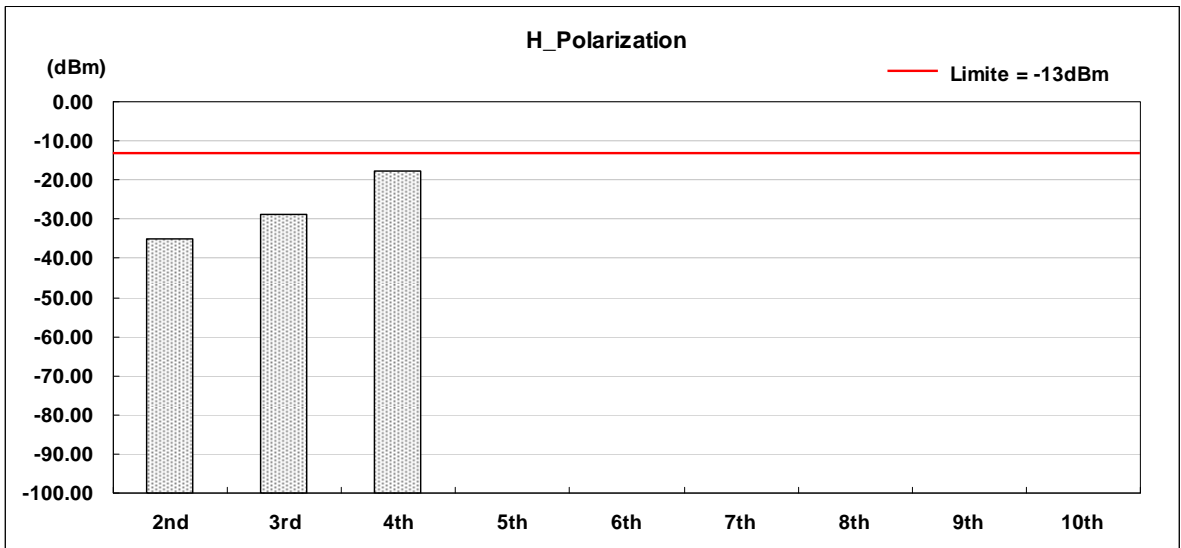
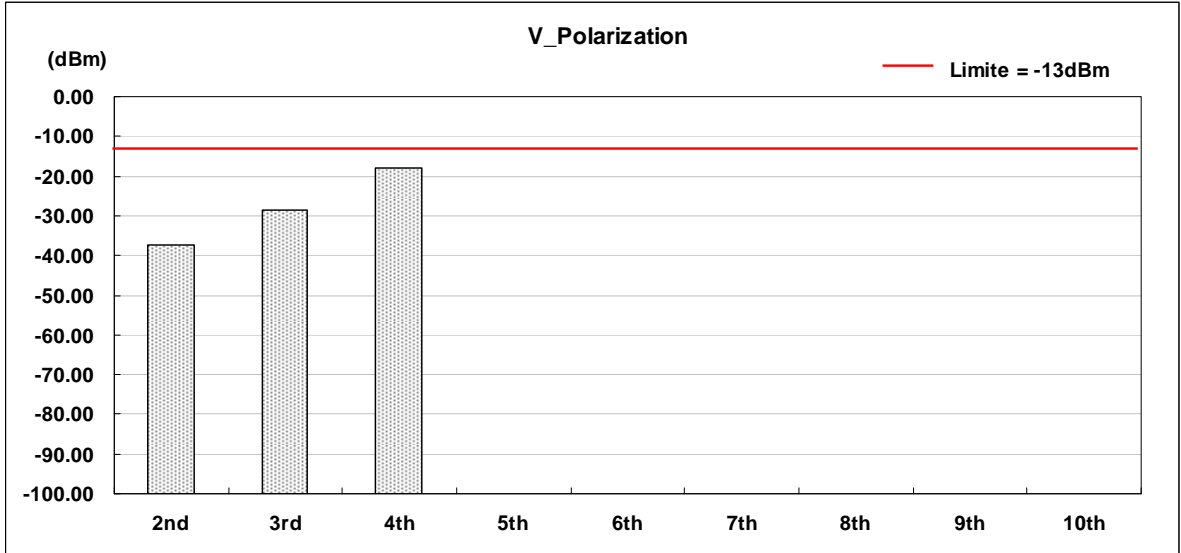



Applicant : Elitegroup Computer Systems Co., LTD.
 Model No : M320/M320A/M320B
 EUT : HSDPA mini-PCle Modem Module
 Test Mode : WCDMA Band II (Middle CH9400)
 Test Date : 05/21/2009

Harmonic	Frequency (MHz)	Polarization	FCC Max. Limit	S.G Power	Substitution Antenna Gain	Cable Loss	Peak Output Power
			(dBm)	(dBm)	(dBi)	(dBm)	(dBm)
2nd	3760.0	V	-13	-41.95	10.79	0.58	-31.74
3rd	5640.0	V	-13	-39.02	10.71	0.63	-28.94
4th	7520.0	V	-13	-27.52	10.81	0.78	-17.49
5th	9400.0	V	-13	*	*	*	*
6th	11280.0	V	-13	*	*	*	*
7th	13160.0	V	-13	*	*	*	*
8th	15040.0	V	-13	*	*	*	*
9th	16920.0	V	-13	*	*	*	*
10th	18800.0	V	-13	*	*	*	*
2nd	3760.0	H	-13	-41.51	10.79	0.58	-31.30
3rd	5640.0	H	-13	-38.08	10.71	0.63	-28.00
4th	7520.0	H	-13	-27.67	10.81	0.78	-17.64
5th	9400.0	H	-13	*	*	*	*
6th	11280.0	H	-13	*	*	*	*
7th	13160.0	H	-13	*	*	*	*
8th	15040.0	H	-13	*	*	*	*
9th	16920.0	H	-13	*	*	*	*
10th	18800.0	H	-13	*	*	*	*

Notes:

5. * Indicates the spurious emission could not be detected due to noise limitations or ambients.
6. Each emission reported reflects the highest absolute level at the specific harmonic for the low, mid, and high channels at maximum power.
7. The Spectrum was investigated from 30 MHz to the tenth harmonic of the fundamental.
8. ERP = S.G Power (dBm) + Substitution Antenna Gain (dBd) - Cable Loss (dB)
 ERP = S.G Power (dBm) + Substitution Antenna Gain (dBi) - Cable Loss (dB)

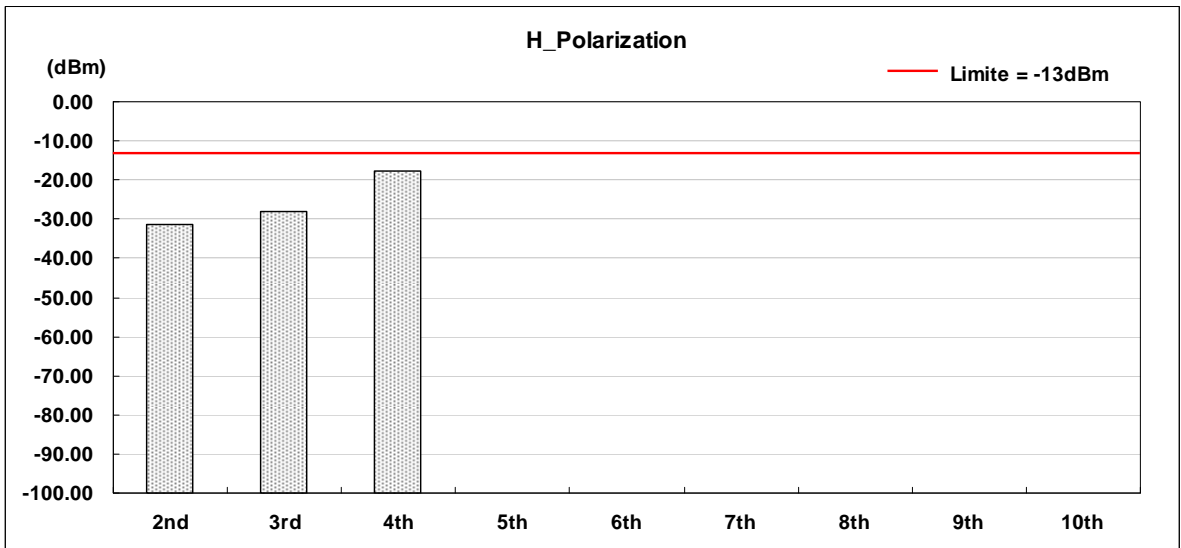
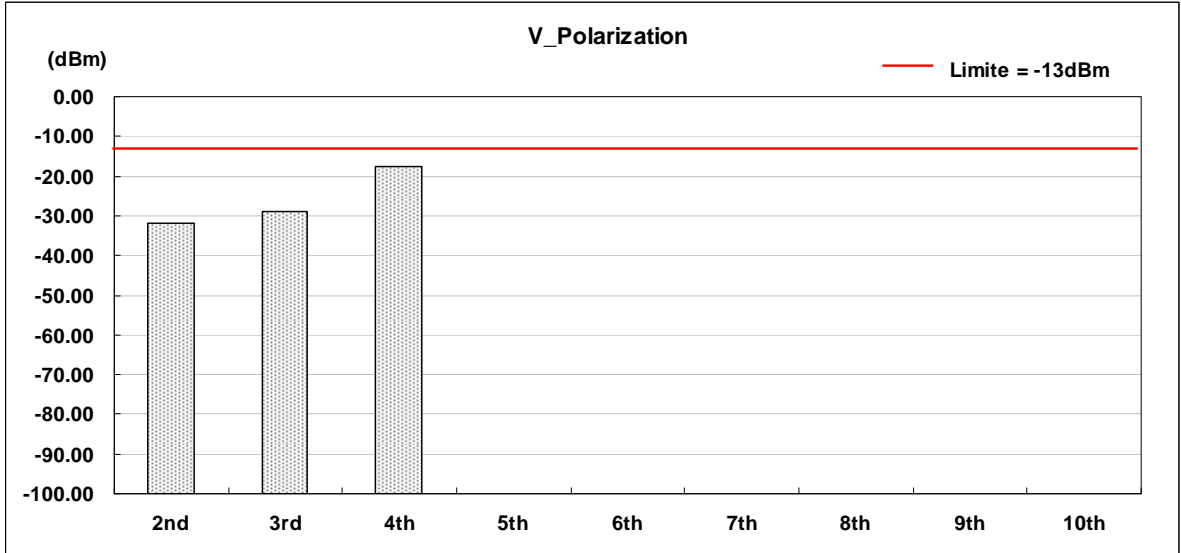



Applicant : Elitegroup Computer Systems Co., LTD.
 Model No : M320/M320A/M320B
 EUT : HSDPA mini-PCle Modem Module
 Test Mode : WCDMA Band II (High CH 9538)
 Test Date : 05/21/2009

Harmonic	Frequency (MHz)	Polarization	FCC Max. Limit	S.G Power	Substitution Antenna Gain	Cable Loss	Peak Output Power
			(dBm)	(dBm)	(dBi)	(dBm)	(dBm)
2nd	3815.2	V	-13	-39.28	10.79	0.58	-29.07
3rd	5722.8	V	-13	-38.72	10.71	0.63	-28.64
4th	7630.4	V	-13	-27.81	10.81	0.78	-17.78
5th	9538.0	V	-13	*	*	*	*
6th	11445.6	V	-13	*	*	*	*
7th	13353.2	V	-13	*	*	*	*
8th	15260.8	V	-13	*	*	*	*
9th	17168.4	V	-13	*	*	*	*
10th	19076.0	V	-13	*	*	*	*
2nd	3815.2	H	-13	-39.97	10.79	0.58	-29.76
3rd	5722.8	H	-13	-38.75	10.71	0.63	-28.67
4th	7630.4	H	-13	-27.43	10.81	0.78	-17.40
5th	9538.0	H	-13	*	*	*	*
6th	11445.6	H	-13	*	*	*	*
7th	13353.2	H	-13	*	*	*	*
8th	15260.8	H	-13	*	*	*	*
9th	17168.4	H	-13	*	*	*	*
10th	19076.0	H	-13	*	*	*	*

Notes:

5. * Indicates the spurious emission could not be detected due to noise limitations or ambients.
6. Each emission reported reflects the highest absolute level at the specific harmonic for the low, mid, and high channels at maximum power.
7. The Spectrum was investigated from 30 MHz to the tenth harmonic of the fundamental.
8. ERP = S.G Power (dBm) + Substitution Antenna Gain (dBd) - Cable Loss (dB)
 ERP = S.G Power (dBm) + Substitution Antenna Gain (dBi) - Cable Loss (dB)

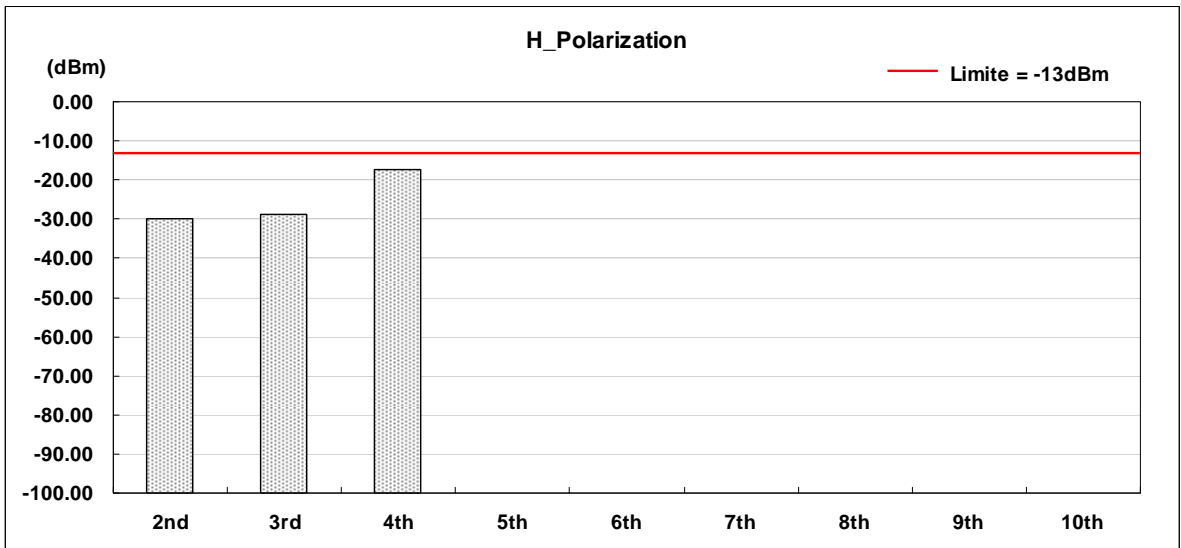
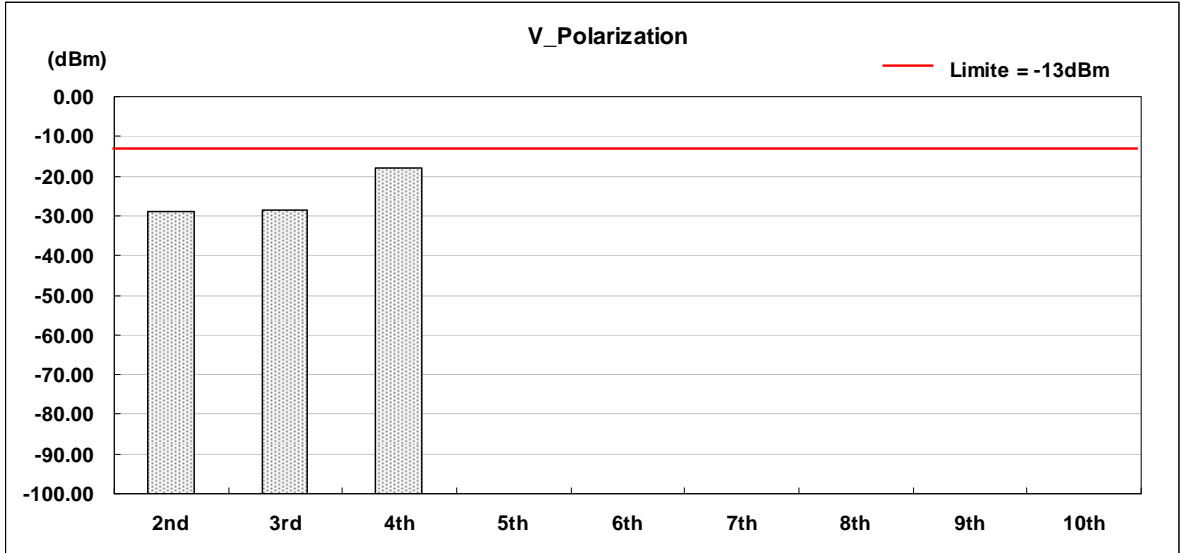

4.7 Frequency Stability (Temperature Variation)

4.7.1 Measurement Instrument

As described in chapter 5 of this test report.

4.7.2 Test Procedure

The measurement is made according to FCC rules part 22 and 24:

1. The EUT and test equipment were set up as shown on the following section.
2. With all power removed, the temperature was decreased to -30°C and permitted to stabilize for three hours. Power was applied and the maximum change in frequency was note within one minute.
3. With power OFF, the temperature was raised in 10°C steps. The sample was permitted to stabilize at each step for at least one-half hour. Power was applied and the maximum frequency change was noted within one minute.
4. The temperature tests were performed for the worst case.
5. Test data was recorded.

4.7.3 Test Setup Layout

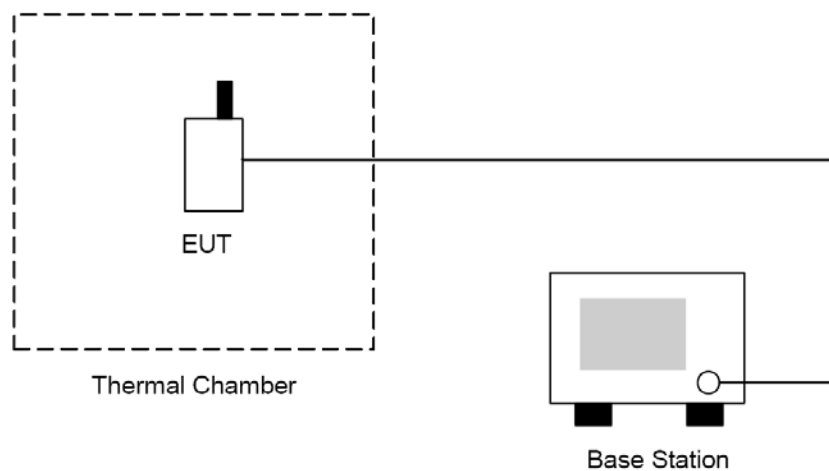



4.7.4 Test Result

Test Mode: GSM 850 CH190

Temperature (°C)	Deviation (Hz)	Deviation (ppm)	Limit (ppm)
-30	22.03	0.026	0.1
-20	23.51	0.028	0.1
-10	22.21	0.027	0.1
0	18.38	0.022	0.1
10	16.59	0.020	0.1
20	23.87	0.029	0.1
30	28.62	0.034	0.1
40	30.85	0.037	0.1
50	22.53	0.027	0.1

Test Mode: GSM 1900 CH661

Temperature (°C)	Deviation (Hz)	Deviation (ppm)	Limit (ppm)
-30	30.06	0.016	1
-20	34.53	0.018	1
-10	33.64	0.018	1
0	35.51	0.019	1
10	40.61	0.022	1
20	35.29	0.019	1
30	34.14	0.018	1
40	30.36	0.016	1
50	33.98	0.018	1



Test Mode: WCDMA Band V CH4182

Temperature (°C)	Deviation (Hz)	Deviation (ppm)	Limit (ppm)
-30	23.57	0.028	0.1
-20	36.42	0.044	0.1
-10	20.52	0.025	0.1
0	33.75	0.040	0.1
10	20.36	0.024	0.1
20	22.54	0.027	0.1
30	34.06	0.041	0.1
40	34.53	0.041	0.1
50	31.38	0.038	0.1

Test Mode: WCDMA Band II CH9400

Temperature (°C)	Deviation (Hz)	Deviation (ppm)	Limit (ppm)
-30	42.13	0.022	1
-20	43.63	0.023	1
-10	41.51	0.022	1
0	41.58	0.022	1
10	47.69	0.025	1
20	35.54	0.019	1
30	31.87	0.017	1
40	30.16	0.016	1
50	29.49	0.016	1

4.8 Frequency Stability (Voltage Variation)

4.8.1 Measurement Instrument

As described in chapter 5 of this test report.

4.8.2 Test Procedure

1. The EUT was placed in a temperature chamber at 25 ± 5 °C and connected as the following section.
2. The power supply voltage to the EUT was varied from BEP to 115% of the nominal value measured at the input to the EUT.
3. The variation in frequency was measured for the worst case.

4.8.3 Test Setup Layout

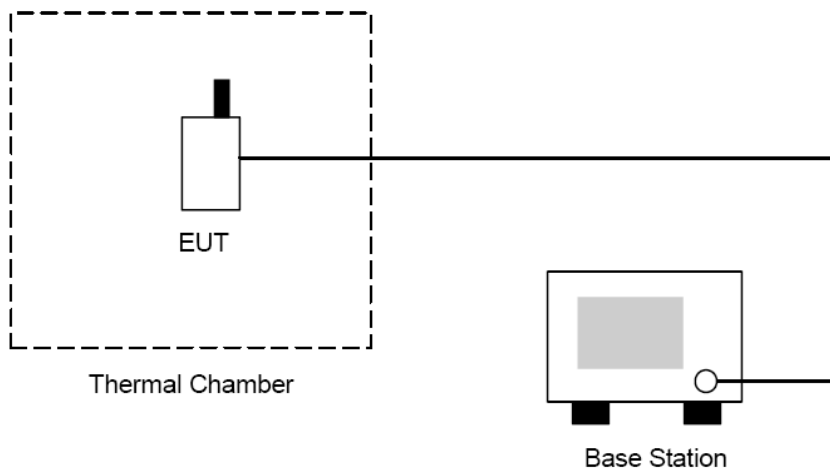



4.8.4 Test Result

Test Mode: GSM 850 CH190

Level	Voltage [V]	Deviation [Hz]	Deviation [ppm]	Limit [ppm]
Battery full point	4.25	22.85	0.027	0.1
Normal	3.70	14.63	0.017	0.1
Battery cut-off point	3.20	11.42	0.014	0.1

Test Mode: GSM 1900 CH661

Level	Voltage [V]	Deviation [Hz]	Deviation [ppm]	Limit [ppm]
Battery full point	4.25	39.14	0.021	1
Normal	3.70	32.74	0.017	1
Battery cut-off point	3.20	36.58	0.019	1

Test Mode: WCDMA Band V CH4182

Level	Voltage [V]	Deviation [Hz]	Deviation [ppm]	Limit [ppm]
Battery full point	4.25	22.49	0.027	0.1
Normal	3.70	20.61	0.025	0.1
Battery cut-off point	3.20	36.06	0.043	0.1

Test Mode: WCDMA Band II CH9400

Level	Voltage [V]	Deviation [Hz]	Deviation [ppm]	Limit [ppm]
Battery full point	4.25	45.85	0.024	1
Normal	3.70	48.43	0.026	1
Battery cut-off point	3.20	40.16	0.021	1



4.9 AC Power Conducted Emissions Requirements

4.9.1 Measurement Instrument

As described in chapter 5 of this test report.

4.9.2 Test Procedure

The measurement is made according to FCC rules 15.207:

The power line conducted emission measurements were performed in a shielded enclosure. The EUT was assembled on a wooden table which is 80 centimeters high, was placed 40 centimeters from the back wall and at least 1 meter from the sidewall.

Power was fed to the EUT from the public utility power grid through a line filter and EMCO Model 3162/2 SH Line Impedance Stabilization Networks (LISN). The LISN housing, measuring instrumentation case, ground plane, etc., were electrically bonded together at the same RF potential. The Spectrum analyzer was connected to the AC line through an isolation transformer. The 50-ohm output of the LISN was connected to the spectrum analyzer directly. Conducted emission levels were in the CISPR quasi-peak detection mode. The analyzer's 6 dB bandwidth was set to 9 KHz. No post-detector video filter was used. The spectrum was scanned from 150 KHz to 30 MHz. The physical arrangement of the test system and associated cabling was varied (within the scope of arrangements likely to be encountered in actual use) to determine the effect on the unit's emanations in amplitude and frequency. All spurious emission frequencies were observed. The highest emission amplitudes relative to the appropriate limit were measured and have been recorded in paragraph 2.6.

4.9.3 Test condition:

EUT tested in accordance with the specifications given by the Manufacturer, and exercised in the most unfavorable manner.



4.9.4 Conducted Emissions Limits:

Frequency range (MHz)	Limits (dBuV)	
	Quasi-peak	Average
0.15 to 0.50	66 to 56	56 to 46
0.50 to 5.0	56	46
5.0 to 30	60	50

4.9.5 Test Result

4.9.5.1 Stand by Test Result

Applicant : Elitegroup Computer Systems Co., LTD.

Model No : M320/M320A/M320B

EUT : HSDPA mini-PCle Modem Module

Test Mode : N/A

Test Date : N/A

The EUT not have AC Adapter



5. List of Measurement Equipments

Manufacturer	Name of Equipment	Type/Model	Serial Number	Calibration	
				Last Cal.	Due Date
Agilent	Spectrum analyzer	E4408B	MY45107753	Jun. 05, 2009	Jun. 05, 2010
R&S	Receiver	ESCI	100367	Jun. 05, 2009	Jun. 05, 2010
SCHWARZBECK	Trilog Broadband Antenna	VULB 9163	9163-270	Jun. 26, 2008	Jun. 26, 2009
SCHWARZBECK	Broadband Horn Antenna	BBHA 9120D	9120D-550	Jun. 26, 2008	Jun. 26, 2009
SCHWARZBECK	Broadband Horn Antenna	BBHA 9170	9170-320	Jun. 01, 2009	Jun. 01, 2010
Agilent	Amplifier	8447D	2944A11119	Jan. 19, 2009	Jan. 19, 2010
Universal Radio Communication Tester	ROHDE & SCHWARZ	CMU200	112387	Jul. 25, 2008	Jul. 25, 2009
Spectrum Analyzer	Agilent	E4445A	MY45300744	Dec. 22, 2008	Dec. 22, 2009
Loop Dipole	ETS-Lindgren	3127-1880	00052640	Jul. 02, 2008	Jul. 02, 2009
Loop Dipole	ETS-Lindgren	3127-836	00055272	Jun. 29, 2008	Jun. 29, 2009
Sleeve Dipole	ETS-Lindgren	3126-1845	00056670	Jun. 29, 2008	Jun. 29, 2009
Sleeve Dipole	ETS-Lindgren	3126-880	00052705	Jun. 29, 2008	Jun. 29, 2009
Anechoic Chamber	ETS-Lindgren	AMS 8500	S/N 102165	NA	
High Pass Filter	MICRO-TRONICS	HPM50108	020	NA	
High Pass Filter	MICRO-TRONICS	HPM50111	021	NA	
Circularly Polarized Communication Antennas	EMCO	3102	00051714	NA	
Pattern Measurement Software	ETS-Lindgren	EMQuest™ EMQ-100	NA	NA	
Desktop Computer with Windows XP		Dell Computers	NA	NA	
Antenna Positioner Controller	EMCO	2090	00052447	NA	
MAPS Positioner	EMCO	2010/2015	NA	NA	
Filter	K&L	5TNF-1700/ 2000-0.1N/N	166	NA	
Filter	K&L	3TNF-800/ 1000-0.2N/N	274	NA	
Attenuator	RADIALL	R41572000	0603033073	NA	
Splitter	Powercom	SGR-GFQ-2-D	41106609	NA	
Power divider	Agilent	87302C	3239A00760	NA	
DC Power Supply	HOLA	DP-30032	NA	NA	



6. Uncertainty Evaluation

Uncertainty of Radiated Emission Measurement (30MHz ~ 1000MHz)

Contribution	Uncertainty of x_i		$U(x_i)$
	dB	Probability Distribution	
Receiver reading	0.41	Normal(k=2)	0.21
Antenna factor calibration	0.83	Normal(k=2)	0.42
Cable loss calibration	0.25	Normal(k=2)	0.13
Pre Amplifier Gain calibration	0.27	Normal(k=2)	0.14
RCV/SPA specification	2.50	Rectangular	0.72
Antenna Factor Interpolation for Frequency	1.00	Rectangular	0.29
Site imperfection	1.43	Rectangular	0.83
Mismatch	+0.39/-0.41	U-shaped	0.28
combined standard uncertainty Uc(y)	1.27		
Measuring uncertainty for a level of confidence of 95% U=2Uc(y)	2.54		

Uncertainty of Radiated Emission Measurement (1GHz ~ 40GHz)

Contribution	Uncertainty of x_i		$U(x_i)$	C_i	$C_i * U(x_i)$
	dB	Probability Distributio			
Receiver reading	±0.10	Normal(k=1)	0.10	1	0.10
Antenna factor calibration	±1.70	Normal(k=2)	0.85	1	0.85
Cable loss calibration	±0.50	Normal(k=2)	0.25	1	0.25
Receiver Correction	±2.00	Rectangular	1.15	1	1.15
Antenna Factor Directional	±1.50	Rectangular	0.87	1	0.87
Site imperfection	±2.80	Triangular	1.14	1	1.14
Mismatch Receiver VSWR $\sqrt{1} = 0.197$ Antenna VSWR $\sqrt{2} = 0.194$ Uncertainty= $20\log(1-\sqrt{1} * \sqrt{2} * \sqrt{3})$	+0.34/-0.35	U-shaped	0.244	1	0.244
Combined standard uncertainty Uc(y)	2.36				
Measuring uncertainty for a level of confidence of 95% U=2Ue(y)	4.72				