

FCC Test Report

Product Name	Wireless Motherboard
Model No.	TR10CD3
FCC ID.	WL6-TRBC41CD1

Applicant	ELITEGROUP COMPUTER SYSTEMS CO., LTD.
Address	No.239, Sec. 2, Ti Ding Blvd., Taipei, Taiwan

Date of Receipt	Mar. 07, 2014
Issued Date	Apr. 11, 2014
Report No.	1430152R-RFUSP03V00-B
Report Version	V1.0



The test results relate only to the samples tested.

The test results shown in the test report are traceable to the national/international standard through the calibration report of the equipment and evaluated measurement uncertainty herein.

This report must not be used to claim product endorsement by TAF or any agency of the government.

The test report shall not be reproduced without the written approval of QuieTek Corporation.

Test Report

Issued Date: Apr. 11, 2014

Report No.: 1430152R-RFUSP03V00-B



Product Name	Wireless Motherboard
Applicant	ELITEGROUP COMPUTER SYSTEMS CO., LTD.
Address	No.239, Sec. 2, Ti Ding Blvd., Taipei, Taiwan
Manufacturer	ELITEGROUP COMPUTER SYSTEMS CO., LTD.
Model No.	TR10CD3
FCC ID.	WL6-TRBC41CD1
EUT Rated Voltage	DC 3.7V (Power by Battery)
EUT Test Voltage	AC 120V/ 60Hz
Trade Name	ECS ELITEGROUP , J.P. SA Couto S.A.
Applicable Standard	FCC CFR Title 47 Part 15 Subpart C: 2012 ANSI C63.10: 2009
Test Result	Complied

Documented By :

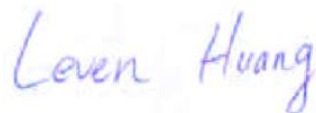

(Senior Adm. Specialist / Leven Huang)

Tested By :



(Engineer / Alan Chen)

Approved By :



(Director / Vincent Lin)

TABLE OF CONTENTS

Description	Page
1. GENERAL INFORMATION	5
1.1. EUT Description.....	5
1.2. Operational Description.....	7
1.3. Tested System Details.....	8
1.4. Configuration of Tested System	8
1.5. EUT Exercise Software	8
1.6. Test Facility	9
2. CONDUCTED EMISSION	10
2.1. Test Equipment.....	10
2.2. Test Setup	10
2.3. Limits.....	11
2.4. Test Procedure	11
2.5. Uncertainty	11
2.6. Test Result of Conducted Emission	12
3. PEAK POWER OUTPUT	14
3.1. Test Equipment.....	14
3.2. Test Setup	14
3.3. Limit	14
3.4. Test Procedure	14
3.5. Uncertainty	14
3.6. Test Result of Peak Power Output.....	15
4. RADIATED EMISSION	17
4.1. Test Equipment.....	17
4.2. Test Setup	17
4.3. Limits.....	18
4.4. Test Procedure	19
4.5. Uncertainty	19
4.6. Test Result of Radiated Emission	20
5. RF ANTENNA CONDUCTED TEST	28
5.1. Test Equipment.....	28
5.2. Test Setup	28
5.3. Limits.....	28
5.4. Test Procedure	28
5.5. Uncertainty	28
5.6. Test Result of RF Antenna Conducted Test.....	29
6. BAND EDGE	31
6.1. Test Equipment.....	31
6.2. Test Setup	32
6.3. Limit	33
6.4. Test Procedure	33
6.5. Uncertainty	33
6.6. Test Result of Band Edge	34
7. CHANNEL NUMBER.....	42
7.1. Test Equipment.....	42

7.2.	Test Setup	42
7.3.	Limit	42
7.4.	Test Procedure	42
7.5.	Uncertainty	42
7.6.	Test Result of Channel Number.....	43
8.	CHANNEL SEPARATION.....	45
8.1.	Test Equipment.....	45
8.2.	Test Setup	45
8.3.	Limit	45
8.4.	Test Procedure	45
8.5.	Uncertainty	45
8.6.	Test Result of Channel Separation.....	46
9.	DWELL TIME.....	50
9.1.	Test Equipment.....	50
9.2.	Test Setup	50
9.3.	Limit	50
9.4.	Test Procedure	50
9.5.	Uncertainty	50
9.6.	Test Result of Dwell Time	51
10.	OCCUPIED BANDWIDTH	55
10.1.	Test Equipment.....	55
10.2.	Test Setup	55
10.3.	Limits.....	55
10.4.	Test Procedure	55
10.5.	Uncertainty	55
10.6.	Test Result of Occupied Bandwidth	56
11.	EMI REDUCTION METHOD DURING COMPLIANCE TESTING	62

Attachment 1: EUT Test Photographs
Attachment 2: EUT Detailed Photographs

1. GENERAL INFORMATION

1.1. EUT Description

Product Name	Wireless Motherboard
Trade Name	ECS ELITEGROUP , J.P. SA Couto S.A.
Model No.	TR10CD3
FCC ID.	WL6-TRBC41CD1
Frequency Range	2402 – 2480MHz
Channel Number	79
Type of Modulation	FHSS: GFSK(1Mbps) / π /4DQPSK(2Mbps) / 8DPSK(3Mbps)
Antenna Type	Chip Antenna
Channel Control	Auto
Antenna Gain	Refer to the table “Antenna List”

Antenna List

No.	Manufacturer	Part No.	Antenna Type	Peak Gain
1	Pulse	02H475-006500	Chip Antenna	3.2dBi for 2.4GHz

Note: 1.The antenna of EUT is conform to FCC 15.203.

Center Frequency of Each Channel:

Channel	Frequency	Channel	Frequency	Channel	Frequency	Channel	Frequency
Channel 00:	2402 MHz	Channel 20:	2422 MHz	Channel 40:	2442 MHz	Channel 60:	2462 MHz
Channel 01:	2403 MHz	Channel 21:	2423 MHz	Channel 41:	2443 MHz	Channel 61:	2463 MHz
Channel 02:	2404 MHz	Channel 22:	2424 MHz	Channel 42:	2444 MHz	Channel 62:	2464 MHz
Channel 03:	2405 MHz	Channel 23:	2425 MHz	Channel 43:	2445 MHz	Channel 63:	2465 MHz
Channel 04:	2406 MHz	Channel 24:	2426 MHz	Channel 44:	2446 MHz	Channel 64:	2466 MHz
Channel 05:	2407 MHz	Channel 25:	2427 MHz	Channel 45:	2447 MHz	Channel 65:	2467 MHz
Channel 06:	2408 MHz	Channel 26:	2428 MHz	Channel 46:	2448 MHz	Channel 66:	2468 MHz
Channel 07:	2409 MHz	Channel 27:	2429 MHz	Channel 47:	2449 MHz	Channel 67:	2469 MHz
Channel 08:	2410 MHz	Channel 28:	2430 MHz	Channel 48:	2450 MHz	Channel 68:	2470 MHz
Channel 09:	2411 MHz	Channel 29:	2431 MHz	Channel 49:	2451 MHz	Channel 69:	2471 MHz
Channel 10:	2412 MHz	Channel 30:	2432 MHz	Channel 50:	2452 MHz	Channel 70:	2472 MHz
Channel 11:	2413 MHz	Channel 31:	2433 MHz	Channel 51:	2453 MHz	Channel 71:	2473 MHz
Channel 12:	2414 MHz	Channel 32:	2434 MHz	Channel 52:	2454 MHz	Channel 72:	2474 MHz
Channel 13:	2415 MHz	Channel 33:	2435 MHz	Channel 53:	2455 MHz	Channel 73:	2475 MHz
Channel 14:	2416 MHz	Channel 34:	2436 MHz	Channel 54:	2456 MHz	Channel 74:	2476 MHz
Channel 15:	2417 MHz	Channel 35:	2437 MHz	Channel 55:	2457 MHz	Channel 75:	2477 MHz
Channel 16:	2418 MHz	Channel 36:	2438 MHz	Channel 56:	2458 MHz	Channel 76:	2478 MHz
Channel 17:	2419 MHz	Channel 37:	2439 MHz	Channel 57:	2459 MHz	Channel 77:	2479 MHz
Channel 18:	2420 MHz	Channel 38:	2440 MHz	Channel 58:	2460 MHz	Channel 78:	2480 MHz
Channel 19:	2421 MHz	Channel 39:	2441 MHz	Channel 59:	2461 MHz		

Note:

1. The EUT is a Wireless Motherboard with a built-in WLAN and Bluetooth transceiver, this report for Bluetooth.
2. These tests were conducted on a sample for the purpose of demonstrating compliance of Bluetooth transmitter with Part 15 Subpart C Paragraph 15.247 for spread spectrum devices.
3. Regarding to the operation frequency, the lowest, middle and highest frequency are selected to perform the test.
4. The radiation measurements are performed in X, Y, Z axis positioning. Only the worst case is shown in the report.
5. Bluetooth operation was evaluated at both 1Mb/s and 3Mb/s data rates. 2Mb/s data rate was found, through pre-testing, to produce emissions similar to those for 3Mb/s.

Test Mode	Mode 1: Transmit - 1Mbps (GFSK) Mode 2: Transmit - 3Mbps (8DPSK)
-----------	---

1.3. Tested System Details

The types for all equipment, plus descriptions of all cables used in the tested system (including inserted cards) are:

Product	Manufacturer	Model No.	Serial No.	Power Cord	
1	Notebook PC	DELL	PPT	N/A	Non-Shielded, 0.8m
2	LED Monitor	DELL	ST2402Lb	CN-0X0K27-74261-2 7E-0M6U T	Non-Shielded, 1.8m
3	Earphone	AIWA	N/A	N/A	N/A
4	Battery	N/A	TR10-1S8100-T1T2	N/A	N/A

Signal Cable Type	Signal cable Description	
A	USB Cable	Shielded, 1.2m
B	HDMI Cable	Shielded, 1.6m
C	Earphone Cable	Non-Shielded, 1.2m

1.4. Configuration of Tested System

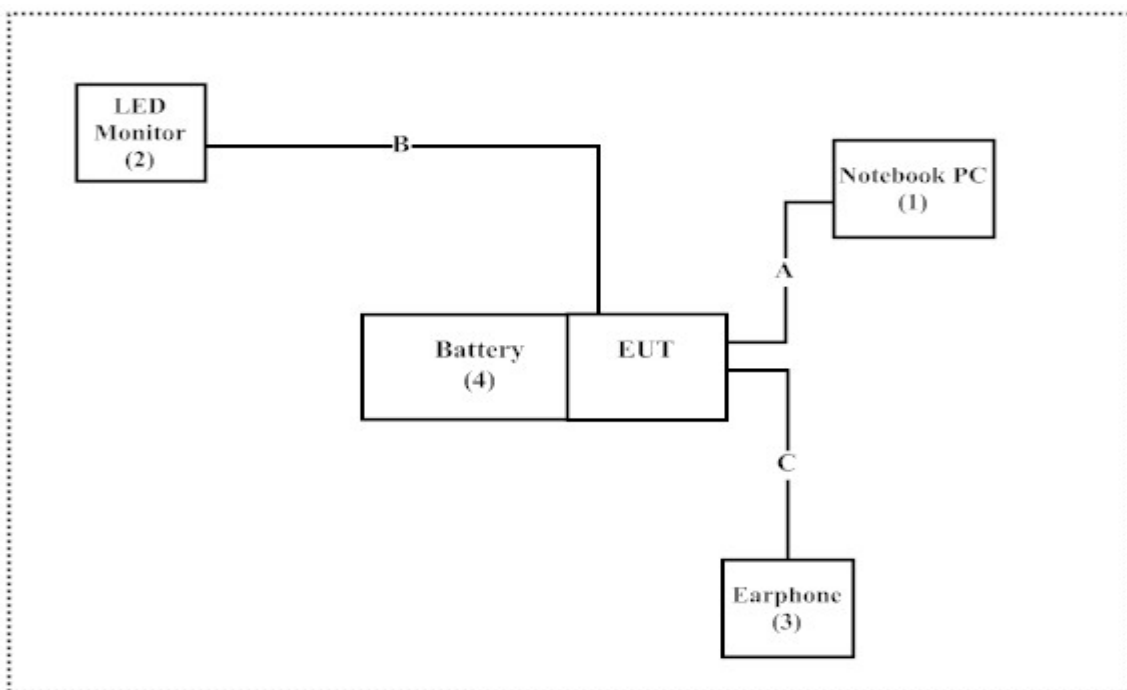

1.5. EUT Exercise Software

- (1) Setup the EUT as shown in Section 1.4
- (2) Execute program “adb.exe” on the Notebook PC.
- (3) Configure the test mode, the test channel, and the data rate.
- (4) Press “OK” to start the continuous Transmit.
- (5) Verify that the EUT works properly.

1.6. Test Facility

Ambient conditions in the laboratory:

Items	Required (IEC 68-1)	Actual
Temperature (°C)	15-35	20-35
Humidity (%RH)	25-75	30-65
Barometric pressure (mbar)	860-1060	950-1000

The related certificate for our laboratories about the test site and management system can be downloaded from Quietek Corporation's Web Site: <http://www.quietek.com/tw/ctg/cts/accreditations.htm>
The address and introduction of Quietek Corporation's laboratories can be founded in our Web site: <http://www.quietek.com/>

Site Description: File on
Federal Communications Commission
FCC Engineering Laboratory
7435 Oakland Mills Road
Columbia, MD 21046
Registration Number: 92195

Site Name: Quietek Corporation
Site Address: No.5-22, Ruishukeng,
Linkou Dist. New Taipei City 24451,
Taiwan, R.O.C.
TEL: 886-2-8601-3788 / FAX : 886-2-8601-3789
E-Mail : service@quietek.com

FCC Accreditation Number: TW1014

2. Conducted Emission

2.1. Test Equipment

	Equipment	Manufacturer	Model No. / Serial No.	Last Cal.	Remark
X	Test Receiver	R & S	ESCS 30 / 825442/018	Sep., 2013	
X	Artificial Mains Network	R & S	ENV4200 / 848411/10	Feb., 2014	Peripherals
X	LISN	R & S	ESH3-Z5 / 825562/002	Feb., 2014	EUT
	DC LISN	Schwarzbeck	8226 / 176	Mar., 2014	EUT
X	Pulse Limiter	R & S	ESH3-Z2 / 357.8810.52	Feb., 2014	
	No.1 Shielded Room				

Note:

1. All equipments are calibrated every one year.
2. The test instruments marked by "X" are used to measure the final test results.

2.2. Test Setup

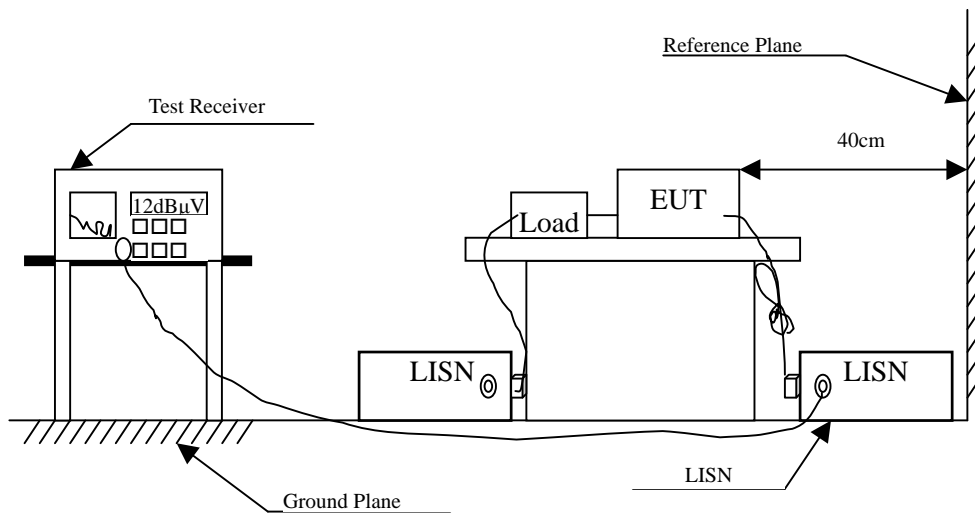

2.3. Limits

FCC Part 15 Subpart C Paragraph 15.207 (dBµV) Limit		
Frequency MHz	Limits	
	QP	AV
0.15 - 0.50	66-56	56-46
0.50-5.0	56	46
5.0 - 30	60	50

Remarks: In the above table, the tighter limit applies at the band edges.

2.4. Test Procedure

The EUT and Peripherals are connected to the main power through a line impedance stabilization network (L.I.S.N.). This provides a 50 ohm /50uH coupling impedance for the measuring equipment. The peripheral devices are also connected to the main power through a LISN that provides a 50ohm /50uH coupling impedance with 50ohm termination. (Please refer to the block diagram of the test setup and photographs.)

Both sides of A.C. line are checked for maximum conducted interference. In order to find the maximum emission, the relative positions of equipment and all the interface cables must be changed according to ANSI C63.10: 2009 on conducted measurement.

Conducted emissions were investigated over the frequency range from 0.15MHz to 30MHz using a receiver bandwidth of 9kHz.

The EUT was setup to ANSI C63.10, 2009; tested to FHSS test procedure of FCC Public Notice DA 00-705 for compliance to FCC 47CFR 15.247 requirements.

2.5. Uncertainty

± 2.26 dB

2.6. Test Result of Conducted Emission

Product : Wireless Motherboard
 Test Item : Conducted Emission Test
 Power Line : Line 1
 Test Mode : Mode 2: Transmit - 3Mbps (8DPSK) (2441MHz)

Frequency MHz	Correct Factor dB	Reading Level dB μ V	Measurement Level dB μ V	Margin dB	Limit dB μ V
LINE 1					
Quasi-Peak					
0.150	9.749	30.870	40.619	-25.381	66.000
0.216	9.739	33.610	43.349	-20.765	64.114
0.283	9.742	27.500	37.242	-24.958	62.200
0.357	9.746	29.700	39.446	-20.640	60.086
0.498	9.752	24.500	34.252	-21.805	56.057
5.560	9.880	25.850	35.730	-24.270	60.000
Average					
0.150	9.749	18.990	28.739	-27.261	56.000
0.216	9.739	24.040	33.779	-20.335	54.114
0.283	9.742	21.640	31.382	-20.818	52.200
0.357	9.746	24.360	34.106	-15.980	50.086
0.498	9.752	22.150	31.902	-14.155	46.057
5.560	9.880	16.270	26.150	-23.850	50.000

Note:

1. All Reading Levels are Quasi-Peak and average value.
2. "█" means the worst emission level.
3. Measurement Level = Reading Level + Correct Factor

Product : Wireless Motherboard
 Test Item : Conducted Emission Test
 Power Line : Line 2
 Test Mode : Mode 2: Transmit - 3Mbps (8DPSK) (2441MHz)

Frequency MHz	Correct Factor dB	Reading Level dB μ V	Measurement Level dB μ V	Margin dB	Limit dB μ V
LINE 2					
Quasi-Peak					
0.154	9.749	25.940	35.688	-30.198	65.886
0.212	9.749	33.490	43.239	-20.990	64.229
0.357	9.746	27.670	37.416	-22.670	60.086
0.498	9.752	22.300	32.052	-24.005	56.057
5.134	9.880	18.600	28.480	-31.520	60.000
13.545	9.990	25.600	35.590	-24.410	60.000
Average					
0.154	9.749	7.250	16.998	-38.888	55.886
0.212	9.749	25.380	35.129	-19.100	54.229
0.357	9.746	23.310	33.056	-17.030	50.086
0.498	9.752	20.550	30.302	-15.755	46.057
5.134	9.880	9.460	19.340	-30.660	50.000
13.545	9.990	21.700	31.690	-18.310	50.000

Note:

1. All Reading Levels are Quasi-Peak and average value.
2. "█" means the worst emission level.
3. Measurement Level = Reading Level + Correct Factor

3. Peak Power Output

3.1. Test Equipment

	Equipment	Manufacturer	Model No./Serial No.	Last Cal.
X	Power Meter	Anritsu	ML2495A/6K00003357	May, 2013
X	Power Sensor	Anritsu	MA2411B/0738448	Jun., 2013

Note: 1. All equipments are calibrated every one year.
 2. The test instruments marked by “X” are used to measure the final test results.

3.2. Test Setup

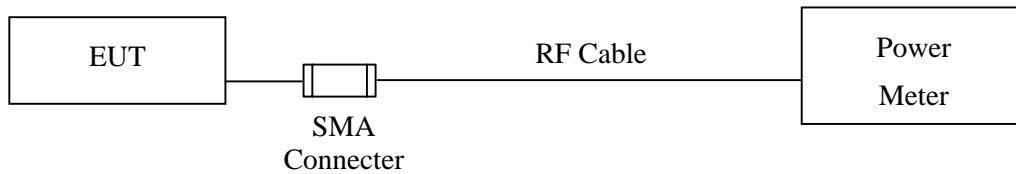

3.3. Limit

The maximum peak power shall be less 1Watt.

3.4. Test Procedure

The EUT was setup to ANSI C63.10, 2009; tested to FHSS test procedure of FCC Public Notice DA 00-705 for compliance to FCC 47CFR 15.247 requirements.

3.5. Uncertainty

± 1.27 dB

3.6. Test Result of Peak Power Output

Product : Wireless Motherboard
Test Item : Peak Power Output
Test Site : No.3 OATS
Test Mode : Mode 1: Transmit - 1Mbps (GFSK)

Channel No.	Frequency (MHz)	Measurement (dBm)	Required Limit	Result
Channel 00	2402.00	7.23	1 Watt= 30 dBm	Pass
Channel 39	2441.00	7.14	1 Watt= 30 dBm	Pass
Channel 78	2480.00	6.92	1 Watt= 30 dBm	Pass

Product : Wireless Motherboard
Test Item : Peak Power Output
Test Site : No.3 OATS
Test Mode : Mode 2: Transmit - 3Mbps (8DPSK)

Channel No.	Frequency (MHz)	Measurement (dBm)	Required Limit	Result
Channel 00	2402.00	4.89	1 Watt= 30 dBm	Pass
Channel 39	2441.00	5.12	1 Watt= 30 dBm	Pass
Channel 78	2480.00	5.32	1 Watt= 30 dBm	Pass

4. Radiated Emission

4.1. Test Equipment

The following test equipments are used during the radiated emission test:

Test Site		Equipment	Manufacturer	Model No./Serial No.	Last Cal.
☒ Site # 3	X	Loop Antenna	Teseq	HLA6120 / 26739	Jul., 2013
	X	Bilog Antenna	Schaffner Chase	CBL6112B/2673	Sep., 2013
	X	Horn Antenna	Schwarzbeck	BBHA9120D/D305	Sep., 2013
	X	Horn Antenna	Schwarzbeck	BBHA9170/208	Jul., 2013
	X	Pre-Amplifier	Agilent	8447D/2944A09549	Sep., 2013
	X	Spectrum Analyzer	Agilent	E4407B / US39440758	May, 2013
	X	Test Receiver	R & S	ESCS 30/ 825442/018	Sep., 2013
	X	Coaxial Cable	QuieTek	QTK-CABLE/ CAB5	Feb., 2014
	X	Controller	QuieTek	QTK-CONTROLLER/ CTRL3	N/A
	X	Coaxial Switch	Anritsu	MP59B/6200265729	N/A

- Note:
1. All equipments are calibrated every one year.
 2. The test instruments marked by "X" are used to measure the final test results.

4.2. Test Setup

Below 1GHz

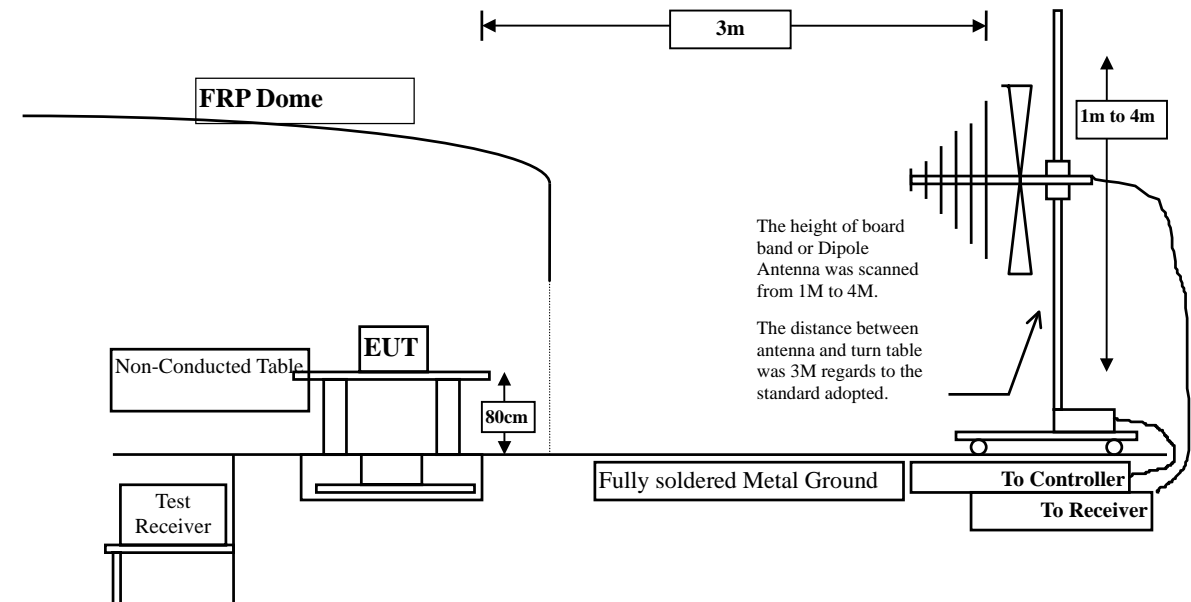

Above 1GHz

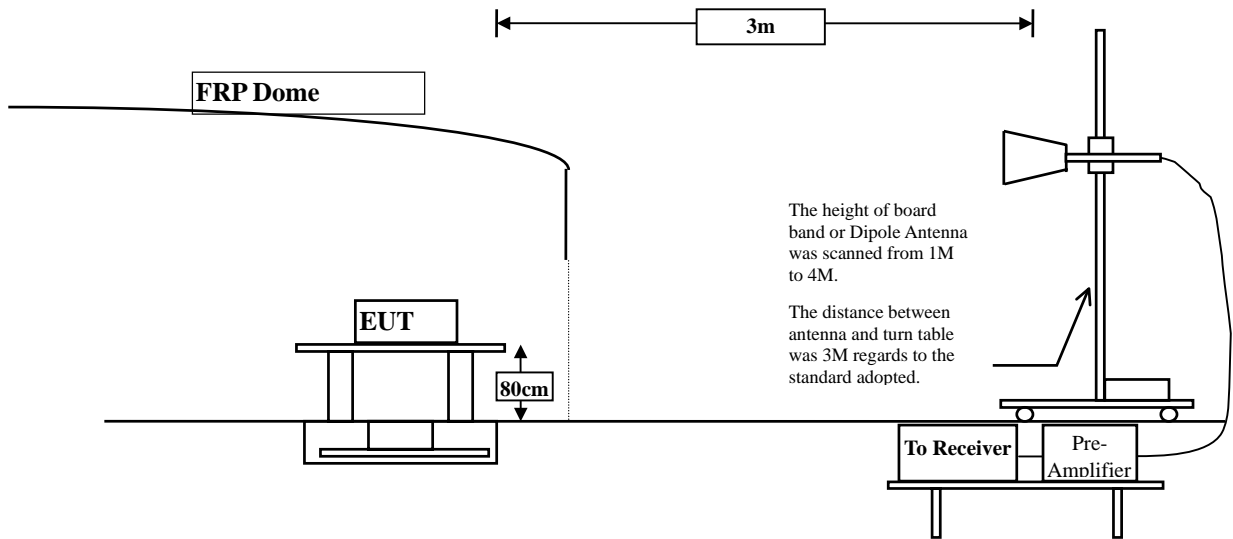

Limits

► General Radiated Emission Limits

Emissions radiated outside of the specified frequency bands, except for harmonics, shall be attenuated by at least 20dB below the level of the fundamental or to the general radiated emission limits in paragraph 15.209, whichever is the lesser attenuation.

FCC Part 15 Subpart C Paragraph 15.209 Limits		
Frequency MHz	Field strength (microvolts/meter)	Measurement distance (meter)
0.009-0.490	2400/F(kHz)	300
0.490-1.705	24000/F(kHz)	30
1.705-30	30	30
30-88	100	3
88-216	150	3
216-960	200	3
Above 960	500	3

- Remarks:
1. RF Voltage (dBμV) = 20 log RF Voltage (uV)
 2. In the Above Table, the tighter limit applies at the band edges.
 3. Distance refers to the distance in meters between the measuring instrument antenna and the closed point of any part of the device or system.

4.3. Test Procedure

The EUT was setup according to ANSI C63.10, 2009 and tested according to FHSS test procedure of FCC Public Notice DA 00-705 for compliance to FCC 47CFR 15.247 requirements.

The EUT is placed on a turn table which is 0.8 meter above ground. The turn table is rotated 360 degrees to determine the position of the maximum emission level. The EUT was positioned such that the distance from antenna to the EUT was 3 meters.

The antenna is scanned from 1 meter to 4 meters to find out the maximum emission level. This is repeated for both horizontal and vertical polarization of the antenna. In order to find the maximum emission, all of the interface cables were manipulated according to ANSI C63.10, 2009 on radiated measurement.

The resolution bandwidth below 30MHz setting on the field strength meter is 9kHz and 30MHz~1GHz is 120kHz and above 1GHz is 1MHz.

Radiated emission measurements below 30MHz are made using Loop Antenna and 30MHz~1GHz are made using broadband Bilog antenna and above 1GHz are made using Horn Antennas.

The measurement is divided into the Preliminary Measurement and the Final Measurement.

The suspected frequencies are searched for in Preliminary Measurement with the measurement antenna kept pointed at the source of the emission both in azimuth and elevation, with the polarization of the antenna oriented for maximum response. The antenna is pointed at an angle towards the source of the emission, and the EUT is rotated in both height and polarization to maximize the measured emission. The emission is kept within the illumination area of the 3 dB bandwidth of the antenna.

The worst radiated emission is measured on the Final Measurement.

The measurement frequency range form 9kHz - 10th Harmonic of fundamental was investigated.

4.4. Uncertainty

± 3.9 dB above 1GHz

± 3.8 dB below 1GHz

4.5. Test Result of Radiated Emission

Product : Wireless Motherboard
 Test Item : Harmonic Radiated Emission
 Test Site : No.3 OATS
 Test Mode : Mode 1: Transmit - 1Mbps (GFSK)(2402MHz)

Frequency MHz	Correct Factor dB	Reading Level dB μ V	Measurement Level dB μ V/m	Margin dB	Limit dB μ V/m
Horizontal					
Peak Detector:					
3906.000	0.742	53.500	54.242	-19.758	74.000
4804.000	3.327	53.330	56.657	-17.343	74.000
7206.000	10.136	38.050	48.186	-25.814	74.000
9608.000	13.706	41.400	55.106	-18.894	74.000
Average					
Detector:					
3906.000	0.742	52.100	52.842	-1.158	54.000
4804.000	3.327	44.780	48.107	-5.893	54.000
9608.000	13.706	29.860	43.566	-10.434	54.000
Vertical					
Peak Detector:					
3906.000	1.858	52.510	54.368	-19.632	74.000
4804.000	6.638	49.390	56.027	-17.973	74.000
7206.000	11.005	37.210	48.215	-25.785	74.000
9608.000	14.103	41.730	55.833	-18.167	74.000
Average					
Detector:					
3906.000	1.858	50.960	52.818	-1.182	54.000
4804.000	6.638	42.510	49.148	-4.852	54.000
9608.000	14.103	31.000	45.103	-8.897	54.000

Note:

- All Readings below 1GHz are Quasi-Peak, above 1GHz are performed with peak and/or average measurements as necessary.
- Peak measurements: RBW = 1MHz, VBW = 3 MHz, Sweep: Auto.
- Average measurements: RBW = 1MHz, VBW = 10 Hz, Sweep: Auto.
- Measurement Level = Reading Level + Correct Factor.
- Correct Factor = Antenna factor + Cable loss – Amplifier gain.
- The average measurement was not performed when the peak measured data under the limit of average detection.
- The emission levels of other frequencies are very lower than the limit and not show in test report.

Product : Wireless Motherboard
 Test Item : Harmonic Radiated Emission
 Test Site : No.3 OATS
 Test Mode : Mode 1: Transmit - 1Mbps (GFSK)(2441MHz)

Frequency MHz	Correct Factor dB	Reading Level dB μ V	Measurement Level dB μ V/m	Margin dB	Limit dB μ V/m
Horizontal					
Peak Detector:					
3984.000	0.503	50.200	50.703	-23.297	74.000
4882.000	3.001	54.040	57.041	-16.959	74.000
7323.000	11.846	36.180	48.027	-25.973	74.000
9764.000	12.563	39.390	51.953	-22.047	74.000
Average					
Detector:					
4882.000	3.001	45.420	48.421	-5.579	54.000
Vertical					
Peak Detector:					
3984.000	1.551	49.640	51.191	-22.809	74.000
4882.000	5.713	50.560	56.274	-17.726	74.000
7323.000	12.727	36.120	48.848	-25.152	74.000
9764.000	13.028	39.360	52.388	-21.612	74.000
Average					
Detector:					
4882.000	5.713	42.400	48.114	-5.886	54.000

Note:

1. All Readings below 1GHz are Quasi-Peak, above 1GHz are performed with peak and/or average measurements as necessary.
2. Peak measurements: RBW = 1MHz, VBW = 3 MHz, Sweep: Auto.
3. Average measurements: RBW = 1MHz, VBW = 10 Hz, Sweep: Auto.
4. Measurement Level = Reading Level + Correct Factor.
5. Correct Factor = Antenna factor + Cable loss - Amplifier gain.
6. The average measurement was not performed when the peak measured data under the limit of average detection.
7. The emission levels of other frequencies are very lower than the limit and not show in test report.

Product : Wireless Motherboard
 Test Item : Harmonic Radiated Emission
 Test Site : No.3 OATS
 Test Mode : Mode 1: Transmit - 1Mbps (GFSK)(2480MHz)

Frequency MHz	Correct Factor dB	Reading Level dB μ V	Measurement Level dB μ V/m	Margin dB	Limit dB μ V/m
Horizontal					
Peak Detector:					
4960.000	2.760	54.360	57.120	-16.880	74.000
7440.000	12.567	36.740	49.306	-24.694	74.000
9920.000	13.456	39.100	52.556	-21.444	74.000
Average					
Detector:					
4960.000	2.760	45.540	48.300	-5.700	54.000
Vertical					
Peak Detector:					
4960.000	5.557	50.010	55.567	-18.433	74.000
7440.000	13.426	36.270	49.695	-24.305	74.000
9920.000	13.958	39.010	52.968	-21.032	74.000
Average					
Detector:					
4960.000	5.557	41.760	47.317	-6.683	54.000

Note:

1. All Readings below 1GHz are Quasi-Peak, above 1GHz are performed with peak and/or average measurements as necessary.
2. Peak measurements: RBW = 1MHz, VBW = 3 MHz, Sweep: Auto.
3. Average measurements: RBW = 1MHz, VBW = 10 Hz, Sweep: Auto.
4. Measurement Level = Reading Level + Correct Factor.
5. Correct Factor = Antenna factor + Cable loss – Amplifier gain.
6. The average measurement was not performed when the peak measured data under the limit of average detection.
7. The emission levels of other frequencies are very lower than the limit and not show in test report.

Product : Wireless Motherboard
 Test Item : Harmonic Radiated Emission
 Test Site : No.3 OATS
 Test Mode : Mode 2: Transmit - 3Mbps (8DPSK)(2402MHz)

Frequency MHz	Correct Factor dB	Reading Level dB μ V	Measurement Level dB μ V/m	Margin dB	Limit dB μ V/m
Horizontal					
Peak Detector:					
3906.000	0.742	52.870	53.612	-20.388	74.000
4804.000	3.327	50.760	54.087	-19.913	74.000
7206.000	10.136	35.070	45.206	-28.794	74.000
9608.000	13.706	39.510	53.216	-20.784	74.000
Average Detector:					
4804.000	3.327	40.500	43.827	-10.173	54.000
Vertical					
Peak Detector:					
3906.000	1.858	51.330	53.188	-20.812	74.000
4804.000	6.638	46.850	53.487	-20.513	74.000
7206.000	11.005	36.450	47.455	-26.545	74.000
9608.000	14.103	39.170	53.273	-20.727	74.000
Average Detector:					
--					

Note:

1. All Readings below 1GHz are Quasi-Peak, above 1GHz are performed with peak and/or average measurements as necessary.
2. Peak measurements: RBW = 1MHz, VBW = 3 MHz, Sweep: Auto.
3. Average measurements: RBW = 1MHz, VBW = 10 Hz, Sweep: Auto.
4. Measurement Level = Reading Level + Correct Factor.
5. Correct Factor = Antenna factor + Cable loss – Amplifier gain.
6. The average measurement was not performed when the peak measured data under the limit of average detection.
7. The emission levels of other frequencies are very lower than the limit and not show in test report.

Product : Wireless Motherboard
 Test Item : Harmonic Radiated Emission
 Test Site : No.3 OATS
 Test Mode : Mode 2: Transmit - 3Mbps (8DPSK) (2441MHz)

Frequency MHz	Correct Factor dB	Reading Level dB μ V	Measurement Level dB μ V/m	Margin dB	Limit dB μ V/m
Horizontal					
Peak Detector:					
3983.000	0.507	50.840	51.347	-22.653	74.000
4882.000	3.001	52.470	55.471	-18.529	74.000
7323.000	11.846	36.340	48.187	-25.813	74.000
9764.000	12.563	38.220	50.783	-23.217	74.000
Average					
Detector:					
4882.000	3.001	43.650	46.651	-7.349	54.000
Vertical					
Peak Detector:					
3983.000	1.554	49.380	50.935	-23.065	74.000
4882.000	5.713	48.270	53.984	-20.016	74.000
7323.000	12.727	36.600	49.328	-24.672	74.000
9764.000	13.028	38.070	51.098	-22.902	74.000
Average					
Detector:					
--					

Note:

1. All Readings below 1GHz are Quasi-Peak, above 1GHz are performed with peak and/or average measurements as necessary.
2. Peak measurements: RBW = 1MHz, VBW = 3 MHz, Sweep: Auto.
3. Average measurements: RBW = 1MHz, VBW = 10 Hz, Sweep: Auto.
4. Measurement Level = Reading Level + Correct Factor.
5. Correct Factor = Antenna factor + Cable loss – Amplifier gain.
6. The average measurement was not performed when the peak measured data under the limit of average detection.
7. The emission levels of other frequencies are very lower than the limit and not show in test report.

Product : Wireless Motherboard
 Test Item : Harmonic Radiated Emission
 Test Site : No.3 OATS
 Test Mode : Mode 2: Transmit - 3Mbps (8DPSK) (2480MHz)

Frequency MHz	Correct Factor dB	Reading Level dB μ V	Measurement Level dB μ V/m	Margin dB	Limit dB μ V/m
Horizontal					
Peak Detector:					
4960.000	2.760	54.320	57.080	-16.920	74.000
7440.000	12.567	36.920	49.486	-24.514	74.000
9920.000	13.456	36.900	50.356	-23.644	74.000
Average Detector:					
4960.000	2.760	45.230	47.990	-6.010	54.000
Vertical					
Peak Detector:					
4960.000	5.557	48.370	53.927	-20.073	74.000
7440.000	13.426	36.420	49.845	-24.155	74.000
9920.000	13.958	37.320	51.278	-22.722	74.000
Average Detector:					
--					

Note:

1. All Readings below 1GHz are Quasi-Peak, above 1GHz are performed with peak and/or average measurements as necessary.
2. Peak measurements: RBW = 1MHz, VBW = 3 MHz, Sweep: Auto.
3. Average measurements: RBW = 1MHz, VBW = 10 Hz, Sweep: Auto.
4. Measurement Level = Reading Level + Correct Factor.
5. Correct Factor = Antenna factor + Cable loss – Amplifier gain.
6. The average measurement was not performed when the peak measured data under the limit of average detection.
7. The emission levels of other frequencies are very lower than the limit and not show in test report.

Product : Wireless Motherboard
 Test Item : General Radiated Emission
 Test Site : No.3 OATS
 Test Mode : Mode 1: Transmit - 1Mbps (GFSK) (2441MHz)

Frequency MHz	Correct Factor dB	Reading Level dB μ V	Measurement Level dB μ V/m	Margin dB	Limit dB μ V/m
Horizontal					
105.660	-3.862	29.402	25.540	-48.460	74.000
336.520	-3.440	31.785	28.345	-45.655	74.000
431.580	-3.291	33.294	30.003	-43.997	74.000
606.180	-3.084	33.041	29.957	-44.043	74.000
720.640	-2.949	39.002	36.053	-37.947	74.000
961.200	-2.710	40.328	37.618	-36.382	74.000
Vertical					
227.880	-8.519	28.032	19.514	-26.486	46.000
373.380	-2.373	28.749	26.376	-19.624	46.000
528.580	-0.462	29.329	28.867	-17.133	46.000
623.640	-2.631	31.731	29.100	-16.900	46.000
817.640	3.272	27.903	31.175	-14.825	46.000
961.200	7.260	31.111	38.371	-15.629	54.000

Note:

1. All Readings below 1GHz are Quasi-Peak, above 1GHz are performed with peak and/or average measurements as necessary.
2. Peak measurements: RBW = 1MHz, VBW = 3 MHz, Sweep: Auto.
3. Average measurements: RBW = 1MHz, VBW = 10 Hz, Sweep: Auto.
4. Measurement Level = Reading Level + Correct Factor.
5. Correct Factor = Antenna factor + Cable loss – Amplifier gain.
6. The average measurement was not performed when the peak measured data under the limit of average detection.
7. The emission levels of other frequencies are very lower than the limit and not show in test report.
8. No emission found between lowest internal used/generated frequency to 30MHz.

Product : Wireless Motherboard
 Test Item : General Radiated Emission
 Test Site : No.3 OATS
 Test Mode : Mode 2: Transmit - 3Mbps (8DPSK) (2441MHz)

Frequency MHz	Correct Factor dB	Reading Level dB μ V	Measurement Level dB μ V/m	Margin dB	Limit dB μ V/m
Horizontal					
103.720	-6.751	33.624	26.872	-16.628	43.500
239.520	-6.851	29.391	22.541	-23.459	46.000
431.580	-2.099	32.011	29.912	-16.088	46.000
573.200	2.537	26.764	29.301	-16.699	46.000
745.860	3.308	27.359	30.667	-15.333	46.000
912.700	6.132	26.953	33.085	-12.915	46.000
Vertical					
57.160	-4.403	27.549	23.146	-16.854	40.000
161.920	-6.696	29.884	23.189	-20.311	43.500
386.960	-3.064	29.633	26.569	-19.431	46.000
623.640	-2.631	32.656	30.025	-15.975	46.000
817.640	3.272	28.057	31.329	-14.671	46.000
912.700	1.762	27.251	29.013	-16.987	46.000

Note:

1. All Readings below 1GHz are Quasi-Peak, above 1GHz are performed with peak and/or average measurements as necessary.
2. Peak measurements: RBW = 1MHz, VBW = 3 MHz, Sweep: Auto.
3. Average measurements: RBW = 1MHz, VBW = 10 Hz, Sweep: Auto.
4. Measurement Level = Reading Level + Correct Factor.
5. Correct Factor = Antenna factor + Cable loss – Amplifier gain.
6. The average measurement was not performed when the peak measured data under the limit of average detection.
7. The emission levels of other frequencies are very lower than the limit and not show in test report.
8. No emission found between lowest internal used/generated frequency to 30MHz.

5. RF Antenna Conducted Test

5.1. Test Equipment

	Equipment	Manufacturer	Model No./Serial No.	Last Cal.
	Spectrum Analyzer	R&S	FSP40 / 100170	Jun., 2013
	Spectrum Analyzer	Agilent	E4407B / US39440758	Jun., 2013
X	Spectrum Analyzer	Agilent	N9010A / MY48030495	Apr., 2014

Note: 1. All equipments are calibrated every one year.
 2. The test instruments Marked “X” are used to measure the final test results.

5.2. Test Setup

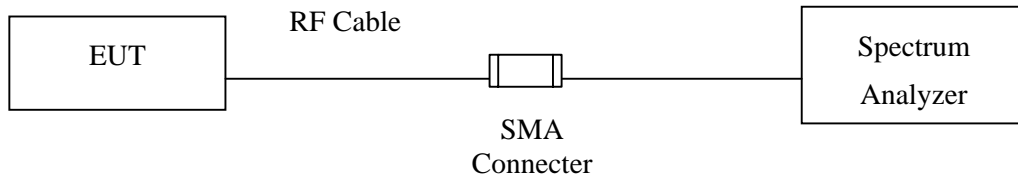

5.3. Limits

According to FCC Section 15.247(d). In any 100 kHz bandwidth outside the frequency band in which the spread spectrum or digitally modulated intentional radiator is operating, the radio frequency power that is produced by the intentional radiator shall be at least 20 dB below that in the 100 kHz bandwidth within the band that contains the highest level of the desired power, based on either an RF conducted or measurement, provided the transmitter demonstrates compliance with the peak conducted power limits. If the transmitter complies with the conducted power limits based on the use of RMS averaging over a time interval, the attenuation required under this paragraph shall be 30 dB instead of 20 dB.

5.4. Test Procedure

The EUT was setup to ANSI C63.10, 2009; tested to FHSS test procedure of FCC Public Notice DA 00-705 for compliance to FCC 47CFR 15.247 requirements.

5.5. Uncertainty

± 150Hz

5.6. Test Result of RF Antenna Conducted Test

Product : Wireless Motherboard
 Test Item : RF Antenna Conducted Test
 Test Site : No.3 OATS
 Test Mode : Mode 1: Transmit - 1Mbps (GFSK)

Channel 00 (2402MHz) 30MHz-25GHz

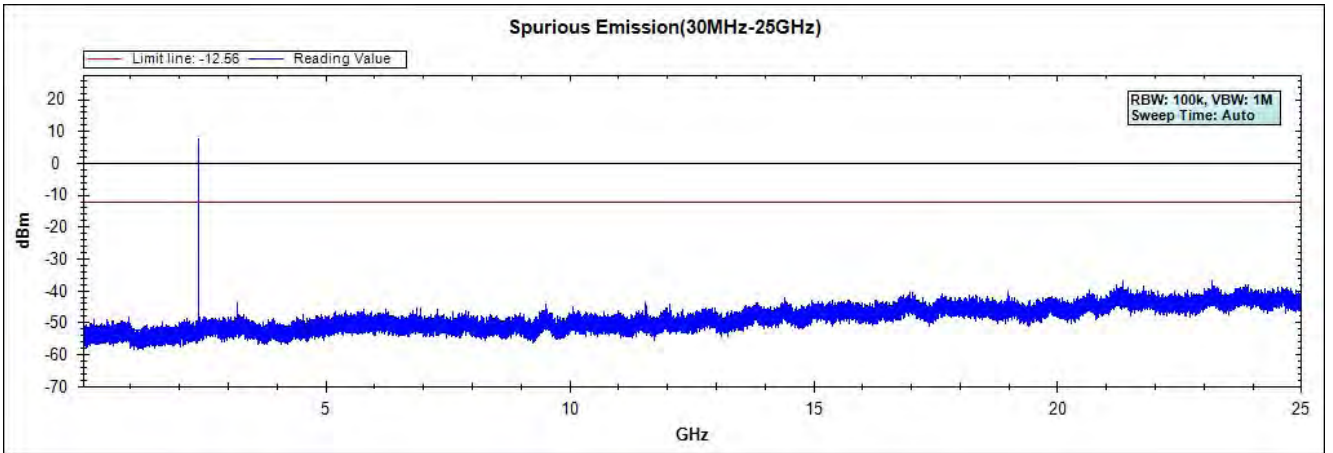

Channel 39 (2441MHz) 30MHz-25GHz

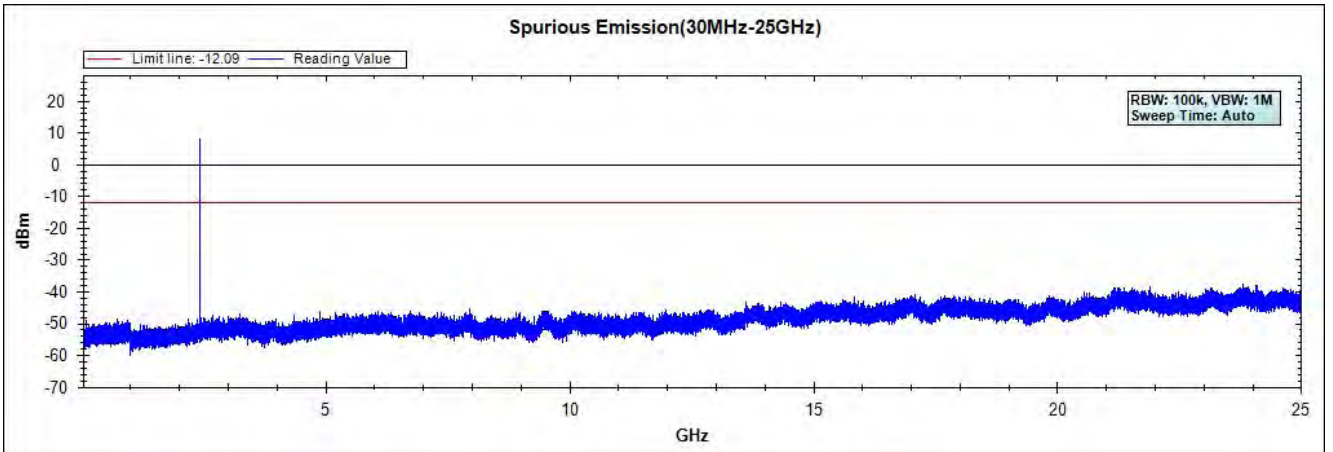

Channel 78 (2480MHz) 30MHz-25GHz

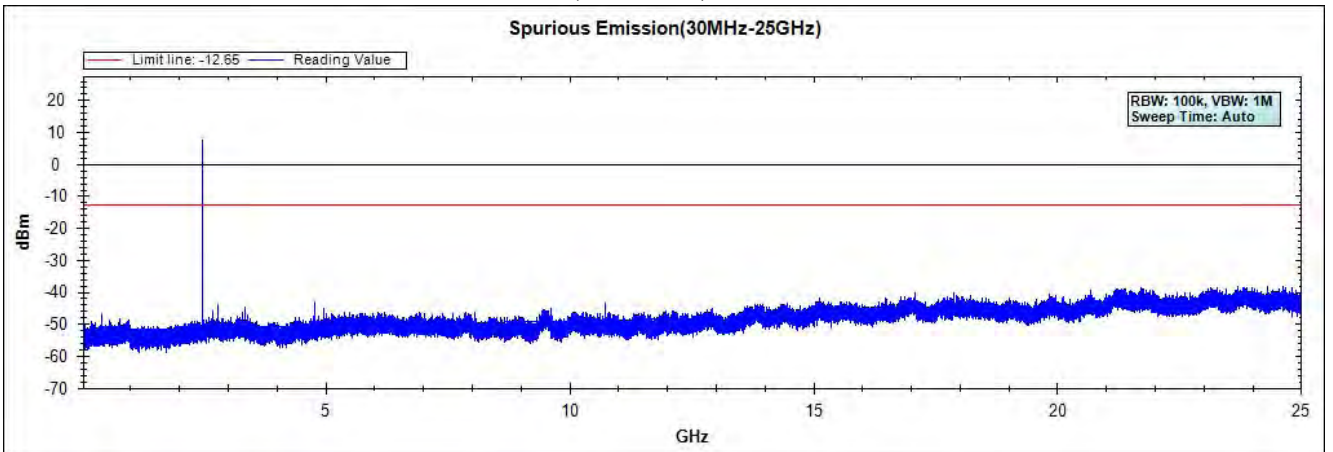

Note: The above test pattern is synthesized by multiple of the frequency range.

Product : Wireless Motherboard
 Test Item : RF Antenna Conducted Test
 Test Site : No.3 OATS
 Test Mode : Mode 2: Transmit - 3Mbps (8DPSK)

Channel 00 (2402MHz) 30MHz-25GHz

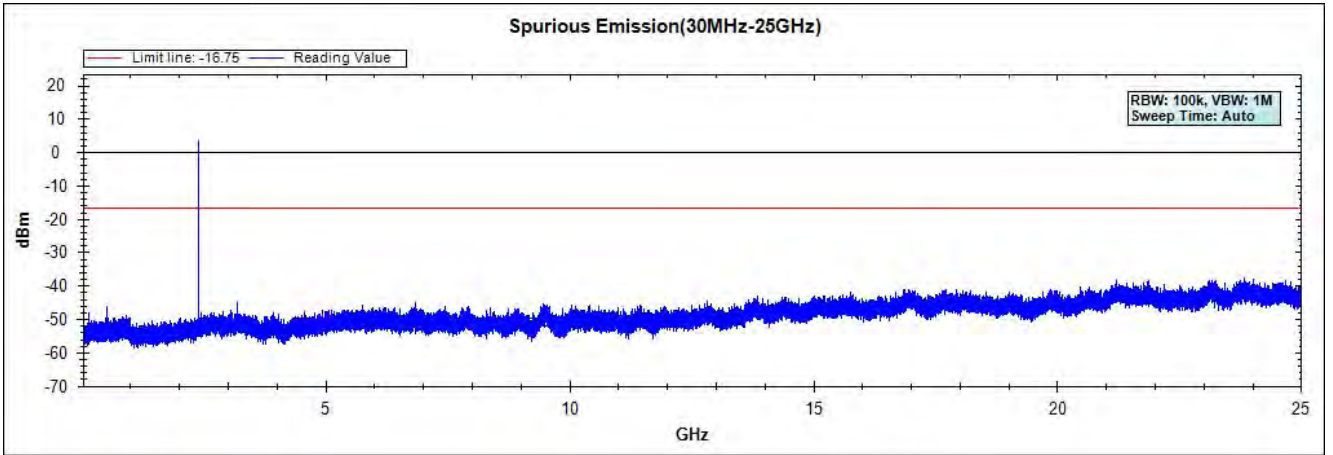

Channel 39 (2441MHz) 30MHz-25GHz

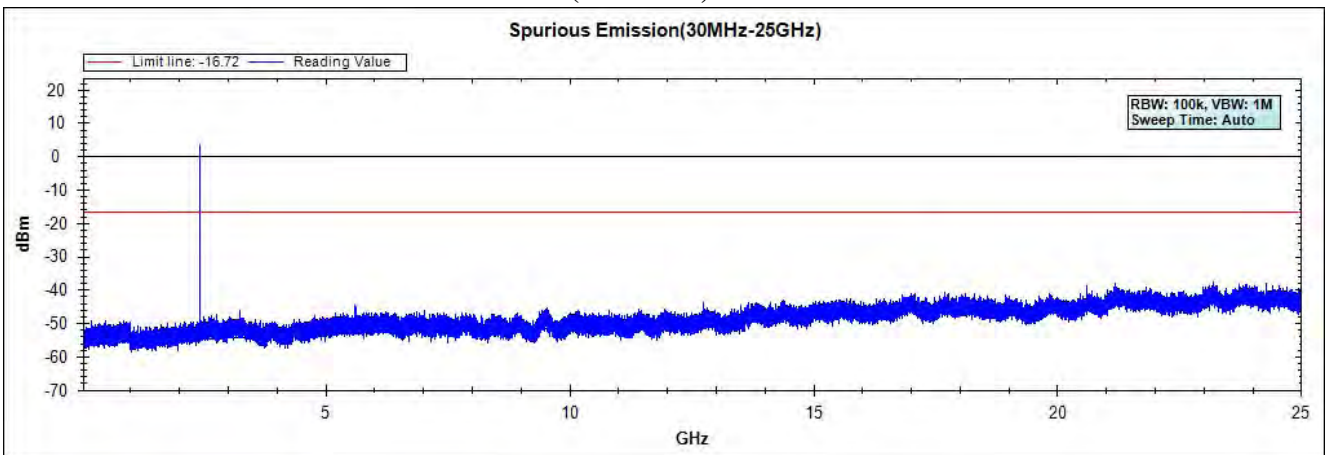

Channel 78 (2480MHz) 30MHz-25GHz

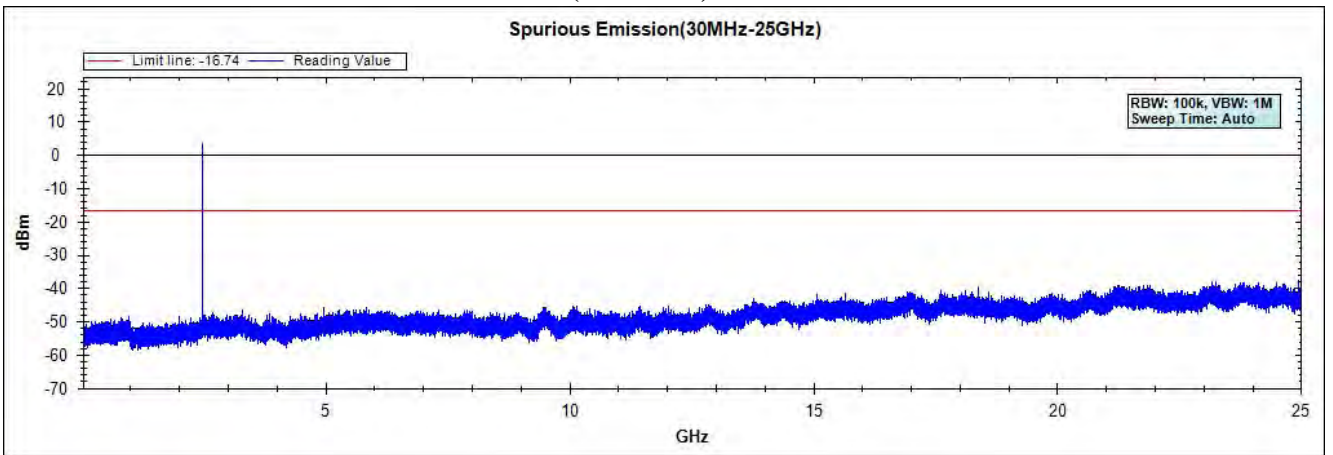

Note: The above test pattern is synthesized by multiple of the frequency range.

6. Band Edge

6.1. Test Equipment

RF Conducted Measurement

The following test equipments are used during the band edge tests:

	Equipment	Manufacturer	Model No./Serial No.	Last Cal.
	Spectrum Analyzer	R&S	FSP40 / 100170	Jun., 2013
	Spectrum Analyzer	Agilent	E4407B / US39440758	Jun., 2013
X	Spectrum Analyzer	Agilent	N9010A / MY48030495	Apr., 2014

RF Radiated Measurement:

The following test equipments are used during the band edge tests:

Test Site		Equipment	Manufacturer	Model No./Serial No.	Last Cal.
☒ Site # 3		Bilog Antenna	Schaffner Chase	CBL6112B/2673	Sep., 2013
	X	Horn Antenna	Schwarzbeck	BBHA9120D/D305	Sep., 2013
		Horn Antenna	Schwarzbeck	BBHA9170/208	Jul., 2013
	X	Pre-Amplifier	Agilent	8447D/2944A09549	Sep., 2013
	X	Spectrum Analyzer	Agilent	E4407B / US39440758	May, 2013
		Test Receiver	R & S	ESCS 30/ 825442/018	Sep., 2013
	X	Coaxial Cable	Quietek	QTK-CABLE/ CAB5	Feb., 2014
	X	Controller	Quietek	QTK-CONTROLLER/ CTRL3	N/A
	X	Coaxial Switch	Anritsu	MP59B/6200265729	N/A

- Note:
1. All equipments are calibrated every one year.
 2. The test instruments marked by "X" are used to measure the final test results.

6.2. Test Setup

RF Conducted Measurement

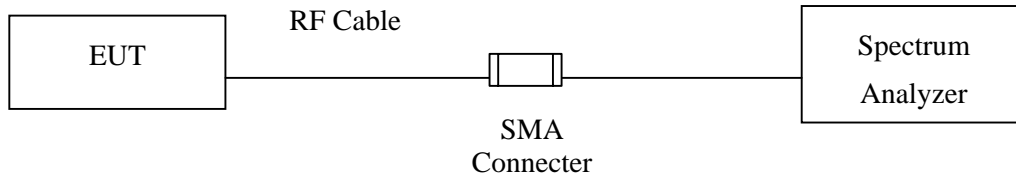

RF Radiated Measurement:

Above 1GHz

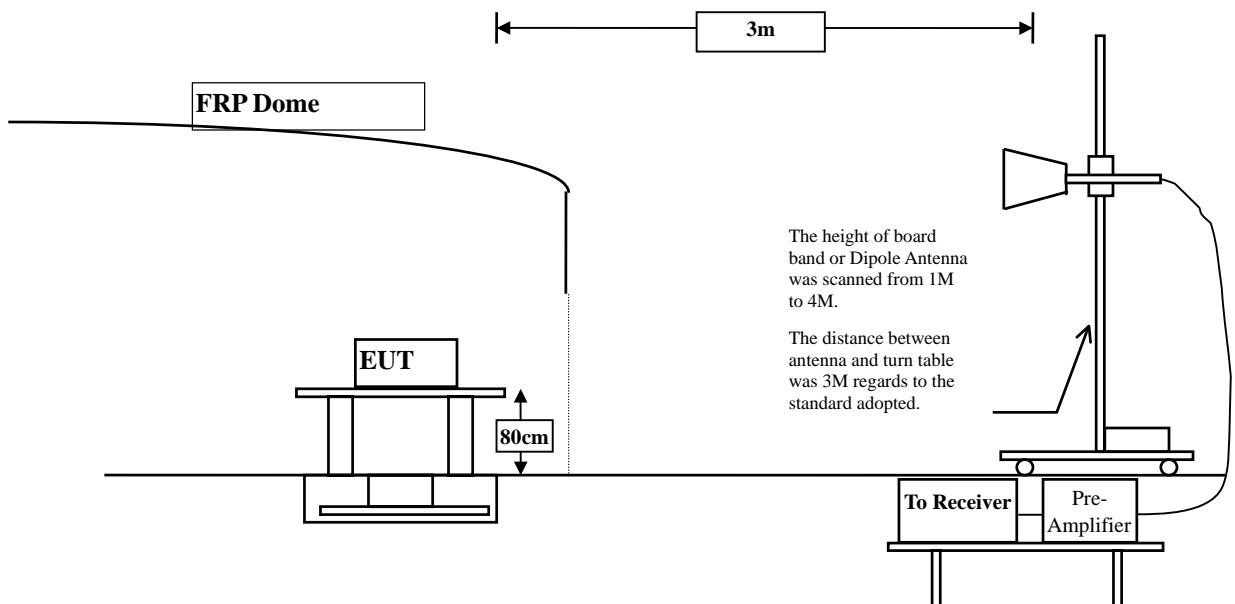

6.3. Limit

In any 100 kHz bandwidth outside the frequency band in which the spread spectrum intentional radiator is operating, the radio frequency power that is produced by the intentional radiator shall be at least 20 dB below that in the 100 kHz bandwidth within the band that contains the highest level of the desired power, based on either an RF conducted or a radiated measurement. Attenuation below the general limits specified in Section 15.209(a) is not required. In addition, radiated emissions which fall in the restricted bands, as defined in Section 15.205(a), must also comply with the radiated emission limits specified in Section 15.209(a) (see Section 15.205(c)).

6.4. Test Procedure

The EUT and its simulators are placed on a turn table which is 0.8 meter above ground. The turn table can rotate 360 degrees to determine the position of the maximum emission level. The EUT was positioned such that the distance from antenna to the EUT was 3 meters.

The antenna can move up and down between 1 meter and 4 meters to find out the maximum emission level.

Both horizontal and vertical polarization of the antenna are set on measurement. In order to find the maximum emission, all of the interface cables must be manipulated according to ANSI C63.10:2009 on radiated measurement.

The bandwidth below 1GHz setting on the field strength meter is 120 kHz, above 1GHz are 1 MHz. The EUT was setup to ANSI C63.10, 2009; tested to FHSS test procedure of FCC Public Notice DA 00-705 for compliance to FCC 47CFR 15.247 requirements.

6.5. Uncertainty

± 3.9 dB above 1GHz

± 3.8 dB below 1GHz

6.6. Test Result of Band Edge

Product : Wireless Motherboard
 Test Item : Band Edge
 Test Site : No.3 OATS
 Test Mode : Mode 1: Transmit - 1Mbps (GFSK)

Fundamental Filed Strength

Antenna Pole	Frequency [MHz]	Correction Factor [dB/m]	Reading Level [dB μ V]	Emission Level [dB μ V/m]	Detector
Horizontal	2402	31.573	76.48	108.054	Peak
Horizontal	2402	31.573	62.24	93.814	Average
Vertical	2402	30.917	69.37	100.287	Peak
Vertical	2402	30.917	56.60	87.517	Average

Note: 1: Spectrum Analyzer setting:

Peak detector: RBW=1MHz, VBW=1MHz

Average detector: RBW=1MHz, VBW=10Hz

Band Edge Test Data

Antenna Pole	Test Frequency (MHz)	Fundamental (dB μ V/m)	Δ (dB)	Band Edge Field Strength (dB μ V/m)	Limit (dB μ V/m)	Detector
Horizontal	2390	108.054	49.892	58.162	74.000	Peak
Horizontal	2390	93.814	48.913	44.901	54.000	Average
Vertical	2390	100.287	49.892	50.395	74.000	Peak
Vertical	2390	87.517	48.913	38.604	54.000	Average

Note:

The Band Edge Field Strength was calculated using the Fundamental and Conducted Band Edge measurements per the Marker-Delta Method with the following formula:

Band Edge field Strength = F - Δ

F = Fundamental field Strength (Peak or Average)

Δ = Conducted Band Edge Delta (Peak or Average)

Peak Detector of conducted Band Edge Delta

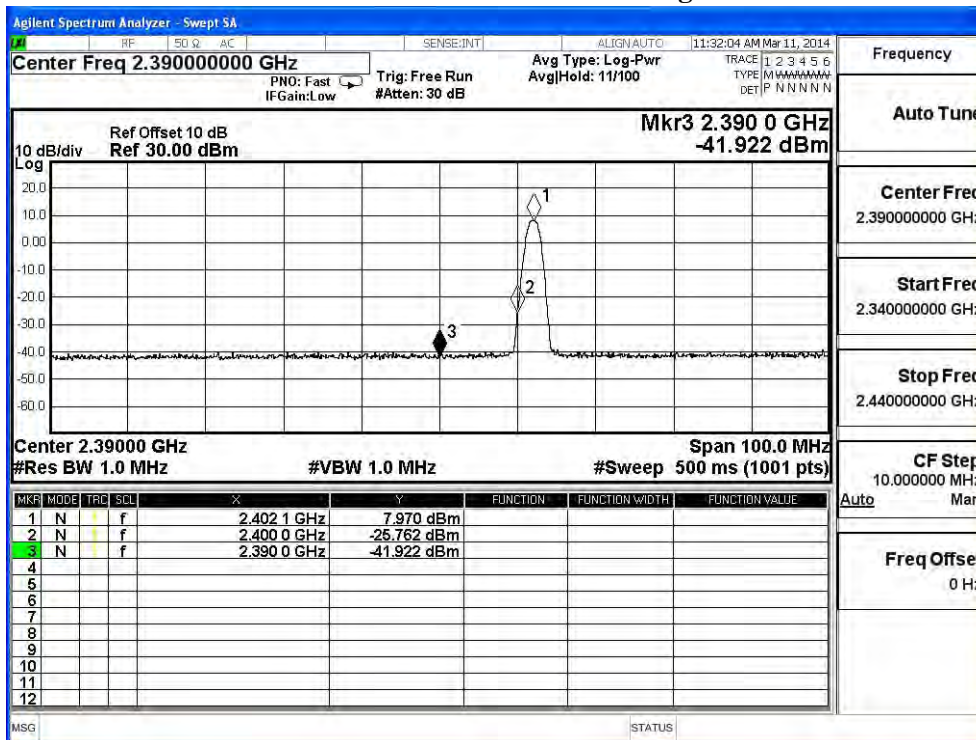

Average Detector of conducted Band Edge Delta

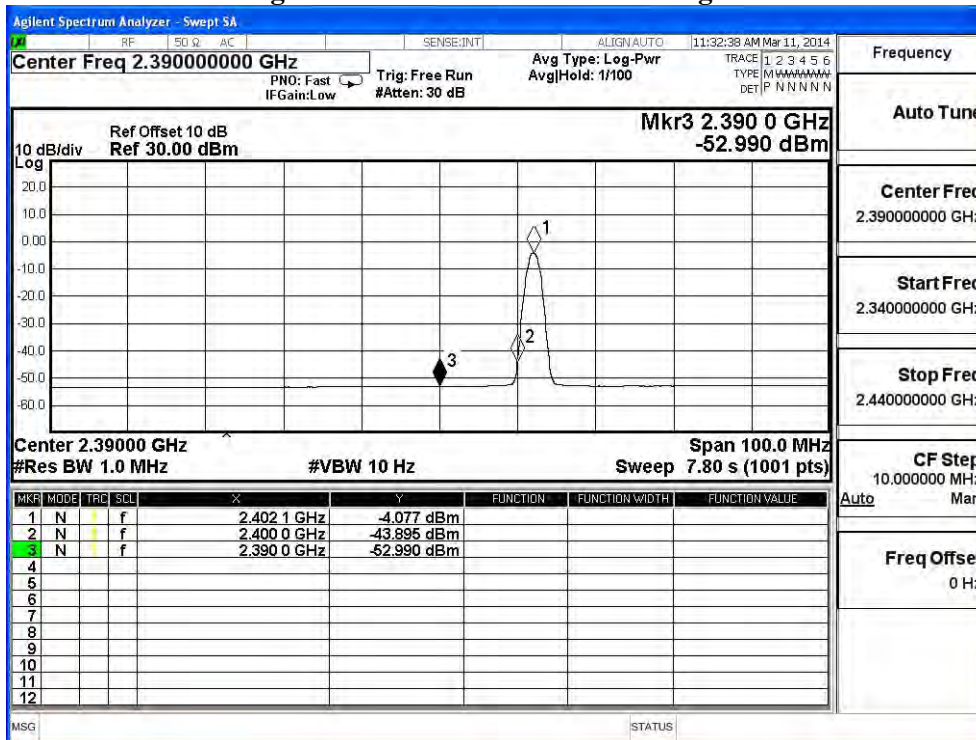

Product : Wireless Motherboard
 Test Item : Band Edge
 Test Site : No.3 OATS
 Test Mode : Mode 1: Transmit - 1Mbps (GFSK)

Fundamental Filed Strength

Antenna Pole	Frequency [MHz]	Correction Factor [dB/m]	Reading Level [dB μ V]	Emission Level [dB(uV/m)]	Detector
Horizontal	2480	32.155	75.80	107.956	Peak
Horizontal	2480	32.155	61.90	94.056	Average
Vertical	2480	31.412	71.10	102.512	Peak
Vertical	2480	31.412	57.87	89.282	Average

Note: 1: Spectrum Analyzer setting:

Peak detector: RBW=1MHz, VBW=1MHz

Average detector: RBW=1MHz, VBW=10Hz

Band Edge Test Data

Antenna Pole	Test Frequency (MHz)	Fundamental (dB μ V/m)	Δ (dB)	Band Edge Field Strength (dB μ V/m)	Limit (dB μ V/m)	Detector
Horizontal	2499.4	107.956	47.27	60.686	74.000	Peak
Horizontal	2483.5	94.056	48.11	45.946	54.000	Average
Vertical	2499.4	102.512	47.27	55.242	74.000	Peak
Vertical	2483.5	89.282	48.11	41.172	54.000	Average

Note:

The Band Edge Field Strength was calculated using the Fundamental and Conducted Band Edge measurements per the Marker-Delta Method with the following formula:

Band Edge field Strength = F - Δ

F = Fundamental field Strength (Peak or Average)

Δ = Conducted Band Edge Delta (Peak or Average)

Peak Detector of conducted Band Edge Delta

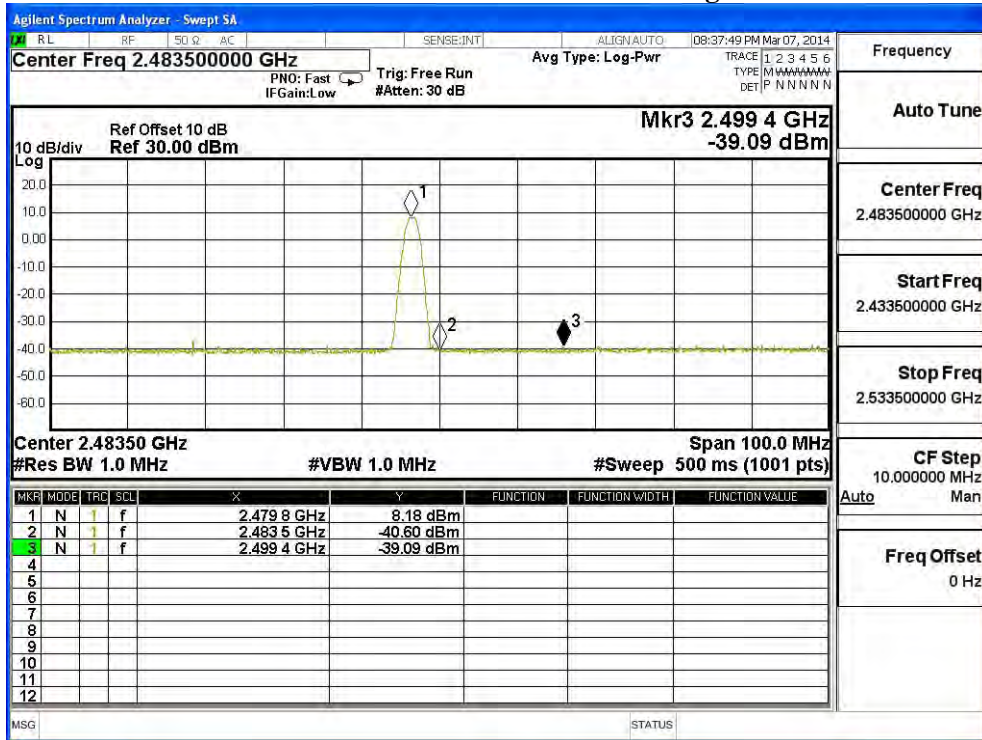

Average Detector of conducted Band Edge Delta

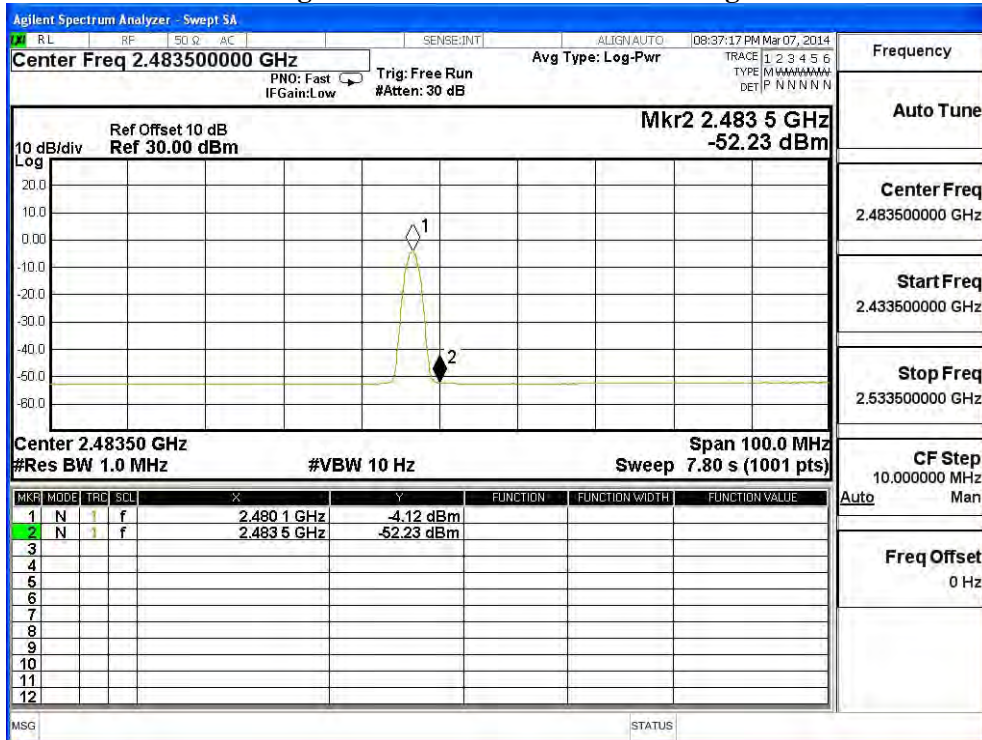

Product : Wireless Motherboard
 Test Item : Band Edge
 Test Site : No.3 OATS
 Test Mode : Mode 2: Transmit - 3Mbps (8DPSK)

Fundamental Filed Strength

Antenna Pole	Frequency [MHz]	Correction Factor [dB/m]	Reading Level [dB μ V]	Emission Level [dB μ V/m]	Detector
Horizontal	2402	31.573	75.60	107.174	Peak
Horizontal	2402	31.573	59.20	90.774	Average
Vertical	2402	30.917	68.54	99.457	Peak
Vertical	2402	30.917	53.50	84.417	Average

Note: 1: Spectrum Analyzer setting:

Peak detector: RBW=1MHz, VBW=1MHz

Average detector: RBW=1MHz, VBW=10Hz

Band Edge Test Data

Antenna Pole	Test Frequency (MHz)	Fundamental (dB μ V/m)	Δ (dB)	Band Edge Field Strength (dB μ V/m)	Limit (dB μ V/m)	Detector
Horizontal	2390	107.174	45.763	61.411	74.000	Peak
Horizontal	2390	90.774	47.993	42.781	54.000	Average
Vertical	2390	99.457	45.763	53.694	74.000	Peak
Vertical	2390	84.417	47.993	36.424	54.000	Average

Note:

The Band Edge Field Strength was calculated using the Fundamental and Conducted Band Edge measurements per the Marker-Delta Method with the following formula:

Band Edge field Strength = F - Δ

F = Fundamental field Strength (Peak or Average)

Δ = Conducted Band Edge Delta (Peak or Average)

Peak Detector of conducted Band Edge Delta

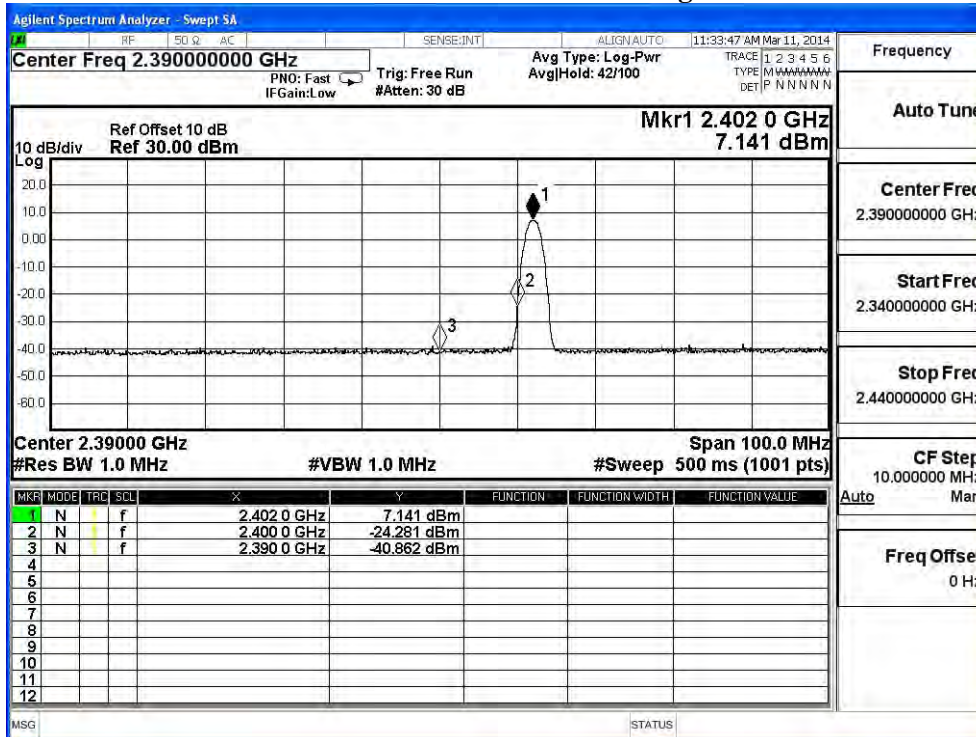

Average Detector of conducted Band Edge Delta

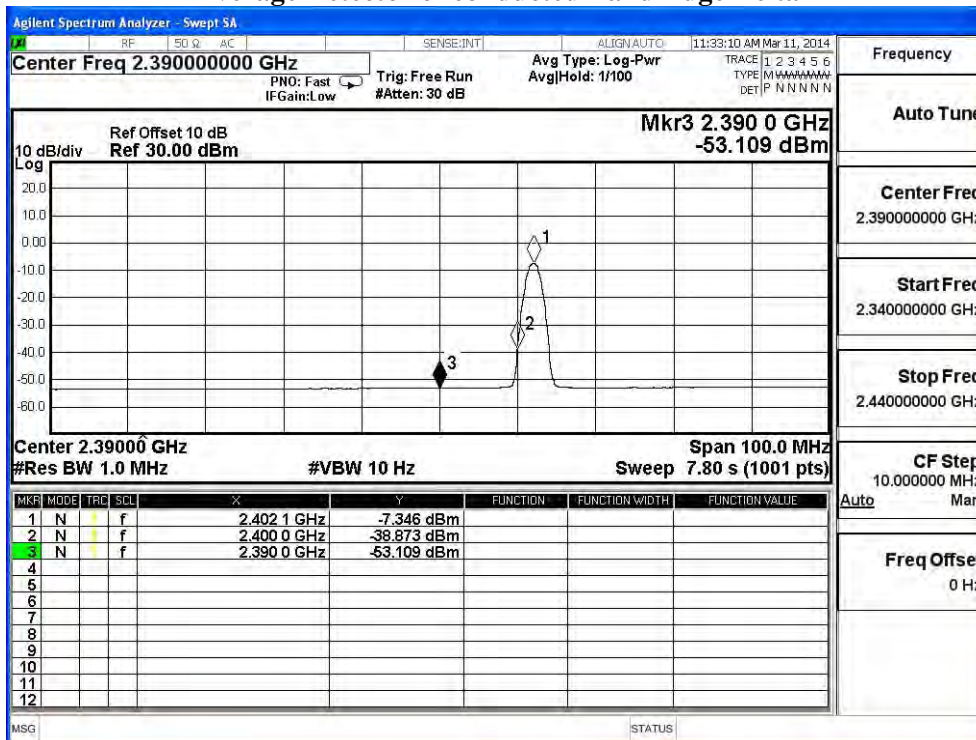

Product : Wireless Motherboard
 Test Item : Band Edge
 Test Site : No.3 OATS
 Test Mode : Mode 2: Transmit - 3Mbps (8DPSK)

Fundamental Filed Strength

Antenna Pole	Frequency [MHz]	Correction Factor [dB/m]	Reading Level [dB μ V]	Emission Level [dB(uV/m)]	Detector
Horizontal	2480	32.155	74.47	106.626	Peak
Horizontal	2480	32.155	58.33	90.486	Average
Vertical	2480	31.412	69.88	101.292	Peak
Vertical	2480	31.412	54.35	85.762	Average

Note: 1: Spectrum Analyzer setting:

Peak detector: RBW=1MHz, VBW=1MHz

Average detector: RBW=1MHz, VBW=10Hz

Band Edge Test Data

Antenna Pole	Test Frequency (MHz)	Fundamental (dB μ V/m)	Δ (dB)	Band Edge Field Strength (dB μ V/m)	Limit (dB μ V/m)	Detector
Horizontal	2486.7	106.626	44.38	62.246	74.000	Peak
Horizontal	2483.5	90.486	45.32	45.166	54.000	Average
Vertical	2486.7	101.292	44.38	56.912	74.000	Peak
Vertical	2483.5	85.762	45.32	40.442	54.000	Average

Note:

The Band Edge Field Strength was calculated using the Fundamental and Conducted Band Edge measurements per the Marker-Delta Method with the following formula:

Band Edge field Strength = F - Δ

F = Fundamental field Strength (Peak or Average)

Δ = Conducted Band Edge Delta (Peak or Average)

Peak Detector of conducted Band Edge Delta

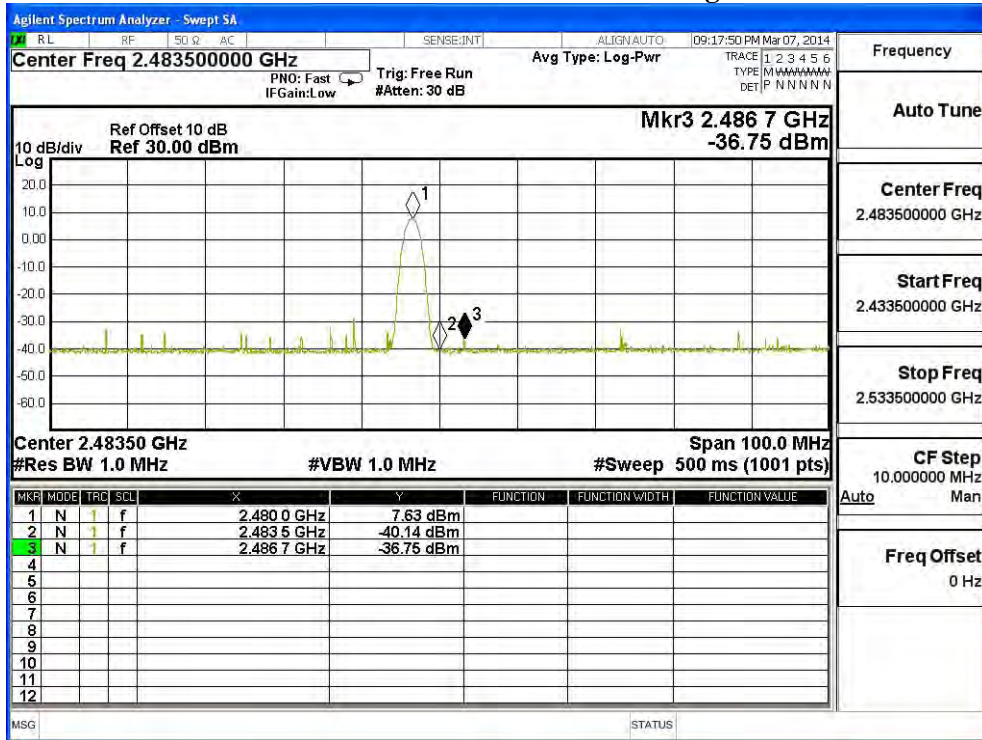

Average Detector of conducted Band Edge Delta

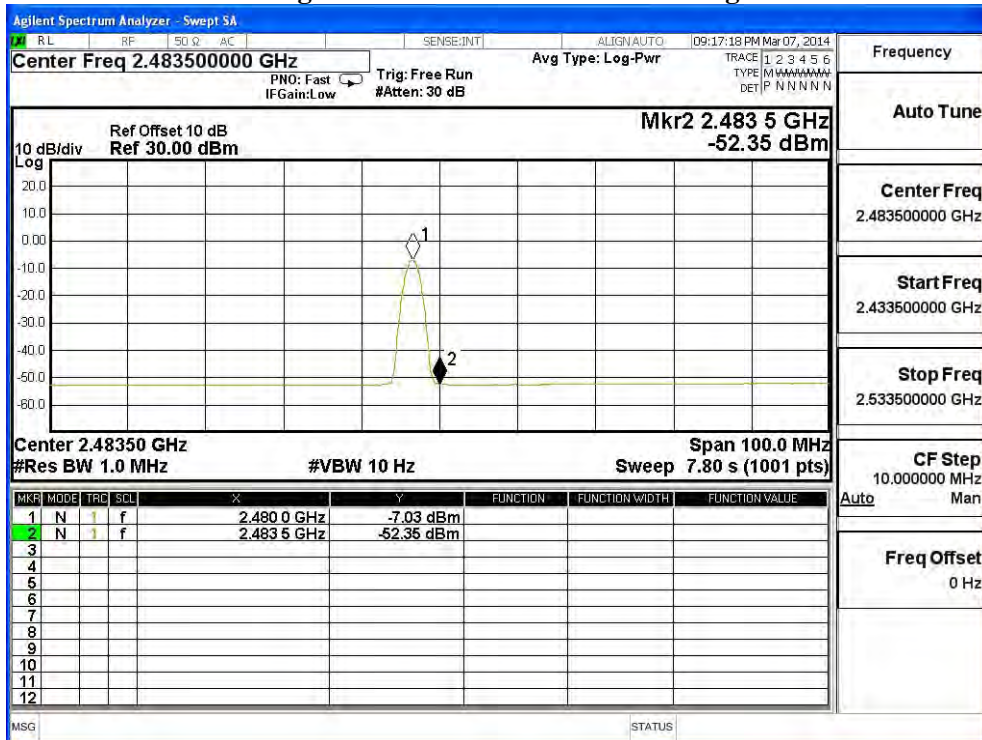

7. Channel Number

7.1. Test Equipment

	Equipment	Manufacturer	Model No./Serial No.	Last Cal.
	Spectrum Analyzer	R&S	FSP40 / 100170	Jun., 2013
	Spectrum Analyzer	Agilent	E4407B / US39440758	Jun., 2013
X	Spectrum Analyzer	Agilent	N9010A / MY48030495	Apr., 2014

Note: 1. All equipments are calibrated every one year.
 2. The test instruments marked by “X” are used to measure the final test results.

7.2. Test Setup

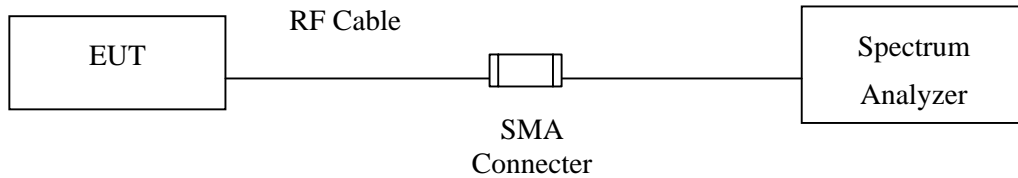

7.3. Limit

Frequency hopping systems operating in the 2400-2483.5 MHz bands shall use at least 75 hopping frequencies.

7.4. Test Procedure

The EUT was setup to ANSI C63.10, 2009; tested to FHSS test procedure of FCC Public Notice DA 00-705 for compliance to FCC 47CFR 15.247 requirements.

7.5. Uncertainty

N/A

7.6. Test Result of Channel Number

Product : Wireless Motherboard
 Test Item : Channel Number
 Test Site : No.3 OATS
 Test Mode : Mode 1: Transmit - 1Mbps (GFSK)

Frequency Range (MHz)	Measurement (Hopping Channel)	Required Limit (Hopping Channel)	Result
2402 ~ 2480	79	>75	Pass

2402-2421MHz

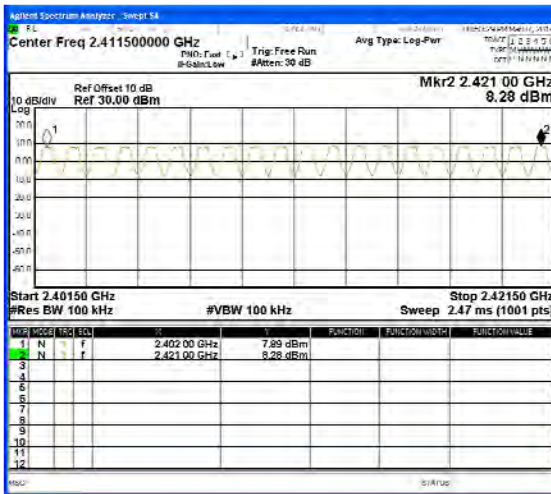

2422-2441MHz

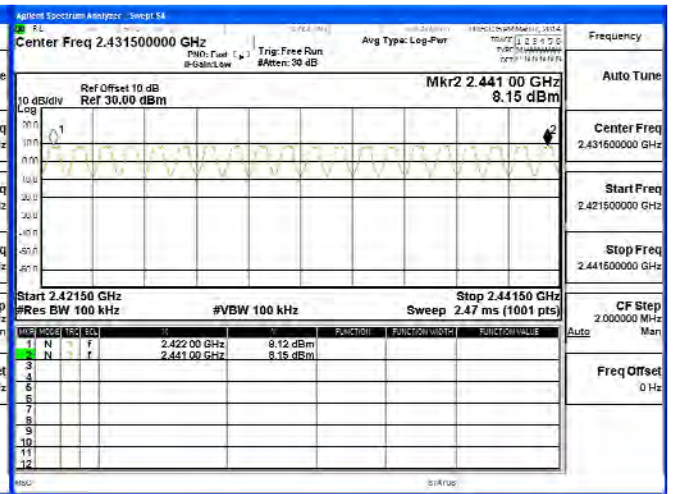

2442-2461MHz

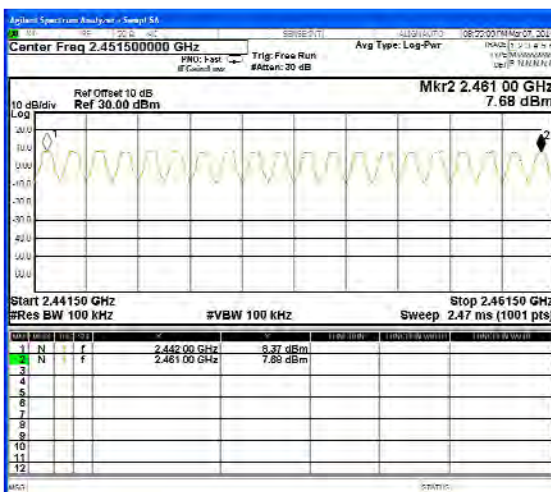

2462-2480MHz

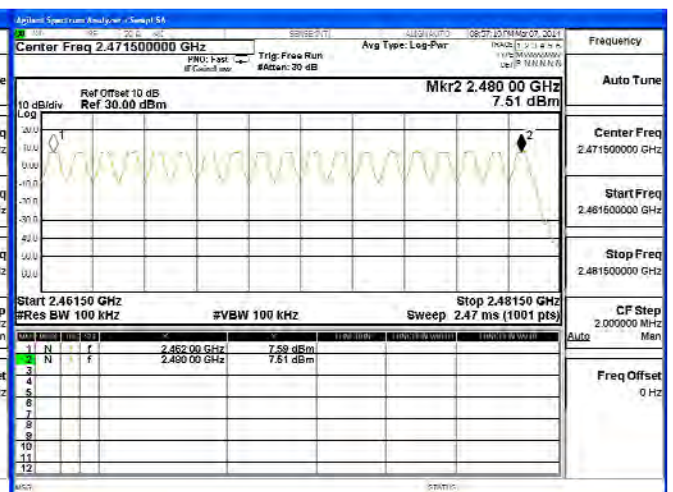

Product : Wireless Motherboard
 Test Item : Channel Number
 Test Site : No.3 OATS
 Test Mode : Mode 2: Transmit - 3Mbps (8DPSK)

Frequency Range (MHz)	Measurement (Hopping Channel)	Required Limit (Hopping Channel)	Result
2402 ~ 2480	79	>75	Pass

2402-2421MHz

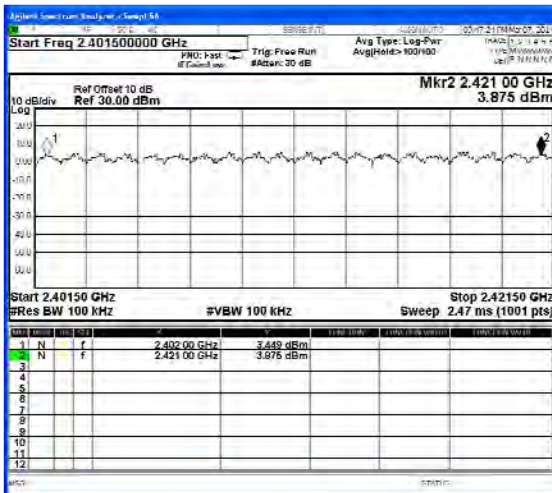

2422-2441MHz

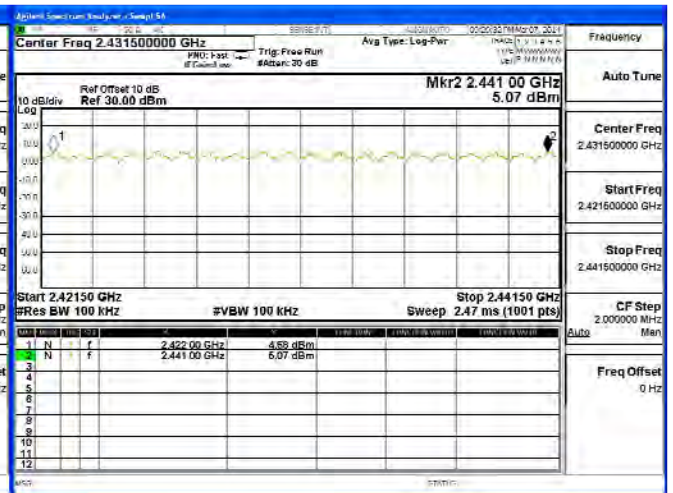

2442-2461MHz



2462-2480MHz

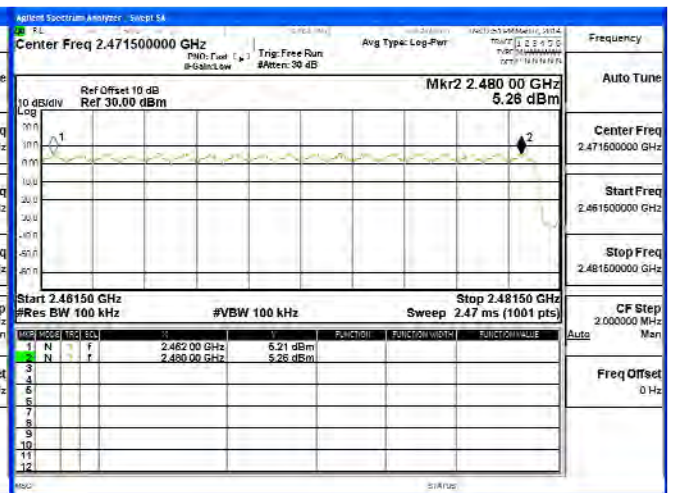

8. Channel Separation

8.1. Test Equipment

	Equipment	Manufacturer	Model No./Serial No.	Last Cal.
	Spectrum Analyzer	R&S	FSP40 / 100170	Jun., 2013
	Spectrum Analyzer	Agilent	E4407B / US39440758	Jun., 2013
X	Spectrum Analyzer	Agilent	N9010A / MY48030495	Apr., 2014

- Note:
1. All equipments are calibrated every one year.
 2. The test instruments mark by “X” are used to measure the final test results.

8.2. Test Setup

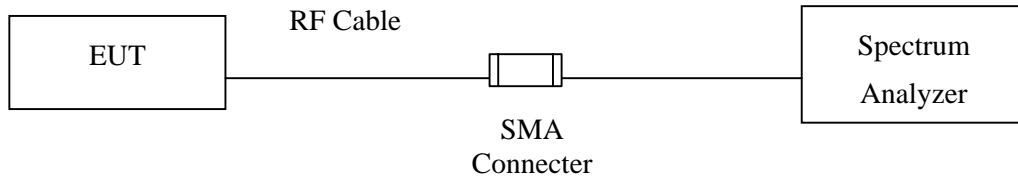

8.3. Limit

Frequency hopping systems shall have hopping channel carrier frequencies separated by a minimum of 25 kHz or the 20 dB bandwidth of the hopping channel, whichever is greater.

8.4. Test Procedure

The EUT was setup to ANSI C63.10, 2009; tested to FHSS test procedure of FCC Public Notice DA 00-705 for compliance to FCC 47CFR 15.247 requirements.

8.5. Uncertainty

± 150Hz

8.6. Test Result of Channel Separation

Product : Wireless Motherboard
 Test Item : Channel Separation
 Test Site : No.3 OATS
 Test Mode : Mode 1: Transmit - 1Mbps (GFSK)

Channel No.	Frequency (MHz)	Measurement Level (kHz)	Limit (kHz)	Limit of (2/3)*20dB Bandwidth (kHz)	Result
00	2402	1000	>25 kHz	760.0	Pass
39	2441	1000	>25 kHz	760.0	Pass
78	2480	1000	>25 kHz	766.7	Pass

NOTE: The 20dB Bandwidth is refer to section 10.

Channel 00 2402MHz

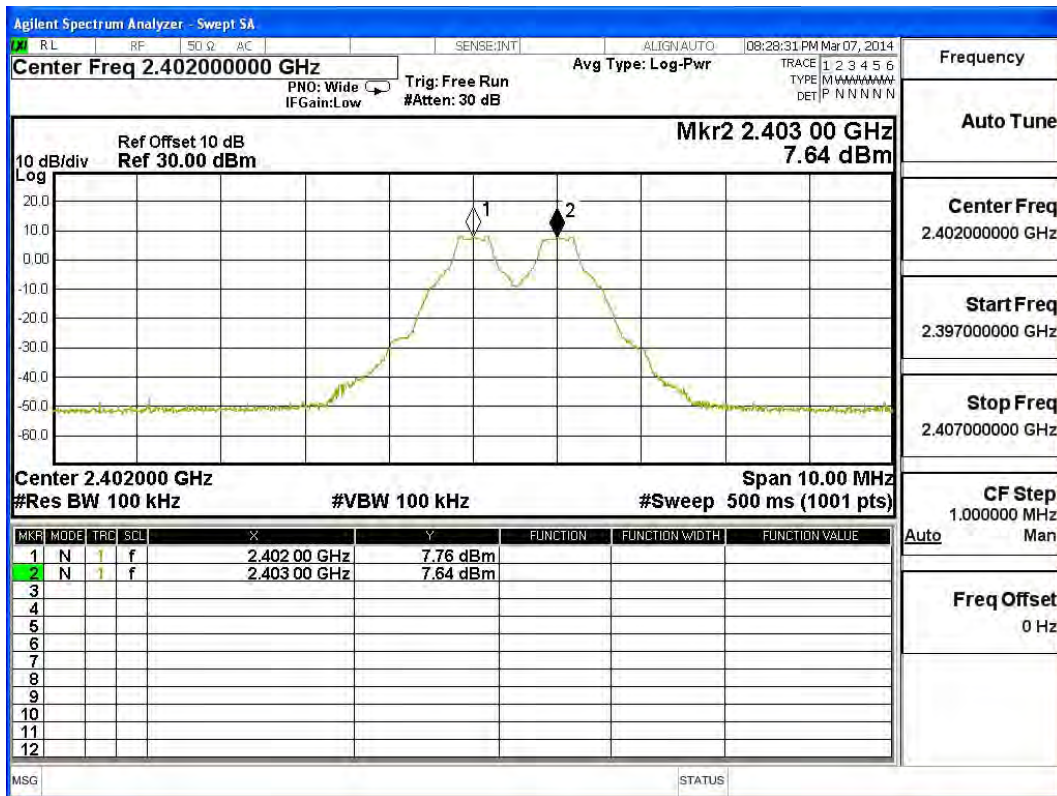

Channel 39 2441MHz

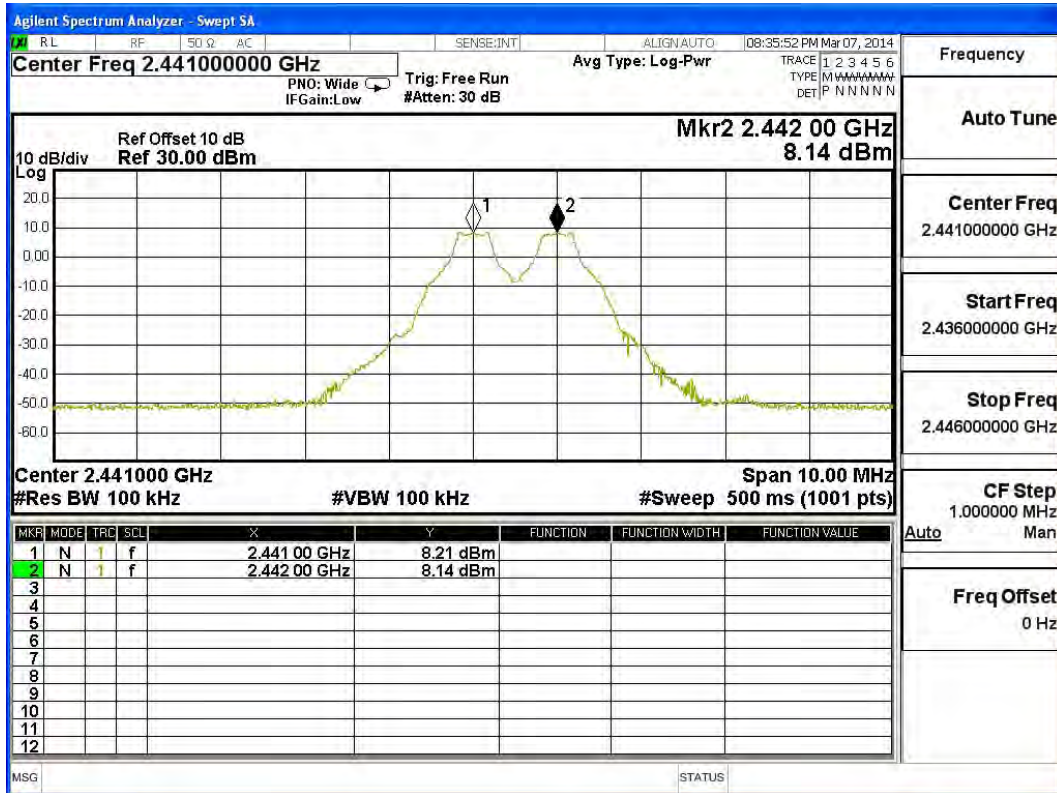

Channel 78 2480 MHz

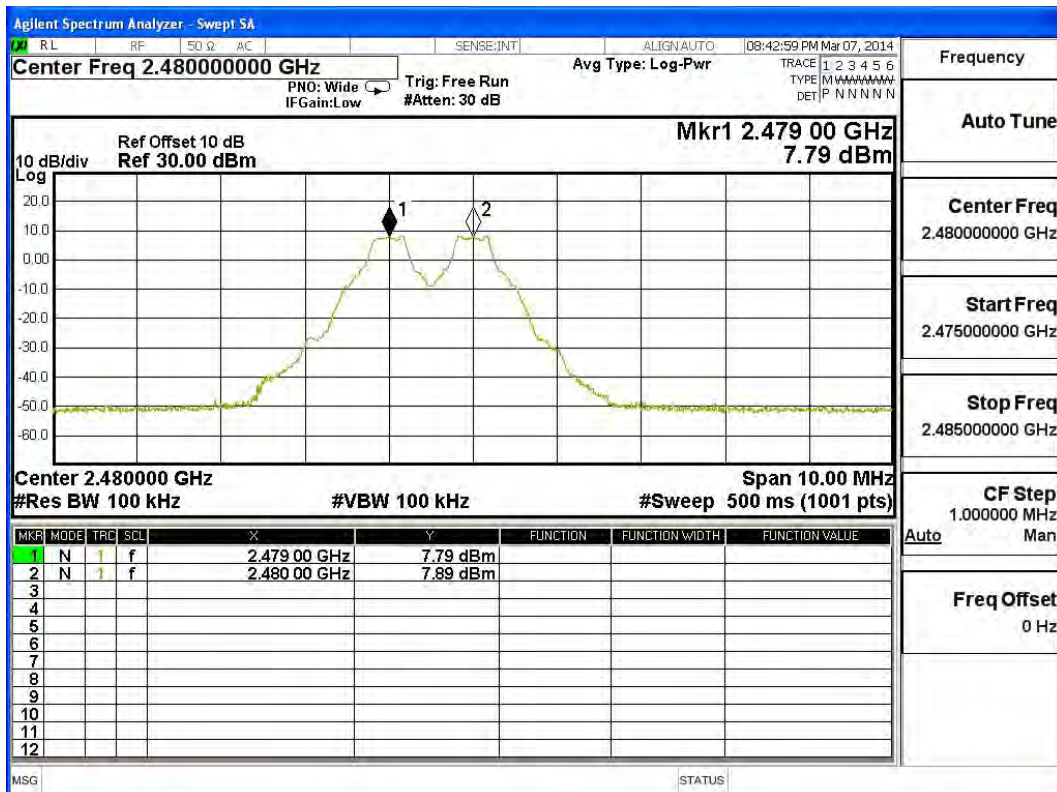

Product : Wireless Motherboard
 Test Item : Channel Separation
 Test Site : No.3 OATS
 Test Mode : Mode 2: Transmit - 3Mbps (8DPSK)

Channel No.	Frequency (MHz)	Measurement Level (kHz)	Limit (kHz)	Limit of (2/3)*20dB Bandwidth (kHz)	Result
00	2402	1000	>25 kHz	946.7	Pass
39	2441	1000	>25 kHz	946.7	Pass
78	2480	1000	>25 kHz	946.7	Pass

NOTE: The 20dB Bandwidth is refer to section 10.

Channel 00 2402MHz

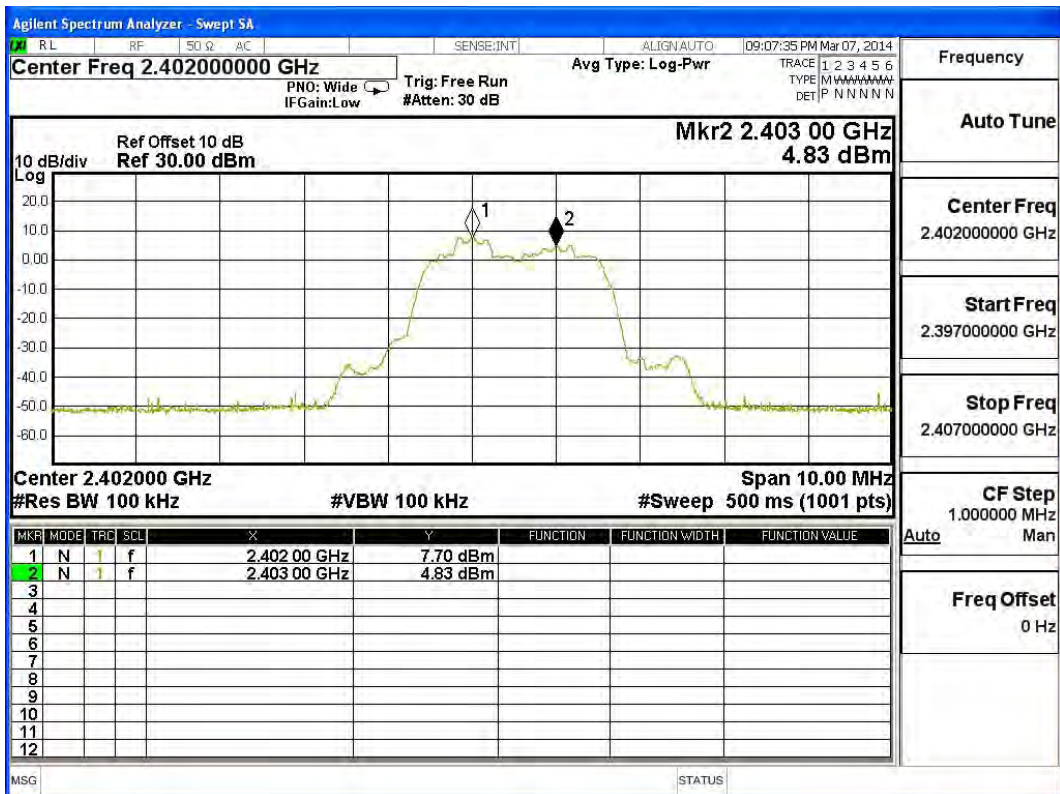

Channel 39 2441MHz

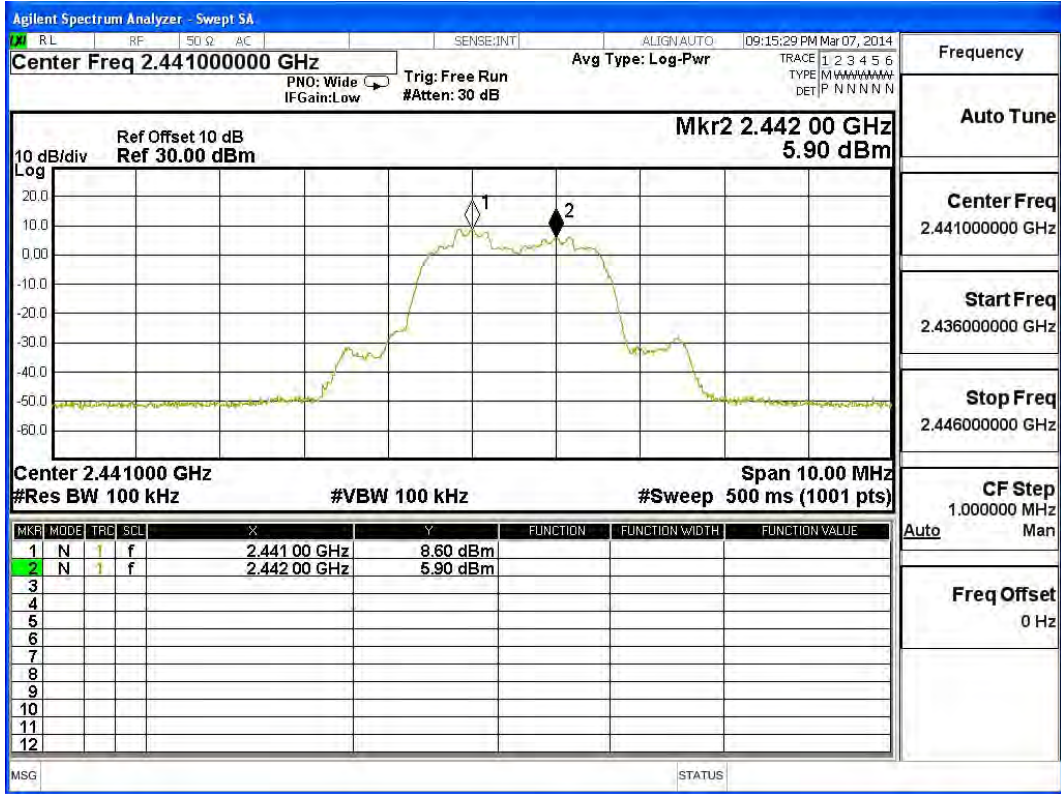

Channel 78 2480 MHz

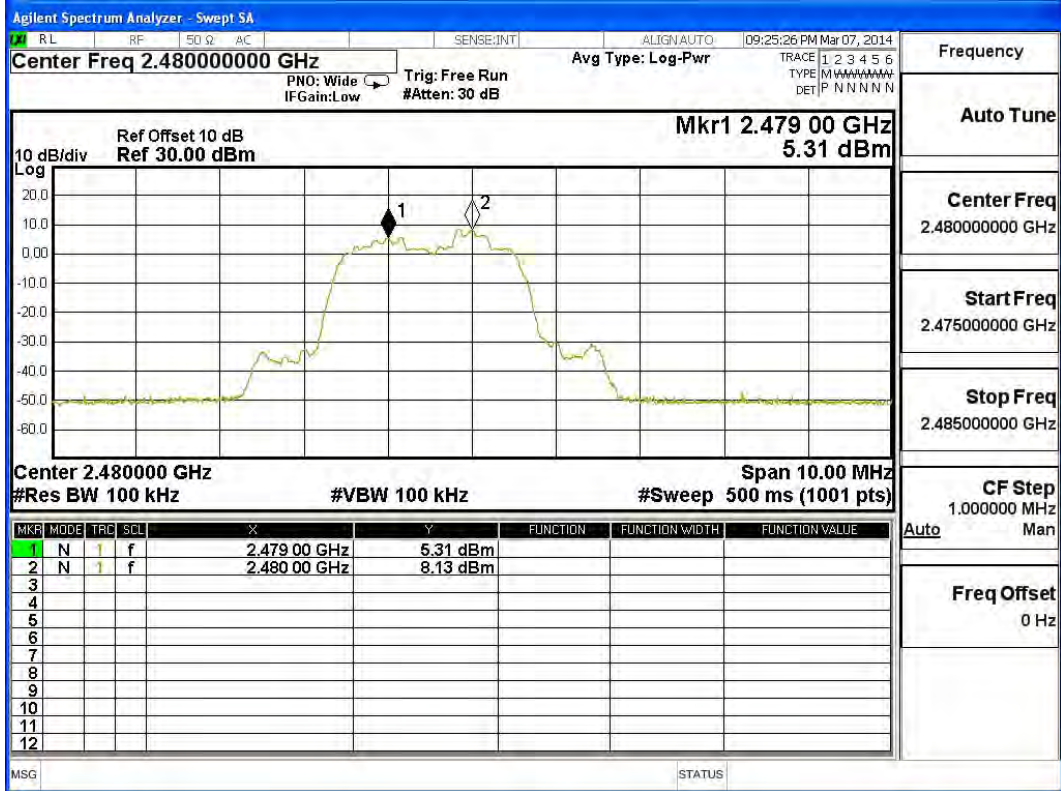

9. Dwell Time

9.1. Test Equipment

	Equipment	Manufacturer	Model No./Serial No.	Last Cal.
	Spectrum Analyzer	R&S	FSP40 / 100170	Jun., 2013
	Spectrum Analyzer	Agilent	E4407B / US39440758	Jun., 2013
X	Spectrum Analyzer	Agilent	N9010A / MY48030495	Apr., 2014

- Note:
1. All equipments are calibrated every one year.
 2. The test instruments marked by “X” are used to measure the final test results.

9.2. Test Setup

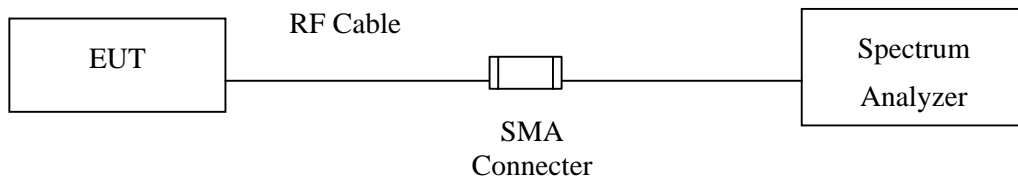

9.3. Limit

The dwell time shall be the average time of occupancy on any frequency shall not be greater than 0.4 seconds within a 30 second period.

9.4. Test Procedure

The EUT was setup to ANSI C63.10, 2009; tested to FHSS test procedure of FCC Public Notice DA 00-705 for compliance to FCC 47CFR 15.247 requirements.

9.5. Uncertainty

± 25msec

9.6. Test Result of Dwell Time

Product : Wireless Motherboard
 Test Item : Dwell Time
 Test Site : No.3 OATS
 Test Mode : Mode 1: Transmit - 1Mbps (GFSK) (Channel 00,39,78 –DH5)

Frequency (MHz)	Time slot length (ms)	Hopping of Number	Sweep time (ms)	Duty cycle	Dwell Time (Sec)	Limit (Sec)	Result
2402	2.890	13	50	0.75	0.301	0.4	Pass
2441	2.880	13	50	0.75	0.300	0.4	Pass
2480	2.890	13	50	0.75	0.301	0.4	Pass

Duty cycle = ((Time slot length(ms)*Hopping of Number) / Sweep time (ms))

Dwell time = (Duty cycle / 79) * (79*0.4)

CH 00 Time Interval between hops

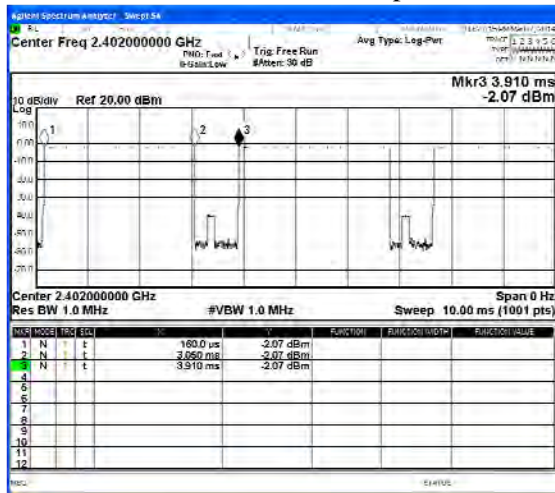

CH 00 Transmission Time

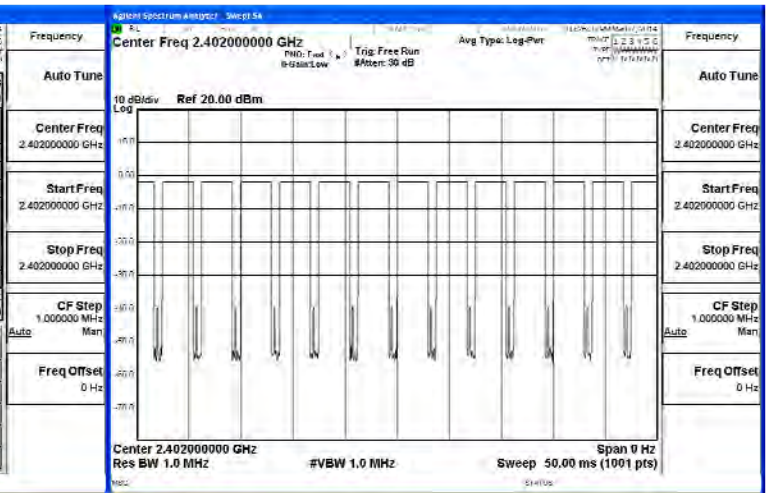

CH39 Time Interval between hops

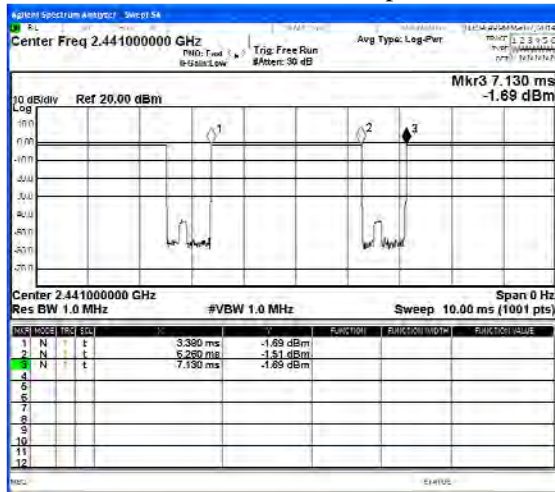

CH 39 Transmission Time

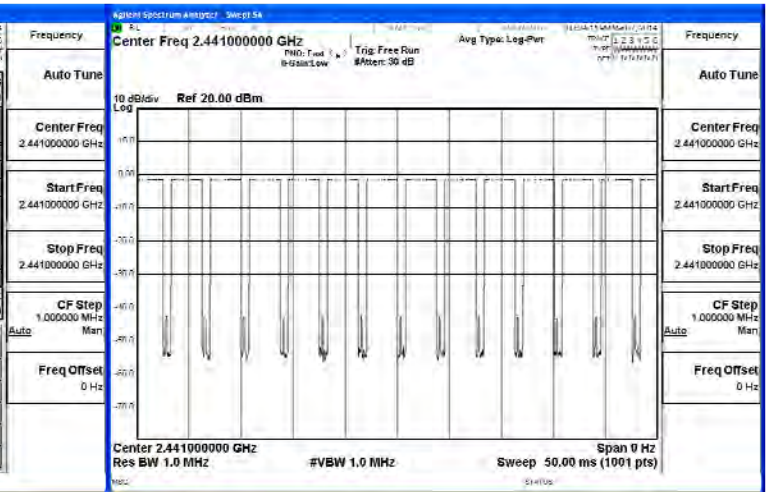

CH 78 Time Interval between hops

CH 78 Transmission Time

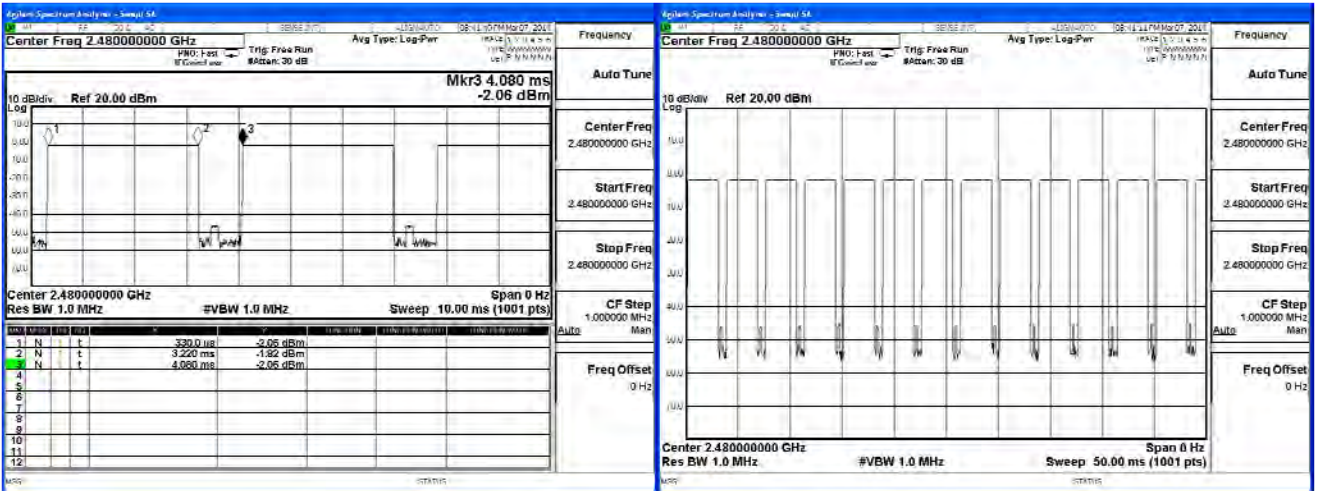

Note:

The dwell times of the packet type of DH1, DH3, and DH5 are tested. Only the worst case is shown on the report.

Product : Wireless Motherboard
 Test Item : Dwell Time
 Test Site : No.3 OATS
 Test Mode : Mode 2: Transmit - 3Mbps (8DPSK) (Channel 00,39,78 –DH5)

Frequency (MHz)	Time slot length (ms)	Hopping of Number	Sweep time (ms)	Duty cycle	Dwell Time (Sec)	Limit (Sec)	Result
2402	2.890	13	50	0.75	0.301	0.4	Pass
2441	2.890	14	50	0.81	0.324	0.4	Pass
2480	2.890	13	50	0.75	0.301	0.4	Pass

Duty cycle = ((Time slot length(ms)*Hopping of Number) / Sweep time (ms))

Dwell time = (Duty cycle /79) * (79*0.4)

CH 00 Time Interval between hops

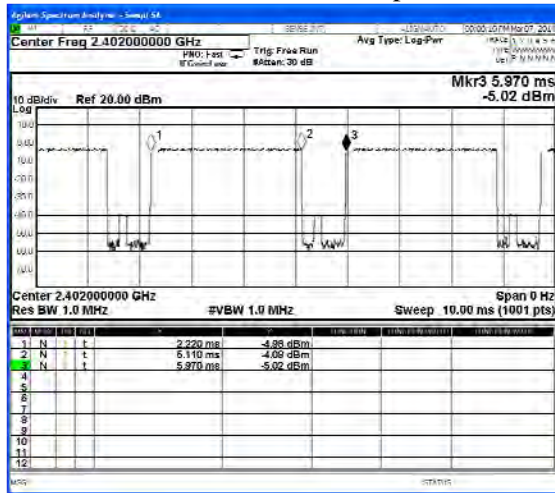

CH 00 Transmission Time

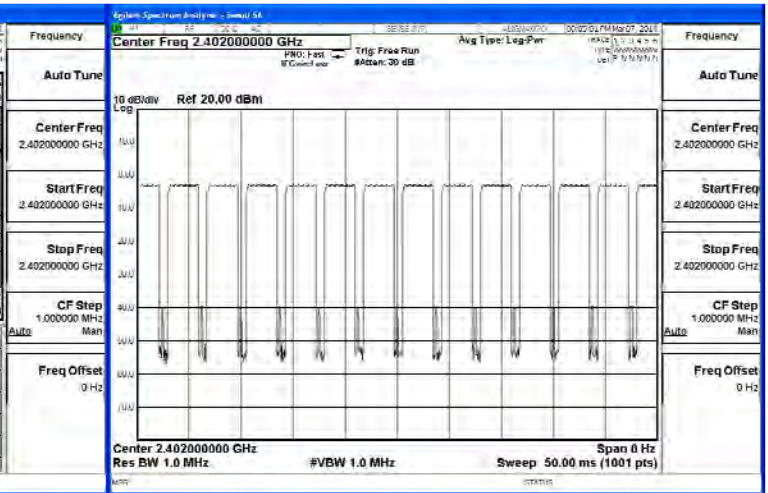

CH39 Time Interval between hops

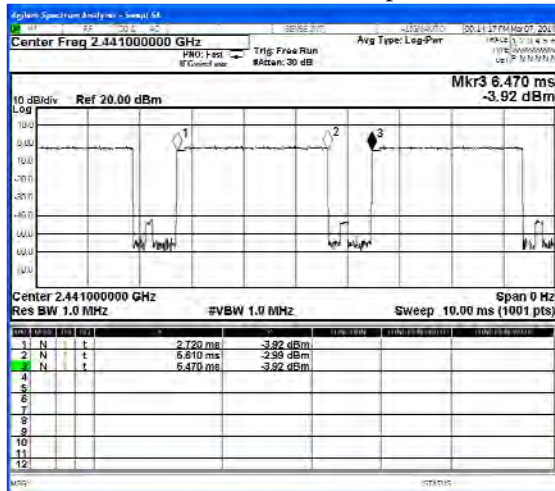

CH 39 Transmission Time

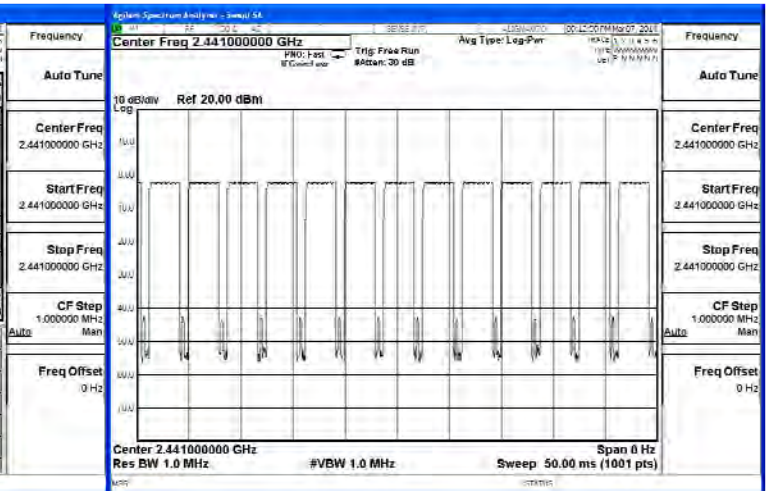

CH 78 Time Interval between hops

CH 78 Transmission Time

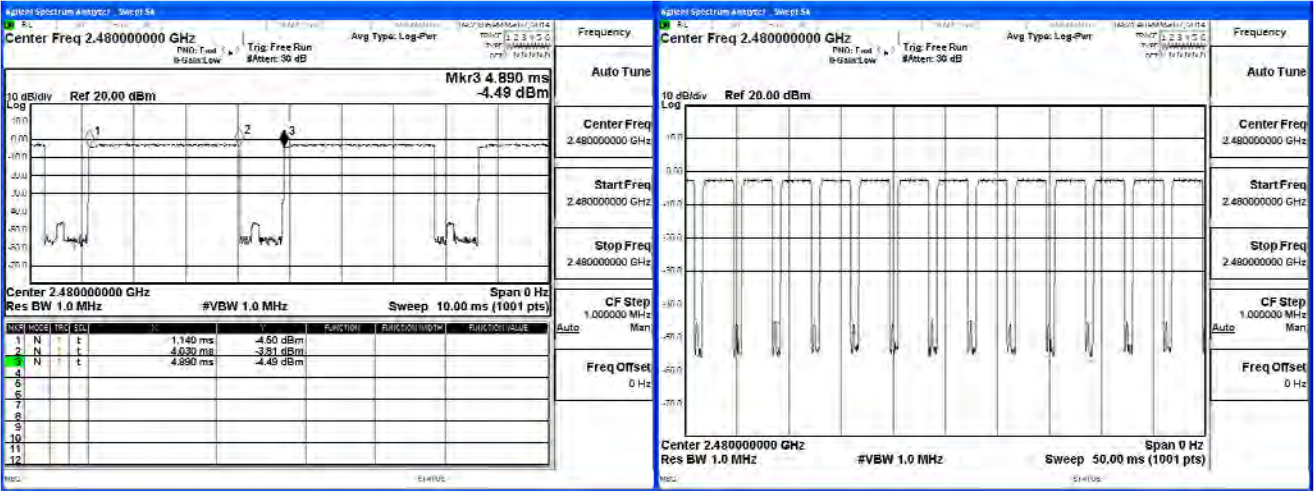

Note:

The dwell times of the packet type of DH1, DH3, and DH5 are tested. Only the worst case is shown on the report.

10. Occupied Bandwidth

10.1. Test Equipment

	Equipment	Manufacturer	Model No./Serial No.	Last Cal.
	Spectrum Analyzer	R&S	FSP40 / 100170	Jun., 2013
	Spectrum Analyzer	Agilent	E4407B / US39440758	Jun., 2013
X	Spectrum Analyzer	Agilent	N9010A / MY48030495	Apr., 2014

- Note: 1. All equipments are calibrated every one year.
 2. The test instruments marked by “X” are used to measure the final test results.

10.2. Test Setup

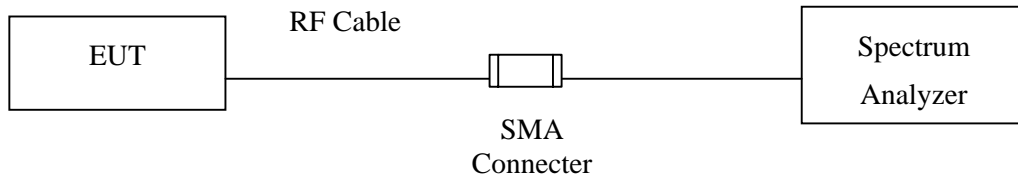

10.3. Limits

N/A

10.4. Test Procedure

The EUT was setup to ANSI C63.10, 2009; tested to FHSS test procedure of FCC Public Notice DA 00-705 for compliance to FCC 47CFR 15.247 requirements.

10.5. Uncertainty

± 150Hz

10.6. Test Result of Occupied Bandwidth

Product : Wireless Motherboard
 Test Item : Occupied Bandwidth Data
 Test Site : No.3 OATS
 Test Mode : Mode 1: Transmit - 1Mbps (GFSK)(2402MHz)

Channel No.	Frequency (MHz)	Measurement Level (kHz)	Required Limit (kHz)	Result
00	2402	1140	--	NA

Figure Channel 00:

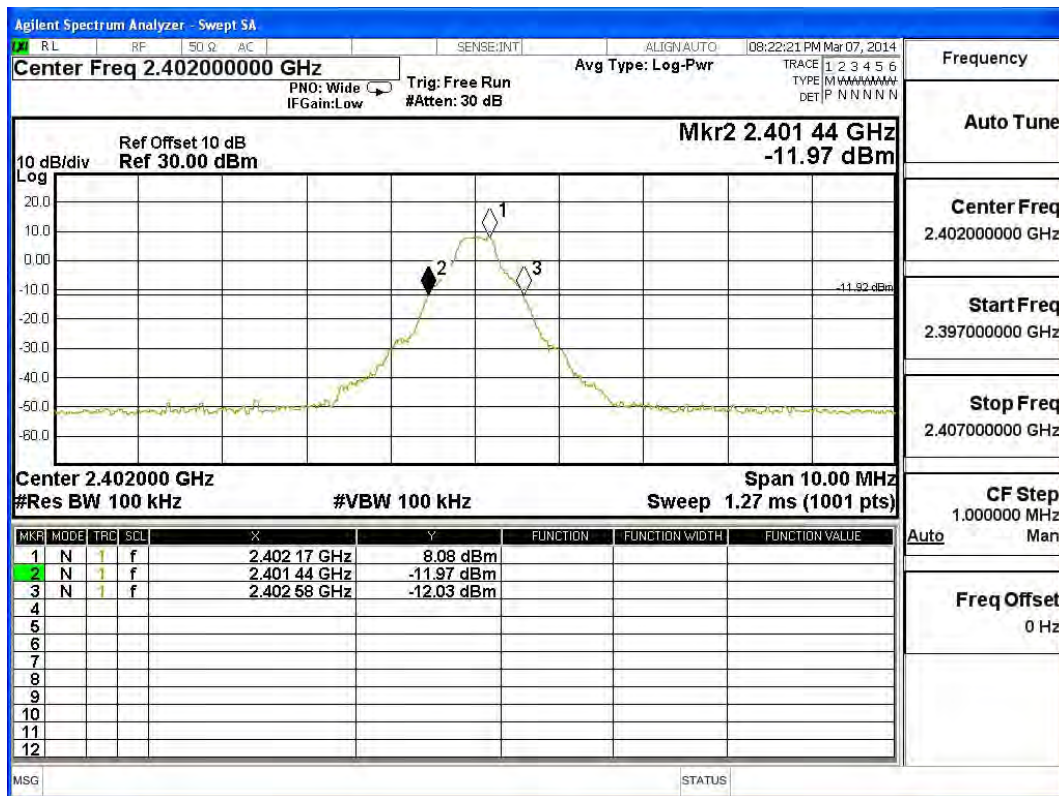

Product : Wireless Motherboard
 Test Item : Occupied Bandwidth Data
 Test Site : No.3 OATS
 Test Mode : Mode 1: Transmit - 1Mbps (GFSK)(2441MHz)

Channel No.	Frequency (MHz)	Measurement Level (kHz)	Required Limit (kHz)	Result
39	2441	1140	--	NA

Figure Channel 39:

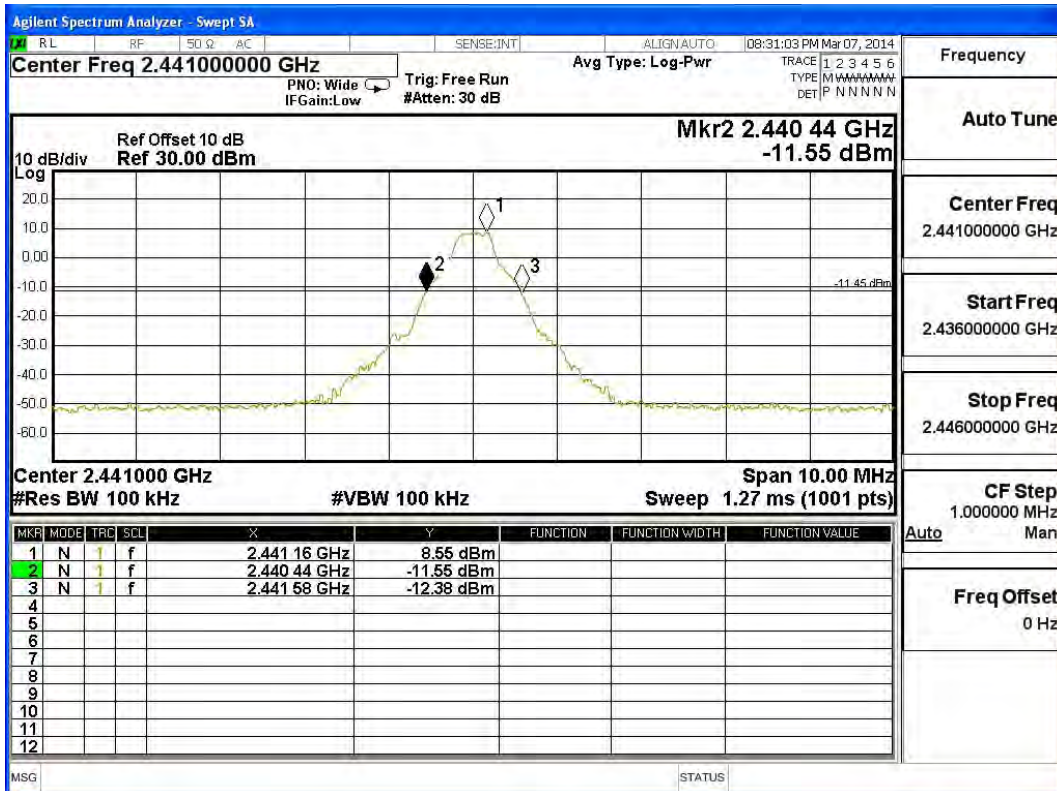

Product : Wireless Motherboard
 Test Item : Occupied Bandwidth Data
 Test Site : No.3 OATS
 Test Mode : Mode 1: Transmit - 1Mbps (GFSK)(2480MHz)

Channel No.	Frequency (MHz)	Measurement Level (kHz)	Required Limit (kHz)	Result
78	2480	1150	--	NA

Figure Channel 78:

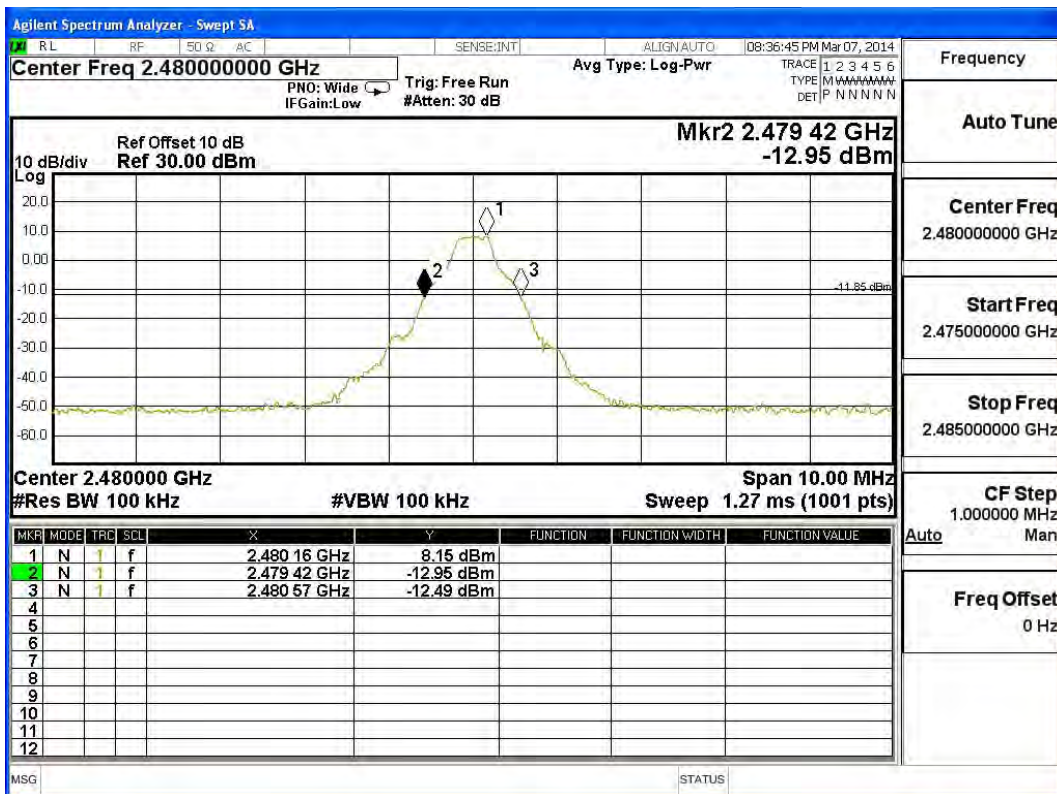

Product : Wireless Motherboard
 Test Item : Occupied Bandwidth Data
 Test Site : No.3 OATS
 Test Mode : Mode 2: Transmit - 3Mbps (8DPSK) (2402MHz)

Channel No.	Frequency (MHz)	Measurement Level (kHz)	Required Limit (kHz)	Result
00	2402	1420	--	NA

Figure Channel 00:

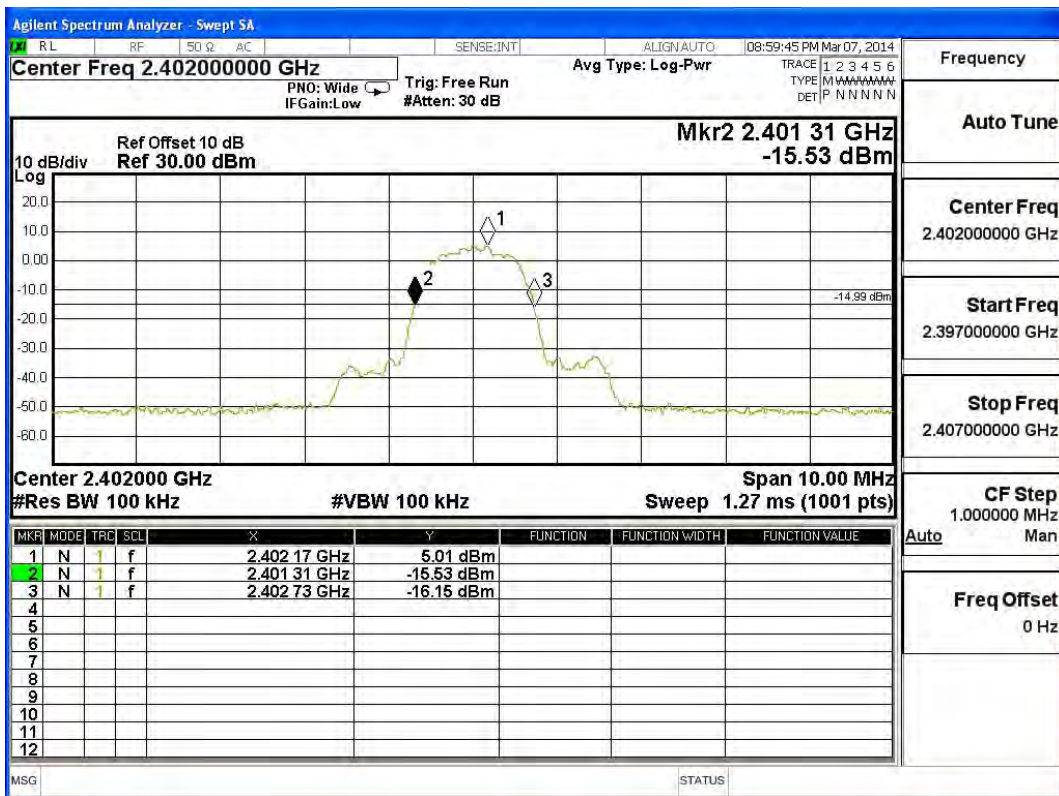

Product : Wireless Motherboard
 Test Item : Occupied Bandwidth Data
 Test Site : No.3 OATS
 Test Mode : Mode 2: Transmit - 3Mbps (8DPSK) (2441MHz)

Channel No.	Frequency (MHz)	Measurement Level (kHz)	Required Limit (kHz)	Result
39	2441	1420	--	NA

Figure Channel 39:

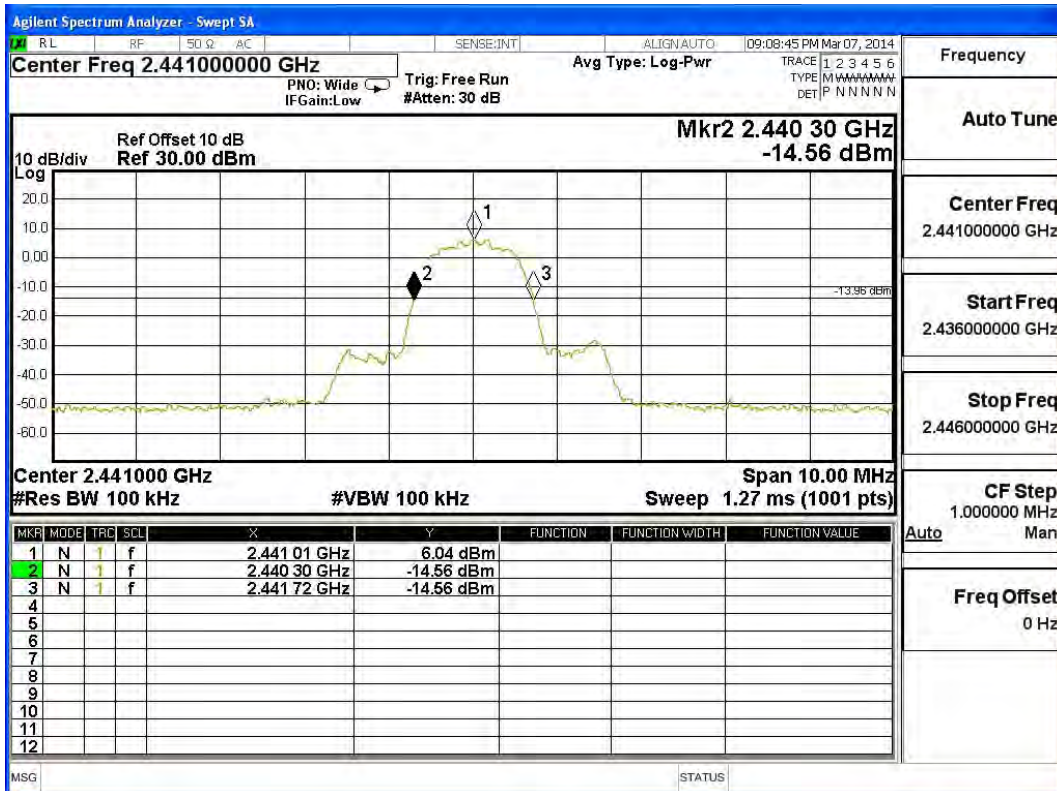

Product : Wireless Motherboard
 Test Item : Occupied Bandwidth Data
 Test Site : No.3 OATS
 Test Mode : Mode 2: Transmit - 3Mbps (8DPSK)(2480MHz)

Channel No.	Frequency (MHz)	Measurement Level (kHz)	Required Limit (kHz)	Result
78	2480	1420	--	NA

Figure Channel 78:

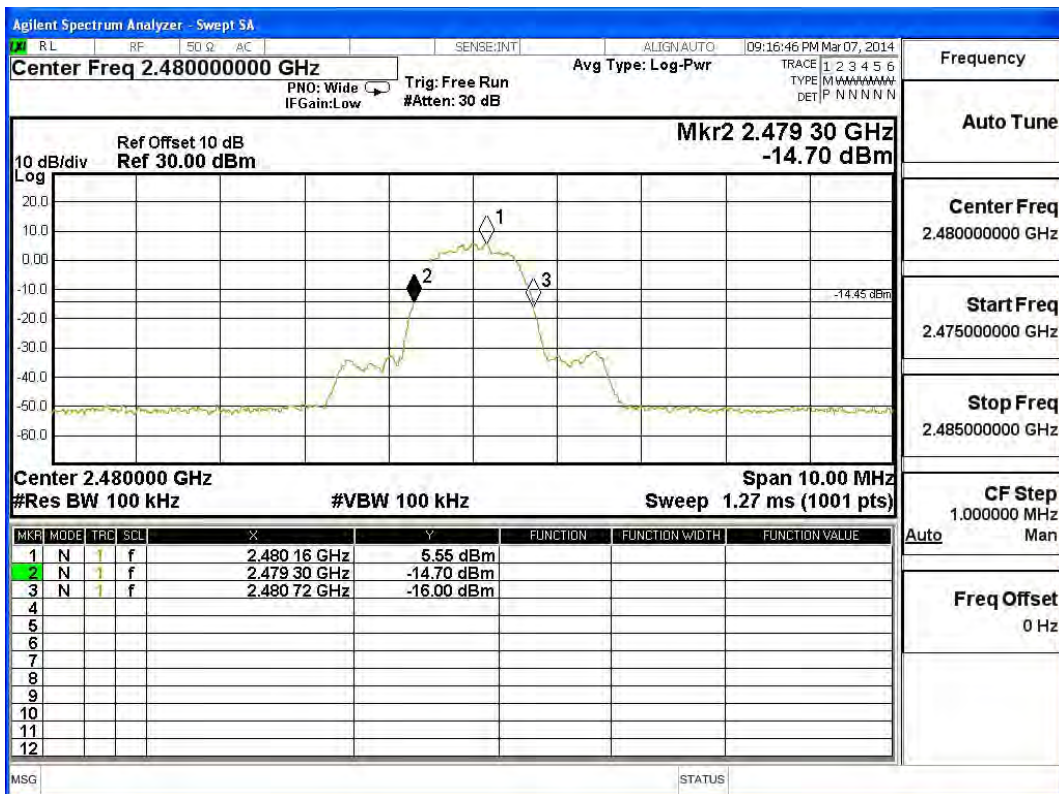

11. EMI Reduction Method During Compliance Testing

No modification was made during testing.