

FCC SAR Test Report (Class II Permissive Change)

Product Name : Wireless Motherboard
Model No. : TA80TA1

Applicant : ELITEGROUP COMPUTER SYSTEMS CO., LTD.
Address : No.239, Sec. 2, Ti Ding Blvd., Taipei, Taiwan

Date of Receipt : 2014/02/12
Issued Date : 2014/02/26
Report No. : 1420141R-SAUSP13V00
Report Version : V1.0



The test results relate only to the samples tested.

The test report shall not be reproduced except in full without the written approval of Quie Tek Corporation.

Test Report Certification

Issued Date: 2014/02/26

Report No.: 1420141R-SAUSP13V00



Product Name : Wireless Motherboard
 Applicant : ELITEGROUP COMPUTER SYSTEMS CO., LTD.
 Address : No.239, Sec. 2, Ti Ding Blvd., Taipei, Taiwan
 Manufacturer : ELITEGROUP COMPUTER SYSTEMS CO., LTD.
 Model No. : TA80TA1
 Trade Name : ECS
 FCC ID : WL6-TABC8TA1
 Applicable Standard : FCC Oet65 Supplement C June 2001
 IEEE Std. 1528-2003
 47CFR § 2.1093
 Measurement : KDB 447498 , KDB 248227, KDB 616217, KDB 865664
 procedures
 Test Result : Max. SAR Measurement (1g)
0.233 W/kg
 Application Type : Certification

The test results relate only to the samples tested.

The test report shall not be reproduced except in full without the written approval of Quietek Corporation.

Documented By : April Chen
 (Adm. Specialist / April Chen)

Tested By : wen Lee
 (Engineer / Wen Lee)

Approved By : Vincent Lin
 (Director / Vincent Lin)

TABLE OF CONTENTS

Description	Page
1. General Information.....	5
1.1 EUT Description	5
1.2 Antenna List.....	5
1.3 Maximum output power and tolerance allowed for production units.....	5
1.4 Test Environment	6
2. SAR Measurement System	7
2.1 DASY5 System Description	7
2.1.1 Applications	8
2.1.2 Area Scans.....	8
2.1.3 Zoom Scan (Cube Scan Averaging).....	8
2.1.4 Uncertainty of Inter-/Extrapolation and Averaging.....	8
2.2 DASY5 E-Field Probe	9
2.2.1 Isotropic E-Field Probe Specification	9
2.3 Boundary Detection Unit and Probe Mounting Device.....	10
2.4 DATA Acquisition Electronics (DAE) and Measurement Server	10
2.5 Robot.....	11
2.6 Light Beam Unit.....	11
2.7 Device Holder	12
2.8 SAM Twin Phantom	12
3. Tissue Simulating Liquid	13
3.1 The composition of the tissue simulating liquid	13
3.2 Tissue Calibration Result	13
3.3 Tissue Dielectric Parameters for Head and Body Phantoms	14
4. SAR Measurement Procedure	15
4.1 SAR System Check.....	15
4.1.1 Dipoles	15
4.1.2 System Check Result	15
4.2 SAR Measurement Procedure.....	16
5. SAR Exposure Limits	17
6. Test Equipment List.....	18
7. Measurement Uncertainty	19
8. Conducted Power Measurement	20
9. Test Results.....	21
9.1 SAR Test Results Summary	21
10. SAR measurement variability	22

Appendix.....23

Appendix A. SAR System Check Data

Appendix B. SAR measurement Data

Appendix C. Test Setup Photographs & EUT Photographs

Appendix D. Probe Calibration Data

Appendix E. Dipole Calibration Data

1. General Information

1.1 EUT Description

Product Name	Wireless Motherboard
Trade Name	ECS
Model No.	TA80TA1
FCC ID	WL6-TABC8TA1
TX Frequency	2412MHz~2462MHz
Type of Modulation	DSSS/OFDM/BPSK/QPSK/16QAM/64QAM
Antenna Type	PCB Antenna
Device Category	Portable
RF Exposure Environment	Uncontrolled
Max. Output Power (Conducted)	802.11b: 14.27 dBm 802.11g: 16.61 dBm 802.11n: 16.54 dBm

*Note: (1) This is to request a Class II permissive change for FCC ID: WL6-TABC8TA1, originally granted on 03/17/2014

The major change filed under this application is:

Change #1: Implementation in new tablet

Model number: TA80TAX (X=0,2~9,A~Z)

Product name: Tablet PC

(2) Per FCC KDB 447498 D01.

(3) The output power of BT is less than 10mW, so SAR not required.

(4) BT & WLAN can't work simultaneously, thus simultaneous mode is no need.

1.2 Antenna List

No.	Manufacturer	Part No.	Peak Gain
1	JEM	13H130-JV8070	2.85 dBi for 2.4GHz
2	WGT	13H130-JV8050	1.77 dBi for 2.4GHz

* Note : Only the higher gain antenna was tested and recorded in this report. When SAR value is less than 0.8 W/kg, other antenna evaluation is not required

1.3 Maximum output power and tolerance allowed for production units

Band	Mode	Nominal power (dBm)	Tolerance (dBm)	Upper Tolerance (dBm)
2.4G	802.11b	13	±1.5	14.5
2.4G	802.11g/n-20	15.5	±1.5	17

1.4 Test Environment

Ambient conditions in the laboratory:

Items	Required	Actual
Temperature (°C)	18-25	21.8± 2
Humidity (%RH)	30-70	55

Site Description:

Accredited by TAF
Accredited Number: 0914
Effective through: December 12, 2014

Site Name: Quietek Corporation

Site Address: No. 5-22, Rueishu Keng, Linkou Dist.,
New Taipei City 24451,
Taiwan. R.O.C.
TEL: 886-2-8601-3788 / FAX: 886-2-8601-3789
E-Mail: service@quietek.com

2. SAR Measurement System

2.1 DASY5 System Description

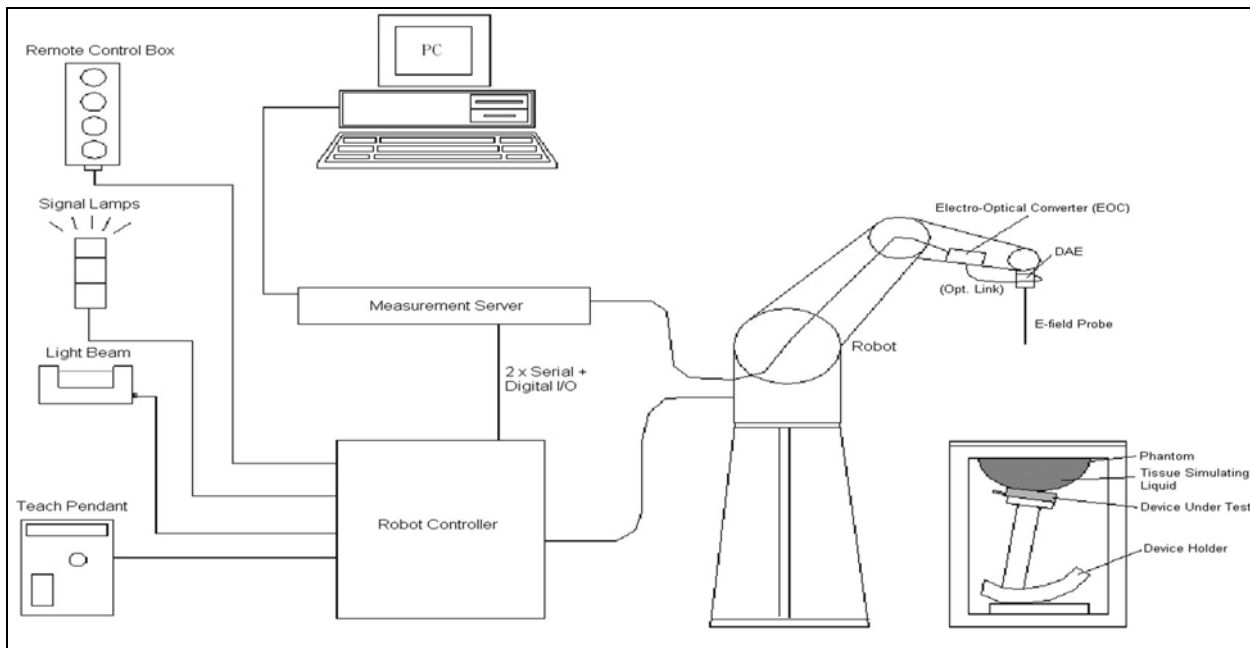

The DASY5 system for performing compliance tests consists of the following items:

- A standard high precision 6-axis robot with controller, teach pendant and software. An arm extension for accommodating the data acquisition electronics (DAE).
- A data acquisition electronics (DAE) which performs the signal amplification, signal multiplexing, AD-conversion, offset measurements, mechanical surface detection, collision detection, etc. The unit is battery powered with standard or rechargeable batteries. The signal is optically transmitted to the EOC.
- The Electro-optical converter (EOC) performs the conversion from optical to electrical signals for the digital communication to the DAE. To use optical surface detection, a special version of the EOC is required. The EOC signal is transmitted to the measurement server.
- The Light Beam used is for probe alignment. This improves the (absolute) accuracy of the probe positioning.
- A computer running WinXP and the DASY5 software.
- Remote control and teach pendant as well as additional circuitry for robot safety such as warning lamps, etc.
- The phantom, the device holder and other accessories according to the targeted measurement.

2.1.1 Applications

Predefined procedures and evaluations for automated compliance testing with all worldwide standards, e.g., IEEE 1528, OET 65, IEC 62209-1, IEC 62209-2, EN 50360, EN 50383 and others.

2.1.2 Area Scans

Area scans are defined prior to the measurement process being executed with a user defined variable spacing between each measurement point (integral) allowing low uncertainty measurements to be conducted. Scans defined for FCC applications utilize a 10mm² step integral, with 1mm interpolation used to locate the peak SAR area used for zoom scan assessments.

When an Area Scan has measured all reachable points, it computes the field maxima found in the scanned area, within a range of the global maximum. The range (in dB) is specified in the standards for compliance testing. For example, a 2 dB range is required in IEEE 1528-2003, EN 50361 and IEC 62209 standards, whereby 3 dB is a requirement when compliance is assessed in accordance with the ARIB standard (Japan).

2.1.3 Zoom Scan (Cube Scan Averaging)

Zoom Scans are used to assess the peak spatial SAR values within a cubic averaging volume containing 1 g and 10 g of simulated tissue. A density of 1000 kg/m³ is used to represent the head and body tissue density and not the phantom liquid density, in order to be consistent with the definition of the liquid dielectric properties, i.e. the side length of the 1 g cube is 10mm, with the side length of the 10 g cube 21,5mm.

The zoom scan integer steps can be user defined so as to reduce uncertainty, but normal practice for typical test applications (including FCC) utilize a physical step of 5x5x7 (8mmx8mmx5mm) providing a volume of 32mm in the X & Y axis, and 30mm in the Z axis.

2.1.4 Uncertainty of Inter-/Extrapolation and Averaging

In order to evaluate the uncertainty of the interpolation, extrapolation and averaged SAR calculation algorithms of the Postprocessor, DASY5 allows the generation of measurement grids which are artificially predefined by analytically based test functions. Therefore, the grids of area scans and zoom scans can be filled with uncertainty test data, according to the SAR benchmark functions of IEEE 1528. The three analytical functions shown in equations as below are used to describe the possible range of the expected SAR distributions for the tested handsets. The field gradients are covered by the spatially flat

distribution f_1 , the spatially steep distribution f_3 and f_2 accounts for H-field cancellation on the phantom/tissue surface.

$$f_1(x, y, z) = Ae^{-\frac{z}{2a}} \cos^2 \left(\frac{\pi \sqrt{x'^2 + y'^2}}{5a} \right)$$

$$f_2(x, y, z) = Ae^{-\frac{z}{a}} \frac{a^2}{a^2 + x'^2} \left(3 - e^{-\frac{2z}{a}} \right) \cos^2 \left(\frac{\pi y'}{2 \cdot 3a} \right)$$

$$f_3(x, y, z) = A \frac{a^2}{\frac{a^2}{4} + x'^2 + y'^2} \left(e^{-\frac{2z}{a}} + \frac{a^2}{2(a + 2z)^2} \right)$$

2.2 DASY5 E-Field Probe

The SAR measurement is conducted with the dosimetric probe manufactured by SPEAG.

The probe is specially designed and calibrated for use in liquid with high permittivity. The dosimetric probe has special calibration in liquid at different frequency.

SPEAG conducts the probe calibration in compliance with international and national standards (e.g. IEEE 1528, EN 62209-1, IEC 62209, etc.) under ISO 17025. The calibration data are in Appendix D.

2.2.1 Isotropic E-Field Probe Specification

Model	Ex3DV4	
Construction	Symmetrical design with triangular core Built-in shielding against static charges PEEK enclosure material (resistant to organic solvents, e.g., DGBE)	
Frequency	10 MHz to 6 GHz Linearity: ± 0.2 dB (30 MHz to 6 GHz)	
Directivity	± 0.3 dB in HSL (rotation around probe axis) ± 0.5 dB in tissue material (rotation normal to probe axis)	
Dynamic Range	10 μ W/g to 100 mW/g Linearity: ± 0.2 dB (noise: typically < 1 μ W/g)	
Dimensions	Overall length: 330 mm (Tip: 20 mm) Tip diameter: 2.5 mm (Body: 12 mm) Typical distance from probe tip to dipole centers: 1 mm	
Application	High precision dosimetric measurements in any exposure scenario (e.g., very strong gradient fields). Only probe which enables compliance testing for frequencies up to 6 GHz with precision of better 30%.	

2.3 Boundary Detection Unit and Probe Mounting Device

The DASY probes use a precise connector and an additional holder for the probe, consisting of a plastic tube and a flexible silicon ring to center the probe. The connector at the DAE is flexibly mounted and held in the default position with magnets and springs. Two switching systems in the connector mount detect frontal and lateral probe collisions and trigger the necessary software response.



2.4 DATA Acquisition Electronics (DAE) and Measurement Server

The data acquisition electronics (DAE) consists of a highly sensitive electrometer-grade preamplifier with auto-zeroing, a channel and gain-switching multiplexer, a fast 16 bit AD-converter and a command decoder and control logic unit.

Transmission to the measurement server is accomplished through an optical downlink for data and status information as well as an optical uplink for commands and the clock.

The input impedance of the DAE4 is 200M Ohm; the inputs are symmetrical and floating. Common mode rejection is above 80dB.



The DASY5 measurement server is based on a PC/104 CPU board with a 400MHz intel ULV Celeron, 128MB chipdisk and 128MB RAM. The necessary circuits for communication with the DAE electronics box, as well as the 16 bit AD converter system for optical detection and digital I/O interface are contained on the DASY5 I/O board, which is directly connected to the PC/104 bus of the CPU board.



2.5 Robot

The DASY5 system uses the high precision robots TX90 XL type out of the newer series from Stäubli SA (France). For the 6-axis controller DASY5 system, the CS8C robot controller version from Stäubli is used.

The XL robot series have many features that are important for our application:

- High precision (repeatability 0.02 mm)
- High reliability (industrial design)
- Jerk-free straight movements
- Low ELF interference (the closed metallic construction shields against motor control fields)
- 6-axis controller



2.6 Light Beam Unit

The light beam switch allows automatic "tooling" of the probe. During the process, the actual position of the probe tip with respect to the robot arm is measured, as well as the probe length and the horizontal probe offset. The software then corrects all movements, such that the robot coordinates are valid for the probe tip.

The repeatability of this process is better than 0.1 mm. If a position has been taught with an aligned probe, the same position will be reached with another aligned probe within 0.1 mm, even if the other probe has different dimensions. During probe rotations, the probe tip will keep its actual position.



2.7 Device Holder

The DASY5 device holder is designed to cope with different positions given in the standard. It has two scales for the device rotation (with respect to the body axis) and the device inclination (with respect to the line between the ear reference points). The rotation center for both scales is the ear reference point (EPR).

Thus the device needs no repositioning when changing the angles.

The DASY5 device holder has been made out of low-loss POM material having the following dielectric parameters: relative permittivity $\epsilon_r = 3$ and loss tangent $\delta = 0.02$. The amount of dielectric material has been reduced in the closest vicinity of the device, since measurements have suggested that the influence of the clamp on the test results could thus be lowered.



2.8 SAM Twin Phantom

The SAM twin phantom is a fiberglass shell phantom with 2mm shell thickness (except the ear region where shell thickness increases to 6mm). It has three measurement areas:

- Left head
- Right head
- Flat phantom



The bottom plate contains three pair of bolts for locking the device holder. The device holder positions are adjusted to the standard measurement positions in the three sections. A white cover is provided to tap the phantom during off-periods to prevent water evaporation and changes in the liquid parameters. On the phantom top, three reference markers are provided to identify the phantom position with respect to the robot.

3. Tissue Simulating Liquid

3.1 The composition of the tissue simulating liquid

INGREDIENT (% Weight)	900MHz Head	1800MHz Head	2450MHz Head	2450MHz Body
Water	--	--	--	73.2
Salt	--	--	--	0.04
Sugar	--	--	--	0.00
HEC	--	--	--	0.00
Preventol	--	--	--	0.00
DGBE	--	--	--	26.7

3.2 Tissue Calibration Result

The dielectric parameters of the liquids were verified prior to the SAR evaluation using APREL Dielectric Probe Kit and Agilent E5071C Vector Network Analyzer.

Body Tissue Simulate Measurement				
Frequency [MHz]	Description	Dielectric Parameters		Tissue Temp. [°C]
		ϵ_r	σ [s/m]	
2450 MHz	Reference result ± 5% window	52.7 50.065 to 55.335	1.95 1.8525 to 2.0475	N/A
	25-Feb-13	53.61	1.88	20.3
2412 MHz	Low channel	54.16	1.86	20.3
2437 MHz	Mid channel	53.72	1.87	20.3
2462 MHz	High channel	53.28	1.90	20.3

3.3 Tissue Dielectric Parameters for Head and Body Phantoms

The head tissue dielectric parameters recommended by the IEEE SCC-34/SC-2 in P1528 have been incorporated in the following table. These head parameters are derived from planar layer models simulating the highest expected SAR for the dielectric properties and tissue thickness variations in a human head. Other head and body tissue parameters that have not been specified in P1528 are derived from the tissue dielectric parameters computed from the 4-Cole-Cole equations described in Reference [12] and extrapolated according to the head parameters specified in P1528.

Target Frequency (MHz)	Head		Body	
	ϵ_r	σ (S/m)	ϵ_r	σ (S/m)
150	52.3	0.76	61.9	0.80
300	45.3	0.87	58.2	0.92
450	43.5	0.87	56.7	0.94
835	41.5	0.90	55.2	0.97
900	41.5	0.97	55.0	1.05
915	41.5	0.98	55.0	1.06
1450	40.5	1.20	54.0	1.30
1610	40.3	1.29	53.8	1.40
1800 – 2000	40.0	1.40	53.3	1.52
2450	39.2	1.80	52.7	1.95
3000	38.5	2.40	52.0	2.73
5800	35.3	5.27	48.2	6.00

(ϵ_r = relative permittivity, σ = conductivity and $\rho = 1000 \text{ kg/m}^3$)

4. SAR Measurement Procedure

4.1 SAR System Check

4.1.1 Dipoles

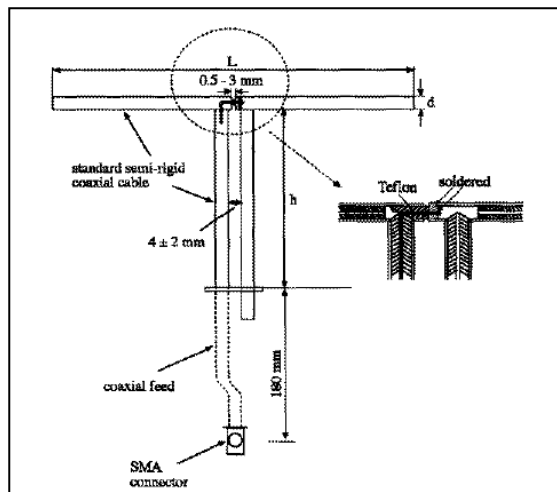

The dipoles used is based on the IEEE-1528 standard, and is complied with mechanical and electrical specifications in line with the requirements of both IEEE and FCC Supplement C. the table below provides details for the mechanical and electrical specifications for the dipoles.

Frequency	L (mm)	h (mm)	d (mm)
2450MHz	53.5	30.4	3.6

4.1.2 System Check Result

System Performance Check at 2450MHz				
Dipole Kit: ALS-D-2450				
Frequency [MHz]	Description	SAR [w/kg] 1g	SAR [w/kg] 10g	Tissue Temp. [°C]
2450 MHz	Reference result ± 10% window	54 48.6 to 59.4	24.96 22.46 to 27.46	N/A
	25-Feb-13	53.2	24.24	20.3

Note: (1) The power level is used 250mW
 (2) All SAR values are normalized to 1W forward power.
 (3) The reference result is from Appendix E.

4.2 SAR Measurement Procedure

The Dasy5 calculates SAR using the following equation,

$$SAR = \frac{\sigma |E|^2}{\rho}$$

σ : represents the simulated tissue conductivity

ρ : represents the tissue density

The EUT is set to transmit at the required power in line with product specification, at each frequency relating to the LOW, MID, and HIGH channel settings.

Pre-scans are made on the device to establish the location for the transmitting antenna, using a large area scan in either air or tissue simulation fluid.

The EUT is placed against the Universal Phantom where the maximum area scan dimensions are larger than the physical size of the resonating antenna. When the scan size is not large enough to cover the peak SAR distribution, it is modified by either extending the area scan size in both the X and Y directions, or the device is shifted within the predefined area.

The area scan is then run to establish the peak SAR location (interpolated resolution set at 1mm²) which is then used to orient the center of the zoom scan. The zoom scan is then executed and the 1g and 10g averages are derived from the zoom scan volume (interpolated resolution set at 1mm³).

5. SAR Exposure Limits

SAR assessments have been made in line with the requirements of IEEE-1528, FCC Supplement C, and comply with ANSI/IEEE C95.1-1992 “Uncontrolled Environments” limits. These limits apply to a location which is deemed as “Uncontrolled Environment” which can be described as a situation where the general public may be exposed to an RF source with no prior knowledge or control over their exposure.

Limits for General Population/Uncontrolled Exposure (W/kg)

Type Exposure	Uncontrolled Environment Limit
Spatial Peak SAR (1g cube tissue for brain or body)	1.60 W/kg
Spatial Average SAR (whole body)	0.08 W/kg
Spatial Peak SAR (10g for hands, feet, ankles and wrist)	4.00 W/kg

6. Test Equipment List

Instrument	Manufacturer	Model No.	Serial No.	Last Calibration	Next Calibration
Stäubli Robot TX60L	Stäubli	TX60L	F09/5BL1A1/A06	2009/05/18	only once
Controller	Speag	CS8c	N/A	2009/05/18	only once
Aprel Reference Dipole 2450MHz	Aprel	ALS-D-2450	QTK-319	2012/11/20	2014/11/19
SAM Twin Phantom	Speag	QD000 P40 CA	TP 1515	N/A	N/A
Device Holder	Speag	N/A	N/A	N/A	N/A
Data Acquisition Electronic	Speag	DAE4	1207	2013/05/22	2014/05/21
E-Field Probe	Speag	EGT6001DV4	3698	2013/07/31	2014/07/30
SAR Software	Speag	DASY52	V52.8 (7)	N/A	N/A
Aprel Dipole Spaccer	Aprel	ALS-DS-U	QTK-295	N/A	N/A
Power Amplifier	Mini-Circuit	ZHL-42	D051404-20	N/A	N/A
Directional Coupler	Agilent	778D-012	50550	N/A	N/A
Universal Radio Communication Tester	R&S	CMU 200	104846	2013/5/9	2014/05/08
Vector Network	Agilent	E5071C	MY46108013	2013/08/09	2014/08/08
Signal Generator	Anritsu	MG694A	041902	2013/08/05	2014/08/04
Power Meter	Anritsu	ML2487	6K00001447	2013/12/14	2014/12/13
Wide Bandwidth Sensor	Anritsu	MA2491A	034457	2013/12/14	2014/12/13

7. Measurement Uncertainty

DASY5 Uncertainty (According to IEC 62209-2/2010)								
Measurement uncertainty for 30 MHz to 6 GHz averaged over 1 gram / 10 gram.								
Error Description	Uncert. value	Prob. Dist.	Div.	(ci) 1g	(ci) 10g	Std. Unc. (1g)	Std. Unc. (10g)	(vi) V _{eff}
Measurement System								
Probe Calibration	±6.55%	N	1	1	1	±6.55%	±6.55%	∞
Axial Isotropy	±4.7%	R	$\sqrt{3}$	0.7	0.7	±1.9%	±1.9%	∞
Hemispherical Isotropy	±9.6%	R	$\sqrt{3}$	0.7	0.7	±3.9%	±3.9%	∞
Boundary Effects	±2.0%	R	$\sqrt{3}$	1	1	±1.2%	±1.2%	∞
Linearity	±4.7%	R	$\sqrt{3}$	1	1	±2.7%	±2.7%	∞
Modulation Response	±2.4%	R	$\sqrt{3}$	1	1	±1.4%	±1.4%	∞
System Detection Limits	±1.0%	R	$\sqrt{3}$	1	1	±0.6%	±0.6%	∞
Readout Electronics	±0.3%	N	1	1	1	±0.3%	±0.3%	∞
Response Time	±0.8%	R	$\sqrt{3}$	1	1	±0.5%	±0.5%	∞
Integration Time	±2.6%	R	$\sqrt{3}$	1	1	±1.5%	±1.5%	∞
RF Ambient Noise	±3.0%	R	$\sqrt{3}$	1	1	±1.7%	±1.7%	∞
RF Ambient Reflections	±3.0%	R	$\sqrt{3}$	1	1	±1.7%	±1.7%	∞
Probe Positioner	±0.8%	R	$\sqrt{3}$	1	1	±0.5%	±0.5%	∞
Probe Positioning	±6.7%	R	$\sqrt{3}$	1	1	±3.9%	±3.9%	∞
Post-processing	±4.0%	R	$\sqrt{3}$	1	1	±2.3%	±2.3%	∞
Test Sample Related								
Device Positioning	±2.9%	N	1	1	1	±2.9%	±2.9%	145
Device Holder	±3.6%	N	1	1	1	±3.6%	±3.6%	5
Power Scaling	±0%	R	$\sqrt{3}$	1	1	±0.0%	±0.0%	
Power Drift	±5.0%	R	$\sqrt{3}$	1	1	±2.9%	±2.9%	∞
Phantom and Setup								
Phantom Uncertainty	±7.9%	R	$\sqrt{3}$	1	1	±4.6%	±4.6%	∞
SAR correction	±1.9%	R	$\sqrt{3}$	1	0.84	±1.1%	±1.1%	∞
Liquid Conductivity (meas.)	±2.5%	N	1	0.78	0.71	±1.1%	±1.0%	∞
Liquid Permittivity (meas.)	±2.5%	N	1	0.26	0.26	±0.3%	±0.4%	∞
Temp. unc. - Conductivity	±3.4%	R	$\sqrt{3}$	0.78	0.71	±1.5%	±1.4%	∞
Temp. unc. - Permittivity	±0.4%	R	$\sqrt{3}$	0.23	0.26	±0.1%	±0.1%	∞
Combined Std. Uncertainty						±12.5%	±12.5%	748
Expanded STD Uncertainty						±25.1%	±25.1%	

8. Conducted Power Measurement

Test Mode	Channel No.	Frequency (MHz)	Average Power (dBm)	Peak Power (dBm)
802.11b	01	2412	11.91	15.19
	06	2437	12.17	15.41
	11	2462	14.27	17.45
802.11g	01	2412	15.61	24.15
	06	2437	16.61	24.17
	11	2462	15.92	23.82
802.11n(20M)	01	2412	16.54	24.36
	06	2437	16.54	24.18
	11	2462	16.53	24.06

9. Test Results

9.1 SAR Test Results Summary

SAR MEASUREMENT								
Ambient Temperature (°C) : 21.8 ±2				Relative Humidity (%) : 55				
Liquid Temperature (°C) : 20.3 ±2				Depth of Liquid (cm):>15				
Test Mode: 802.11b - 2450 MHz- JEM Antenna, P/N: 13H130-JV8070								
Test Position Body	Antenna Position	Frequency		Conducted Power (dBm)		SAR 1g (W/kg)		Limit (W/kg)
		Channel	MHz	Measurement	Tune-up Limit	Measurement	Tune-up Scaled	
Back	Fixed	11	2462	14.27	14.5	0.126	0.133	1.6
Test Mode: 802.11g - 2450 MHz- JEM Antenna, P/N: 13H130-JV8070								
Back	Fixed	6	2437	16.61	17	0.200	0.219	1.6
Front	Fixed	6	2437	16.61	17	0.00751	0.008	1.6
R-Side	Fixed	6	2437	16.61	17	0.00741	0.008	1.6
Botton	Fixed	6	2437	16.61	17	0.017	0.019	1.6
Test Mode: 802.11n (20M)- 2450 MHz- JEM Antenna, P/N: 13H130-JV8070								
Back	Fixed	1	2412	16.54	17	0.179	0.199	1.6
Back	Fixed	6	2437	16.54	17	0.192	0.213	1.6
Back	Fixed	11	2462	16.53	17	0.209	0.233	1.6
Note : According KDB 447498 D01, for antenna(s) located ≥ 5 cm from other side , the SAR is not required. In this device , main antenna between the Top/ Bottom side is 190mm/65mm , so SAR is not required.								

10. SAR measurement variability

- 1) Repeated measurement is not required when the original highest measured SAR is < 0.80 W/kg; steps 2) through 4) do not apply.
- 2) When the original highest measured SAR is ≥ 0.80 W/kg, repeat that measurement once.
- 3) Perform a second repeated measurement only if the ratio of largest to smallest SAR for the original and first repeated measurements is > 1.20 or when the original or repeated measurement is ≥ 1.45 W/kg (~ 10% from the 1-g SAR limit).
- 4) Perform a third repeated measurement only if the original, first or second repeated measurement is ≥ 1.5 W/kg and the ratio of largest to smallest SAR for the original, first and second repeated measurements is > 1.20.

Frequency		SAR 1g (W/kg)						
Channel	MHz	Original	First Repeated		Second Repeated		Third Repeated	
			Value	Ratio	Value	Ratio	Value	Ratio
N/A	N/A	N/A	N/A	N/A	N/A	N/A	N/A	N/A

Appendix**Appendix A. SAR System Check Data****Appendix B. SAR measurement Data****Appendix C. Test Setup Photographs & EUT Photographs****Appendix D. Probe Calibration Data****Appendix E. Dipole Calibration Data**

Appendix A. SAR System Check Data

Test Laboratory: QuieTek

Date/Time: 2/25/2014

System Performance Check_2450MHz-Body

DUT: Dipole 2450 MHz; Type: ALS-D-2450-S-2

Communication System: UID 10000, CW; Frequency: 2450 MHz; Communication System PAR: 0 dB

Medium parameters used: $f = 2450 \text{ MHz}$; $\sigma = 1.88 \text{ S/m}$; $\epsilon_r = 53.61$; $\rho = 1000 \text{ kg/m}^3$

Phantom section: Flat Section

Ambient Temperature ($^{\circ}\text{C}$) : 21.8, Liquid Temperature ($^{\circ}\text{C}$) : 20.3

Measurement Standard: DASYS (IEEE/IEC/ANSI C63.19-2007)

DASY5 Configuration:

- Probe: EX3DV4 - SN3698; ConvF(6.61, 6.61, 6.61); Calibrated: 7/31/2013;
- Sensor-Surface: 3mm (Mechanical Surface Detection)
- Electronics: DAE4 Sn1207; Calibrated: 5/22/2013
- Phantom: SAM with right table; Type: SAM;
- Measurement SW: DASYS2, Version 52.8 (5); SEMCAD X Version 14.6.10 (7164)

Configuration/2450MHz_Body/Area Scan (8x9x1): Measurement grid: $dx=12\text{mm}$, $dy=12\text{mm}$

Maximum value of SAR (measured) = 17.3 W/kg

Configuration/2450MHz_Body/Zoom Scan (7x7x7) (7x7x7)/Cube 0:

Measurement grid: $dx=5\text{mm}$, $dy=5\text{mm}$, $dz=5\text{mm}$

Reference Value = 94.410 V/m; Power Drift = 0.03 dB

Peak SAR (extrapolated) = 27.6 W/kg

SAR(1 g) = 13.3 W/kg; SAR(10 g) = 6.06 W/kg

Maximum value of SAR (measured) = 17.5 W/kg

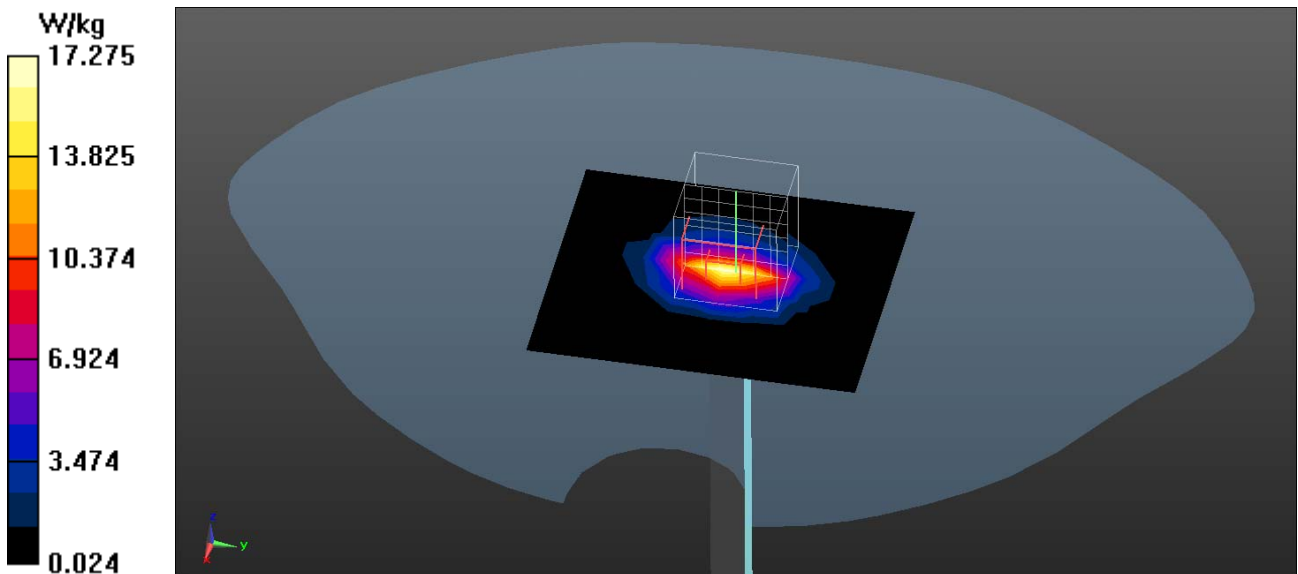

Appendix B. SAR measurement Data

Test Laboratory: QuieTek

Date/Time: 2/25/2014

802.11b_11-Back

DUT: Tablet PC; Type: TA80TAx (X=0,2~9,A~Z)

Communication System: UID 0, WLAN 2.4G; Frequency: 2462 MHz; Communication System PAR: 0 dB

Medium parameters used: $f = 2462 \text{ MHz}$; $\sigma = 1.9 \text{ S/m}$; $\epsilon_r = 53.28$; $\rho = 1000 \text{ kg/m}^3$

Phantom section: Flat Section

Ambient Temperature ($^{\circ}\text{C}$) : 21.8, Liquid Temperature ($^{\circ}\text{C}$) : 20.3

Measurement Standard: DASYS (IEEE/IEC/ANSI C63.19-2007)

DASY5 Configuration:

- Probe: EX3DV4 - SN3698; ConvF(6.61, 6.61, 6.61); Calibrated: 7/31/2013;
- Sensor-Surface: 3mm (Mechanical Surface Detection)
- Electronics: DAE4 Sn1207; Calibrated: 5/22/2013
- Phantom: SAM with right table; Type: SAM;
- Measurement SW: DASYS2, Version 52.8 (7); SEMCAD X Version 14.6.10 (7164)

Configuration/Body/Area Scan (13x6x1): Measurement grid: $dx=12\text{mm}$, $dy=12\text{mm}$
 Maximum value of SAR (measured) = 0.266 W/kg

Configuration/Body/Zoom Scan (7x7x7) (7x7x7)/Cube 0: Measurement grid:
 $dx=5\text{mm}$, $dy=5\text{mm}$, $dz=5\text{mm}$
 Reference Value = 7.861 V/m; Power Drift = -0.17 dB
 Peak SAR (extrapolated) = 0.354 W/kg
SAR(1 g) = 0.126 W/kg; SAR(10 g) = 0.055 W/kg
 Maximum value of SAR (measured) = 0.178 W/kg

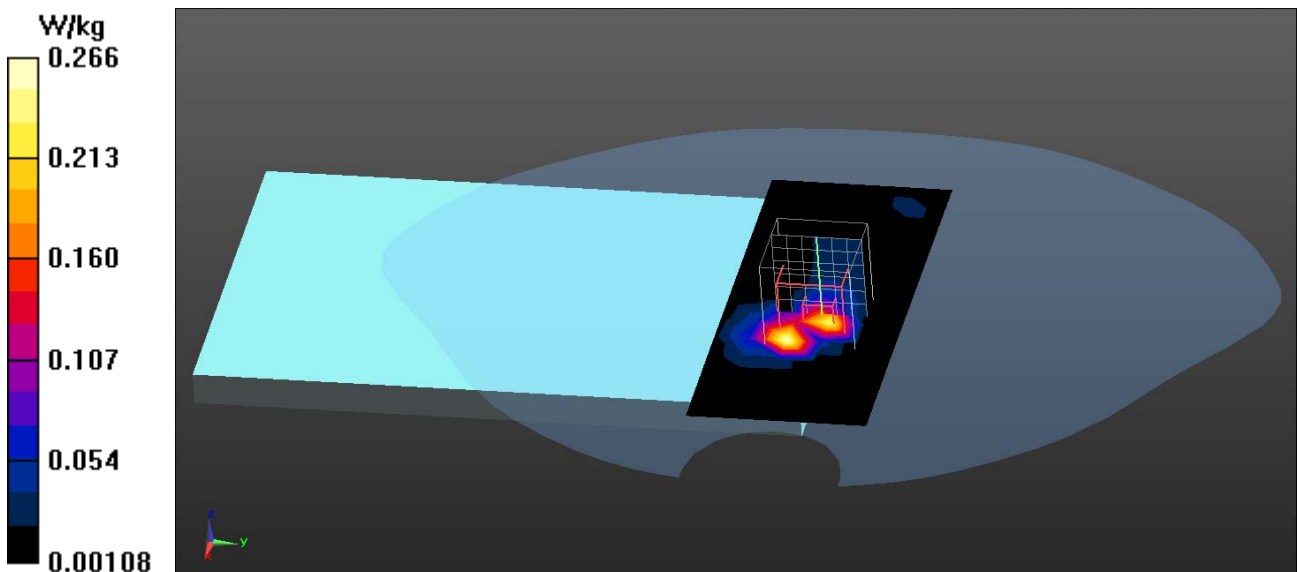

Test Laboratory: QuieTek

Date/Time: 2/25/2014

802.11g_6-Back

DUT: Tablet PC; Type: TA80TAx (X=0,2~9,A~Z)

Communication System: UID 0, WLAN 2.4G; Frequency: 2437 MHz; Communication System PAR: 0 dB

Medium parameters used: $f = 2437 \text{ MHz}$; $\sigma = 1.87 \text{ S/m}$; $\epsilon_r = 53.72$; $\rho = 1000 \text{ kg/m}^3$

Phantom section: Flat Section

Ambient Temperature ($^{\circ}\text{C}$) : 21.8, Liquid Temperature ($^{\circ}\text{C}$) : 20.3

Measurement Standard: DASY5 (IEEE/IEC/ANSI C63.19-2007)

DASY5 Configuration:

- Probe: EX3DV4 - SN3698; ConvF(6.61, 6.61, 6.61); Calibrated: 7/31/2013;
- Sensor-Surface: 3mm (Mechanical Surface Detection)
- Electronics: DAE4 Sn1207; Calibrated: 5/22/2013
- Phantom: SAM with right table; Type: SAM;
- Measurement SW: DASY52, Version 52.8 (7); SEMCAD X Version 14.6.10 (7164)

Configuration/Body/Area Scan (13x6x1): Measurement grid: $dx=12\text{mm}$, $dy=12\text{mm}$
 Maximum value of SAR (measured) = 0.199 W/kg

Configuration/Body/Zoom Scan (7x7x7) (7x7x7)/Cube 0: Measurement grid: $dx=5\text{mm}$, $dy=5\text{mm}$, $dz=5\text{mm}$

Reference Value = 7.614 V/m; Power Drift = -0.15 dB

Peak SAR (extrapolated) = 0.655 W/kg

SAR(1 g) = 0.200 W/kg; SAR(10 g) = 0.072 W/kg

Maximum value of SAR (measured) = 0.269 W/kg

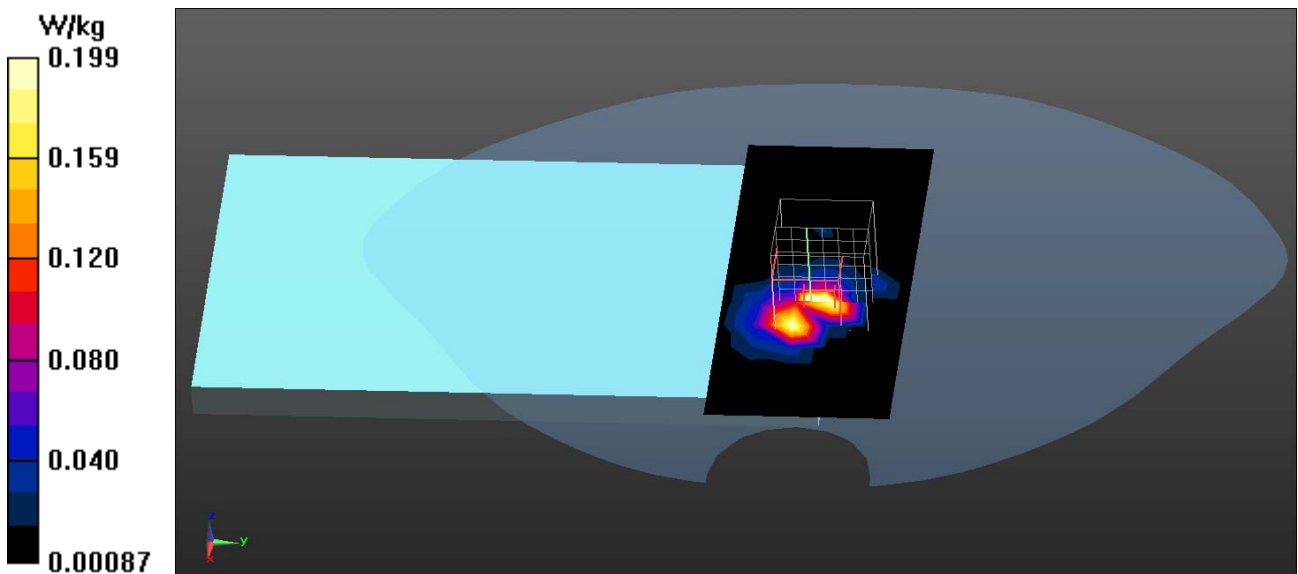

Test Laboratory: QuieTek

Date/Time: 2/25/2014

802.11g_6-Front

DUT: Tablet PC; Type: TA80TAx (X=0,2~9,A~Z)

Communication System: UID 0, WLAN 2.4G; Frequency: 2437 MHz; Communication System PAR: 0 dB

Medium parameters used: $f = 2437 \text{ MHz}$; $\sigma = 1.87 \text{ S/m}$; $\epsilon_r = 53.72$; $\rho = 1000 \text{ kg/m}^3$

Phantom section: Flat Section

Ambient Temperature ($^{\circ}\text{C}$) : 21.8, Liquid Temperature ($^{\circ}\text{C}$) : 20.3

Measurement Standard: DASYS (IEEE/IEC/ANSI C63.19-2007)

DASY5 Configuration:

- Probe: EX3DV4 - SN3698; ConvF(6.61, 6.61, 6.61); Calibrated: 7/31/2013;
- Sensor-Surface: 3mm (Mechanical Surface Detection)
- Electronics: DAE4 Sn1207; Calibrated: 5/22/2013
- Phantom: SAM with right table; Type: SAM;
- Measurement SW: DASYS2, Version 52.8 (7); SEMCAD X Version 14.6.10 (7164)

Configuration/Body/Area Scan (13x6x1): Measurement grid: $dx=12\text{mm}$, $dy=12\text{mm}$
 Maximum value of SAR (measured) = 0.0183 W/kg

Configuration/Body/Zoom Scan (7x7x7) (7x7x7)/Cube 0: Measurement grid: $dx=5\text{mm}$, $dy=5\text{mm}$, $dz=5\text{mm}$

Reference Value = 1.112 V/m; Power Drift = 0.19 dB

Peak SAR (extrapolated) = 0.0380 W/kg

SAR(1 g) = 0.00751 W/kg; SAR(10 g) = 0.00316 W/kg

Maximum value of SAR (measured) = 0.0329 W/kg

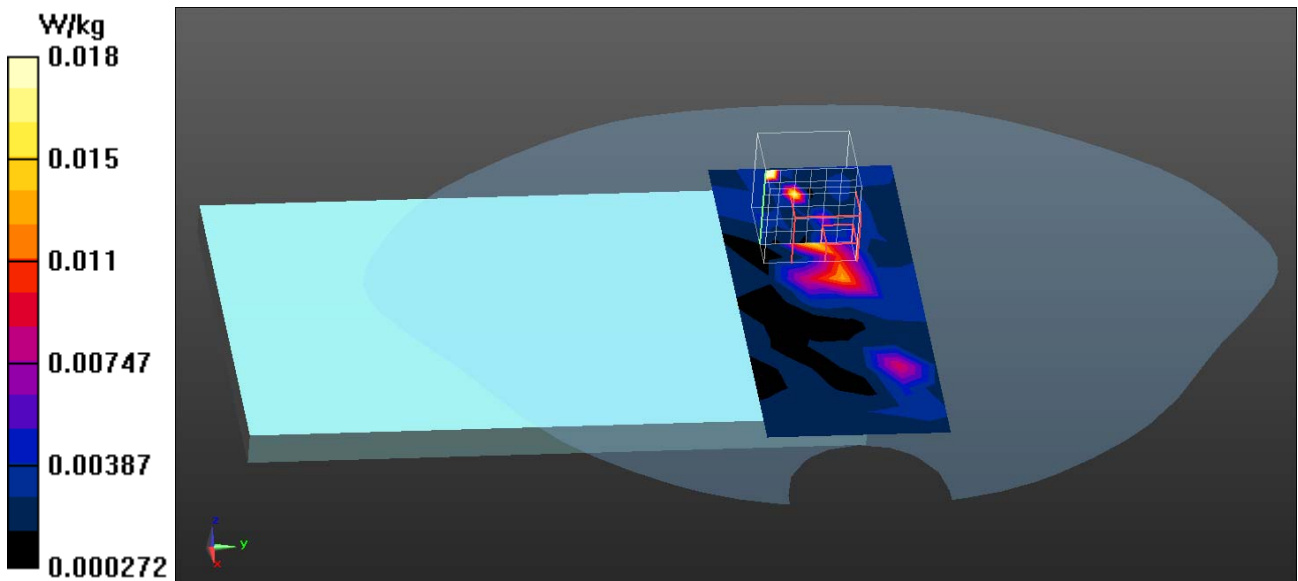

Test Laboratory: QuieTek

Date/Time: 2/25/2014

802.11g_6-Right-Side

DUT: Tablet PC; Type: TA80TAx (X=0,2~9,A~Z)

Communication System: UID 0, WLAN 2.4G; Frequency: 2437 MHz; Communication System PAR: 0 dB

Medium parameters used: $f = 2437$ MHz; $\sigma = 1.87$ S/m; $\epsilon_r = 53.72$; $\rho = 1000$ kg/m³

Phantom section: Flat Section

Ambient Temperature (°C) : 21.8, Liquid Temperature (°C) : 20.3

Measurement Standard: DASY5 (IEEE/IEC/ANSI C63.19-2007)

DASY5 Configuration:

- Probe: EX3DV4 - SN3698; ConvF(6.61, 6.61, 6.61); Calibrated: 7/31/2013;
- Sensor-Surface: 3mm (Mechanical Surface Detection)
- Electronics: DAE4 Sn1207; Calibrated: 5/22/2013
- Phantom: SAM with right table; Type: SAM;
- Measurement SW: DASY52, Version 52.8 (7); SEMCAD X Version 14.6.10 (7164)

Configuration/Body/Area Scan (6x13x1): Measurement grid: dx=12mm, dy=12mm
 Maximum value of SAR (measured) = 0.00923 W/kg

Configuration/Body/Zoom Scan (7x7x7) (7x7x7)/Cube 0: Measurement grid: dx=5mm, dy=5mm, dz=5mm

Reference Value = 2.213 V/m; Power Drift = -0.17 dB

Peak SAR (extrapolated) = 0.0220 W/kg

SAR(1 g) = 0.00741 W/kg; SAR(10 g) = 0.00322 W/kg

Maximum value of SAR (measured) = 0.0130 W/kg

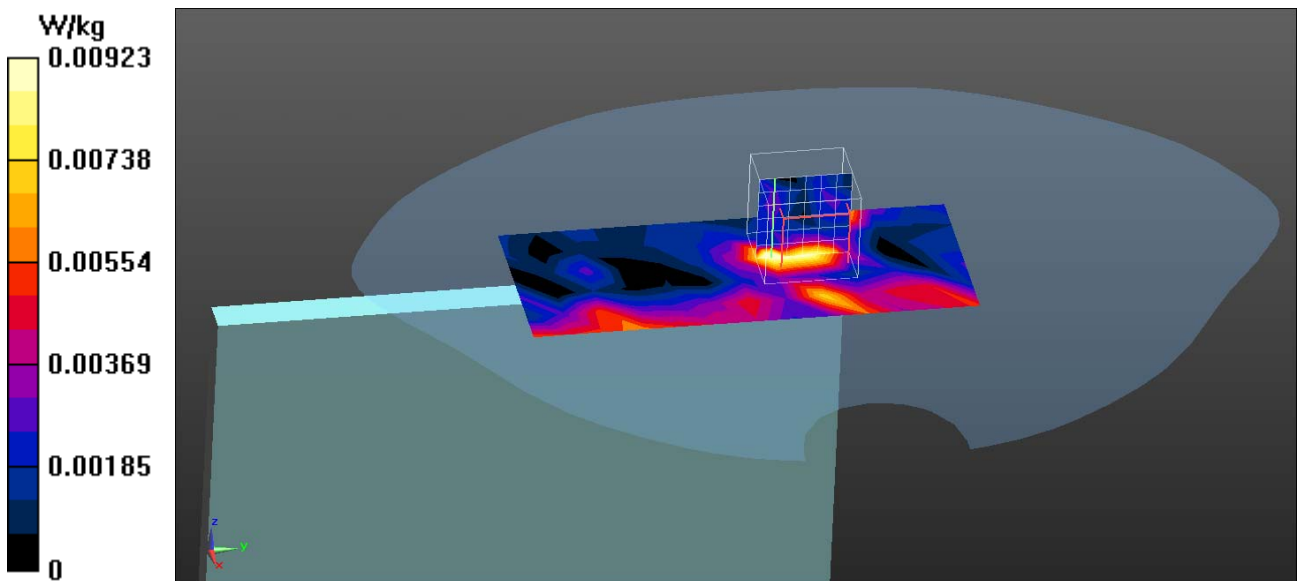

Test Laboratory: QuieTek

Date/Time: 2/25/2014

802.11g_6-Bottom

DUT: Tablet PC; Type: TA80TAx (X=0,2~9,A~Z)

Communication System: UID 0, WLAN 2.4G; Frequency: 2437 MHz; Communication System PAR: 0 dB

Medium parameters used: $f = 2437 \text{ MHz}$; $\sigma = 1.87 \text{ S/m}$; $\epsilon_r = 53.72$; $\rho = 1000 \text{ kg/m}^3$

Phantom section: Flat Section

Ambient Temperature ($^{\circ}\text{C}$) : 21.8, Liquid Temperature ($^{\circ}\text{C}$) : 20.3

Measurement Standard: DASYS (IEEE/IEC/ANSI C63.19-2007)

DASY5 Configuration:

- Probe: EX3DV4 - SN3698; ConvF(6.61, 6.61, 6.61); Calibrated: 7/31/2013;
- Sensor-Surface: 3mm (Mechanical Surface Detection)
- Electronics: DAE4 Sn1207; Calibrated: 5/22/2013
- Phantom: SAM with right table; Type: SAM;
- Measurement SW: DASYS2, Version 52.8 (7); SEMCAD X Version 14.6.10 (7164)

Configuration/Body/Area Scan (6x13x1): Measurement grid: $dx=12\text{mm}$, $dy=12\text{mm}$
 Maximum value of SAR (measured) = 0.0223 W/kg

Configuration/Body/Zoom Scan (7x7x7) (7x7x7)/Cube 0: Measurement grid:
 $dx=5\text{mm}$, $dy=5\text{mm}$, $dz=5\text{mm}$

Reference Value = 1.741 V/m; Power Drift = -0.06 dB

Peak SAR (extrapolated) = 0.0580 W/kg

SAR(1 g) = 0.017 W/kg; SAR(10 g) = 0.00507 W/kg

Maximum value of SAR (measured) = 0.0239 W/kg

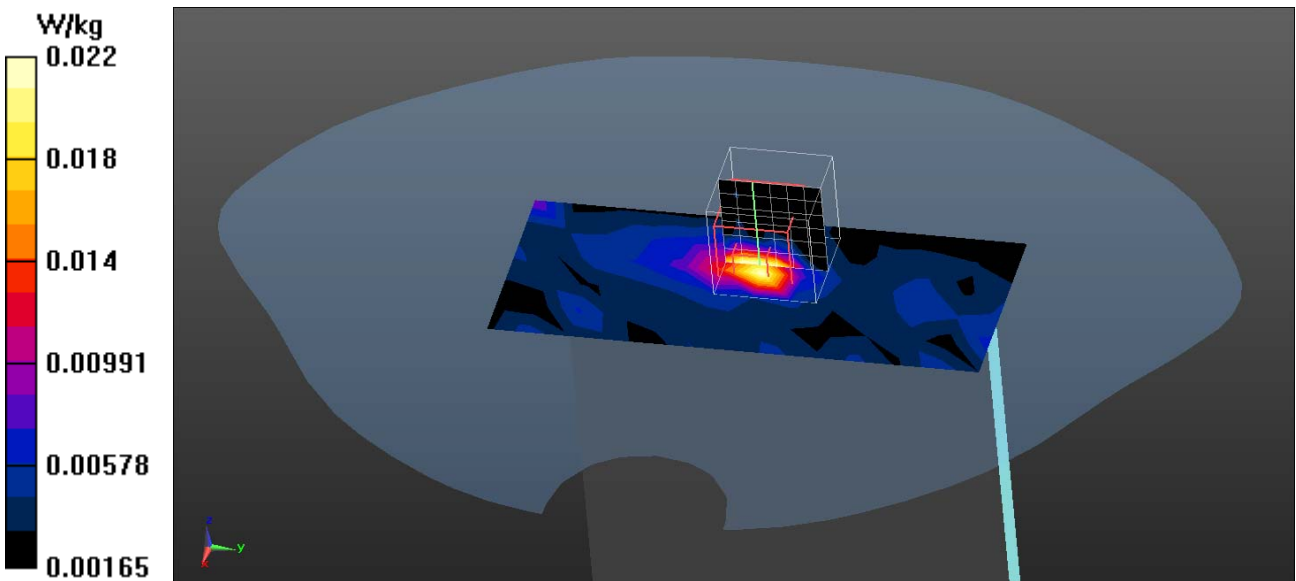

Test Laboratory: QuieTek

Date/Time: 2/25/2014

802.11n_1-Back

DUT: Tablet PC; Type: TA80TAx (X=0,2~9,A~Z)

Communication System: UID 0, WLAN 2.4G; Frequency: 2412 MHz; Communication System PAR: 0 dB

Medium parameters used: $f = 2412 \text{ MHz}$; $\sigma = 1.86 \text{ S/m}$; $\epsilon_r = 54.16$; $\rho = 1000 \text{ kg/m}^3$

Phantom section: Flat Section

Ambient Temperature ($^{\circ}\text{C}$) : 21.8, Liquid Temperature ($^{\circ}\text{C}$) : 20.3

Measurement Standard: DASYS (IEEE/IEC/ANSI C63.19-2007)

DASY5 Configuration:

- Probe: EX3DV4 - SN3698; ConvF(6.61, 6.61, 6.61); Calibrated: 7/31/2013;
- Sensor-Surface: 3mm (Mechanical Surface Detection)
- Electronics: DAE4 Sn1207; Calibrated: 5/22/2013
- Phantom: SAM with right table; Type: SAM;
- Measurement SW: DASYS2, Version 52.8 (7); SEMCAD X Version 14.6.10 (7164)

Configuration/Body/Area Scan (13x6x1): Measurement grid: $dx=12\text{mm}$, $dy=12\text{mm}$
 Maximum value of SAR (measured) = 0.214 W/kg

Configuration/Body/Zoom Scan (7x7x7) (7x7x7)/Cube 0: Measurement grid: $dx=5\text{mm}$, $dy=5\text{mm}$, $dz=5\text{mm}$

Reference Value = 6.631 V/m; Power Drift = -0.17 dB

Peak SAR (extrapolated) = 0.598 W/kg

SAR(1 g) = 0.179 W/kg; SAR(10 g) = 0.071 W/kg

Maximum value of SAR (measured) = 0.266 W/kg

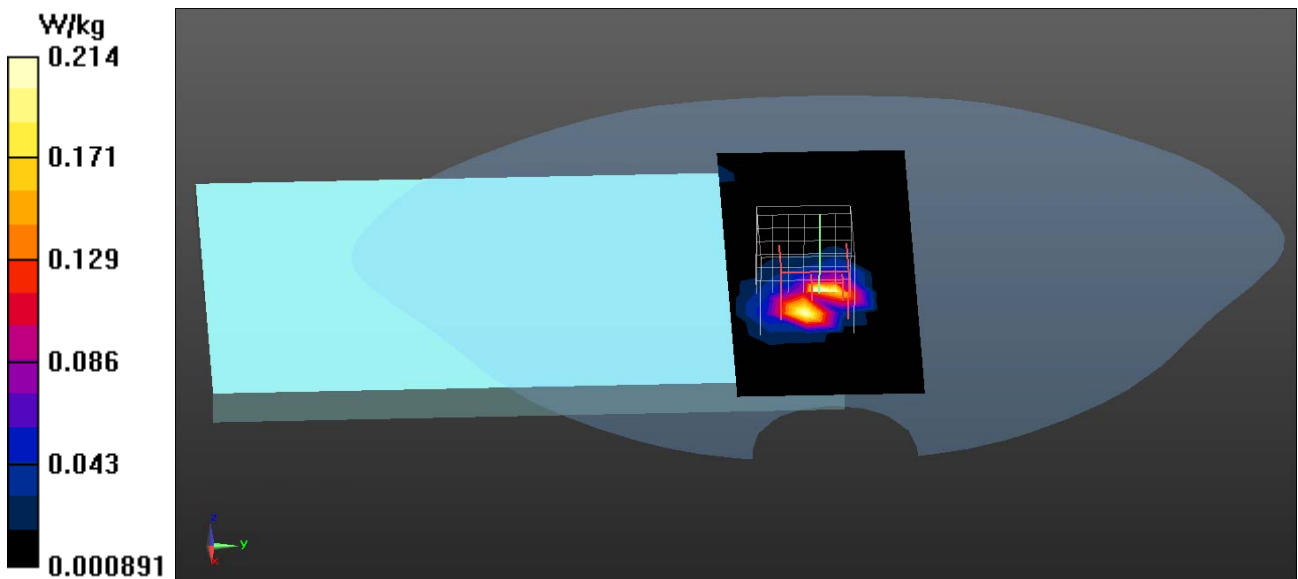

Test Laboratory: QuieTek

Date/Time: 2/25/2014

802.11n_6-Back

DUT: Tablet PC; Type: TA80TAx (X=0,2~9,A~Z)

Communication System: UID 0, WLAN 2.4G; Frequency: 2437 MHz; Communication System PAR: 0 dB

Medium parameters used: $f = 2437 \text{ MHz}$; $\sigma = 1.87 \text{ S/m}$; $\epsilon_r = 53.72$; $\rho = 1000 \text{ kg/m}^3$

Phantom section: Flat Section

Ambient Temperature ($^{\circ}\text{C}$) : 21.8, Liquid Temperature ($^{\circ}\text{C}$) : 20.3

Measurement Standard: DASY5 (IEEE/IEC/ANSI C63.19-2007)

DASY5 Configuration:

- Probe: EX3DV4 - SN3698; ConvF(6.61, 6.61, 6.61); Calibrated: 7/31/2013;
- Sensor-Surface: 3mm (Mechanical Surface Detection)
- Electronics: DAE4 Sn1207; Calibrated: 5/22/2013
- Phantom: SAM with right table; Type: SAM;
- Measurement SW: DASY52, Version 52.8 (7); SEMCAD X Version 14.6.10 (7164)

Configuration/Body/Area Scan (13x6x1): Measurement grid: $dx=12\text{mm}$, $dy=12\text{mm}$
 Maximum value of SAR (measured) = 0.215 W/kg

Configuration/Body/Zoom Scan (7x7x7) (7x7x7)/Cube 0: Measurement grid:
 $dx=5\text{mm}$, $dy=5\text{mm}$, $dz=5\text{mm}$

Reference Value = 6.732 V/m; Power Drift = -0.13 dB

Peak SAR (extrapolated) = 0.580 W/kg

SAR(1 g) = 0.192 W/kg; SAR(10 g) = 0.073 W/kg

Maximum value of SAR (measured) = 0.276 W/kg

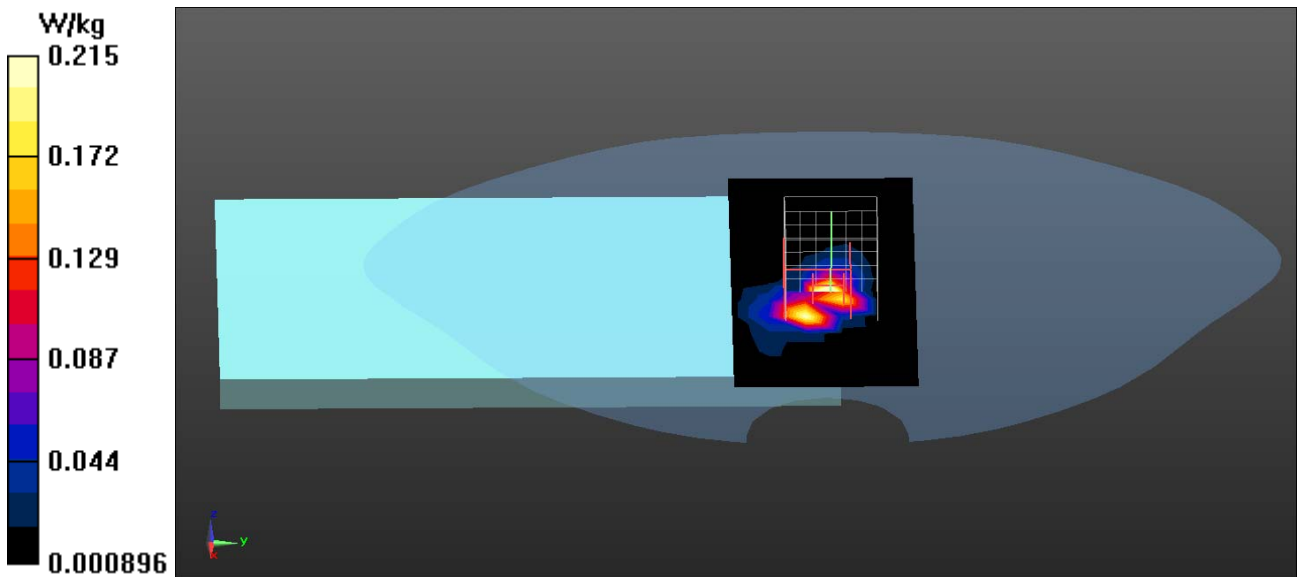

Test Laboratory: QuieTek

Date/Time: 2/25/2014

802.11n_11-Back

DUT: Tablet PC; Type: TA80TAx (X=0,2~9,A~Z)

Communication System: UID 0, WLAN 2.4G; Frequency: 2462 MHz; Communication System PAR: 0 dB

Medium parameters used: $f = 2462 \text{ MHz}$; $\sigma = 1.9 \text{ S/m}$; $\epsilon_r = 53.28$; $\rho = 1000 \text{ kg/m}^3$

Phantom section: Flat Section

Ambient Temperature ($^{\circ}\text{C}$) : 21.8, Liquid Temperature ($^{\circ}\text{C}$) : 20.3

Measurement Standard: DASYS (IEEE/IEC/ANSI C63.19-2007)

DASY5 Configuration:

- Probe: EX3DV4 - SN3698; ConvF(6.61, 6.61, 6.61); Calibrated: 7/31/2013;
- Sensor-Surface: 3mm (Mechanical Surface Detection)
- Electronics: DAE4 Sn1207; Calibrated: 5/22/2013
- Phantom: SAM with right table; Type: SAM;
- Measurement SW: DASYS2, Version 52.8 (7); SEMCAD X Version 14.6.10 (7164)

Configuration/Body/Area Scan (13x6x1): Measurement grid: $dx=12\text{mm}$, $dy=12\text{mm}$
 Maximum value of SAR (measured) = 0.239 W/kg

Configuration/Body/Zoom Scan (7x7x7) (7x7x7)/Cube 0: Measurement grid:
 $dx=5\text{mm}$, $dy=5\text{mm}$, $dz=5\text{mm}$

Reference Value = 8.041 V/m; Power Drift = -0.18 dB

Peak SAR (extrapolated) = 0.677 W/kg

SAR(1 g) = 0.209 W/kg; SAR(10 g) = 0.080 W/kg

Maximum value of SAR (measured) = 0.344 W/kg

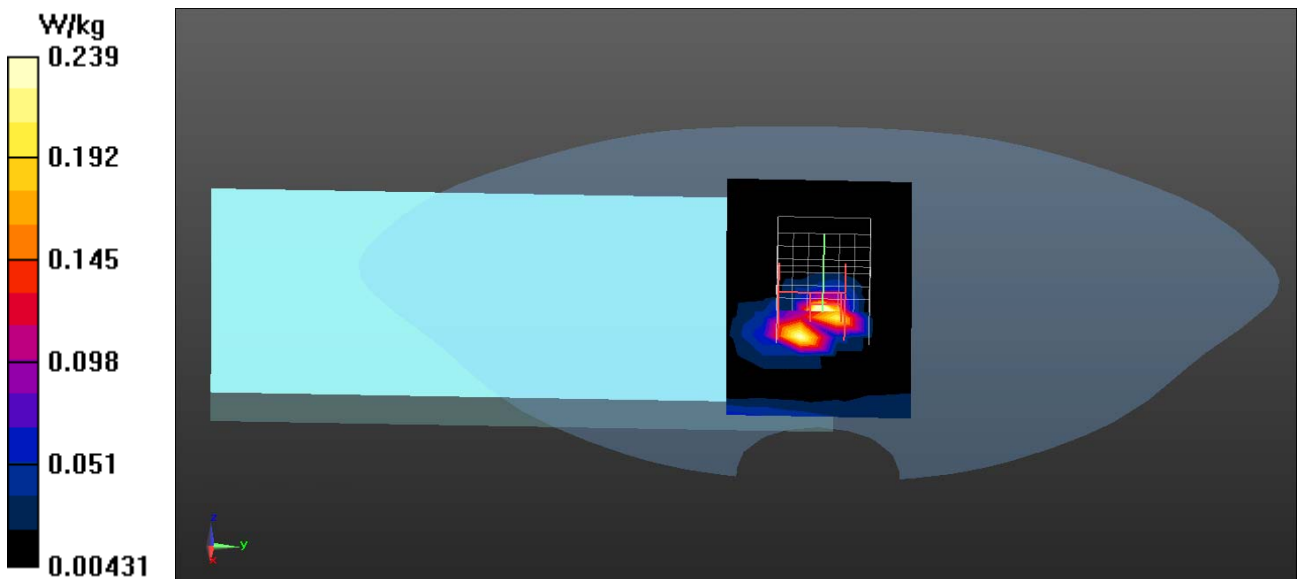

802.11n EUT Back Z-Axis plot

Channel: 11

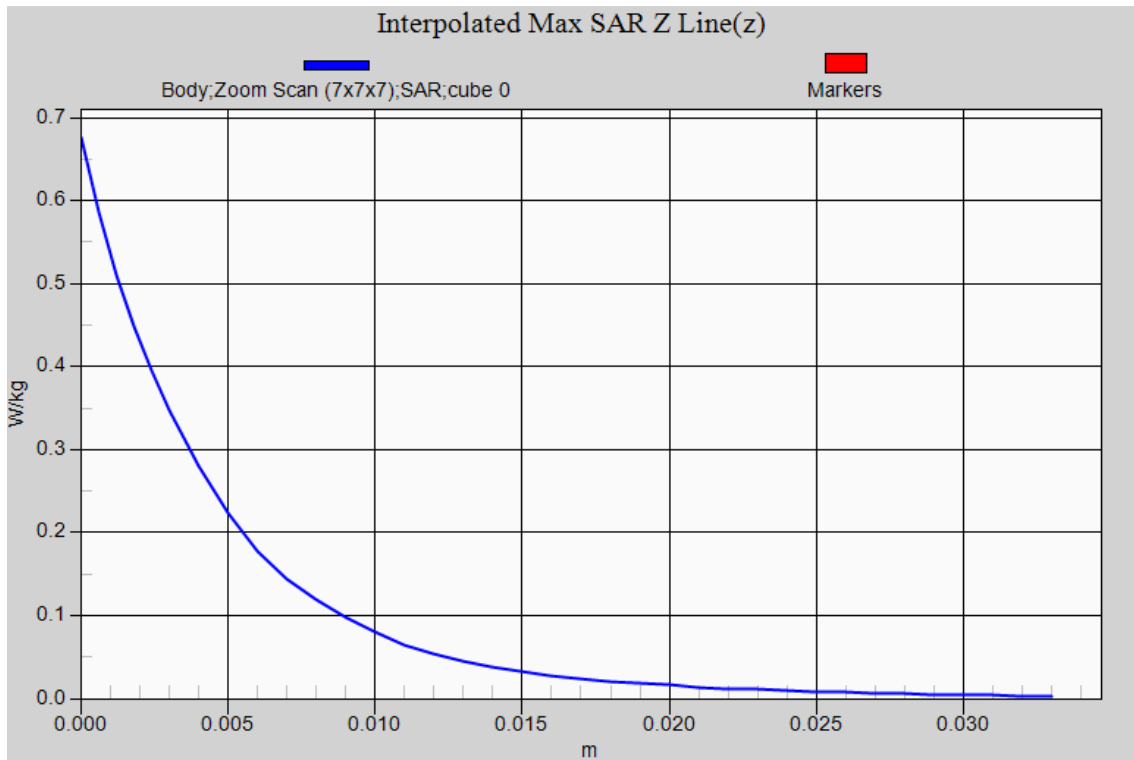



Appendix D. Probe Calibration Data

Object: EX3DV4- SN: 3698

**Calibration Laboratory of
Schmid & Partner
Engineering AG**
Zeughausstrasse 43, 8004 Zurich, Switzerland



S Schweizerischer Kalibrierdienst
S Service suisse d'étalonnage
S Servizio svizzero di taratura
S Swiss Calibration Service

Accredited by the Swiss Accreditation Service (SAS)
The Swiss Accreditation Service is one of the signatories to the EA
Multilateral Agreement for the recognition of calibration certificates

Accreditation No.: **SCS 108**

Client **Quietek-TW (Auden)**

Certificate No: **EX3-3698_Jul13**

CALIBRATION CERTIFICATE

Object **EX3DV4 - SN:3698**

Calibration procedure(s) **QA CAL-01.v8, QA CAL-14.v3, QA CAL-23.v4, QA CAL-25.v4
Calibration procedure for dosimetric E-field probes**

Calibration date: **July 31, 2013**

This calibration certificate documents the traceability to national standards, which realize the physical units of measurements (SI).
The measurements and the uncertainties with confidence probability are given on the following pages and are part of the certificate.

All calibrations have been conducted in the closed laboratory facility: environment temperature (22 ± 3)°C and humidity < 70%.

Calibration Equipment used (M&TE critical for calibration)

Primary Standards	ID	Cal Date (Certificate No.)	Scheduled Calibration
Power meter E4419B	GB41293874	04-Apr-13 (No. 217-01733)	Apr-14
Power sensor E4412A	MY41498087	04-Apr-13 (No. 217-01733)	Apr-14
Reference 3 dB Attenuator	SN: S5054 (3c)	04-Apr-13 (No. 217-01737)	Apr-14
Reference 20 dB Attenuator	SN: S5277 (20x)	04-Apr-13 (No. 217-01735)	Apr-14
Reference 30 dB Attenuator	SN: S5129 (30b)	04-Apr-13 (No. 217-01738)	Apr-14
Reference Probe ES3DV2	SN: 3013	28-Dec-12 (No. ES3-3013_Dec12)	Dec-13
DAE4	SN: 660	31-Jan-13 (No. DAE4-660_Jan13)	Jan-14
Secondary Standards	ID	Check Date (in house)	Scheduled Check
RF generator HP 8648C	US3642U01700	4-Aug-99 (in house check Apr-13)	In house check: Apr-15
Network Analyzer HP 8753E	US37390585	18-Oct-01 (in house check Oct-12)	In house check: Oct-13

Calibrated by:	Name Claudio Leubler	Function Laboratory Technician	Signature
Approved by:	Name Katja Pokovic	Function Technical Manager	Signature

Issued: July 31, 2013

This calibration certificate shall not be reproduced except in full without written approval of the laboratory.



Accredited by the Swiss Accreditation Service (SAS)
The Swiss Accreditation Service is one of the signatories to the EA
Multilateral Agreement for the recognition of calibration certificates

Accreditation No.: **SCS 108**

Glossary:

TSL	tissue simulating liquid
NORM _{x,y,z}	sensitivity in free space
ConvF	sensitivity in TSL / NORM _{x,y,z}
DCP	diode compression point
CF	crest factor (1/duty_cycle) of the RF signal
A, B, C, D	modulation dependent linearization parameters
Polarization φ	φ rotation around probe axis
Polarization θ	θ rotation around an axis that is in the plane normal to probe axis (at measurement center), i.e., θ = 0 is normal to probe axis

Calibration is Performed According to the Following Standards:

- a) IEEE Std 1528-2003, "IEEE Recommended Practice for Determining the Peak Spatial-Averaged Specific Absorption Rate (SAR) in the Human Head from Wireless Communications Devices: Measurement Techniques", December 2003
- b) IEC 62209-1, "Procedure to measure the Specific Absorption Rate (SAR) for hand-held devices used in close proximity to the ear (frequency range of 300 MHz to 3 GHz)", February 2005

Methods Applied and Interpretation of Parameters:

- *NORM_{x,y,z}*: Assessed for E-field polarization θ = 0 (f ≤ 900 MHz in TEM-cell; f > 1800 MHz: R22 waveguide). *NORM_{x,y,z}* are only intermediate values, i.e., the uncertainties of *NORM_{x,y,z}* does not affect the E²-field uncertainty inside TSL (see below *ConvF*).
- *NORM(f)_{x,y,z}* = *NORM_{x,y,z}* * *frequency_response* (see Frequency Response Chart). This linearization is implemented in DASY4 software versions later than 4.2. The uncertainty of the frequency response is included in the stated uncertainty of *ConvF*.
- *DCP_{x,y,z}*: DCP are numerical linearization parameters assessed based on the data of power sweep with CW signal (no uncertainty required). DCP does not depend on frequency nor media.
- *PAR*: PAR is the Peak to Average Ratio that is not calibrated but determined based on the signal characteristics
- *A_{x,y,z}; B_{x,y,z}; C_{x,y,z}; D_{x,y,z}; VR_{x,y,z}; A, B, C, D* are numerical linearization parameters assessed based on the data of power sweep for specific modulation signal. The parameters do not depend on frequency nor media. *VR* is the maximum calibration range expressed in RMS voltage across the diode.
- *ConvF and Boundary Effect Parameters*: Assessed in flat phantom using E-field (or Temperature Transfer Standard for f ≤ 800 MHz) and inside waveguide using analytical field distributions based on power measurements for f > 800 MHz. The same setups are used for assessment of the parameters applied for boundary compensation (alpha, depth) of which typical uncertainty values are given. These parameters are used in DASY4 software to improve probe accuracy close to the boundary. The sensitivity in TSL corresponds to *NORM_{x,y,z}* * *ConvF* whereby the uncertainty corresponds to that given for *ConvF*. A frequency dependent *ConvF* is used in DASY version 4.4 and higher which allows extending the validity from ± 50 MHz to ± 100 MHz.
- *Spherical isotropy (3D deviation from isotropy)*: in a field of low gradients realized using a flat phantom exposed by a patch antenna.
- *Sensor Offset*: The sensor offset corresponds to the offset of virtual measurement center from the probe tip (on probe axis). No tolerance required.

Probe EX3DV4

SN:3698

Manufactured: April 22, 2009
Calibrated: July 31, 2013

Calibrated for DASY/EASY Systems
(Note: non-compatible with DASY2 system!)

DASY/EASY - Parameters of Probe: EX3DV4 - SN:3698

Basic Calibration Parameters

	Sensor X	Sensor Y	Sensor Z	Unc (k=2)
Norm ($\mu\text{V}/(\text{V}/\text{m})^2$) ^A	0.41	0.35	0.36	$\pm 10.1 \%$
DCP (mV) ^B	100.4	101.3	97.5	

Modulation Calibration Parameters

UID	Communication System Name		A dB	B dB $\sqrt{\mu\text{V}}$	C	D dB	VR mV	Unc ^E (k=2)
0	CW	X	0.0	0.0	1.0	0.00	138.1	$\pm 3.0 \%$
		Y	0.0	0.0	1.0		131.7	
		Z	0.0	0.0	1.0		127.6	

The reported uncertainty of measurement is stated as the standard uncertainty of measurement multiplied by the coverage factor k=2, which for a normal distribution corresponds to a coverage probability of approximately 95%.

^A The uncertainties of NormX,Y,Z do not affect the E²-field uncertainty inside TSL (see Pages 5 and 6).

^B Numerical linearization parameter: uncertainty not required.

^E Uncertainty is determined using the max. deviation from linear response applying rectangular distribution and is expressed for the square of the field value.

DASY/EASY - Parameters of Probe: EX3DV4 - SN:3698

Calibration Parameter Determined in Head Tissue Simulating Media

f (MHz) ^C	Relative Permittivity ^F	Conductivity (S/m) ^F	ConvF X	ConvF Y	ConvF Z	Alpha	Depth (mm)	Unct. (k=2)
750	41.9	0.89	9.49	9.49	9.49	0.80	0.50	± 12.0 %
835	41.5	0.90	9.05	9.05	9.05	0.80	0.50	± 12.0 %
900	41.5	0.97	8.67	8.67	8.67	0.80	0.50	± 12.0 %
1750	40.1	1.37	7.61	7.61	7.61	0.48	0.73	± 12.0 %
1900	40.0	1.40	7.34	7.34	7.34	0.44	0.77	± 12.0 %
2450	39.2	1.80	6.54	6.54	6.54	0.27	1.01	± 12.0 %
2600	39.0	1.96	6.46	6.46	6.46	0.29	0.99	± 12.0 %
3500	37.9	2.91	6.03	6.03	6.03	0.25	3.61	± 13.1 %
5200	36.0	4.66	4.81	4.81	4.81	0.35	1.80	± 13.1 %
5300	35.9	4.76	4.63	4.63	4.63	0.36	1.80	± 13.1 %
5500	35.6	4.96	4.53	4.53	4.53	0.41	1.80	± 13.1 %
5600	35.5	5.07	4.04	4.04	4.04	0.59	1.80	± 13.1 %
5800	35.3	5.27	4.34	4.34	4.34	0.45	1.80	± 13.1 %

^C Frequency validity of ± 100 MHz only applies for DASY v4.4 and higher (see Page 2), else it is restricted to ± 50 MHz. The uncertainty is the RSS of the ConvF uncertainty at calibration frequency and the uncertainty for the indicated frequency band.

^F At frequencies below 3 GHz, the validity of tissue parameters (ϵ and σ) can be relaxed to ± 10% if liquid compensation formula is applied to measured SAR values. At frequencies above 3 GHz, the validity of tissue parameters (ϵ and σ) is restricted to ± 5%. The uncertainty is the RSS of the ConvF uncertainty for indicated target tissue parameters.

DASY/EASY - Parameters of Probe: EX3DV4 - SN:3698

Calibration Parameter Determined in Body Tissue Simulating Media

f (MHz) ^C	Relative Permittivity ^F	Conductivity (S/m) ^F	ConvF X	ConvF Y	ConvF Z	Alpha	Depth (mm)	Unct. (k=2)
750	55.5	0.96	9.08	9.08	9.08	0.80	0.50	± 12.0 %
835	55.2	0.97	8.89	8.89	8.89	0.80	0.50	± 12.0 %
900	55.0	1.05	8.69	8.69	8.69	0.80	0.50	± 12.0 %
1750	53.4	1.49	7.39	7.39	7.39	0.35	0.94	± 12.0 %
1900	53.3	1.52	7.06	7.06	7.06	0.43	0.90	± 12.0 %
2450	52.7	1.95	6.61	6.61	6.61	0.74	0.64	± 12.0 %
2600	52.5	2.16	6.41	6.41	6.41	0.78	0.62	± 12.0 %
3500	51.3	3.31	5.76	5.76	5.76	0.21	2.85	± 13.1 %
5200	49.0	5.30	4.33	4.33	4.33	0.45	1.90	± 13.1 %
5300	48.9	5.42	4.12	4.12	4.12	0.48	1.90	± 13.1 %
5500	48.6	5.65	3.82	3.82	3.82	0.50	1.90	± 13.1 %
5600	48.5	5.77	3.39	3.39	3.39	0.67	1.90	± 13.1 %
5800	48.2	6.00	4.01	4.01	4.01	0.51	1.90	± 13.1 %

^C Frequency validity of ± 100 MHz only applies for DASY v4.4 and higher (see Page 2), else it is restricted to ± 50 MHz. The uncertainty is the RSS of the ConvF uncertainty at calibration frequency and the uncertainty for the indicated frequency band.

^F At frequencies below 3 GHz, the validity of tissue parameters (ϵ and σ) can be relaxed to ± 10% if liquid compensation formula is applied to measured SAR values. At frequencies above 3 GHz, the validity of tissue parameters (ϵ and σ) is restricted to ± 5%. The uncertainty is the RSS of the ConvF uncertainty for indicated target tissue parameters.

Frequency Response of E-Field (TEM-Cell:ifi110 EXX, Waveguide: R22)

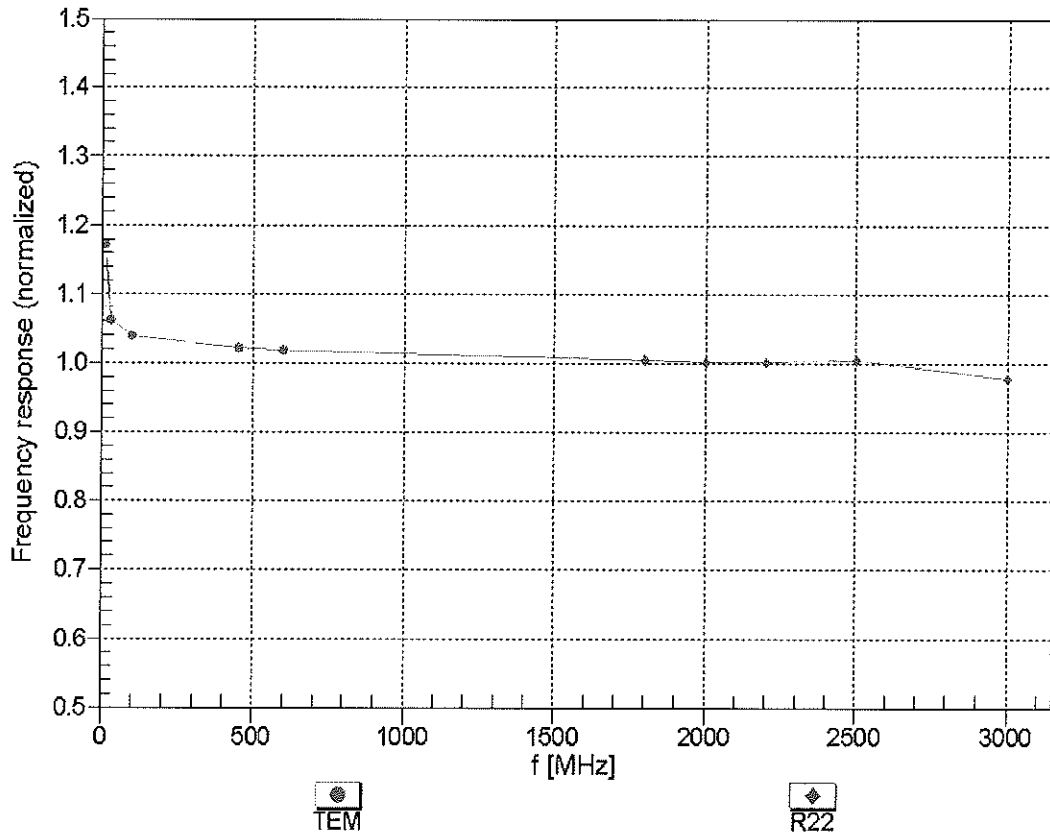

Uncertainty of Frequency Response of E-field: $\pm 6.3\%$ (k=2)

Receiving Pattern (ϕ), $\theta = 0^\circ$

f=600 MHz,TEM

f=1800 MHz,R22

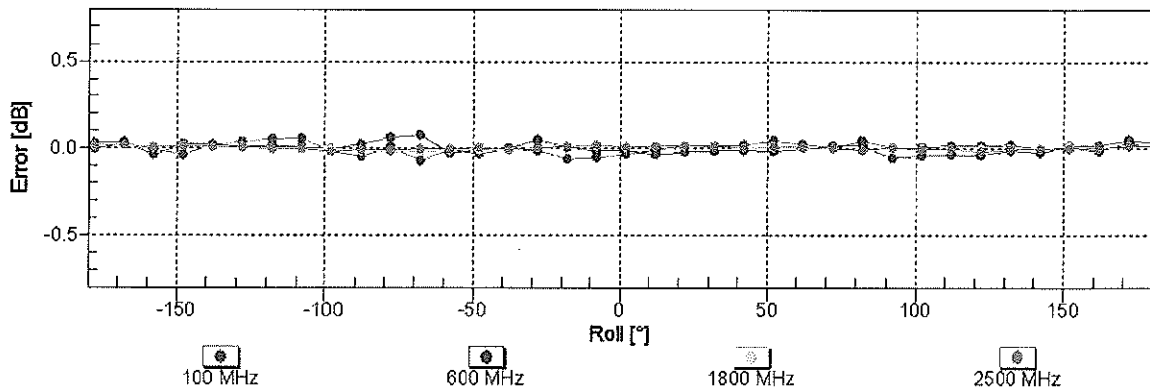
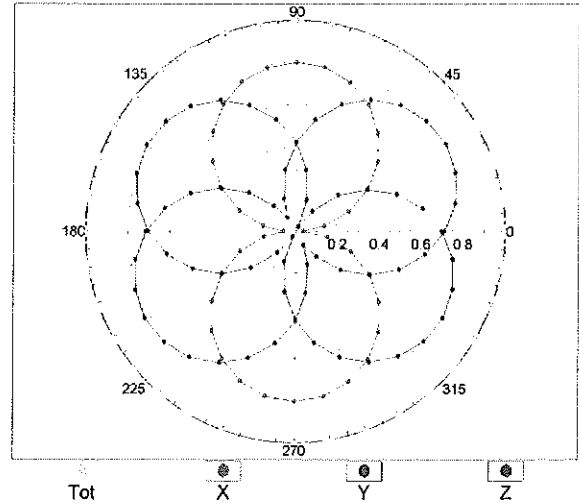
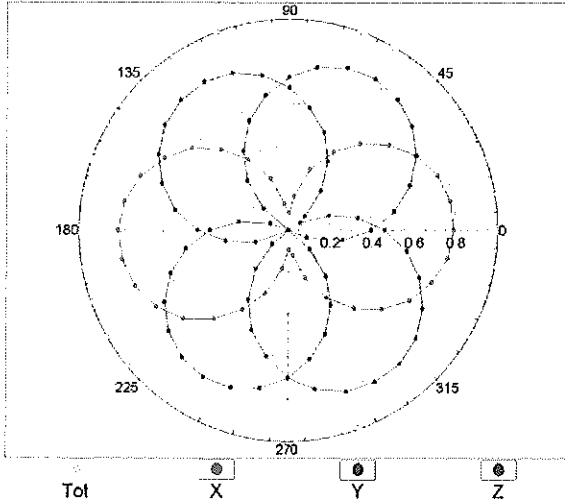

Uncertainty of Axial Isotropy Assessment: $\pm 0.5\%$ ($k=2$)

Dynamic Range $f(\text{SAR}_{\text{head}})$ (TEM cell , $f = 900 \text{ MHz}$)

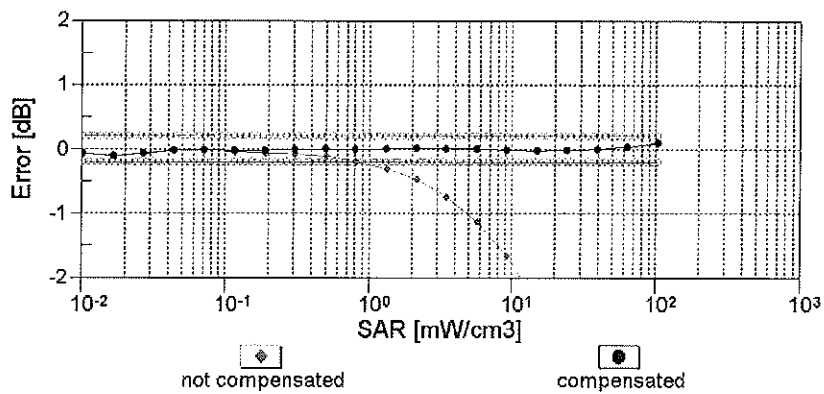
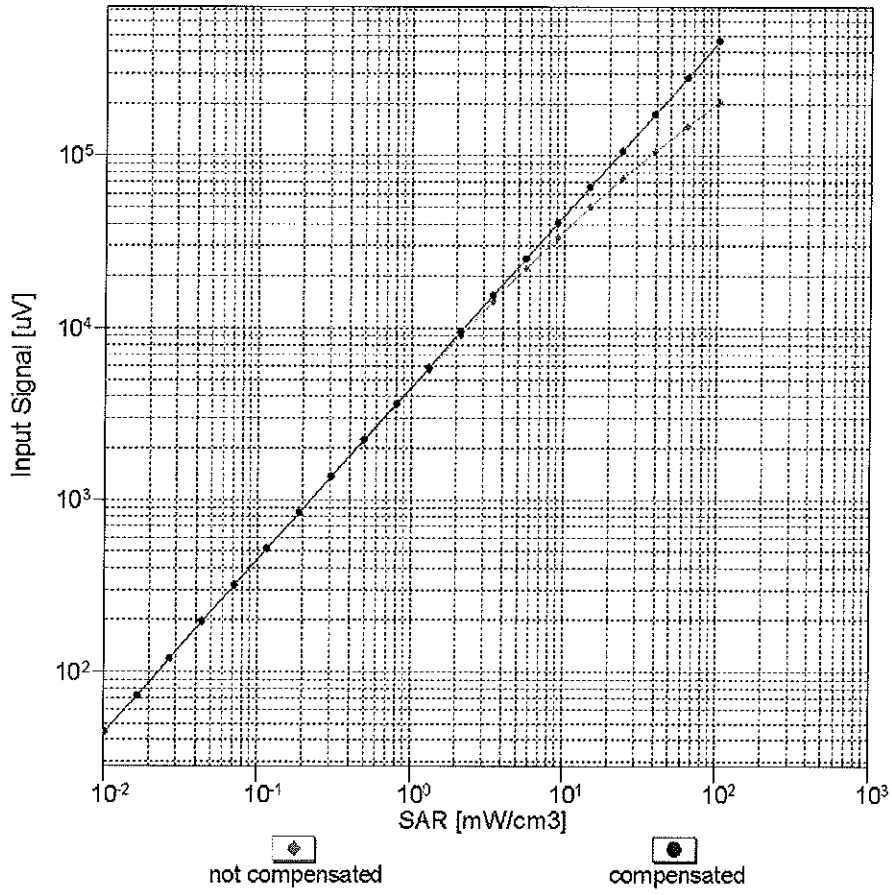

Uncertainty of Linearity Assessment: $\pm 0.6\%$ ($k=2$)

Conversion Factor Assessment

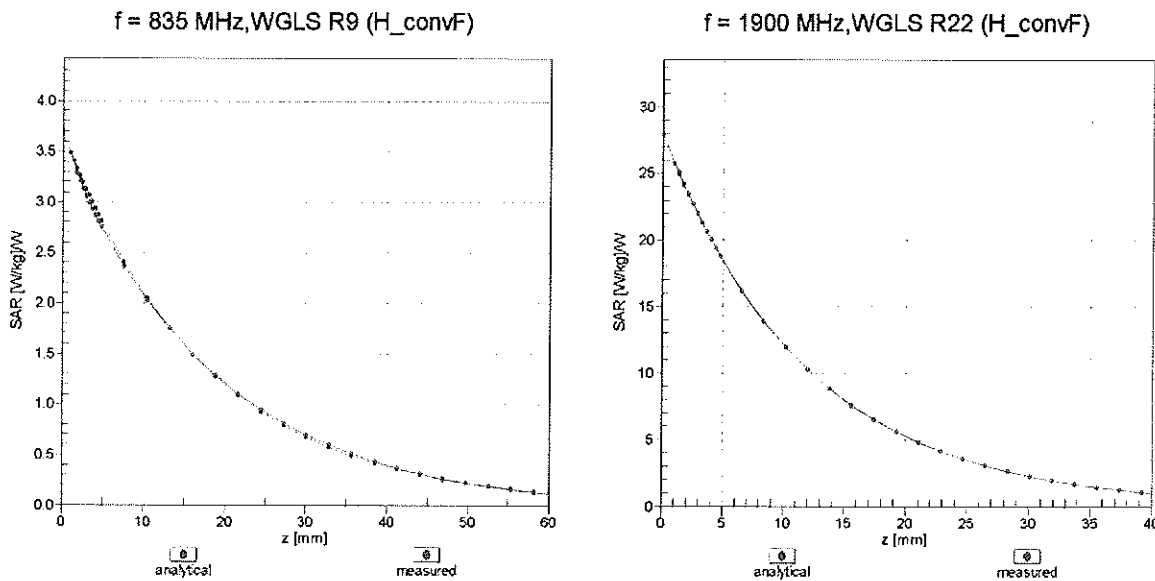

Deviation from Isotropy in Liquid

Error (ϕ, θ), f = 900 MHz

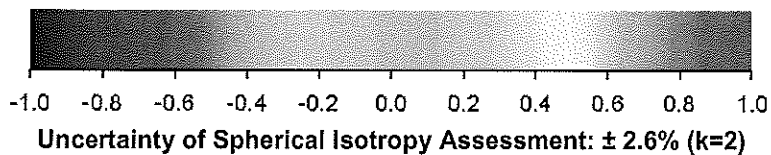
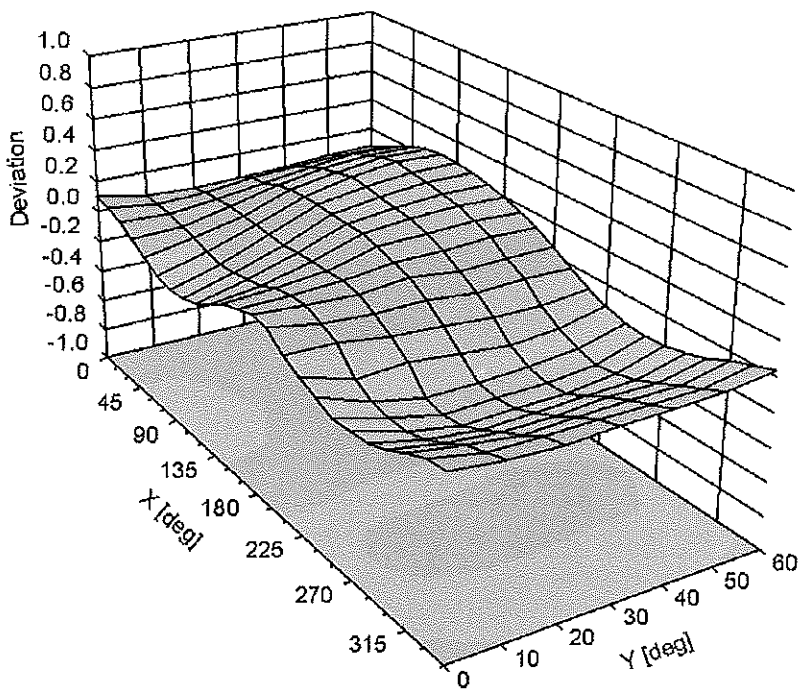

DASY/EASY - Parameters of Probe: EX3DV4 - SN:3698**Other Probe Parameters**

Sensor Arrangement	Triangular
Connector Angle (°)	-138
Mechanical Surface Detection Mode	enabled
Optical Surface Detection Mode	disabled
Probe Overall Length	337 mm
Probe Body Diameter	10 mm
Tip Length	9 mm
Tip Diameter	2.5 mm
Probe Tip to Sensor X Calibration Point	1 mm
Probe Tip to Sensor Y Calibration Point	1 mm
Probe Tip to Sensor Z Calibration Point	1 mm
Recommended Measurement Distance from Surface	2 mm



Appendix E. Dipole Calibration

Validation Dipole 2450 MHz

M/N: ALS-D-2450

S/N: QTK-319

**Calibration Laboratory of
Schmid & Partner
Engineering AG**
Zeughausstrasse 43, 8004 Zurich, Switzerland



S Schweizerischer Kalibrierdienst
S Service suisse d'étalonnage
C Servizio svizzero di taratura
S Swiss Calibration Service

Accredited by the Swiss Accreditation Service (SAS)
The Swiss Accreditation Service is one of the signatories to the EA
Multilateral Agreement for the recognition of calibration certificates

Accreditation No.: **SCS 108**

Client **Quietek (Auden)**

Certificate No: **ALS-2450-QTK-319_Nov12**

CALIBRATION CERTIFICATE

Object **ALS-D-2450 - SN: QTK-319**

Calibration procedure(s) **QA CAL-05.v8
Calibration procedure for dipole validation kits above 700 MHz**

Calibration date: **November 20, 2012**

This calibration certificate documents the traceability to national standards, which realize the physical units of measurements (SI).
The measurements and the uncertainties with confidence probability are given on the following pages and are part of the certificate.

All calibrations have been conducted in the closed laboratory facility: environment temperature (22 ± 3)°C and humidity < 70%.

Calibration Equipment used (M&TE critical for calibration)

Primary Standards	ID #	Cal Date (Certificate No.)	Scheduled Calibration
Power meter EPM-442A	GB37480704	01-Nov-12 (No. 217-01640)	Oct-13
Power sensor HP 8481A	US37292783	01-Nov-12 (No. 217-01640)	Oct-13
Reference 20 dB Attenuator	SN: 5058 (20k)	27-Mar-12 (No. 217-01530)	Apr-13
Type-N mismatch combination	SN: 5047.2 / 06327	27-Mar-12 (No. 217-01533)	Apr-13
Reference Probe ES3DV3	SN: 3205	30-Dec-11 (No. ES3-3205_Dec11)	Dec-12
DAE4	SN: 601	27-Jun-12 (No. DAE4-601_Jun12)	Jun-13

Secondary Standards	ID #	Check Date (in house)	Scheduled Check
Power sensor HP 8481A	MY41092317	18-Oct-02 (in house check Oct-11)	In house check: Oct-13
RF generator R&S SMT-06	100005	04-Aug-99 (in house check Oct-11)	In house check: Oct-13
Network Analyzer HP 8753E	US37390585 S4206	18-Oct-01 (in house check Oct-12)	In house check: Oct-13

Calibrated by:	Name Leif Klynsner	Function Laboratory Technician	Signature
Approved by:	Name Katja Pokovic	Technical Manager Technical Manager	

Issued: November 21, 2012

This calibration certificate shall not be reproduced except in full without written approval of the laboratory.



Accredited by the Swiss Accreditation Service (SAS)
The Swiss Accreditation Service is one of the signatories to the EA
Multilateral Agreement for the recognition of calibration certificates

Accreditation No.: **SCS 108**

Glossary:

TSL	tissue simulating liquid
ConvF	sensitivity in TSL / NORM x,y,z
N/A	not applicable or not measured

Calibration is Performed According to the Following Standards:

- IEEE Std 1528-2003, "IEEE Recommended Practice for Determining the Peak Spatial-Averaged Specific Absorption Rate (SAR) in the Human Head from Wireless Communications Devices: Measurement Techniques", December 2003
- IEC 62209-1, "Procedure to measure the Specific Absorption Rate (SAR) for hand-held devices used in close proximity to the ear (frequency range of 300 MHz to 3 GHz)", February 2005
- Federal Communications Commission Office of Engineering & Technology (FCC OET), "Evaluating Compliance with FCC Guidelines for Human Exposure to Radiofrequency Electromagnetic Fields; Additional Information for Evaluating Compliance of Mobile and Portable Devices with FCC Limits for Human Exposure to Radiofrequency Emissions", Supplement C (Edition 01-01) to Bulletin 65

Additional Documentation:

- DASY4/5 System Handbook

Methods Applied and Interpretation of Parameters:

- Measurement Conditions:** Further details are available from the Validation Report at the end of the certificate. All figures stated in the certificate are valid at the frequency indicated.
- Antenna Parameters with TSL:** The dipole is mounted with the spacer to position its feed point exactly below the center marking of the flat phantom section, with the arms oriented parallel to the body axis.
- Feed Point Impedance and Return Loss:** These parameters are measured with the dipole positioned under the liquid filled phantom. The impedance stated is transformed from the measurement at the SMA connector to the feed point. The Return Loss ensures low reflected power. No uncertainty required.
- Electrical Delay:** One-way delay between the SMA connector and the antenna feed point. No uncertainty required.
- SAR measured:** SAR measured at the stated antenna input power.
- SAR normalized:** SAR as measured, normalized to an input power of 1 W at the antenna connector.
- SAR for nominal TSL parameters:** The measured TSL parameters are used to calculate the nominal SAR result.

The reported uncertainty of measurement is stated as the standard uncertainty of measurement multiplied by the coverage factor $k=2$, which for a normal distribution corresponds to a coverage probability of approximately 95%.

Measurement Conditions

DASY system configuration, as far as not given on page 1.

DASY Version	DASY5	V52.8.3
Extrapolation	Advanced Extrapolation	
Phantom	Modular Flat Phantom	
Distance Dipole Center - TSL	10 mm	with Spacer
Zoom Scan Resolution	dx, dy, dz = 5 mm	
Frequency	2450 MHz \pm 1 MHz	

Head TSL parameters

The following parameters and calculations were applied.

	Temperature	Permittivity	Conductivity
Nominal Head TSL parameters	22.0 °C	39.2	1.80 mho/m
Measured Head TSL parameters	(22.0 \pm 0.2) °C	38.7 \pm 6 %	1.85 mho/m \pm 6 %
Head TSL temperature change during test	< 0.5 °C	----	----

SAR result with Head TSL

SAR averaged over 1 cm ³ (1 g) of Head TSL	Condition	
SAR measured	250 mW input power	14.3 W/kg
SAR for nominal Head TSL parameters	normalized to 1W	56.3 W/kg \pm 17.0 % (k=2)

SAR averaged over 10 cm ³ (10 g) of Head TSL	condition	
SAR measured	250 mW input power	6.63 W/kg
SAR for nominal Head TSL parameters	normalized to 1W	26.3 W/kg \pm 16.5 % (k=2)

Body TSL parameters

The following parameters and calculations were applied.

	Temperature	Permittivity	Conductivity
Nominal Body TSL parameters	22.0 °C	52.7	1.95 mho/m
Measured Body TSL parameters	(22.0 \pm 0.2) °C	51.2 \pm 6 %	2.01 mho/m \pm 6 %
Body TSL temperature change during test	< 0.5 °C	----	----

SAR result with Body TSL

SAR averaged over 1 cm ³ (1 g) of Body TSL	Condition	
SAR measured	250 mW input power	13.5 W/kg
SAR for nominal Body TSL parameters	normalized to 1W	52.9 W/kg \pm 17.0 % (k=2)

SAR averaged over 10 cm ³ (10 g) of Body TSL	condition	
SAR measured	250 mW input power	6.24 W/kg
SAR for nominal Body TSL parameters	normalized to 1W	24.7 W/kg \pm 16.5 % (k=2)

Appendix

Antenna Parameters with Head TSL

Impedance, transformed to feed point	56.7 Ω - 0.9 j Ω
Return Loss	- 24.0 dB

Antenna Parameters with Body TSL

Impedance, transformed to feed point	53.2 Ω + 1.5 j Ω
Return Loss	- 29.3 dB

General Antenna Parameters and Design

Electrical Delay (one direction)	1.018 ns
----------------------------------	----------

After long term use with 100W radiated power, only a slight warming of the dipole near the feedpoint can be measured.

The dipole is made of standard semirigid coaxial cable. The center conductor of the feeding line is directly connected to the second arm of the dipole. The antenna is therefore short-circuited for DC-signals. On some of the dipoles, small end caps are added to the dipole arms in order to improve matching when loaded according to the position as explained in the "Measurement Conditions" paragraph. The SAR data are not affected by this change. The overall dipole length is still according to the Standard.

No excessive force must be applied to the dipole arms, because they might bend or the soldered connections near the feedpoint may be damaged.

Additional EUT Data

Manufactured by	APREL
Manufactured on	Not available

Special Note

The deviation in SAR averaged results towards the latest certificate of the same dipole is higher than expected (higher than typical repeatability deviation for SAR validation dipoles). The reason is unknown, but it may be linked with the dipole repair that took place in between the two calibrations conducted in the SCS108 laboratory.

DASY5 Validation Report for Head TSL

Date: 20.11.2012

Test Laboratory: SPEAG, Zurich, Switzerland

DUT: Dipole 2450 MHz; Type: ALS-D-2450-S-2; Serial: SN: QTK-319

Communication System: CW; Frequency: 2450 MHz

Medium parameters used: $f = 2450$ MHz; $\sigma = 1.85$ mho/m; $\epsilon_r = 38.7$; $\rho = 1000$ kg/m³

Phantom section: Flat Section

Measurement Standard: DASY5 (IEEE/IEC/ANSI C63.19-2007)

DASY52 Configuration:

- Probe: ES3DV3 - SN3205; ConvF(4.45, 4.45, 4.45); Calibrated: 30.12.2011;
- Sensor-Surface: 3mm (Mechanical Surface Detection)
- Electronics: DAE4 Sn601; Calibrated: 27.06.2012
- Phantom: Flat Phantom 5.0 (front); Type: QD000P50AA; Serial: 1001
- DASY52 52.8.3(988); SEMCAD X 14.6.7(6848)

Dipole Calibration for Head Tissue/Pin=250 mW, d=10mm/Zoom Scan (7x7x7)/Cube 0:

Measurement grid: dx=5mm, dy=5mm, dz=5mm

Reference Value = 102.6 V/m; Power Drift = 0.00 dB

Peak SAR (extrapolated) = 29.5 W/kg

SAR(1 g) = 14.3 W/kg; SAR(10 g) = 6.63 W/kg

Maximum value of SAR (measured) = 18.2 W/kg

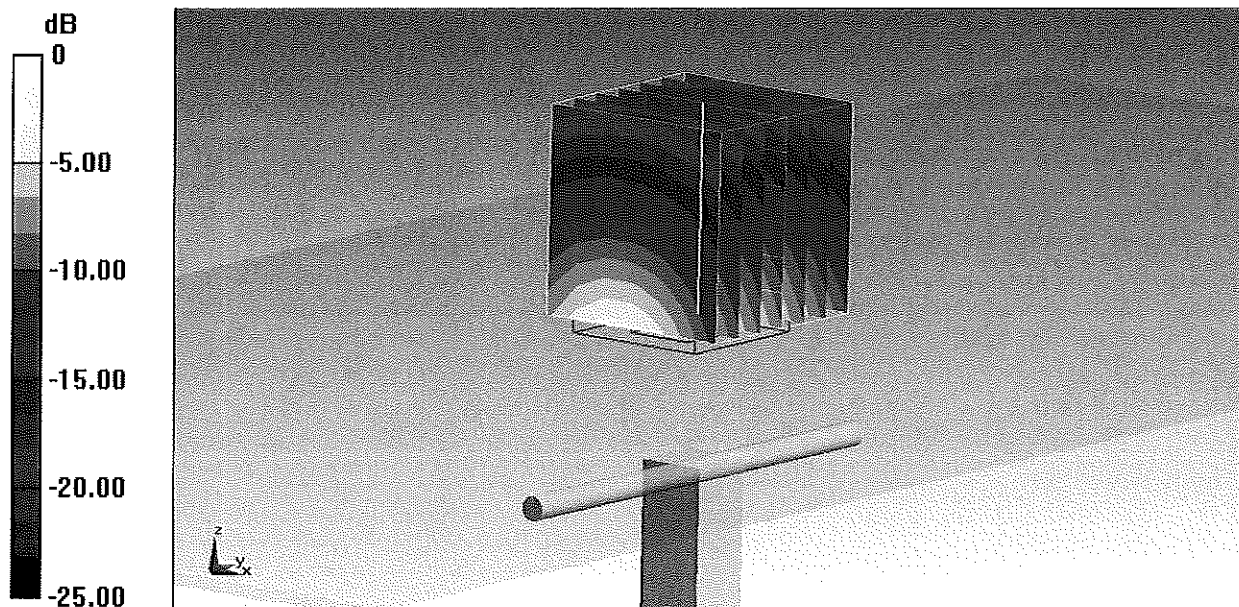

0 dB = 18.2 W/kg = 12.60 dBW/kg

Impedance Measurement Plot for Head TSL

20 Nov 2012 14:30:41

CH1 S11 1 U FS 1: 37.553 Ω 4.2793 Ω 277.99 μH 2 450.000 000 MHz

*
Del
CA
Avg
16
H1d

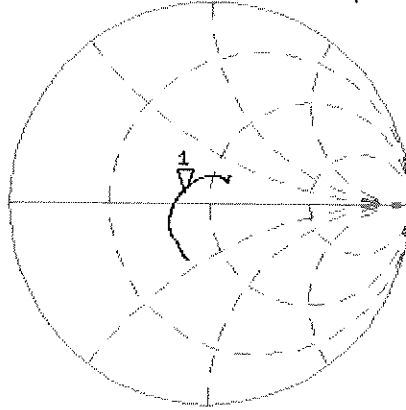

CH2 S11 LOG 5 dB/REF -20 dB 1:-16.469 dB 2 450.000 000 MHz

CA
Avg
16
H1d

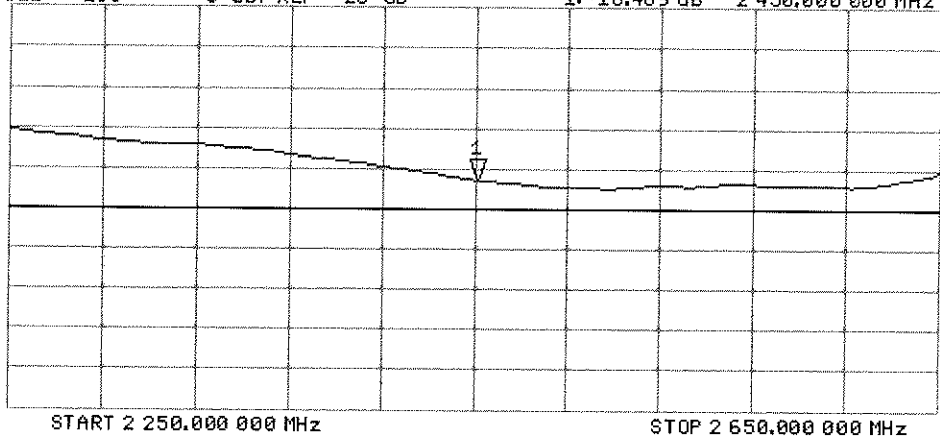

DASY5 Validation Report for Body TSL

Date: 20.11.2012

Test Laboratory: SPEAG, Zurich, Switzerland

DUT: Dipole 2450 MHz; Type: ALS-D-2450-S-2; Serial: SN: QTK-319

Communication System: CW; Frequency: 2450 MHz

Medium parameters used: $f = 2450$ MHz; $\sigma = 2.01$ mho/m; $\epsilon_r = 51.2$; $\rho = 1000$ kg/m³

Phantom section: Flat Section

Measurement Standard: DASY5 (IEEE/IEC/ANSI C63.19-2007)

DASY52 Configuration:

- Probe: ES3DV3 - SN3205; ConvF(4.26, 4.26, 4.26); Calibrated: 30.12.2011;
- Sensor-Surface: 3mm (Mechanical Surface Detection)
- Electronics: DAE4 Sn601; Calibrated: 27.06.2012
- Phantom: Flat Phantom 5.0 (back); Type: QD000P50AA; Serial: 1002
- DASY52 52.8.3(988); SEMCAD X 14.6.7(6848)

Dipole Calibration for Body Tissue/Pin=250 mW, d=10mm/Zoom Scan (7x8x7)/Cube 0:

Measurement grid: dx=5mm, dy=5mm, dz=5mm

Reference Value = 94.392 V/m; Power Drift = 0.00 dB

Peak SAR (extrapolated) = 27.9 W/kg

SAR(1 g) = 13.5 W/kg; SAR(10 g) = 6.24 W/kg

Maximum value of SAR (measured) = 17.8 W/kg

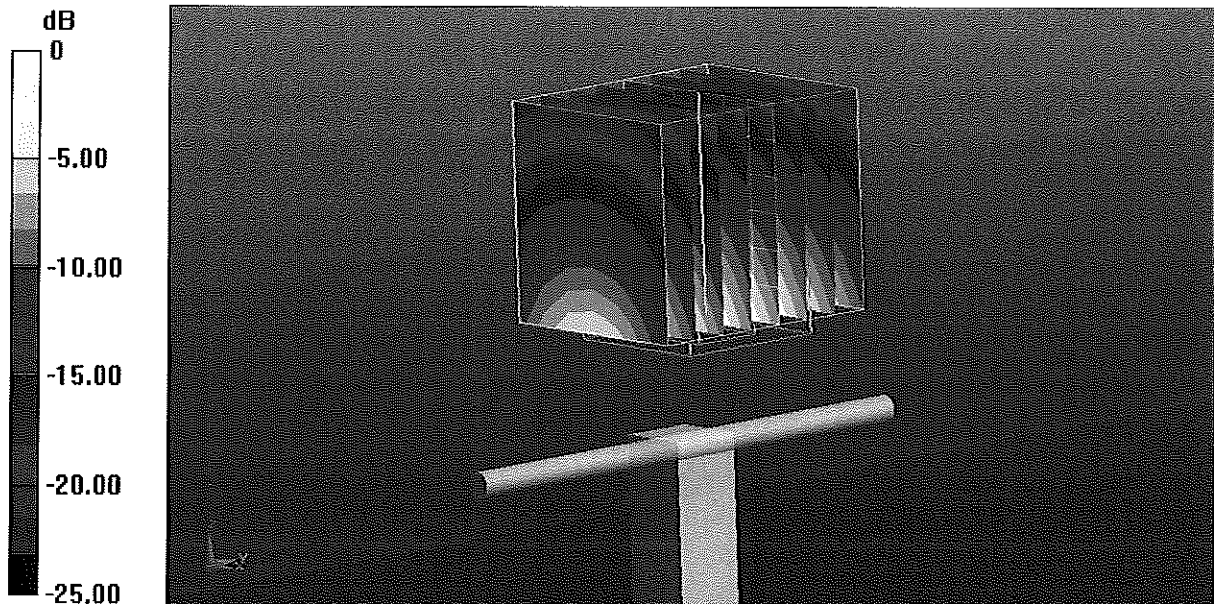

0 dB = 17.8 W/kg = 12.50 dBW/kg

Impedance Measurement Plot for Body TSL

20 Nov 2012 09:55:15
[CH1] S11 1 U FS 1: 34.504 Ω 8.8320 Ω 573.74 pF 2 450.000 000 MHz

*
De1
Cor

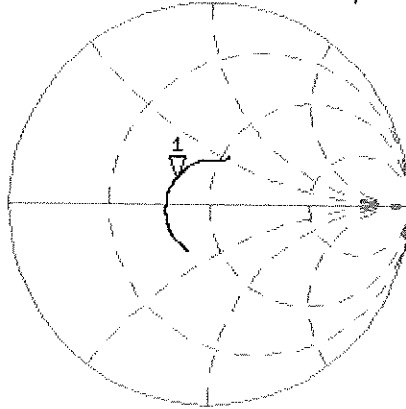

Avg
16

H1d

CH2 S11 LOG 5 dB/REF -20 dB 1: -13.561 dB 2 450.000 000 MHz

Cor

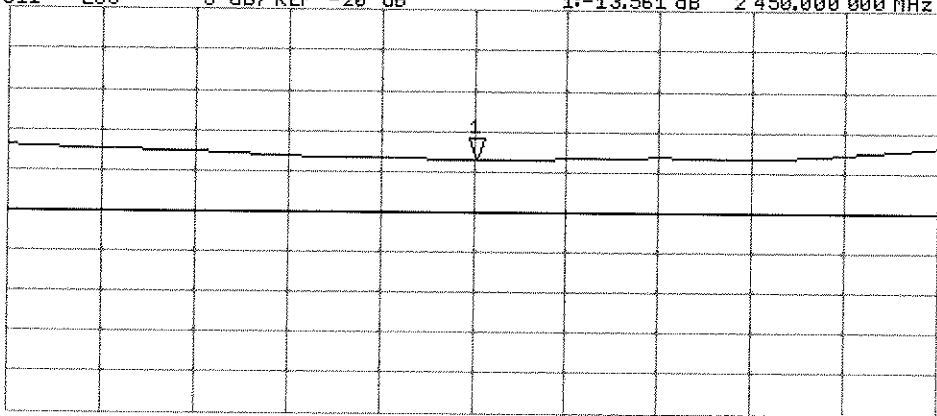

START 2 250.000 000 MHz

STOP 2 650.000 000 MHz