



# FCC TEST REPORT (BLUETOOTH+EDR)

**REPORT NO.:** RF130924D02-1

**MODEL NO.:** TA10CAx

**FCC ID:** WL6-TABC0001

**RECEIVED:** Sep. 8, 2013

**TESTED:** Oct. 3 ~ 8, 2013

**ISSUED:** Oct. 18, 2013

**APPLICANT:** Elitegroup Computer Systems Co., Ltd

**ADDRESS:** No. 239, Ti Ding Blvd., Sec. 2, Taipei, Taiwan 11493

**ISSUED BY:** Bureau Veritas Consumer Products Services  
(H.K.) Ltd., Taoyuan Branch

**LAB ADDRESS:** No. 47, 14th Ling, Chia Pau Vil., Lin Kou Dist.,  
New Taipei City, Taiwan, R.O.C.

This report should not be used by the client to claim product certification, approval, or endorsement by TAF or any government agencies.



This report is for your exclusive use. Any copying or replication of this report to or for any other person or entity, or use of our name or trademark, is permitted only with our prior written permission. This report sets forth our findings solely with respect to the test samples identified herein. The results set forth in this report are not indicative or representative of the quality or characteristics of the lot from which a test sample was taken or any similar or identical product unless specifically and expressly noted. Our report includes all of the tests requested by you and the results thereof based upon the information that you provided to us. You have 60 days from date of issuance of this report to notify us of any material error or omission caused by our negligence, provided, however, that such notice shall be in writing and shall specifically address the issue you wish to raise. A failure to raise such issue within the prescribed time shall constitute your unqualified acceptance of the completeness of this report, the tests conducted and the correctness of the report contents. Unless specific mention, the uncertainty of measurement has been explicitly taken into account to declare the compliance or non-compliance to the specification.

## Table of Contents

|  |    |
|--|----|
| RELEASE CONTROL RECORD .....                                     | 4  |
| 1. CERTIFICATION.....  | 5  |
| 2. SUMMARY OF TEST RESULTS .....                                 | 6  |
| 2.1 MEASUREMENT UNCERTAINTY .....                                | 6  |
| 3. GENERAL INFORMATION .....                                     | 7  |
| 3.1 GENERAL DESCRIPTION OF EUT .....                             | 7  |
| 3.2 DESCRIPTION OF TEST MODES .....                              | 8  |
| 3.2.1 TEST MODE APPLICABILITY AND TESTED CHANNEL DETAIL.....     | 9  |
| 3.3 DESCRIPTION OF SUPPORT UNITS .....                           | 12 |
| 3.3.1 CONFIGURATION OF SYSTEM UNDER TEST.....                    | 12 |
| 3.4 GENERAL DESCRIPTION OF APPLIED STANDARDS.....                | 13 |
| 4. TEST TYPES AND RESULTS .....                                  | 14 |
| 4.1 RADIATED EMISSION AND BANDEDGE MEASUREMENT .....             | 14 |
| 4.1.1 LIMITS OF RADIATED EMISSION AND BANDEDGE MEASUREMENT ..... | 14 |
| 4.1.2 TEST INSTRUMENTS.....                                      | 15 |
| 4.1.3 TEST PROCEDURES .....                                      | 16 |
| 4.1.4 DEVIATION FROM TEST STANDARD.....                          | 16 |
| 4.1.5 TEST SETUP.....  | 17 |
| 4.1.6 EUT OPERATING CONDITIONS .....                             | 17 |
| 4.1.7 TEST RESULTS .....   | 18 |
| 4.2 CONDUCTED EMISSION MEASUREMENT.....                          | 25 |
| 4.2.1 LIMITS OF CONDUCTED EMISSION MEASUREMENT .....             | 25 |
| 4.2.2 TEST INSTRUMENTS.....                                      | 25 |
| 4.2.3 TEST PROCEDURES .....                                      | 26 |
| 4.2.4 DEVIATION FROM TEST STANDARD.....                          | 26 |
| 4.2.5 TEST SETUP.....  | 27 |
| 4.2.6 EUT OPERATING CONDITIONS .....                             | 27 |
| 4.2.7 TEST RESULTS .....   | 28 |
| 4.3 NUMBER OF HOPPING FREQUENCY USED.....                        | 30 |
| 4.3.1 LIMIT OF HOPPING FREQUENCY USED.....                       | 30 |
| 4.3.2 TEST SETUP.....  | 30 |
| 4.3.3 TEST INSTRUMENTS.....                                      | 30 |
| 4.3.4 TEST PROCEDURES .....                                      | 30 |
| 4.3.5 DEVIATION FROM TEST STANDARD.....                          | 30 |
| 4.3.6 TEST RESULTS .....   | 30 |
| 4.4 DWELL TIME ON EACH CHANNEL.....                              | 32 |
| 4.4.1 LIMIT OF DWELL TIME USED .....                             | 32 |
| 4.4.2 TEST SETUP.....  | 32 |
| 4.4.3 TEST INSTRUMENTS.....                                      | 32 |



A D T

|       |   |    |
|-------|---|----|
| 4.4.4 | TEST PROCEDURES .....   | 32 |
| 4.4.5 | DEVIATION FROM TEST STANDARD .....  | 32 |
| 4.4.6 | TEST RESULTS .....  | 33 |
| 4.5   | CHANNEL BANDWIDTH .....   | 35 |
| 4.5.1 | LIMITS OF CHANNEL BANDWIDTH .....   | 35 |
| 4.5.2 | TEST SETUP .....  | 35 |
| 4.5.3 | TEST INSTRUMENTS .....  | 35 |
| 4.5.4 | TEST PROCEDURE .....  | 35 |
| 4.5.5 | DEVIATION FROM TEST STANDARD .....  | 35 |
| 4.5.6 | EUT OPERATING CONDITION .....   | 35 |
| 4.5.7 | TEST RESULTS .....  | 36 |
| 4.6   | HOPPING CHANNEL SEPARATION .....  | 37 |
| 4.6.1 | LIMIT OF HOPPING CHANNEL SEPARATION .....   | 37 |
| 4.6.2 | TEST SETUP .....  | 37 |
| 4.6.3 | TEST INSTRUMENTS .....  | 37 |
| 4.6.4 | TEST PROCEDURES .....   | 37 |
| 4.6.5 | DEVIATION FROM TEST STANDARD .....  | 37 |
| 4.6.6 | TEST RESULTS .....  | 38 |
| 4.7   | MAXIMUM OUTPUT POWER .....  | 39 |
| 4.7.1 | LIMITS OF MAXIMUM OUTPUT POWER MEASUREMENT .....  | 39 |
| 4.7.2 | TEST SETUP .....  | 39 |
| 4.7.3 | TEST INSTRUMENTS .....  | 39 |
| 4.7.4 | TEST PROCEDURES .....   | 39 |
| 4.7.5 | DEVIATION FROM TEST STANDARD .....  | 39 |
| 4.7.6 | EUT OPERATING CONDITION .....   | 39 |
| 4.7.7 | TEST RESULTS .....  | 40 |
| 4.8   | CONDUCTED OUT OF BAND EMISSION MEASUREMENT .....  | 41 |
| 4.8.1 | LIMITS OF CONDUCTED OUT OF BAND EMISSION MEASUREMENT .....                                  | 41 |
| 4.8.2 | TEST INSTRUMENTS .....  | 41 |
| 4.8.3 | TEST PROCEDURE .....  | 41 |
| 4.8.4 | DEVIATION FROM TEST STANDARD .....  | 41 |
| 4.8.5 | EUT OPERATING CONDITION .....   | 41 |
| 4.8.6 | TEST RESULTS .....  | 41 |
| 5.    | PHOTOGRAPHS OF THE TEST CONFIGURATION .....   | 44 |
| 6.    | INFORMATION ON THE TESTING LABORATORIES .....   | 45 |
| 7.    | APPENDIX A - MODIFICATIONS RECORDERS FOR ENGINEERING<br>CHANGES TO THE EUT BY THE LAB ..... | 46 |



## RELEASE CONTROL RECORD

| ISSUE NO.     | REASON FOR CHANGE | DATE ISSUED   |
|---------------|-------------------|---------------|
| RF130924D02-1 | Original release  | Oct. 18, 2013 |



## 1. CERTIFICATION

**PRODUCT:** Tablet PC  
**BRAND NAME:** ECS  
**MODEL NO.:** TA10CAx (x=0~9, A~Z or blank or "-")  
**APPLICANT:** Elitegroup Computer Systems Co., Ltd  
**TESTED:** Oct. 3 ~ 8, 2013  
**TEST SAMPLE:** ENGINEERING SAMPLE  
**STANDARDS:** **FCC Part 15, Subpart C (Section 15.247)**  
ANSI C63.10-2009

The above equipment (Model: TA10CA1) has been tested by **Bureau Veritas Consumer Products Services (H.K.) Ltd., Taoyuan Branch**, and found compliance with the requirement of the above standards. The test record, data evaluation & Equipment Under Test (EUT) configurations represented herein are true and accurate accounts of the measurements of the sample's EMC characteristics under the conditions specified in this report.

**PREPARED BY :** Annie Chang , **DATE:** Oct. 18, 2013  
( Annie Chang / Supervisor )

**APPROVED BY :** Rex Lai , **DATE:** Oct. 18, 2013  
( Rex Lai / Assistant Manager )

## 2. SUMMARY OF TEST RESULTS

The EUT has been tested according to the following specifications:

| APPLIED STANDARD: FCC Part 15, Subpart C |   |        |  |
|--|---|--------|--|
| STANDARD SECTION                         | TEST TYPE AND LIMIT   | RESULT | REMARK   |
| 15.207                                   | AC Power Conducted Emission   | PASS   | Meet the requirement of limit. Minimum passing margin is -12.08dB at 0.51976MHz. |
| 15.247(a)(1) (iii)                       | Number of Hopping Frequency Used  | PASS   | Meet the requirement of limit.   |
| 15.247(a)(1) (iii)                       | Dwell Time on Each Channel  | PASS   | Meet the requirement of limit.   |
| 15.247(a)(1)                             | 1. Hopping Channel Separation<br>2. Spectrum Bandwidth of a Frequency Hopping Sequence Spread Spectrum System | PASS   | Meet the requirement of limit.   |
| 15.247(b)                                | Maximum Peak Output Power   | PASS   | Meet the requirement of limit.   |
| 15.247(d)                                | Transmitter Radiated Emissions  | PASS   | Meet the requirement of limit. Minimum passing margin is -7.0dB at 54.10MHz.     |
| 15.247(d)                                | Band Edge Measurement   | PASS   | Meet the requirement of limit.   |
| 15.203                                   | Antenna Requirement   | PASS   | Antenna connector is I-PEX not a standard connector.                             |

**NOTE:** If The Frequency Hopping System operating in 2400-2483.5MHz band and the output power less than 125mW. The hopping channel carrier frequencies separated by a minimum of 25kHz or two-thirds of the 20dB bandwidth of hopping channel whichever is greater.

### 2.1 MEASUREMENT UNCERTAINTY

Where relevant, the following measurement uncertainty levels have been estimated for tests performed on the EUT as specified in CISPR 16-4-2:

This uncertainty represents an expanded uncertainty expressed at approximately the 95% confidence level using a coverage factor of k=2.

| MEASUREMENT         | FREQUENCY      | UNCERTAINTY |
|---------------------|----------------|-------------|
| Conducted emissions | 150kHz ~ 30MHz | 2.41 dB     |
| Radiated emissions  | 30MHz ~ 1GHz   | 4.30 dB     |
|                     | Above 1GHz     | 3.36 dB     |

### 3. GENERAL INFORMATION

#### 3.1 GENERAL DESCRIPTION OF EUT

|                              |                                |
|------------------------------|--------------------------------|
| <b>EUT</b>                   | Tablet PC                      |
| <b>MODEL NO.</b>             | TA10CAx                        |
| <b>POWER SUPPLY</b>          | 5.0Vdc from Adapter            |
| <b>MODULATION TYPE</b>       | GFSK, $\pi/4$ -DQPSK, 8DPSK    |
| <b>MODULATION TECHNOLOGY</b> | FHSS                           |
| <b>TRANSFER RATE</b>         | 1/2/3Mbps                      |
| <b>OPERATING FREQUENCY</b>   | 2402 ~ 2480MHz                 |
| <b>NUMBER OF CHANNEL</b>     | 79                             |
| <b>MAX. OUTPUT POWER</b>     | 6.9mW                          |
| <b>ANTENNA TYPE</b>          | PIFA antenna with 0.80dBi gain |
| <b>ANTENNA CONNECTOR</b>     | I-PEX connector                |
| <b>I/O PORTS</b>             | Shielded USB cable (1.0m)      |
| <b>DATA CABLE</b>            | Refer to user's manual         |
| <b>ACCESSORY DEVICES</b>     | Refer to note below            |

**NOTE:**

1. The EUT is a Tablet PC.
2. The "x" in the model could be defined as 0~9, A~Z or blank or "-" for marketing differentiation. During the test, model: **TA10CA1** was selected as the representative one and therefore only its test data was recorded in this report.
3. The EUT consumes power from a switching power adapter and the following different models could be chosen (following adapters are identical to each other except for their plug type differences only) :

| Brand/ Model No.     | Plug Type                 | Specification   |
|----------------------|---------------------------|---|
| Chicony / W12-010N3A | US                        | AC I/P: 100-240V, 50-60Hz, 0.3A<br>DC O/P: 5V, 2A<br>AC 2 Pin |
| Chicony / W12-010N3C | China                     |   |
| Chicony / W12-010N3E | UK                        |   |
| Chicony / W12-010N3B | EU                        |   |
| Chicony / W12-010N3G | Argentina                 |   |
| Chicony / W12-010N3J | Brazil                    |   |
| Chicony / W12-010N3F | Australia                 |   |
| Chicony / W12-010N3D | Korea                     |   |
| Chicony / W12-010N3H | South Africa / India Plug |   |

During the test, model: **W12-010N3A** was selected as the representative one and therefore only its test data was recorded in this report.

4. The EUT was pre-tested with the following modes:

- ✧ Operating + Charging Mode (EUT + Adapter)
- ✧ Operating Mode (EUT stand-alone)

The worst emission level was found when the EUT tested under **Operating + Charging Mode (EUT + Adapter)**, therefore, only its test data was recorded in this report.

5. The above EUT information is declared by manufacturer and for more detailed features description, please refer to the manufacturer's specifications or User's Manual.

### 3.2 DESCRIPTION OF TEST MODES

79 channels are provided to this EUT:

| CHANNEL | FREQ. (MHz) | CHANNEL | FREQ. (MHz) | CHANNEL | FREQ. (MHz) | CHANNEL | FREQ. (MHz) |
|---------|-------------|---------|-------------|---------|-------------|---------|-------------|
| 0       | 2402        | 20      | 2422        | 40      | 2442        | 60      | 2462        |
| 1       | 2403        | 21      | 2423        | 41      | 2443        | 61      | 2463        |
| 2       | 2404        | 22      | 2424        | 42      | 2444        | 62      | 2464        |
| 3       | 2405        | 23      | 2425        | 43      | 2445        | 63      | 2465        |
| 4       | 2406        | 24      | 2426        | 44      | 2446        | 64      | 2466        |
| 5       | 2407        | 25      | 2427        | 45      | 2447        | 65      | 2467        |
| 6       | 2408        | 26      | 2428        | 46      | 2448        | 66      | 2468        |
| 7       | 2409        | 27      | 2429        | 47      | 2449        | 67      | 2469        |
| 8       | 2410        | 28      | 2430        | 48      | 2450        | 68      | 2470        |
| 9       | 2411        | 29      | 2431        | 49      | 2451        | 69      | 2471        |
| 10      | 2412        | 30      | 2432        | 50      | 2452        | 70      | 2472        |
| 11      | 2413        | 31      | 2433        | 51      | 2453        | 71      | 2473        |
| 12      | 2414        | 32      | 2434        | 52      | 2454        | 72      | 2474        |
| 13      | 2415        | 33      | 2435        | 53      | 2455        | 73      | 2475        |
| 14      | 2416        | 34      | 2436        | 54      | 2456        | 74      | 2476        |
| 15      | 2417        | 35      | 2437        | 55      | 2457        | 75      | 2477        |
| 16      | 2418        | 36      | 2438        | 56      | 2458        | 76      | 2478        |
| 17      | 2419        | 37      | 2439        | 57      | 2459        | 77      | 2479        |
| 18      | 2420        | 38      | 2440        | 58      | 2460        | 78      | 2480        |
| 19      | 2421        | 39      | 2441        | 59      | 2461        |         |             |





### 3.2.1 TEST MODE APPLICABILITY AND TESTED CHANNEL DETAIL

| EUT CONFIGURE MODE | APPLICABLE TO |       |     |      |    | DESCRIPTION |
|--------------------|---------------|-------|-----|------|----|-------------|
|                    | RE≥1G         | RE<1G | PLC | APCM | OB |             |
| -                  | √             | √     | √   | √    | √  | -           |

Where **RE≥1G**: Radiated Emission above 1GHz      **RE<1G**: Radiated Emission below 1GHz  
**PLC**: Power Line Conducted Emission      **APCM**: Antenna Port Conducted Measurement  
**OB**: Conducted Out-Band Emission Measurement

**NOTE:** The EUT had been pre-tested on the positioned of each 3 axis. The worst case was found when positioned on Z-plane.

#### RADIATED EMISSION TEST (ABOVE 1 GHz):

- Pre-Scan has been conducted to determine the worst-case mode from all possible combinations between available modulations, antenna ports (if EUT with antenna diversity architecture) and packet type.
- Following channel(s) was (were) selected for the final test as listed below.

| EUT CONFIGURE MODE | AVAILABLE CHANNEL | TESTED CHANNEL | MODULATION TECHNOLOGY | MODULATION TYPE | PACKET TYPE |
|--------------------|-------------------|----------------|-----------------------|-----------------|-------------|
| -                  | 0 to 78           | 0, 39, 78      | FHSS                  | GFSK            | DH5         |
|                    | 0 to 78           | 0, 39, 78      | FHSS                  | 8DPSK           | DH5         |

#### RADIATED EMISSION TEST (BELOW 1 GHz):

- Pre-Scan has been conducted to determine the worst-case mode from all possible combinations between available modulations, antenna ports (if EUT with antenna diversity architecture) and packet type.
- Following channel(s) was (were) selected for the final test as listed below.

| EUT CONFIGURE MODE | AVAILABLE CHANNEL | TESTED CHANNEL | MODULATION TECHNOLOGY | MODULATION TYPE | PACKET TYPE |
|--------------------|-------------------|----------------|-----------------------|-----------------|-------------|
| -                  | 0 to 78           | 0              | FHSS                  | GFSK            | DH5         |

**POWER LINE CONDUCTED EMISSION TEST:**

- Pre-Scan has been conducted to determine the worst-case mode from all possible combinations between available modulations, antenna ports (if EUT with antenna diversity architecture), and packet types.
- Following channel(s) was (were) selected for the final test as listed below.

| EUT CONFIGURE MODE | AVAILABLE CHANNEL | TESTED CHANNEL | MODULATION TECHNOLOGY | MODULATION TYPE | PACKET TYPE |
|--------------------|-------------------|----------------|-----------------------|-----------------|-------------|
| -                  | 0 to 78           | 0              | FHSS                  | GFSK            | DH5         |

**CONDUCTED OUT-BAND EMISSION MEASUREMENT:**

- Pre-Scan has been conducted to determine the worst-case mode from all possible combinations between available modulations, antenna ports (if EUT with antenna diversity architecture), and packet types.
- Following channel(s) was (were) selected for the final test as listed below.

| EUT CONFIGURE MODE | AVAILABLE CHANNEL | TESTED CHANNEL | MODULATION TECHNOLOGY | MODULATION TYPE | PACKET TYPE |
|--------------------|-------------------|----------------|-----------------------|-----------------|-------------|
| -                  | 0 to 78           | 0, 78          | FHSS                  | GFSK            | DH5         |
|                    | 0 to 78           | 0, 78          | FHSS                  | 8DPSK           | DH5         |

**ANTENNA PORT CONDUCTED MEASUREMENT:**

- This item includes all test value of each mode, but only includes spectrum plot of worst value of each mode.
- Pre-Scan has been conducted to determine the worst-case mode from all possible combinations between available modulations, antenna ports (if EUT with antenna diversity architecture), and packet types.
- Following channel(s) was (were) selected for the final test as listed below.

| EUT CONFIGURE MODE | AVAILABLE CHANNEL | TESTED CHANNEL | MODULATION TECHNOLOGY | MODULATION TYPE | PACKET TYPE |
|--------------------|-------------------|----------------|-----------------------|-----------------|-------------|
| -                  | 0 to 78           | 0, 39, 78      | FHSS                  | GFSK            | DH5         |
|                    | 0 to 78           | 0, 39, 78      | FHSS                  | 8DPSK           | DH5         |



A D T

**TEST CONDITION:**

| APPLICABLE TO | ENVIRONMENTAL CONDITIONS | INPUT POWER  | TESTED BY |
|---------------|--------------------------|--------------|-----------|
| RE $\geq$ 1G  | 25deg. C, 76% RH         | 120Vac, 60Hz | Joey Liu  |
| RE<1G         | 25deg. C, 76% RH         | 120Vac, 60Hz | Joey Liu  |
| PLC           | 24deg. C, 76% RH         | 120Vac, 60Hz | Aaron You |
| OB            | 25deg. C, 76% RH         | 120Vac, 60Hz | Joey Liu  |
| APCM          | 25deg. C, 60% RH         | 120Vac, 60Hz | Dalen Dai |

### 3.3 DESCRIPTION OF SUPPORT UNITS

The EUT has been tested as an independent unit together without other necessary accessories or support units.

#### 3.3.1 CONFIGURATION OF SYSTEM UNDER TEST

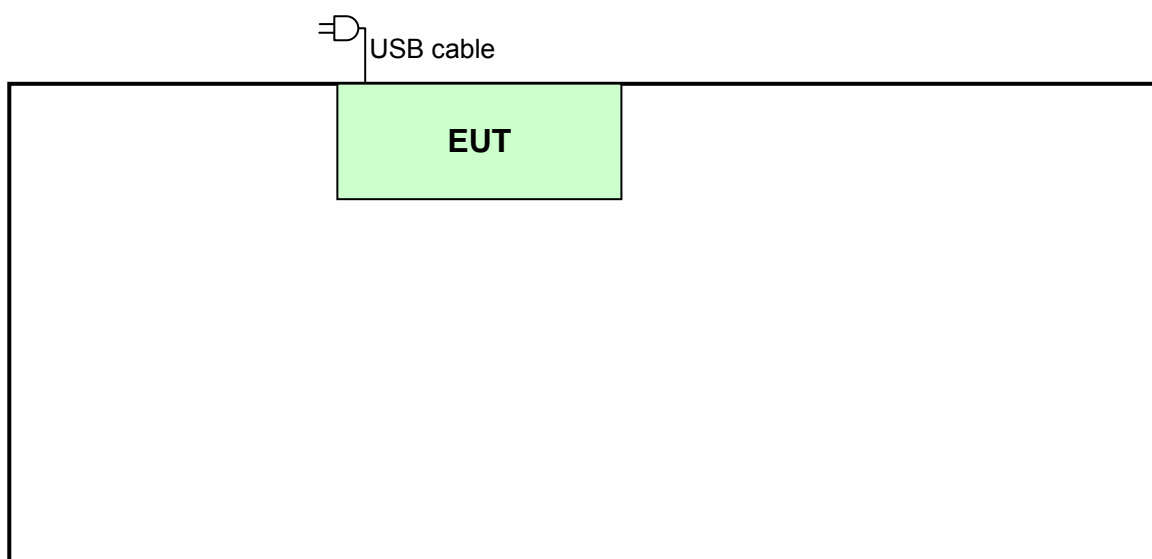

### 3.4 GENERAL DESCRIPTION OF APPLIED STANDARDS

The EUT is a RF Product. According to the specifications of the manufacturer, it must comply with the requirements of the following standards:

**FCC Part 15, Subpart C. (15.247)**

ANSI C63.10-2009

All test items have been performed and recorded as per the above standards.

**NOTE:** The product has been verified to comply with the requirements of FCC Part 15, Subpart B, Class B (DoC). The test report has been issued separately.

## 4. TEST TYPES AND RESULTS

### 4.1 RADIATED EMISSION AND BANDEDGE MEASUREMENT

#### 4.1.1 LIMITS OF RADIATED EMISSION AND BANDEDGE MEASUREMENT

Radiated emissions which fall in the restricted bands must comply with the radiated emission limits specified as below table. Other emissions shall be at least 20dB below the highest level of the desired power:

| FREQUENCIES (MHz) | FIELD STRENGTH (microvolts/meter) | MEASUREMENT DISTANCE (meters) |
|-------------------|-----------------------------------|-------------------------------|
| 0.009 ~ 0.490     | 2400/F(kHz)                       | 300                           |
| 0.490 ~ 1.705     | 24000/F(kHz)                      | 30                            |
| 1.705 ~ 30.0      | 30                                | 30                            |
| 30 ~ 88           | 100                               | 3                             |
| 88 ~ 216          | 150                               | 3                             |
| 216 ~ 960         | 200                               | 3                             |
| Above 960         | 500                               | 3                             |

**NOTE:**

1. The lower limit shall apply at the transition frequencies.
2. Emission level (dBuV/m) = 20 log Emission level (uV/m).
3. For frequencies above 1000MHz, the field strength limits are based on average detector, however, the peak field strength of any emission shall not exceed the maximum permitted average limits, specified above by more than 20dB under any condition of modulation.



## 4.1.2 TEST INSTRUMENTS

| DESCRIPTION & MANUFACTURER                   | MODEL NO.                    | SERIAL NO. | CALIBRATED DATE | CALIBRATED UNTIL |
|--|------------------------------|------------|-----------------|------------------|
| HP Preamplifier                              | 8447D                        | 2432A03504 | Feb. 26, 2013   | Feb. 25, 2014    |
| HP Preamplifier                              | 8449B                        | 3008A01201 | Feb. 26, 2013   | Feb. 25, 2014    |
| Agilent<br>TEST RECEIVER                     | N9038A                       | MY51210129 | Jan. 03, 2013   | Jan. 02, 2014    |
| Schwarzbeck Antenna                          | VULB 9168                    | 137        | Mar. 20, 2013   | Mar. 19, 2014    |
| Schwarzbeck Antenna                          | VHBA 9123                    | 480        | May 29, 2013    | May 28, 2014     |
| ADT. Turn Table                              | TT100                        | 0306       | NA              | NA               |
| ADT. Tower                                   | AT100                        | 0306       | NA              | NA               |
| Software                                     | ADT_Radiated_V<br>7.6.15.9.2 | NA         | NA              | NA               |
| SUHNER RF cable                              | SF102                        | CABLE-CH6  | Aug. 19, 2013   | Aug. 18, 2014    |
| Schwarzbeck Horn<br>Antenna                  | BBHA 9120-D1                 | D130       | May 13, 2013    | May 12, 2014     |
| Highpass filter<br>Wainwright<br>Instruments | WHK<br>3.1/18G-10SS          | SN 8       | NA              | NA               |
| ROHDE & SCHWARZ<br>Spectrum Analyzer         | FSP 40                       | 100036     | May. 17, 2013   | May. 16, 2014    |
| Anritsu<br>Power Sensor                      | MA2411B                      | 0738404    | Apr. 24, 2013   | Apr. 23, 2014    |
| Anritsu<br>Power Meter                       | ML2495A                      | 0842014    | Apr. 25, 2013   | Apr. 24, 2014    |

- NOTE:** 1. The calibration interval of the above test instruments is 12/24 months. And the calibrations are traceable to NML/ROC and NIST/USA.
2. The horn antenna and HP preamplifier (model: 8449B) are used only for the measurement of emission frequency above 1GHz if tested.
3. The test was performed in Chamber No. 6.
4. The Industry Canada Reference No. IC 7450E-6.
5. The FCC Site Registration No. is 447212.

### 4.1.3 TEST PROCEDURES

- a. The EUT was placed on the top of a rotating table 0.8 meters above the ground at a 3 meter semi-anechoic chamber. The table was rotated 360 degrees to determine the position of the highest radiation.
- b. The EUT was set 3 meters away from the interference-receiving antenna, which was mounted on the top of a variable-height antenna tower.
- c. The height is varied from one meter to four meters above the ground to determine the maximum value of the field strength. Both horizontal and vertical polarizations of the antenna are set to make the measurement.
- d. For each suspected emission, the EUT was arranged to its worst case and then the antenna was tuned to heights from 1 meter to 4 meters and the rotatable table was turned from 0 degrees to 360 degrees to find the maximum reading.
- e. The test-receiver system was set to Peak Detect Function and Specified Bandwidth with Maximum Hold Mode.
- f. If the emission level of the EUT in peak mode was lower than the limit specified, then testing could be stopped and the peak values of the EUT would be reported. Otherwise the emissions would be re-tested one by one using peak, quasi-peak or average method as specified and then reported in a data sheet.

**NOTE:**

1. The resolution bandwidth and video bandwidth of test receiver/spectrum analyzer is 120kHz for Quasi-peak detection at frequency below 1GHz.
2. The resolution bandwidth of test receiver/spectrum analyzer is 1 MHz and video bandwidth is 3MHz for Peak detection at frequency above 1GHz.
3. All modes of operation were investigated and the worst-case emissions are reported.

### 4.1.4 DEVIATION FROM TEST STANDARD

No deviation.



### 4.1.5 TEST SETUP

Frequency range 30MHz~1GHz

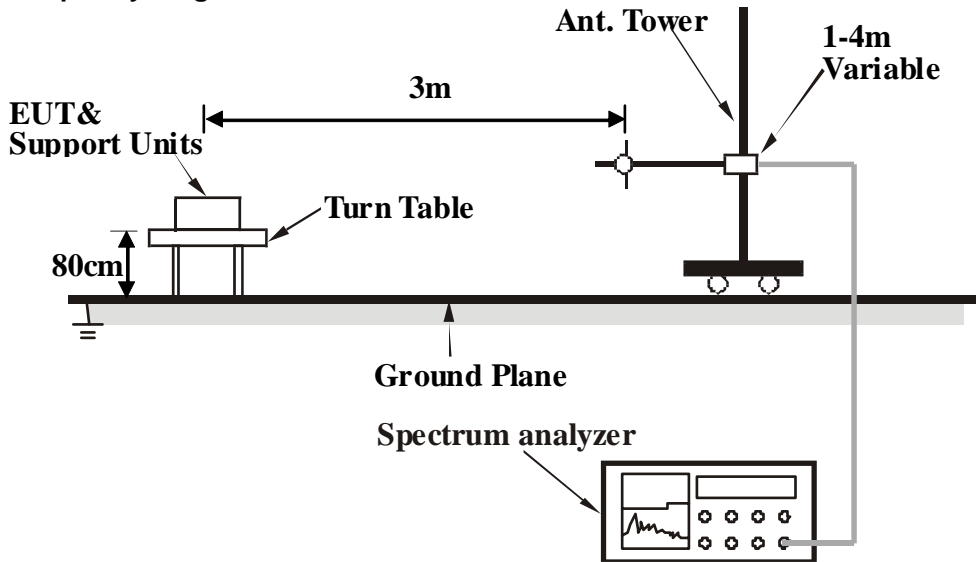

Frequency range above 1GHz

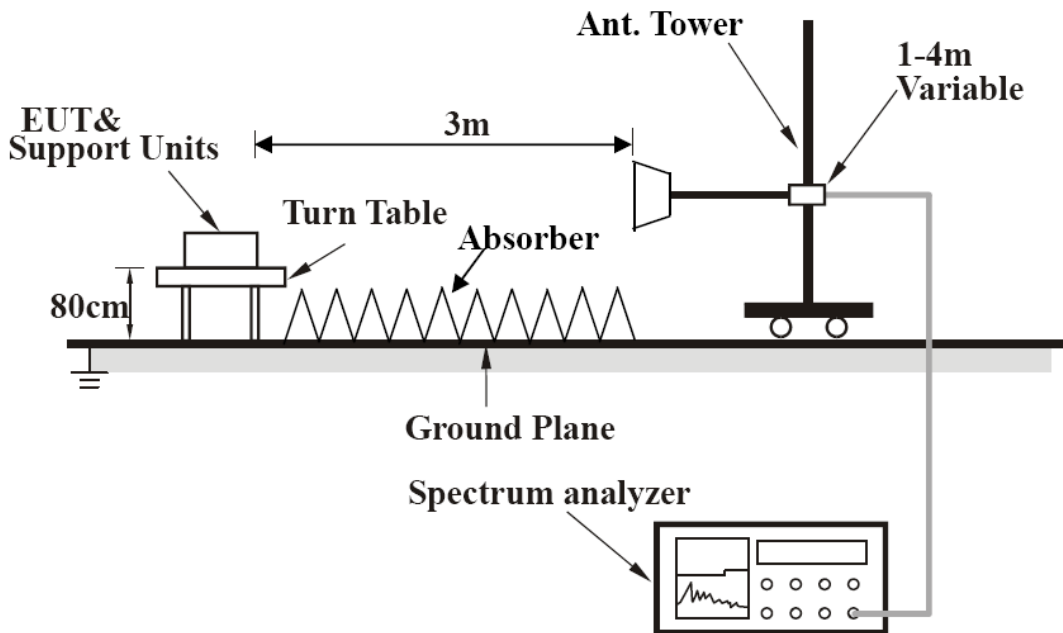

For the actual test configuration, please refer to the attached file (Test Setup Photo).

### 4.1.6 EUT OPERATING CONDITIONS

- a. Connected the EUT with adapter placed on testing table.
- b. Set the EUT under transmission/receiving condition continuously at specific channel frequency and charging condition.

## 4.1.7 TEST RESULTS

### ABOVE 1GHz DATA

#### BT\_GFSK

|                        |              |                              |              |
|------------------------|--------------|------------------------------|--------------|
| <b>CHANNEL</b>         | TX Channel 0 | <b>DETECTOR<br/>FUNCTION</b> | Peak (PK)    |
| <b>FREQUENCY RANGE</b> | 1GHz ~ 25GHz |                              | Average (AV) |

#### ANTENNA POLARITY & TEST DISTANCE: HORIZONTAL AT 3 M

| NO. | FREQ.<br>(MHz) | EMISSION<br>LEVEL<br>(dBuV/m) | LIMIT<br>(dBuV/m) | MARGIN<br>(dB) | ANTENNA<br>HEIGHT<br>(m) | TABLE<br>ANGLE<br>(Degree) | RAW<br>VALUE<br>(dBuV) | CORRECTION<br>FACTOR<br>(dB/m) |
|-----|----------------|-------------------------------|-------------------|----------------|--------------------------|----------------------------|------------------------|--------------------------------|
| 1   | 2390.00        | 44.5 PK                       | 74.0              | -29.5          | 1.51 H                   | 253                        | 48.27                  | -3.75                          |
| 2   | 2390.00        | 32.8 AV                       | 54.0              | -21.2          | 1.51 H                   | 253                        | 36.53                  | -3.75                          |
| 3   | #2400.00       | 59.2 PK                       | 73.7              | -14.5          | 1.51 H                   | 253                        | 62.87                  | -3.70                          |
| 4   | #2400.00       | 30.3 AV                       | 39.8              | -9.5           | 1.51 H                   | 253                        | 33.95                  | -3.70                          |
| 5   | *2402.00       | 93.7 PK                       |                   |                | 1.51 H                   | 253                        | 97.36                  | -3.69                          |
| 6   | *2402.00       | 59.8 AV                       |                   |                | 1.51 H                   | 253                        | 63.44                  | -3.69                          |
| 7   | 4804.00        | 45.6 PK                       | 74.0              | -28.4          | 1.53 H                   | 250                        | 41.91                  | 3.70                           |
| 8   | 4804.00        | 33.5 AV                       | 54.0              | -20.5          | 1.53 H                   | 250                        | 29.83                  | 3.70                           |

#### ANTENNA POLARITY & TEST DISTANCE: VERTICAL AT 3 M

| NO. | FREQ.<br>(MHz) | EMISSION<br>LEVEL<br>(dBuV/m) | LIMIT<br>(dBuV/m) | MARGIN<br>(dB) | ANTENNA<br>HEIGHT<br>(m) | TABLE<br>ANGLE<br>(Degree) | RAW<br>VALUE<br>(dBuV) | CORRECTION<br>FACTOR<br>(dB/m) |
|-----|----------------|-------------------------------|-------------------|----------------|--------------------------|----------------------------|------------------------|--------------------------------|
| 1   | 2390.00        | 53.8 PK                       | 74.0              | -20.2          | 1.00 V                   | 253                        | 57.53                  | -3.75                          |
| 2   | 2390.00        | 37.3 AV                       | 54.0              | -16.7          | 1.00 V                   | 253                        | 41.04                  | -3.75                          |
| 3   | #2400.00       | 64.1 PK                       | 77.6              | -13.5          | 1.00 V                   | 253                        | 67.75                  | -3.70                          |
| 4   | #2400.00       | 27.4 AV                       | 40.9              | -13.5          | 1.00 V                   | 253                        | 31.09                  | -3.70                          |
| 5   | *2402.00       | 97.6 PK                       |                   |                | 1.00 V                   | 253                        | 101.24                 | -3.69                          |
| 6   | *2402.00       | 60.9 AV                       |                   |                | 1.00 V                   | 253                        | 64.58                  | -3.69                          |
| 7   | 4804.00        | 42.7 PK                       | 74.0              | -31.3          | 1.00 V                   | 255                        | 39.02                  | 3.70                           |
| 8   | 4804.00        | 33.7 AV                       | 54.0              | -20.3          | 1.00 V                   | 255                        | 29.97                  | 3.70                           |

#### REMARKS:

1. Emission Level(dBuV/m) = Raw Value(dBuV) + Correction Factor(dB/m)
2. Correction Factor(dB/m) = Antenna Factor(dB/m) + Cable Factor(dB) – Pre-Amplifier Factor(dB)
3. The other emission levels were very low against the limit.
4. Margin value = Emission Level – Limit value
5. " \* " : Fundamental frequency.
6. " # " : The radiated frequency is out of the restricted band.



A D T

|                        |               |                          |              |
|------------------------|---------------|--------------------------|--------------|
| <b>CHANNEL</b>         | TX Channel 39 | <b>DETECTOR FUNCTION</b> | Peak (PK)    |
| <b>FREQUENCY RANGE</b> | 1GHz ~ 25GHz  |                          | Average (AV) |

**ANTENNA POLARITY & TEST DISTANCE: HORIZONTAL AT 3 M**

| NO. | FREQ. (MHz) | EMISSION LEVEL (dBuV/m) | LIMIT (dBuV/m) | MARGIN (dB) | ANTENNA HEIGHT (m) | TABLE ANGLE (Degree) | RAW VALUE (dBuV) | CORRECTION FACTOR (dB/m) |
|-----|-------------|-------------------------|----------------|-------------|--------------------|----------------------|------------------|--------------------------|
| 1   | *2441.00    | 93.3 PK                 |                |             | 1.52 H             | 333                  | 96.78            | -3.51                    |
| 2   | *2441.00    | 59.4 AV                 |                |             | 1.52 H             | 333                  | 62.89            | -3.51                    |
| 3   | 4882.00     | 47.5 PK                 | 74.0           | -26.5       | 1.51 H             | 324                  | 43.78            | 3.76                     |
| 4   | 4882.00     | 36.4 AV                 | 54.0           | -17.6       | 1.51 H             | 324                  | 32.63            | 3.76                     |

**ANTENNA POLARITY & TEST DISTANCE: VERTICAL AT 3 M**

| NO. | FREQ. (MHz) | EMISSION LEVEL (dBuV/m) | LIMIT (dBuV/m) | MARGIN (dB) | ANTENNA HEIGHT (m) | TABLE ANGLE (Degree) | RAW VALUE (dBuV) | CORRECTION FACTOR (dB/m) |
|-----|-------------|-------------------------|----------------|-------------|--------------------|----------------------|------------------|--------------------------|
| 1   | *2441.00    | 98.2 PK                 |                |             | 1.00 V             | 255                  | 101.72           | -3.51                    |
| 2   | *2441.00    | 60.3 AV                 |                |             | 1.00 V             | 255                  | 63.83            | -3.51                    |
| 3   | 4882.00     | 47.1 PK                 | 74.0           | -26.9       | 1.00 V             | 250                  | 43.36            | 3.76                     |
| 4   | 4882.00     | 35.9 AV                 | 54.0           | -18.1       | 1.00 V             | 250                  | 32.11            | 3.76                     |

**REMARKS:**

1. Emission Level(dBuV/m) = Raw Value(dBuV) + Correction Factor(dB/m)
2. Correction Factor(dB/m) = Antenna Factor(dB/m) + Cable Factor(dB) – Pre-Amplifier Factor(dB)
3. The other emission levels were very low against the limit.
4. Margin value = Emission Level – Limit value
5. " \* " : Fundamental frequency.



A D T

|                        |               |                          |              |
|------------------------|---------------|--------------------------|--------------|
| <b>CHANNEL</b>         | TX Channel 78 | <b>DETECTOR FUNCTION</b> | Peak (PK)    |
| <b>FREQUENCY RANGE</b> | 1GHz ~ 25GHz  |                          | Average (AV) |

**ANTENNA POLARITY & TEST DISTANCE: HORIZONTAL AT 3 M**

| NO. | FREQ. (MHz) | EMISSION LEVEL (dBuV/m) | LIMIT (dBuV/m) | MARGIN (dB) | ANTENNA HEIGHT (m) | TABLE ANGLE (Degree) | RAW VALUE (dBuV) | CORRECTION FACTOR (dB/m) |
|-----|-------------|-------------------------|----------------|-------------|--------------------|----------------------|------------------|--------------------------|
| 1   | *2480.00    | 93.5 PK                 |                |             | 1.52 H             | 334                  | 96.78            | -3.33                    |
| 2   | *2480.00    | 60.2 AV                 |                |             | 1.52 H             | 334                  | 63.55            | -3.33                    |
| 3   | 2483.50     | 45.3 PK                 | 74.0           | -28.7       | 1.52 H             | 334                  | 48.65            | -3.32                    |
| 4   | 2483.50     | 31.9 AV                 | 54.0           | -22.1       | 1.52 H             | 334                  | 35.26            | -3.32                    |
| 5   | 4960.00     | 48.2 PK                 | 74.0           | -25.8       | 1.49 H             | 330                  | 44.53            | 3.70                     |
| 6   | 4960.00     | 35.8 AV                 | 54.0           | -18.2       | 1.49 H             | 330                  | 32.10            | 3.70                     |

**ANTENNA POLARITY & TEST DISTANCE: VERTICAL AT 3 M**

| NO. | FREQ. (MHz) | EMISSION LEVEL (dBuV/m) | LIMIT (dBuV/m) | MARGIN (dB) | ANTENNA HEIGHT (m) | TABLE ANGLE (Degree) | RAW VALUE (dBuV) | CORRECTION FACTOR (dB/m) |
|-----|-------------|-------------------------|----------------|-------------|--------------------|----------------------|------------------|--------------------------|
| 1   | *2480.00    | 106.5 PK                |                |             | 1.00 V             | 248                  | 109.87           | -3.33                    |
| 2   | *2480.00    | 60.5 AV                 |                |             | 1.00 V             | 248                  | 63.78            | -3.33                    |
| 3   | 2483.50     | 49.1 PK                 | 74.0           | -24.9       | 1.00 V             | 248                  | 52.42            | -3.32                    |
| 4   | 2483.50     | 31.5 AV                 | 54.0           | -22.5       | 1.00 V             | 248                  | 34.86            | -3.32                    |
| 5   | 4960.00     | 48.2 PK                 | 74.0           | -25.8       | 1.00 V             | 253                  | 44.52            | 3.70                     |
| 6   | 4960.00     | 36.5 AV                 | 54.0           | -17.5       | 1.00 V             | 253                  | 32.78            | 3.70                     |

**REMARKS:**

1. Emission Level(dBuV/m) = Raw Value(dBuV) + Correction Factor(dB/m)
2. Correction Factor(dB/m) = Antenna Factor(dB/m) + Cable Factor(dB) – Pre-Amplifier Factor(dB)
3. The other emission levels were very low against the limit.
4. Margin value = Emission Level – Limit value
5. " \* ": Fundamental frequency.

BT\_8DPSK

|                        |              |                          |              |
|------------------------|--------------|--------------------------|--------------|
| <b>CHANNEL</b>         | TX Channel 0 | <b>DETECTOR FUNCTION</b> | Peak (PK)    |
| <b>FREQUENCY RANGE</b> | 1GHz ~ 25GHz |                          | Average (AV) |

| ANTENNA POLARITY & TEST DISTANCE: HORIZONTAL AT 3 M |             |                         |                |             |                    |                      |                  |                          |
|---|-------------|-------------------------|----------------|-------------|--------------------|----------------------|------------------|--------------------------|
| NO.   | FREQ. (MHz) | EMISSION LEVEL (dBuV/m) | LIMIT (dBuV/m) | MARGIN (dB) | ANTENNA HEIGHT (m) | TABLE ANGLE (Degree) | RAW VALUE (dBuV) | CORRECTION FACTOR (dB/m) |
| 1   | 2390.00     | 49.8 PK                 | 74.0           | -24.2       | 1.52 H             | 334                  | 53.53            | -3.75                    |
| 2   | 2390.00     | 35.2 AV                 | 54.0           | -18.8       | 1.52 H             | 334                  | 38.92            | -3.75                    |
| 3   | #2400.00    | 59.3 PK                 | 73.8           | -14.5       | 1.52 H             | 334                  | 63.03            | -3.70                    |
| 4   | #2400.00    | 25.1 AV                 | 39.6           | -14.5       | 1.52 H             | 334                  | 28.79            | -3.70                    |
| 5   | *2402.00    | 93.8 PK                 |                |             | 1.52 H             | 334                  | 97.52            | -3.69                    |
| 6   | *2402.00    | 59.6 AV                 |                |             | 1.52 H             | 334                  | 63.28            | -3.69                    |
| 7   | 4804.00     | 44.5 PK                 | 74.0           | -29.5       | 1.51 H             | 351                  | 40.82            | 3.70                     |
| 8   | 4804.00     | 32.4 AV                 | 54.0           | -21.6       | 1.51 H             | 351                  | 28.69            | 3.70                     |

| ANTENNA POLARITY & TEST DISTANCE: VERTICAL AT 3 M |             |                         |                |             |                    |                      |                  |                          |
|---|-------------|-------------------------|----------------|-------------|--------------------|----------------------|------------------|--------------------------|
| NO.   | FREQ. (MHz) | EMISSION LEVEL (dBuV/m) | LIMIT (dBuV/m) | MARGIN (dB) | ANTENNA HEIGHT (m) | TABLE ANGLE (Degree) | RAW VALUE (dBuV) | CORRECTION FACTOR (dB/m) |
| 1   | 2390.00     | 50.3 PK                 | 74.0           | -23.7       | 1.00 V             | 248                  | 54.09            | -3.75                    |
| 2   | 2390.00     | 34.7 AV                 | 54.0           | -19.3       | 1.00 V             | 248                  | 38.43            | -3.75                    |
| 3   | #2400.00    | 63.9 PK                 | 78.4           | -14.5       | 1.00 V             | 248                  | 67.58            | -3.70                    |
| 4   | #2400.00    | 26.6 AV                 | 41.1           | -14.5       | 1.00 V             | 248                  | 30.33            | -3.70                    |
| 5   | *2402.00    | 98.4 PK                 |                |             | 1.00 V             | 248                  | 102.07           | -3.69                    |
| 6   | *2402.00    | 61.1 AV                 |                |             | 1.00 V             | 248                  | 64.82            | -3.69                    |
| 7   | 4804.00     | 45.6 PK                 | 74.0           | -28.4       | 1.00 V             | 238                  | 41.93            | 3.70                     |
| 8   | 4804.00     | 32.4 AV                 | 54.0           | -21.6       | 1.00 V             | 238                  | 28.69            | 3.70                     |

**REMARKS:**

1. Emission Level(dBuV/m) = Raw Value(dBuV) + Correction Factor(dB/m)
2. Correction Factor(dB/m) = Antenna Factor(dB/m) + Cable Factor(dB) – Pre-Amplifier Factor(dB)
3. The other emission levels were very low against the limit.
4. Margin value = Emission Level – Limit value
5. " \* ": Fundamental frequency.
6. " # ": The radiated frequency is out of the restricted band.



A D T

|                        |               |                          |              |
|------------------------|---------------|--------------------------|--------------|
| <b>CHANNEL</b>         | TX Channel 39 | <b>DETECTOR FUNCTION</b> | Peak (PK)    |
| <b>FREQUENCY RANGE</b> | 1GHz ~ 25GHz  |                          | Average (AV) |

**ANTENNA POLARITY & TEST DISTANCE: HORIZONTAL AT 3 M**

| NO. | FREQ. (MHz) | EMISSION LEVEL (dBuV/m) | LIMIT (dBuV/m) | MARGIN (dB) | ANTENNA HEIGHT (m) | TABLE ANGLE (Degree) | RAW VALUE (dBuV) | CORRECTION FACTOR (dB/m) |
|-----|-------------|-------------------------|----------------|-------------|--------------------|----------------------|------------------|--------------------------|
| 1   | *2441.00    | 93.4 PK                 |                |             | 1.55 H             | 330                  | 96.87            | -3.51                    |
| 2   | *2441.00    | 59.8 AV                 |                |             | 1.55 H             | 330                  | 63.27            | -3.51                    |
| 3   | 4882.00     | 47.4 PK                 | 74.0           | -26.6       | 1.52 H             | 328                  | 43.67            | 3.76                     |
| 4   | 4882.00     | 35.9 AV                 | 54.0           | -18.1       | 1.52 H             | 328                  | 32.17            | 3.76                     |

**ANTENNA POLARITY & TEST DISTANCE: VERTICAL AT 3 M**

| NO. | FREQ. (MHz) | EMISSION LEVEL (dBuV/m) | LIMIT (dBuV/m) | MARGIN (dB) | ANTENNA HEIGHT (m) | TABLE ANGLE (Degree) | RAW VALUE (dBuV) | CORRECTION FACTOR (dB/m) |
|-----|-------------|-------------------------|----------------|-------------|--------------------|----------------------|------------------|--------------------------|
| 1   | *2441.00    | 97.7 PK                 |                |             | 1.00 V             | 250                  | 101.24           | -3.51                    |
| 2   | *2441.00    | 59.7 AV                 |                |             | 1.00 V             | 250                  | 63.25            | -3.51                    |
| 3   | 4882.00     | 47.4 PK                 | 74.0           | -26.6       | 1.00 V             | 248                  | 43.62            | 3.76                     |
| 4   | 4882.00     | 36.2 AV                 | 54.0           | -17.8       | 1.00 V             | 248                  | 32.47            | 3.76                     |

**REMARKS:**

1. Emission Level(dBuV/m) = Raw Value(dBuV) + Correction Factor(dB/m)
2. Correction Factor(dB/m) = Antenna Factor(dB/m) + Cable Factor(dB) – Pre-Amplifier Factor(dB)
3. The other emission levels were very low against the limit.
4. Margin value = Emission Level – Limit value
5. " \* " : Fundamental frequency.



A D T

|                        |               |                          |              |
|------------------------|---------------|--------------------------|--------------|
| <b>CHANNEL</b>         | TX Channel 78 | <b>DETECTOR FUNCTION</b> | Peak (PK)    |
| <b>FREQUENCY RANGE</b> | 1GHz ~ 25GHz  |                          | Average (AV) |

**ANTENNA POLARITY & TEST DISTANCE: HORIZONTAL AT 3 M**

| NO. | FREQ. (MHz) | EMISSION LEVEL (dBuV/m) | LIMIT (dBuV/m) | MARGIN (dB) | ANTENNA HEIGHT (m) | TABLE ANGLE (Degree) | RAW VALUE (dBuV) | CORRECTION FACTOR (dB/m) |
|-----|-------------|-------------------------|----------------|-------------|--------------------|----------------------|------------------|--------------------------|
| 1   | *2480.00    | 93.8 PK                 |                |             | 1.53 H             | 333                  | 97.12            | -3.33                    |
| 2   | *2480.00    | 60.5 AV                 |                |             | 1.53 H             | 333                  | 63.84            | -3.33                    |
| 3   | 4960.00     | 48.1 PK                 | 74.0           | -26.0       | 1.50 H             | 331                  | 44.35            | 3.70                     |
| 4   | 4960.00     | 36.1 AV                 | 54.0           | -17.9       | 1.50 H             | 331                  | 32.39            | 3.70                     |

**ANTENNA POLARITY & TEST DISTANCE: VERTICAL AT 3 M**

| NO. | FREQ. (MHz) | EMISSION LEVEL (dBuV/m) | LIMIT (dBuV/m) | MARGIN (dB) | ANTENNA HEIGHT (m) | TABLE ANGLE (Degree) | RAW VALUE (dBuV) | CORRECTION FACTOR (dB/m) |
|-----|-------------|-------------------------|----------------|-------------|--------------------|----------------------|------------------|--------------------------|
| 1   | *2480.00    | 99.0 PK                 |                |             | 1.00 V             | 250                  | 102.32           | -3.33                    |
| 2   | *2480.00    | 61.8 AV                 |                |             | 1.00 V             | 250                  | 65.17            | -3.33                    |
| 3   | 4960.00     | 47.4 PK                 | 74.0           | -26.6       | 1.00 V             | 253                  | 43.72            | 3.70                     |
| 4   | 4960.00     | 36.6 AV                 | 54.0           | -17.4       | 1.00 V             | 253                  | 32.89            | 3.70                     |

**REMARKS:**

1. Emission Level(dBuV/m) = Raw Value(dBuV) + Correction Factor(dB/m)
2. Correction Factor(dB/m) = Antenna Factor(dB/m) + Cable Factor(dB) – Pre-Amplifier Factor(dB)
3. The other emission levels were very low against the limit.
4. Margin value = Emission Level – Limit value
5. " \* ": Fundamental frequency.

**BELOW 1GHz WORST-CASE DATA**

**BT\_GFSK**

|                        |              |                          |                 |
|------------------------|--------------|--------------------------|-----------------|
| <b>CHANNEL</b>         | TX Channel 0 | <b>DETECTOR FUNCTION</b> | Quasi-Peak (QP) |
| <b>FREQUENCY RANGE</b> | 30MHz ~ 1GHz |                          |                 |

**ANTENNA POLARITY & TEST DISTANCE: HORIZONTAL AT 3 M**

| NO. | FREQ. (MHz) | EMISSION LEVEL (dBuV/m) | LIMIT (dBuV/m) | MARGIN (dB) | ANTENNA HEIGHT (m) | TABLE ANGLE (Degree) | RAW VALUE (dBuV) | CORRECTION FACTOR (dB/m) |
|-----|-------------|-------------------------|----------------|-------------|--------------------|----------------------|------------------|--------------------------|
| 1   | 104.06      | 30.4 QP                 | 43.5           | -13.1       | 1.43 H             | 97                   | 47.90            | -17.52                   |
| 2   | 144.65      | 36.3 QP                 | 43.5           | -7.2        | 1.17 H             | 211                  | 49.66            | -13.34                   |
| 3   | 166.58      | 35.7 QP                 | 43.5           | -7.8        | 1.55 H             | 143                  | 49.20            | -13.53                   |
| 4   | 240.78      | 33.3 QP                 | 46.0           | -12.7       | 1.38 H             | 315                  | 47.33            | -14.00                   |
| 5   | 288.02      | 32.2 QP                 | 46.0           | -13.9       | 1.27 H             | 311                  | 43.93            | -11.78                   |
| 6   | 358.25      | 32.8 QP                 | 46.0           | -13.2       | 2.01 H             | 216                  | 43.13            | -10.37                   |
| 7   | 506.27      | 33.0 QP                 | 46.0           | -13.0       | 1.67 H             | 341                  | 40.18            | -7.22                    |

**ANTENNA POLARITY & TEST DISTANCE: VERTICAL AT 3 M**

| NO. | FREQ. (MHz) | EMISSION LEVEL (dBuV/m) | LIMIT (dBuV/m) | MARGIN (dB) | ANTENNA HEIGHT (m) | TABLE ANGLE (Degree) | RAW VALUE (dBuV) | CORRECTION FACTOR (dB/m) |
|-----|-------------|-------------------------|----------------|-------------|--------------------|----------------------|------------------|--------------------------|
| 1   | 54.10       | 33.0 QP                 | 40.0           | -7.0        | 1.60 V             | 62                   | 46.10            | -13.13                   |
| 2   | 104.88      | 33.3 QP                 | 43.5           | -10.2       | 1.34 V             | 146                  | 50.73            | -17.46                   |
| 3   | 154.16      | 33.9 QP                 | 43.5           | -9.6        | 1.02 V             | 256                  | 46.76            | -12.90                   |
| 4   | 293.31      | 31.1 QP                 | 46.0           | -14.9       | 1.66 V             | 297                  | 42.75            | -11.67                   |
| 5   | 506.22      | 35.2 QP                 | 46.0           | -10.9       | 1.14 V             | 134                  | 42.38            | -7.23                    |
| 6   | 658.51      | 37.3 QP                 | 46.0           | -8.7        | 1.62 V             | 240                  | 41.67            | -4.40                    |

**REMARKS:**

1. Emission Level(dBuV/m) = Raw Value(dBuV) + Correction Factor(dB/m)
2. Correction Factor(dB/m) = Antenna Factor(dB/m) + Cable Factor(dB) – Pre-Amplifier Factor(dB)
3. The other emission levels were very low against the limit.
4. Margin value = Emission Level – Limit value



## 4.2 CONDUCTED EMISSION MEASUREMENT

### 4.2.1 LIMITS OF CONDUCTED EMISSION MEASUREMENT

| FREQUENCY OF EMISSION (MHz) | CONDUCTED LIMIT (dB $\mu$ V) |          |
|-----------------------------|------------------------------|----------|
|                             | Quasi-peak                   | Average  |
| 0.15 ~ 0.5                  | 66 to 56                     | 56 to 46 |
| 0.5 ~ 5                     | 56                           | 46       |
| 5 ~ 30                      | 60                           | 50       |

- NOTE:** 1. The lower limit shall apply at the transition frequencies.  
 2. The limit decreases in line with the logarithm of the frequency in the range of 0.15 to 0.50MHz.

### 4.2.2 TEST INSTRUMENTS

| DESCRIPTION & MANUFACTURER                                       | MODEL NO.       | SERIAL NO.   | CALIBRATED DATE | CALIBRATED UNTIL |
|--|-----------------|--------------|-----------------|------------------|
| ROHDE & SCHWARZ<br>TEST RECEIVER                                 | ESCS 30         | 100276       | Jan. 07, 2013   | Jan. 06, 2014    |
| ROHDE & SCHWARZ<br>Artificial Mains Network<br>(for EUT)         | ESH3-Z5         | 100219       | Nov. 28, 2012   | Nov. 27, 2013    |
| LISN With Adapter<br>(for EUT)                                   | AD10            | C10Ada-001   | Nov. 28, 2012   | Nov. 27, 2013    |
| ROHDE & SCHWARZ<br>Artificial Mains Network<br>(for peripherals) | ESH3-Z5         | 100218       | Dec. 05, 2012   | Dec. 04, 2013    |
| Software   | ADT_Cond_V7.3.7 | NA           | NA              | NA               |
| Software   | ADT_ISN_V7.3.7  | NA           | NA              | NA               |
| RF cable (JYEBAO)  | 5D-FB           | Cable-C10.01 | Feb. 19, 2013   | Feb. 18, 2014    |
| SUHNER Terminator<br>(For ROHDE & SCHWARZ LISN)                  | 65BNC-5001      | E1-010773    | Feb. 06, 2013   | Feb. 05, 2014    |

- NOTE:** 1. The calibration interval of the above test instruments is 12 months and the calibrations are traceable to NML/ROC and NIST/USA.  
 2. The test was performed in Shielded Room No. 10.  
 3. The VCCI Site Registration No. C-1852.

### 4.2.3 TEST PROCEDURES

- a. The EUT was placed 0.4 meters from the conducting wall of the shielded room with EUT being connected to the power mains through a line impedance stabilization network (LISN). Other support units were connected to the power mains through another LISN. The two LISNs provide 50 ohm/ 50uH of coupling impedance for the measuring instrument.
- b. Both lines of the power mains connected to the EUT were checked for maximum conducted interference.
- c. The frequency range from 150kHz to 30MHz was searched. Emission levels under (Limit - 20dB) was not recorded.

**NOTE:** All modes of operation were investigated and the worst-case emissions are reported.

### 4.2.4 DEVIATION FROM TEST STANDARD

No deviation.

## 4.2.5 TEST SETUP

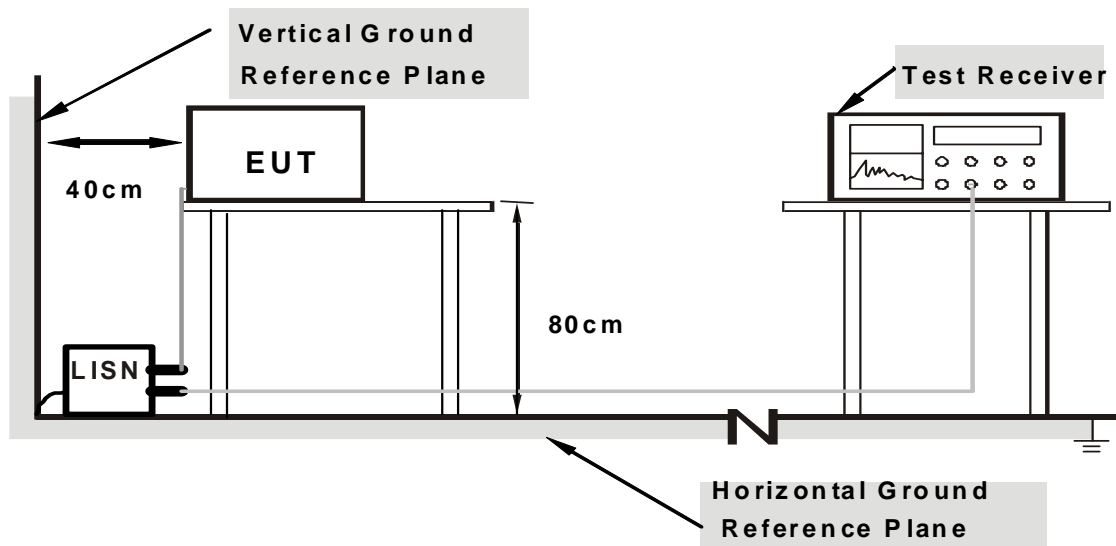

**Note: Support units were connected to second LISN.**

For the actual test configuration, please refer to the attached file (Test Setup Photo).

## 4.2.6 EUT OPERATING CONDITIONS

Same as item 4.1.6.

## 4.2.7 TEST RESULTS

### CONDUCTED WORST-CASE DATA : GFSK

|       |        |               |      |
|-------|--------|---------------|------|
| PHASE | Line 1 | 6dB BANDWIDTH | 9kHz |
|-------|--------|---------------|------|

| No       | Freq.<br>[MHz] | Corr.<br>Factor<br>(dB) | Reading Value<br>[dB (uV)] |              | Emission Level<br>[dB (uV)] |              | Limit<br>[dB (uV)] |              | Margin<br>(dB) |               |
|----------|----------------|-------------------------|----------------------------|--------------|-----------------------------|--------------|--------------------|--------------|----------------|---------------|
|          |                |                         | Q.P.                       | AV.          | Q.P.                        | AV.          | Q.P.               | AV.          | Q.P.           | AV.           |
|          | 1              | 0.15781                 | 0.14                       | 39.60        | 23.71                       | 39.74        | 23.85              | 65.58        | 55.58          | -25.84        |
| 2        | 0.29844        | 0.17                    | 29.65                      | 20.75        | 29.82                       | 20.92        | 60.29              | 50.29        | -30.47         | -29.37        |
| <b>3</b> | <b>0.51976</b> | <b>0.19</b>             | <b>38.50</b>               | <b>33.73</b> | <b>38.69</b>                | <b>33.92</b> | <b>56.00</b>       | <b>46.00</b> | <b>-17.31</b>  | <b>-12.08</b> |
| 4        | 2.23438        | 0.27                    | 27.41                      | 20.79        | 27.68                       | 21.06        | 56.00              | 46.00        | -28.32         | -24.94        |
| 5        | 3.52344        | 0.34                    | 24.98                      | 18.90        | 25.32                       | 19.24        | 56.00              | 46.00        | -30.68         | -26.76        |
| 6        | 13.64063       | 0.97                    | 28.02                      | 21.20        | 28.99                       | 22.17        | 60.00              | 50.00        | -31.01         | -27.83        |

#### REMARKS:

1. Q.P. and AV. are abbreviations of quasi-peak and average individually.
2. The emission levels of other frequencies were very low against the limit.
3. Margin value = Emission Level – Limit value
4. Correction Factor = Insertion loss + Cable loss
5. Emission Level = Correction Factor + Reading Value

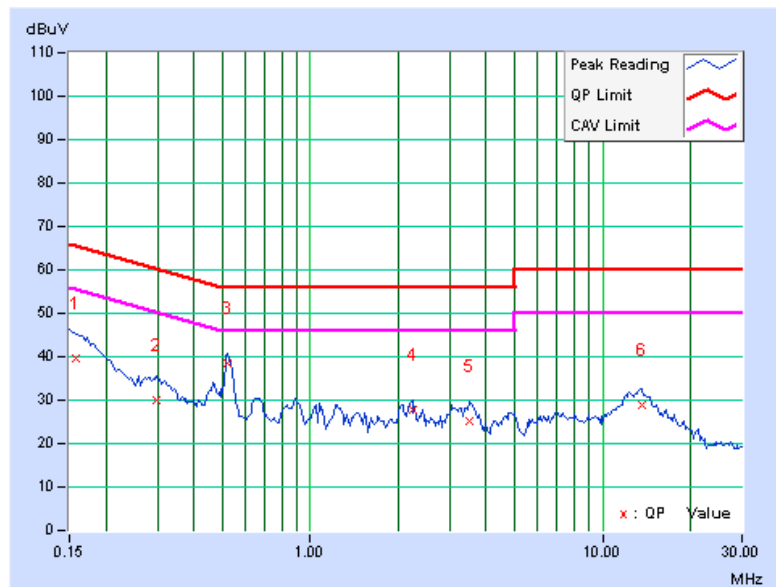



A D T

|       |        |               |      |
|-------|--------|---------------|------|
| PHASE | Line 2 | 6dB BANDWIDTH | 9kHz |
|-------|--------|---------------|------|

| No | Freq.<br>[MHz] | Corr.<br>Factor<br>(dB) | Reading Value<br>[dB (uV)] |       | Emission Level<br>[dB (uV)] |       | Limit<br>[dB (uV)] |       | Margin<br>(dB) |        |
|----|----------------|-------------------------|----------------------------|-------|-----------------------------|-------|--------------------|-------|----------------|--------|
|    |                |                         | Q.P.                       | AV.   | Q.P.                        | AV.   | Q.P.               | AV.   | Q.P.           | AV.    |
|    | 1              | 0.15391                 | 0.12                       | 42.69 | 25.77                       | 42.81 | 25.89              | 65.79 | 55.79          | -22.98 |
| 2  | 0.18125        | 0.12                    | 41.34                      | 28.16 | 41.46                       | 28.28 | 64.43              | 54.43 | -22.97         | -26.15 |
| 3  | 0.52109        | 0.16                    | 27.88                      | 23.60 | 28.04                       | 23.76 | 56.00              | 46.00 | -27.96         | -22.24 |
| 4  | 0.93125        | 0.17                    | 18.93                      | 12.12 | 19.10                       | 12.29 | 56.00              | 46.00 | -36.90         | -33.71 |
| 5  | 2.10938        | 0.22                    | 22.59                      | 16.20 | 22.81                       | 16.42 | 56.00              | 46.00 | -33.19         | -29.58 |
| 6  | 12.86328       | 0.72                    | 21.51                      | 15.45 | 22.23                       | 16.17 | 60.00              | 50.00 | -37.77         | -33.83 |

**REMARKS:**

1. Q.P. and AV. are abbreviations of quasi-peak and average individually.
2. The emission levels of other frequencies were very low against the limit.
3. Margin value = Emission Level – Limit value
4. Correction Factor = Insertion loss + Cable loss
5. Emission Level = Correction Factor + Reading Value

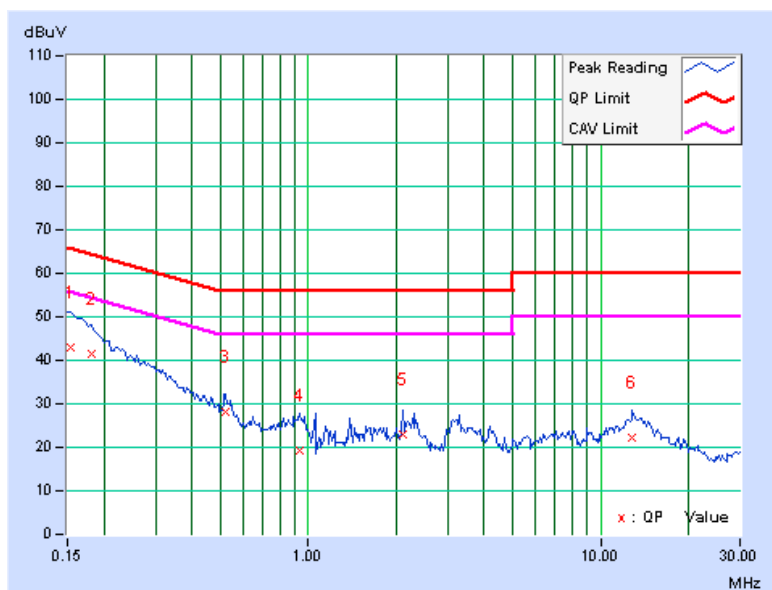

## 4.3 NUMBER OF HOPPING FREQUENCY USED

### 4.3.1 LIMIT OF HOPPING FREQUENCY USED

At least 15 channels frequencies, and should be equally spaced.

### 4.3.2 TEST SETUP

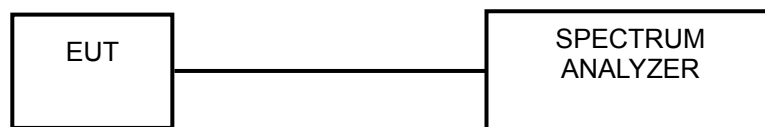

### 4.3.3 TEST INSTRUMENTS

Refer to section 4.1.2 to get information of above instrument.

### 4.3.4 TEST PROCEDURES

- a. Check the calibration of the measuring instrument (SA) using either an internal calibrator or a known signal from an external generator.
- b. Turn on the EUT and connect its antenna terminal to measurement via a low loss cable. Then set it to any one measured frequency within its operating range and make sure the instrument is operated in its linear range.
- c. Set the SA on MaxHold Mode, and then keep the EUT in hopping mode. Record all the signals from each channel until each one has been recorded.
- d. Set the SA on View mode and then plot the result on SA screen.
- e. Repeat above procedures until all frequencies measured were complete.

### 4.3.5 DEVIATION FROM TEST STANDARD

No deviation.

### 4.3.6 TEST RESULTS

There are 79 hopping frequencies in the hopping mode. Please refer to next two pages for the test result. On the plots, it shows that the hopping frequencies are equally spaced.



A D T

### GFSK

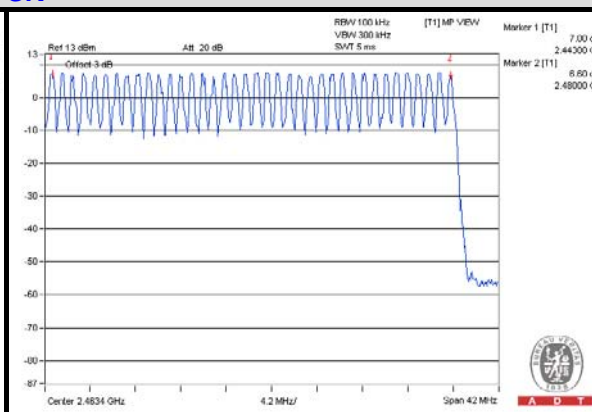
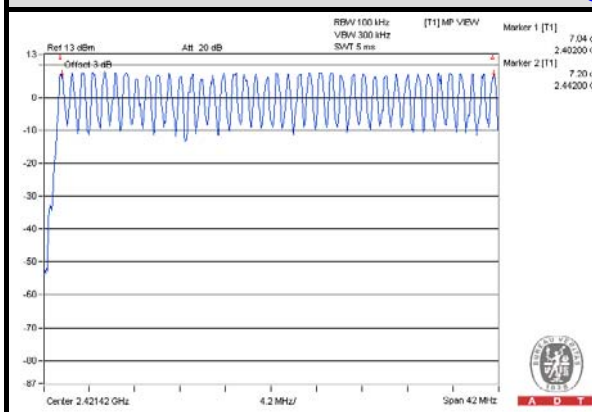

### 8DPSK

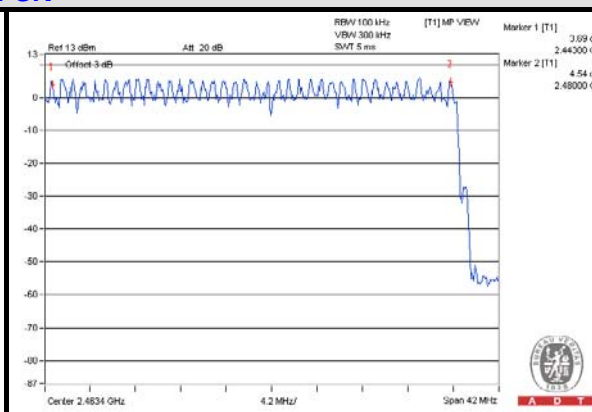
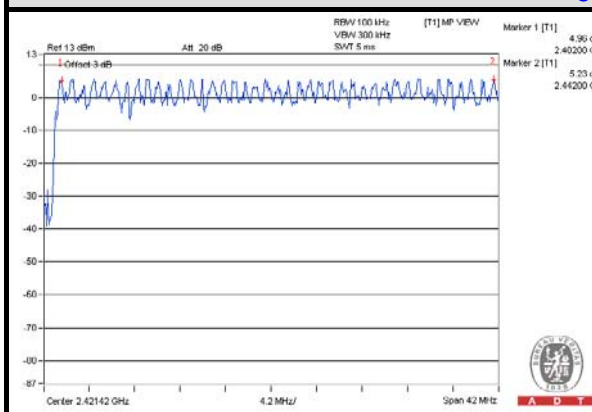

## 4.4 DWELL TIME ON EACH CHANNEL

### 4.4.1 LIMIT OF DWELL TIME USED

The average time of occupancy on any channel shall not be greater than 0.4 seconds within a period of 0.4 seconds multiplied by the number of hopping channels employed.

### 4.4.2 TEST SETUP

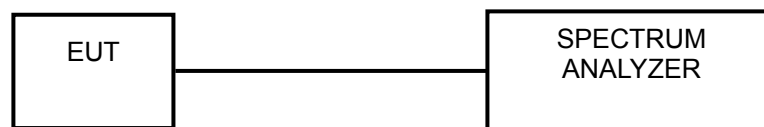

### 4.4.3 TEST INSTRUMENTS

Refer to section 4.1.2 to get information of above instrument.

### 4.4.4 TEST PROCEDURES

- a. Check the calibration of the measuring instrument (SA) using either an internal calibrator or a known signal from an external generator.
- b. Turn on the EUT and connect its antenna terminal to measurement via a low loss cable. Then set it to any one measured frequency within its operating range and make sure the instrument is operated in its linear range.
- c. Adjust the center frequency of SA on any frequency be measured and set SA to zero span mode. And then, set RBW and VBW of spectrum analyzer to proper value.
- d. Measure the time duration of one transmission on the measured frequency. And then plot the result with time difference of this time duration.
- e. Repeat above procedures until all different time-slot modes have been completed.

### 4.4.5 DEVIATION FROM TEST STANDARD

No deviation.





A D T

### 4.4.6 TEST RESULTS

#### GFSK

| Mode | Number of transmission in a 31.6 (79Hopping*0.4) | Length of transmission time (msec) | Result (msec) | Limit (msec) |
|------|--|------------------------------------|---------------|--------------|
| DH1  | 50 (times / 5 sec) * 6.32 = 316.00times          | 0.414                              | 130.82        | 400          |
| DH3  | 27 (times / 5 sec) * 6.32 = 170.64 times         | 1.692                              | 288.72        | 400          |
| DH5  | 17 (times / 5 sec) * 6.32 = 107.44 times         | 2.930                              | 314.80        | 400          |

NOTE: Test plots of the transmitting time slot are shown as below.

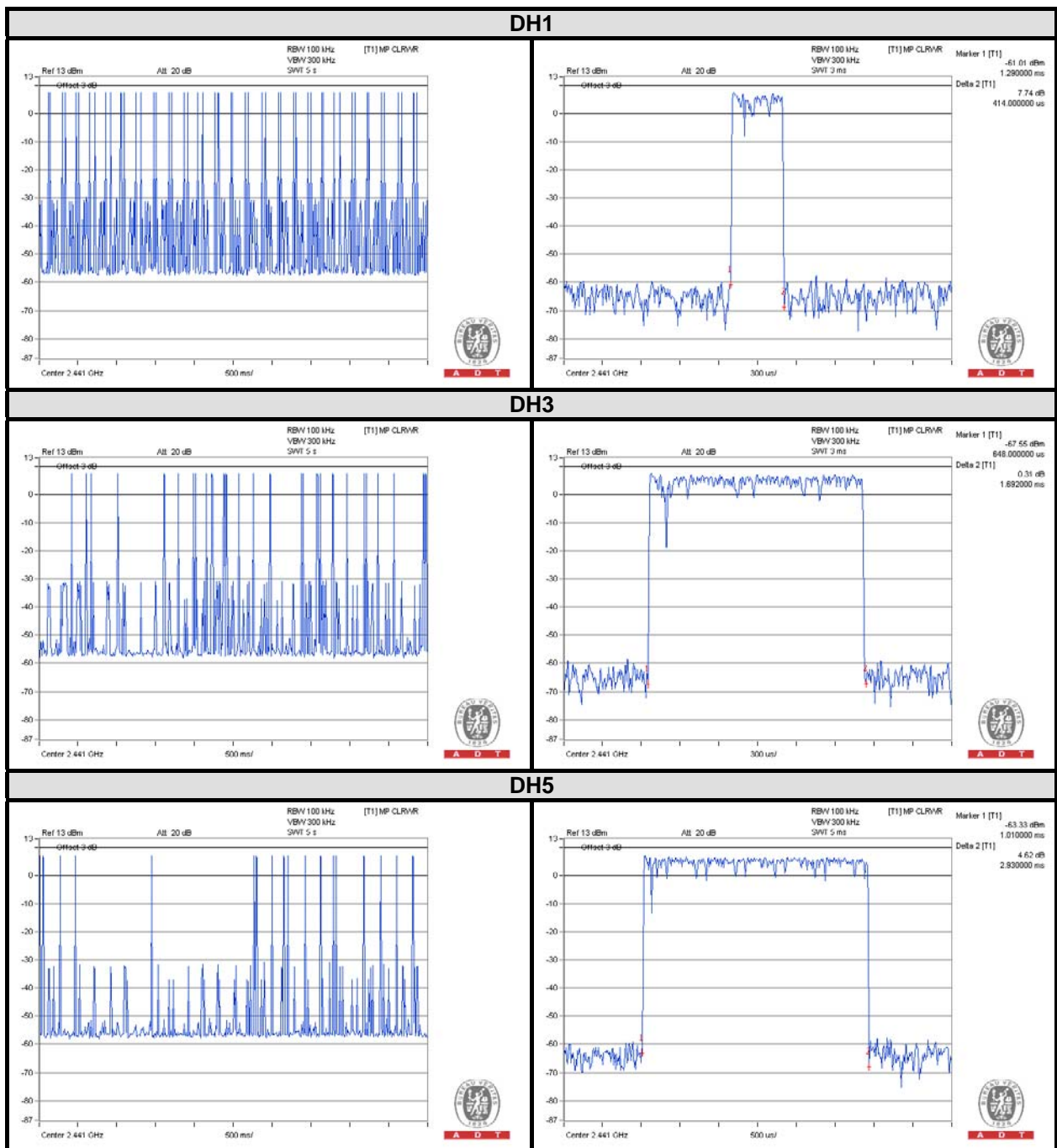



A D T

### 8DPSK

| Mode | Number of transmission in a 31.6 (79Hopping*0.4) | Length of transmission time (msec) | Result (msec) | Limit (msec) |
|------|--|------------------------------------|---------------|--------------|
| DH1  | 51 (times / 5 sec) * 6.32 = 322.32times          | 0.438                              | 141.18        | 400          |
| DH3  | 26 (times / 5 sec) * 6.32 = 164.32 times         | 1.686                              | 277.04        | 400          |
| DH5  | 17 (times / 5 sec) * 6.32 = 107.44 times         | 2.980                              | 320.17        | 400          |

NOTE: Test plots of the transmitting time slot are shown as below.

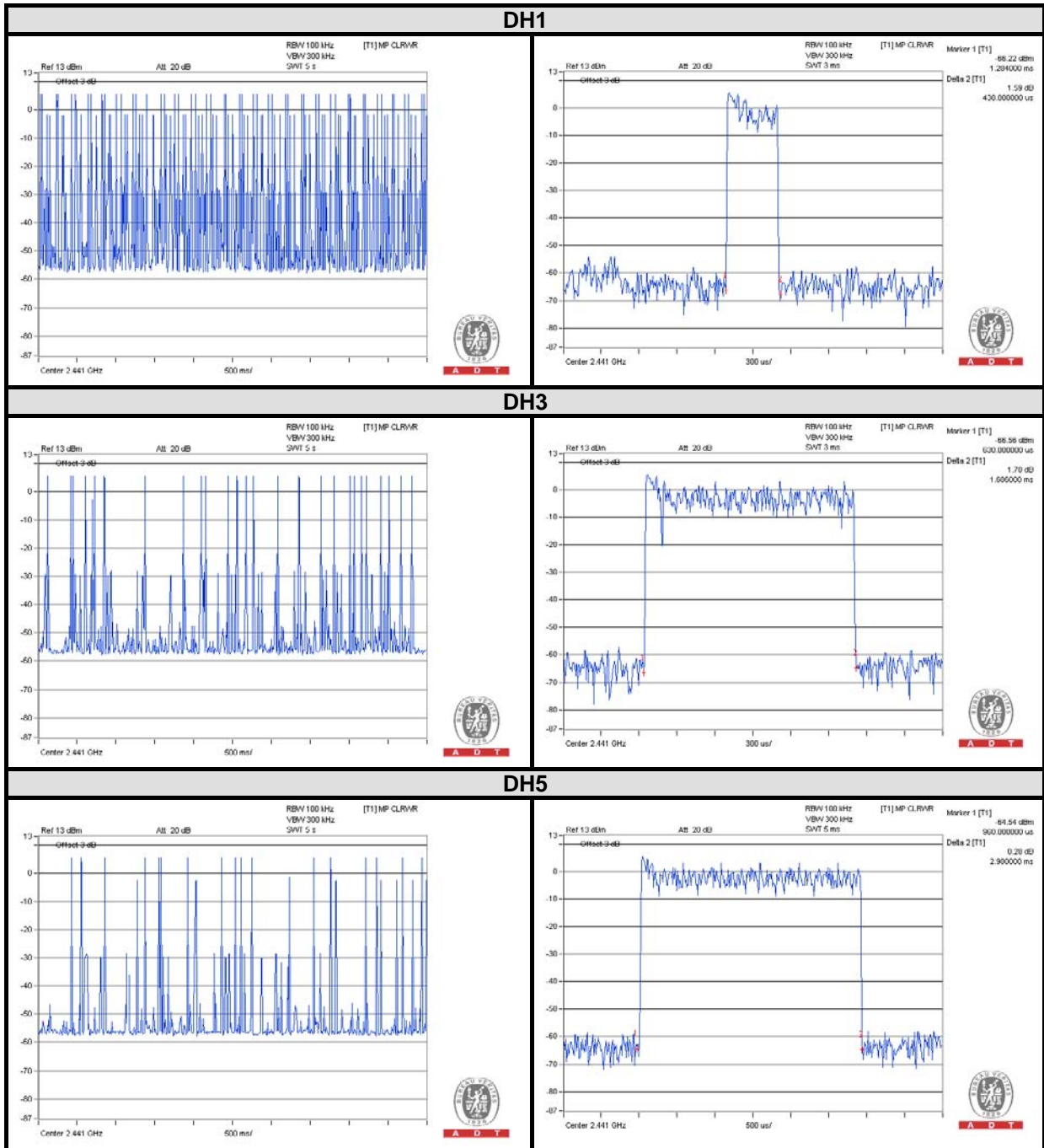

## 4.5 CHANNEL BANDWIDTH

### 4.5.1 LIMITS OF CHANNEL BANDWIDTH

For frequency hopping system operating in the 2400-2483.5MHz, If the 20dB bandwidth of hopping channel is greater than 25kHz, two-thirds 20dB bandwidth of hopping channel shall be a minimum limit for the hopping channel separation.

### 4.5.2 TEST SETUP

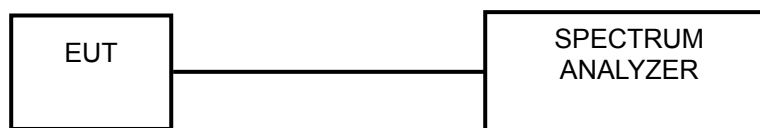

### 4.5.3 TEST INSTRUMENTS

Refer to section 4.1.2 to get information of above instrument.

### 4.5.4 TEST PROCEDURE

- a. Check the calibration of the measuring instrument using either an internal calibrator or a known signal from an external generator.
- b. Turn on the EUT and connect it to measurement instrument. Then set it to any one convenient frequency within its operating range. Set a reference level on the measuring instrument equal to the highest peak value.
- c. Measure the frequency difference of two frequencies that were attenuated 20dB from the reference level. Record the frequency difference as the emission bandwidth.
- d. Repeat above procedures until all frequencies measured were complete.

### 4.5.5 DEVIATION FROM TEST STANDARD

No deviation.

### 4.5.6 EUT OPERATING CONDITION

The software provided by client enabled the EUT to transmit and receive data at lowest, middle and highest channel frequencies individually.



A D T

### 4.5.7 TEST RESULTS

| CHANNEL | FREQUENCY (MHz) | 20dB BANDWIDTH (MHz) |       |
|---------|-----------------|----------------------|-------|
|         |                 | GFSK                 | 8DPSK |
| 0       | 2402            | 1.02                 | 1.25  |
| 39      | 2441            | 1.02                 | 1.27  |
| 78      | 2480            | 1.03                 | 1.25  |

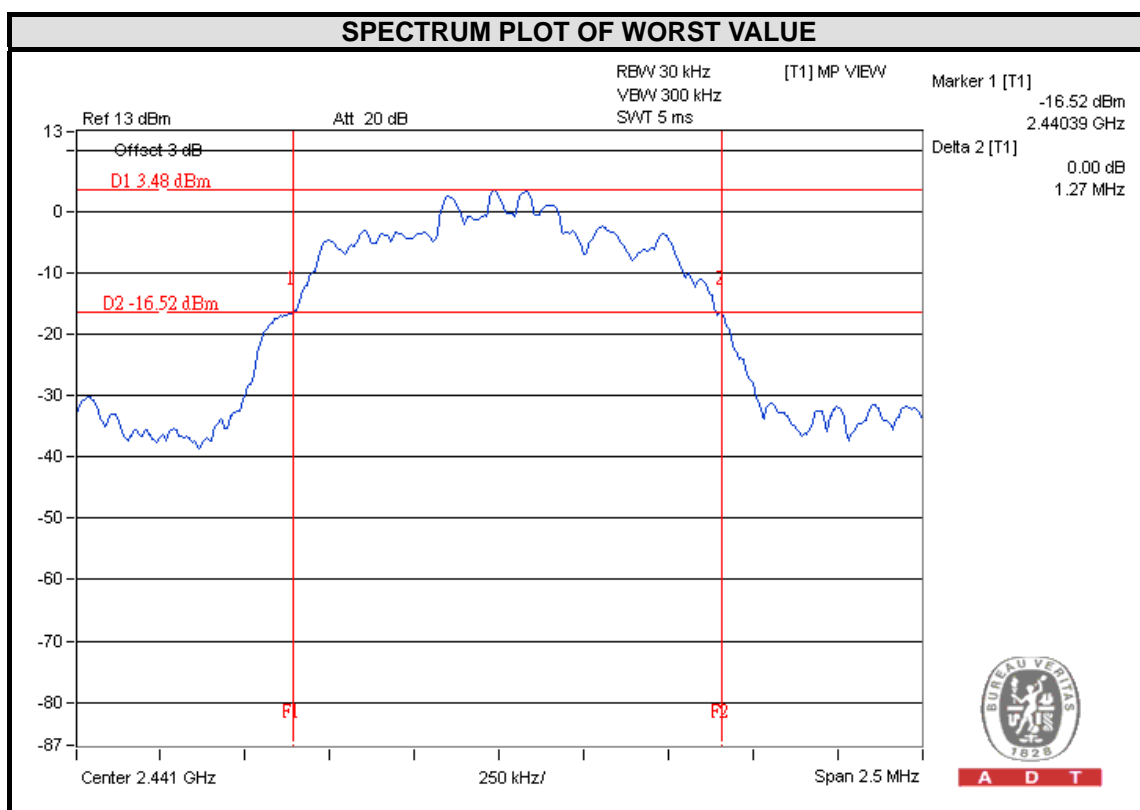

## 4.6 HOPPING CHANNEL SEPARATION

### 4.6.1 LIMIT OF HOPPING CHANNEL SEPARATION

At least 25kHz or two-third of 20dB hopping channel bandwidth (whichever is greater).

### 4.6.2 TEST SETUP

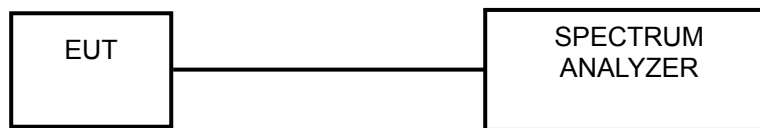

### 4.6.3 TEST INSTRUMENTS

Refer to section 4.1.2 to get information of above instrument.

### 4.6.4 TEST PROCEDURES

- a. Check the calibration of the measuring instrument using either an internal calibrator or a known signal from an external generator.
- b. Turn on the EUT and connect it to measurement instrument. Then set it to any one convenient frequency within its operating range.
- c. By using the MaxHold function record the separation of two adjacent channels.
- d. Measure the frequency difference of these two adjacent channels by SA MARK function. And then plot the result on SA screen.
- e. Repeat above procedures until all frequencies measured were complete.

### 4.6.5 DEVIATION FROM TEST STANDARD

No deviation.

### 4.6.6 TEST RESULTS

| CHANNEL | FREQUENCY (MHz) | ADJACENT CHANNEL SEPARATION (MHz) |       | 20dB BANDWIDTH (MHz) |       | MINIMUM LIMIT (MHz) |       | PASS / FAIL |
|---------|-----------------|-----------------------------------|-------|----------------------|-------|---------------------|-------|-------------|
|         |                 | GFSK                              | 8DPSK | GFSK                 | 8DPSK | GFSK                | 8DPSK |             |
| 0       | 2402            | 1.00                              | 1.00  | 1.02                 | 1.25  | 0.68                | 0.83  | PASS        |
| 39      | 2441            | 1.00                              | 1.01  | 1.02                 | 1.27  | 0.68                | 0.85  | PASS        |
| 78      | 2480            | 1.01                              | 1.00  | 1.03                 | 1.25  | 0.69                | 0.83  | PASS        |

**NOTE:** The minimum limit is two-third 20dB bandwidth.

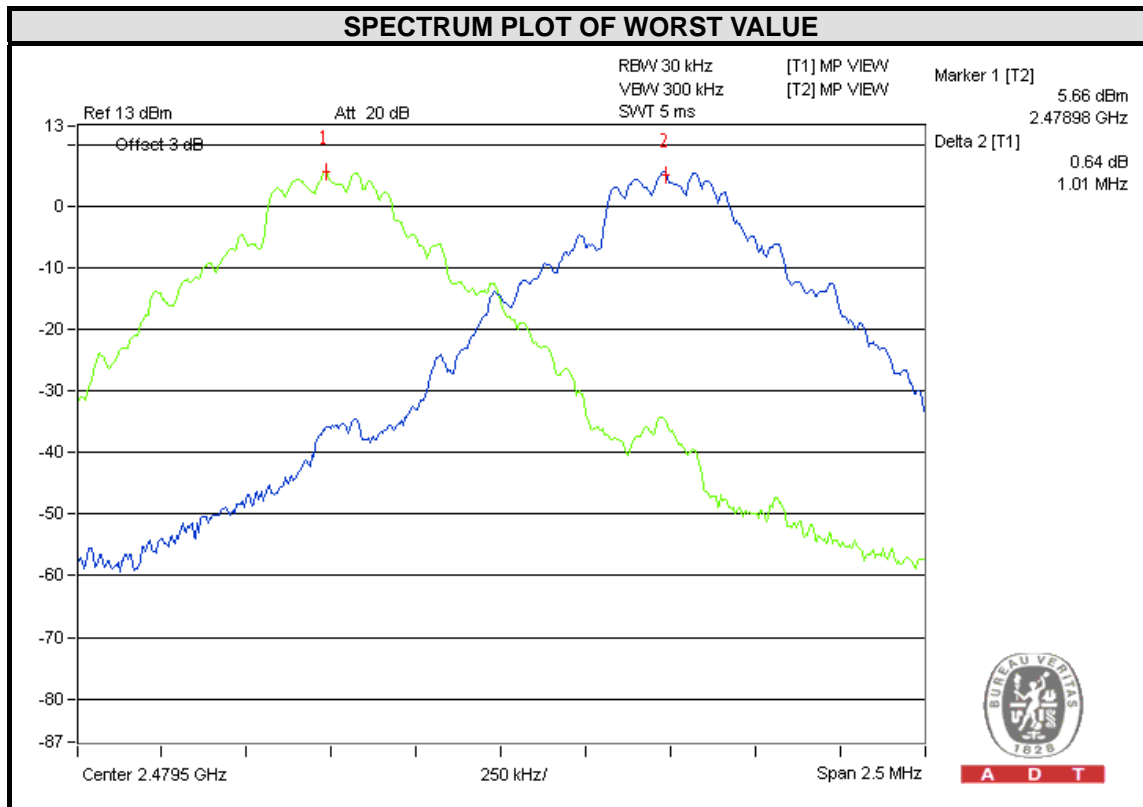

## 4.7 MAXIMUM OUTPUT POWER

### 4.7.1 LIMITS OF MAXIMUM OUTPUT POWER MEASUREMENT

The Maximum Output Power Measurement is 125mW.

### 4.7.2 TEST SETUP

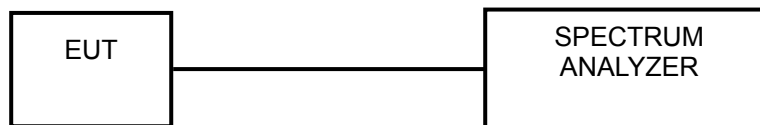

### 4.7.3 TEST INSTRUMENTS

Refer to section 4.1.2 to get information of above instrument.

### 4.7.4 TEST PROCEDURES

- a. Check the calibration of the measuring instrument using either an internal calibrator or a known signal from an external generator.
- b. Turn on the EUT and connect it to measurement instrument. Then set it to any one convenient frequency within its operating range. Set a reference level on the measuring instrument equal to the highest peak value.
- c. The center frequency of the spectrum analyzer is set to the fundamental frequency and using 3MHz RBW and 10 MHz VBW.
- d. Measure the captured power within the band and recording the plot.
- e. Repeat above procedures until all frequencies required were complete.

### 4.7.5 DEVIATION FROM TEST STANDARD

No deviation.

### 4.7.6 EUT OPERATING CONDITION

The software provided by client enabled the EUT to transmit and receive data at lowest, middle and highest channel frequencies individually.



A D T

### 4.7.7 TEST RESULTS

| CHANNEL | FREQUENCY (MHz) | OUTPUT POWER (dBm) |       | OUTPUT POWER (mW) |       | POWER LIMIT (mW) | PASS / FAIL |
|---------|-----------------|--------------------|-------|-------------------|-------|------------------|-------------|
|         |                 | GFSK               | 8DPSK | GFSK              | 8DPSK |                  |             |
| 0       | 2402            | 8.4                | 8.1   | <b>6.9</b>        | 6.5   | 125              | PASS        |
| 39      | 2441            | 8.0                | 8.0   | 6.3               | 6.3   | 125              | PASS        |
| 78      | 2480            | 8.1                | 8.2   | 6.5               | 6.6   | 125              | PASS        |

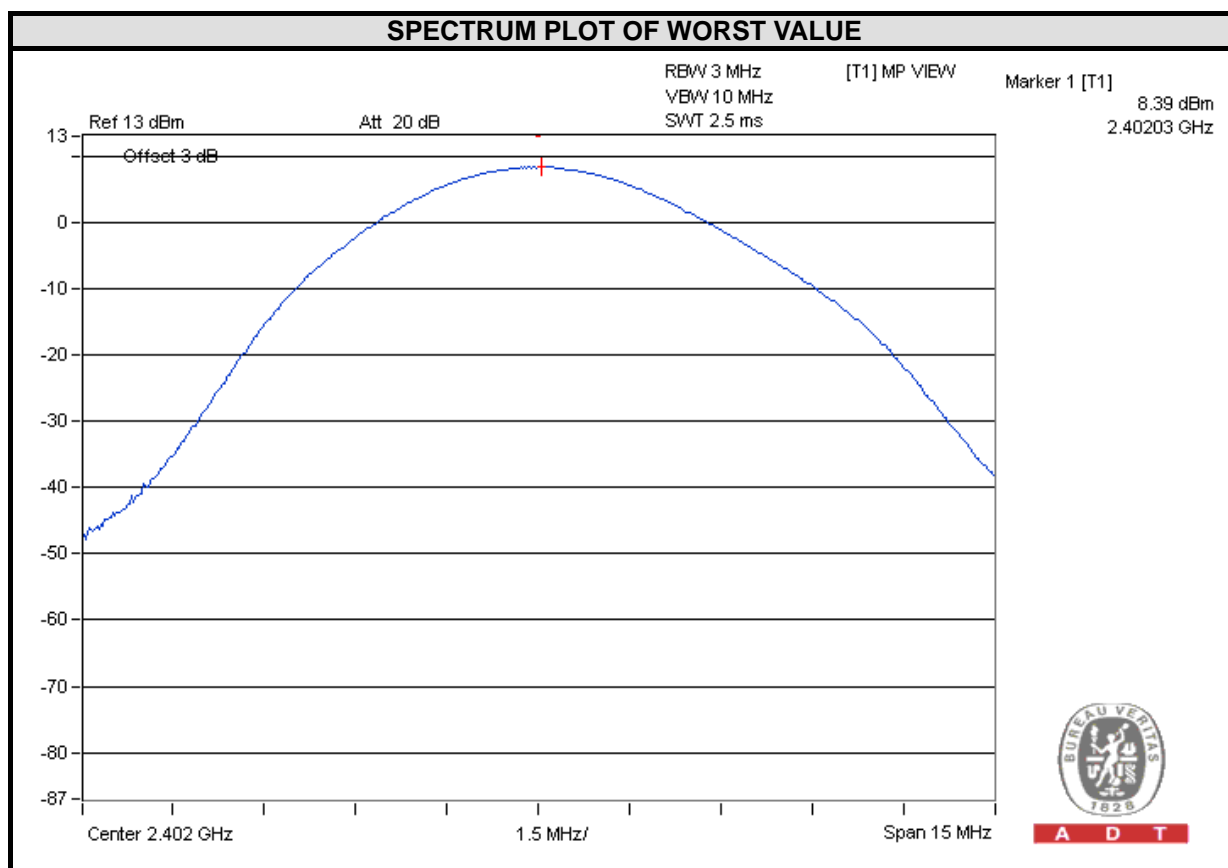



## **4.8 CONDUCTED OUT OF BAND EMISSION MEASUREMENT**

### **4.8.1 LIMITS OF CONDUCTED OUT OF BAND EMISSION MEASUREMENT**

Below  $-20\text{dB}$  of the highest emission level of operating band (in 100KHz RBW).

### **4.8.2 TEST INSTRUMENTS**

Refer to section 4.1.2 to get information of above instrument.

### **4.8.3 TEST PROCEDURE**

The transmitter output was connected to the spectrum analyzer via a low lose cable. Set both RBW and VBW of spectrum analyzer to 100 kHz and 300 kHz with suitable frequency span including 100 MHz bandwidth from band edge. The band edges was measured and recorded.

### **4.8.4 DEVIATION FROM TEST STANDARD**

No deviation.

### **4.8.5 EUT OPERATING CONDITION**

The software provided by client enabled the EUT to transmit and receive data at lowest, middle and highest channel frequencies individually.

### **4.8.6 TEST RESULTS**

The spectrum plots are attached on the following images. D1 line indicates the highest level, D2 line indicates the 20dB offset below D1. It shows compliance with the requirement.



A D T

### GFSK

#### Hopping disabled\_ Low Channel

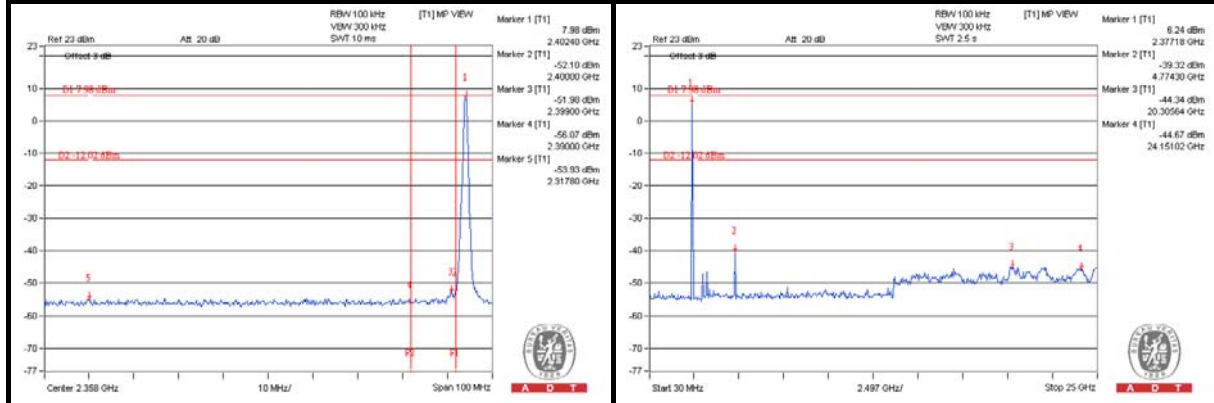

#### Hopping disabled\_ High Channel

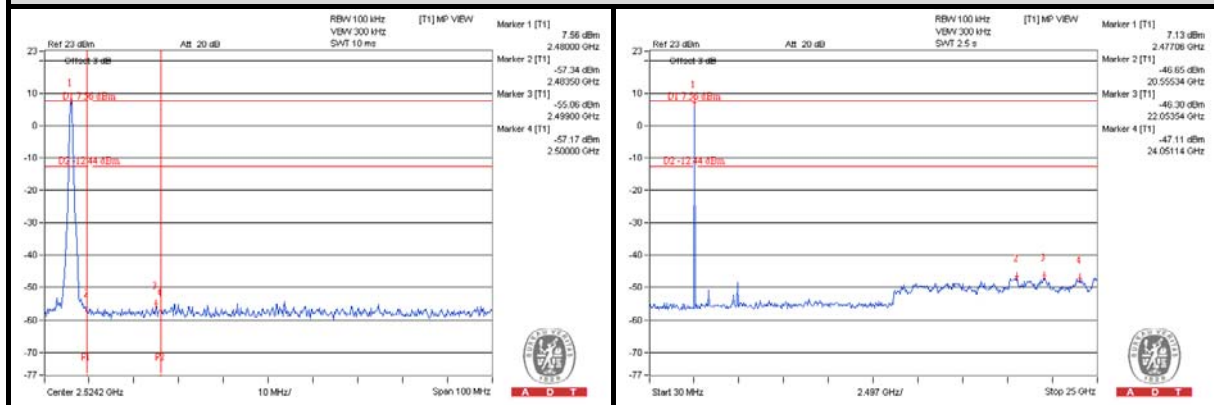

#### Hopping enabled\_ Low Channel

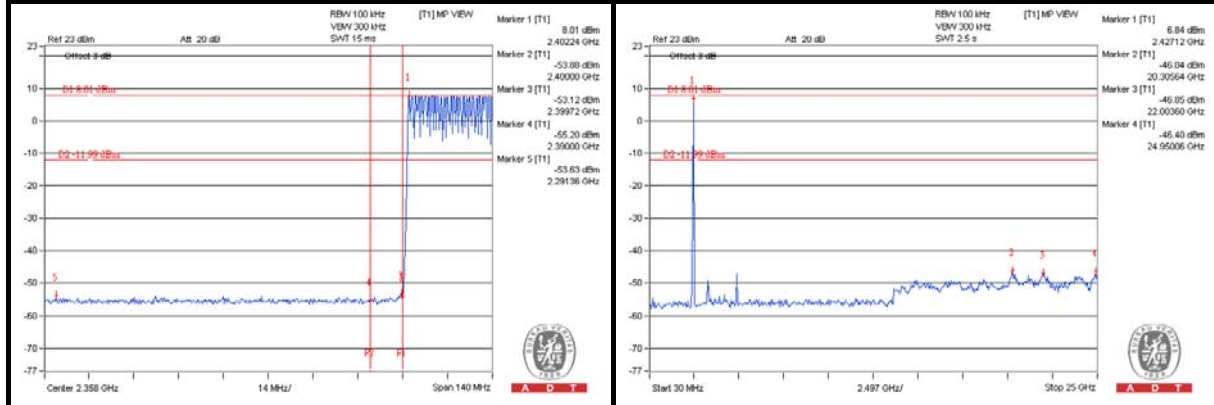

#### Hopping enabled\_ High Channel

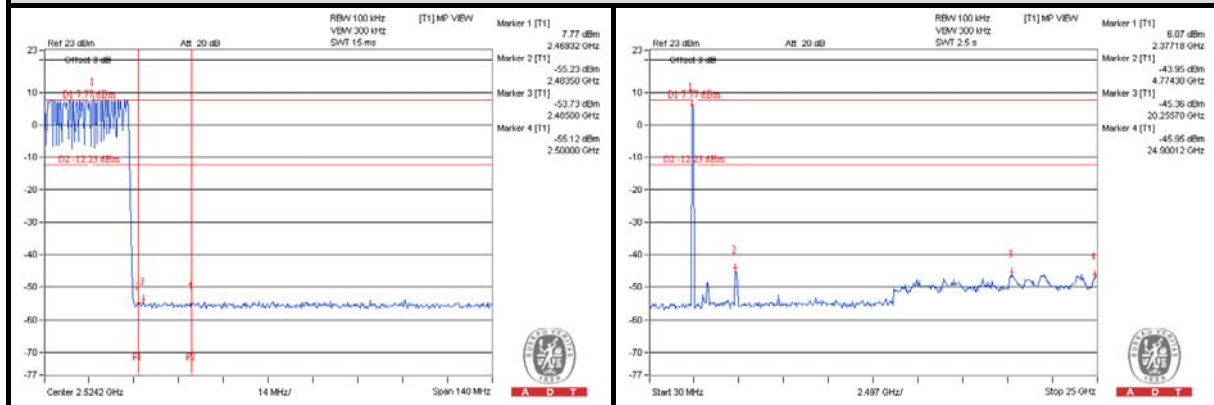



A D T

### 8DPSK

#### Hopping disabled \_ Low Channel

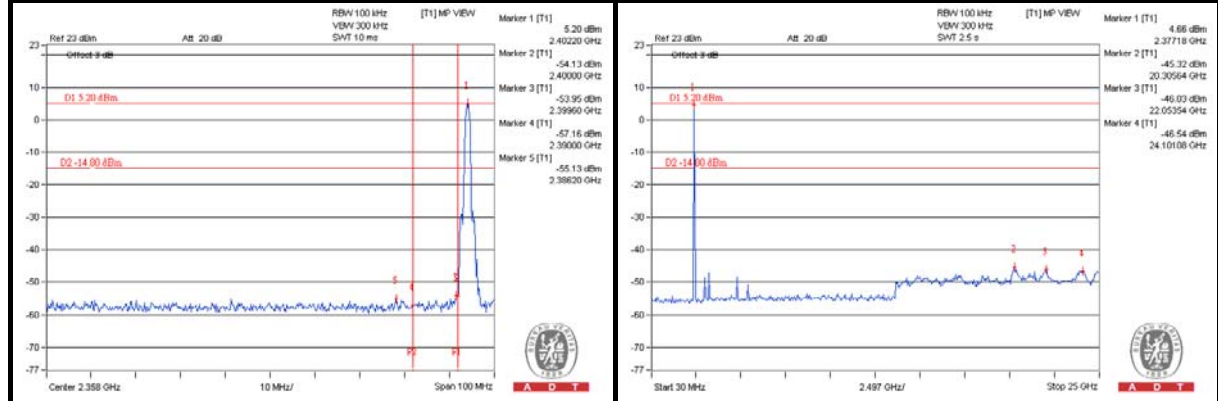

#### Hopping disabled \_ High Channel

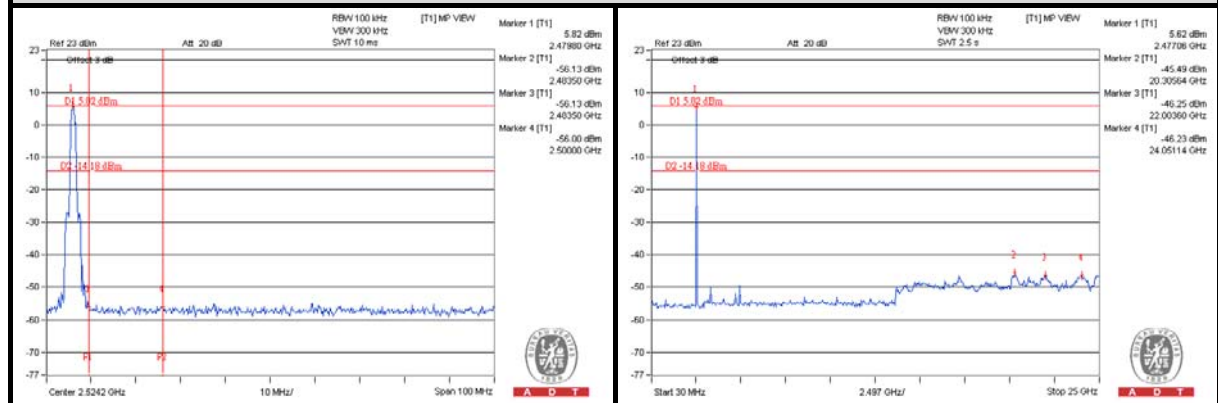

#### Hopping enabled \_ Low Channel

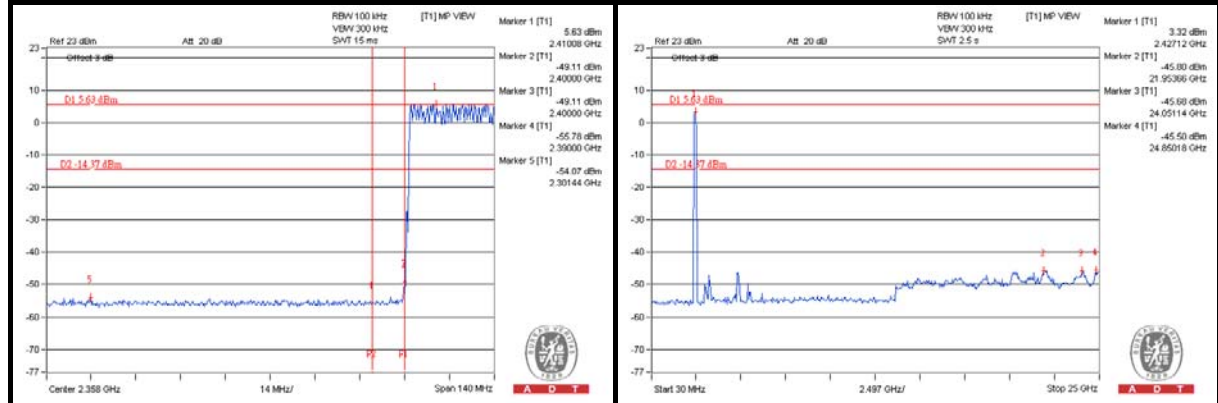

#### Hopping enabled \_ High Channel

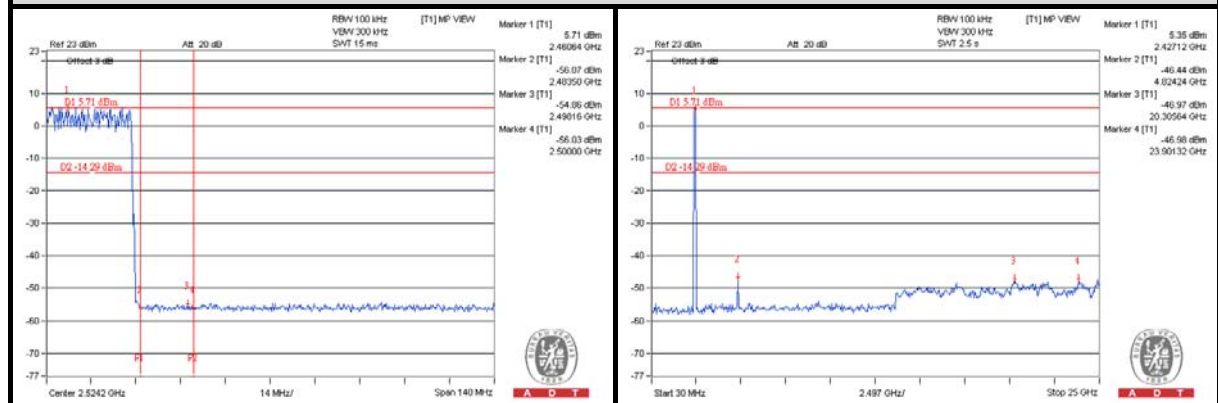



A D T

## 5. PHOTOGRAPHS OF THE TEST CONFIGURATION

Please refer to the attached file (Test Setup Photo).



## 6. INFORMATION ON THE TESTING LABORATORIES

We, Bureau Veritas Consumer Products Services (H.K.) Ltd., Taoyuan Branch, were founded in 1988 to provide our best service in EMC, Radio, Telecom and Safety consultation. Our laboratories are accredited and approved according to ISO/IEC 17025.

If you have any comments, please feel free to contact us at the following:

**Linko EMC/RF Lab:**

Tel: 886-2-26052180

Fax: 886-2-26051924

**Hsin Chu EMC/RF Lab:**

Tel: 886-3-5935343

Fax: 886-3-5935342

**Hwa Ya EMC/RF/Safety/Telecom Lab:**

Tel: 886-3-3183232

Fax: 886-3-3270892

**Email:** [service.adt@tw.bureauveritas.com](mailto:service.adt@tw.bureauveritas.com)

**Web Site:** [www.bureauveritas-adt.com](http://www.bureauveritas-adt.com)

The address and road map of all our labs can be found in our web site also.



A D T

## **7. APPENDIX A - MODIFICATIONS RECORDERS FOR ENGINEERING CHANGES TO THE EUT BY THE LAB**

No modifications were made to the EUT by the lab during the test.

--- END ---