



**KTL**  
part of TRAC global

## Test report

**KTL EMC Test Report** : 7F1040WUS5

**Applicant** : AlertMe.com Ltd

**Apparatus** : Wireless Motion Detector 1-1

**Authorised by** :

: K J Anderson, Senior EMC and Radio Engineer

**Issue Date** : 9<sup>th</sup> September 2008

**Authorised Copy Number** : PDF

Total number of pages : 62

**Contents**

Section 1:	Introduction	3
	1.1 General	3
	1.2 Tests Requested By	4
	1.3 Manufacturer	4
	1.4 Apparatus Assessed	4
	1.5 Test Result Summary	5
	1.6 Notes Relating To The Assessment	6
	1.7 Deviations from Test Standards	6
Section 2:	Measurement Uncertainty	7
	2.1 Application of Measurement Uncertainty	7
	2.2 KTL Measurement Uncertainty Values	8
Section 3:	Modifications	9
	3.1 Modifications Performed During Assessment	9
Appendix A:	Formal Emission Test Results	10
	A1 Conducted Fundamental Carrier Power	11
	A2 RF Antenna Conducted Spurious Emissions	12
	A3 Radiated Electric Field Emissions Within The Restricted Band 15.205	16
	A4 6 dB Bandwidth	21
	A5 Antenna Gain	22
	A6 Power Spectral Density	23
Appendix B:	Supporting Graphical Data	24
Appendix C:	Additional Test and Sample Details	43
Appendix D:	Additional Information	50
Appendix E:	Calculation of the duty cycle correction factor	53
Appendix F:	Photographs and Figures	54
Appendix G:	MPE Calculation	61

**Section 1:**

**Introduction**

**1.1 General**

This report contains an assessment of an apparatus against Electromagnetic Compatibility Standards based upon tests carried out on samples submitted to the Laboratory.

Test performed by:

KTL  
Unit E  
South Orbital Trading Park  
Hedon Road  
Hull, HU9 1NJ.  
United Kingdom.

Telephone: +44 (0) 1482 801801  
Fax: +44 (0) 1482 801806  
Email: [ktl@ktl.com](mailto:ktl@ktl.com)  
Web site: [www.ktl.com](http://www.ktl.com)

Tests performed by:



, Senior EMC and Radio Group Engineer

Report author:.

As Above

**This report must not be reproduced except in full without prior written permission from KTL.**

## **1.2 Tests Requested By**

This testing in this report was requested by :

AlertMe.com Ltd  
27-28 Bridge Street  
Cambridge  
CB21UJ  
United Kingdom

## **1.3 Manufacturer**

In-Tech Electronics Ltd  
N2 Qihang Industrial Park  
Haoxiang Road  
Sha Jing Town  
Bao An  
Shenzhen  
PRC

## **1.4 Apparatus Assessed**

The following apparatus was assessed between 16/06/08 and 07/07/08:

Alertme WIRELESS MOTION DETECTOR 1-1 detector

The above equipment was a wireless Alertme Motion Detector 1-1 as part of an intelligent home security and monitoring service operating in the 2.4GHz band.

## 1.5 Test Result Summary

Full details of test results are contained within Appendix A. The following table summarises the results of the assessment.

The statements relating to compliance with the standards below apply ONLY as qualified in the notes and deviations stated in sections 1.6 to 1.7 of this test report.

Full details of test results are contained within Appendix A. The following table summarises the results of the assessment.

Test Type	Regulation	Measurement standard	Result
CFCP	Title 47 of the CFR :2008, Part 15 Subpart (c) 15.247(b)(3)	ANSI C63.4: 2003	Pass
RF Antenna Port Conducted Spurious Emissions	Title 47 of the CFR: 2008, Part 15 Subpart (c) 15.247(d)	ANSI C63.4: 2003	Pass
REFE (Within the restricted band)	Title 47 of the CFR: 2008, Part 15 Subpart (c) 15.247(d) and 15.205	ANSI C63.4: 2003	Pass
PLCE	Title 47 of the CFR: 2008, Part 15 Subpart (c) 15.207	ANSI C63.4: 2003	N/A
6dB Bandwidth	Title 47 of the CFR :2008, Part 15 Subpart (c) 15.247(a)(2)	ANSI C63.4: 2003	Pass
Antenna Gain	Title 47 of the CFR :2008, Part 15 Subpart (c) 15.247(b)(4)	ANSI C63.4: 2003	Pass
Power Spectral Density	Title 47 of the CFR :2008, Part 15 Subpart (c) 15.247(e)	ANSI C63.4: 2003	Pass

Abbreviations used in the above table:

Mod	: Modification	ANSI	: American National Standards Institution
CFR	: Code of Federal Regulations	PLCE	: Power Line Conducted Emissions
REFE	: Radiated Electric Field Emissions		
CFCP	: Conducted Fundamental Carrier Power		

## 1.6 Notes Relating To The Assessment

With regard to this assessment, the following points should be noted:

The results contained in this report relate only to the items tested and were obtained in the period between the date of initial receipt of samples and the date of issue of the report.

The apparatus was set up and exercised using the configurations, modes of operation and arrangements defined in this report only.

Particular operating modes, apparatus monitoring methods and performance criteria required by the standards tested to have been performed except where identified in Section 1.7 of this test report (Deviations from Test Standards).

For emissions testing, throughout this test report, "Pass" indicates that the results for the sample as tested were below the specified limit (refer also to Section 2, Measurement Uncertainty).

Where relevant, the apparatus was only assessed using the monitoring methods and susceptibility criteria defined in this report.

All testing with the exception of testing at the Open Area Test Site was performed under the following environmental conditions:

Temperature	: 17 to 23 °C
Humidity	: 45 to 75 %
Barometric Pressure	: 86 to 106 kPa

All dates used in this report are in the format dd/mm/yy.

This assessment has been performed in accordance with the requirements of ISO/IEC 17025.

KTL Hull is a listed electromagnetic compatibility Conformance Assessment Body (CAB) for EC access to the US market. (Decision No 3/2000 of the Joint Committee established under the Agreement on Mutual Recognition between the European Community and the United States of America. This decision was effective from 16<sup>th</sup> January 2001).

FCC Facility Registration number (3m semi anechoic chamber) : 90743

## 1.7 Deviations from Test Standards

There were no deviations from the standards tested to.

## Section 2:

## Measurement Uncertainty

### 2.1 Application of Measurement Uncertainty

The following table contains the measurement uncertainties for KTL measurements

The following procedure is used when determining the result of a measurement :

- (i) If specification limits are not exceeded by the measured result, extended by the positive component of the expanded uncertainty interval at a confidence level of 95%, then a pass result is recorded.
- (ii) Where a specification limit is exceeded by the result even when the result is decreased by the negative component of the expanded uncertainty interval, a fail result is recorded.
- (iii) Where measured result is below a limit, but by a margin less than the positive measurement uncertainty component, it is not possible to record a pass based on a 95% confidence level. However, the result indicates that a pass result is more probable than a fail result.
- (iv) Where a measured result is above a limit, but by a margin less than the negative measurement uncertainty component, it is not possible to record a fail based on a 95% confidence level. However the result indicates that a fail is more probable than a pass.

## **2.2 KTL Measurement Uncertainty Values**

All results were recorded in accordance with Section 2.1(i).



**Section 3:**

**Modifications**

**3.1 Modifications Performed During Assessment**

No modifications were performed during the assessment

## Appendix A:

## Formal Emission Test Results

Abbreviations used in the tables in this appendix:

Spec	: Specification	ALSR	: Absorber Lined Screened Room
Mod	: Modification	OATS	: Open Area Test Site
EUT	: Equipment Under Test	ATS	: Alternative Test Site
SE	: Support Equipment		
		Ref	: Reference
		Freq	: Frequency
		MD	: Measurement Distance
L	: Live Power Line	SD	: Spec Distance
N	: Neutral Power Line		
E	: Earth Power Line	Pol	: Polarisation
		H	: Horizontal Polarisation
Pk	: Peak Detector	V	: Vertical Polarisation
QP	: Quasi-Peak Detector		
Av	: Average Detector	CDN	: Coupling & decoupling network

**A1 Conducted Fundamental Carrier Power**

Conducted carrier power was verified using a peak power meter, the EUT transmitting on its lowest, centre and highest carrier frequency in turn.

Test Details:	
Regulation	Title 47 of the CFR 2008, Part15 Subpart (c) 15.247(b)(3)
EUT sample number	S07
Modification state	0
SE in test environment	S02 and S03
SE isolated from EUT	None
EUT set up	Refer to Appendix C

Channel No	Channel Frequency (MHz)	Measured Peak Conducted Carrier Power (W)	Limit (W)	Result
11	2405	0.001368	1	Pass
18	2440	0.001556		Pass
25	2475	0.001755		Pass

**Note**

For battery-operated equipment, the test was performed using a new battery as required by 15.31(e).

## A2 RF Antenna Conducted Spurious Emissions

Measurement of conducted spurious emissions at the antenna port was performed using a peak detector with the RBW set to 100kHz and the VBW>RBW. Frequencies were scanned up through to the 10th harmonic with the EUT transmitting on its lowest, centre and highest carrier frequency in turn.

Test Details CH11	
Regulation	Title 47 of the CFR 2008, Part 15 Subpart (c) Clause 15.247(d) and Clause 15.205
Measurement standard	ANSI C63.4:2003
Frequency range	9 kHz to 25 GHz
EUT sample number	S07
Modification state	0
SE in test environment	S02 and S03
SE isolated from EUT	None
EUT set up	Refer to Appendix C

The worst case conducted emission measurements at the antenna port are listed below:

Ref No.	Measured Freq (MHz)	Det.	Is measured Frequency within the Restricted bands (Y/N)	Measured Peak Conducted power (RBW =100kHz) (dBuV)	15.247(d) Limit (dBuV)	Summary
1	0.00945	Pk	N	15.42	88.36	Pass
2	0.0155	Pk	N	14.08	88.36	Pass
3	0.0706	Pk	N	11.19	88.36	Pass
4	0.150	Pk	N	32.65	88.36	Pass
5	0.484	Pk	N	31.17	88.36	Pass
6	1.154	Pk	N	30.64	88.36	Pass
7	120.176	Pk	Y	35.77	N/A	See Section A3
8	144.150	Pk	N	32.67	88.36	Pass
9	169.214	Pk	Y	31.99	N/A	See Section A3
10	192.371	Pk	N	33.34	88.36	Pass
11	397.435	Pk	N	37.07	88.36	Pass
12	2285.576	Pk	Y	39.30	N/A	See Section A3
13	2390.000	Pk	Y	44.17	N/A	See Section A3
14	2400.000	Pk	N	62.01	88.36	Pass
15	2483.500	Pk	Y	33.31	N/A	See Section A3
16	2500.512	Pk	N	38.26	88.36	Pass
16	2524.236	Pk	N	41.59	88.36	Pass
17	2549.620	Pk	N	39.50	88.36	Pass
18	4807.692	Pk	Y	65.24	N/A	See Section A3
19	7211.538	Pk	N	53.78	88.36	Pass
20	19471.153	Pk	Y	39.02	N/A	See Section A3

**RF Antenna Conducted Spurious Emissions continued:**

<b>Test Details CH18</b>	
Regulation	Title 47 of the CFR 2008, Part 15 Subpart (c) Clause 15.247(d) and Clause 15.205
Measurement standard	ANSI C63.4:2003
Frequency range	9 kHz to 25 GHz
EUT sample number	S07
Modification state	0
SE in test environment	S02 and S03
SE isolated from EUT	None
EUT set up	Refer to Appendix C

The worst case conducted emission measurements at the antenna port are listed below:

Ref No.	Measured Freq (MHz)	Det.	Is measured Frequency within the Restricted bands (Y/N)	Measured Peak Conducted power (RBW =100kHz) (dBuV)	15.247(d) Limit (dBuV)	Summary
1	0.0090	Pk	N	15.78	88.92	Pass
2	0.0205	Pk	N	13.48	88.92	Pass
3	0.07069	Pk	N	12.67	88.92	Pass
4	0.150	Pk	N	33.21	88.92	Pass
5	1.154	Pk	N	28.39	88.92	Pass
6	15.696	Pk	N	27.90	88.92	Pass
7	120.176	Pk	Y	29.29	N/A	See Section A3
8	192.099	Pk	N	31.30	88.92	Pass
9	762.820	Pk	N	36.48	88.92	Pass
10	2321.474	Pk	Y	39.57	N/A	See Section A3
11	2390.000	Pk	Y	37.21	N/A	See Section A3
12	2400.000	Pk	N	33.07	88.92	Pass
13	2483.500	Pk	Y	33.33	N/A	See Section A3
14	2488.360	Pk	Y	39.68	N/A	See Section A3
15	2510.233	Pk	N	38.57	88.92	Pass
16	2558.838	Pk	N	42.17	88.92	Pass
17	2583.141	Pk	N	39.19	88.92	Pass
18	4875.000	Pk	Y	62.36	N/A	See Section A3
19	7317.307	Pk	Y	57.34	N/A	See Section A3
20	19599.358	Pk	Y	39.52	N/A	See Section A3

**RF Antenna Conducted Spurious Emissions continued:**

Test Details CH25	
Regulation	Title 47 of the CFR 2008, Part 15 Subpart (c) Clause 15.247(d) and Clause 15.205
Measurement standard	ANSI C63.4:2003
Frequency range	9 kHz to 25 GHz
EUT sample number	S07
Modification state	0
SE in test environment	S02 and S03
SE isolated from EUT	None
EUT set up	Refer to Appendix C

The worst case conducted emission measurements at the antenna port are listed below:

Ref No.	Measured Freq (MHz)	Det.	Is measured Frequency within the Restricted bands (Y/N)	Measured Peak Conducted power (RBW =100kHz) (dBuV)	15.247(d) Limit (dBuV)	Summary
1	0.0117	Pk	N	14.50	89.44	Pass
2	0.0214	Pk	N	11.77	89.44	Pass
3	0.07069	Pk	N	10.77	89.44	Pass
4	0.150	Pk	N	33.86	89.44	Pass
5	0.437	Pk	N	31.64	89.44	Pass
6	120.176	Pk	Y	30.73	N/A	See Section A3
7	544.871	Pk	N	36.89	89.44	Pass
8	2357.371	Pk	Y	39.05	N/A	See Section A3
9	2390.000	Pk	Y	35.44	N/A	See Section A3
10	2400.000	Pk	N	36.20	89.44	Pass
11	2483.500	Pk	Y	53.42	N/A	See Section A3
12	2485.930	Pk	Y	55.24	N/A	See Section A3
13	2522.384	Pk	N	43.63	89.44	Pass
14	2546.687	Pk	N	48.09	89.44	Pass
15	2570.990	Pk	N	50.74	89.44	Pass
16	2595.293	Pk	N	50.42	89.44	Pass
17	2617.165	Pk	N	48.85	89.44	Pass
18	2643.899	Pk	N	45.64	89.44	Pass
19	2668.201	Pk	N	40.48	89.44	Pass
20	2690.074	Pk	Y	39.46	N/A	See Section A3
21	2714.377	Pk	Y	38.78	N/A	See Section A3
22	4951.923	Pk	Y	60.86	N/A	See Section A3
23	7423.076	Pk	Y	50.83	N/A	See Section A3
24	19519.230	Pk	Y	39.06	N/A	See Section A3
25	24932.692	Pk	N	42.88	89.44	Pass

**Notes:**

1. The conducted emission limit for emissions outside the restricted bands, defined in 47CFR15.205(a) is based on a transmitted carrier level of 15.247(b)(3). With the EUT transmitting on its lowest, centre and highest carrier frequencies in turn, emissions from the EUT are required to be 20 dB below the level of the highest fundamental as measured within a 100 kHz RBW in accordance with 15.247(d) using a peak detector.
2. The RBW = 100 kHz, Video bandwidth (VBW) > RBW and the radio spectrum was investigated up to the 10th harmonic in accordance 15.33 (a)(1).
3. The measurements at 2400 MHz and 2483.5 MHz were made to ensure band edge compliance.

The limit outside the restricted band in 100 kHz RBW is defined using the following formula in accordance with 15.247(d):

$$\text{The limit in 100 kHz RBW} = (\text{Maximum Peak Conducted Power}) - 20\text{dB}$$

Where:

The maximum peak conducted power was measured using a peak power meter. Please refer to section A1 of this test report.

Channel No.	Channel Frequency (MHz)	Measured Peak Conducted Carrier Power (W)	Measured Peak Conducted Carrier (dB $\mu$ V)	Measured Peak Conducted Carrier – 20dB (dB $\mu$ V)	Emission Limit 15.247(d) Outside the restricted band in 100 kHz RBW (dB $\mu$ V)
11	2405	0.001368	108.360	108.360-20	88.36
18	2440	0.001556	108.920	108.920-20	88.92
25	2475	0.001755	109.440	109.440-20	89.44

**A3 Radiated Electric Field Emissions Within The Restricted Band 15.205**

Preliminary conducted emission testing was performed using a peak detector with the RBW = 100kHz. The radiated electric field emission test applies to spurious emissions and harmonics that fall within the restricted bands listed in Section 15.205. The maximum permitted field strength is listed in Section 15.209. The EUT was set to transmit on its lowest, centre and highest carrier frequency in turn.

The following test site was used for final measurements as specified by the standard tested to :

10m open area test site :       3m alternative test site :

The effect of the EUT set-up on the measurements is summarised in note (c) below.

Test Details CH11	
Regulation	Title 47 of the CFR 2008, Part 15 Subpart (c) Clause 15.247(d) and Clause 15.205
Measurement standard	ANSI C63.4:2003
Frequency range	30MHz to 25GHz
EUT sample number	S13
Modification state	0
SE in test environment	S15
SE isolated from EUT	None
EUT set up	Refer to Appendix C
Photographs (Appendix F)	Photograph 1 and 2

The worst case radiated emission measurements, for spurious emissions and harmonics that fall within the restricted bands, are listed below:

Ref No.	Freq (MHz)	Det.	Angle. Deg.	Height (cm)	Pol.	Result (dB $\mu$ V/m)	Spec. Limit (dB $\mu$ V/m)	Margin (dB)	Summary
1	120.176	QP	0	100	H	13.8	54	-40.2	Pass
2	120.176	Pk	0	100	H	15.0	74	-59.0	Pass
3	169.214	QP	0	100	H	8.1	54	-45.9	Pass
4	169.214	Pk	0	100	H	13.8	74	-60.2	Pass
5	2285.576	Pk	0	100	H	50.8	74	-23.2	Pass
6	2285.576	Av	0	100	H	37.6	54	-16.4	Pass
7	2390.000	Pk	80	100	H	51.7	74	-22.3	Pass
8	2390.000	Av	80	100	H	37.5	54	-16.5	Pass
9	2400.000	Pk	61	100	V	56.1	74	-17.9	Pass
10	2400.000	Av	61	100	V	46.1	54	-7.9	Pass
11	2483.500	Pk	180	100	H	51.6	74	-22.4	Pass
12	2483.500	Av	180	100	H	37.9	54	-16.1	Pass
13	4807.692	Pk	320	100	V	56.9	74	-17.1	Pass
14	4807.692	Av	320	100	V	46.8	54	-7.2	Pass
15	19471.153	Pk	0	H	100	49.4	74	-24.6	Pass
16	19471.153	Av	0	H	100	37.1	54	-16.9	Pass



**Radiated Electric Field Emissions Within The Restricted Band 15.205 continued:**

The effect of the EUT set-up on the measurements is summarised in note (c) below.

Test Details CH18	
Regulation	Title 47 of the CFR 2008, Part 15 Subpart (c) Clause 15.247(d) and Clause 15.205
Measurement standard	ANSI C63.4:2003
Frequency range	30MHz to 25GHz
EUT sample number	S13
Modification state	0
SE in test environment	S15
SE isolated from EUT	None
EUT set up	Refer to Appendix C
Photographs (Appendix F)	Photograph 1 and 2

The worst case radiated emission measurements, for spurious emissions and harmonics that fall within the restricted bands, are listed below:

Ref No.	Freq (MHz)	Det.	Angle. Deg.	Height (cm)	Pol.	Result (dB $\mu$ V/m)	Spec. Limit (dB $\mu$ V/m)	Margin (dB)	Summary
1	120.176	QP	0	100	H	10.1	54	-43.9	Pass
2	120.176	Pk	0	100	H	14.8	74	-59.2	Pass
3	2321.474	Pk	0	100	H	50.6	74	-23.4	Pass
4	2321.474	Av	0	100	H	37.4	54	-16.6	Pass
5	2390.000	Pk	258	100	H	50.8	74	-23.2	Pass
6	2390.000	Av	258	100	H	37.5	54	-16.5	Pass
7	2400.000	Pk	0	100	H	50.9	74	-23.1	Pass
8	2400.000	Av	0	100	H	37.6	54	-16.4	Pass
9	2483.500	Pk	0	100	H	51.2	74	-22.8	Pass
10	2483.500	Av	0	100	H	37.9	54	-16.1	Pass
11	2488.360	Pk	0	100	H	51.7	74	-22.3	Pass
12	2488.360	Av	0	100	H	37.9	54	-16.1	Pass
13	4875.000	Pk	221	100	V	57.0	74	-17.0	Pass
14	4875.000	Av	221	100	H	46.1	54	-7.9	Pass
15	7371.307	Pk	28	100	H	57.2	74	-16.8	Pass
16	7371.307	Av	28	100	V	44.2	54	-9.8	Pass
17	19599.358	Pk	0	H	100	49.4	74	-24.6	Pass
18	19599.358	Av	0	H	100	36.9	54	-17.1	Pass

**Radiated Electric Field Emissions Within The Restricted Band 15.205 continued:**

The effect of the EUT set-up on the measurements is summarised in note (c) below.

Test Details CH25	
Regulation	Title 47 of the CFR 2008, Part 15 Subpart (c) Clause 15.247(d) and Clause 15.205
Measurement standard	ANSI C63.4:2003
Frequency range	30MHz to 25GHz
EUT sample number	S13
Modification state	0
SE in test environment	S15
SE isolated from EUT	None
EUT set up	Refer to Appendix C
Photographs (Appendix F)	Photograph 1 and 2

The worst case radiated emission measurements, for spurious emissions and harmonics that fall within the restricted bands, are listed below:

Ref No.	Freq (MHz)	Det.	Angle. Deg.	Height (cm)	Pol.	Result (dB $\mu$ V/m)	Spec. Limit (dB $\mu$ V/m)	Margin (dB)	Summary
1	120.176	QP	0	100	H	9.7	54	-44.3	Pass
2	120.176	Pk	0	100	H	16.1	74	-57.9	Pass
3	2357.371	Pk	0	100	H	49.7	74	-24.3	Pass
4	2357.371	Av	0	100	H	37.2	54	-16.8	Pass
5	2390.000	Pk	0	100	V	50.8	74	-23.2	Pass
6	2390.000	Av	0	100	V	37.5	54	-16.5	Pass
7	2400.000	Pk	0	100	V	50.2	74	-23.8	Pass
8	2400.000	Av	0	100	V	37.6	54	-16.4	Pass
9	2483.500	Pk	0	100	V	52.7	74	-21.3	Pass
10	2483.500	Av	0	100	V	38.8	54	-15.2	Pass
11	2485.930	Pk	0	100	H	51.6	74	-22.4	Pass
12	2485.935	Av	0	100	H	38.6	54	-15.4	Pass
13	2690.074	Pk	26	100	H	53.6	74	-20.4	Pass
14	2690.074	Av	26	100	H	39.8	54	-14.2	Pass
15	2714.373	Pk	0	100	V	53.4	74	-20.6	Pass
16	2714.373	Av	0	100	V	40.1	54	-13.9	Pass
17	4951.923	Pk	214	100	H	56.1	74	-17.9	Pass
18	4951.923	Av	214	100	H	43.2	54	-10.8	Pass
19	7423.076	Pk	228	100	H	58.3	74	-15.7	Pass
20	7423.076	Av	228	100	H	44.7	54	-9.3	Pass
21	19519.23	Pk	0	H	100	50.3	74	-23.7	Pass
22	19519.23	Av	0	H	100	36.9	54	-17.1	Pass

**Notes:**

- 1 Any testing performed below 30 MHz was performed using a magnetic loop antenna in accordance with ANSI C63.4: 2003 section 8.2.1.
- 2 In accordance with 15.35(b), above 1 GHz, emissions measured using a peak detector shall not exceed a level 20 dB above the average limit.
- 3 The measurements 2483.5 MHz was made to ensure band edge compliance.
- 4 Demonstration of band edge compliance at 2.4GHz (which lies outside the restricted bands as defined in section 47CFR15.205(a) is contained in section A2, RF Antenna Conducted Spurious Emissions and Appendix B of this test report.
- 5 Testing was performed with the EUT orientated in three orthogonal planes and the maximum emissions level recorded. In addition, the EUT antenna was varied within its range of motion in order to maximise emissions.
- 6 For Frequencies Below 1 GHz, RBW= 100 kHz, testing was performed with CISPR16 compliant test receiver with QP detector. Above 1 GHz tests were performed using a spectrum analyser using the following settings:

Peak	RBW=VBW= 1MHz
Average	RBW= 1 MHz, VBW = 10 Hz

These settings are as per ANSI C63.4.

- 7 In accordance with 47CFR 15.35(c) the emissions may be reduced by the duty cycle correction factor. The duty cycle factor was determined by the on-time of the transmitter/100 milliseconds or period, whichever is less See Appendix E for further details.

The upper frequency of the measurement range was decided according to 47 CFR 15:2008 Clause 15.33(a)(1).

Radiated emission limits (47 CFR 15:2008 Clause 15.209) for emissions falling within the restricted bands defined in 15.205(a):

Frequency of emission (MHz)	Field strength $\mu\text{V}/\text{m}$	Measurement Distance m	Field strength $\text{dB}\mu\text{V}/\text{m}$
0.009-0.490	2400/F(kHz)	300	67.6/F (kHz)
0.490-1.705	24000/F(kHz)	30	87.6/F (kHz)
1.705-30	30	30	29.5
30-88	100	3	40.0
88-216	150	3	43.5
216-960	210	3	46.4
Above 960	500	3	54.0

**Notes:**

- (a) Where results have been measured at one distance, and a signal level displayed at another, the results have been extrapolated using the following formula:

$$\text{Extrapolation (dB)} = 20 \log_{10} \left( \frac{\text{measurement distance}}{\text{specification distance}} \right)$$

The results displayed take into account applicable antenna factors and cable losses.

- (b) The levels may have been rounded for display purposes.
- (c) The following table summarises the effect of the EUT operating mode, internal configuration and arrangement of cables / samples on the measured emission levels :

	See (i)	See (ii)	See (iii)	See (iv)
Effect of EUT operating mode on emission levels	✓			
Effect of EUT internal configuration on emission levels		✓		
Effect of Position of EUT cables & samples on emission levels	✓			
(i) Parameter defined by standard and / or single possible, refer to Appendix D (ii) Parameter defined by client and / or single possible, refer to Appendix D (iii) Parameter had a negligible effect on emission levels, refer to Appendix D (iv) Worst case determined by initial measurement, refer to Appendix D				

**A4 6 dB Bandwidth**

Measurement of the bandwidth of the transmission between the -6 dB points on the transmitted modulated spectrum was verified using a spectrum analyser. To determine the occupied bandwidth a RBW of 100 kHz and a minimum VBW three times greater than the RBW (1 MHz) was used. The spectrum analyser was then set to take a peak hold measurement. The peak level was found and set to a 0dB reference point and markers offset by -6dB determined the bandwidth. The EUT was set to transmit on its lowest, centre and highest carrier frequency in turn. The formal measurements are detailed below:

Test Details:	
Regulation	Title 47 of the CFR 2008, Part 15 Subpart (c) 15.247(a)(2)
EUT sample number	S07
Modification state	0
SE in test environment	S02 and S03
SE isolated from EUT	None
EUT set up	Refer to Appendix C

Channel No.	Channel Frequency (MHz)	Measured 6 dB Bandwidth (MHz)	Limit	Result
11	2405	1.498	>500 kHz	Pass
18	2440	1.538		Pass
25	2475	1.570		Pass

Plots of the 6 dB bandwidth are contained in Appendix B of this test report.

**A5 Antenna Gain**

The maximum antenna gain for the antenna types to be used with the EUT, as declared by the client, is 1 dBi.

**A6 Power Spectral Density**

Power spectral density was verified using a spectrum analyser. Testing was performed with the EUT transmitting a modulated carrier on its lowest, centre and highest carrier frequency in turn.

Test Details:	
Regulation	Title 47 of the CFR 2008, Part 15 Subpart (c) 15.247(e)
EUT sample number	S07
Modification state	0
SE in test environment	S02 and S03
SE isolated from EUT	None
EUT set up	Refer to Appendix C

Channel No	Channel Frequency (MHz)	Measured power Spectral density (dBm/3kHz)	Limit (dBm/3kHz)	Result
11	2405	-13.86	8.0	Pass
18	2440	-12.83		Pass
25	2475	-12.28		Pass

**Appendix B:**

**Supporting Graphical Data**

This appendix contains graphical data obtained during testing.

Notes:

- (a) The conducted emissions graphical data in this appendix is preview data. Any emissions detected within the restricted band were formally assessed against the limits in 15.209. For details of formal results, refer to Appendix A and Appendix B.
- (b) The time and date on the plots do not necessarily equate to the time of the test.
- (c) Where relevant, on power line conducted emission plots, the limit displayed is the average limit, which is stricter than the quasi peak limit.
- (d) Appendix C details the numbering system used to identify the sample and its modification state.
- (e) The plots presented in this appendix may not be a complete record of the measurements performed, but are a representative sample, relative to the final assessment.



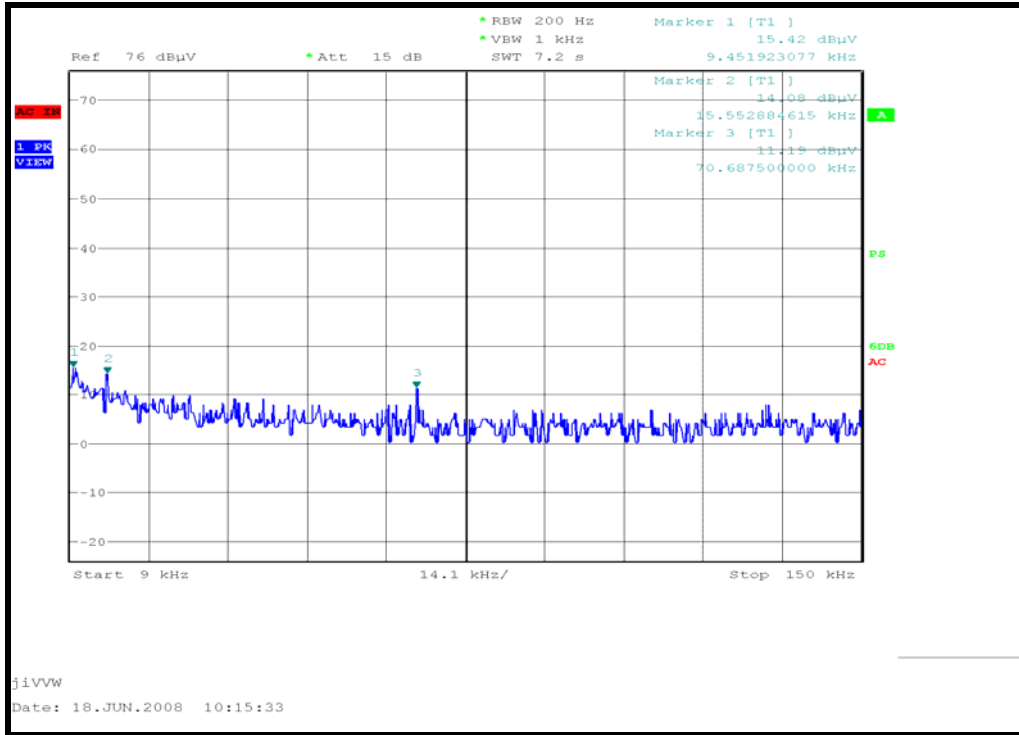

Conducted emissions: Channel 11

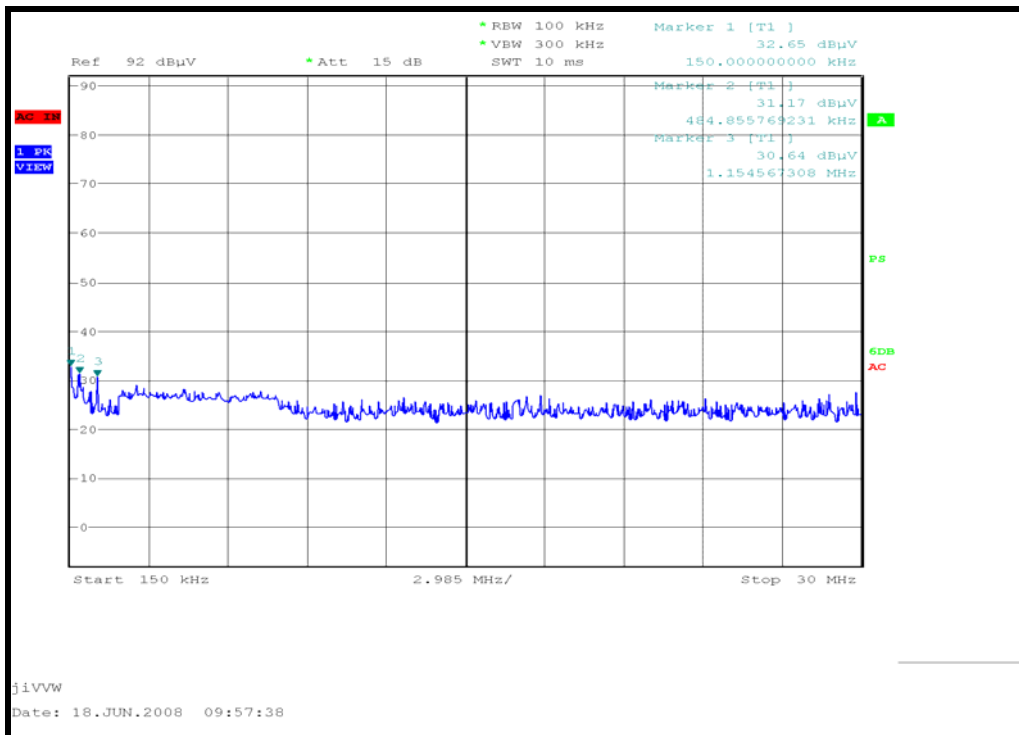

Conducted emissions: Channel 11

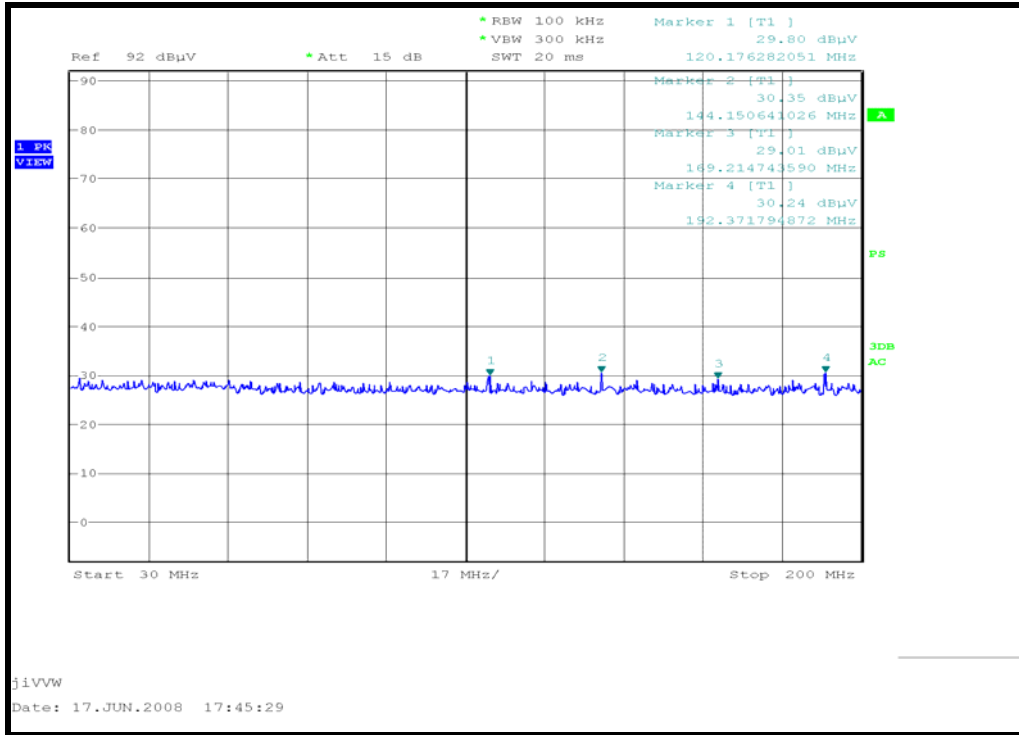

Conducted emissions: Channel 11

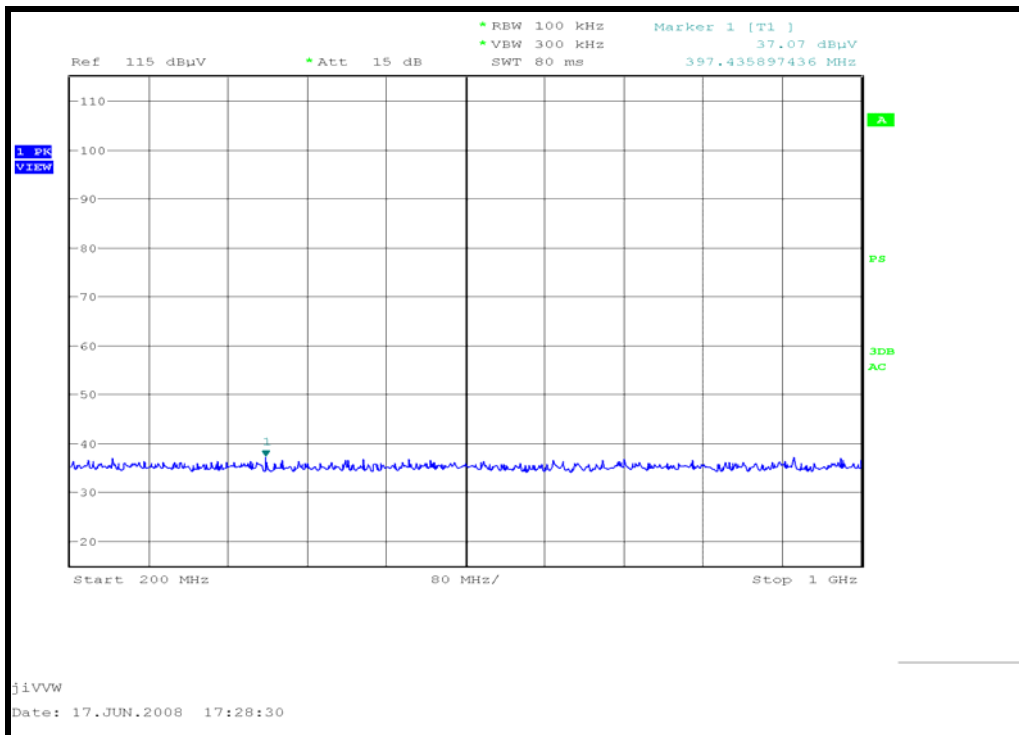

Conducted emissions: Channel 11

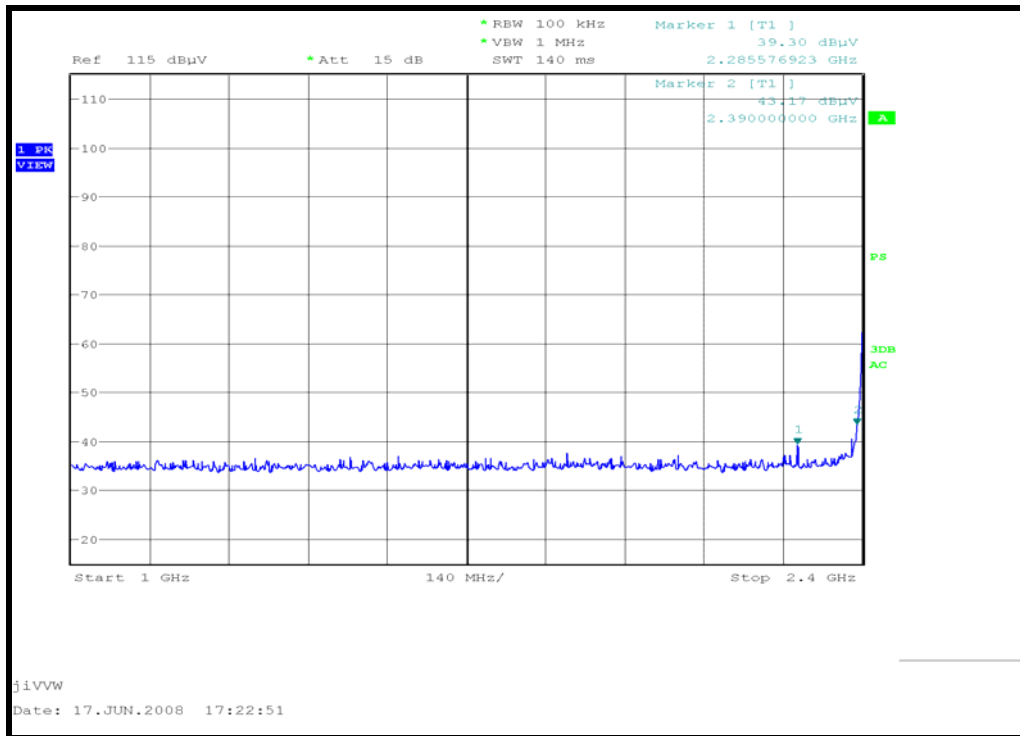

Conducted emissions: Channel 11

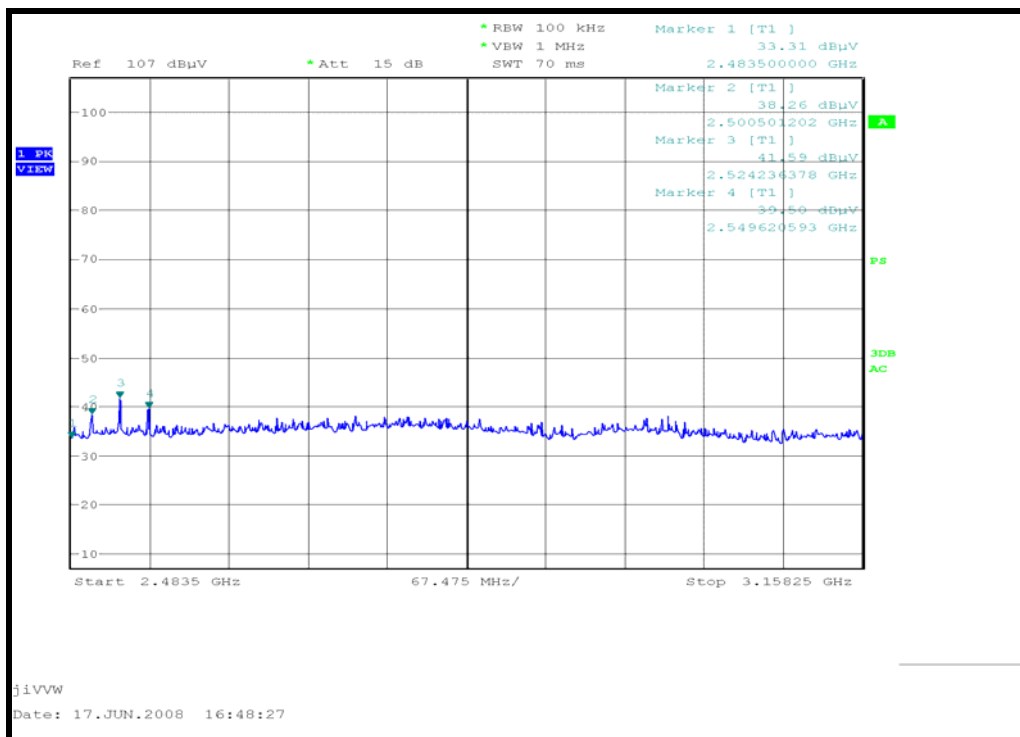

Conducted emissions: Channel 11

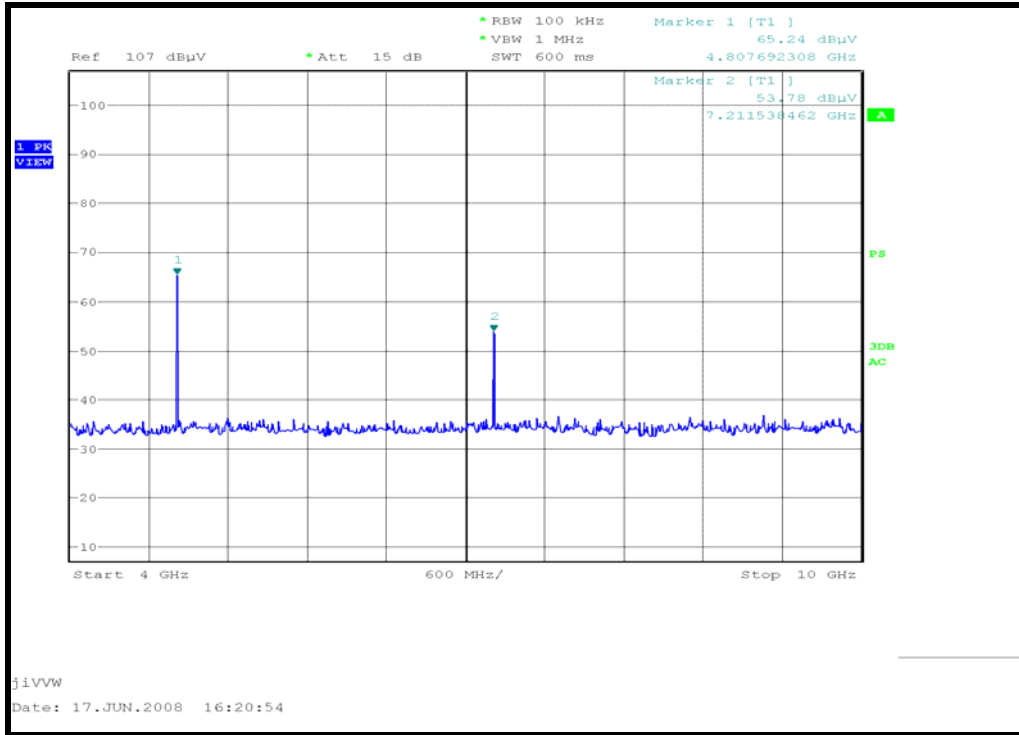

Conducted emissions: Channel 11

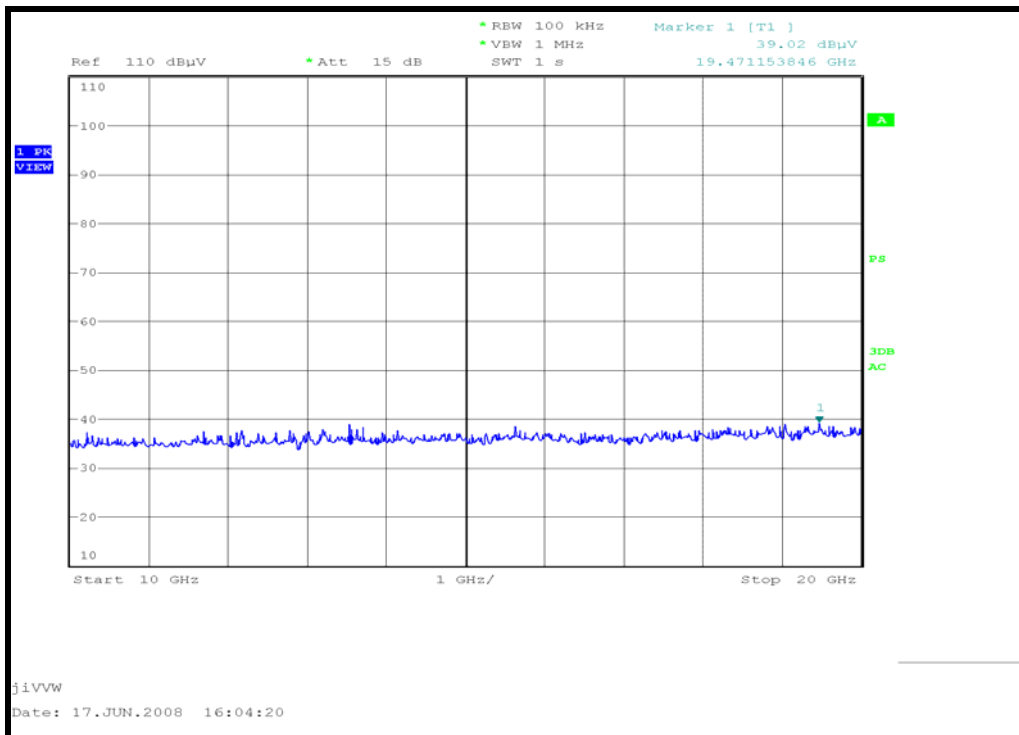

Conducted emissions: Channel 11

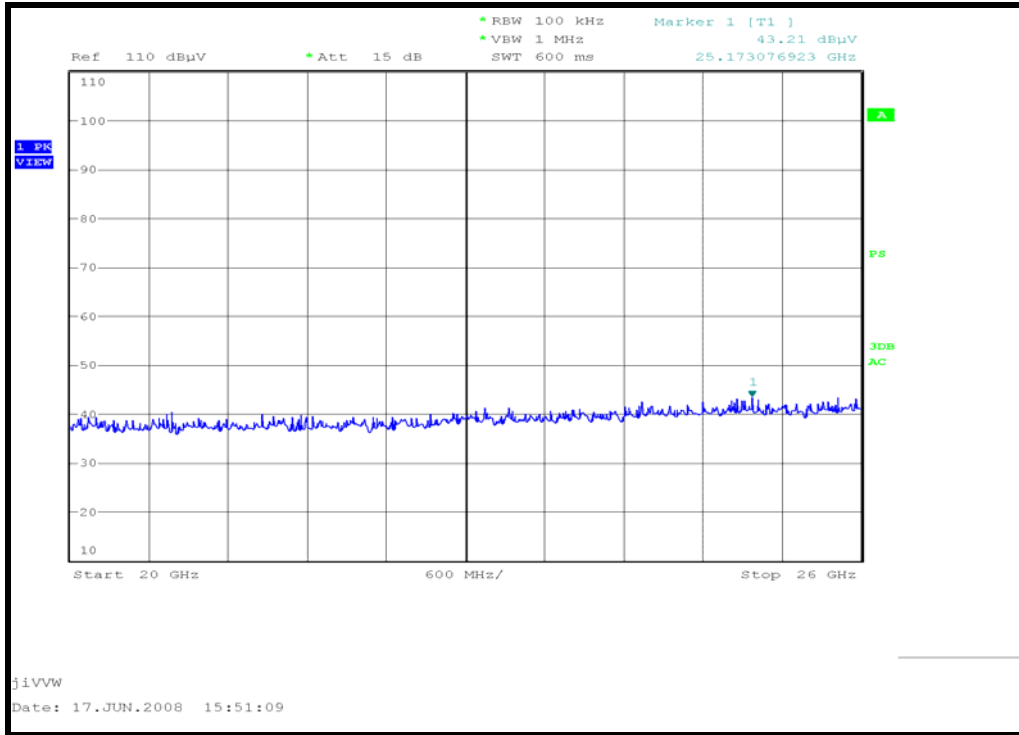

Conducted emissions: Channel 11

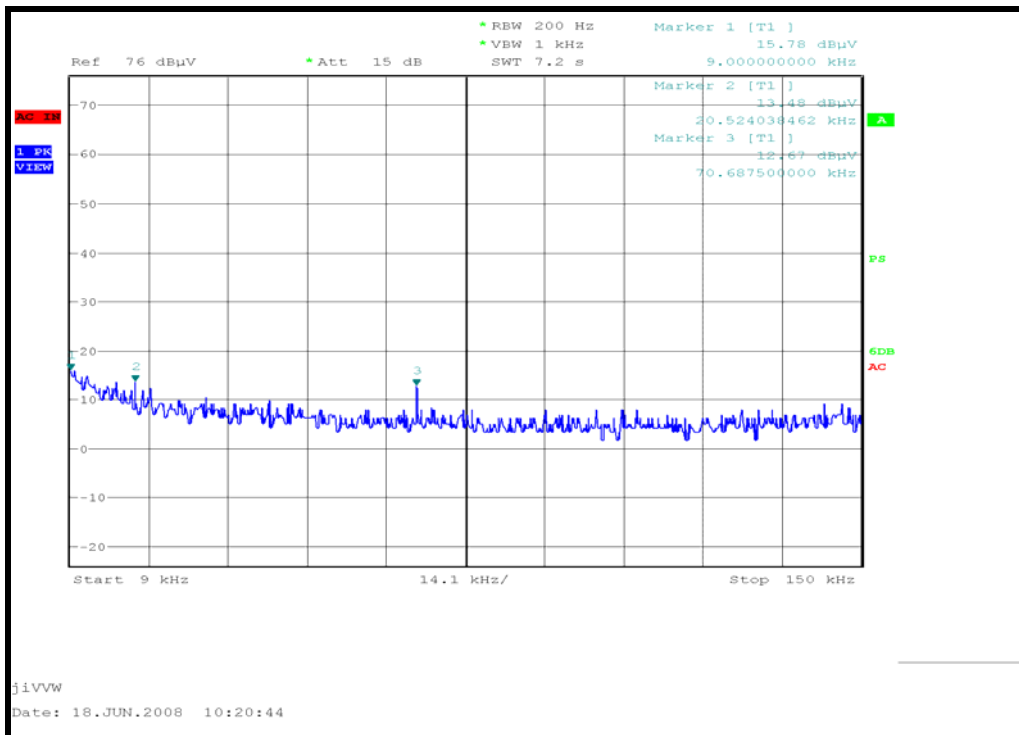

Conducted emissions: Channel 18

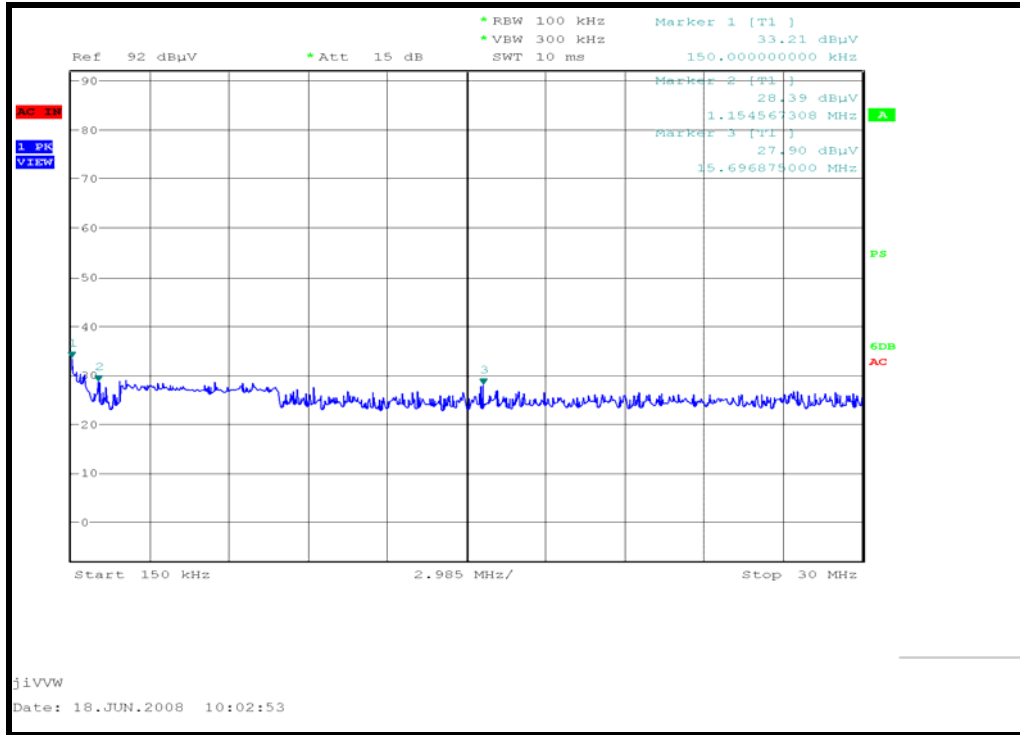

Conducted emissions: Channel 18

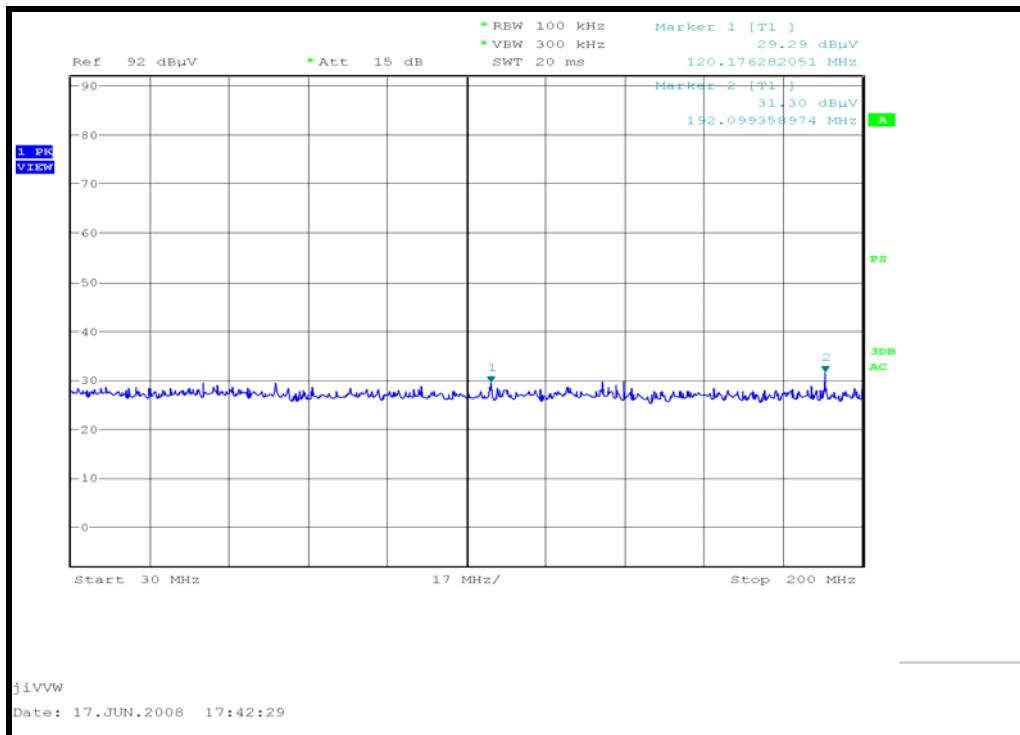

Conducted emissions: Channel 18

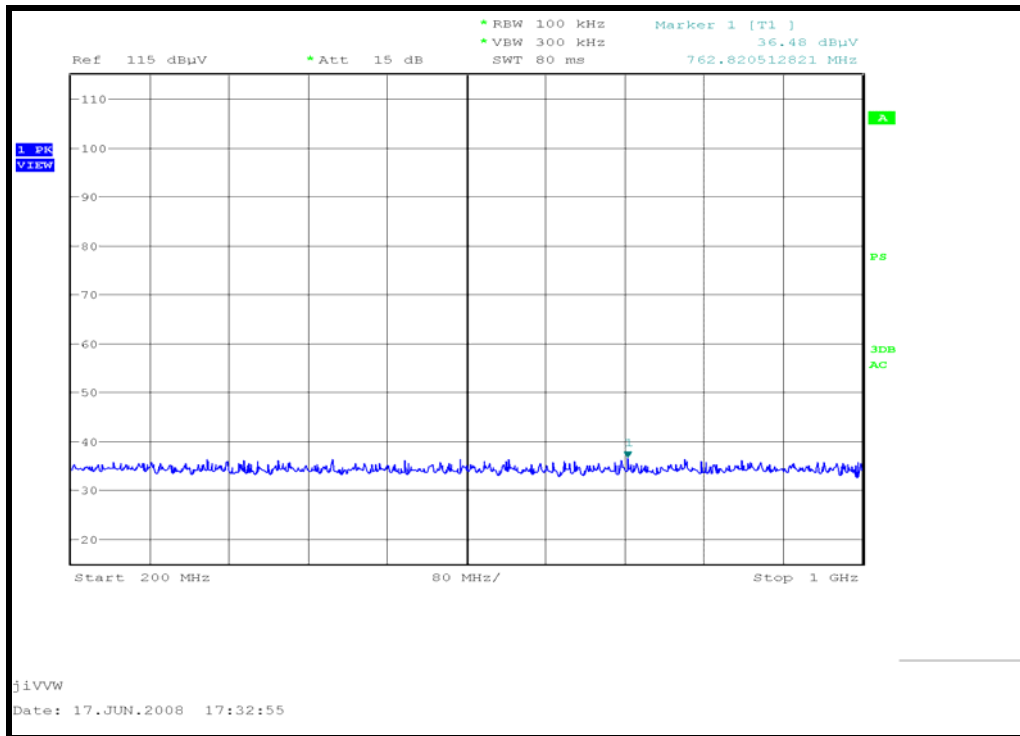

Conducted emissions: Channel 18

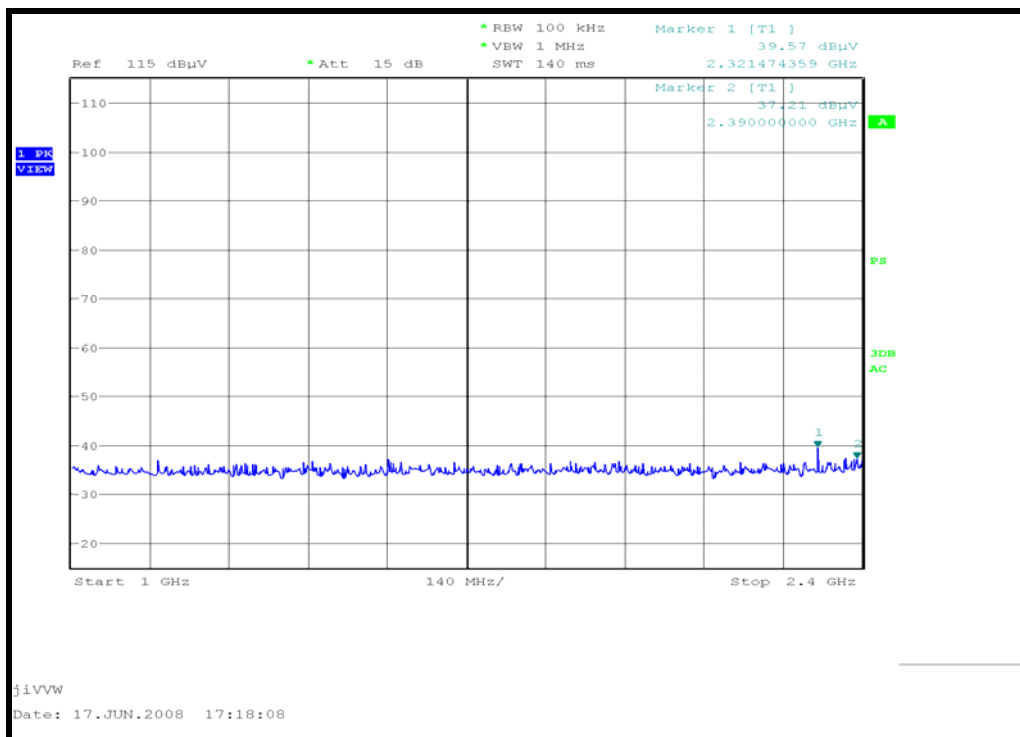

Conducted emissions: Channel 18

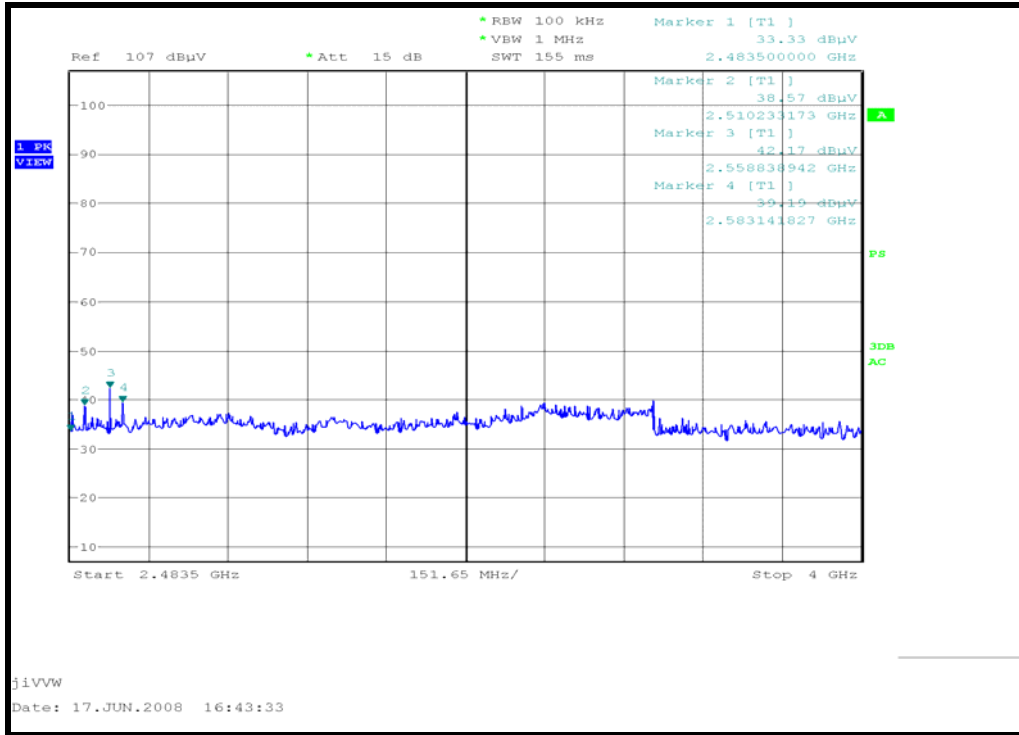

Conducted emissions: Channel 18

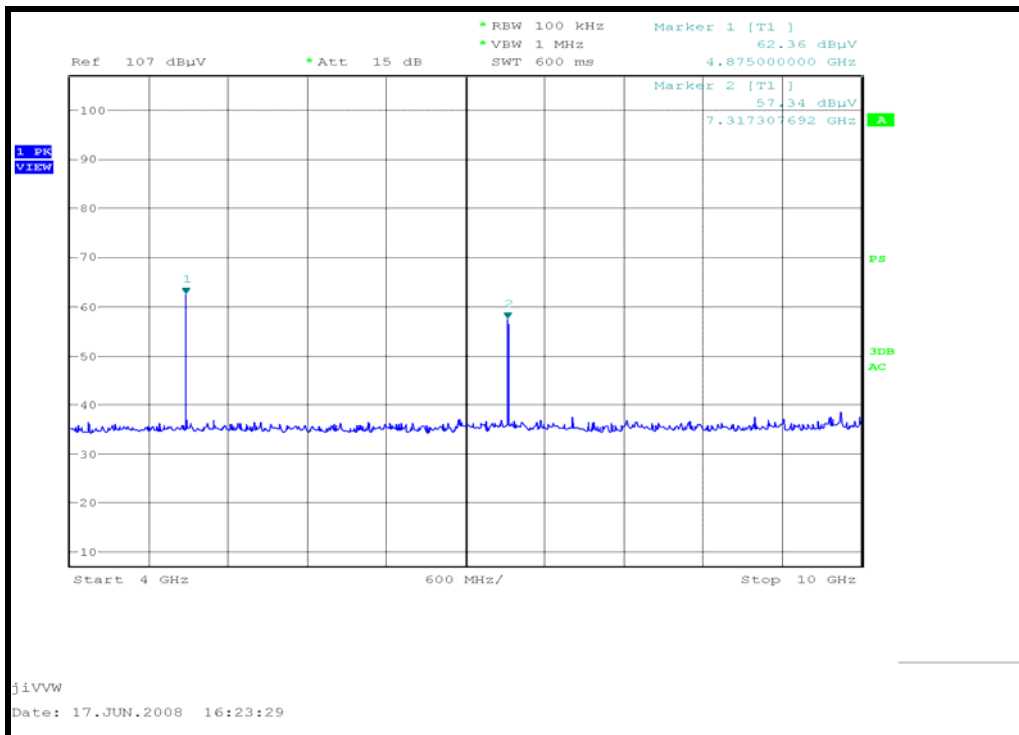

Conducted emissions: Channel 18



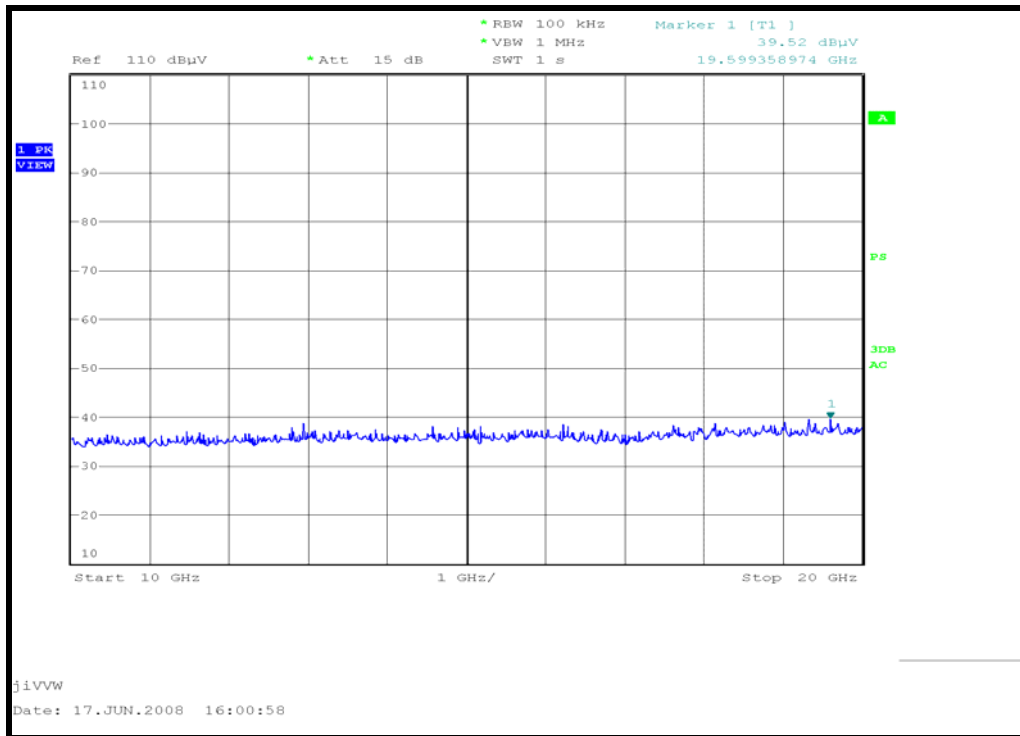

Conducted emissions: Channel 18

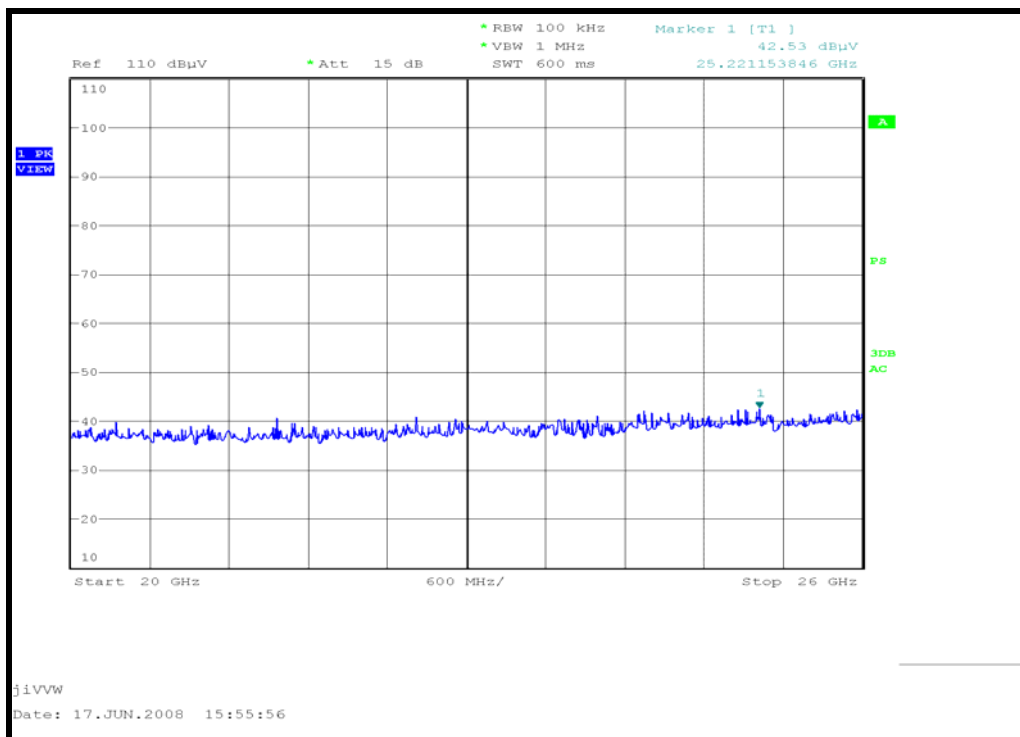

Conducted emissions: Channel 18





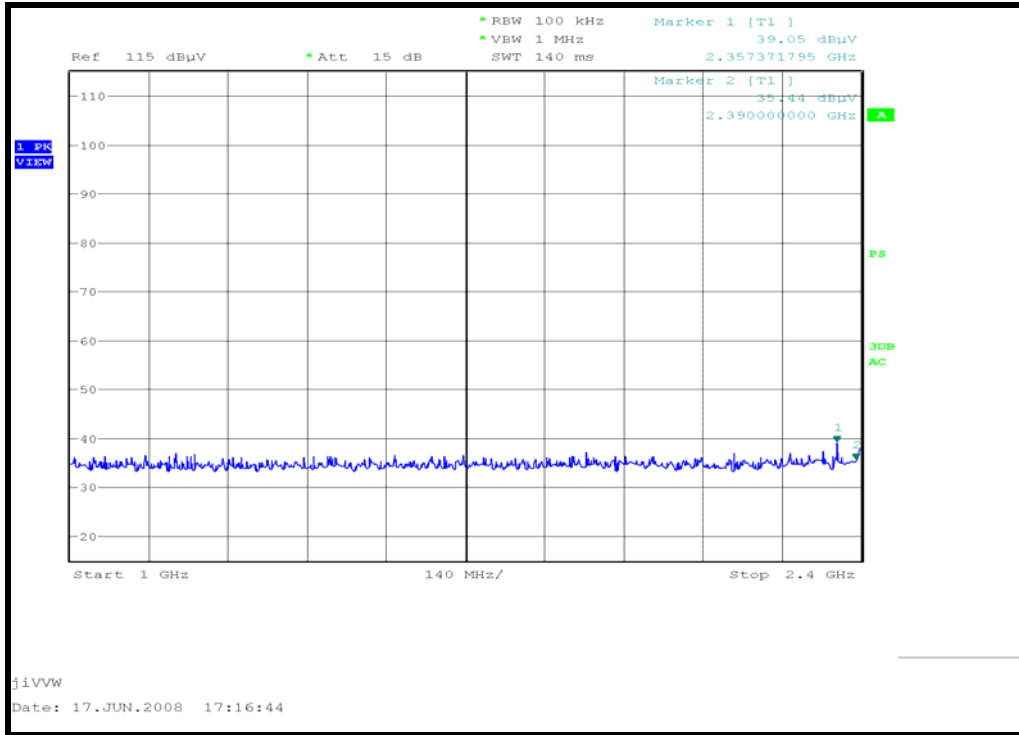

Conducted emissions: Channel 25

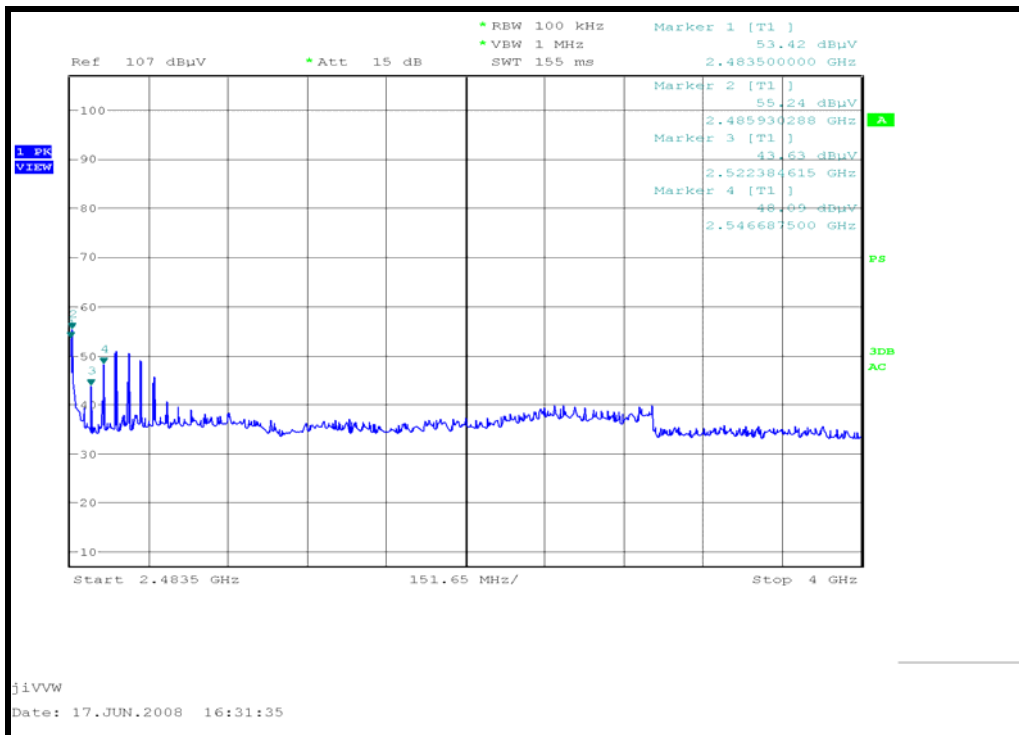

Conducted emissions: Channel 25

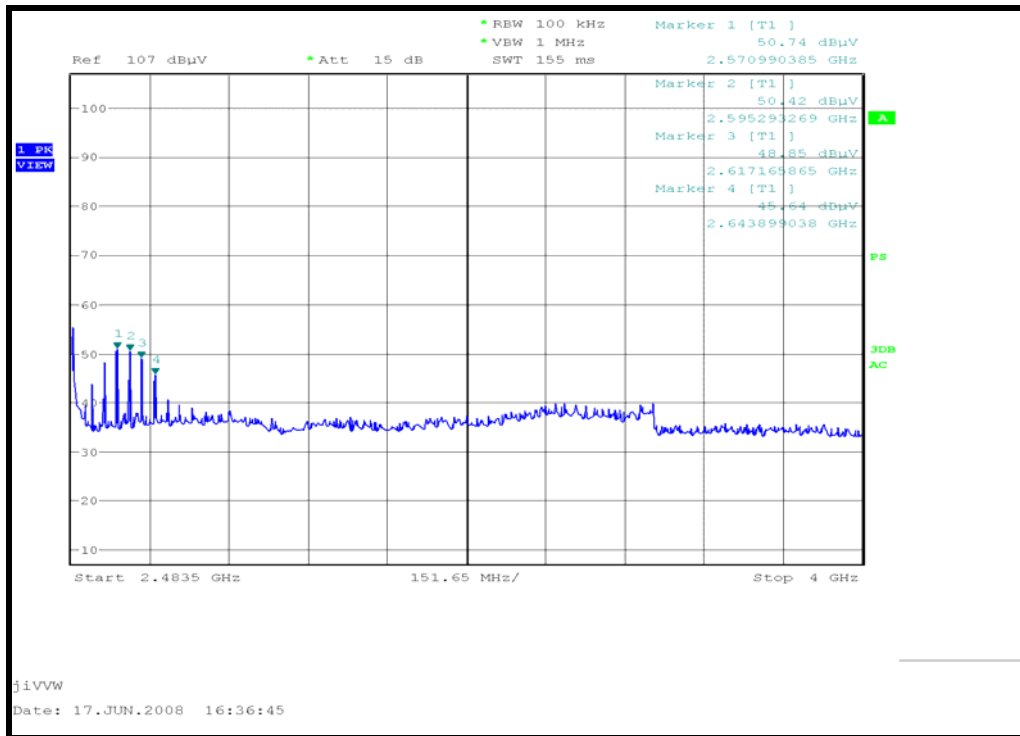

Conducted emissions: Channel 25

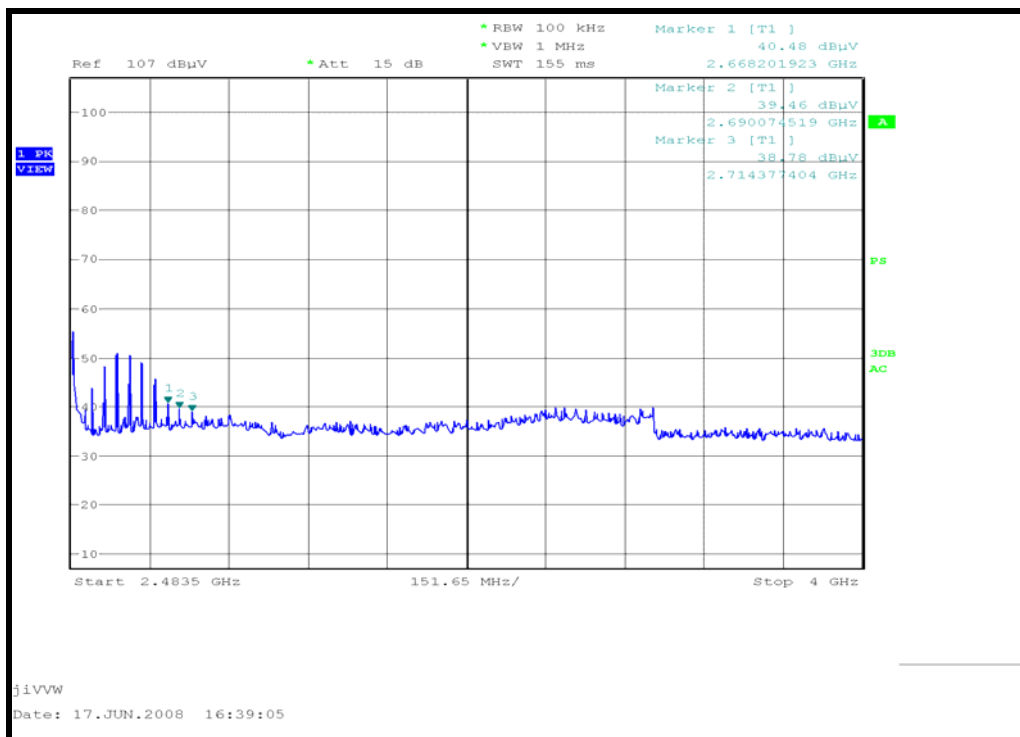

Conducted emissions: Channel 25

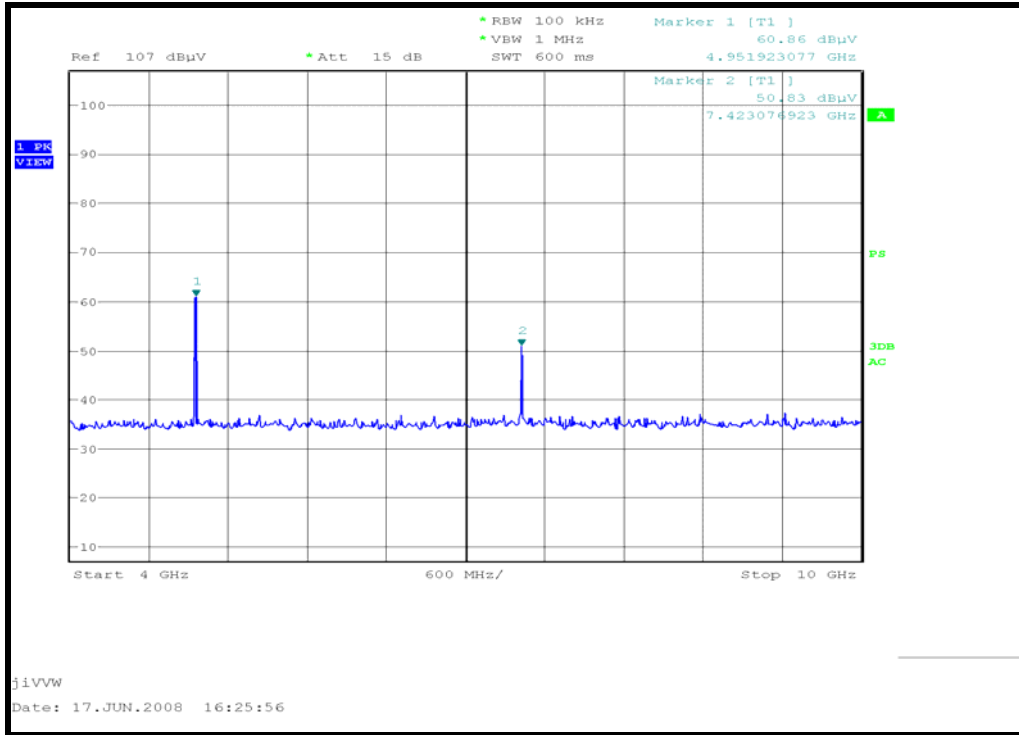

Conducted emissions: Channel 25

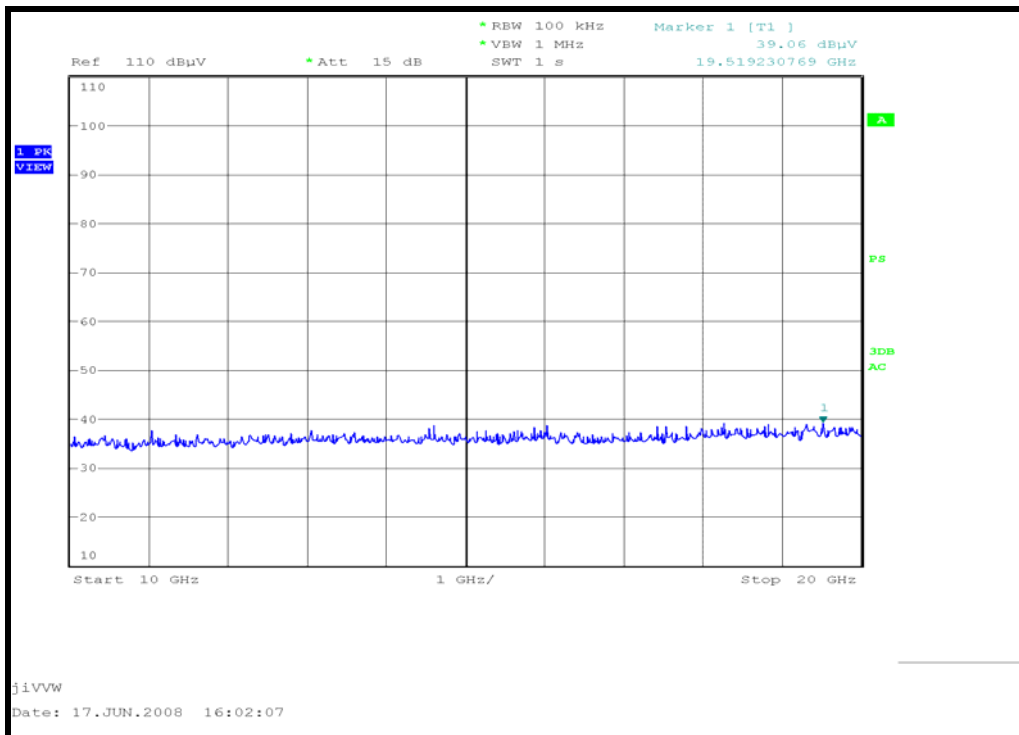

Conducted emissions: Channel 25

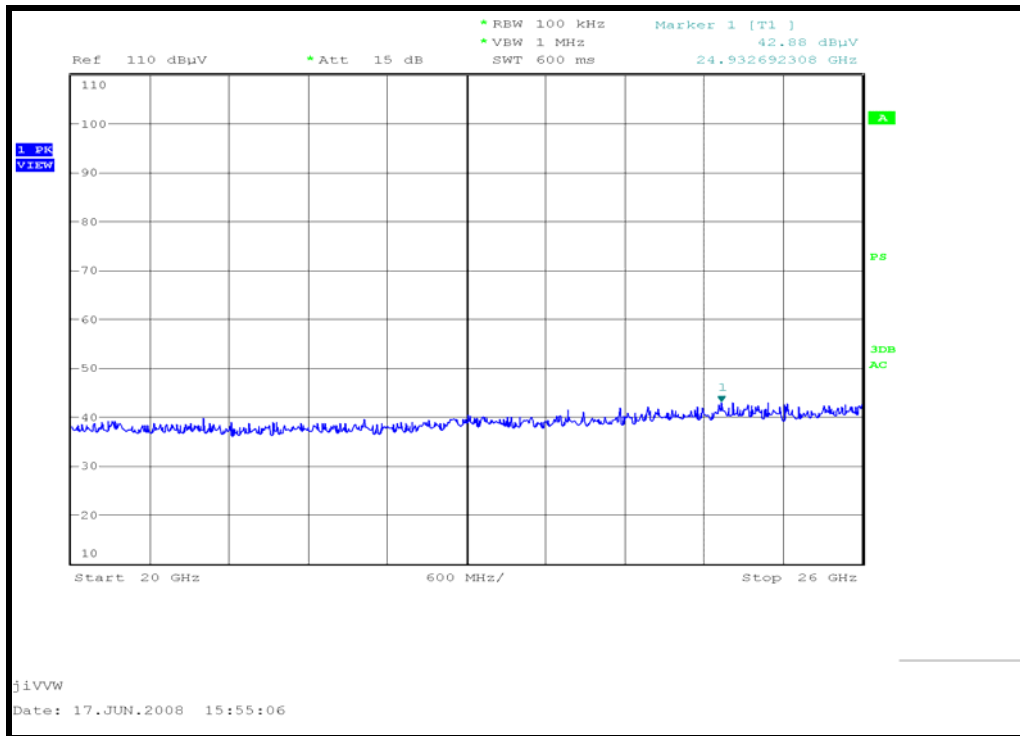

Conducted emissions: Channel 25

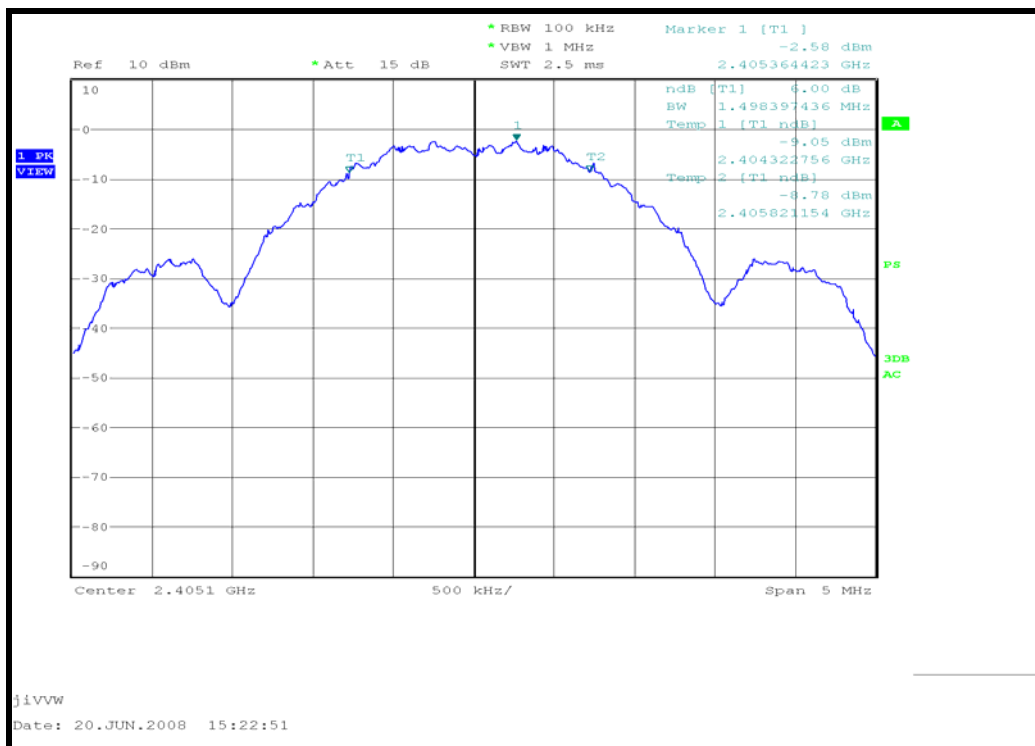

6dB Bandwidth: Channel 11

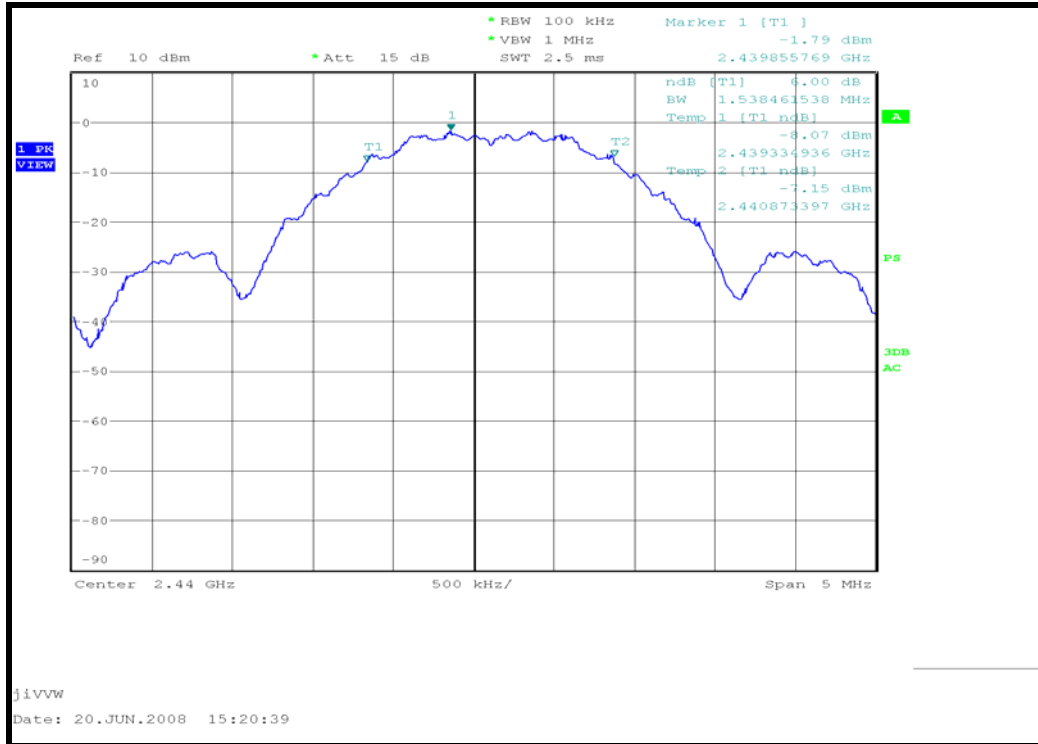

6dB Bandwidth: Channel 18

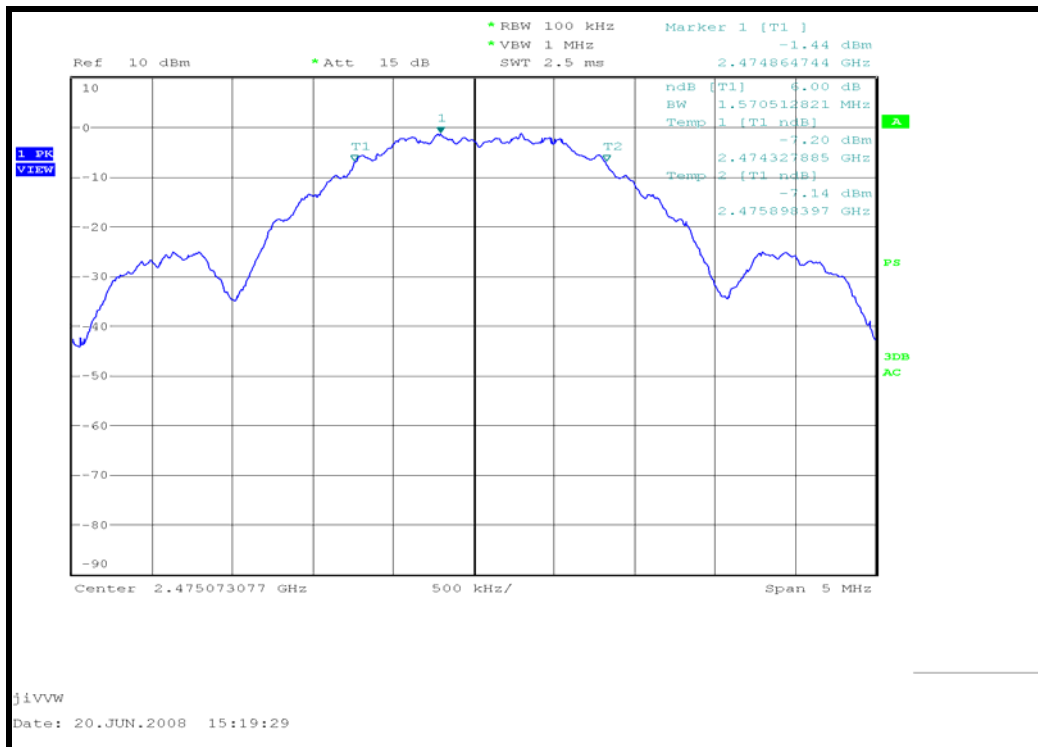

6dB Bandwidth: Channel 25



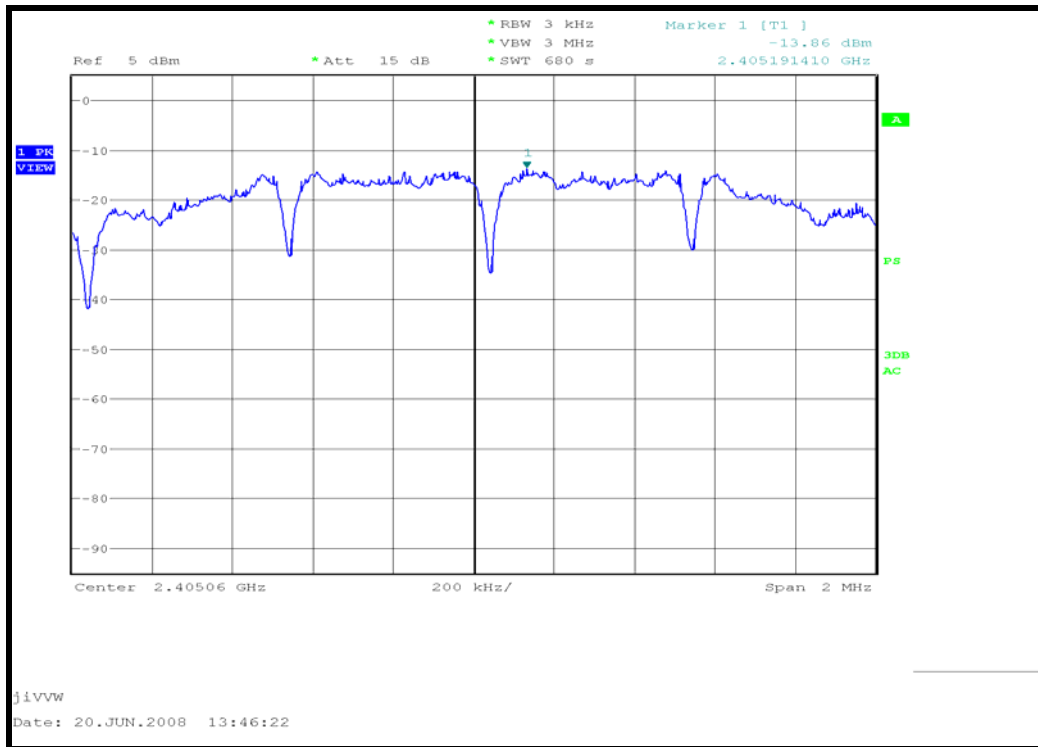

Power Spectral density: Channel 11

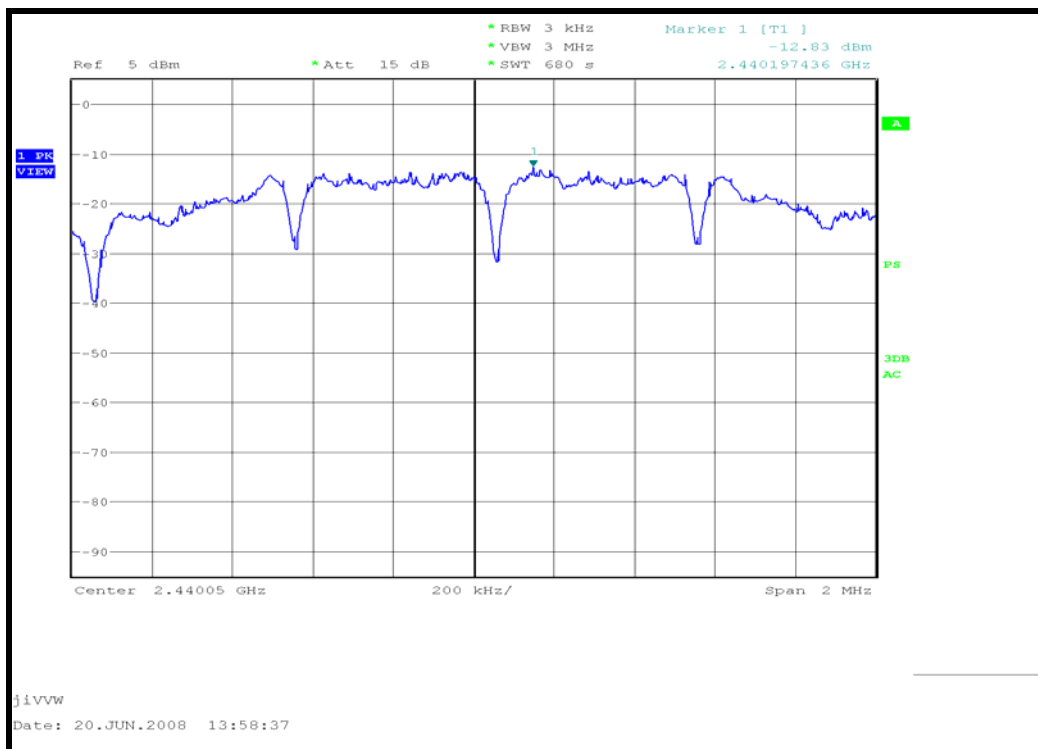

Power Spectral Density: Channel 18

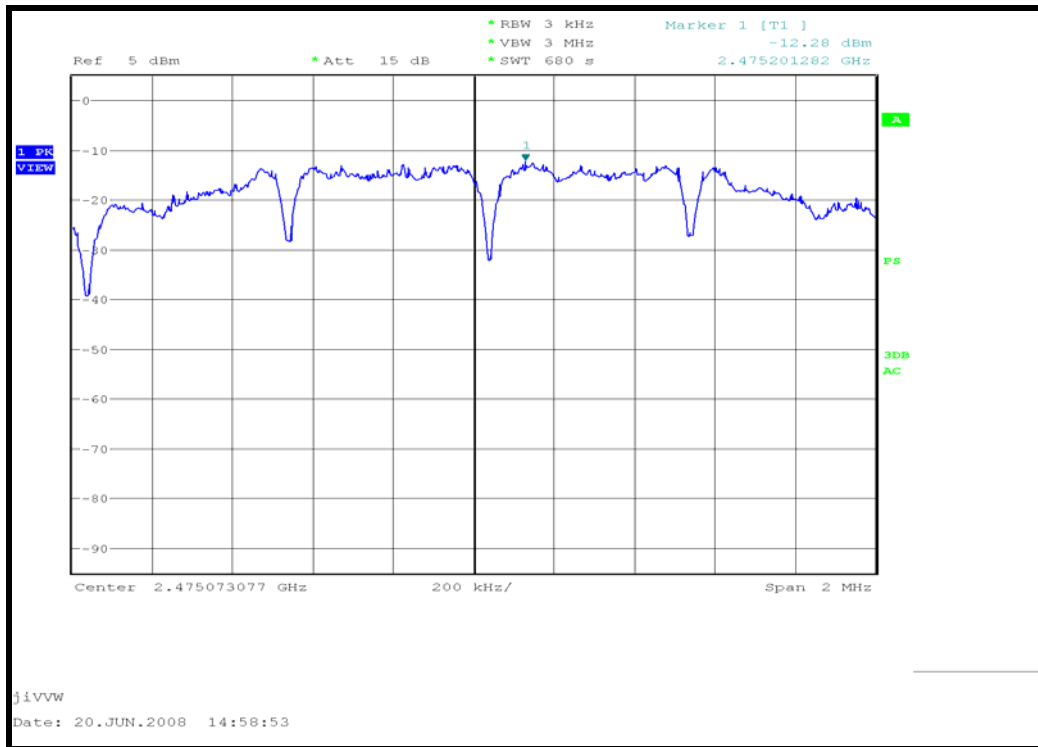

Power spectral density: Channel 25

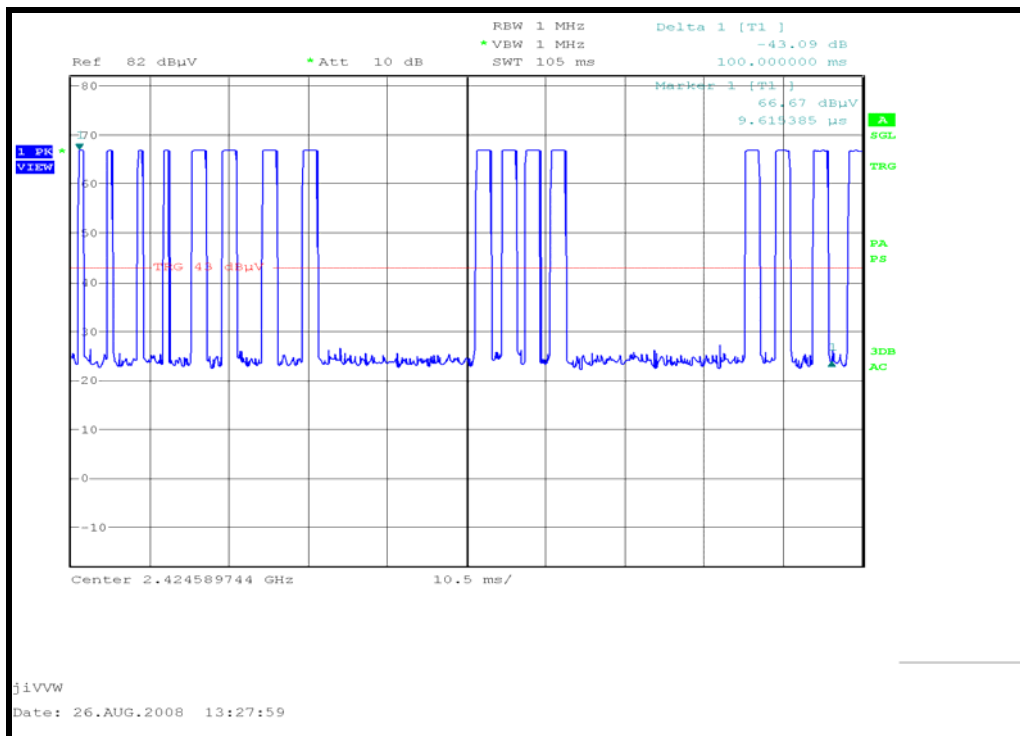

Transmitter on time (*Duty cycle*)

**Appendix C:****Additional Test and Sample Details**

This appendix contains details of:

1. The samples submitted for testing.
2. Details of EUT operating mode(s)
3. Details of EUT configuration(s) (see below).
4. EUT arrangement (see below).

Throughout testing, the following numbering system is used to identify the sample and it's modification state:

**Sample No:** Sxx Mod w

where:

xx	= sample number	eg. S01
w	= modification number	eg. Mod 2

The following terminology is used throughout the test report:

**Support Equipment (SE)** is any additional equipment required to exercise the EUT in the applicable operating mode. Where relevant SE is divided into two categories:

**SE in test environment:** The SE is positioned in the test environment and is not isolated from the EUT (e.g. on the table top during REFE testing).

**SE isolated from the EUT:** The SE is isolated via filtering from the EUT. (e.g. equipment placed externally to the ALSR during REFE testing).

**EUT configuration** refers to the internal set-up of the EUT. It may include for example:

- Positioning of cards in a chassis.
- Setting of any internal switches.
- Circuit board jumper settings.
- Alternative internal power supplies.

Where no change in EUT configuration is **possible**, the configuration is described as "single possible configuration".

**EUT arrangement** refers to the termination of EUT ports / connection of support equipment, and where relevant, the relative positioning of samples (EUT and SE) in the test environment.

For further details of the test procedures and general test set ups used during testing please refer to the related document "EMC Test Methods - An Overview", which can be supplied by KTL upon request.

**C1) Test samples**

The following samples of the apparatus were submitted by the client for testing :

Sample No.	Description	Identification
S07	Wireless Motion Detector 1-1 Conducted	Build W18/08 REV-1-2
S13	Wireless Motion Detector 1-1 Radiated Sample	Build W18/08 REV-1-2
S15	Power one lithium CR2 3V battery	-

The following samples of apparatus were submitted by the client as host, support or drive equipment (auxiliary equipment):

Sample No.	Description	Identification
S02	ISA box (Ember)	EMBER07
S03	Plug Top PSU for S02	EMS130150P5PSZ

**C2) EUT Operating Mode During Testing.**

During testing, the EUT was exercised as described in the following tables :

Test	Description of Operating Mode:
CFCP	The EUT was powered via the InSight port (programming & debug connector) using a ribbon cable from the support equipment (S02/S03). The EUT was transmitting on maximum power using O-QPSK with half-sine pulse-shaping - 8-symbol listen-before send for CSMA-CA - Bit rate 250kb/s, symbol rate 62.5ksymbol/s with 4-bit 16-ary orthogonal symbols, chip rate 2000kchip/s) modulation at centre frequencies $F_c = 2405 + 5(k - 11)$ in MHz, where $k = 11, 18$ and $25$
RF Antenna Port Conducted Spurious Emissions	
6dB Bandwidth	
Power Spectral Density	

Test	Description of Operating Mode:
REFE (15.205 In the restricted band)	EUT powered using a Power One lithium CR2 3V battery. The EUT was transmitting continuously on maximum power using O-QPSK with half-sine pulse-shaping - 8-symbol listen-before send for CSMA-CA - Bit rate 250kb/s, symbol rate 62.5ksymbol/s with 4-bit 16-ary orthogonal symbols, chip rate 2000kchip/s) modulation at centre frequencies $F_c = 2405 + 5(k - 11)$ in MHz, where $k = 11, 18$ and $25$

**C3) EUT Configuration Information.**

Sample	Internal Configuration Details
S07	Single possible internal configuration
S13	Single possible internal configuration
S15	Single possible internal configuration

**C4) List of EUT Ports**

The table below describes the termination of EUT ports:

Sample : S07  
 Tests : RF Antenna Port Conducted Spurious Emissions, 6dB Bandwidth, Power Spectral Density and Conducted Fundamental Carrier Power

Port	Description of Cable Attached	Cable length	Equipment Connected
dc Power <sup>1</sup>	Multicore unscreened via Serial ports	N/A	S02
RF Antenna Port	50Ω coax	0.1	REF847
InSight port <sup>1</sup>	Multicore unscreened	0.3m	S02

Sample : S13  
 Tests : Radiated Electric Field Emissions (Restricted band 15.205) (Internal Battery)

Port	Description of Cable Attached	Cable length	Equipment Connected
dc Power	Internal Battery Backup (Power One lithium CR2 3V battery)	N/A	S15
InSight port	Multicore Unscreened	0.3m	S02 <sup>2</sup>

Sample : S15  
 Tests : Radiated Electric Field Emissions (Restricted band 15.205) (Internal Battery)

Port	Description of Cable Attached	Cable length	Equipment Connected
dc Power	Internal Battery Backup (Power One lithium CR2 3V battery)	N/A	S13

Notes on the above:

1. The EUT was powered via the InSight port (programming & debug connector) using a ribbon cable from the support equipment (S02/S03). A block diagram (figure 1) showing the connection of drive equipment during conducted testing in dc mode (battery) is contained within Appendix D.
2. Only connected to configure EUT. Once configured S02 was disconnected.

**C5 Details of Equipment Used**

For Radiated Electric Field Emissions 30MHz to 1GHz: (Restricted band 15.205)

RFG No	Type	Description	Manufacturer	Date Calibrated.
274	ATS	Ferrite Lined Chamber	KTL	11/01/08
244	CBL6111	Blue Bilog Antenna (0.03 - 1GHz)	Chase	22/01/06
REF837	PSA E4440A	Spectrum Analyser	Agilent	21/02/08
REF847	ESU	EMI Test Receiver (Spectrum analyser)	R&S	29/02/08
267	N-type	RF coaxial cable (Lab 10)	KTL	28/01/08
270	N-type	RF coaxial cable (Lab 10)	KTL	25/08/07

For Radiated Electric Field Emissions 1GHz to 18GHz (Restricted band 15.205)

RFG No	Type	Description	Manufacturer	Date Calibrated
274	ATS	Ferrite Lined Chamber	KTL	11/01/08
130	3115	Horn Antennas	EMCO	29/07/98
307	HP8449B	Microwave Pre-Amp (1-26.5GHz)	HP	18/02/08
476	60637	50Ω Coax 3m	Semflex	14/04/08
477	60637	50Ω Coax 3m	Semflex	14/04/08
650	N-106	Sucoflex uW Cable 3m	Suhner	14/07/08
651	N-106	Sucoflex uW Cable 7m	Suhner	14/07/08
REF847	ESU	EMI Test Receiver (Spectrum analyser)	R&S	29/02/08
244	4478	Bandstop Filter	BSC	N/A (Cal during use)

For Radiated Electric Field Emissions 18GHz to 26GHz (Restricted band 15.205)

RFG No	Type	Description	Manufacturer	Date Calibrated
274	Lab 10	Large anechoic chamber	KTL	N/A
630	QSH20S20S	Horn antenna	Q-par	02/11/06
476	60637	50Ω Coax 3m	Semflex	14/04/08
477	60637	50Ω Coax 3m	Semflex	14/04/08
307	8449B	Microwave pre amp	HP	25/01/06
REF847	ESU	EMI Test Receiver (Spectrum analyser)	R&S	29/02/08
244	4478	Bandstop Filter	BSC	N/A (Cal during use)



**Details of Equipment Used Continued:**

For Conducted Emissions

RFG No	Type	Description	Manufacturer	Date Calibrated
REF847	ESU	EMI Test Receiver (Spectrum analyser)	R&S	29/02/08
244	4478	Bandstop Filter	BSC	N/A (Cal during use)
REF 835/836	N1922A & N1911A	Power head and meter	Agilent	08/02/08

For Conducted RF power

RFG No	Type	Description	Manufacturer	Date Calibrated
REF 835/836	N1922A & N1911A	Power head and meter	Agilent	08/02/08

For 6dB Bandwidth measurement

RFG No	Type	Description	Manufacturer	Date Calibrated
REF847	ESU	EMI Test Receiver (Spectrum analyser)	R&S	29/02/08

For Power Spectral density

RFG No	Type	Description	Manufacturer	Date Calibrated
REF847	ESU	EMI Test Receiver (Spectrum analyser)	R&S	29/02/08

**Appendix D:****Additional Information**

The block diagram (figure 1) shows the connection of drive equipment during conducted testing which simulated the internal battery (S15). The EUT was powered via the InSight port (programming & debug connector) using a ribbon cable from the support equipment (S02/S03). The support equipment was not isolated during the testing.

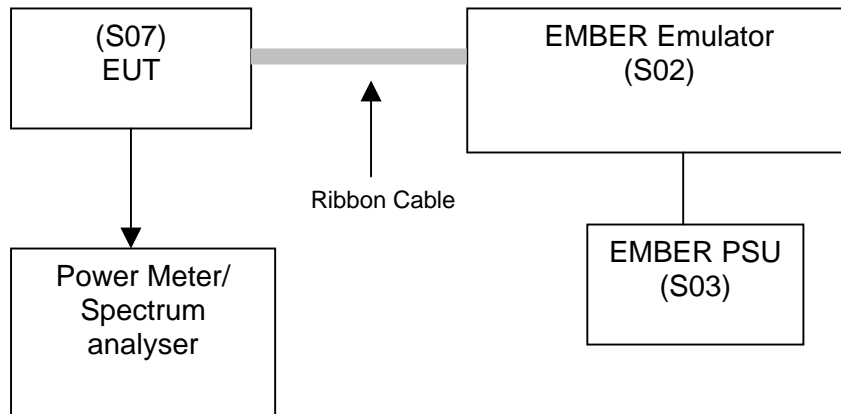

Figure 1

**The following information is a copy of email correspondence from the client, detailing the frequencies used within the EUT. The lowest and highest declared frequency generated in the device. In addition are details of the antenna gain and modulation scheme**

Hi Martin,  
to answer your questions:

1. The lowest and highest operating frequencies on each of the devices,  
While the hardware is capable of 2400-2500MHz (Ember EM2xx data sheet 120-0082-000P p16), the firmware only permits it to be set to a set of 5MHz channels with centre frequencies  $F_c = 2405 + 5(k - 11)$  in megahertz, for  $k = 11, 12, \dots, 26$  where  $k$  is the channel number according to IEEE Std 802.15.4-2003 (p30). Alertme devices are further limited to operation only on channels 11-25, corresponding to minimum and maximum centre frequencies of 2405MHz and 2475MHz.

2. Modulation used

- O-QPSK with half-sine pulse-shaping
- 8-symbol listen-before send for CSMA-CA
- Bit rate 250kb/s, symbol rate 62.5ksymbol/s with 4-bit 16-ary orthogonal symbols, chip rate 2000kchip/s
- ref. IEEE Std 802.15.4-2003 p47

3. Details of the antenna/specification of maximum gain

- Impexa (left hand version) 2.4 GHz SMD Antenna Part No. 3030A6150, implemented according to Antenova reference design.
- Peak gain 1.0dBi, average gain -1.9dBi, average efficiency 65%

4. The name of the 8 pin connector on the board, i.e. (serial port....)

The 10-pin programming and debug interface header is called the InSight Port

I'll bring you the documents tomorrow.

Amyas

---

Dr Amyas Phillips

Alertme.com

27-28 Bridge Street, Cambridge, CB2 1UJ, UK

cell: +44 (0)7941 420129

direct: +44 (0)1223 222157

office: +44 (0)1223 361555

fax: +44 (0)1223 361557

skype: aewp22

Extract from Antenna Manufacturers data sheet detailing antenna gain

Impexa 2.4 GHz SMD Antenna  
Part No. 3030A6150 / 3030A6250

#### 4 Part numbers

Impexa Left: 3030A6150-01

Impexa Right: 3030A6250-01

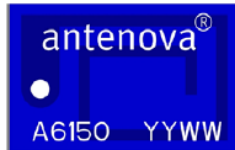

#### 5 General data

Product name	Impexa 2.4 GHz
Part Number	3030A6150-01 (Left)
	3030A6250-01 (Right)
Frequency	2.4 – 2.5 GHz
Polarization	Linear
Operating temperature	-40 °C to +85 °C
Impedance with matching	50 Ω
Weight	0.05 g
Antenna type	SMD
Dimensions	6.1 x 3.9 x 1.1 [mm]

#### 6 Electrical characteristics

	Typical performance	Conditions
Peak gain	1.0 dBi	All data measured on Antenova's reference boards, part numbers AN-1-0542-1 and AN-1-0563-1  Data given for the 2.4 – 2.5 GHz frequency range
Average gain	-1.9 dBi	
Average efficiency	65%	
Maximum Return Loss	-10 dB	
Maximum VSWR	1.9:1	

Integrated Antenna Solutions

**Appendix E: Calculation of the duty cycle correction factor**

Using a spectrum analyser in zero span mode, centred on the fundamental carrier frequency with a RBW of 1MHz and a video Bandwidth of 1MHz the sweep time was set accordingly to capture the pulse train. The transmit pulsewidths and period was measured. A plots of the pulse train is contained in Appendix B of this test report.

If the pulse train was less than 100 ms, including blanking intervals, the duty cycle was calculated by averaging the sum of the pulsewidths over one complete pulse train. However if the pulse train exceeds 100ms then the duty cycle was calculated by averaging the sum of the pulsewidths over the 100ms width with the highest average value. (The duty cycle is the value of the sum of the pulse widths in one period (or 100ms), divided by the length of the period (or 100ms). The duty cycle correction factor was then expressed in dB and the peak emissions adjusted accordingly to give an average value of the emission.

Correction factor dB =  $20 \times (\text{Log}_{10} \text{ Calculated Duty Cycle})$

Therefore the calculated duty cycle was determined:

The pulse train period was greater than >100ms and in as shown from the plots in contained in appendix B of this test report.

Duty cycle =  $\frac{\text{the sum of the highest average value pulsewidths over 100ms}}{100\text{ms}}$

e.g

$$= \frac{7.459\text{ms}}{100\text{ms}} = 0.07459$$

0.07459 or 7.459%

Correction factor (dB) =  $20 \times (\text{Log}_{10} 0.07459) = -22.54\text{dB}$

**Appendix F:**

**Photographs and Figures**

The following photographs were taken of the test samples:

1. Radiated electric field emissions arrangement: front view.
2. Radiated electric field emissions arrangement: rear view.
3. Photo of the RF module front view
4. Photo of the RF module rear view
5. PCB top face
6. PCB bottom face

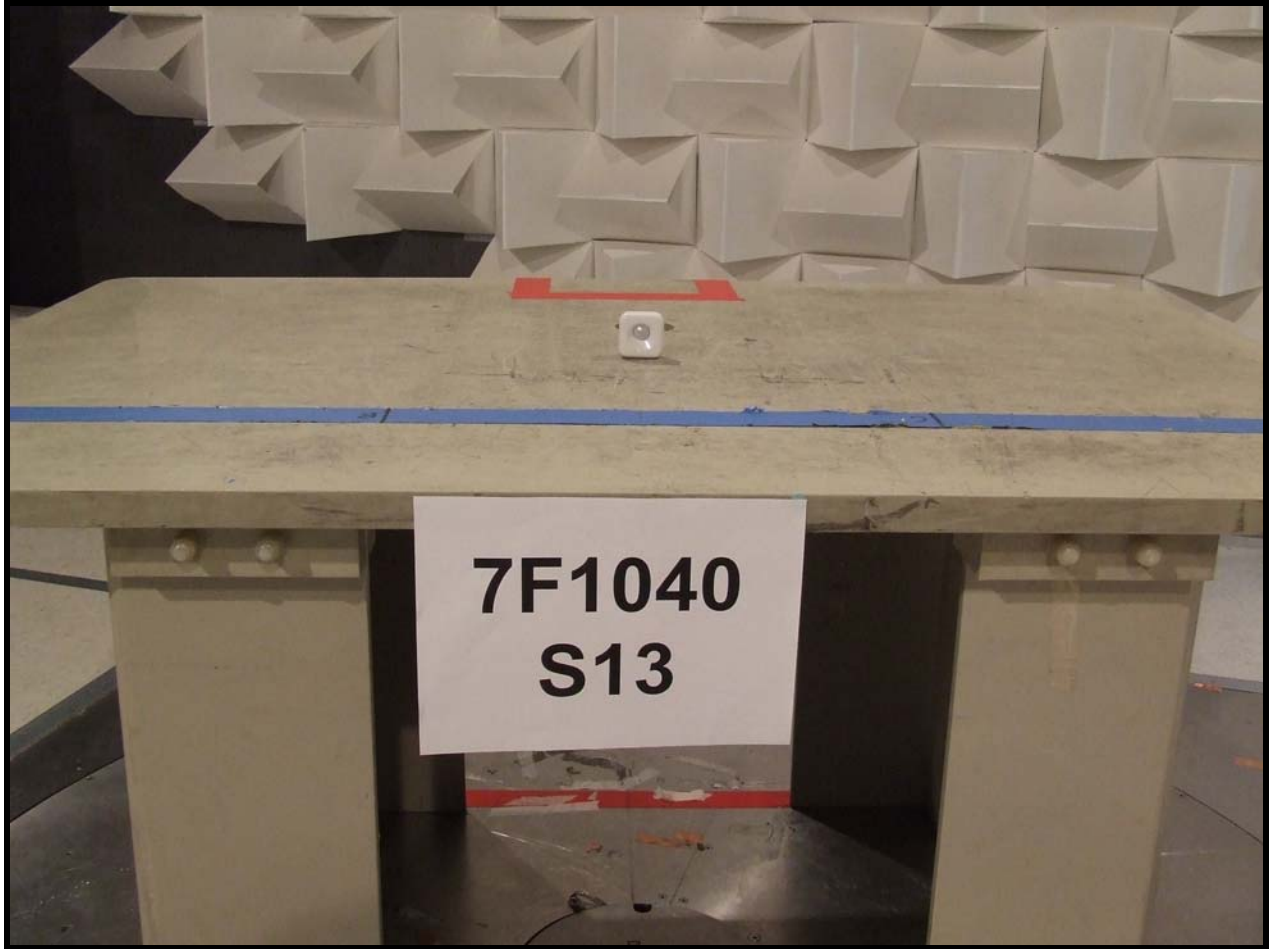

Photograph 1

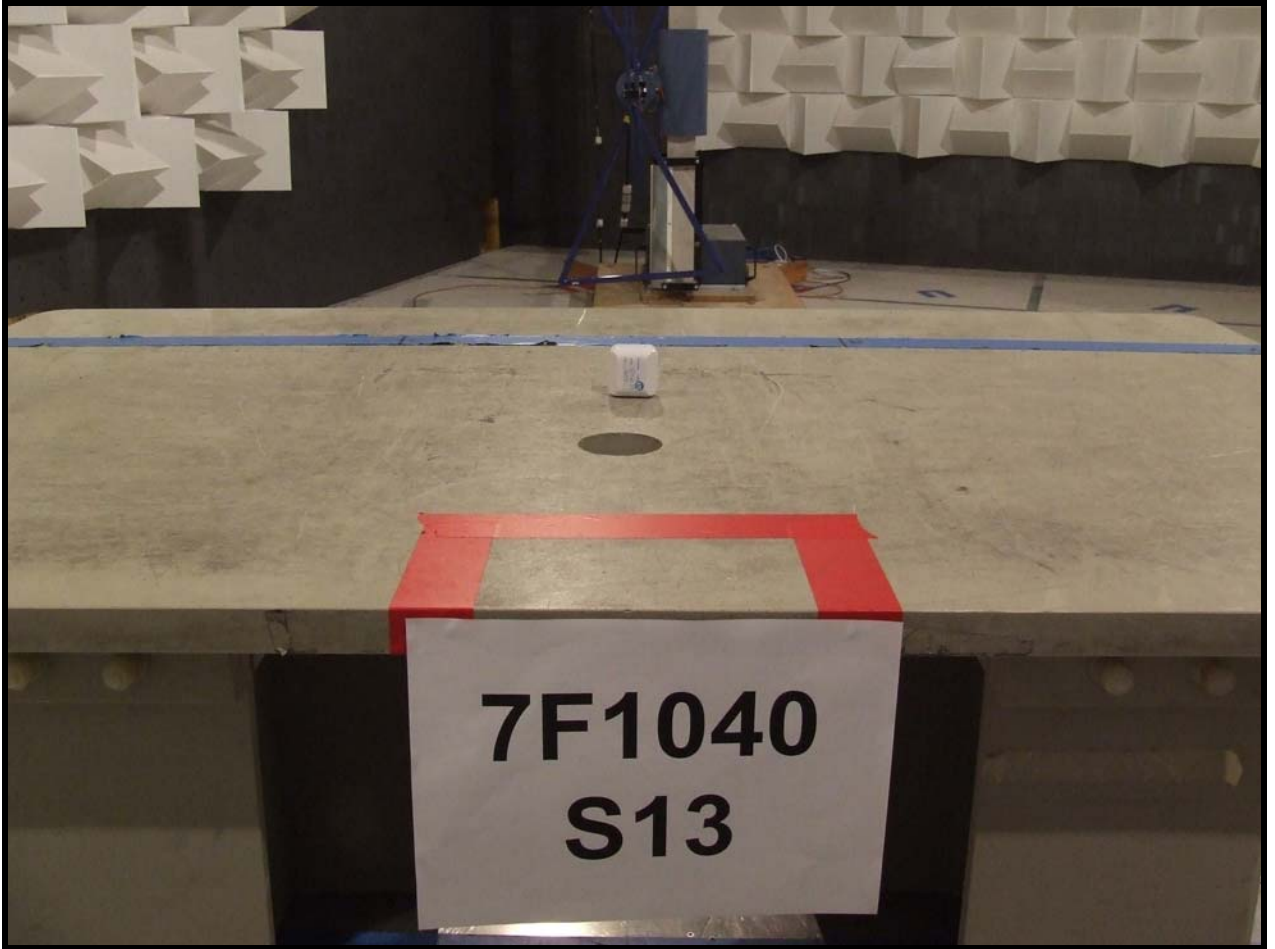

Photograph 2





Photograph 3



Photograph 4

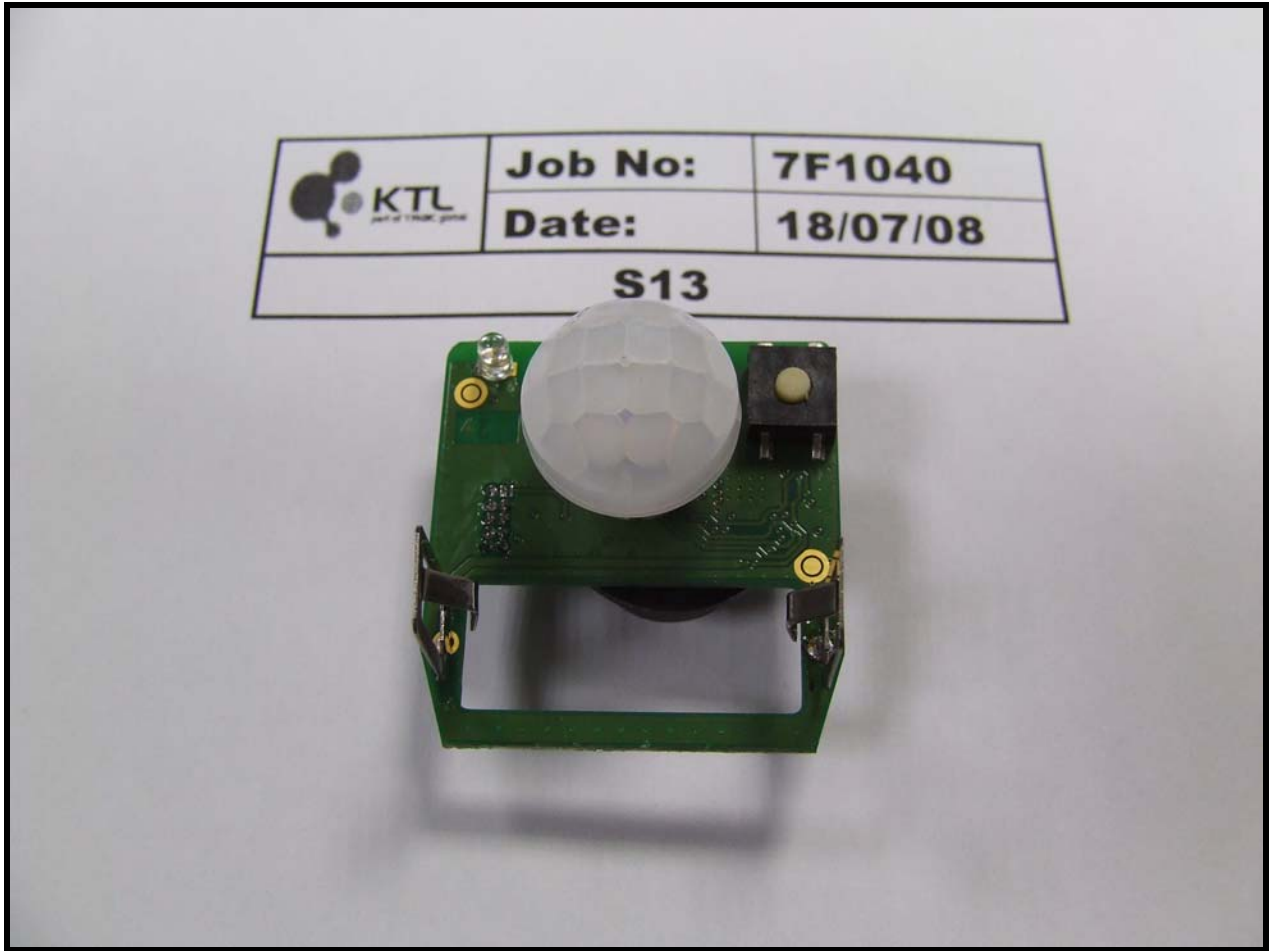

Photograph 5



Photograph 6

**Appendix G:****MPE Calculation**

OET Bulletin No. 65, Supplement C 01-01

**47 CFR §§1.1307 and 2.1091**

2.1091 Radio frequency radiation exposure evaluation: mobile devices.

A mobile device is defined as a transmitting device designed to be used in other than fixed locations and to generally be used in such a way that a separation distance of at least 20 centimeters is normally maintained between the transmitter's radiating structure(s) and the body of the user or nearby persons. In this context, the term "fixed location" means that the device is physically secured at one location and is not able to be easily moved to another location. Transmitting devices designed to be used by consumers or workers that can be easily re-located, such as wireless devices associated with a personal computer, are considered to be mobile devices if they meet the 20 centimetre separation requirement.

**Prediction of MPE limit at a given distance**

Equation from page 18 of OET Bulletin 65, Edition 97-01

$$S = \frac{PG}{4 \pi R^2}$$

where:

S = power density

P = power input to the antenna

G = power gain of the antenna in the direction of interest relative to an isotropic radiator

R = distance to the centre of radiation of the antenna

Maximum peak output power at the antenna terminal:	2.44	dBm
Maximum peak output power at the antenna terminal:	1.75500000	mW
Antenna gain (typical):	-1.9	dBi
Maximum antenna gain:	0.645654229	numeric
Prediction distance:	20	cm
Prediction frequency:	2475	MHz

**Result**

Prediction Frequency (MHz)	Maximum allowable antenna gain: (dBi)	Power density (S) at prediction frequency: (mW/cm <sup>2</sup> )	MPE limit for uncontrolled exposure at prediction frequency: (mW/cm <sup>2</sup> )	Result
2475	34.56992735	0.000225	1	Pass



**KTL**  
part of TRaC global

- Unit E, South Orbital Trading Park, Hedon Road, Hull, HU9 1NJ, UK.
- **T** +44 (0)1482 801801
- **F** +44 (0)1482 801806
- **E** [info@trac-ctl.com](mailto:info@trac-ctl.com)